

Agilent 33220A

20 MHz Function/Arbitrary Waveform Generator

User's Guide

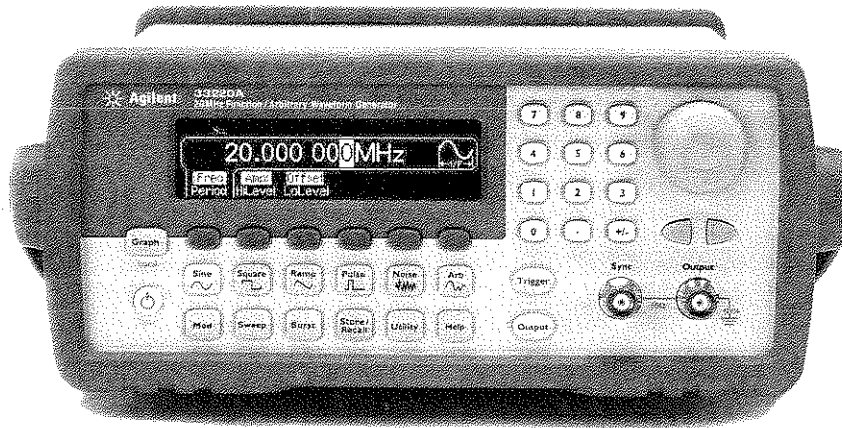

1

2

Front-Panel
Menu Operation

3

Features and
Functions

4

Remote Interface
Reference

5

Errors
Messages

6

Application
Programs

7

Tutorial

8

Specifications

1

Note: The power-on state will be the
power-down recall mode. See "Instrum

Output Configuration

- Function
- Frequency
- Amplitude / Offset
- Output Units
- Output Termination
- Autorange

Modulation

- Carrier (AM, FM, PM, FSK)
- Carrier (PWM)
- Mod. Waveform (AM)
- Mod. Waveform (FM, PM, PWM)
- AM Depth
- FM Deviation
- PM Deviation
- FSK Hop Frequency
- FSK Rate
- PWM Width Deviation
- Modulation State

Sweep

- Start / Stop Frequency
- Sweep Time
- Sweep Mode
- Sweep State

Burst

- Burst Count
- Burst Period
- Burst Start Phase
- Burst State

System-Related Operations

- Power-Down Recall
- Display Mode
- Error Queue
- Stored States, Stored Arbs
- Output State

Triggering Operations

- Trigger Source

Remote Interface Configuration

- GPIB Address
- DHCP
- IP Address
- Subnet Mask
- Default Gateway
- DNS Server
- Host Name
- Domain Name

Calibration

- Calibration State

Parameters marked with a bullet (•) are



Contents

Manuf

Manuf

Declar

Pr

Mo

Pr

Confo

The prc
EMC D

Confo

EMC

Safety

21 Fel

Date

Agilent 33220A at a Glance	2
The Front Panel at a Glance	3
The Front Panel Display at a Glance	4
Front-Panel Number Entry	5
The Rear Panel at a Glance	6
In This Book	7
Chapter 1 – Quick Start	13
Chapter 2 – Front-Panel Menu Operation	31
Chapter 3 – Features and Functions	53
Chapter 4 – Remote Interface Reference	147
Chapter 5 – Error Messages	273
Chapter 6 – Application Programs	301
Chapter 7 – Tutorial	311
Chapter 8 – Specifications	335
Index	341

User's Guide

Publication Number 33220-90001 (*order as 33220-90000 manual set*)
Edition 1, February 2003

Copyright © 2003 Agilent Technologies, Inc.

**Agilent 33220A
20 MHz Function/
Arbitrary Waveform Generator**

Agilent 33220A at a Glance

The Agilent Technologies 33220A is a 20 MHz synthesized function generator with built-in arbitrary waveform and pulse capabilities. Its combination of bench-top and system features makes this function generator a versatile solution for your testing requirements now and in the future.

Convenient bench-top features

- 10 standard waveforms
- Built-in 14-bit 50 MSa/s arbitrary waveform capability
- Precise pulse waveform capabilities with adjustable edge time
- LCD display provides numeric and graphical views
- Easy-to-use knob and numeric keypad
- Instrument state storage with user-defined names
- Portable, ruggedized case with non-skid feet

Flexible system features

- Four downloadable 64K-point arbitrary waveform memories
- GPIB (IEEE-488), USB, and LAN remote interfaces are standard
- SCPI (Standard Commands for Programmable Instruments) compatibility

Note: *Unless otherwise indicated, this manual applies to all Serial Numbers.*

The Front Panel at a Glance

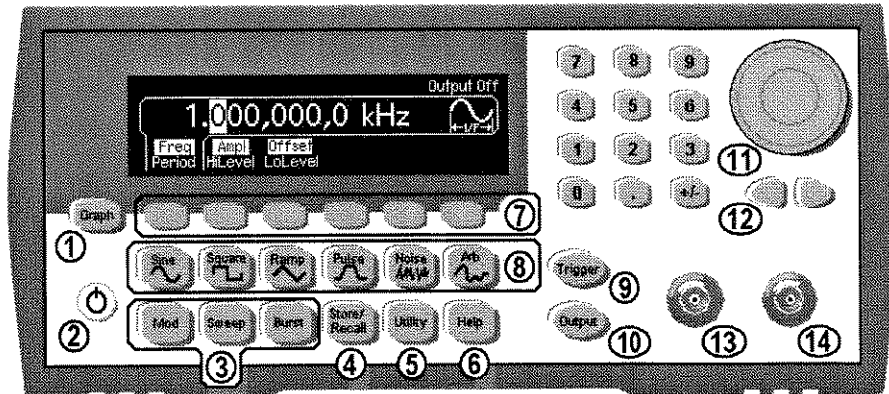

- | | |
|-------------------------------|---|
| 1 Graph Mode/Local Key | 9 Manual Trigger Key (<i>used for Sweep and Burst only</i>) |
| 2 On/Off Switch | 10 Output Enable/Disable Key |
| 3 Modulation/Sweep/Burst Keys | 11 Knob |
| 4 State Storage Menu Key | 12 Cursor Keys |
| 5 Utility Menu Key | 13 Sync Connector |
| 6 Help Menu Key | 14 Output Connector |
| 7 Menu Operation Softkeys | |
| 8 Waveform Selection Keys | |

Note: To get context-sensitive help on any front-panel key or menu softkey, press and hold down that key.

The Front-Panel Display at a Glance

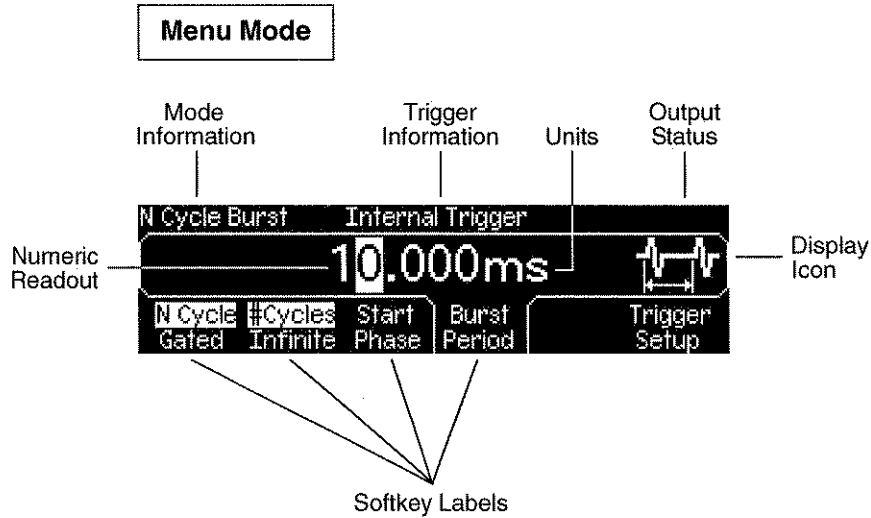

Graph Mode

To enter or exit the Graph Mode, press the **Graph** key.

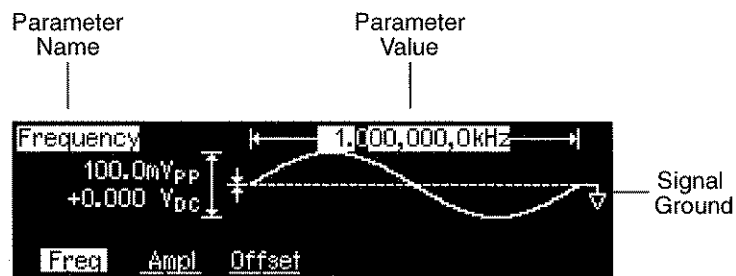

In Graph Mode, only one parameter label is displayed for each key at one time.

Front-Panel Number Entry

You can enter numbers from the front-panel using one of two methods.

Use the knob and cursor keys to modify the displayed number.

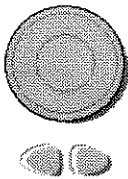

1. Use the keys below the knob to move the cursor left or right.
2. Rotate the knob to change a digit (clockwise to increase).

Use the keypad to enter numbers and the softkeys to select units.

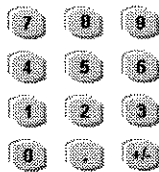

1. Key in a value as you would on a typical calculator.
2. Select a unit to enter the value.

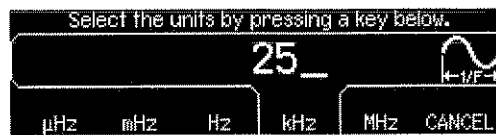

The Rear Panel at a Glance

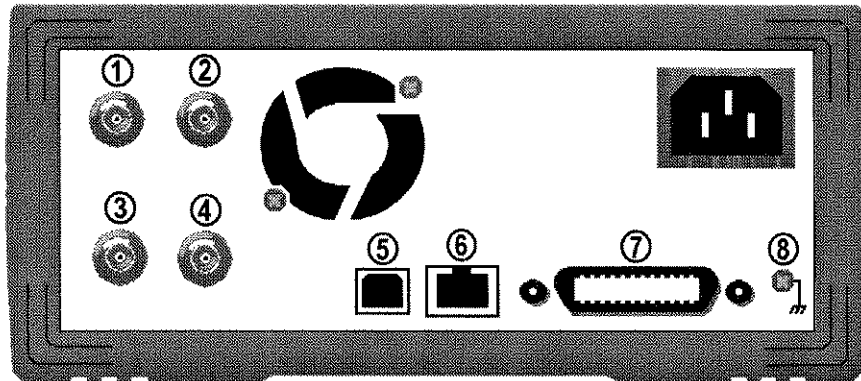

- | | |
|---|----------------------------|
| 1 External 10 MHz Reference Input Terminal (Option 001 only). | 5 USB Interface Connector |
| 2 Internal 10 MHz Reference Output Terminal (Option 001 only). | 6 LAN Interface Connector |
| 3 External Modulation Input Terminal | 7 GPIB Interface Connector |
| 4 Input: External Trig/FSK/Burst Gate
Output: Trigger Output | 8 Chassis Ground |

Use the **Utility** menu to:

- Select the GPIB address (see chapter 2).
- Set the network parameters for the LAN interface (see chapter 2).
- Display the current network parameters (see chapter 2).

Note: The *External and Internal 10 MHz Reference Terminals (1 and 2, above)* are present **only** if Option 001, *External Timebase Reference*, is installed. Otherwise, the holes for these connectors are plugged.

WARNING

For protection from electrical shock, the power cord ground must not be defeated. If only a two-contact electrical outlet is available, connect the instrument's chassis ground screw (see above) to a good earth ground.

In This Book

Quick Start Chapter 1 prepares the function generator for use and helps you get familiar with a few of its front-panel features.

Front-Panel Menu Operation Chapter 2 introduces you to the front-panel menu and describes some of the function generator's menu features.

Features and Functions Chapter 3 gives a detailed description of the function generator's capabilities and operation. You will find this chapter useful whether you are operating the function generator from the front panel or over the remote interface.

Remote Interface Reference Chapter 4 contains reference information to help you program the function generator over the remote interface.

Error Messages Chapter 5 lists the error messages that may appear as you are working with the function generator. Each listing contains information to help you diagnose and solve the problem.

Application Programs Chapter 6 contains several remote interface application programs to help you develop programs for your application.

Tutorial Chapter 7 discusses the fundamentals of signal generation and modulation techniques.

Specifications Chapter 8 lists the function generator's specifications.



If you have questions relating to the operation of the Agilent 33220A, call **1-800-452-4844** in the United States, or contact your nearest Agilent Technologies Sales Office.

If your 33220A fails within three years of purchase, Agilent will either repair or replace it free of charge. Call **1-877-447-7278** in the United States (and ask for "Agilent Express") or contact your local Agilent Technologies Sales Office.



Contents

Chapter 1 Quick Start 13

- To Prepare the Function Generator for Use 15
- To Adjust the Carrying Handle 16
- To Set the Output Frequency 17
- To Set the Output Amplitude 18
- To Set a DC Offset Voltage 20
- To Set the High-Level and Low-Level Values 21
- To Select "DC Volts" 22
- To Set the Duty Cycle of a Square Wave 23
- To Configure a Pulse Waveform 24
- To View a Waveform Graph 25
- To Output a Stored Arbitrary Waveform 26
- To Use the Built-In Help System 27
- To Rack Mount the Function Generator 29

Chapter 2 Front-Panel Menu Operation 31

- Front-Panel Menu Reference 33
- To Select the Output Termination 35
- To Reset the Function Generator 35
- To Output a Modulated Waveform 36
- To Output an FSK Waveform 38
- To Output a PWM Waveform 40
- To Output a Frequency Sweep 42
- To Output a Burst Waveform 44
- To Trigger a Sweep or Burst 46
- To Store the Instrument State 47
- To Configure the Remote Interface 48

Chapter 3 Features and Functions 53

- Output Configuration 55
- Pulse Waveforms 70
- Amplitude Modulation (AM) 74
- Frequency Modulation (FM) 79
- Phase Modulation (PM) 85
- Frequency-Shift Keying (FSK) Modulation 89
- Pulse Width Modulation (PWM) 93
- Frequency Sweep 99
- Burst Mode 106

Contents

Triggering 115
Arbitrary Waveforms 120
System-Related Operations 126
Remote Interface Configuration 135
Calibration Overview 141
Factory Default Settings 145

Chapter 4 Remote Interface Reference 147

SCPI Command Summary 149
Simplified Programming Overview 161
Using the APPLy Command 163
Output Configuration Commands 172
Pulse Configuration Commands 185
Amplitude Modulation (AM) Commands 190
Frequency Modulation (FM) Commands 193
Phase Modulation (PM) Commands 197
Frequency-Shift Keying (FSK) Commands 200
Pulse Width Modulation (PWM) Commands 203
Frequency Sweep Commands 208
Burst Mode Commands 216
Triggering Commands 224
Arbitrary Waveform Commands 227
State Storage Commands 238
System-Related Commands 242
Interface Configuration Commands 247
Phase-Lock Commands (Option 001 Only) 248
The SCPI Status System 250
Status Reporting Commands 260
Calibration Commands 264
An Introduction to the SCPI Language 266
Using Device Clear 271

Contents

Chapter 5 Error Messages 273

Command Errors 275
Execution Errors 278
Device Dependent Errors 293
Query Errors 294
Instrument Errors 295
Self-Test Errors 296
Calibration Errors 298
Arbitrary Waveform Errors 299

Chapter 6 Application Programs 301

Introduction 302
Program Listings 304

Chapter 7 Tutorial 311

Direct Digital Synthesis 313
Creating Arbitrary Waveforms 316
Square Waveform Generation 318
Pulse Waveform Generation 319
Signal Imperfections 320
Output Amplitude Control 322
Ground Loops 323
Attributes of AC Signals 325
Modulation 327
Frequency Sweep 332
Burst 333

Chapter 8 Specifications 335

- Waveforms 336
- Waveform Characteristics 336
- Common Characteristics 337
- Modulation 337
- Sweep 338
- Burst 338
- Trigger Characteristics 338
- Programming Times 338
- General 339
- Product Dimensions 340

Index 341

Quick Start

Quick Start

One of the first things you will want to do with your function generator is to become acquainted with the front panel. We have written the exercises in this chapter to prepare the instrument for use and help you get familiar with some of its front-panel operations. This chapter is divided into the following sections:

- To Prepare the Function Generator for Use, *on page 15*
- To Adjust the Carrying Handle, *on page 16*
- To Set the Output Frequency, *on page 17*
- To Set the Output Amplitude, *on page 18*
- To Set a DC Offset Voltage, *on page 20*
- To Set the High-Level and Low-Level Values, *on page 21*
- To Select “DC Volts”, *on page 22*
- To Set the Duty Cycle of a Square Wave, *on page 23*
- To Configure a Pulse Waveform, *on page 24*
- To View a Waveform Graph, *on page 25*
- To Output a Stored Arbitrary Waveform, *on page 26*
- To Use the Built-In Help System, *on page 27*
- To Rack Mount the Function Generator, *on page 29*

To Prepare the Function Generator for Use

1 Check the list of supplied items.

Verify that you have received the following items with your instrument. If anything is missing, please contact your nearest Agilent Sales Office.

- One power cord.
- This *User's Guide*.
- One *Service Guide*.
- One folded *Quick Start Tutorial*.
- One folded *Quick Reference Guide*.
- Certificate of Calibration.
- Connectivity software on CD-ROM.



2 Connect the power cord and turn on the function generator.

The instrument runs a short power-on self test, which takes a few seconds. When the instrument is ready for use it displays a message about how to obtain help, along with the current GPIB address. The function generator powers up in the *sine wave* function at 1 kHz with an amplitude of 100 mV peak-to-peak (into a 50Ω termination). At power-on, the *Output* connector is disabled. To enable the *Output* connector, press the  key.

If the function generator *does not* turn on, verify that the power cord is firmly connected to the power receptacle on the rear panel (the power-line voltage is automatically sensed at power-on). You should also make sure that the function generator is connected to a power source that is energized. Then, verify that the function generator is turned on.

If the power-on self test fails, "Self-Test Failed" is displayed along with an error code. See the *Agilent 33220A Service Guide* for information on error codes, and for instructions on returning the function generator to Agilent for service.

To Adjust the Carrying Handle

To adjust the position, grasp the handle by the sides and *pull outward*. Then, rotate the handle to the desired position.

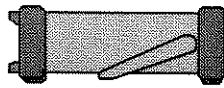

Retracted

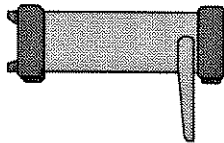

Extended

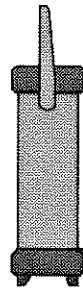

**Carrying
Position**



To Set the Output Frequency

At power-on, the function generator outputs a sine wave at 1 kHz with an amplitude of 100 mV peak-to-peak (into a 50Ω termination).
The following steps show you how to change the frequency to 1.2 MHz.

1 Press the “Freq” softkey.

The displayed frequency is either the power-on value or the frequency previously selected. When you change functions, the same frequency is used if the present value is valid for the new function. To set the waveform *period* instead, press the **Freq** softkey again to toggle to the **Period** softkey (the current selection is highlighted).



2 Enter the magnitude of the desired frequency.

Using the numeric keypad, enter the value “1.2”.



3 Select the desired units.

Press the softkey that corresponds to the desired units. When you select the units, the function generator outputs a waveform with the displayed frequency (if the output is enabled). For this example, press **MHz**.



Note: You can also enter the desired value using the knob and cursor keys.

To Set the Output Amplitude

At power-on, the function generator outputs a sine wave with an amplitude of 100 mV peak-to-peak (into a 50Ω termination).
The following steps show you how to change the amplitude to 50 mVrms.

1 Press the “Ampl” softkey.

The displayed amplitude is either the power-on value or the amplitude previously selected. When you change functions, the same amplitude is used if the present value is valid for the new function. To set the amplitude using a *high level* and *low level*, press the **Ampl** softkey again to toggle to the **HiLevel** and **LoLevel** softkeys (the current selection is highlighted).



2 Enter the magnitude of the desired amplitude.

Using the numeric keypad, enter the value “50”.



3 Select the desired units.

Press the softkey that corresponds to the desired units. When you select the units, the function generator outputs the waveform with the displayed amplitude (if the output is enabled). For this example, press **mV_{RMS}**.



Note: You can also enter the desired value using the knob and cursor keys.

You can easily convert the displayed amplitude from one unit to another. For example, the following steps show you how to convert the amplitude from V_{rms} to V_{pp} .

4 Enter the numeric entry mode.

Press the \pm/\square key to enter the numeric entry mode.



5 Select the new units.

Press the softkey that corresponds to the desired units. The displayed value is converted to the new units. For this example, press the **Vpp** softkey to convert 50 mVrms to its equivalent in volts peak-to-peak.



To change the displayed amplitude by *decades*, press the right-cursor key to move the cursor to the units on the right side of the display. Then, rotate the knob to increase or decrease the displayed amplitude by decades.



To Set a DC Offset Voltage

At power-on, the function generator outputs a sine wave with a dc offset of 0 volts (into a 50Ω termination). *The following steps show you how to change the offset to -1.5 mVdc.*

1 Press the “Offset” softkey.

The displayed offset voltage is either the power-on value or the offset previously selected. When you change functions, the same offset is used if the present value is valid for the new function.



2 Enter the magnitude of the desired offset.

Using the numeric keypad, enter the value “-1.5”.



3 Select the desired units.

Press the softkey that corresponds to the desired units. When you select the units, the function generator outputs the waveform with the displayed offset (if the output is enabled). For this example, press **mV_{DC}**.



Note: You can also enter the desired value using the knob and cursor keys.

To Set the High-Level and Low-Level Values

You can specify a signal by setting its amplitude and dc offset values, as described previously. Another way to set the limits of a signal is to specify its high-level (maximum) and low-level (minimum) values. This is typically convenient for digital applications. In the following example, let's set the high-level to 1.0 V and the low-level to 0.0 V.

1 Press the "Ampl" softkey to select "Ampl".

2 Press the softkey again to toggle to "HiLevel".

Note that both the **Ampl** and **Offset** softkeys toggle together, to **HiLevel** and **LoLevel**, respectively.



3 Set the "HiLevel" value.

Using the numeric keypad or the knob, select a value of "1.0 V". (If you are using the keypad, you will need to select the unit, "V", to enter the value.)



4 Press the "LoLevel" softkey and set the value.

Again, use the numeric keypad or the knob to enter a value of "0.0 V".



Note that these settings (high-level = "1.0 V" and low-level = "0.0 V") are equivalent to setting an amplitude of "1.0 Vpp" and an offset of "500 mVdc".

To Select "DC Volts"

You can select the "DC Volts" feature from the "Utility" menu, and then set a constant dc voltage as an "Offset" value. Let's set "DC Volts" = 1.0 Vdc.

- 1 Press **Utility** and then select the DC On softkey.

The **Offset** value becomes selected.



- 2 Enter the desired voltage level as an "Offset".

Enter 1.0 Vdc with the numeric keypad or knob.



You can enter any dc voltage from -5 Vdc to +5 Vdc.

To Set the Duty Cycle of a Square Wave

At power-on, the duty cycle for square waves is 50%. You can adjust the duty cycle from 20% to 80% for output frequencies up to 10 MHz. *The following steps show you how to change the duty cycle to 30%.*

1 Select the square wave function.

Press the  key and then set the desired output frequency to any value up to 10 MHz.

2 Press the “Duty Cycle” softkey.

The displayed duty cycle is either the power-on value or the percentage previously selected. The duty cycle represents the amount of time per cycle that the square wave is at a *high* level (note the icon on the right side of the display).



3 Enter the desired duty cycle.

Using the numeric keypad or the knob, select a duty cycle value of “30”. The function generator adjusts the duty cycle immediately and outputs a square wave with the specified value (if the output is enabled).



To Configure a Pulse Waveform

You can configure the function generator to output a pulse waveform with variable pulse width and edge time. *The following steps show you how to configure a 500 ms pulse waveform with a pulse width of 10 ms and edge times of 50 ns.*

1 Select the pulse function.

Press the **Pulse** key to select the pulse function and output a pulse waveform with the default parameters.

2 Set the pulse period.

Press the **Period** softkey and then set the pulse period to 500 ms.



3 Set the pulse width.

Press the **Width** softkey and then set the pulse width to 10 ms. The pulse width represents the time from the 50% threshold of the rising edge to the 50% threshold of the next falling edge (note the display icon).



4 Set the edge time for both edges.

Press the **Edge Time** softkey and then set the edge time for *both* the rising and falling edges to 50 ns. The edge time represents the time from the 10% threshold to the 90% threshold of each edge (note the display icon).



To View a Waveform Graph

In the *Graph Mode*, you can view a graphical representation of the current waveform parameters. The softkeys are listed in the same order as in the normal display mode, and they perform the same functions. However, only one label (for example, **Freq** or **Period**) is displayed for each softkey at one time.

1 Enable the Graph Mode.

Press the **Graph** key to enable the Graph Mode. The name of the currently selected parameter, shown in the upper-left corner of the display, and the parameter's numeric value field are both highlighted.



2 Select the desired parameter.

To select a specific parameter, note the softkey labels at the bottom of the display. For example, to select period, press the **Period** softkey.

- As in the normal display mode, you can edit numbers using either the numeric keypad or the knob and cursor keys.
- Parameters which normally toggle when you press a key a second time also toggle in the Graph Mode. However, you can see only one label for each softkey at one time (for example, **Freq** or **Period**).
- To exit the Graph Mode, press **Graph** again.

The **Graph** key also serves as a **Local** key to restore front-panel control after remote interface operations.

To Output a Stored Arbitrary Waveform

There are five built-in arbitrary waveforms stored in non-volatile memory. The following steps show you how to output the built-in “exponential fall” waveform from the front panel.

For information on creating a custom arbitrary waveform, refer to “To Create and Store an Arbitrary Waveform” on page 120.

1 Select the arbitrary waveform function.

When you press the **Arb** key to select the arbitrary waveform function, a temporary message is displayed indicating which waveform is currently selected (the default is “exponential rise”).

2 Select the active waveform.

Press the **Select Wform** softkey and then press the **Built-In** softkey to select from the five built-in waveforms. Then press the **Exp Fall** softkey. The waveform is output using the present settings for frequency, amplitude, and offset unless you change them.

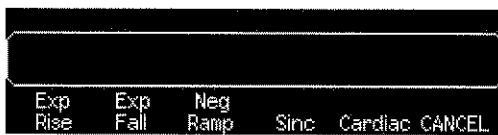

The selected waveform is now assigned to the **Arb** key. Whenever you press this key, the selected arbitrary waveform is output. To quickly determine which arbitrary waveform is currently selected, press **Arb**.

To Use the Built-In Help System

The built-in help system is designed to provide context-sensitive assistance on any front-panel key or menu softkey. A list of help topics is also available to assist you with several front-panel operations.

1 View the help information for a function key.

Press and hold down the **Sine** key. If the message contains more information than will fit on the display, press the \downarrow softkey or turn the knob clockwise to view the remaining information.

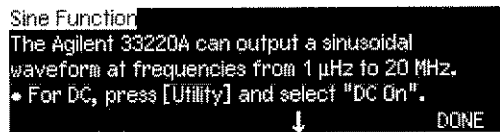

Sine Function
The Agilent 33220A can output a sinusoidal waveform at frequencies from 1 μ Hz to 20 MHz.
• For DC, press [Utility] and select "DC On".
 \downarrow DONE

Press **DONE** to exit Help.

2 View the help information for a menu softkey.

Press and hold down the **Freq** softkey. If the message contains more information than will fit on the display, press the \downarrow softkey or rotate the knob clockwise to view the remaining information.

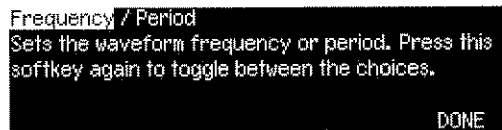

Frequency / Period
Sets the waveform frequency or period. Press this softkey again to toggle between the choices.
DONE

Press **DONE** to exit Help.

Chapter 1 Quick Start
To Use the Built-In Help System

3 View the list of help topics.

Press the **Help** key to view the list of available help topics. To scroll through the list, press the \uparrow or \downarrow softkey or rotate the knob. Select the third topic “*Get HELP on any key*” and then press **SELECT**.

Get HELP on any key
To get context-sensitive help on any front-panel key or menu softkey, press and hold down that key.
DONE

Press **DONE** to exit Help.

4 View the help information for displayed messages.

Whenever a limit is exceeded or any other invalid configuration is found, the function generator will display a message. For example, if you enter a value that exceeds the frequency limit for the selected function, a message will be displayed. The built-in help system provides additional information on the most recent message to be displayed.

Press the **Help** key, select the first topic “*View the last message displayed*”, and then press **SELECT**.

Frequency upper limit = 20.000,000MHz.
The specified value exceeds the upper limit for this parameter. The instrument has set the parameter equal to the upper limit.
DONE

Press **DONE** to exit Help.

Local Language Help: The built-in help system is available in multiple languages. All messages, context-sensitive help, and help topics appear in the selected language. The menu softkey labels and status line messages are not translated.

To select the local language, press the **Utility** key, press the **System** softkey, and then press the **Help In** softkey. Select the desired language.

To Rack Mount the Function Generator

You can mount the Agilent 33220A in a standard 19-inch rack cabinet using one of two optional kits available. Instructions and mounting hardware are included with each rack-mounting kit. Any Agilent *System II* instrument of the same size can be rack-mounted beside the Agilent 33220A.

Note: Remove the carrying handle, and the front and rear rubber bumpers, before rack-mounting the instrument.

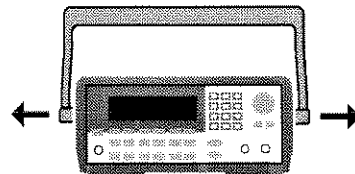
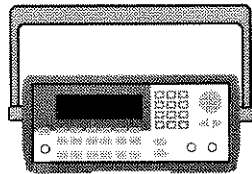

To remove the handle, rotate it to vertical and pull the ends outward.

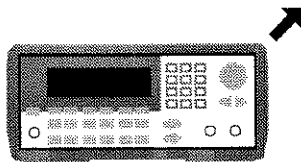

Front

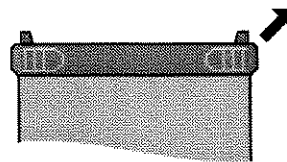

Rear (bottom view)

To remove the rubber bumper, stretch a corner and then slide it off.

Chapter 1 Quick Start

To Rack Mount the Function Generator

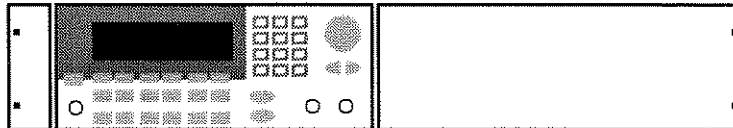

To rack mount a single instrument, order adapter kit 5063-9240.

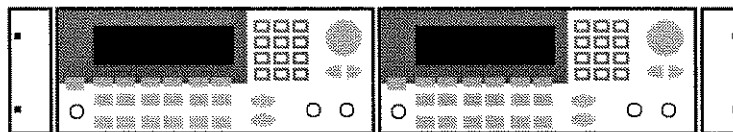

To rack mount two instruments side-by-side, order lock-link kit 5061-9694 and flange kit 5063-9212. Be sure to use the support rails in the rack cabinet.

Note: The lock-link kit works *only* for instruments of equal depth. If you want to mount an Agilent 33220A and an instrument of a different depth (for example, an Agilent 33250A) contact your Agilent Representative for further information.

In order to prevent overheating, do not block the flow of air into or out of the instrument. Be sure to allow enough clearance at the rear, sides, and bottom of the instrument to permit adequate internal air flow.

Front-Panel Menu Operation

Front-Panel Menu Operation

This chapter introduces you to the front-panel keys and menu operation. This chapter does not give a detailed description of every front-panel key or menu operation. It does, however, give you an overview of the front-panel menus and many front-panel operations. See chapter 3 “Features and Functions,” starting on page 53, for a complete discussion of the function generator’s capabilities and operation.

- Front-Panel Menu Reference, *on page 33*
- To Select the Output Termination, *on page 35*
- To Reset the Function Generator, *on page 35*
- To Output a Modulated Waveform, *on page 36*
- To Output an FSK Waveform, *on page 38*
- To Output a PWM Waveform, *on page 40*
- To Output a Frequency Sweep, *on page 42*
- To Output a Burst Waveform, *on page 44*
- To Trigger a Sweep or Burst, *on page 46*
- To Store the Instrument State, *on page 47*
- To Configure the Remote Interface, *on page 48*

Front-Panel Menu Reference

This section gives an overview of the front-panel menus. The remainder of this chapter contains examples of using the front-panel menus.

2

Mod Configure the modulation parameters for AM, FM, PM, FSK and PWM.

- Select the modulation type.
- Select an internal or external modulation source.
- Specify AM modulation depth, modulating frequency, and modulation shape.
- Specify FM frequency deviation, modulating frequency, and modulation shape.
- Specify PM phase deviation, modulating frequency, and modulation shape.
- Specify FSK "hop" frequency and FSK rate.
- Specify PWM deviation, modulating frequency, and modulation shape.

Sweep Configure the parameters for frequency sweep.

- Select linear or logarithmic sweeping.
- Select the start/stop frequencies or center/span frequencies.
- Select the time in seconds required to complete a sweep.
- Specify a marker frequency.
- Specify an internal or external trigger source for the sweep.
- Specify the slope (rising or falling edge) for an external trigger source.
- Specify the slope (rising or falling edge) of the "Trig Out" signal.

Burst Configure the parameters for burst.

- Select the triggered (N Cycle) or externally-gated burst mode.
- Select the number of cycles per burst (1 to 50,000, or Infinite).
- Select the starting phase angle of the burst (-360° to $+360^\circ$).
- Specify the time from the start of one burst to the start of the next burst.
- Specify an internal or external trigger source for the burst.
- Specify the slope (rising or falling edge) for an external trigger source.
- Specify the slope (rising or falling edge) of the "Trig Out" signal.

Chapter 2 Front-Panel Menu Operation
Front-Panel Menu Reference



Store and recall instrument states.

- Store up to four instrument states in non-volatile memory.
- Assign a custom name to each storage location.
- Recall stored instrument states.
- Restore all instrument settings to their factory default values.
- Select the instrument's power-on configuration (last or factory default).



Configure system-related parameters.

- Generate a dc-only voltage level.
- Enable/disable the Sync signal which is output from the "Sync" connector.
- Select the output termination (1 Ω to 10 k Ω , or Infinite).
- Enable/disable amplitude autoranging.
- Select the waveform polarity (normal or inverted).
- Select the GPIB address.
- Specify the LAN configuration (IP address and network configuration).
- Select how periods and commas are used in numbers displayed on the front panel.
- Select the local language for front-panel messages and help text.
- Enable/disable the tone heard when an error is generated.
- Enable/disable the display bulb-saver mode.
- Adjust the contrast setting of the front-panel display.
- Perform an instrument self-test.
- Secure/unsecure the instrument for calibration and perform manual calibrations.
- Query the instrument's firmware revision codes.



View the list of Help topics.

- View the last message displayed.
- View the remote command error queue.
- Get HELP on any key.
- How to generate a dc-only voltage level.
- How to generate a modulated waveform.
- How to create an arbitrary waveform.
- How to reset the instrument to its default state.
- How to view a waveform in the Graph Mode.
- How to synchronize multiple instruments.
- How to obtain Agilent Technical Support.

To Select the Output Termination

The Agilent 33220A has a fixed series output impedance of 50 ohms to the front-panel *Output* connector. If the actual load impedance is different than the value specified, the displayed amplitude and offset levels will be incorrect. The load impedance setting is simply provided as a convenience to ensure that the displayed voltage matches the expected load.

1 Press **Utility**.

2 Navigate the menu to set the output termination.

Press the **Output Setup** softkey and then select the **Load** softkey.



3 Select the desired output termination.

Use the knob or numeric keypad to select the desired load impedance or press the **Load** softkey again to choose “High Z”.

To Reset the Function Generator

To reset the instrument to its factory default state, press **Store/Recall** and then select the **Set to Defaults** softkey. Press **YES** to confirm the operation.

For a complete listing of the instrument's power-on and reset conditions, see “Agilent 33220A Factory Default Settings” on page 146.

To Output a Modulated Waveform

A modulated waveform consists of a *carrier* and a *modulating waveform*. In AM (amplitude modulation), the amplitude of the carrier is varied by the amplitude of the modulating waveform. For this example, you will output an AM waveform with 80% modulation depth. The carrier will be a 5 kHz sine wave and the modulating waveform will be a 200 Hz sine wave.

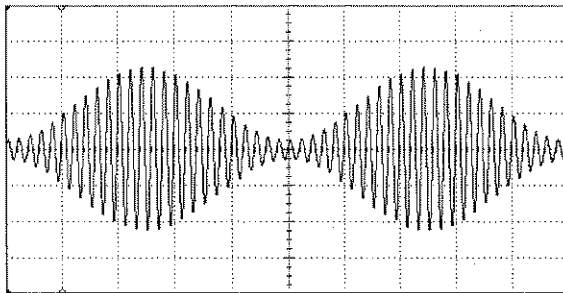

1 Select the function, frequency, and amplitude of the carrier.

Press **Sine** and then press the **Freq**, **Ampl**, and **Offset** softkeys to configure the carrier waveform. For this example, select a 5 kHz sine wave with an amplitude of 5 Vpp.

2 Select AM.

Press **Mod** and then select “AM” using the **Type** softkey. Notice that a status message “AM by Sine” is shown in the upper-left corner of the display.

3 Set the modulation depth.

Press the **AM Depth** softkey and then set the value to 80% using the numeric keypad or the knob and cursor keys.



4 Set the modulating frequency.

Press the **AM Freq** softkey and then set the value to 200 Hz using the numeric keypad or the knob and cursor keys.



2

5 Select the modulating waveform shape.

Press the **Shape** softkey to select the shape of the modulating waveform. For this example, select a sine wave.

At this point, the function generator outputs an AM waveform with the specified modulation parameters (if the output is enabled).

6 View the waveform.

Press **Graph** to view the waveform parameters.

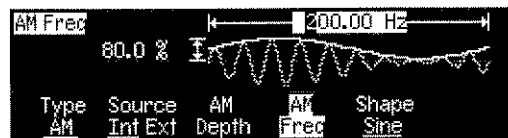

To turn off the Graph Mode, press **Graph** again.

To Output an FSK Waveform

You can configure the function generator to “shift” its output frequency between two preset values using FSK modulation. The rate at which the output shifts between the two frequencies (called the “carrier frequency” and the “hop frequency”) is determined by the internal rate generator or the signal level on the rear-panel *Trig In* connector. *For this example, you will set the “carrier” frequency to 3 kHz and the “hop” frequency to 500 Hz, with an FSK rate of 100 Hz.*

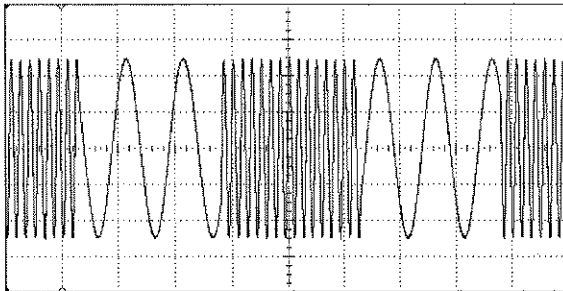

1 Select the function, frequency, and amplitude of the carrier.

Press **Sine** and then press the **Freq**, **Ampl**, and **Offset** softkeys to configure the carrier waveform. *For this example, select a 3 kHz sine wave with an amplitude of 5 Vpp.*

2 Select FSK.

Press **Mod** and then select “FSK” using the **Type** softkey. Notice that a status message “FSK” is shown in the upper-left corner of the display.

3 Set the “hop” frequency.

Press the **Hop Freq** softkey and then set the value to 500 Hz using the numeric keypad or the knob and cursor keys.



2

4 Set the FSK “shift” rate.

Press the **FSK Rate** softkey and then set the value to 100 Hz using the numeric keypad or the knob and cursor keys.



At this point, the function generator outputs an FSK waveform (if the output is enabled).

5 View the waveform.

Press **Graph** to view the waveform parameters.



*To turn off the Graph Mode, press **Graph** again.*

To Output a PWM Waveform

You can configure the function generator to output a pulse width modulated (PWM) waveform. The Agilent 33220A provides PWM for pulse carrier waveforms, and PWM is the only type of modulation supported for pulse waveforms. In PWM, the pulse width or duty cycle of the carrier waveform is varied according to the modulating waveform. You can specify either a pulse width and width deviation, or a pulse duty cycle and duty cycle deviation, the deviation to be controlled by the modulating waveform.

For this example, you will specify a pulse width and pulse width deviation for a 1 kHz pulse waveform with a 100 Hz sine wave modulating waveform.

1 Select the carrier waveform parameters.

Press **Pulse** and then press the **Freq**, **Ampl**, **Offset**, **Width**, and **Edge Time** softkeys to configure the carrier waveform. For this example, select a 1 kHz pulse waveform with an amplitude of 1 V_{pp}, a zero offset, a pulse width of 100 μ s, and an edge time of 50 ns.

2 Select PWM.

Press **Mod** (PWM is the only modulation type for **Pulse**). Notice that a status message "PWM by Sine" is shown in the upper-left corner of the display.

3 Set the width deviation.

Press the **Width Dev** softkey and set the value to 20 μ s using the numeric keypad or the knob and cursor keys.



4 Set the modulating frequency.

Press the **PWM Freq** softkey and then set the value to 5 Hz using the numeric keypad or the knob and cursor keys.



5 Select the modulating waveform shape.

Press the **Shape** softkey to select the shape of the modulating waveform. For this example, select a sine wave.

At this point, the function generator outputs a PWM waveform with the specified modulation parameters (if the output is enabled).

6 View the waveform.

Press **Graph** to view the waveform and parameters.

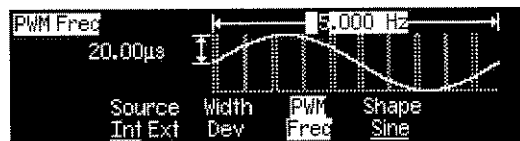

To turn off the Graph Mode, press **Graph** again.

Of course, to really view the PWM waveform, you would need to output it to an oscilloscope. If you do this, you will see how the pulse width varies, in this case, from 80 to 120 µs. At a modulation frequency of 5 Hz, the deviation is quite visible.

To Output a Frequency Sweep

In the frequency sweep mode, the function generator “steps” from the *start frequency* to the *stop frequency* at a *sweep rate* which you specify. You can sweep up or down in frequency, and with either linear or logarithmic spacing. *For this example, you will output a swept sine wave from 50 Hz to 5 kHz. You will not change the other parameters from their default settings: internal sweep trigger, linear spacing, and 1 second sweep time.*

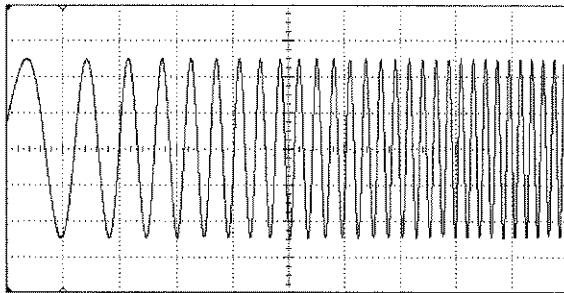

1 Select the function and amplitude for the sweep.

For sweeps, you can select sine, square, ramp, or arbitrary waveforms (pulse, noise, and dc are not allowed). *For this example, select a sine wave with an amplitude of 5 Vpp.*

2 Select the sweep mode.

Press **Sweep** and then verify that the linear sweep mode is currently selected. Notice that a status message “Linear Sweep” is shown in the upper-left corner of the display.

3 Set the start frequency.

Press the **Start** softkey and then set the value to 50 Hz using the numeric keypad or the knob and cursor keys.



4 Set the stop frequency.

Press the **Stop** softkey and then set the value to 5 kHz using the numeric keypad or the knob and cursor keys.



At this point, the function generator outputs a continuous sweep from 50 Hz to 5 kHz (if the output is enabled).

Note: If desired, you can set the frequency boundaries of the sweep using a *center frequency* and *frequency span*. These parameters are similar to the start frequency and stop frequency and are included to give you added flexibility. To achieve the same results, set the center frequency to 2.525 kHz and the frequency span to 4.950 kHz.

5 View the waveform.

Press **Graph** to view the waveform parameters.

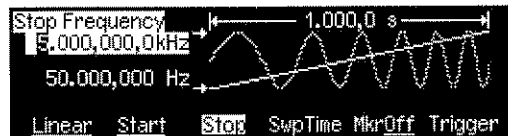

To turn off the Graph Mode, press **Graph** again.

You can generate a single frequency sweep by pressing the **Trigger** key. For more information, see "To Trigger a Sweep or Burst" on page 46.

To Output a Burst Waveform

You can configure the function generator to output a waveform with a specified number of cycles, called a *burst*. You can output the burst at a rate determined by the internal rate generator or the signal level on the rear-panel *Trig In* connector. *For this example, you will output a three-cycle sine wave with a 20 ms burst period. You will not change the other parameters from their default settings: internal burst source and 0 degree starting phase.*

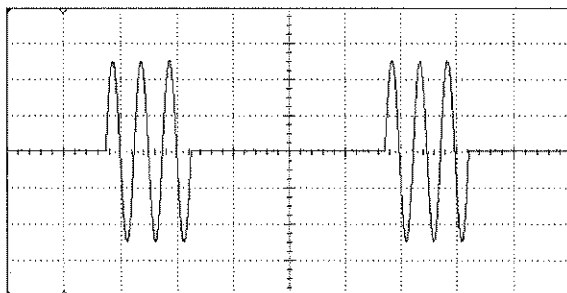

1 Select the function and amplitude for the burst.

For burst waveforms, you can select sine, square, ramp, pulse, or arbitrary waveforms (noise is allowed only in the “gated” burst mode and dc is not allowed). *For this example, select a sine wave with an amplitude of 5 Vpp.*

2 Select the burst mode.

Press and then verify that the “N Cycle” (internally-triggered) mode is currently selected. Notice that a status message “N Cycle Burst” is shown in the upper-left corner of the display.

3 Set the burst count.

Press the **#Cycles** softkey and then set the count to “3” using the numeric keypad or knob.



2

4 Set the burst period.

Press the **Burst Period** softkey and then set the period to 20 ms using the numeric keypad or the knob and cursor keys. The burst period sets the time from the start of one burst to the start of the next burst (note the display icon).



At this point, the function generator outputs a continuous three-cycle burst (if the output is enabled).

5 View the waveform.

Press **Graph** to view the waveform parameters.

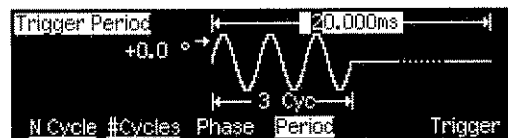



*To turn off the Graph Mode, press **Graph** again.*

You can generate a single burst (with the specified count) by pressing the **Trigger** key. For more information, see “To Trigger a Sweep or Burst” on page 46.

You can also use an external gate signal to either turn the burst signal “on” or “off” based on the external signal applied to the rear-panel **Trig In** connector. For more information, see “Burst Mode” on page 106.

To Trigger a Sweep or Burst

You can issue triggers from the front panel for sweeps and bursts using a *manual* trigger or an *internal* trigger.

- *Internal* or “automatic” triggering is enabled with the default settings of the function generator. In this mode, the function generator outputs continuously when the sweep or burst mode is selected.
- *Manual* triggering initiates one sweep or outputs one burst each time you press the  key from the front-panel. Continue pressing this key to re-trigger the function generator.
- The  key is disabled when in remote (the remote icon turns on while in remote) and when a function other than sweep or burst is currently selected (or when the output is disabled). The  key flashes off momentarily when using a manual trigger.



To Store the Instrument State

You can store the instrument state in one of four non-volatile storage locations. A fifth storage location automatically holds the power-down configuration of the instrument. When power is restored, the instrument can automatically return to its state before power-down.

1 Select the desired storage location.

Press  and then select the **Store State** softkey.



2 Select a custom name for the selected location.

If desired, you can assign a custom name to each of the four locations.



- The name can contain up to 12 characters. The first character must be a letter but the remaining characters can be letters, numbers, or the underscore character (“_”).
- To add additional characters, press the right-cursor key until the cursor is to the right of the existing name and then turn the knob.
- To delete all characters to the right of the cursor position, press .
- To use numbers in the name, you can enter them directly from the numeric keypad. Use the decimal point from the numeric keypad to add the underscore character (“_”) to the name.

3 Store the instrument state.

Press the **STORE STATE** softkey. The instrument stores the selected function, frequency, amplitude, dc offset, duty cycle, symmetry, as well as any modulation parameters in use. The instrument *does not* store volatile waveforms created in the arbitrary waveform function.

To Configure the Remote Interface

The Agilent 33220A supports remote interface communication using a choice of three interfaces: GPIB, USB, and LAN. All three interfaces are "live" at power up. The instructions that follow tell how to configure your remote interface from the instrument front panel.

Note: *The CD-ROM provided with your instrument contains connectivity software to enable communications over these interfaces. Refer to the instructions provided on the CD-ROM to install this software on your PC.*

GPIB Configuration

You need only select a GPIB address.

1 Select the "I/O" menu.

Press **Utility** and then press the **I/O** softkey.



2 Select the GPIB address.

Use the knob and cursor keys or the numeric keypad to select a GPIB address in the range 0 through 30 (the factory default is "10").

The GPIB address is shown on the front-panel display at power-on.

3 Exit the menu.

Press the **DONE** softkey.

USB Configuration

The USB interface requires no front panel configuration parameters. Just connect your Agilent 33220A to your PC using a standard USB cable and the interface will self configure. Press the **Show USB Id** softkey in the “I/O menu” to see the USB interface identification string.

LAN Configuration

There are several parameters that you may need to set to establish network communication using the LAN interface. Primarily, you will need to establish an IP address. You may need to contact your network administrator for help in establishing communication with the LAN interface.

1 Select the “I/O” menu.

Press **Utility** and then press the **I/O** softkey.



2 Select the “LAN” menu.

Press the **LAN** softkey.



From this menu, you can select **IP Setup** to set an IP address and related parameters, **DNS Setup** to configure DNS, or **Current Config** to view the current LAN configuration.

3 Establish an "IP Setup."

To use the Agilent 33220A on the network, you must first establish an IP setup, including an IP address, and possibly a subnet mask and gateway address. Press the **IP Setup** softkey. By default, **DHCP** is set to **On**.

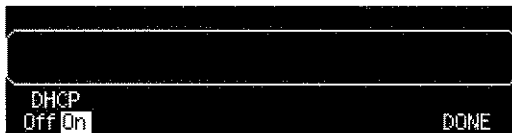

With **DHCP On**, an IP address will automatically be set by DHCP (Dynamic Host Configuration Protocol) when you connect the Agilent 33220A to the network, provided the DHCP server is found and is able to do so. DHCP also automatically deals with the subnet mask and gateway address, if required. *This is typically the easiest way to establish LAN communication for your instrument. All you need to do is leave **DHCP On**.*

However, if you cannot establish communication by means of DHCP, you will need to manually set an IP address, and a subnet mask and gateway address if they are in use. Follow these steps:

- a. **Set the "IP Address."** Press the softkey to select **DHCP Off**. The manual selection softkeys appear and the current IP address is displayed:



Contact your network administrator for the IP address to use. All IP addresses take the form "nnn.nnn.nnn.nnn" where each "nnn" is a byte value in the range 000 through 255. You can enter a new IP address using the numeric keypad (not the knob). Just type in the numbers and the period delimiters using the keypad. Use the left cursor key as a backspace key.

- b. **Set the “Subnet Mask.”** The subnet mask is required if your network has been divided into subnets. Ask your network administrator whether a subnet mask is needed, and for the correct mask. Press the **Subnet Mask** softkey and enter the subnet mask in the IP address format (using the keypad).



- c. **Set the “Default Gateway.”** The gateway address is the address of a gateway, which is a device that connects two networks. Ask your network administrator whether a gateway is in use and for the correct address. Press the **Default Gateway** softkey and enter the gateway address in the IP address format (using the keypad).
- d. **Exit the “IP Setup” menu.** Press **DONE** to return to the “LAN” menu.

4 Configure the “DNS Setup” (optional).

DNS (Domain Name Service) is an Internet service that translates domain names into IP addresses. Ask your network administrator whether DNS is in use, and if it is, for the host name, domain name, and DNS server address to use.

Start at the “LAN” menu.



Press the **DNS Setup** softkey to display the “Host Name” field.



- a. **Set the "Host Name."** Enter the host name. The host name is the host portion of the domain name, which is translated into an IP address. The host name is entered as a string using the knob and cursor keys to select and change characters. The host name may include letters, numbers, and dashes ("-"). You can use the keypad for the numeric characters only.

Press  to delete all characters to the right of the cursor position.

- b. **Set the "Domain Name."** Press the **Domain Name** softkey and enter the domain name. The domain name is translated into an IP address. The domain name is entered as a string using the knob and cursor keys to select and change characters. The domain name may include letters, numbers, dashes ("-"), and periods ("."). You can use the keypad for the numeric characters only.

Press  to delete all characters to the right of the cursor position.

- c. **Set the "DNS Server" address.** Press the **DNS Server** softkey and enter the address of the DNS server in the IP address format (using the keypad).
- d. **Exit the "DNS Setup" menu.** Press **DONE** to return to the "LAN" menu.

5 View the current LAN configuration.

Press the **Current Config** softkey to view the current LAN configuration. To scroll through the configuration, use the ↑ and ↓ softkeys or rotate the knob. Press **DONE** to return to the "LAN" menu.

6 Exit the menu.

Press **DONE** to exit each menu in turn, or press  to exit the "Utility" menu directly.

Features and Functions

Features and Functions

This chapter makes it easy to look up all the details about a particular feature of the function generator. It covers both front panel and remote interface operation. You may want to read chapter 2, “Front-Panel Menu Operation” first. See chapter 4, “Remote Interface Reference” for a detailed discussion of the syntax of the SCPI commands to program the function generator. This chapter is divided into the following sections:

- Output Configuration, *on page 55*
- Pulse Waveforms, *on page 70*
- Amplitude Modulation (AM), *on page 74*
- Frequency Modulation (FM), *on page 79*
- Phase Modulation (PM), *on page 84*
- Frequency-Shift Keying (FSK) Modulation, *on page 89*
- Pulse Width Modulation (PWM), *on page 89*
- Frequency Sweep, *on page 99*
- Burst Mode, *on page 106*
- Triggering, *on page 115*
- Arbitrary Waveforms, *on page 120*
- System-Related Operations, *on page 126*
- Remote Interface Configuration, *on page 135*
- Calibration Overview, *on page 141*
- Factory Default Settings, *on page 139*

Throughout this manual “*default*” states and values are identified. These are the power-on default states *provided* you have not enabled the power-down recall mode (see “Instrument State Storage” on page 126).

Throughout this manual, the following conventions are used for SCPI command syntax for remote interface programming:

- Square brackets ([]) indicate optional keywords or parameters.
- Braces ({ }) enclose parameters within a command string.
- Triangle brackets (< >) enclose parameters for which you must substitute a value.
- A vertical bar (|) separates multiple parameter choices.

Output Configuration

This section contains information to help you configure the function generator for outputting waveforms. You may never have to change some of the parameters discussed here, but they are provided to give you the flexibility you might need.

Output Function

The function generator can output five standard waveforms (sine, square, ramp, pulse, and noise), plus dc. You can also select one of five built-in arbitrary waveforms or create your own custom waveforms. You can internally modulate sine, square, ramp, and arbitrary waveforms using AM, FM, PM, or FSK. You can also modulate pulse using PWM. Linear or logarithmic frequency sweeping is available for sine, square, ramp, and arbitrary waveforms. You can generate a burst waveform using any of the standard or arbitrary waveforms (but not dc). *The default function is sine wave.*

- The table below shows which output functions are allowed with modulation, sweep, and burst. Each “•” indicates a valid combination. If you change to a function that is not allowed with modulation, sweep, or burst, then the modulation or mode is turned off.

	Sine	Square	Ramp	Pulse	Noise	DC	Arb
AM, FM, PM, FSK Carrier	•	•	•				•
PWM Carrier				•			
Sweep Mode	•	•	•				•
Burst Mode	•	•	•	•	• ¹		•

¹ Allowed in the External Gated burst mode only.

Chapter 3 Features and Functions

Output Configuration

- *Function Limitations:* If you change to a function whose maximum frequency is less than that of the current function, the frequency is adjusted to the maximum value for the new function. For example, if you are currently outputting a 20 MHz sine wave and then change to the ramp function, the function generator will automatically adjust the output frequency to 200 kHz (the upper limit for ramps).
- *Amplitude Limitations:* If you change to a function whose maximum amplitude is less than that of the current function, the amplitude is automatically adjusted to the maximum value for the new function. This may occur when the output units are *Vrms* or *dBm* due to the differences in crest factor for the various output functions.

For example, if you output a 5 Vrms square wave (into 50 ohms) and then change to the sine wave function, the function generator will automatically adjust the output amplitude to 3.536 Vrms (the upper limit for sine in Vrms).

- *Front-Panel Operation:* To select a function, press any key in the top row of function keys. Press **Arb** to output the arbitrary waveform currently selected. To view the other arbitrary waveform choices, press the **Select Wform** softkey.

To select *dc volts* from the front panel, press **Utility** and then select the **DC On** softkey. Press the **Offset** softkey to enter the desired offset voltage level.

- *Remote Interface Operation:*

```
FUNCTION {SINusoid|SQUare|RAMP|PULSe|NOISE|DC|USER}
```

You can also use the **APPLY** command to select the function, frequency, amplitude, and offset with a single command.

Output Frequency

As shown below, the output frequency range depends on the function currently selected. *The default frequency is 1 kHz for all functions.*

Function	Minimum Frequency	Maximum Frequency
Sine	1 μ Hz	20 MHz
Square	1 μ Hz	20 MHz
Ramp	1 μ Hz	200 kHz
Pulse	500 μ Hz	5 MHz
Noise, DC	Not Applicable	Not Applicable
Arbs	1 μ Hz	6 MHz

3

- **Function Limitations:** If you change to a function whose maximum frequency is less than that of the current function, the frequency is adjusted to the maximum value for the new function. For example, if you are currently outputting a 20 MHz sine wave and then change to the ramp function, the function generator will automatically adjust the output frequency to 200 kHz (the upper limit for ramps).
- **Burst Limitation:** For internally-triggered bursts, the minimum frequency is 2 mHz. For sine and square waveforms, frequencies above 6 MHz are allowed only with an “infinite” burst count.
- **Duty Cycle Limitations:** For square waveforms, the function generator may not be able to use the full range of duty cycle values at higher frequencies as shown below.

20% to 80% (frequency \leq 10 MHz)

40% to 60% (frequency $>$ 10 MHz)

If you change to a frequency that cannot produce the current duty cycle, the duty cycle is automatically adjusted to the maximum value for the new frequency. For example, if you currently have the duty cycle set to 70% and then change the frequency to 12 MHz, the function generator will automatically adjust the duty cycle to 60% (the upper limit for this frequency).

Output Configuration

- *Front-Panel Operation:* To set the output frequency, press the **Freq** softkey for the selected function. Then use the knob or numeric keypad to enter the desired frequency. To set the waveform period instead, press the **Freq** softkey again to toggle to the **Period** softkey.
- *Remote Interface Operation:*

```
FREQuency {<frequency>|MINimum|MAXimum}
```

You can also use the **APPLY** command to select the function, frequency, amplitude, and offset with a single command.

Output Amplitude

The default amplitude is 100 mVpp (into 50 ohms) for all functions.

- *Offset Voltage Limitations:* The relationship between output amplitude and offset voltage is shown below. V_{max} is the maximum peak voltage for the selected output termination (5 volts for a 50 Ω load or 10 volts for a high-impedance load).

$$V_{pp} \leq 2 \times (V_{max} - |V_{offset}|)$$

- *Limits Due to Output Termination:* If you change the output termination setting, the displayed output amplitude will be adjusted (and no error will be generated). For example, if you set the amplitude to 10 Vpp and then change the output termination from 50 ohms to "high impedance", the amplitude displayed on the function generator's front-panel will *double* to 20 Vpp. If you change from "high impedance" to 50 ohms, the displayed amplitude will drop in half. *For more information, see "Output Termination" on page 63.*
- *Limits Due to Units Selection:* In some cases, the amplitude limits are determined by the output units selected. This may occur when the units are *Vrms* or *dBm* due to the differences in crest factor for the various output functions. For example, if you output a 5 *Vrms* square wave (into 50 ohms) and then change to the sine wave function, the function generator will automatically adjust the output amplitude to 3.536 *Vrms* (the upper limit for sine waves in *Vrms*).

- You can set the output amplitude in Vpp, Vrms, or dBm. *For more information, see “Output Units” on page 62.*
- You cannot specify the output amplitude in dBm if the output termination is currently set to “high impedance”. The units are automatically converted to Vpp. *For more information, see “Output Units” on page 62.*
- *Arbitrary Waveform Limitations:* For arbitrary waveforms, the maximum amplitude will be limited if the waveform data points do not span the full range of the output DAC (Digital-to-Analog Converter). For example, the built-in “Sinc” waveform does not use the full range of values between ± 1 and therefore its maximum amplitude is limited to 6.087 Vpp (into 50 ohms).
- While changing amplitude, you may notice a momentary disruption in the output waveform at certain voltages due to switching of the output attenuators. To prevent this disruption in the output, you can disable the voltage autoranging feature as described on page 66.
- You can also set the amplitude (with an associated offset voltage) by specifying a high level and low level. For example, if you set the high level to +2 volts and the low level to -3 volts, the resulting amplitude is 5 Vpp (with an offset voltage of -500 mV).
- For dc volts, the output level is actually controlled by setting the offset voltage. You can set the dc level to any value between ± 5 Vdc into 50 ohms or ± 10 Vdc into an open circuit. *See “DC Offset Voltage” on the following page for more information.*

To select *dc volts* from the front panel, press  and then select the **DC On** softkey. Press the **Offset** softkey to set the desired offset voltage level.

- *Front-Panel Operation:* To set the output amplitude, press the **Ampl** softkey for the selected function. Then use the knob or numeric keypad to enter the desired amplitude. To set the amplitude using a high level and low level, press the **Ampl** softkey again to toggle to the **HiLevel** and **LoLevel** softkeys.

Chapter 3 Features and Functions

Output Configuration

- *Remote Interface Operation:*

```
VOLTage {<amplitude>|MINimum|MAXimum}
```

Or, you can set the amplitude by specifying a high level and low level using the following commands.

```
VOLTage:HIGH {<voltage>|MINimum|MAXimum}  
VOLTage:LOW {<voltage>|MINimum|MAXimum}
```

You can also use the APPLy command to select the function, frequency, amplitude, and offset with a single command.

DC Offset Voltage

The default offset is 0 volts for all functions.

- *Limits Due to Amplitude:* The relationship between offset voltage and output amplitude is shown below. V_{max} is the maximum *peak voltage* for the selected output termination (5 volts for a 50 Ω load or 10 volts for a high-impedance load).

$$|V_{offset}| \leq V_{max} - \frac{V_{pp}}{2}$$

If the specified offset voltage is not valid, the function generator will automatically adjust it to the maximum dc voltage allowed with the amplitude specified.

- *Limits Due to Output Termination:* The offset limits are determined by the current output termination setting. For example, if you set the offset to 100 mVdc and then change the output termination from 50 ohms to “high impedance”, the offset voltage displayed on the function generator’s front-panel will *double* to 200 mVdc (and no error will be generated). If you change from “high impedance” to 50 ohms, the displayed offset will drop in half. See “*Output Termination*” on page 63 for more information.

- *Arbitrary Waveform Limitations:* For arbitrary waveforms, the maximum offset and amplitude will be limited if the waveform data points do not span the full range of the output DAC (Digital-to-Analog Converter). For example, the built-in “Sinc” waveform does not use the full range of values between ± 1 and therefore its maximum offset is limited to 4.95 volts (into 50 ohms).
- You can also set the offset by specifying a high level and low level. For example, if you set the high level to +2 volts and the low level to -3 volts, the resulting amplitude is 5 Vpp (with an offset voltage of -500 mV).
- For dc volts, the output level is actually controlled by setting the offset voltage. You can set the dc level to any value between ± 5 Vdc into 50 ohms or ± 10 Vdc into an open circuit.

To select *dc volts* from the front panel, press **Utility** and then select the **DC On** softkey. Press the **Offset** softkey to set the desired offset voltage level.

- *Front-Panel Operation:* To set the dc offset, press the **Offset** softkey for the selected function. Then use the knob or numeric keypad to enter the desired offset. To set the offset using a high level and low level, press the **Offset** softkey again to toggle to the **HiLevel** and **LoLevel** softkeys.
- *Remote Interface Operation:*

```
VOLTage:OFFSet {<offset>|MINimum|MAXimum}
```

Or, you can set the offset by specifying a high level and low level using the following commands.

```
VOLTage:HIGH {<voltage>|MINimum|MAXimum}  
VOLTage:LOW {<voltage>|MINimum|MAXimum}
```

You can also use the **APPLY** command to select the function, frequency, amplitude, and offset with a single command.

Output Configuration

Output Units

Applies to output amplitude only. At power-on, the units for output amplitude are volts peak-to-peak.

- Output units: **Vpp**, Vrms, or dBm. *The default is Vpp.*
- The unit setting is stored in *volatile* memory. The units are set to “Vpp” when power has been off or after a remote interface reset (provided the Power On state is set to “default”).
- The function generator uses the current units selection for both front panel and remote interface operations. For example, if you select “VRMS” from the remote interface, the units are displayed as “VRMS” on the front panel.
- The output units for amplitude cannot be set to dBm if the output termination is currently set to “high impedance”. The units are automatically converted to Vpp.
- *Front-Panel Operation:* Use the numeric keypad to enter the desired magnitude and then press the appropriate softkey to select the units. You can also convert from one unit to another from the front panel. For example, to convert 2 Vpp to its equivalent value in Vrms, press $\boxed{+/-}$ and then press the **V_{RMS}** softkey. The converted value is 707.1 mVrms for a sine wave.
- *Remote Interface Operation:*

```
VOLTage:UNIT {VPP|VRMS|DBM}
```

Output Termination

Applies to output amplitude and offset voltage only. The Agilent 33220A has a fixed series output impedance of 50 ohms to the front-panel *Output* connector. If the actual load impedance is different than the value specified, the displayed amplitude and offset levels will be incorrect.

- Output termination: 1Ω to 10 kΩ, or Infinite. The default is 50Ω. The message line at the top of the display calls attention to output termination settings other than 50Ω.
- The output termination setting is stored in *non-volatile* memory and *does not* change when power has been off or after a remote interface reset (assuming the Power On state is set to “default”).
- If you specify a 50-ohm termination but are actually terminating into an open circuit, the actual output will be *twice* the value specified. For example, if you set the offset to 100 mVdc (and specify a 50-ohm load) but are terminating the output into an open circuit, the actual offset will be 200 mVdc.
- If you change the output termination setting, the displayed output amplitude and offset levels are automatically adjusted (no error will be generated). For example, if you set the amplitude to 10 Vpp and then change the output termination from 50 ohms to “high impedance”, the amplitude displayed on the function generator’s front-panel will *double* to 20 Vpp. If you change from “high impedance” to 50 ohms, the displayed amplitude will drop in half.
- You cannot specify the output amplitude in dBm if the output termination is currently set to “high impedance”. The units are automatically converted to Vpp.
- *Front-Panel Operation:* Press **Utility** and select the **Output Setup** softkey. Then use the knob or numeric keypad to select the desired load impedance or press the **Load** softkey again to choose “High Z”.
- *Remote Interface Operation:*

```
OUTPut:LOAD {<ohms>|INFIinity|MINimum|MAXimum}
```

Duty Cycle (Square Waves)

The duty cycle of a square wave represents the amount of time per cycle that the square wave is at a *high level* (assuming that the waveform is not inverted).

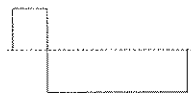

20% Duty Cycle



80% Duty Cycle

(See Pulse Waveforms, on page 70 for information about duty cycle for pulse waveforms.)

- Duty Cycle: 20% to 80% (*frequency* ≤ 10 MHz)
40% to 60% (*frequency* > 10 MHz)
- The duty cycle is stored in *volatile* memory; the duty cycle is set to 50% (the default) when power has been off or after a remote interface reset (assuming the Power On state is set to “default”).
- The duty cycle setting is remembered when you change from square wave to another function. When you return to the square function, the previous duty cycle is used.
- *Limits Due to Frequency*: If the square wave function is selected and you change to a frequency that cannot produce the current duty cycle, the duty cycle is automatically adjusted to the maximum value for the new frequency. For example, if you currently have the duty cycle set to 70% and then change the frequency to 12 MHz, the function generator will automatically adjust the duty cycle to 60% (the upper limit for this frequency).
- The duty cycle setting *does not* apply to a square waveform used as the *modulating* waveform for AM, FM, PM or PWM. A 50% duty cycle is always used for a modulating square waveform. The duty cycle setting applies only to a square waveform *carrier*.
- *Front-Panel Operation*: After selecting the square wave function, press the **Duty Cycle** softkey. Then use the knob or numeric keypad to enter the desired duty cycle.

- *Remote Interface Operation:*

FUNCTION:SQUare:DCYCLE {<percent>|MINimum|MAXimum}

The APPLY command automatically sets the duty cycle to 50%.

Symmetry (Ramp Waves)

Applies to ramp waves only. Symmetry represents the amount of time per cycle that the ramp wave is *rising* (assuming that the waveform is not inverted).

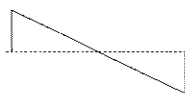

0% Symmetry

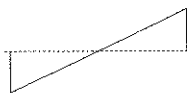

100% Symmetry

- The symmetry is stored in *volatile* memory; the symmetry is set to 100% (the default) when power has been off or after a remote interface reset (assuming the Power On state is set to “default”).
- The symmetry setting is remembered when you change from ramp wave to another function. When you return to the ramp function, the previous symmetry is used.
- If you select a ramp waveform as the *modulating* waveform for AM, FM, PM, or PWM, the symmetry setting *does not* apply.
- *Front-Panel Operation:* After selecting the ramp function, press the **Symmetry** softkey. Then use the knob or numeric keypad to enter the desired symmetry.
- *Remote Interface Operation:*

FUNCTION:RAMP:SYMMetry {<percent>|MINimum|MAXimum}

The APPLY command automatically sets the symmetry to 100%.

Voltage Autoranging

Autoranging is enabled by default and the function generator automatically selects the optimal settings for the output amplifier and attenuators. With autoranging disabled, the function generator uses the current amplifier and attenuator settings.

- You can disable autoranging to eliminate momentary disruptions caused by switching of the attenuators while changing amplitude. *However, turning autoranging off has side effects:*
 - The amplitude and offset accuracy and resolution (as well as waveform fidelity) may be adversely affected when reducing the amplitude below a range change that would occur with autoranging on.
 - You may not be able to achieve the minimum amplitude that is available with autoranging on.
- *Front-Panel Operation:* Press **Utility** and select the **Output Setup** softkey. Then press the **Range** softkey again to toggle between the “Auto” and “Hold” selections.
- *Remote Interface Operation:*

```
VOLTage:RANGe:AUTO {OFF|ON|ONCE}
```

The APPLY command overrides the voltage autorange setting and automatically enables autoranging.

Output Control

You can disable or enable the front-panel *Output* connector. By default, the output is disabled at power on to protect other equipment. When enabled, the **Output** key is illuminated.

- If an excessive external voltage is applied to the front-panel *Output* connector, an error message will be displayed and the output will be disabled. To re-enable the output, remove the overload from the *Output* connector and press **Output** to enable the output.
- *Front-Panel Operation:* Press **Output** to enable or disable the output.

- *Remote Interface Operation:*

OUTPut {OFF|ON}

The APPLY command overrides the current setting and automatically enables the *Output* connector.

Waveform Polarity

In the *normal* mode (default), the waveform goes positive during the first part of the cycle. In the *inverted* mode, the waveform goes negative during the first part of the cycle.

- As shown in the examples below, the waveform is inverted *relative to* the offset voltage. Any offset voltage present will remain unchanged when the waveform is inverted.

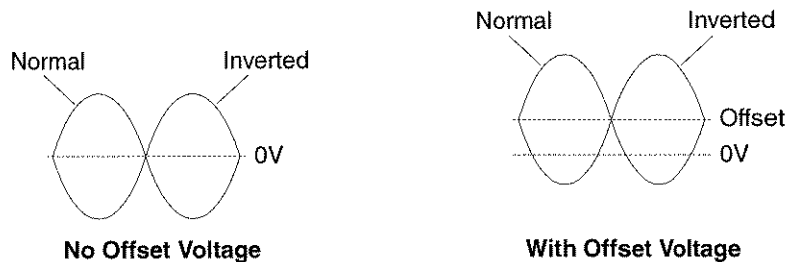

- When a waveform is inverted, the Sync signal associated with the waveform *is not* inverted.
- *Front-Panel Operation:* Press **Utility** and select the **Output Setup** softkey. Then press the **Normal** softkey again to toggle between the "Normal" and "Invert" selections.
- *Remote Interface Operation:*

OUTPut:POLarity {NORMal|INVerted}

Sync Output Signal

A sync output is provided on the front-panel *Sync* connector. All of the standard output functions (except dc and noise) have an associated Sync signal. For certain applications where you may not want to output the Sync signal, you can disable the *Sync* connector.

- By default, the Sync signal is routed to the *Sync* connector (enabled). When the Sync signal is disabled, the output level on the *Sync* connector is at a logic “low” level.
- When a waveform is inverted (see “Waveform Polarity” on the previous page), the Sync signal associated with the waveform *is not* inverted.
- The Sync signal setting is overridden by the setting of the marker used with the sweep mode (see page 103). Therefore, when the marker is enabled (and the sweep mode is also enabled), the Sync signal setting is ignored.
- For *sine*, *ramp*, and *pulse* waveforms, the Sync signal is a square waveform with a 50% duty cycle. The Sync signal is a TTL “high” when the waveform’s output is positive, relative to zero volts (or the dc offset value). The Sync signal is a TTL “low” when the output is negative, relative to zero volts (or the dc offset value).
- For *square* waveforms, the Sync signal is a square waveform with the same duty cycle as the main output. The Sync signal is a TTL “high” when the waveform’s output is positive, relative to zero volts (or the dc offset value). The Sync signal is a TTL “low” when the output is negative, relative to zero volts (or the dc offset value).
- For *arbitrary* waveforms, the Sync signal is a square waveform with a 50% duty cycle. The Sync signal is a TTL “high” when the first downloaded waveform point is output.
- For internally-modulated *AM*, *FM*, *PM*, and *PWM*, the Sync signal is referenced to the modulating waveform (not the carrier) and is a square waveform with a 50% duty cycle. The Sync signal is a TTL “high” during the first half of the modulating waveform.
- For externally-modulated *AM*, *FM*, *PM*, and *PWM*, the Sync signal is referenced to the carrier waveform (not the modulating waveform) and is a square waveform with a 50% duty cycle.

- For *FSK*, the Sync signal is referenced to the “hop” frequency. The Sync signal is a TTL “high” on the transition to the “hop” frequency.
- For *frequency sweeps with Marker Off*, the Sync signal is a square waveform with a 50% duty cycle. The Sync signal is a TTL “high” at the beginning of the sweep and goes “low” at the midpoint of the sweep. The frequency of the sync waveform equals the specified sweep time.
- For *frequency sweeps with Marker On*, the Sync signal is a TTL “high” at the beginning of the sweep and goes “low” at the marker frequency.
- For a *triggered burst*, the Sync signal is a TTL “high” when the burst begins. The Sync signal is a TTL “low” at the end of the specified number of cycles (may not be the zero-crossing point if the waveform has an associated start phase). For an *infinite count burst*, the Sync signal is the same as for a continuous waveform.
- For an *externally-gated burst*, the Sync signal follows the external gate signal. However, note that the signal will not go to a TTL “low” until the end of the last cycle (may not be the zero-crossing point if the waveform has an associated start phase).
- *Front-Panel Operation*: Press  and select the **Sync** softkey again to toggle between “off” and “on”.
- *Remote Interface Operation*:

OUTPut: SYNC {OFF | ON} *Setting is stored in non-volatile memory*

Pulse Waveforms

As shown below, a pulse waveform consists of a *period*, a *pulse width*, a *rising edge*, and a *falling edge*.

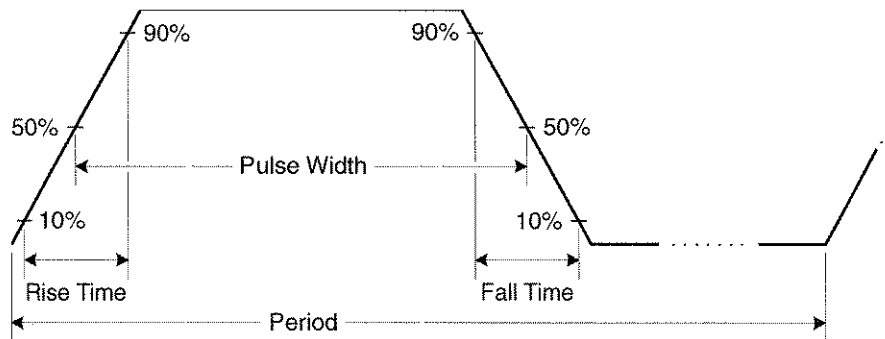

Pulse Period

- Pulse period: 200 ns to 2000 s. *The default is 1 ms.*
- The specified period must be greater than the sum of the *pulse width* and the *edge time* as shown below. The function generator will adjust the pulse width and edge time as needed to accommodate the specified period.

$$\text{Period} \geq \text{Pulse Width} + (1.6 \times \text{Edge Time})$$

- *Front-Panel Operation:* After selecting the pulse function, press the **Freq** softkey again to toggle to the **Period** softkey. Then use the knob or numeric keypad to enter the desired pulse period.
- *Remote Interface Operation:*

```
PULSe:PERiod {<seconds>|MINimum|MAXimum}
```

Pulse Width

The pulse width represents the time from the 50% threshold of the rising edge of the pulse to the 50% threshold of the next falling edge.

- Pulse width: 20 ns to 2000 s (see restrictions below). *The default pulse width is 100 μs.*
- The *minimum pulse width* (Wmin) is affected by the period.

Wmin = 20 ns for period ≤ 10 s.
Wmin = 200 ns for period > 10 s, but ≤ 100 s.
Wmin = 2 μs for period > 100 s, but ≤ 1000 s.
Wmin = 20 μs for period > 1000 s.

- The specified pulse width must also be less than the difference between the *period* and the *minimum pulse width as shown below*. The function generator will adjust the pulse width as needed to accommodate the specified period.

$$\text{Pulse Width} \leq \text{Period} - \text{Wmin}$$

- The specified pulse width must be less than the difference between the *period* and the *edge time* as shown below. The function generator will automatically adjust the pulse width as needed to accommodate the specified period.

$$\text{Pulse Width} \leq \text{Period} - (1.6 \times \text{Edge Time})$$

- The pulse width must also be greater than the total time of one edge as shown below.

$$\text{Pulse Width} \geq 1.6 \times \text{Edge Time}$$

- *Front-Panel Operation:* After selecting the pulse function, press the **Width** softkey. Then use the knob or numeric keypad to enter the desired pulse width.
- *Remote Interface Operation:*

```
FUNCTION:PULSe:WIDTh {<seconds>|MINimum|MAXimum}
```

Pulse Waveforms

Pulse Duty Cycle

The pulse duty cycle is defined as:

$$\text{Duty Cycle} = 100 \times \text{Pulse Width} \div \text{Period}$$

where the pulse width represents the time from the 50% threshold of the rising edge of the pulse to the 50% threshold of the next falling edge.

- Pulse duty cycle: 0% to 100% (see restrictions below). The default is 10%.
- The specified pulse duty cycle must conform to the following restrictions determined by the *minimum pulse width* (W_{min}). The function generator will adjust the pulse duty cycle as needed to accommodate the specified period.

$$\text{Duty Cycle} \geq 100 \times W_{min} \div \text{Period}$$

and

$$\text{Duty Cycle} \leq 100 \times (1 - W_{min} \div \text{Period})$$

where:

$$W_{min} = 20 \text{ ns for period } \leq 10 \text{ s.}$$

$$W_{min} = 200 \text{ ns for period } > 10 \text{ s, but } \leq 100 \text{ s.}$$

$$W_{min} = 2 \text{ } \mu\text{s for period } > 100 \text{ s, but } \leq 1000 \text{ s.}$$

$$W_{min} = 20 \text{ } \mu\text{s for period } > 1000 \text{ s.}$$

- The specified pulse duty cycle must conform to the following restriction determined by the *edge time*. The function generator will adjust the pulse duty cycle as needed to accommodate the specified period.

$$\text{Duty Cycle} \geq 100 \times (1.6 \times \text{Edge Time}) \div \text{Period}$$

and

$$\text{Duty Cycle} \leq 100 \times (1 - (1.6 \times \text{Edge Time}) \div \text{Period})$$

- *Front-Panel Operation:* After selecting the pulse function, press the **Dty Cyc** softkey. Then use the knob or numeric keypad to enter the desired duty cycle.
- *Remote Interface Operation:*

FUNCTION:PULSE:DCYCLE {<percent> | MINimum | MAXimum}

Edge Time

The edge time sets each edge transition time (rising and falling) of the pulse. The rise time and fall time cannot be set independently—each is equal to the edge time. For each transition, the edge time represents the time from the 10% threshold to the 90% threshold.

- Edge time: 5 ns to 100 ns (see restrictions below). *The default edge time is 5 ns.*
- The specified edge time must fit within the specified pulse width as shown below. The function generator will adjust the edge time as needed to accommodate the specified pulse width.

$$\text{Edge Time} \leq 0.625 \times \text{Pulse Width}$$

or in terms of duty cycle

$$\text{Edge Time} \leq 0.625 \times \text{Period} \times \text{Duty Cycle} \div 100$$

- *Front-Panel Operation:* After selecting the pulse function, press the **Edge Time** softkey. Then use the knob or numeric keypad to enter the desired edge time.
- *Remote Interface Operation:*

```
FUNCTION:PULSe:TRANSition {<seconds>|MINimum|MAXimum}
```

Amplitude Modulation (AM)

A modulated waveform consists of a *carrier waveform* and a *modulating waveform*. In AM, the amplitude of the carrier is varied by the instantaneous voltage of the modulating waveform. The function generator will accept an internal or external modulation source.

For more information on the fundamentals of Amplitude Modulation, refer to chapter 7, "Tutorial".

To Select AM Modulation

- The function generator will allow only one modulation mode to be enabled at a time. For example, you cannot enable AM and FM at the same time. When you enable AM, the previous modulation mode is turned off.
- The function generator will not allow AM to be enabled at the same time that sweep or burst is enabled. When you enable AM, the sweep or burst mode is turned off.
- *Front-Panel Operation:* You must enable AM *before* setting up any of the other modulation parameters. Press **Mod** and then select "AM" using the **Type** softkey. The AM waveform is output using the present settings for the carrier frequency, modulating frequency, output amplitude, and offset voltage.
- *Remote Interface Operation:* To avoid multiple waveform changes, enable AM *after* you have set up the other modulation parameters.

```
AM:STATE {OFF|ON}
```

Carrier Waveform Shape

- AM carrier shape: **Sine**, Square, Ramp, or Arbitrary waveform. *The default is Sine. You cannot use pulse, noise, or dc as the carrier waveform.*
- *Front-Panel Operation:* Press any of the front-panel function keys except **Pulse** or **Noise**. For arbitrary waveforms, press **Arb** and then choose the **Select Wform** softkey to select the active waveform.
- *Remote Interface Operation:*

FUNCTION {SINusoid|SQUare|RAMP|USER}

You can also use the APPLY command to select the function, frequency, amplitude, and offset with a single command.

Carrier Frequency

The maximum carrier frequency depends on the function selected as shown below. *The default is 1 kHz for all functions.*

Function	Minimum Frequency	Maximum Frequency
Sine	1 μ Hz	20 MHz
Square	1 μ Hz	20 MHz
Ramp	1 μ Hz	200 kHz
Arbs	1 μ Hz	6 MHz

- *Front-Panel Operation:* To set the carrier frequency, press the **Freq** softkey for the selected function. Then use the knob or numeric keypad to enter the desired frequency.
- *Remote Interface Operation:*

FREQUENCY {<frequency>|MINimum|MAXimum}

You can also use the APPLY command to select the function, frequency, amplitude, and offset with a single command.

Modulating Waveform Shape

The function generator will accept an internal or external modulation source for AM.

- Modulating waveform shape (*internal source*): **Sine**, Square, Ramp, Negative Ramp, Triangle, Noise, or Arb waveform. *The default is Sine.*

- Square has 50% duty cycle.



- Ramp has 100% symmetry.



- Triangle has 50% symmetry.



- Negative ramp has 0% symmetry.



- You can use noise as the modulating waveshape, but you *cannot* use noise, pulse, or dc as the carrier waveform.
- If you select an arbitrary waveform as the *modulating* waveshape, the waveform is automatically limited to 4K points. Extra waveform points are removed using decimation.
- *Front-Panel Operation:* After enabling AM, press the **Shape** softkey.
- *Remote Interface Operation:*

```
AM:INTernal:FUNCTION {SINusoid|SQUare|RAMP|NRAMP|
TRIangle|NOISe|USER}
```

Modulating Waveform Frequency

The function generator will accept an internal or external modulation source for AM.

- Modulating frequency (*internal source*): 2 mHz to 20 kHz. *The default is 100 Hz.*
- *Front-Panel Operation:* After enabling AM, press the **AM Freq** softkey.
- *Remote Interface Operation:*

```
AM:INTernal:FREQUENCY {<frequency>|MINimum|MAXimum}
```

Modulation Depth

The *modulation depth* is expressed as a percentage and represents the extent of the amplitude variation. At 0% depth, the output amplitude is half of the selected value. At 100% depth, the output amplitude equals the selected value.

- Modulation depth: 0% to 120%. *The default is 100%.*
- Note that even at greater than 100% depth, the function generator will not exceed $\pm 5V$ peak on the output (into a 50Ω load).
- If you select the *External* modulating source, the carrier waveform is modulated with an external waveform. The modulation depth is controlled by the $\pm 5V$ signal level present on the rear-panel *Modulation In* connector. For example, if you have set the modulation depth to 100%, then when the modulating signal is at +5 volts, the output will be at the *maximum* amplitude. When the modulating signal is at -5 volts, then the output will be at the *minimum* amplitude.
- *Front-Panel Operation:* After enabling AM, press the **AM Depth** softkey. Then use the knob or numeric keypad to enter the depth.
- *Remote Interface Operation:*

AM:DEPTH { <depth in percent> | MINimum | MAXimum }

Amplitude Modulation (AM)

Modulating Source

The function generator will accept an internal or external modulation source for AM.

- Modulating source: **Internal** or External. *The default is Internal.*
- If you select the *External* source, the carrier waveform is modulated with an external waveform. The modulation depth is controlled by the $\pm 5V$ signal level present on the rear-panel *Modulation In* connector. For example, if you have set the modulation depth to 100%, then when the modulating signal is at +5 volts, the output will be at the *maximum* amplitude. When the modulating signal is at -5 volts, then the output will be at the *minimum* amplitude.

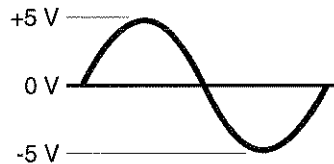
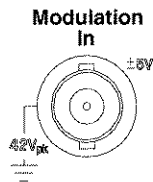

- *Front-Panel Operation:* After enabling AM, press the **Source** softkey.
- *Remote Interface Operation:*

```
AM:SOURce {INTernal|EXTernal}
```

Frequency Modulation (FM)

A modulated waveform consists of a *carrier waveform* and a *modulating waveform*. In FM, the frequency of the carrier is varied by the instantaneous voltage of the modulating waveform.

For more information on the fundamentals of Frequency Modulation, refer to chapter 7, "Tutorial".

To Select FM Modulation

- The function generator will allow only one modulation mode to be enabled at a time. For example, you cannot enable FM and AM at the same time. When you enable FM, the previous modulation mode is turned off.
- The function generator will not allow FM to be enabled at the same time that sweep or burst is enabled. When you enable FM, the sweep or burst mode is turned off.
- *Front-Panel Operation:* You must enable FM *before* setting up any of the other modulation parameters. Press **Mod** and then select "FM" using the **Type** softkey. The FM waveform is output using the present settings for the carrier frequency, modulating frequency, output amplitude, and offset voltage.
- *Remote Interface Operation:* To avoid multiple waveform changes, enable FM *after* you have set up the other modulation parameters.

FM:STATE {OFF|ON}

Carrier Waveform Shape

- FM carrier shape: **Sine**, Square, Ramp, or Arbitrary waveform. *The default is Sine. You cannot use pulse, noise, or dc as the carrier waveform.*
- *Front-Panel Operation:* Press any of the front-panel function keys except **Pulse** or **Noise**. For arbitrary waveforms, press **Arb** and then choose the **Select Wform** softkey to select the active waveform.
- *Remote Interface Operation:*

```
FUNCTION {SINusoid|SQUare|RAMP|USER}
```

You can also use the **APPLY** command to select the function, frequency, amplitude, and offset with a single command.

Carrier Frequency

The maximum carrier frequency depends on the function selected as shown below. *The default is 1 kHz for all functions.*

Function	Minimum Frequency	Maximum Frequency
Sine	1 μ Hz	20 MHz
Square	1 μ Hz	20 MHz
Ramp	1 μ Hz	200 kHz
Arbs	1 μ Hz	6 MHz

- The *carrier frequency* must always be greater than or equal to the frequency deviation. If you attempt to set the deviation to a value greater than the carrier frequency (with FM enabled), the function generator will automatically adjust the deviation to the maximum value allowed with the present carrier frequency.
- The sum of the *carrier frequency* and deviation must be less than or equal to the maximum frequency for the selected function **plus 100 kHz** (20.1 MHz for sine and square, 300 kHz for ramp, and 6.1 MHz for arbitrary waveforms). If you attempt to set the deviation to a value that is not valid, the function generator will automatically adjust it to the maximum value allowed with the present carrier frequency.
- *Front-Panel Operation:* To set the carrier frequency, press the **Freq** softkey for the selected function. Then use the knob or numeric keypad to enter the desired frequency.
- *Remote Interface Operation:*

FREQUENCY {<frequency> | MINimum | MAXimum}

You can also use the APPLY command to select the function, frequency, amplitude, and offset with a single command.

Modulating Waveform Shape

The function generator will accept an internal or external modulation source for FM.

- Modulating waveform shape (*internal source*): **Sine**, Square, Ramp, Negative Ramp, Triangle, Noise, or Arb waveform. *The default is Sine.*

- Square has 50% duty cycle.



- Ramp has 100% symmetry.



- Triangle has 50% symmetry.



- Negative ramp has 0% symmetry.



- You can use noise as the modulating waveshape, but you *cannot* use noise, pulse, or dc as the carrier waveform.
- If you select an arbitrary waveform as the *modulating* waveshape, the waveform is automatically limited to 4K points. Extra waveform points are removed using decimation.
- *Front-Panel Operation:* After enabling FM, press the **Shape** softkey.
- *Remote Interface Operation:*

```
FM:INTERNAL:FUNCTION {SINusoid|SQUare|RAMP|NRAMP|
TRIangle|NOISE|USER}
```

Modulating Waveform Frequency

The function generator will accept an internal or external modulation source for FM.

- Modulating frequency (*internal source*): 2 mHz to 20 kHz. *The default is 10 Hz.*
- *Front-Panel Operation:* After enabling FM, press the **FM Freq** softkey.
- *Remote Interface Operation:*

```
FM:INTERNAL:FREQUENCY {<frequency>|MINimum|MAXimum}
```

Frequency Deviation

The *frequency deviation* setting represents the peak variation in frequency of the modulated waveform from the carrier frequency.

- Frequency deviation: 1 μ Hz to 10.05 MHz (limited to 150 kHz for ramps and 3.05 MHz for arbitrary waveforms). *The default is 100 Hz.*
- The *carrier frequency* must always be greater than or equal to the deviation. If you attempt to set the deviation to a value greater than the carrier frequency (with FM enabled), the function generator will limit the deviation to the maximum value allowed with the present carrier frequency.
- The sum of the *carrier frequency* and deviation must be less than or equal to the maximum frequency for the selected function **plus 100 kHz** (20.1 MHz for sine and square, 300 kHz for ramp, and 6.1 MHz for arbitrary waveforms). If you attempt to set the deviation to a value that is not valid, the function generator will limit it to the maximum value allowed with the present carrier frequency.
- *Front-Panel Operation:* After enabling FM, press the **Freq Dev** softkey. Then use the knob or numeric keypad to enter the desired deviation.
- *Remote Interface Operation:*

FM:DEVIation {<peak deviation in Hz>|MINimum|MAXimum}

Modulating Source

The function generator will accept an internal or external modulation source for FM.

- Modulating source: **Internal** or External. *The default is Internal.*
- If you select the *External* source, the carrier waveform is modulated with an external waveform. The frequency deviation is controlled by the $\pm 5\text{V}$ signal level present on the rear-panel *Modulation In* connector. For example, if you have set the deviation to 100 kHz, then a $+5\text{V}$ signal level corresponds to a 100 kHz increase in frequency. Lower external signal levels produce less deviation and negative signal levels reduce the frequency below the carrier frequency.

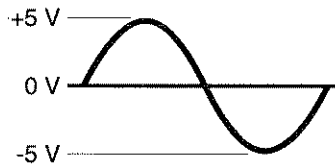
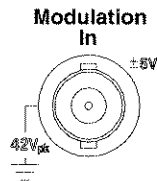

- *Front-Panel Operation:* After enabling FM, press the **Source** softkey.
- *Remote Interface Operation:*

```
FM:SOURce {INTernal|EXTernal}
```

Phase Modulation (PM)

A modulated waveform consists of a *carrier waveform* and a *modulating waveform*. PM is very similar to FM, but in PM the *phase* of the modulated waveform is varied by the instantaneous voltage of the modulating waveform.

For more information on the fundamentals of Phase Modulation, refer to chapter 7, "Tutorial".

To Select PM Modulation

- The function generator will allow only one modulation mode to be enabled at a time. For example, you cannot enable PM and AM at the same time. When you enable PM, the previous modulation mode is turned off.
- The function generator will not allow PM to be enabled at the same time that sweep or burst is enabled. When you enable PM, the sweep or burst mode is turned off.
- *Front-Panel Operation:* You must enable PM *before* setting up any of the other modulation parameters. Press **Mod** and then select "PM" using the **Type** softkey. The PM waveform is output using the present settings for the carrier frequency, modulating frequency, output amplitude, and offset voltage.
- *Remote Interface Operation:* To avoid multiple waveform changes, enable PM *after* you have set up the other modulation parameters.

```
PM:STATe {OFF|ON}
```

Phase Modulation (PM)**Carrier Waveform Shape**

- PM carrier shape: **Sine**, Square, Ramp, or Arbitrary waveform. *The default is Sine. You cannot use pulse, noise, or dc as the carrier waveform.*
- *Front-Panel Operation:* Press any of the front-panel function keys except **Pulse** or **Noise**. For arbitrary waveforms, press **Arb** and then choose the **Select Wform** softkey to select the active waveform.
- *Remote Interface Operation:*

```
FUNCTION {SINusoid|SQUare|RAMP|USER}
```

You can also use the **APPLY** command to select the function, frequency, amplitude, and offset with a single command.

Carrier Frequency

The maximum carrier frequency depends on the function selected as shown below. *The default is 1 kHz for all functions.*

Function	Minimum Frequency	Maximum Frequency
Sine	1 μ Hz	20 MHz
Square	1 μ Hz	20 MHz
Ramp	1 μ Hz	200 kHz
Arbs	1 μ Hz	6 MHz





- *Front-Panel Operation:* To set the carrier frequency, press the **Freq** softkey for the selected function. Then use the knob or numeric keypad to enter the desired frequency.
- *Remote Interface Operation:*

```
FREQUENCY {<frequency>|MINimum|MAXimum}
```

You can also use the **APPLY** command to select the function, frequency, amplitude, and offset with a single command.

Modulating Waveform Shape

The function generator will accept an internal or external modulation source for PM.

- Modulating waveform shape (*internal source*): **Sine**, Square, Ramp, Negative Ramp, Triangle, Noise, or Arb waveform. *The default is Sine.*
 - Square has 50% duty cycle. 
 - Ramp has 100% symmetry. 
 - Triangle has 50% symmetry. 
 - Negative ramp has 0% symmetry. 
- You can use noise as the modulating waveshape, but you *cannot* use noise, pulse, or dc as the carrier waveform.
- If you select an arbitrary waveform as the *modulating* waveshape, the waveform is automatically limited to 4K points. Extra waveform points are removed using decimation.
- *Front-Panel Operation:* After enabling PM, press the **Shape** softkey.
- *Remote Interface Operation:*

```
PM:INTernal:FUNCTION {SINusoid|SQUare|RAMP|NRAMP|
TRIangle|NOISE|USER}
```

Modulating Waveform Frequency

The function generator will accept an internal or external modulation source for PM.

- Modulating frequency (*internal source*): 2 mHz to 20 kHz. *The default is 10 Hz.*
- *Front-Panel Operation:* After enabling PM, press the **PM Freq** softkey.
- *Remote Interface Operation:*

```
PM:INTernal:FREQUENCY {<frequency>|MINimum|MAXimum}
```

Phase Modulation (PM)

Phase Deviation

The *phase deviation* setting represents the peak variation in phase of the modulated waveform from the carrier waveform. The phase deviation can be set from 0 to 360 degrees. The default is 180 degrees.

- Since a 360 degree phase deviation is equivalent to 0 degrees, the maximum effective deviation setting is 180 degrees.
- *Front-Panel Operation:* After enabling PM, press the **Phase Dev** softkey. Then use the knob or numeric keypad to enter the desired deviation.
- *Remote Interface Operation:*

```
PM:DEVIation { < deviation in degrees > | MINimum | MAXimum }
```

Modulating Source

The function generator will accept an internal or external modulation source for PM.

- Modulating source: **Internal** or **External**. *The default is Internal.*
- If you select the *External* source, the carrier waveform is modulated with an external waveform. The phase deviation is controlled by the $\pm 5V$ signal level present on the rear-panel *Modulation In* connector. For example, if you have set the deviation to 180 degrees, then a +5V signal level corresponds to a 180 degree phase shift. Lower external signal levels produce less deviation.

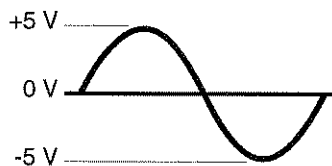
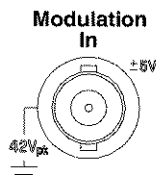

- *Front-Panel Operation:* After enabling PM, press the **Source** softkey.
- *Remote Interface Operation:*

```
PM:SOURce { INTernal | EXTernal }
```

Frequency-Shift Keying (FSK) Modulation

You can configure the function generator to “shift” its output frequency between two preset values using FSK modulation. The rate at which the output shifts between the two frequencies (called the “carrier frequency” and the “hop frequency”) is determined by the internal rate generator or the signal level on the rear-panel *Trig In* connector.

For more information on the fundamentals of FSK Modulation, refer to chapter 7, “Tutorial”.

To Select FSK Modulation

- The function generator will allow only one modulation mode to be enabled at a time. For example, you cannot enable FSK and AM at the same time. When you enable FSK, the previous modulation mode is turned off.
- The function generator will not allow FSK to be enabled at the same time that sweep or burst is enabled. When you enable FSK, the sweep or burst mode is turned off.
- *Front-Panel Operation:* You must enable FSK *before* setting up any of the other modulation parameters. Press **Mod** and then select “FSK” using the **Type** softkey. The FSK waveform is output using the present settings for the carrier frequency, output amplitude, and offset voltage.
- *Remote Interface Operation:* To avoid multiple waveform changes, enable FSK *after* you have set up the other modulation parameters.

```
FSKey:STATE {OFF|ON}
```

Carrier Waveform Shape

- FSK carrier shape: **Sine**, Square, Ramp, or Arbitrary waveform. *The default is Sine. You cannot use pulse, noise, or dc as the carrier waveform.*
- *Front-Panel Operation:* Press any of the front-panel function keys except **Pulse** or **Noise**. For arbitrary waveforms, press **Arb** and then choose the **Select Wform** softkey to select the active waveform.
- *Remote Interface Operation:*

```
FUNCTION {SINusoid|SQUare|RAMP|USER}
```

You can also use the **APPLY** command to select the function, frequency, amplitude, and offset with a single command.

FSK Carrier Frequency

The maximum carrier frequency depends on the function selected as shown below. *The default is 1 kHz for all functions.*

Function	Minimum Frequency	Maximum Frequency
Sine	1 μ Hz	20 MHz
Square	1 μ Hz	20 MHz
Ramp	1 μ Hz	200 KHz
Arbs	1 μ Hz	6 MHz

- When the *External* source is selected, the output frequency is determined by the signal level on the rear-panel *Trig In* connector. When a logic *low* level is present, the *carrier* frequency is output. When a logic *high* level is present, the *hop* frequency is output.
- *Front-Panel Operation:* To set the carrier frequency, press the **Freq** softkey for the selected function. Then use the knob or numeric keypad to enter the desired frequency.
- *Remote Interface Operation:*

```
FREQuency {<frequency>|MINimum|MAXimum}
```

You can also use the **APPLY** command to select the function, frequency, amplitude, and offset with a single command.

FSK “Hop” Frequency

The maximum alternate (or “hop”) frequency depends on the function selected as shown below. *The default is 100 Hz for all functions.*

Function	Minimum Frequency	Maximum Frequency
Sine	1 μ Hz	20 MHz
Square	1 μ Hz	20 MHz
Ramp	1 μ Hz	200 kHz
Arbs	1 μ Hz	6 MHz

- The internal modulating waveform is a *square wave* with a 50% duty cycle.
- When the *External* source is selected, the output frequency is determined by the signal level on the rear-panel *Trig In* connector. When a logic *low* level is present, the *carrier* frequency is output. When a logic *high* level is present, the *hop* frequency is output.
- *Front-Panel Operation*: To set the “hop” frequency, press the **Hop Freq** softkey. Then use the knob or numeric keypad to enter the desired frequency.
- *Remote Interface Operation*:

FSKey: FREQuency { <frequency> | MINimum | MAXimum }

FSK Rate

The *FSK rate* is the rate at which the output frequency “shifts” between the carrier frequency and the hop frequency when you select the internal FSK source.

- FSK rate (*internal source*): 2 mHz to 100 kHz. *The default is 10 Hz.*
- The FSK rate is ignored when the external FSK source is selected.
- *Front-Panel Operation*: To set the FSK rate, press the **FSK Rate** softkey. Then use the knob or numeric keypad to enter the desired rate.
- *Remote Interface Operation*:

FSKey: INTernal: RATE { <rate in Hz> | MINimum | MAXimum }

FSK Source

- FSK source: **Internal** or **External**. *The default is Internal.*
- When the *Internal* source is selected, the rate at which the output frequency “shifts” between the carrier frequency and hop frequency is determined by the *FSK rate* specified.
- When the *External* source is selected, the output frequency is determined by the signal level on the rear-panel *Trig In* connector. When a logic *low* level is present, the *carrier* frequency is output. When a logic *high* level is present, the *hop* frequency is output.
- The maximum external FSK rate is 100 kHz.
- Note that the connector used for externally-controlled FSK waveforms (*Trig In*) is not the same connector that is used for externally-modulated AM, FM, PM, and PWM waveforms (*Modulation In*). When used for FSK, the *Trig In* connector *does not* have adjustable edge polarity.
- *Front-Panel Operation*: After enabling FSK, press the **Source** softkey.
- *Remote Interface Operation*:

```
FSKey:SOURce {INTernal|EXTernal}
```

Pulse Width Modulation (PWM)

In Pulse Width Modulation (PWM), the width of a pulse waveform is varied by the instantaneous voltage of the modulating waveform. The width of the pulse can be expressed either as a *pulse width* (expressed in time units, like the period) or a *duty cycle* (expressed as a percentage of the period). The function generator will accept an internal or external modulation source.

For more information on the fundamentals of Pulse Width Modulation, refer to chapter 7, "Tutorial".

To Select PWM Modulation

- The function generator only allows PWM to be selected for a pulse waveform, and PWM is the only modulation type supported for pulse.
- The function generator will not allow PWM to be enabled at the same time that sweep or burst is enabled.
- *Front-Panel Operation:* You must enable PWM *before* setting up any of the other modulation parameters. Press **Pulse** to select pulse, and then press **Mod** to turn on modulation. PWM is selected as the only modulation type supported for pulse. The PWM waveform is output using the present settings for the pulse frequency, modulating frequency, output amplitude, offset voltage, pulse width, and edge time.
- *Remote Interface Operation:* To avoid multiple waveform changes, enable PWM *after* you have set up the other modulation parameters.

```
PWM:STATE {OFF|ON}
```

Chapter 3 Features and Functions

Pulse Width Modulation (PWM)

Pulse Waveform

- Pulse is the only waveform shape supported for PWM.
- *Front-Panel Operation:* Press **Pulse**.
- *Remote Interface Operation:*

```
FUNCTION {PULSe}
```

You can also use the **APPLY** command to select the function, frequency, amplitude, and offset with a single command.

Pulse Period

The range for the pulse period is 200 ns to 2000 s. The default is 1 ms.

- *Front-Panel Operation:* After selecting the pulse function, press the **Freq** softkey again to toggle to the **Period** softkey. Then use the knob or numeric keypad to enter the desired pulse period.
- *Remote Interface Operation:*

```
PULSe:PERiod {<seconds>|MINimum|MAXimum}
```

Modulating Waveform Shape

The function generator will accept an internal or external modulation source for PWM.

- Modulating waveform shape (*internal source*): **Sine**, Square, Ramp, Negative Ramp, Triangle, Noise, or Arb waveform. *The default is Sine.*

- Square has 50% duty cycle.



- Ramp has 100% symmetry.



- Triangle has 50% symmetry.



- Negative ramp has 0% symmetry.



- If you select an arbitrary waveform as the *modulating* waveshape, the waveform is automatically limited to 4K points. Extra waveform points are removed using decimation.
- *Front-Panel Operation*: After enabling PWM, press the **Shape** softkey.
- *Remote Interface Operation*:

```
PWM:INTernal:FUNCTION {SINusoid|SQUare|RAMP|NRAMP|
TRIangle|NOISE|USER}
```

Modulating Waveform Frequency

The function generator will accept an internal or external modulation source for PWM.

- Modulating frequency (*internal source*): 2 mHz to 20 kHz. *The default is 10 Hz.*
- *Front-Panel Operation*: After enabling PWM, press the **PWM Freq** softkey.
- *Remote Interface Operation*:

```
PWM:INTernal:FREQuency {<frequency>|MINimum|MAXimum}
```

Width Deviation

The width deviation represents the variation in width (in seconds) in the modulated waveform from the width of the original pulse waveform.

- Width deviation: 0 s to 1000 s (see below). The default is 10 μ s.
- The width deviation cannot exceed the current pulse width.
- The width deviation is also limited by the minimum pulse width (Wmin):

$$\text{Width Deviation} \leq \text{Pulse Width} - W_{\text{min}}$$

and

$$\text{Width Deviation} \leq \text{Period} - \text{Pulse Width} - W_{\text{min}}$$

where:

$$W_{\text{min}} = 20 \text{ ns for period} \leq 10 \text{ s.}$$

$$W_{\text{min}} = 200 \text{ ns for period} > 10 \text{ s, but} \leq 100 \text{ s.}$$

$$W_{\text{min}} = 2 \mu\text{s for period} > 100 \text{ s, but} \leq 1000 \text{ s.}$$

$$W_{\text{min}} = 20 \mu\text{s for period} > 1000 \text{ s.}$$

- The width deviation is limited by the current edge time setting.

$$\text{Width Deviation} \leq \text{Pulse Width} - (1.6 \times \text{Edge Time})$$

and

$$\text{Width Deviation} \leq \text{Period} - \text{Pulse Width} - (1.6 \times \text{Edge Time})$$

- *Front-Panel Operation:* After enabling PWM, press the **Width Dev** softkey. Then use the knob or numeric keypad to enter the desired deviation.
- *Remote Interface Operation:*

```
PWM:DEVIation {< deviation in seconds> | MINimum | MAXimum}
```

Note: *The pulse width and width deviation, and the pulse duty cycle and duty cycle deviation are coupled in the front panel interface. If you select **Width** for the pulse waveform and enable PWM, the **Width Dev** softkey is available. On the other hand, if you select **Dty Cyc** for the pulse waveform and enable PWM, the **Dty Cyc Dev** softkey is available.*

Duty Cycle Deviation

The duty cycle deviation represents the variation in duty cycle of the modulated waveform from the duty cycle of the pulse waveform. The duty cycle deviation is expressed as a percentage of the period.

- Duty cycle deviation: 0 to 100% (see below). The default is 1%.
- The duty cycle deviation cannot exceed the current pulse duty cycle.
- The duty cycle deviation is also limited by the minimum pulse width (Wmin):

$$\text{Duty Cycle Deviation} \leq \text{Duty Cycle} - 100 \times \text{Wmin} \div \text{Period}$$

and

$$\text{Duty Cycle Deviation} \leq 100 - \text{Duty Cycle} - 100 \times \text{Wmin} \div \text{Period}$$

where:

$$\text{Wmin} = 20 \text{ ns for period} \leq 10 \text{ s.}$$

$$\text{Wmin} = 200 \text{ ns for period} > 10 \text{ s, but} \leq 100 \text{ s.}$$

$$\text{Wmin} = 2 \text{ } \mu\text{s for period} > 100 \text{ s, but} \leq 1000 \text{ s.}$$

$$\text{Wmin} = 20 \text{ } \mu\text{s for period} > 1000 \text{ s.}$$

- The duty cycle deviation is also limited by the current edge time setting.

$$\text{Duty Cycle Dev} \leq \text{Duty Cycle} - (160 \times \text{Edge Time}) \div \text{Period}$$

and

$$\text{Duty Cycle Dev} \leq 100 - \text{Duty Cycle} - (160 \times \text{Edge Time}) \div \text{Period}$$

- *Front-Panel Operation:* After enabling PWM, press the **Dty CyC Dev** softkey. Then use the knob or numeric keypad to enter the desired deviation.
- *Remote Interface Operation:*

```
PWM:Deviation:DCYCLE { < deviation in percent > | MIN | MAX }
```

Note: The pulse width and width deviation, and the pulse duty cycle and duty cycle deviation are coupled in the front panel interface. If you select **Width** for the pulse waveform and enable PWM, the **Width Dev** softkey is available. On the other hand, if you select **Dty CyC** for the pulse waveform and enable PWM, the **Dty CyC Dev** softkey is available.

Modulating Source

The function generator will accept an internal or external modulation source for PWM.

- Modulating source: **Internal** or External. *The default is Internal.*
- If you select the *External* source, the pulse waveform is modulated with an external waveform. The width deviation or duty cycle deviation is controlled by the $\pm 5V$ signal level present on the rear-panel *Modulation In* connector. For example, if you have set the duty cycle to 10% and the duty cycle deviation to 5%, then when the modulating signal is at +5 volts, the output will be at the *maximum* duty cycle (15%). When the modulating signal is at -5 volts, the output will be at the *minimum* duty cycle (5%).

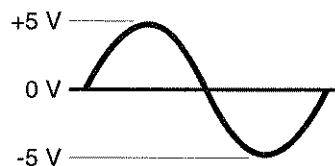
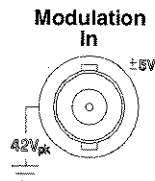

- *Front-Panel Operation:* After enabling PWM, press the **Source** softkey.
- *Remote Interface Operation:*

```
PWM:SOURce {INTernal|EXTernal}
```

Frequency Sweep

In the frequency sweep mode, the function generator “steps” from the *start frequency* to the *stop frequency* at a *sweep rate* which you specify. You can sweep up or down in frequency, and with either linear or logarithmic spacing. You can also configure the function generator to output a single sweep (one pass from start frequency to stop frequency) by applying an external or manual trigger. The function generator can produce a frequency sweep for sine, square, ramp, or arbitrary waveforms (pulse, noise, and dc are not allowed).

For more information on the fundamentals of a sweep, refer to chapter 7, “Tutorial”.

3

To Select Sweep

- The function generator will not allow the sweep mode to be enabled at the same time that burst or any modulation mode is enabled. When you enable sweep, the burst or modulation mode is turned off.
- *Front-Panel Operation:* You must enable sweep *before* setting up any of the other sweep parameters. Press **Sweep** to output a sweep using the present settings for frequency, output amplitude, and offset.
- *Remote Interface Operation:* To avoid multiple waveform changes, enable the sweep mode *after* you have set up the other parameters.

SWEep:STATE {OFF|ON}

Start Frequency and Stop Frequency

The *start frequency* and *stop frequency* set the upper and lower frequency bounds for the sweep. The function generator begins at the start frequency, sweeps to the stop frequency, and then resets back to the start frequency.

- Start and Stop frequencies: 1 μ Hz to 20 MHz (limited to 200 kHz for ramps and 6 MHz for arbitrary waveforms). The sweep is phase continuous over the full frequency range. *The default start frequency is 100 Hz. The default stop frequency is 1 kHz.*
- To sweep **up** in frequency, set the start frequency < stop frequency. To sweep **down** in frequency, set the start frequency > stop frequency.
- For sweeps with *Marker Off*, the Sync signal is a square waveform with a 50% duty cycle. The Sync signal is a TTL “high” at the beginning of the sweep and goes “low” at the midpoint of the sweep. The frequency of the sync waveform is equal to the specified sweep time. The signal is output from the front-panel *Sync* connector.
- For sweeps with *Marker On*, the Sync signal is a TTL “high” at the beginning of the sweep and goes “low” at the marker frequency. The signal is output from the front-panel *Sync* connector.
- *Front-Panel Operation:* After enabling sweeps, press the **Start** or **Stop** softkey. Then use the knob or numeric keypad to enter the desired frequency.
- *Remote Interface Operation:*

```
FREQUENCY:START {<frequency>|MINimum|MAXimum}  
FREQUENCY:STOP {<frequency>|MINimum|MAXimum}
```

Center Frequency and Frequency Span

If desired, you can set the frequency boundaries of the sweep using a *center frequency* and *frequency span*. These parameters are similar to the start frequency and stop frequency (*see the previous page*) and are included to give you added flexibility.

- Center frequency: 1 μ Hz to 20 MHz (limited to 200 kHz for ramps and 6 MHz for arbitrary waveforms). *The default is 550 Hz.*
- Frequency span: 0 Hz to 20 MHz (limited to 200 kHz for ramps and 6 MHz for arbitrary waveforms). *The default is 900 Hz.*
- To sweep **up** in frequency, set a *positive* frequency span. To sweep **down** in frequency, set a *negative* frequency span.
- For sweeps with *Marker Off*, the Sync signal is a square waveform with a 50% duty cycle. The Sync signal is a TTL “high” at the beginning of the sweep and goes “low” at the midpoint of the sweep. The frequency of the sync waveform is equal to the specified sweep time. The signal is output from the front-panel *Sync* connector.
- For sweeps with *Marker On*, the Sync signal is a TTL “high” at the beginning of the sweep and goes “low” at the marker frequency. The signal is output from the front-panel *Sync* connector.
- *Front-Panel Operation:* After enabling sweeps, press the **Start** or **Stop** softkey again to toggle to the **Center** or **Span** softkey. Then use the knob or numeric keypad to enter the desired values.
- *Remote Interface Operation:*

```
FREQUENCY:CENTER {<frequency>|MINimum|MAXimum}  
FREQUENCY:SPAN {<frequency>|MINimum|MAXimum}
```

Frequency Sweep

Sweep Mode

You can sweep with either linear or logarithmic spacing. For a *linear* sweep, the function generator varies the output frequency in a linear fashion during the sweep. For a *logarithmic* sweep, the function generator varies the output frequency in a logarithmic fashion.

- Sweep mode: Linear or Logarithmic. *The default is Linear.*
- *Front-Panel Operation:* After enabling sweeps, press the **Linear** softkey again to toggle between the linear or log mode.
- *Remote Interface Operation:*

```
SWEep:SPACing {LINEar|LOGarithmic}
```

Sweep Time

The *sweep time* specifies the number of seconds required to sweep from the start frequency to the stop frequency. The number of discrete frequency points in the sweep is automatically calculated by the function generator and is based on the sweep time you select.

- Sweep time: 1 ms to 500 seconds. *The default is 1 second.*
- *Front-Panel Operation:* After enabling sweeps, press the **Sweep Time** softkey. Then use the knob or numeric keypad to enter the desired sweep time.
- *Remote Interface Operation:*

```
SWEep:TIME {<seconds>|MINimum|MAXimum}
```

Marker Frequency

If desired, you can set the frequency at which the signal on the front-panel *Sync* connector goes to a logic low during the sweep. The Sync signal always goes from low to high at the beginning of the sweep.

- Marker frequency: 1 μ Hz to 20 MHz (limited to 200 kHz for ramps and 6 MHz for arbitrary waveforms). *The default is 500 Hz.*
- When the sweep mode is enabled, the marker frequency *must* be between the specified start frequency and stop frequency. If you attempt to set the marker frequency to a frequency not in this range, the function generator will automatically set the marker frequency equal to the start frequency or stop frequency (whichever is closer).
- The Sync enable setting is overridden by enabling the marker used with the sweep mode (*see page 68*). Therefore, when the marker is enabled (and the sweep mode is also enabled), the Sync setting is ignored.
- *Front-Panel Operation:* After enabling sweeps, press the **Marker** softkey. Then use the knob or numeric keypad to enter the desired marker frequency.
- *Remote Interface Operation:*

```
MARKer:FREquency {<frequency>|MINimum|MAXimum}  
MARKer {Off|On}
```

Sweep Trigger Source

In the sweep mode, the function generator outputs a single sweep when a trigger signal is received. After one sweep from the start frequency to the stop frequency, the function generator waits for the next trigger while outputting the start frequency.

- Sweep trigger source: **Internal**, External, or Manual. *The default is Internal.*
- When the *Internal* (immediate) source is selected, the function generator outputs a continuous sweep at a rate determined by the *sweep time* specified.
- When the *External* source is selected, the function generator will accept a hardware trigger applied to the rear-panel *Trig In* connector. The function generator initiates one sweep each time *Trig In* receives a TTL pulse with the specified polarity.
- The trigger period must be greater than or equal to the specified sweep time **plus** 1 ms.
- When the *Manual* source is selected, the function generator outputs one sweep each time the front-panel  key is pressed.
- *Front-Panel Operation:* Press the **Trigger Setup** softkey and then select the desired source by pressing the **Source** softkey.

To specify whether the function generator triggers on the rising or falling edge of the *Trig In* connector, press the **Trigger Setup** softkey. Then select the desired edge by pressing the **Slope** softkey.

- *Remote Interface Operation:*

```
TRIGger:SOURce {IMMediate|EXTernal|BUS}
```

Use the following command to specify whether the function generator triggers on the rising or falling edge of the signal on the *Trig In* connector.

```
TRIGger:SLOPe {POSitive|NEGative}
```

See “Triggering” on page 115 for more information.

Trigger Out Signal

A “trigger out” signal is provided on the rear-panel *Trig Out* connector (*used with sweep and burst* only). When enabled, a TTL-compatible square waveform with either a rising edge (default) or falling edge is output from the *Trig Out* connector at the beginning of the sweep.

- When the *Internal* (immediate) trigger source is selected, the function generator outputs a square waveform with a 50% duty cycle from the *Trig Out* connector at the beginning of the sweep. The frequency of the waveform is equal to the specified *sweep time*.
- When the *External* trigger source is selected, the function generator automatically disables the “trigger out” signal. The *Trig Out* connector cannot be used for both operations at the same time (an externally-triggered waveform uses the same connector to trigger the sweep).
- When the *Manual* trigger source is selected, the function generator outputs a pulse (>1 μ s pulse width) from the *Trig Out* connector at the beginning of each sweep or burst.
- *Front-Panel Operation:* After enabling sweeps, press the **Trigger Setup** softkey. Then select the desired edge by pressing the **Trig Out** softkey.
- *Remote Interface Operation:*

```
OUTPut:TRIGger:SLOPe {POSitive|NEGative}  
OUTPut:TRIGger {OFF|ON}
```

Burst Mode

You can configure the function generator to output a waveform with a specified number of cycles, called a *burst*. The function generator can produce a burst using sine, square, ramp, pulse, or arbitrary waveforms (noise is allowed only in the gated burst mode and dc is not allowed).

For more information on the fundamentals of the burst mode, refer to chapter 7, "Tutorial".

To Select Burst

- The function generator will not allow burst to be enabled at the same time that sweep or any modulation mode is enabled. When you enable burst, the sweep or modulation mode is turned off.
- *Front-Panel Operation:* You must enable burst *before* setting up any of the other burst parameters. Press  to output a burst using the present settings for frequency, output amplitude, and offset voltage.
- *Remote Interface Operation:* To avoid multiple waveform changes, enable the burst mode *after* you have set up the other parameters.

```
BURSt:STATE {OFF|ON}
```

Burst Type

You can use burst in one of two modes as described below. The function generator enables one burst mode at a time based on the *trigger source* and *burst source* that you select (see the table below).

- **Triggered Burst Mode:** In this mode (default), the function generator outputs a waveform with a specified number of cycles (*burst count*) each time a trigger is received. After the specified number of cycles have been output, the function generator stops and waits for the next trigger. You can configure the function generator to use an internal trigger to initiate the burst or you can provide an external trigger by pressing the front-panel **Trigger** key, applying a trigger signal to the rear-panel *Trig In* connector, or sending a software trigger command from the remote interface.
- **External Gated Burst Mode:** In this mode, the output waveform is either “on” or “off” based on the level of the external signal applied to the rear-panel *Trig In* connector. When the gate signal is *true*, the function generator outputs a continuous waveform. When the gate signal goes *false*, the current waveform cycle is completed and then the function generator stops while remaining at the voltage level corresponding to the starting burst phase of the selected waveform. For a noise waveform, the output stops immediately when the gate signal goes false.

	Burst Mode (BURS:MODE)	Burst Count (BURS:NCYC)	Burst Period (BURS:INT:PER)	Burst Phase (BURS:PHAS)	Trigger Source (TRIG:SOUR)
Triggered Burst Mode: Internal Trigger	TRIGgered	Available	Available	Available	IMMediate
Triggered Burst Mode: External Trigger	TRIGgered	Available	Not Used	Available	EXternal, BUS
Gated Burst Mode: External Trigger	GATed	Not Used	Not Used	Available	Not Used

Burst Mode

- When the *gated* mode is selected, the burst count, burst period, and trigger source are ignored (these parameters are used for the triggered burst mode only). If a manual trigger is received, it is ignored and no error will be generated.
- When the *gated* mode is selected, you can also select the polarity of the signal on the rear-panel *Trig In* connector.
- *Front-Panel Operation:* After enabling bursts, press the **N Cycle** (triggered) or **Gated** softkey.

To select the polarity of the external gate signal on the *Trig In* connector, press the **Polarity** softkey. The default polarity is POS (true-high logic).

- *Remote Interface Operation:*

```
BURSt:MODE {TRIGgered|GATed}
```

Use the following command to select the polarity of the external gate signal on the *Trig In* connector. The default is NORM (true-high logic).

```
BURSt:GATE:POLarity {NORMal|INVerted}
```

Waveform Frequency

The *waveform frequency* defines the repetition rate of the burst waveform in the triggered and external gated modes. In the *triggered mode*, the number of cycles specified by the *burst count* is output at the waveform frequency. In the *external gated mode*, the waveform frequency is output when the external gate signal is true.

Keep in mind that the waveform frequency is different than the “burst period” which specifies the interval between bursts (triggered mode only).

- Waveform frequency: 1 μ Hz to 20 MHz (limited to 200 kHz for ramps and 6 MHz for arbitrary waveforms). *The default waveform frequency is 1 kHz. (For an internally triggered burst waveform, the minimum frequency is 2 mHz.)* You can select a sine, square, ramp, pulse, or arbitrary waveform (noise is allowed only in the gated burst mode and dc is not allowed).
- For sine and square waveforms, frequencies above 6 MHz are allowed only with an “infinite” burst count.
- *Front-Panel Operation:* To set the waveform frequency, press the **Freq** softkey for the selected function. Then use the knob or numeric keypad to enter the desired frequency.
- *Remote Interface Operation:*

```
FREQuency { <frequency> | MINimum | MAXimum }
```

You can also use the APPLY command to select the function, frequency, amplitude, and offset with a single command.

Burst Mode

Burst Count

The burst count defines the number of cycles to be output per burst.
Used in the triggered burst mode only (internal or external source).

- Burst count: 1 to 50,000 cycles, in 1 cycle increments. You can also select an infinite burst count. *The default is 1 cycle.*
- When the *Internal* trigger source is selected, the specified number of cycles is output continuously at a rate determined by the *burst period* setting. The burst period defines the interval between bursts.
- When the *Internal* trigger source is selected, the burst count must be less than the product of the burst period and the waveform frequency as shown below.

$$\text{Burst Count} < \text{Burst Period} \times \text{Waveform Frequency}$$

- The function generator will automatically increase the burst period up to its maximum value to accommodate the specified burst count (but the waveform frequency *will not* be changed).
- When the *gated* burst mode is selected, the burst count is ignored. However, if you change the burst count from the remote interface while in the gated mode, the function generator remembers the new count and will use it when the triggered mode is selected.
- *Front-Panel Operation:* To set the burst count, press the **#Cycles** softkey and then use the knob or numeric keypad to enter the count. To select an infinite count burst instead, press the **#Cycles** softkey again to toggle to the **Infinite** softkey (press  once to start the waveform, and a second time to stop it).
- *Remote Interface Operation:*

```
BURSt:NCYCles {<# cycles>|INFIinity|MINimum|MAXimum}
```

Burst Period

The *burst period* defines time from the start of one burst to the start of the next burst. *Used in the internal triggered burst mode only.*

Keep in mind that burst period is different than the “waveform frequency” which specifies the frequency of the bursted signal.

- Burst period: 1 μ s to 500 seconds. *The default is 10 ms.*
- The burst period setting is used only when *Internal* triggering is enabled. The burst period is ignored when manual or external triggering is enabled (or when the *gated* burst mode is selected).
- It *is not* possible to specify a burst period which is too short for the function generator to output with the specified burst count and frequency (*see below*). If the burst period is too short, the function generator will automatically adjust it as needed to continuously re-trigger the burst.

$$\text{Burst Period} > \frac{\text{Burst Count}}{\text{Waveform Frequency}} + 200 \text{ ns}$$

- *Front-Panel Operation:* To set the burst period, press the **Burst Period** softkey and then use the knob or numeric keypad to enter the period.
- *Remote Interface Operation:*

```
BURSt:INTernal:PERiod {<seconds>|MINimum|MAXimum}
```

Burst Mode

Burst Phase

The *burst phase* defines the starting phase of the burst.

- Burst phase: -360 degrees to +360 degrees. *The default is 0 degrees.*
- From the remote interface, you can set the starting phase in degrees or radians using the `UNIT:ANGL` command (see page 221).
- From the front panel, the starting phase is always displayed in degrees (radians are not available). If you set the starting phase in radians from the remote interface and then return to front-panel operation, you will see that the function generator converts the phase to degrees.
- For sine, square, and ramp waveforms, 0 degrees is the point at which the waveform crosses zero volts (or the dc offset value) in a positive-going direction. For arbitrary waveforms, 0 degrees is the first waveform point downloaded to memory. The burst phase has no effect on pulse or noise waveforms.
- The burst phase is also used in the *gated* burst mode. When the gate signal goes *false*, the current waveform cycle is completed and then the function generator stops. The output will remain at the voltage level corresponding to the starting burst phase.
- *Front-Panel Operation:* To set the burst phase, press the **Start Phase** softkey and then use the knob or numeric keypad to enter the desired phase in degrees.
- *Remote Interface Operation:*

```
BURSt:PHASe {<angle>|MINimum|MAXimum}
```

Burst Trigger Source

In the *triggered* burst mode, the function generator outputs a burst with the specified number of cycles (*burst count*) each time a trigger is received. After the specified number of cycles have been output, the function generator stops and waits for the next trigger. *At power-on, the internally-triggered burst mode is enabled.*

- Burst trigger source: **Internal**, External, or Manual. *The default is Internal.*
- When the *Internal* (immediate) source is selected, the frequency at which the burst is generated is determined by the *burst period*.
- When the *External* source is selected, the function generator will accept a hardware trigger applied to the rear-panel *Trig In* connector. The function generator outputs the specified number of cycles each time *Trig In* receives a TTL pulse with the specified polarity. External trigger signals that occur during a burst are ignored.
- When the *Manual* source is selected, the function generator outputs one burst each time the front-panel  key is pressed.
- When the *External* or *Manual* trigger source is selected, the *burst count* and *burst phase* remain in effect but the *burst period* is ignored.
- *Front-Panel Operation:* Press the **Trigger Setup** softkey and then select the desired source by pressing the **Source** softkey.

To specify whether the function generator triggers on the rising or falling edge of the signal on the *Trig In* connector, press the **Trigger Setup** softkey. Then select the desired edge by pressing the **Slope** softkey.

Burst Mode

- *Remote Interface Operation:*

```
TRIGger:SOURce {IMMediate|EXTernal|BUS}
```

Use the following command to specify whether the function generator triggers on the rising or falling edge of the *Trig In* connector.

```
TRIGger:SLOPe {POSitive|NEGative}
```

See “Triggering” on page 115 for more information on triggering.

Trigger Out Signal



A “trigger out” signal is provided on the rear-panel *Trig Out* connector (*used with burst and sweep only*). When enabled, a TTL-compatible pulse waveform with either a rising edge (default) or falling edge is output from the *Trig Out* connector at the beginning of the burst.

- When the *Internal* (immediate) trigger source is selected the function generator outputs a square waveform with a 50% duty cycle from the *Trig Out* connector at the beginning of the burst. The frequency of the waveform is equal to the specified *burst period*.
- When the *External* trigger source is selected, the function generator automatically disables the “trigger out” signal. The *Trig Out* connector cannot be used for both operations at the same time (an externally-triggered waveform uses the same connector to trigger the burst).
- When the *Manual* trigger source is selected, the function generator outputs a pulse (>1 μ s pulse width) from the *Trig Out* connector at the beginning of each burst.
- *Front-Panel Operation:* After enabling bursts, press the **Trigger Setup** softkey. Then select the desired edge by pressing the **Trig Out** softkey.
- *Remote Interface Operation:*

```
OUTPut:TRIGger:SLOPe {POSitive|NEGative}  
OUTPut:TRIGger {OFF|ON}
```

Triggering

Applies to sweep and burst only. You can issue triggers for sweeps or bursts using *internal* triggering, *external* triggering, or *manual* triggering.

- Internal or “automatic” triggering is enabled when you turn on the function generator. In this mode, the function generator outputs continuously when the sweep or burst mode is selected.
- External triggering uses the rear-panel *Trig In* connector to control the sweep or burst. The function generator initiates one sweep or outputs one burst each time *Trig In* receives a TTL pulse. You can select whether the function generator triggers on the rising or falling edge of the external trigger signal.
- Manual triggering initiates one sweep or outputs one burst each time you press  from the front-panel. Continue pressing this key to re-trigger the function generator.
- The  key is disabled when in remote and when a function other than burst or sweep is currently selected.

Trigger Source Choices

Applies to sweep and burst only. You must specify the source from which the function generator will accept a trigger.

- Sweep trigger source: **Internal**, External, or Manual. *The default is Internal.*
- The function generator will accept a manual trigger, a hardware trigger from the rear-panel *Trig In* connector, or continuously output sweeps or bursts using an internal trigger. *At power-on, internal trigger is selected.*

Triggering

- The trigger source setting is stored in *volatile* memory; the source is set to internal trigger (front panel) or immediate (remote interface) when power has been off or after a remote interface reset. (Provided that the Power On state is set to Default.)
- *Front-Panel Operation:* After enabling sweeps or bursts, press the **Trigger Setup** softkey. Then select the desired source by pressing the **Source** softkey.
- *Remote Interface Operation:*

```
TRIGger:SOURce {IMMediate|EXTernal|BUS}
```

The APPLY command automatically sets the source to *Immediate*.

Internal Triggering In the internal trigger mode, the function generator continuously outputs the sweep or burst (as specified by the *sweep time* or *burst period*). This is the default trigger source for both front-panel and remote interface use.

- *Front-Panel Operation:* Press the **Trigger Setup** softkey and then select the **Source Int** softkey.
- *Remote Interface Operation:*

```
TRIGger:SOURce IMMEDIATE
```

Manual Triggering In the manual trigger mode (front panel only), you can manually trigger the function generator by pressing the front-panel **Trigger** key. The function generator initiates one sweep or outputs one burst for each time you press the key. The **Trigger** key is illuminated while the function generator is waiting for a manual trigger (the key is disabled when in remote).

External Triggering In the external trigger mode, the function generator will accept a hardware trigger applied to the rear-panel *Trig In* connector. The function generator initiates one sweep or outputs one burst each time *Trig In* receives a TTL pulse with the specified edge.

See also “Trigger Input Signal,” on the following page.

- **Front-Panel Operation:** The external trigger mode is like the manual trigger mode except that you apply the trigger to the *Trig In* connector. To select the external source, press the **Trigger Setup** softkey and then select the **Source Ext** softkey.

To specify whether the function generator triggers on the rising or falling edge, press the **Trigger Setup** softkey and then select the desired edge by pressing the **Slope** softkey.

- **Remote Interface Operation:**

```
TRIGger:SOURce EXTernal
```

Use the following command to specify whether the function generator triggers on the rising or falling edge.

```
TRIGger:SLOPe {POSitive|NEGative}
```

Software (Bus) Triggering The bus trigger mode is available only from the remote interface. This mode is similar to the manual trigger mode from the front panel, but you trigger the function generator by sending a bus trigger command. The function generator initiates one sweep or outputs one burst each time a bus trigger command is received.

- To select the bus trigger source, send the following command.

```
TRIGger:SOURce BUS
```

- To trigger the function generator from the remote interface (GPIB, USB, or LAN) when the *Bus* source selected, send the TRIG or *TRG (trigger) command. The front-panel  key is illuminated when the function generator is waiting for a bus trigger.

Trigger Input Signal

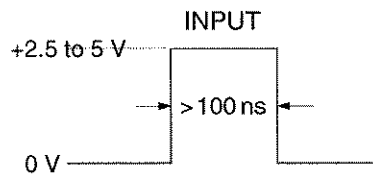
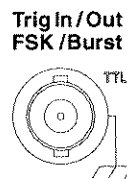

Rising edge shown.

This rear-panel connector is used in the following modes:

- *Triggered Sweep Mode:* To select the external source, press the **Trigger Setup** softkey and then select the **Source Ext** softkey or execute the `TRIG:SOUR EXT` command from the remote interface (sweep must be enabled). When the rising or falling edge (you specify which edge) of a TTL pulse is received on the *Trig In* connector, the function generator outputs a single sweep.
- *Externally-Modulated FSK Mode:* To enable the externally-modulated mode, press the **Source** softkey from the front-panel or execute the `FSK:SOUR EXT` command from the remote interface (FSK must be enabled). When a logic *low* level is present, the *carrier* frequency is output. When a logic *high* level is present, the *hop* frequency is output. The maximum external FSK rate is 100 kHz.
- *Triggered Burst Mode:* To select the external source, press the **Trigger Setup** softkey and then select the **Source Ext** softkey or execute the `TRIG:SOUR EXT` command from the remote interface (burst must be enabled). The function generator outputs a waveform with a specified number of cycles (*burst count*) each time a trigger is received from the specified trigger source.
- *External Gated Burst Mode:* To enable the gated mode, press the **Gated** softkey or execute the `BURS:MODE GAT` command from the remote interface (burst must be enabled). When the external gate signal is *true*, the function generator outputs a continuous waveform. When the external gate signal goes *false*, the current waveform cycle is completed and then the function generator stops while remaining at the voltage level corresponding to the starting burst phase. For noise, the output stops immediately when the gate signal goes false.

Trigger Output Signal

A “trigger out” signal is provided on the rear-panel *Trig Out* connector (used with sweep and burst only). When enabled, a TTL-compatible square waveform with either a rising edge (default) or falling edge is output from the rear-panel *Trig Out* connector at the beginning of the sweep or burst.

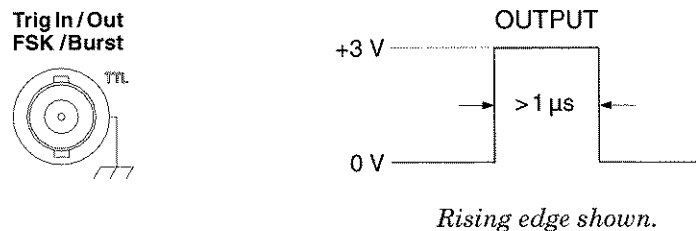

3

- When the *Internal* (immediate) trigger source is selected, the function generator outputs a square waveform with a 50% duty cycle from the *Trig Out* connector at the beginning of the sweep or burst. The period of the waveform is equal to the specified *sweep time* or *burst period*.
- When the *External* trigger source is selected, the function generator automatically disables the “trigger out” signal. The *Trig Out* connector cannot be used for both operations at the same time (an externally-triggered waveform uses the same connector to trigger the sweep or burst).
- When the *Bus* (software) or manual trigger source is selected, the function generator outputs a pulse ($> 1 \mu\text{s}$ pulse width) from the *Trig Out* connector at the beginning of each sweep or burst.
- *Front-Panel Operation:* After enabling sweeps or burst, press the **Trigger Setup** softkey. Then select the desired edge by pressing the **Trig Out** softkey.
- *Remote Interface Operation:*

```
OUTPut:TRIGger:SLOPe {POSitive|NEGative}  
OUTPut:TRIGger {OFF|ON}
```

Arbitrary Waveforms

There are five built-in arbitrary waveforms stored in non-volatile memory. You can also store up to four user-defined waveforms in non-volatile memory in addition to one in volatile memory. Each waveform can contain between 1 (a dc voltage) and 65,536 (64K) data points.

You can create an arbitrary waveform from the front panel as described in the following section, or you can use the Agilent IntuiLink software provided on the CD-ROM included with the Agilent 33220A. The Agilent IntuiLink software allows you to create arbitrary waveforms using a graphical user interface on your PC, and then download them into the Agilent 33220A. You can also capture waveforms from your Agilent oscilloscope and import them into IntuiLink. Please see the online help included with the Agilent IntuiLink software for further information.

Refer to chapter 7, "Tutorial", for more information on the internal operation of downloading and outputting an arbitrary waveform.

To Create and Store an Arbitrary Waveform

This section gives an example which shows you how to create and store an arbitrary waveform from the front panel. To download an arbitrary waveform from the remote interface, see "Arbitrary Waveform Commands" starting on page 227. For this example, you will create and store the ramp waveform shown below using four waveform points.

Volt/Div = 1 Volt
Time/Div = 1 ms

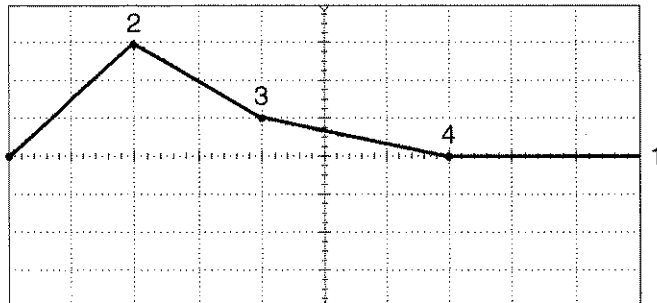

1 Select the arbitrary waveform function.

When you press **Arb** to select the arbitrary function, a temporary message is displayed indicating which waveform is currently selected.

2 Start the arbitrary waveform editor.

Press the **Create New** softkey to start the waveform editor. While in the waveform editor, you define the waveform by specifying time and voltage values for each point in the waveform. When creating a new waveform, the previous waveform in volatile memory is overwritten.

3 Set the waveform period.

Press the **Cycle Period** softkey to set the *time* boundaries for the waveform. The time value of the last point that can be defined in the waveform must be *less* than the specified cycle period.

For this example, set the period of the waveform to 10 ms.



4 Set the waveform voltage limits.

Press the **High V Limit** and **Low V Limit** softkeys to set the upper and lower voltage levels that can be reached while editing the waveform. The upper limit *must* be greater than the lower limit. By default, Point #1 is set equal to the upper limit and Point #2 is set equal to the lower limit.

For this example, set the upper limit to 3.0 V and the lower limit to 0 V.



Arbitrary Waveforms

5 Select the interpolation method.

Press the **Interp** softkey to enable or disable linear interpolation between waveform points (this feature is available from the front panel only). With interpolation enabled (default), the waveform editor makes a straight-line connection between points. With interpolation disabled, the waveform editor maintains a constant voltage level between points and creates a “step-like” waveform.

For this example, turn on linear interpolation.

6 Set the initial number of waveform points.

You can create an arbitrary waveform with up to 65,536 (64K) points. The waveform editor initially builds a waveform with two points and automatically connects the last point of the waveform to the voltage level of the first point to create a continuous waveform. Press the **Init # Points** softkey to specify the initial number of waveform points (you can add or remove points later if necessary).

For this example, set the initial number of points to “4”.

7 Start the point-by-point editing process.

Press the **Edit Points** softkey to accept the initial waveform settings and begin point-by-point editing. The status line at the top of the display window shows the point number at the *left*, the time value of the current point in the *center*, and the voltage value of the current point to the *right*.

8 Define the first waveform point.

Press the **Voltage** softkey to set the voltage level for Point #1 (this point is fixed at a time of 0 seconds). By default, Point #1 is set equal to the upper limit.

For this example, set the voltage level of Point #1 to 0 V.

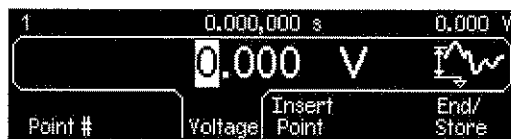

9 Define the next waveform point.

Press the **Point #** softkey and then turn the knob to move to Point #2. Press the **Time** softkey to set the time for the current point (this softkey is not available for Point #1). Press the **Voltage** softkey to set the voltage level for the current point.

For this example, set the time to 2 ms and the voltage level to 3.0 V.

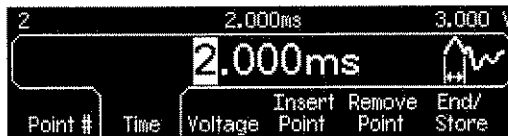

10 Define the remaining waveform points.

Using the **Time** and **Voltage** softkeys, define the remaining waveform points using the values shown in the table below.

Point	Time Value	Voltage Value
1	0 s	0 V
2	2 ms	3 V
3	4 ms	1 V
4	7 ms	0 V

- The time value of the last point that can be defined in the waveform must be *less* than the specified cycle period.
- The waveform editor automatically connects the last waveform point to the voltage level of first point to create a continuous waveform.
- To insert additional points after the current waveform point, press the **Insert Point** softkey. The new point is inserted midway between the current point and the next defined point.
- To remove the current waveform point, press the **Remove Point** softkey. The remaining points are joined using the interpolation method currently selected. You cannot remove Point #1 since the waveform must have a defined initial value.

11 Store the arbitrary waveform in memory.

Press the **End/Store** softkey to store the new waveform in memory. Then press the **DONE** softkey to store the waveform in *volatile* memory **or** press the **Store in Non-Vol** softkey to store the waveform in one of four *non-volatile* memory locations.

You can assign a custom name to the four non-volatile memory locations.

- The custom name can contain up to 12 characters. The first character must be a letter but the remaining characters can be letters, numbers, or the underscore character (“_”).
- To add additional characters, press the right-cursor key until the cursor is to the right of the existing name and then turn the knob.
- To delete all characters to the right of the cursor, press the **+/-** key.

*For this example, assign the name “RAMP_NEW” to memory location 1 and then press the **STORE ARB** softkey to store the waveform.*



The waveform is now stored in non-volatile memory and is currently being output from the function generator. The name that you used to store the waveform should now appear in the list of stored waveforms (under the **Stored Wform** softkey).

Additional Information on Arbitrary Waveforms

- As a shortcut to determine which arbitrary waveform is selected, press **Arb**. A temporary message is displayed on the front panel.
- In addition to creating a new arbitrary waveform from the front panel, you can also edit any existing user-defined waveforms. You can edit waveforms that were created either from the front panel or from the remote interface. However, you cannot edit any of the five built-in arbitrary waveforms.
- Press the **Edit Wform** softkey to edit any of the arbitrary waveforms stored in non-volatile memory or the waveform currently stored in volatile memory. While editing an existing waveform, please note the following interactions.
 - If you *increase* the cycle period, some points could potentially match existing points. The waveform editor will preserve the earliest points and remove all duplicates.
 - If you *decrease* the cycle period, the waveform editor will remove all points that were previously defined beyond the new period.
 - If you *increase* the voltage limits, there will be no change in the voltage levels of any existing points but there may be some loss of vertical resolution.
 - If you *decrease* the voltage limits, some of the existing points could potentially exceed the new limits. The waveform editor will reduce the voltage levels of such points to equal the new limits.
- If you select an arbitrary waveform as the *modulating* waveshape for AM, FM, PM, or PWM, the waveform is automatically limited to 4K points. Extra waveform points are removed using decimation.

System-Related Operations

This section gives information on topics such as instrument state storage, power-down recall, error conditions, self test, and front-panel display control. This information is not directly related to waveform generation but is an important part of operating the function generator.

Instrument State Storage

The function generator has five storage locations in non-volatile memory to store instrument states. The locations are numbered 0 through 4. The function generator automatically uses location “0” to hold the state of the instrument at power down. You can also assign a user-defined name to each of the locations (1 through 4) for use from the front panel.



- You can store the instrument state in any of the five storage locations. However, you can only recall a state from a location that contains a previously-stored state.
- From the *remote interface* only, you can use storage location “0” to store a fifth instrument state (you cannot store to this location from the front panel). However, note that location “0” is automatically overwritten when power is cycled (the instrument state previously stored will be overwritten).
- The state storage feature “remembers” the selected function (including arbitrary waveforms), frequency, amplitude, dc offset, duty cycle, symmetry, as well as any modulation parameters in use.
- When shipped from the factory, storage locations “1” through “4” are empty (location “0” contains the power-down state).
- When power is turned off, the function generator automatically stores its state in storage location “0”. You can configure the function generator to automatically recall the power-down state when power is restored. However, when shipped from the factory, the function generator is configured to automatically recall the factory default state at power-on.

- You can assign a custom name to each of the storage locations (however, you cannot name location “0” from the front panel). You can name a location from the front panel or over the remote interface, but you can only recall a state by name from the front panel. From the remote interface, you can only recall a stored state using a number (0 through 4).
- The name can contain up to 12 characters. The first character *must* be a letter (A-Z), but the remaining characters can be letters, numbers (0-9), or the underscore character (“_”). Blank spaces are not allowed. An error will be generated if you specify a name with more than 12 characters.
- The function generator *will not* prevent you from assigning the *same* custom name to different storage locations. For example, you can assign the same name to locations “1” and “2”.
- If you delete an arbitrary waveform from non-volatile memory after storing the instrument state, the waveform data is lost and the function generator *will not* output the waveform when the state is recalled. The built-in “exponential rise” waveform is output in place of the deleted waveform.
- The front-panel display state (see “Display Control” on page 132) is saved when you store the instrument state. When you recall the state, the front-panel display will return to the previous state.
- An instrument reset *does not* affect the configurations stored in memory. Once a state is stored, it remains until it is overwritten or specifically deleted.

Chapter 3 Features and Functions

System-Related Operations

- *Front-Panel Operation:* Press  and then select the **Store State** or **Recall State** softkey. To delete a stored state, select the **Delete State** softkey (also removes the custom name for this memory location).

To configure the function generator to recall the factory default state at power-on, press  and then select the **Pwr-On Default** softkey. To configure the function generator to recall the power-down state when power is restored, press  and select the **Pwr-On Last** softkey.

You can assign a custom name to each of the four storage locations.

- The custom name can contain up to 12 characters. The first character must be a letter but the remaining characters can be letters, numbers, or the underscore character (“_”).
 - To add additional characters, press the right-cursor key until the cursor is to the right of the existing name and then turn the knob.
 - To delete all characters to the right of the cursor, press the  key.
- *Remote Interface Operation:*

*SAV {0|1|2|3|4} *State 0 is the instrument state at power down.*
*RCL {0|1|2|3|4} *States 1, 2, 3, and 4 are user-defined states.*

To assign a custom name to a stored state to be recalled from the front panel, send the following command. From the remote interface, you can only recall a stored state using a number (0 through 4).

```
MEM:STATE:NAME 1,TEST_WFORM_1
```

To configure the function generator to automatically recall the power-down state when power is restored, send the following command.

```
MEMory:STATE:RECall:AUTO ON
```

Error Conditions

A record of up to 20 command syntax or hardware errors can be stored in the function generator's error queue. *See chapter 5 for a complete listing of the errors.*

- Errors are retrieved in first-in-first-out (FIFO) order. The first error returned is the first error that was stored. Errors are cleared as you read them. The function generator beeps once each time an error is generated (unless you have disabled the beeper).
- If more than 20 errors have occurred, the last error stored in the queue (the most recent error) is replaced with "Queue overflow". No additional errors are stored until you remove errors from the queue. If no errors have occurred when you read the error queue, the function generator responds with "No error".
- The error queue is cleared by the *CLS (clear status) command or when the power is cycled. The errors are also cleared when you read the error queue. The error queue *is not* cleared by an instrument reset (*RST command).
- *Front-Panel Operation:* Press  and then select the topic entitled "View the remote command error queue" (topic number 2). Then press the **SELECT** softkey to view the errors in the error queue. As shown below, the first error in the list (i.e., the error at the top of the list) is the first error that was generated.



```
Remote Interface Command Errors.  
-113 Undefined header  
-151 Invalid string data  
DONE
```

- *Remote Interface Operation:*

SYSTEM:ERROR? *Reads one error from the error queue*

Errors have the following format (the error string may contain up to 255 characters).

-113, "Undefined header"

Beeper Control

Normally, the function generator will emit a tone when an error is generated from the front-panel or over the remote interface. You may want to disable the front-panel beeper for certain applications.

- The beeper state is stored in *non-volatile* memory and *does not* change when power has been off or after a remote interface reset. When shipped from the factory, the beeper is enabled.
- Turning off the beeper *does not* disable the key click generated when you press a front-panel key or turn the knob.
- *Front-Panel Operation:* Press  and then select the **Beep** softkey from the “System” menu.
- *Remote Interface Operation:*

```
SYSTem:BEePer                               Issue a single beep immediately
SYSTem:BEePer:STATe {OFF|ON}                 Disable/enable beeper
```

Display Bulb-Saver

The front-panel display bulb will normally turn off and the screen will go blank after 8 hours of inactivity. For certain applications, you may want to disable the bulb-saver feature. *This feature is available from the front panel only.*

- The bulb-saver setting is stored in *non-volatile* memory and *does not* change when power has been off or after a remote interface reset. When shipped from the factory, the bulb-saver mode is enabled.
- *Front-Panel Operation:* Press  and then select the **Scrn Svr** (screen saver) softkey from the “System” menu.

Display Contrast

To optimize the readability of the front-panel display, you can adjust the contrast setting. *This feature is available from the front panel only.*

- Display contrast: 15 to 50. *The default is 30.*
- The contrast setting is stored in *non-volatile* memory and *does not* change when power has been off or after a remote interface reset.
- *Front-Panel Operation:* Press  and then select the **Display Contr** softkey from the “System” menu.

3

Self-Test

- A *power-on* self-test occurs automatically when you turn on the function generator. This limited test assures you that the function generator is operational.
- A *complete* self-test runs a series of tests and takes approximately 15 seconds to execute. If all tests pass, you can have high confidence that the function generator is fully operational.
- If the complete self-test is successful, “Self-Test Passed” is displayed on the front panel. If the self-test fails, “Self-Test Failed” is displayed and an error number is shown. See the Agilent 33220A *Service Guide* for instructions on returning the instrument to Agilent for service.
- *Front-Panel Operation:* Press  and then select the **Self Test** softkey from the “Test/Cal” menu.
- *Remote Interface Operation:*

*TST?

Returns “0” if the self-test passes or “1” if it fails. If the self-test fails, an error message is also generated with additional information on why the test failed.

Display Control

For security reasons, or to speed up the rate at which the function generator can execute commands from the remote interface, you may want to turn off the front-panel display. From the remote interface, you can also display a 12-character message on the front panel.

- You can only disable the front-panel display by sending a command from the remote interface (you cannot disable the front panel while in local operation).
- When disabled, the front-panel display is blanked (however, the bulb used to backlight the display remains enabled). All keys except **Local** are locked out when the display is disabled.
- Sending a message to the front-panel display from the remote interface overrides the display state. This means that you can display a message even if the display is currently disabled (remote interface errors are always displayed even if the display is disabled).
- The display is automatically enabled when power is cycled, after an instrument reset (*RST command), or when you return to local (front panel) operation. Press the **Local** key or execute the IEEE-488 GTL (*Go To Local*) command from the remote interface to return to the local state.
- The display state is saved when you store the instrument state using *SAV command. When you recall the instrument state using *RCL command, the front-panel display will return to the previous state.
- You can display a text message on the front panel by sending a command from the remote interface. You can use upper- or lower-case letters (A-Z), numbers (0-9), and any other character on a standard computer keyboard. Depending on the number of characters that you specify, the function generator will choose one of two font sizes to display the message. You can display approximately 12 characters in a large font and approximately 40 characters in a small font.

- *Remote Interface Operation:* The following command turns off the front-panel display.

```
DISP OFF
```

- The following command displays a message on the front panel and turns on the display if currently disabled.

```
DISP:TEXT 'Test in Progress...'
```

To clear the message displayed on the front panel (without changing the display state), send the following command.

```
DISP:TEXT CLEAR
```

3

Number Format

The function generator can show numbers on the front-panel display with periods or commas for the decimal point and digits separator. *This feature is available from the front panel only.*



Decimal Point: Period
Digits Separator: Comma



Decimal Point: Comma
Digits Separator: None

- The number format is stored in *non-volatile* memory and *does not* change when power has been off or after a remote interface reset. When shipped from the factory, a period is used for the decimal point and commas are used for the digits separator (e.g., 1.000,000,00 kHz).
- *Front-Panel Operation:* Press  and then select the **Number Format** softkey from the “System” menu.

Firmware Revision Query

You can query the function generator to determine which revision of firmware is currently installed. The revision code contains five numbers in the form “**f.ff-b.bb-aa-p**”.

- f.ff** = Firmware revision number
- b.bb** = Boot kernel revision number
- aa** = ASIC revision number
- p** = Printed circuit board revision number

- *Front-Panel Operation:* Press  and then select the **Cal Info** softkey from the “Test/Cal” menu. The revision code is listed as one of the messages on the front-panel display.
- *Remote Interface Operation:* Use the following command to read the function generator’s firmware revision numbers (be sure to dimension a string variable with at least 50 characters).

```
*IDN?
```

This command returns a string in the form:

```
Agilent Technologies,33220A,0,f.ff-b.bb-aa-p
```

SCPI Language Version Query

The function generator complies with the rules and conventions of the present version of SCPI (*Standard Commands for Programmable Instruments*). You can determine the SCPI version with which the instrument is in compliance by sending a query from the remote interface.

You cannot query the SCPI version from the front panel.

- *Remote Interface Operation:*

```
SYSTem:VERSion?
```

Returns a string in the form “YYYY.V”, where “YYYY” represents the year of the version, and “V” represents a version number for that year (e.g., 1999.0).

Remote Interface Configuration

This section gives information on configuring the function generator for remote interface communication. For information on configuring the instrument from the front panel, see “To Configure the Remote Interface” starting on page 48. For information on the SCPI commands available to program the function generator over the remote interface, see chapter 4, “Remote Interface Reference” starting on page 141.

The Agilent 33220A supports remote interface communication using a choice of three interfaces: GPIB, USB, and LAN. All three interfaces are “live” at power up. This section describes some interface configuration parameters that you may need to set on your function generator.

Note: *The CD-ROM provided with your instrument contains connectivity software to enable communications over these interfaces. Refer to the instructions provided on the CD-ROM to install this software on your PC.*

- **GPIB Interface.** You need only set the GPIB address for the function generator and connect it to your PC using a GPIB cable.
- **USB Interface.** There is nothing to configure on your function generator. Just connect the function generator to the PC with a USB cable.
- **LAN Interface.** By default, DHCP is On, which may enable network communication over the LAN interface. You may need to set several configuration parameters as described in the LAN configuration sections that follow.

For detailed background information, refer to the *Agilent Technologies USB/LAN/GPIB Connectivity Guide*, which you can download from the Agilent web site at the following URL:

www.agilent.com/find/connectivity

GPIB Address

Each device on the GPIB (IEEE-488) interface must have a unique address. You can set the function generator's address to any value between 0 and 30. The address is set to "10" when the function generator is shipped from the factory. The GPIB address is displayed at power-on.

- The address is stored in *non-volatile* memory and *does not* change when power has been off or after a remote interface reset.
- Your computer's GPIB interface card has its own address. Be sure to avoid using the computer's address for any instrument on the interface bus.
- *Front-Panel Operation:* Press  and then select the **GPIB Address** softkey from the "I/O" menu.
- There is no SCPI command to set the GPIB address.

DHCP On/Off (LAN)

DHCP (Dynamic Host Configuration Protocol) is a protocol for automatically assigning a dynamic IP address to a device on a network. DHCP is typically the easiest way to configure your Agilent 33220A for remote communication using the LAN interface. *DHCP is On by default.*

- Select **DHCP On** to use DHCP to automatically assign an IP address.
- Select **DHCP Off** if you want to manually assign an IP address using the **IP Address** softkey.
- If the DHCP server fails to assign a valid IP address, the currently configured IP Address setting will be used
- The DHCP setting is stored in *non-volatile* memory and does not change when power has been off or after a remote interface reset.
- *Front panel operation:* Press  and press the **I/O** softkey. Then select **LAN**, followed by **IP Setup**. By default, DHCP is On. Press the **DHCP On/Off** softkey to toggle its state.
- There is no SCPI command to set DHCP On/Off.

Note: *If you change any LAN settings, you must cycle the power to activate the new settings. This is true for all LAN settings, including turning DHCP on or off.*

IP Address (LAN)

You can enter an IP address for the Agilent 33220A. An IP address is actually a four-byte integer expressed in the notation "nnn.nnn.nnn.nnn" where "nnn" in each case is a byte value from 000 to 255.

- You need not set an IP address if DHCP is in use. However, if the DHCP server fails to assign a valid IP address, the currently configured IP Address setting is used.
- Contact your network administrator for a valid IP address to use for your function generator.
- Enter the IP address using the numeric keypad (not the knob).
- The IP address is stored in *non-volatile* memory and does not change when power has been off or after a remote interface reset.
- *Front panel operation:* Press **Utility** and press the **I/O** softkey. Then select **LAN**, followed by **IP Setup**. By default, DHCP is On. Select **DHCP Off** if necessary. The **IP Address** field appears.
- There is no SCPI command to set an IP address.

Subnet Mask (LAN)

Subnetting allows the network administrator to divide a network into smaller networks to simplify administration and to minimize network traffic. The subnet mask indicates the portion of the host address to be used to indicate the subnet.

- You need not set a subnet mask if DHCP is in use.
- Contact your network administrator to find out whether subnetting is being used, and for the correct subnet mask.
- Enter the subnet mask using the numeric keypad (not the knob).
- The subnet mask is stored in *non-volatile* memory and does not change when power has been off or after a remote interface reset.
- *Front panel operation:* Press **Utility** and press the **I/O** softkey. Then select **LAN**, followed by **IP Setup**. By default, DHCP is On. Select **DHCP Off** if necessary. Then select **Subnet Mask**.
- There is no SCPI command to set a subnet mask.



Default Gateway (LAN)

A gateway is a network device that provides a connection between networks. The default gateway setting is the IP address of such a device.

- You need not set a gateway address if DHCP is in use.
- Contact your network administrator to find out whether a gateway is being used, and for the address.
- Enter the gateway address using the numeric keypad (not the knob).
- The gateway address is stored in *non-volatile* memory and does not change when power has been off or after a remote interface reset.
- *Front panel operation:* Press  and press the **I/O** softkey. Then select **LAN**, followed by **IP Setup**. By default, DHCP is On. Select **DHCP Off** if necessary. Then select **Default Gateway**.
- There is no SCPI command to set a gateway address.



Host Name (LAN)

A host name is the host portion of the domain name, which is translated into an IP address.

- Contact your network administrator for the correct host name.
- Enter the host name using the knob and cursor keys. Each character in the name can be a letter ("a" through "z"), number, or dash ("_").
 - Use the knob to select each character.
 - Use the cursor key to move to the next character.
 - You can use the keypad for numbers.
 - Use the  key to delete all characters to the right, starting at the cursor position.
- The host name is stored in *non-volatile* memory and does not change when power has been off or after a remote interface reset.
- *Front panel operation:* Press  and press the **I/O** softkey. Then select **LAN**, followed by **DNS Setup**. Then select **Host Name**.
- There is no SCPI command to set a host name.

Domain Name (LAN)

A domain name is a registered name on the Internet, which is translated into an IP address.

- Contact your network administrator for the correct domain name.
- Enter the domain name using the knob and cursor keys. Each character in the name can be a letter ("a" through "z"), number, dash ("_"), or period (".").
 - Use the knob to select each character.
 - Use the cursor key to move to the next character.
 - You can use the keypad for numbers.
- Use the  key to delete all characters to the right, starting at the cursor position.
- The host name is stored in *non-volatile* memory and does not change when power has been off or after a remote interface reset.
- *Front panel operation:* Press  and press the **I/O** softkey. Then select **LAN**, followed by **DNS Setup**. Then select **Domain Name**.
- There is no SCPI command to set a domain name.

DNS Server (LAN)

DNS (Domain Name Service) is an Internet service that translates Domain names into IP addresses. The DNS server address is the IP address of a server that performs this service.

- Contact your network administrator to find out whether DNS is being used, and for the correct DNS server address.
- Enter the address using the numeric keypad (not the knob).
- The DNS server address is stored in *non-volatile* memory and does not change when power has been off or after a remote interface reset.
- *Front panel operation:* Press  and press the **I/O** softkey. Then select **LAN**, followed by **DNS Setup**. Then select **DNS Server**.
- There is no SCPI command to set a DNS server address.

Current Configuration (LAN)

Select the Currently Active Settings display to view the current LAN configuration information.

- *Front panel operation:* Press  and press the **I/O** softkey. Select **LAN**, and then select **Current Config**.
- There is no SCPI command to display the configuration screen.

Note: *This display reflects only the settings that are **currently active**. If you have changed any LAN settings, you must first cycle the power to activate the settings, then select **Current Config**. Also, this display is **static**. It does not update information for events that have occurred after the information is displayed. For example, if DHCP assigns an IP address while the display is open, you will not see the new IP address until you press the **Refresh** button.*

Try the Agilent 33220A Web Interface!

The Agilent 33220A provides a web interface resident in the instrument. You can use this interface over the LAN to view and modify the instrument's I/O configuration. Also, a remote front panel interface is provided, which allows you to control the instrument over the network.

To access and use the web interface:

1. Establish LAN interface connectivity from your PC to the 33220A.
2. Open your PC's web browser.
3. To launch the web interface enter the IP address of the *instrument*, or its fully qualified host name, in the browser address field.
4. Follow the directions in the web interface's online help.

For further information, see the *Agilent Technologies USB/LAN/GPIB Connectivity Guide*, which you can download from the Agilent web site at the following URL:

www.agilent.com/find/connectivity

Calibration Overview

This section gives a brief introduction to the calibration features of the function generator. For a more detailed discussion of the calibration procedures, see chapter 4 in the *Agilent 33220A Service Guide*.

Calibration Security

This feature allows you to enter a security code to prevent accidental or unauthorized calibrations of the function generator. When you first receive your function generator, it is secured. Before you can perform a calibration, you must unsecure the function generator by entering the correct security code.

3

If you forget your security code, you can disable the security feature by means of two “CAL ENABLE” pads on the main PC board inside the instrument. See the *Agilent 33220A Service Guide* for more information.

- The security code is set to “AT33220A” when the function generator is shipped from the factory. The security code is stored in *non-volatile* memory and *does not* change when power has been off or after a remote interface reset.
- The security code may contain up to 12 alphanumeric characters. The first character must be a letter, but the remaining characters can be letters, numbers, or an underscore (“_”). You do not have to use all 12 characters but the first character must always be a letter.

Calibration Overview

To Unsecure for Calibration You can unsecure the function generator either from the front panel or over the remote interface. The function generator is secured when shipped from the factory and the security code is set to “AT33220A”.

- Once you enter a security code, that code must be used for both front-panel and remote operation. For example, if you secure the function generator from the front panel, you must use that same code to unsecure it from the remote interface.
- *Front-Panel Operation:* Press **Utility** and then select the **Secure Off** softkey from the “Test/Cal” menu.
- *Remote Interface Operation:* To unsecure the function generator, send the following command with the correct security code.

```
CAL:SECURE:STATE OFF,AT33220A
```

To Secure Against Calibration You can secure the function generator either from the front panel or over the remote interface. The function generator is secured when shipped from the factory and the security code is set to “AT33220A”.

- Once you enter a security code, that code must be used for both front-panel and remote operation. For example, if you secure the function generator from the front panel, you must use that same code to unsecure it from the remote interface.
- *Front-Panel Operation:* Press **Utility** and then select the **Secure On** softkey from the “Test/Cal” menu.
- *Remote Interface Operation:* To secure the function generator, send the following command with the correct security code.

```
CAL:SECURE:STATE ON,AT33220A
```



To Change the Security Code To change the security code, you must first unsecure the function generator, and then enter a new code. Make sure you have read the security code rules described on page 141 before attempting to change the security code.

- *Front-Panel Operation:* To change the security code, unsecure the function generator using the old security code. Then press **UTILITY** and select the **Secure Code** softkey from the “Test/Cal” menu. Changing the code from the front panel also changes the security code as seen from the remote interface.
- *Remote Interface Operation:* To change the security code, you must first unsecure the function generator using the old security code. Then enter the new code as shown below.

```
CAL:SECURE:STATE OFF, AT33220A    Unsecure with old code
CAL:SECURE:CODE SN123456789      Enter new code
```

Calibration Count

You can query the function generator to determine how many calibrations have been performed. Note that your function generator was calibrated before it left the factory. When you receive your function generator, be sure to read the count to determine its initial value.

- The calibration count is stored in *non-volatile* memory and *does not* change when power has been off or after a remote interface reset.
- The calibration count increments up to a maximum of 65,535 after which it rolls over to “0”. Since the value increments by one for each calibration point, a complete calibration may increase the value by many counts.
- *Front-Panel Operation:* Press **UTILITY** and then select the **Cal Info** softkey from the “Test/Cal” menu. The calibration count is listed as one of the messages on the display.
- *Remote Interface Operation:*

```
CALibration:COUNT?
```

Calibration Overview

Calibration Message

The function generator allows you to store one message in calibration memory in the mainframe. For example, you can store such information as the date when the last calibration was performed, the date when the next calibration is due, the function generator's serial number, or the name and phone number of the person to contact for a new calibration.

- You can record a calibration message *only* from the remote interface and *only* when the function generator is unsecured. You can read the message from either the front-panel or over the remote interface. You can *read* the calibration message whether the function generator is secured or unsecured.
- The calibration message may contain up to 40 characters (additional characters are truncated).
- Storing a calibration message will overwrite any message previously stored in memory.
- The calibration message is stored in *non-volatile* memory and *does not* change when power has been off or after a remote interface reset.
- *Front-Panel Operation:* Press  and then select the **Cal Info** softkey from the "Test/Cal" menu. The calibration message is listed as one of the messages on the display.
- *Remote Interface Operation:* To store the calibration message, send the following command, including any desired string within the single quotes (' ').

```
CAL:STR 'Cal Due: 01 August 2003'
```

Factory Default Settings

The table on the following page summarizes the factory default settings for the Agilent 33220A. *For your convenience, this table is duplicated inside the rear cover of this manual and on the Quick Reference Card.*

Note: The power-on state will be different than that in the table if you have enabled the power-down recall mode. See “Instrument State Storage” on page 126.



Factory Default Settings**Agilent 33220A Factory Default Settings**

Output Configuration	Factory Setting
Function	Sine wave
Frequency	1 kHz
Amplitude / Offset	100 mVpp / 0.000 Vdc
Output Units	Vpp
Output Termination	50 Ω
Autorange	On
Modulation	Factory Setting
Carrier (AM, FM, PM, FSK)	1 kHz Sine wave
Carrier (PWM)	1 kHz Pulse
Mod. Waveform (AM)	100 Hz Sine wave
Mod. Waveform (FM, PM, PWM)	10 Hz Sine wave
AM Depth	100%
FM Deviation	100 Hz
PM Deviation	180 degrees
FSK Hop Frequency	100 Hz
FSK Rate	10 Hz
PWM Width Deviation	10 μ s
Modulation State	Off
Sweep	Factory Setting
Start / Stop Frequency	100 Hz / 1 kHz
Sweep Time	1 Second
Sweep Mode	Linear
Sweep State	Off
Burst	Factory Setting
Burst Count	1 Cycle
Burst Period	10 ms
Burst Start Phase	0 degrees
Burst State	Off
System-Related Operations	Factory Setting
• Power-Down Recall	• Disabled
Display Mode	On
Error Queue	Errors are Cleared
Stored States, Stored Arbs	No Change
Output State	Off
Triggering Operations	Factory Setting
Trigger Source	Internal (Immediate)
Remote Interface Configuration	Factory Setting
• GPIB Address	• 10
• DHCP	• On
• IP Address	• 169.254.002.020
• Subnet Mask	• 255.255.000.000
• Default Gateway	• 000.000.000.000
• DNS Server	• 000.000.000.000
• Host Name	• none
• Domain Name	• none
Calibration	Factory Setting
Calibration State	Secured

Parameters marked with a bullet (•) are stored in *non-volatile* memory.

Remote Interface Reference

Remote Interface Reference

- SCPI Command Summary, *on page 149*
-  → • Simplified Programming Overview, *on page 161*
- Using the APPLy Command, *on page 163*
- Output Configuration Commands, *on page 172*
- Pulse Configuration Commands, *on page 185*
- Amplitude Modulation (AM) Commands, *on page 190*
- Frequency Modulation (FM) Commands, *on page 193*
- Phase Modulation (PM) Commands, *on page 197*
- Frequency-Shift Keying (FSK) Commands, *on page 182*
- Pulse Width Modulation (PWM) Commands, *on page 185*
- Frequency Sweep Commands, *on page 208*
- Burst Mode Commands, *on page 216*
- Triggering Commands, *on page 224*
- Arbitrary Waveform Commands, *on page 227*
- State Storage Commands, *on page 238*
- System-Related Commands, *on page 242*
- Interface Configuration Commands, *on page 247*
- Phase-Lock Commands (Option 001 Only), *on page 248*
- The SCPI Status System, *on page 250*
- Status Reporting Commands, *on page 260*
- Calibration Commands, *on page 264*
-  → • An Introduction to the SCPI Language, *on page 266*
- Using Device Clear, *on page 271*

Throughout this manual “*default*” states and values are identified. These are the power-on default states *provided* you have not enabled the power-down recall mode (see “Instrument State Storage” in chapter 3).



If you are a first-time user of the SCPI language, please refer to these sections to become familiar with the language before attempting to program the function generator.

SCPI Command Summary

Throughout this manual, the following conventions are used for SCPI command syntax for remote interface programming:

- Square brackets ([]) indicate optional keywords or parameters.
- Braces ({ }) enclose parameters within a command string.
- Triangle brackets (< >) enclose parameters for which you must substitute a value.
- A vertical bar (|) separates multiple parameter choices.

The APPLY Commands

(see page 163 for more information)

APPLY

```
:SINusoid [<frequency> [, <amplitude> [, <offset>] ] ]  
:SQUare [<frequency> [, <amplitude> [, <offset>] ] ]  
:RAMP [<frequency> [, <amplitude> [, <offset>] ] ]  
:PULSe [<frequency> [, <amplitude> [, <offset>] ] ]  
:NOISe [<frequency>|DEF>1 [, <amplitude> [, <offset>] ] ]  
:DC [<frequency>|DEF>1 [, <amplitude>|DEF>1 [, <offset>] ] ]  
:USER [<frequency> [, <amplitude> [, <offset>] ] ]
```

APPLY?

¹ This parameter has no effect for this command but you **MUST** specify a value or "DEFault".

Chapter 4 Remote Interface Reference
SCPI Command Summary

Output Configuration Commands

(see page 172 for more information)

```
FUNCTION {SINusoid|SQUare|RAMP|PULSe|NOISe|DC|USER}
FUNCTION?

FREQuency {<frequency>|MINimum|MAXimum}
FREQuency? [MINimum|MAXimum]

VOLTage {<amplitude>|MINimum|MAXimum}
VOLTage? [MINimum|MAXimum]

VOLTage:OFFSet {<offset>|MINimum|MAXimum}
VOLTage:OFFSet? [MINimum|MAXimum]

VOLTage
  :HIGH {<voltage>|MINimum|MAXimum}
  :HIGH? [MINimum|MAXimum]
  :LOW {<voltage>|MINimum|MAXimum}
  :LOW? [MINimum|MAXimum]

VOLTage:RANGE:AUTO {OFF|ON|ONCE}
VOLTage:RANGE:AUTO?

VOLTage:UNIT {VPP|VRMS|DBM}
VOLTage:UNIT?

FUNCTION:SQUare:DCYCLE {<percent>|MINimum|MAXimum}
FUNCTION:SQUare:DCYCLE? [MINimum|MAXimum]

FUNCTION:RAMP:SYMMetry {<percent>|MINimum|MAXimum}
FUNCTION:RAMP:SYMMetry? [MINimum|MAXimum]

OUTPut {OFF|ON}
OUTPut?

OUTPut:LOAD {<ohms>|INFinity|MINimum|MAXimum}
OUTPut:LOAD? [MINimum|MAXimum]

OUTPut:POLarity {NORMal|INVerted}
OUTPut:POLarity?

OUTPut:SYNC {OFF|ON}
OUTPut:SYNC?
```

Parameters shown in **bold** are selected following a *RST (reset) command.

Pulse Configuration Commands

(see page 185 for more information)

```
PULSe:PERiod {<seconds>|MINimum|MAXimum}
PULSe:PERiod? [MINimum|MAXimum]

FUNCTION:PULSe
:HOlD {width|DCYcle}
:HOlD? [WIDTh|DCYClE]
:WIDTh {<seconds>|MINimum|MAXimum} 50% to 50% Thresholds
:WIDTh? [MINimum|MAXimum]
:DCYClE {<percent>|MINimum|MAXimum}
:DCYClE? [MINimum|MAXimum]
:TRANsition {<seconds>|MINimum|MAXimum} 10% to 90% Thresholds
:TRANsition? [MINimum|MAXimum]
```

*Parameters shown in bold are selected following a *RST (reset) command.*

Chapter 4 Remote Interface Reference
SCPI Command Summary

Modulation Commands

(see page 190 for more information)

AM Commands

AM:INTernal
:FUNction {**SINusoid**|SQUare|RAMP|NRAMP|TRIangle|NOISE|USER}
:FUNction?

AM:INTernal
:FREQuency {<frequency>|MINimum|MAXimum}
:FREQuency? [MINimum|MAXimum]

AM:DEPTH {<depth in percent>|MINimum|MAXimum}
AM:DEPTH? [MINimum|MAXimum]

AM:SOURce {**INTernal**|EXTernal}
AM:SOURce?

AM:STATe {**OFF**|ON}
AM:STATe?

FM Commands

FM:INTernal
:FUNction {**SINusoid**|SQUare|RAMP|NRAMP|TRIangle|NOISE|USER}
:FUNction?

FM:INTernal
:FREQuency {<frequency>|MINimum|MAXimum}
:FREQuency? [MINimum|MAXimum]

FM:DEVIation {<peak deviation in Hz>|MINimum|MAXimum}
FM:DEVIation? [MINimum|MAXimum]

FM:SOURce {**INTernal**|EXTernal}
FM:SOURce?

FM:STATe {**OFF**|ON}
FM:STATe?

Parameters shown in bold are selected following a *RST (reset) command.

Chapter 4 Remote Interface Reference
SCPI Command Summary

PM Commands

```
PM:INTernal
:FUNction {SINusoid|SQUare|RAMP|NRAMP|TRIangle|NOISe|USER}
:FUNction?

PM:INTernal
:FREQuency {<frequency>|MINimum|MAXimum}
:FREQuency? [MINimum|MAXimum]

PM:DEVIation {<deviation in degrees>|MINimum|MAXimum}
PM:DEVIation? [MINimum|MAXimum]

PM:SOURce {INTernal|EXTernal}
PM:SOURce?

PM:STATe {OFF|ON}
PM:STATe?
```

FSK Commands

```
FSKey:FREQuency {<frequency>|MINimum|MAXimum}
FSKey:FREQuency? [MINimum|MAXimum]

FSKey:INTernal:RATE {<rate in Hz>|MINimum|MAXimum}
FSKey:INTernal:RATE? [MINimum|MAXimum]

FSKey:SOURce {INTernal|EXTernal}
FSKey:SOURce?

FSKey:STATe {OFF|ON}
FSKey:STATe?
```

PWM Commands

```
PWM:INTernal
:FUNction {SINusoid|SQUare|RAMP|NRAMP|TRIangle|NOISe|USER}
:FUNction?

PWM:INTernal
:FREQuency {<frequency>|MINimum|MAXimum}
:FREQuency? [MINimum|MAXimum]

PWM:DEVIation {<deviation in seconds>|MINimum|MAXimum}
PWM:DEVIation? [MINimum|MAXimum]

PWM:DEVIation:DCYCLE {<deviation in percent>|MINimum|MAXimum}
PWM:DEVIation:DCYCLE? [MINimum|MAXimum]

PWM:SOURce {INTernal|EXTernal}
PWM:SOURce?

PWM:STATe {OFF|ON}
PWM:STATe?
```

*Parameters shown in bold are selected following a *RST (reset) command.*

Chapter 4 Remote Interface Reference
SCPI Command Summary

Sweep Commands

(see page 210 for more information)

```
FREquency
:START {<frequency>|MINimum|MAXimum}
:START? [MINimum|MAXimum]
:STOP {<frequency>|MINimum|MAXimum}
:STOP? [MINimum|MAXimum]

FREquency
:CENTer {<frequency>|MINimum|MAXimum}
:CENTer? [MINimum|MAXimum]
:SPAN {<frequency>|MINimum|MAXimum}
:SPAN? [MINimum|MAXimum]

SWEep
:SPACing {LINear|LOGarithmic}
:SPACing?
:TIME {<seconds>|MINimum|MAXimum}
:TIME? [MINimum|MAXimum]

SWEep:STATe {OFF|ON}
SWEep:STATe?

TRIGger:SOURce {IMmediate|EXTernal|BUS}
TRIGger:SOURce?

TRIGger:SLOPe {POSitive|NEGative}          "Trig In" Connector
TRIGger:SLOPe?

OUTPut
:TRIGger:SLOPe {POSitive|NEGative}        "Trig Out" Connector
:TRIGger:SLOPe?
:TRIGger {OFF|ON}
:TRIGger?

MARKer:FREquency {<frequency>|MINimum|MAXimum}
MARKer:FREquency? [MINimum|MAXimum]

MARKer {OFF|ON}
MARKer?
```

Parameters shown in **bold** are selected following a *RST (reset) command.

Burst Commands

(see page 216 for more information)

```
BURSt:MODE {TRIGgered|GATed}
BURSt:MODE?

BURSt:NCYCles {<# cycles>|INFIinity|MINimum|MAXimum}
BURSt:NCYCles? [MINimum|MAXimum]

BURSt:INTernal:PERiod {<seconds>|MINimum|MAXimum}
BURSt:INTernal:PERiod? [MINimum|MAXimum]

BURSt:PHASe {<angle>|MINimum|MAXimum}
BURSt:PHASe? [MINimum|MAXimum]

BURSt:STATE {OFF|ON}
BURSt:STATE?

UNIT:ANGLE {DEGREE|RADian}
UNIT:ANGLE?

TRIGger:SOURce {IMMEDIATE|EXTernal|BUS} Triggered Burst
TRIGger:SOURce?

TRIGger:SLOPe {POSitive|NEGative} "Trig In" Connector
TRIGger:SLOPe?

BURSt:GATE:POLarity {NORMAL|INVerted} External Gated Burst
BURSt:GATE:POLarity?

OUTPut
:TRIGger:SLOPe {POSitive|NEGative} "Trig Out" Connector
:TRIGger:SLOPe?
:TRIGger {OFF|ON}
:TRIGger?
```

Parameters shown in bold are selected following a *RST (reset) command.

Chapter 4 Remote Interface Reference
SCPI Command Summary

Arbitrary Waveform Commands

(see page 227 for more information)

```
DATA VOLATILE, <value>, <value>, . . .
DATA:DAC VOLATILE, {<binary block>|<value>, <value>, . . . }
FORMat:BORDER {NORMAL|SWAPPed}          Specify Byte Order
FORMat:BORDER?
DATA:COPY <destination arb name> [, VOLATILE]
FUNCTION:USER {<arb name>1|VOLATILE}
FUNCTION:USER?
FUNCTION USER
FUNCTION?
DATA
:CATalog?
:NVOLatile:CATalog?
:NVOLatile:FREE?
DATA:DELeTe <arb name>
DATA:DELeTe:ALL
DATA
:ATTRibute:AVERage? [<arb name>1]
:ATTRibute:CFACTOR? [<arb name>1]
:ATTRibute:POINTs? [<arb name>1]
:ATTRibute:PTPeak? [<arb name>1]
```

¹ The names of the built-in arb waveforms are: **EXP_RISE**, **EXP_FALL**, **NEG_RAMP**, **SINC**, and **CARDIAC**.

Parameters shown in **bold** are selected following a *RST (reset) command.

Triggering Commands

(see page 224 for more information)

These commands are used for Sweep and Burst only.

```
TRIGger:SOURce {IMmediate|EXTeRnal|BUS}
TRIGger:SOURce?

TRIGger
*TRG

TRIGger:SLOPe {POSitive|NEGative}           "Trig In" Connector
TRIGger:SLOPe?

BURSt:GATE:POLarity {NORmal|INVerted}       External Gated Burst
BURSt:GATE:POLarity?

OUTPut
:TRIGger:SLOPe {POSitive|NEGative}         "Trig Out" Connector
:TRIGger:SLOPe?
:TRIGger {OFF|ON}
:TRIGger?
```

State Storage Commands

(see page 238 for more information)

```
*SAV {0|1|2|3|4}           State 0 is the instrument state at power down.
*RCL {0|1|2|3|4}           States 1 through 4 are user-defined states.

MEMory:STATE
:NAME {0|1|2|3|4} [, <name>]
:NAME? {0|1|2|3|4}
:DELeTe {0|1|2|3|4}
:RECall:AUTO {OFF|ON}
:RECall:AUTO?
:VALid? {0|1|2|3|4}

MEMory:NSTates?
```

*Parameters shown in bold are selected following a *RST (reset) command.*

Chapter 4 Remote Interface Reference
SCPI Command Summary

System-Related Commands

(see page 242 for more information)

SYSTem:ERRor?
*IDN?
DISPlay {OFF|ON}
DISPlay?
DISPlay
:TEXT <quoted string>
:TEXT?
:TEXT:CLEar
*RST
*TST?
SYSTem:VERSion?
SYSTem
:BEEPer
:BEEPer:STATe {OFF|ON}
:BEEPer:STATe?
SYSTem
:KLOCK[:STATe] {OFF|ON}
:KLOCK:EXCLude {NONE|LOCAL}
SYSTem:SECurity:IMMediate

*LRN?
*OPC
*OPC?
*WAI

Caution. Clears all memory. Not recommended for routine applications.

Interface Configuration Commands

(see page 247 for more information)

SYSTem:COMMunicate:RLSTate {LOCAL|REMOTE|RWLOCK}

Parameters shown in bold are selected following a *RST (reset) command.

Phase-Lock Commands

These commands require Option 001, External Timebase Reference (see page 248 for more information).

```
PHASe {<angle>|MINimum|MAXimum}
PHASe? [MINimum|MAXimum]

PHASe:REFerence

PHASe:UNLock:ERRor:STATe {OFF|ON}
PHASe:UNLock:ERRor:STATe?

UNIT:ANGLE {DEGree|RADian}
UNIT:ANGLE?
```

Status Reporting Commands

(see page 260 for more information)

```
*STB?

*SRE <enable value>
*SRE?

STATus
:QUESTionable:CONDition?
:QUESTionable[:EVENT]?
:QUESTionable:ENABle <enable value>
:QUESTionable:ENABle?

*ESR?

*ESE <enable value>
*ESE?

*CLS

STATus:PRESet

*PSC {0|1}
*PSC?

*OPC
```

Parameters shown in **bold** are selected following a *RST (reset) command.

Chapter 4 Remote Interface Reference
SCPI Command Summary

Calibration Commands

(see page 264 for more information)

CALibration?

CALibration

```
:SECure:STATe {OFF|ON}, <code>
:SECure:STATe?
:SECure:CODE <new code>
:SETup <0|1|2|3| . . . |94>
:SETup?
:VALue <value>
:VALue?
:COUNT?
:STRing <quoted string>
:STRing?
```

IEEE 488.2 Common Commands

```
*CLS
*ESR?
*ESE <enable value>
*ESE?
*IDN?
*LRN?
*OPC
*OPC?
*PSC {0|1}
*PSC?
*RST
*SAV {0|1|2|3|4}
*RCL {0|1|2|3|4}
*STB?
*SRE <enable value>
*SRE?
*TRG
*TST?
```

*State 0 is the instrument state at power down.
States 1 through 4 are user-defined states.*

Simplified Programming Overview

This section gives an overview of the basic techniques used to program the function generator over the remote interface. This section is only an overview and does not give all of the details you will need to write your own application programs. Refer to the remainder of this chapter and also the application examples in chapter 6 for more details. You may also want to refer to the reference manual that came with your programming application for further details on instrument control.

Using the APPLy Command

The APPLy command provides the most straightforward method to program the function generator over the remote interface. For example, the following command string sent from your computer will output a 3 Vpp sine wave at 5 kHz with a -2.5 volt offset.

```
APPL:SIN 5.0E+3, 3.0, -2.5
```

Using the Low-Level Commands

Although the APPLy command provides the most straightforward method to program the function generator, the low-level commands give you more flexibility to change individual parameters. For example, the following command strings sent from your computer will output a 3 Vpp sine wave at 5 kHz with a -2.5 volt offset.

<code>FUNC SIN</code>	<i>Select sine wave function</i>
<code>FREQ 5000</code>	<i>Set frequency to 5 kHz</i>
<code>VOLT 3.0</code>	<i>Set amplitude to 3 Vpp</i>
<code>VOLT:OFFS -2.5</code>	<i>Set offset to -2.5 Vdc</i>

Reading a Query Response

Only the query commands (commands that end with “?”) will instruct the function generator to send a response message. Queries return internal instrument settings. For example, the following command string sent from your computer will read the function generator’s error queue and retrieve the response from the most recent error.

dimension statement	<i>Dimension string array (255 elements)</i>
SYST:ERR?	<i>Read error queue</i>
enter statement	<i>Enter error string response</i>

Selecting a Trigger Source

When *Sweep* or *Burst* is enabled, the function generator will accept an immediate internal trigger, a hardware trigger from the rear-panel *Trig In* connector, a manual trigger from the front-panel  key, or a software (bus) trigger. By default, the internal trigger source is selected. If you want to use an external or a software trigger source, you must first select that source. For example, the following command strings sent from your computer will output a 3-cycle burst each time the rear-panel *Trig In* connector receives the rising edge of a TTL pulse.

BURS:NCYC 3	<i>Set burst count to 3 cycles</i>
TRIG:SLOP POS	<i>Set polarity to rising edge</i>
TRIG:SOUR EXT	<i>Select external trigger source</i>
BURS:STAT ON	<i>Enable burst mode</i>

Using the APPLy Command

See also “Output Configuration” starting on page 55 in chapter 3.

The APPLy command provides the most straightforward method to program the function generator over the remote interface. You can select the function, frequency, amplitude, and offset all in one command as shown in the syntax statement below.

```
APPLy:<function> [<frequency> [, <amplitude> [, <offset>] ]]
```

For example, the following command string sent from your computer will output a 3 Vpp sine wave at 5 kHz with a -2.5 volt offset.

```
APPL:SIN 5 KHZ, 3.0 VPP, -2.5 V
```

The APPLy command performs the following operations:

- Sets the trigger source to *Immediate* (equivalent to sending the TRIG:SOUR IMM command).
- Turns off any modulation, sweep, or burst mode currently enabled and places the instrument in the continuous waveform mode.
- Turns on the *Output* connector (OUTP ON command) but *does not* change the output termination setting (OUTP:LOAD command).
- Overrides the voltage autorange setting and automatically enables autoranging (VOLT:RANG:AUTO command).
- For square waveforms, overrides the current duty cycle setting and automatically selects 50% (FUNC:SQU:DCYC command).
- For ramp waveforms, overrides the current symmetry setting and automatically selects 100% (FUNC:RAMP:SYMM command).

The syntax statements for the APPLy command are shown on page 168.

Output Frequency

- For the *frequency* parameter of the APPLy command, the output frequency range depends on the function specified. You can substitute “MINimum”, “MAXimum”, or “DEFault” in place of a specific value for the *frequency* parameter. MIN selects the lowest frequency allowed for the function specified and MAX selects the highest frequency allowed. *The default frequency is 1 kHz for all functions.*

Function	Minimum Frequency	Maximum Frequency
Sine	1 μ Hz	20 MHz
Square	1 μ Hz	20 MHz
Ramp	1 μ Hz	200 kHz
Pulse	500 μ Hz	5 MHz
Noise, DC	Not Applicable	Not Applicable
Arbs	1 μ Hz	6 MHz

- Limits Due to Function:* The frequency limits are determined by the function specified in the APPLy command. The APPLy command always sets both the function and the frequency, and the specified frequency must be appropriate for the function. For example, the command APPL:RAMP 20 MHz results in a “Data out of range” error. The frequency is set to 200 kHz, which is the maximum for a ramp waveform.

Output Amplitude

- For the *amplitude* parameter of the APPLY command, the output amplitude range depends on the function specified and the output termination. You can substitute “MINimum”, “MAXimum”, or “DEFault” in place of a specific value for the *amplitude* parameter. MIN selects the smallest amplitude (1 mVpp into 50 ohms). MAX selects the largest amplitude for the function specified (at most 10 Vpp into 50 ohms depending on function and offset voltage). *The default amplitude is 100 mVpp (into 50 ohms) for all functions.*
- *Limits Due to Output Termination:* The output amplitude limits are determined by the current output termination setting (the APPLY command does not change the termination setting). For example, if you set the amplitude to 10 Vpp and then change the output termination from 50 ohms to “high impedance”, the amplitude displayed on the function generator’s front-panel will *double* to 20 Vpp (and no error will be generated). If you change from “high impedance” to 50 ohms, the displayed amplitude will drop in half. *See the OUTP:LOAD command on page 182 for more information.*
- You can set the output amplitude in Vpp, Vrms, or dBm by specifying the units as part of the APPLY command as shown below.

```
APPL:SIN 5.0E+3, 3.0 VRMS, -2.5
```

Or, you can use the VOLT:UNIT command (see page 184) to specify the output units for all commands that follow. Unless you specify the units as part of the APPLY command, the VOLT:UNIT command takes precedence. For example, if you select “Vrms” using the VOLT:UNIT command and *do not* include units with the APPLY command, the value specified for the *amplitude* parameter in the APPLY command will be in “Vrms”.

Using the APPLy Command

- You cannot specify the output amplitude in dBm if the output termination is currently set to “high impedance”. The units are automatically converted to Vpp. See the VOLT:UNIT command on page 184 for more information.
- *Limits Due to Units Selection:* In some cases, the amplitude limits are determined by the output units selected. This may occur when the units are Vrms or dBm due to the differences in crest factor for the various output functions. For example, if you output a 5 Vrms square wave (into 50 ohms) and then change to the sine wave function, the function generator will automatically adjust the output amplitude to 3.536 Vrms (the upper limit for sine waves in Vrms). From the remote interface, a “Data out of range” error will be generated and the amplitude will be adjusted as described.
- *Arbitrary Waveform Limitations:* For arbitrary waveforms, the maximum amplitude will be limited if the waveform data points do not span the full range of the output DAC (Digital-to-Analog Converter). For example, the built-in “Sinc” waveform does not use the full range of values between ± 1 and therefore its maximum amplitude is limited to 6.087 Vpp (into 50 ohms).
- While changing amplitude, you may notice a momentary disruption in the output waveform at certain voltages due to switching of the output attenuators. The amplitude is controlled, however, so the output voltage will never exceed the current setting while switching ranges. To prevent this disruption in the output, you can disable the voltage autoranging feature using the VOLT:RANG:AUTO command (see page 179 for more information). The APPLy command automatically enables autoranging.

DC Offset Voltage

- For the *offset* parameter of the APPLy command, you can substitute “MINimum”, “MAXimum”, or “DEFault” in place of a specific value for the parameter. MIN selects the most negative dc offset voltage for the function and amplitude specified. MAX selects the largest dc offset for the function and amplitude specified. *The default offset is 0 volts for all functions.*
- *Limits Due to Amplitude:* The relationship between offset voltage and output amplitude is shown below. V_{max} is the maximum *peak voltage* for the selected output termination (5 volts for a 50Ω load or 10 volts for a high-impedance load).

$$|V_{offset}| \leq V_{max} - \frac{V_{PP}}{2}$$

If the specified offset voltage is not valid, the function generator will automatically adjust it to the maximum dc voltage allowed with the amplitude specified. *From the remote interface, a “Data out of range” error will be generated and the offset will be adjusted as described.*

- *Limits Due to Output Termination:* The offset limits are determined by the current output termination setting (the APPLy command does not change the termination setting). For example, if you set the offset to 100 mVdc and then change the output termination from 50 ohms to “high impedance”, the offset voltage displayed on the function generator’s front-panel will *double* to 200 mVdc (and no error will be generated). If you change from “high impedance” to 50 ohms, the displayed offset will drop in half. *See the OUTP : LOAD command on page 182 for more information.*
- *Arbitrary Waveform Limitations:* For arbitrary waveforms, the maximum offset and amplitude will be limited if the waveform data points do not span the full range of the output DAC (Digital-to-Analog Converter). For example, the built-in “Sinc” waveform does not use the full range of values between ±1 and therefore its maximum offset is limited to 4.95 volts (into 50 ohms). The “0” DAC value is still used as the offset reference even if the waveform data points do not span the full range of the output DAC.

APPLy Command Syntax

- Because of the use of optional parameters in the APPLy commands (enclosed in square brackets), you must specify *frequency* to use the *amplitude* parameter, and you must specify both *frequency* and *amplitude* to use the *offset* parameter. For example, the following command string is valid (*frequency* and *amplitude* are specified but *offset* is omitted and therefore uses a default value).

```
APPL:SIN 5.0E+3, 3.0
```

However, you cannot specify an *amplitude* or *offset* without specifying a *frequency*.

- You can substitute “MINimum”, “MAXimum”, or “DEFault” in place of specific values for the *frequency*, *amplitude*, and *offset* parameters. For example, the following statement outputs a 3 V_{pp} sine wave at 20 MHz (the maximum frequency for sine) with a -2.5 volt offset.

```
APPL:SIN MAX, 3.0, -2.5
```

- The APPLy command performs the following operations:
 - Sets the trigger source to *Immediate* (equivalent to sending the TRIG:SOUR IMM command).
 - Turns off any modulation, sweep, or burst mode currently enabled and places the instrument in the continuous waveform mode.
 - Turns on the *Output* connector (OUTP ON command) but *does not* change the output termination setting (OUTP:LOAD command).
 - Overrides the voltage autorange setting and automatically enables autoranging (VOLT:RANG:AUTO command).
 - For square waveforms, overrides the current duty cycle setting and automatically selects 50% (FUNC:SQU:DCYC command).
 - For ramp waveforms, overrides the current symmetry setting and automatically selects 100% (FUNC:RAMP:SYMM command).

APPLY:SINusoid [*<frequency>* [, *<amplitude>* [, *<offset>*]]]

Output a sine wave with the specified frequency, amplitude, and dc offset. The waveform is output as soon as the command is executed.

APPLY:SQUare [*<frequency>* [, *<amplitude>* [, *<offset>*]]]

Output a square wave with the specified frequency, amplitude, and dc offset. This command overrides the current duty cycle setting and automatically selects 50%. The waveform is output as soon as the command is executed.

APPLY:RAMP [*<frequency>* [, *<amplitude>* [, *<offset>*]]]

Output a ramp wave with the specified frequency, amplitude, and dc offset. This command overrides the current symmetry setting and automatically selects 100%. The waveform is output as soon as the command is executed.

APPLY:PULSe [*<frequency>* [, *<amplitude>* [, *<offset>*]]]

Output a pulse wave with the specified frequency, amplitude, and dc offset. The waveform is output as soon as the command is executed.

- This command preserves the current pulse width setting (FUNC:PULS:WIDT command) or pulse duty cycle setting (FUNC:PULS:DCYC command), depending on which has been selected to “hold” (FUNC:PULS:HOLD command). The edge time setting (FUNC:PULS:TRAN command) is also preserved. However, based on the specified frequency, the function generator will adjust the pulse width or edge time to comply with the frequency restrictions for pulse waveforms. *See page 185 for more information on setting the pulse width and edge time.*

Chapter 4 Remote Interface Reference
Using the APPLy Command

APPLy:NOISe [*<frequency>*|DEFault> [,*<amplitude>* [,*<offset>*]]]

Output Gaussian noise with the specified amplitude and dc offset. The waveform is output as soon as the command is executed.

- The *frequency* parameter has no effect for this command but you must specify a value or “DEFault” (the noise function has a 10 MHz bandwidth). If you specify a frequency, it has no effect on the noise output, but the value is remembered when you change to a different function. The following statement shows the use of the APPLy command for noise.

```
APPL:NOIS DEF, 5.0, 2.0
```

APPLy:DC [*<frequency>*|DEFault> [,*<amplitude>*|DEFault> [,*<offset>*]]]

Output a dc voltage with the level specified by the *offset* parameter. You can set the dc voltage to any value between ± 5 Vdc into 50 ohms or ± 10 Vdc into an open circuit. The dc voltage is output as soon as the command is executed.

- The *frequency* and *amplitude* parameters have no effect for this command but you must specify a value or “DEFault”. If you specify a frequency and amplitude, they have no effect on the dc output, but the values are remembered when you change to a different function. The following statement shows the use of the APPLy command for a dc output.

```
APPL:DC DEF, DEF, -2.5
```

APPLy:USER [*<frequency>* [,*<amplitude>* [,*<offset>*]]]

Output the arbitrary waveform currently selected by the FUNC:USER command. The waveform is output using the specified frequency, amplitude, and dc offset. The waveform is output as soon as the command is executed. *See page 227 for more information on downloading arbitrary waveforms to memory.*

APPLy?

Query the function generator's current configuration and return a quoted string. The purpose of this command is to allow you to append this query response to an APPL: command in your programming application and use the result to place the function generator in the specified state. The function, frequency, amplitude, and offset are returned as shown in the sample string below (the quotation marks are returned as part of the string).

```
"SIN +5.000000000000E+03,+3.000000000000E+00,-2.500000000000E+00"
```

Output Configuration Commands

See also “Output Configuration” starting on page 55 in chapter 3.

This section describes the low-level commands used to program the function generator. Although the `APPLY` command provides the most straightforward method to program the function generator, the low-level commands give you more flexibility to change individual parameters.

FUNCTION {`SINusoid` | `SQUare` | `RAMP` | `PULSe` | `NOISe` | `DC` | `USER` }
FUNCTION?

Select the output function. The selected waveform is output using the previously selected frequency, amplitude, and offset voltage settings. The `FUNC?` query returns “SIN”, “SQU”, “RAMP”, “PULS”, “NOIS”, “DC”, or “USER”.

- If you select “USER”, the function generator outputs the arbitrary waveform currently selected by the `FUNC:USER` command.
- The table below shows which output functions are allowed with modulation, sweep, and burst. Each “•” indicates a valid combination. If you change to a function that is not allowed with modulation, sweep, or burst, the modulation or mode is turned off.

	Sine	Square	Ramp	Pulse	Noise	DC	User
AM, FM, PM, FSK Carrier	•	•	•				•
PWM Carrier				•			
Sweep Mode	•	•	•				•
Burst Mode	•	•	•	•	• ¹		•

¹ Allowed in the External Gated burst mode only.

- *Function Limitations:* If you change to a function whose maximum frequency is less than that of the current function, the frequency is adjusted to the maximum value for the new function. For example, if you are currently outputting a 20 MHz sine wave and then change to the ramp function, the function generator will automatically adjust the output frequency to 200 kHz (the upper limit for ramps). *From the remote interface, a “Settings conflict” error will be generated and the frequency will be adjusted as described.*
- *Amplitude Limitations:* If you change to a function whose maximum amplitude is less than that of the current function, the amplitude is automatically adjusted to the maximum value for the new function. This may occur when the output units are *Vrms* or *dBm* due to the differences in crest factor for the various output functions.

For example, if you output a 5 *Vrms* square wave (into 50 ohms) and then change to the sine wave function, the function generator will automatically adjust the output amplitude to 3.536 *Vrms* (the upper limit for sine in *Vrms*). *From the remote interface, a “Settings conflict” error will be generated and the amplitude will be adjusted as described.*

Chapter 4 Remote Interface Reference

Output Configuration Commands

FREQuency {<frequency> | **MIN**imum | **MAX**imum}
FREQuency? [**MIN**imum | **MAX**imum]

Set the output frequency. MIN selects the lowest frequency allowed for the selected function and MAX selects the highest frequency allowed. The default is 1 kHz for all functions. The **FREQ?** query returns the frequency setting in hertz for the function currently selected.

Function	Minimum Frequency	Maximum Frequency
Sine	1 μ Hz	20 MHz
Square	1 μ Hz	20 MHz
Ramp	1 μ Hz	200 kHz
Pulse	500 μ Hz	5 MHz
Noise, DC	Not Applicable	Not Applicable
Arbs	1 μ Hz	6 MHz

- *Function Limitations:* The frequency limits are function dependent, as shown in the above table. If you send a command specifying a frequency that is not in the appropriate range for the current function, an error will occur. For example, if the current function is “ramp” and you send the command **FREQ 20 MHz**, a “Data out of range” error is generated and the frequency is set to 200 kHz, which is the maximum for a ramp waveform.
- *Duty Cycle Limitations:* For square waveforms, the function generator may not be able to use the full range of duty cycle values at higher frequencies as shown below.

20% to 80% (*frequency* \leq 10 MHz)
40% to 60% (*frequency* $>$ 10 MHz)

If you change to a frequency that cannot produce the current duty cycle, the duty cycle is automatically adjusted to the maximum value for the new frequency. For example, if you currently have the duty cycle set to 70% and then change the frequency to 12 MHz, the function generator will automatically adjust the duty cycle to 60% (the upper limit for this frequency). *From the remote interface, a “Settings conflict” error will be generated and the duty cycle will be adjusted as described.*

VOLTage { <amplitude> | MINimum | MAXimum }
VOLTage? [MINimum | MAXimum]

Set the output amplitude. The default amplitude is 100 mVpp (into 50Ω) for all functions. MIN selects the smallest amplitude (1 mVpp into 50Ω). MAX selects the largest amplitude for the selected function (at most 10 Vpp into 50Ω depending on the selected function and offset voltage). The VOLT? query returns the output amplitude for the function currently selected. Values are always returned in the units set by the most recent VOLT:UNIT command.

- *Offset Voltage Limitations:* The output amplitude and offset are related to V_{max} as shown below.

$$|V_{offset}| + V_{pp} \div 2 \leq V_{max}$$

where V_{max} is the maximum *peak voltage* for the selected output termination (5 volts for a 50Ω load or 10 volts for a high-impedance load). The new amplitude specified in the VOLT command will be set, *but the offset voltage may be reduced accordingly, and a “Settings conflict” error generated.*

- *Limits Due to Output Termination:* If you change the output termination setting, the displayed output amplitude will be automatically adjusted (and no error will be generated). For example, if you set the amplitude to 10 Vpp and then change the output termination from 50 ohms to “high impedance”, the amplitude displayed on the function generator’s front-panel will *double* to 20 Vpp. If you change from “high impedance” to 50 ohms, the displayed amplitude will drop in half. *For more information, see the OUTP:LOAD command on page 182.*
- You can set the output amplitude in Vpp, Vrms, or dBm by specifying the units as part of the VOLT command as shown below.

VOLT 3.0 VRMS

Or, you can use the VOLT:UNIT command (see page 184) to specify the output units for all commands that follow.

- You cannot specify the output amplitude in dBm if the output termination is currently set to “high impedance”. The units are automatically converted to Vpp. *See the VOLT:UNIT command on page 184 for more information.*

Output Configuration Commands

- *Limits Due to Units Selection:* In some cases, the amplitude limits are determined by the output units selected. This may occur when the units are *Vrms* or *dBm* due to the differences in crest factor for the various output functions. For example, if you output a 5 *Vrms* square wave (into 50 ohms) and then change to the sine wave function, the function generator will automatically adjust the output amplitude to 3.536 *Vrms* (the upper limit for sine waves in *Vrms*). *From the remote interface, a "Settings conflict" error will be generated and the amplitude will be adjusted as described.*
- *Arbitrary Waveform Limitations:* For arbitrary waveforms, the maximum amplitude will be limited if the waveform data points do not span the full range of the output DAC (Digital- to-Analog Converter). For example, the built-in "Sinc" waveform does not use the full range of values between ± 1 and therefore its maximum amplitude is limited to 6.087 *Vpp* (into 50 ohms).
- While changing amplitude, you may notice a momentary disruption in the output waveform at certain voltages due to switching of the output attenuators. The amplitude is controlled, however, so the output voltage will never exceed the current setting while switching ranges. To prevent this disruption in the output, you can disable the voltage autoranging feature using the `VOLT:RANG:AUTO` command (see page 179 for more information).
- You can also set the amplitude (with an associated offset voltage) by specifying a high level and low level. For example, if you set the high level to +2 volts and the low level to -3 volts, the resulting amplitude is 5 *Vpp* (with an associated offset voltage of -500 mV). *See the VOLT:HIGH and VOLT:LOW commands on page 178 for more information.*
- To output a *dc voltage level*, select the dc voltage function using the `FUNCDC` command and then set the offset voltage level using the `VOLT:OFFS` command. You can set the dc level to any value between ± 5 *Vdc* into 50 ohms or ± 10 *Vdc* into an open circuit.

4



```
VOLTage:OFFSet { <offset> | MINimum | MAXimum }  
VOLTage:OFFSet? [MINimum | MAXimum]
```

Set the dc offset voltage. The default offset is 0 volts for all functions. MIN selects the most negative dc offset voltage for the selected function and amplitude. MAX selects the largest dc offset for the selected function and amplitude. The :OFFSet? query returns the offset voltage for the function currently selected.

- *Limits Due to Amplitude:* The output amplitude and offset are related to V_{max} as shown below.

$$|V_{offset}| + V_{pp} \div 2 \leq V_{max}$$

where V_{max} is the maximum *peak voltage* for the selected output termination (5 volts for a 50Ω load or 10 volts for a high-impedance load). The new offset specified in the VOLT:OFFSet command will be set, *but the amplitude may be reduced accordingly, and a “Settings conflict” error generated.*

- *Limits Due to Output Termination:* The offset limits are determined by the current output termination setting. For example, if you set the offset to 100 mVdc and then change the output termination from 50 ohms to “high impedance”, the offset voltage displayed on the function generator’s front-panel will *double* to 200 mVdc (and no error will be generated). If you change from “high impedance” to 50 ohms, the displayed offset will drop in half. *See the OUTP:LOAD command on page 182 for more information.*
- *Arbitrary Waveform Limitations:* For arbitrary waveforms, the maximum offset and amplitude will be limited if the waveform data points do not span the full range of the output DAC (Digital-to-Analog Converter). For example, the built-in “Sinc” waveform does not use the full range of values between ±1 and therefore its maximum offset is limited to 4.95 volts (into 50 ohms).

Chapter 4 Remote Interface Reference
Output Configuration Commands

- You can also set the offset by specifying a high level and low level. For example, if you set the high level to +2 volts and the low level to -3 volts, the resulting amplitude is 5 Vpp (with an associated offset voltage of -500 mV). See the VOLT:HIGH and VOLT:LOW commands below for more information.
- To output a dc voltage level, select the dc voltage function using the FUNCDC command and then set the offset voltage level using the VOLT:OFFS command. You can set the dc level to any value between ±5 Vdc into 50 ohms or ±10 Vdc into an open circuit.

VOLTage

:HIGH {<voltage> | MINimum | MAXimum}
:HIGH? [MINimum | MAXimum]
:LOW {<voltage> | MINimum | MAXimum}
:LOW? [MINimum | MAXimum]

Set the high or low voltage levels. For all functions, the default *high level* is +50 mV and the default *low level* is -50 mV. MIN selects the most negative voltage level for the selected function and MAX selects the largest voltage level. The :HIGH? and :LOW? queries return the high and low levels, respectively.

- *Limits Due to Amplitude:* You can set the voltage levels to a positive or negative value with the restrictions shown below. Vpp is the maximum peak-to-peak amplitude for the selected output termination (10 Vpp for a 50-ohm load or 20 Vpp for a high-impedance load).

$$V_{high} - V_{low} \leq V_{pp}(\max) \quad \text{and} \quad V_{high}, V_{low} \leq \frac{V_{pp}(\max)}{2}$$

If the specified level is not valid, the function generator will automatically adjust it to the maximum voltage allowed. From the remote interface, a "Data out of range" error will be generated and the level will be adjusted as described.

- You can set the levels to a positive or negative value, but note that the high level *must* always be greater than the low level. If you specify a low level that is greater than the high level, the function generator will automatically set the high level to be 1 mV more than the new low level. A "Settings conflict" error will be generated.

- Note that when you set the high and low levels, you are also setting the amplitude of the waveform. For example, if you set the high level to +2 volts and the low level to -3 volts, the resulting amplitude is 5 Vpp (with an offset voltage of -500 mV).
- *Limits Due to Output Termination:* If you change the output termination setting, the displayed voltage levels will be automatically adjusted (and no error will be generated). For example, if you set the high level to +100 mVdc and then change the output termination from 50 ohms to “high impedance”, the voltage displayed on the function generator’s front-panel will *double* to +200 mVdc. If you change from “high impedance” to 50 ohms, the displayed voltage will drop in half. *See the OUTP:LOAD command on page 182 for more information.*
- To invert the waveform relative to the offset voltage, you can use the OUTP:POL command. *See page 183 for more information.*

VOLTage:RANGe:AUTO {OFF|ON|ONCE}
VOLTage:RANGe:AUTO?

Disable or enable voltage autoranging for all functions. In the default mode, autoranging is enabled (“ON”) and the function generator automatically selects the optimal settings for the output amplifier and attenuators. With autoranging disabled (“OFF”), the function generator uses the current amplifier and attenuator settings. The :AUTO? query returns “0” (OFF) or “1” (ON).

- The APPLY command overrides the voltage autorange setting and automatically enables autoranging (“ON”).
- The advantage of disabling autoranging is to eliminate momentary disruptions caused by switching of the attenuators while changing amplitude. However, the amplitude and offset accuracy and resolution (as well as waveform fidelity) may be adversely affected when reducing the amplitude below the expected range change.
- The “ONCE” parameter has the same effect as turning autoranging “ON”, and then “OFF”. This parameter allows you to make a one-time change to the amplifier/attenuator setting before returning to the VOLT:RANG:AUTO OFF setting.

Chapter 4 Remote Interface Reference
Output Configuration Commands

FUNCTION:SQUare:DCYCLE {<percent> | MINimum | MAXimum}
FUNCTION:SQUare:DCYCLE? [MINimum | MAXimum]

Set the duty cycle percentage for *square waves*. Duty cycle represents the amount of time per cycle that the square wave is at a *high level* (assuming that the waveform polarity is not inverted). The default is 50%. MIN selects the minimum duty cycle for the selected frequency and MAX selects the maximum duty cycle (see restrictions below). The :DCYC? query returns the current duty cycle setting in percent.

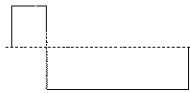

20% Duty Cycle



80% Duty Cycle

- Duty Cycle: 20% to 80% (*frequency* ≤ 10 MHz)
40% to 60% (*frequency* > 10 MHz)
- For square waveforms, the APPLY command overrides the current duty cycle setting and automatically selects 50%.
- The duty cycle setting is remembered when you change from square wave to another function. When you return to the square wave function, the previous duty cycle is used.
- *Limits Due to Frequency:* If the square wave function is selected and you change to a frequency that cannot produce the current duty cycle, the duty cycle is automatically adjusted to the maximum value for the new frequency. For example, if you currently have the duty cycle set to 70% and then change the frequency to 12 MHz, the function generator will automatically adjust the duty cycle to 60% (the upper limit for this frequency). *From the remote interface, a "Settings conflict" error will be generated and the duty cycle will be adjusted as described.*
- If you select a square waveform as the *modulating* waveform for AM or FM, the duty cycle setting *does not* apply. The function generator always uses a square waveform with a 50% duty cycle.

FUNCTION:RAMP:SYMMetry {<percent>|MINimum|MAXimum}
FUNCTION:RAMP:SYMMetry? [MINimum|MAXimum]

Set the symmetry percentage for *ramp waves*. Symmetry represents the amount of time per cycle that the ramp wave is *rising* (assuming that the waveform polarity is not inverted). You can set the symmetry to any value from 0% to 100%. The default is 100%. MIN = 0%. MAX = 100%. The :SYMM? query returns the current symmetry setting in percent.

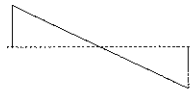

0% Symmetry



100% Symmetry

- For ramp waveforms, the **APPLY** command overrides the current symmetry setting and automatically selects 100%.
- The symmetry setting is remembered when you change from ramp wave to another function. When you return to the ramp wave function, the previous symmetry is used.
- If you select a ramp waveform as the *modulating* waveform for AM or FM, the symmetry setting *does not* apply.

OUTPut {OFF|ON}
OUTPut?

Disable or enable the front-panel *Output* connector. The default is “OFF”. When the output is enabled, the  key is illuminated on the function generator’s front panel. The **OUTP?** query returns “0” (OFF) or “1” (ON).

- The **APPLY** command overrides the current **OUTP** command setting and automatically enables the *Output* connector (“ON”).
- If an excessive external voltage is applied to the front-panel *Output* connector, an error message will be displayed and the output will be disabled. To re-enable the output, remove the overload from the *Output* connector and send the **OUTP ON** command.

Chapter 4 Remote Interface Reference
Output Configuration Commands

```
OUTPut:LOAD {<ohms>|INFinity|MINimum|MAXimum}  
OUTPut:LOAD? [MINimum|MAXimum]
```

Select the desired output termination (i.e., the impedance of the load attached to the output of the Agilent 33220A). The specified value is used for amplitude, offset, and high/low level settings. You can set the load to any value from 1 Ω to 10 k Ω . MIN selects 1 Ω . MAX selects 10 k Ω . INF sets the output termination to “high impedance” (>10 k Ω). The default is 50 Ω . The :LOAD? query returns the current load setting in ohms or “9.9E+37” (for “high impedance”).

- The Agilent 33220A has a fixed series output impedance of 50 ohms to the front-panel *Output* connector. If the actual load impedance is different than the value specified, the displayed amplitude, offset, and high/low levels will be incorrect.
- If you change the output termination setting, the displayed output amplitude, offset, and high/low levels are automatically adjusted (and no error will be generated). For example, if you set the amplitude to 10 Vpp and then change the output termination from 50 ohms to “high impedance”, the amplitude displayed on the function generator’s front-panel will *double* to 20 Vpp. If you change from “high impedance” to 50 ohms, the displayed amplitude will drop in half.
- You cannot specify the output amplitude in dBm if the output termination is currently set to “high impedance”. The units are automatically converted to Vpp. See the VOLT:UNIT command on page 184 for more information.

OUTPut:POLarity {NORMal | INVerted}
OUTPut:POLarity?

Invert the waveform relative to the offset voltage. In the *normal* mode (default), the waveform goes positive during the first part of the cycle. In the *inverted* mode, the waveform goes negative during the first part of the cycle. The `:POL?` query returns “NORM” or “INV”.

- As shown in the examples below, the waveform is inverted *relative to* the offset voltage. Any offset voltage present will remain unchanged when the waveform is inverted.

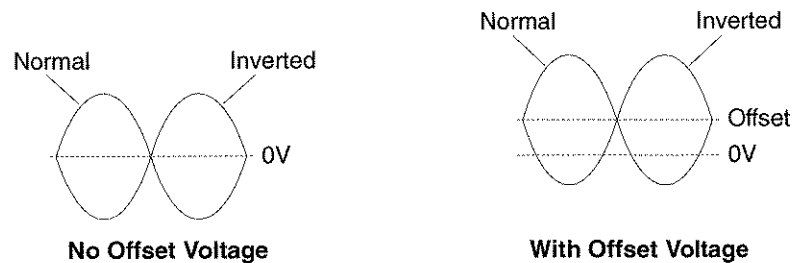

- When a waveform is inverted, the Sync signal associated with the waveform *is not* inverted.

OUTPut:SYNC {OFF | ON}
OUTPut:SYNC?

Disable or enable the front-panel *Sync* connector. At lower amplitudes, you can reduce output distortion by disabling the Sync signal. The default setting is “ON”. The `:SYNC?` query returns “0” (OFF) or “1” (ON).

- For more details on the Sync signal for each waveform function, see “Sync Output Signal” on page 68.
- When the Sync signal is disabled, the output level on the *Sync* connector is a logic “low” level.
- When a waveform is inverted (`OUTP:POL` command), the Sync signal associated with the waveform *is not* inverted.
- The `OUTP:SYNC` command is overridden by the setting of the `MARK` command used with the sweep mode (see page 215). Therefore, when the marker frequency is enabled (and the sweep mode is also enabled), the `OUTP:SYNC` command is ignored.

Chapter 4 Remote Interface Reference
Output Configuration Commands

VOLTage:UNIT {VPP | VRMS | DBM}
VOLTage:UNIT?

Select the units for output amplitude (does not affect offset voltage or high/low levels). The default is VPP. The :UNIT? query returns “VPP”, “VRMS”, or “DBM”.

- The function generator uses the current units selection for both front panel and remote interface operations. For example, if you select “VRMS” from the remote interface using the VOLT:UNIT command, the units are displayed as “VRMS” on the front panel.
- The VOLT? query command (see page 175) returns the output amplitude in the units set by the most recent VOLT:UNIT command.
- The output units for amplitude cannot be set to dBm if the output termination is currently set to “high impedance”. The units are automatically converted to Vpp. *See the OUTP:LOAD command on page 182 for more information.*
- Unless you specify the units as part of the APPLY or VOLT command, the VOLT:UNIT command takes precedence. For example, if you select “Vrms” using the VOLT:UNIT command and *do not* include units with the APPLY or VOLT command, the value specified for the *amplitude* parameter in the APPLY command will be in “Vrms”.



Pulse Configuration Commands

See also "Pulse Waveforms" starting on page 70 in chapter 3.

This section describes the low-level commands used to program the function generator to output a pulse waveform. To select the pulse function, use the `FUNC PULS` command (see page 172). Refer to the diagram below for the command descriptions that follow.

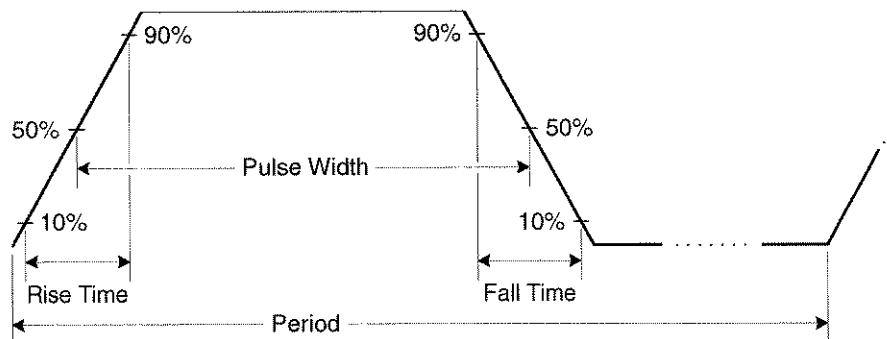

4

```
PULSe:PERiod { <seconds> | MINimum | MAXimum }
PULSe:PERiod? [ MINimum | MAXimum ]
```

Set the period for pulses. Select a period from 200 ns to 2000 seconds. The default is 1 ms. MIN = 200 ns. MAX = 2000 seconds. The `PULS:PER?` query returns the period of the pulse waveform in seconds.

- The specified period must be greater than the sum of the *pulse width* and the *edge time*. The function generator will adjust the edge time and the pulse width as needed to accommodate the specified period. *From the remote interface, a "Settings conflict" error will be generated. The edge time is minimized first, and then the width (or duty cycle) is adjusted as shown below.*

$$\text{Period} \geq \text{Pulse Width} + (1.6 \times \text{Edge Time})$$

or in terms of pulse duty cycle:

$$\text{Period} \geq (\text{Period} \times \text{Duty Cycle} \div 100) + (1.6 \times \text{Edge Time})$$

Pulse Configuration Commands

- This command affects the period (and frequency) for *all* waveform functions (not just pulse). For example, if you select a period using the `PULS:PER` command and then change the function to sine wave, the specified period will be used for the new function.
- *Function Limitations:* If you change to a function whose minimum period is greater than that for a pulse waveform, the period is adjusted to the minimum value allowed for the new function. For example, if you output a pulse waveform with a period of 200 ns and then change to the ramp function, the function generator will automatically adjust the period to 5 μ s (the lower limit for ramps). *From the remote interface, a "Settings conflict" error will be generated and the period will be adjusted as described.*

FUNCTION:PULSE:HOLD {WIDTH|DCYCLE}
FUNCTION:PULSE:HOLD? [WIDTH|DCYCLE]

Set the function generator to hold either pulse width or pulse duty cycle:

- **WIDTH:** The function generator holds the pulse width setting (in seconds) constant as the period is varied. (Minimum width and edge time restrictions apply.) If a command to set a duty cycle value is received, the duty cycle is converted to the equivalent pulse width in seconds. If Pulse Width Modulation (PWM) is turned on, the pulse width is held, and the width deviation also is held, as the period is varied. Duty cycle deviation commands are converted to width deviation values.
- **DCYCLE:** The function generator holds the pulse duty cycle setting (in percent) constant as the period is varied. (Minimum width and edge time restrictions apply.) If a command to set a pulse width value is received, the width is converted to the equivalent duty cycle in percent. If Pulse Width Modulation (PWM) is turned on, the pulse duty cycle is held, and the duty cycle deviation also is held, as the period is varied. Width deviation commands are converted to duty cycle deviation values.

Note: *The `FUNC:PULS:HOLD` command does **not** limit **period** settings. The pulse width or duty cycle are adjusted if necessary to accommodate a new period setting.*

*This command will cause the **Width/Dty Cyc** softkey in the pulse menu to toggle its sense when appropriate. Also, changing the **Width/Dty Cyc** softkey from the front panel will change the `HOLD` selection for subsequent programmatic behavior.*

FUNCTION:PULSE:WIDTH {<seconds>|**MINimum**|**MAXimum**}
FUNCTION:PULSE:WIDTH? [**MINimum**|**MAXimum**]

Set the pulse width in seconds. The pulse width represents the time from the 50% threshold of the rising edge of the pulse to the 50% threshold of the next falling edge. You can vary the pulse width from 20 ns to 2000 seconds (*see restrictions below*). The default pulse width is 100 μ s. MIN = 20 ns. MAX = 1999.99 seconds. The :WIDTh? query returns the pulse width in seconds.

- The *minimum pulse width* (Wmin) is affected by the period.

Wmin = 20 ns for period \leq 10 s.

Wmin = 200 ns for period > 10 s, but \leq 100 s.

Wmin = 2 μ s for period > 100 s, but \leq 1000 s.

Wmin = 20 μ s for period > 1000 s.

- The specified pulse width must also be less than the difference between the *period* and the *minimum pulse width as shown below*. The function generator will adjust the pulse edge time and then the pulse width as needed to accommodate the specified period. *From the remote interface, a “Settings conflict” error will be generated and the pulse width will be adjusted as described.*

$$\text{Pulse Width} \leq \text{Period} - \text{Wmin}$$

- The specified pulse width must be less than the difference between the *period* and the *edge time* as shown below. The function generator will limit the pulse edge time first, and then the pulse width as needed to accommodate the specified period. *From the remote interface, a “Data out of range” error will be generated and the pulse width will be limited as described.*

$$\text{Pulse Width} \leq \text{Period} - (1.6 \times \text{Edge Time})$$

- The pulse width must also be greater than the total time of one edge as shown below.

$$\text{Pulse Width} \geq 1.6 \times \text{Edge Time}$$

Note: *This function is affected by the FUNC:PULS:HOLD command, which determines the value to be held constant as the period is adjusted: the specified **pulse width** value, or the specified **pulse duty cycle** value. See the FUNC:PULS:HOLD command for further information.*

Pulse Configuration Commands

FUNCTION:PULSE:DCYCLE {<percent>|**MINimum**|**MAXimum**}

FUNCTION:PULSE:DCYCLE? [**MINimum**|**MAXimum**]

Set the pulse duty cycle in percent. The the pulse duty cycle is defined as:

$$\text{Duty Cycle} = 100 \times \text{Pulse Width} \div \text{Period}$$

where the pulse width represents the time from the 50% threshold of the rising edge of the pulse to the 50% threshold of the next falling edge.

The pulse duty cycle range is 0 percent to 100 percent. However, the pulse duty cycle is limited by minimum pulse width and edge time restrictions, which prevent you from setting exactly 0 percent or 100 percent. For example, for a 1 kHz pulse waveform, you are typically restricted to pulse duty cycles in the range 0.002 percent to 99.998 percent, limited by the minimum pulse width of 20 ns.

The default pulse duty cycle is 10 percent. MIN is approximately 0%. MAX is approximately 100%. The :DCYC? query returns the pulse duty cycle in percent. *The width and edge restrictions are described below:*

- The specified pulse duty cycle must conform to the following restrictions determined by the *minimum pulse width* (Wmin). The function generator will adjust the pulse duty cycle as needed to accommodate the specified period. *From the remote interface, a "Data out of range" error will be generated and the duty cycle will be adjusted as described.*

$$\text{Duty Cycle} \geq 100 \times W_{\text{min}} \div \text{Period}$$

and

$$\text{Duty Cycle} \leq 100 \times (1 - W_{\text{min}} \div \text{Period})$$

where:

$$W_{\text{min}} = 20 \text{ ns for period } \leq 10 \text{ s.}$$

$$W_{\text{min}} = 200 \text{ ns for period } > 10 \text{ s, but } \leq 100 \text{ s.}$$

$$W_{\text{min}} = 2 \text{ } \mu\text{s for period } > 100 \text{ s, but } \leq 1000 \text{ s.}$$

$$W_{\text{min}} = 20 \text{ } \mu\text{s for period } > 1000 \text{ s.}$$

- The specified pulse duty cycle may affect the edge time. The edge time is adjusted first, and then the duty cycle to accommodate the specified period, conforming to the following restriction. *From the remote interface, a “Data out of range” error will be generated and the edge time and duty cycle will be limited as described.*

$$\text{Duty Cycle} \geq 100 \times (1.6 \times \text{Edge Time}) \div \text{Period}$$

and

$$\text{Duty Cycle} \leq 100 \times (1 - (1.6 \times \text{Edge Time}) \div \text{Period})$$

Note: *This command is affected by the FUNC:PULS:HOLD command, which determines the value to be held constant as the period is adjusted: the specified **pulse width** value, or the specified **pulse duty cycle** value. See the FUNC:PULS:HOLD command for further information.*

FUNCTION:PULSe:TRANsition { <percent> | MINimum | MAXimum }
 FUNCTION:PULSe:TRANsition? [MINimum | MAXimum]

Set the edge time in seconds for *both* the rising and falling edges. The edge time represents the time from the 10% threshold to the 90% threshold of each edge. You can vary the edge time from 5 ns to 100 ns (see restrictions below). The default edge time is 5 ns. MIN = 5 ns. MAX = 100 ns. The :TRAN? query returns the edge time in seconds.

- The specified edge time must fit within the specified pulse width as shown below. The function generator will limit the edge time as needed to accommodate the specified pulse width or duty cycle. *From the remote interface, a “Settings Conflict” error will be generated and the edge time will be limited as described.*

$$\text{Edge Time} \leq 0.625 \times \text{Pulse Width}$$

or in terms of duty cycle:

$$\text{Edge Time} \leq 0.625 \times \text{Period} \times \text{Duty Cycle} \div 100$$

Amplitude Modulation (AM) Commands

See also “Amplitude Modulation” starting on page 74 in chapter 3.

AM Overview

The following is an overview of the steps required to generate an AM waveform. The commands used for AM are listed on the next page.

1 Configure the carrier waveform.

Use the `APPLY` command or the equivalent `FUNC`, `FREQ`, `VOLT`, and `VOLT:OFFS` commands to select the function, frequency, amplitude, and offset of the carrier waveform. You can select a sine, square, ramp, or arbitrary waveform for the carrier (pulse, noise, and dc are not allowed).

2 Select the modulation source.

The function generator will accept an internal or external modulation source. Select the modulation source using the `AM:SOUR` command.
For an external source, you can skip steps 3 and 4 below.

3 Select the shape of the modulating waveform.

You can modulate the carrier with a sine, square, ramp, noise, or arbitrary waveform (pulse and dc are not allowed). Use the `AM:INT:FUNC` command to select the modulating waveshape.

4 Set the modulating frequency.

Set the modulating frequency to any value from 2 mHz to 20 kHz using the `AM:INT:FREQ` command.

5 Set the modulation depth.

Set the modulation depth (also called “percent modulation”) to any value from 0% to 120% using the `AM:DEPT` command.

6 Enable AM modulation.

After you have set up the other modulation parameters, use the `AM:STAT ON` command to enable AM.

AM Commands

Use the APPLY command or the equivalent FUNC, FREQ, VOLT, and VOLT:OFFS commands to configure the carrier waveform.





AM:SOURce {INTernal|EXTernal}
AM:SOURce?

Select the source of the modulating signal. The function generator will accept an internal or external modulation source. The default is INT. The :SOUR? query returns "INT" or "EXT".

- If you select the *External* source, the carrier waveform is modulated with an external waveform. The modulation depth is controlled by the $\pm 5V$ signal level present on the rear-panel *Modulation In* connector. For example, if you have set the modulation depth to 100% using the AM:DEPT command, then when the modulating signal is at +5 volts, the output will be at the *maximum* amplitude. When the modulating signal is at -5 volts, then the output will be at the *minimum* amplitude.

AM:INTernal
:FUNCTION {SINusoid|SQUare|RAMP|NRAMp|TRIangle|NOISe|USER}
:FUNCTION?

Select the shape of the *modulating* waveform. Used only when the *Internal* modulation source is selected (AM:SOUR INT command). You can use noise as the modulating waveshape, but you *cannot* use noise, pulse, or dc as the carrier waveform. The default is SIN. The :FUNC? query returns "SIN", "SQU", "RAMP", "NRAM", "TRI", "NOIS", or "USER".

- Select "SQU" for a square waveform with a 50% duty cycle. 
- Select "RAMP" for a ramp waveform with 100% symmetry. 
- Select "TRI" for a ramp waveform with 50% symmetry. 
- Select "NRAM" (negative ramp) for a ramp waveform with 0% symmetry. 
- If you select an arbitrary waveform as the *modulating* waveshape ("USER"), the waveform is automatically limited to 4K points. Extra waveform points are removed using decimation.

Chapter 4 Remote Interface Reference
Amplitude Modulation (AM) Commands

AM:INTernal:FREQuency { <frequency> | MINimum | MAXimum }
AM:INTernal:FREQuency? [MINimum | MAXimum]

Set the frequency of the *modulating* waveform. Used only when the *Internal* modulation source is selected (AM:SOUR INT command). Select from 2 mHz to 20 kHz. The default is 100 Hz. MIN = 2 mHz. MAX = 20 kHz. The :FREQ? query returns the internal modulating frequency in hertz.

AM:DEPTh { <depth in percent> | MINimum | MAXimum }
AM:DEPTh? [MINimum | MAXimum]

Set the internal modulation depth (or “percent modulation”) in percent. Select from 0% to 120%. The default is 100%. MIN = 0%. MAX = 120%. The :DEPT? query returns the modulation depth in percent.

- Note that even at greater than 100% depth, the function generator will not exceed $\pm 5V$ peak on the output (into a 50Ω load).
- If you select the *External* modulating source (AM:SOUR EXT command), the carrier waveform is modulated with an external waveform. The modulation depth is controlled by the $\pm 5V$ signal level present on the rear-panel *Modulation In* connector. For example, if you have set the modulation depth to 100% using the AM:DEPT command, then when the modulating signal is at +5 volts, the output will be at the *maximum* amplitude. When the modulating signal is at -5 volts, then the output will be at the *minimum* amplitude.

AM:STATe { OFF | ON }
AM:STATe?

Disable or enable AM. To avoid multiple waveform changes, you can enable AM *after* you have set up the other modulation parameters. The default is OFF. The :STAT? query returns “0” (OFF) or “1” (ON).

- The function generator will allow only one modulation mode to be enabled at a time. For example, you cannot enable AM and FM at the same time. When you enable AM, the previous modulation mode is turned off.
- The function generator will not allow AM to be enabled at the same time that sweep or burst is enabled. When you enable AM, the sweep or burst mode is turned off.

Frequency Modulation (FM) Commands

See also “Frequency Modulation” starting on page 79 in chapter 3.

FM Overview

The following is an overview of the steps required to generate an FM waveform. The commands used for FM are listed on the next page.

1 Configure the carrier waveform.

Use the APPLY command or the equivalent FUNC, FREQ, VOLT, and VOLT:OFFS commands to select the function, frequency, amplitude, and offset of the carrier waveform. You can select a sine, square, ramp, or arbitrary waveform for the carrier (pulse, noise, and dc are not allowed).

2 Select the modulation source.

The function generator will accept an internal or external modulation source. Select the modulation source using the FM:SOUR command.
For an external source, you can skip steps 3 and 4 below.

3 Select the shape of the modulating waveform.

You can modulate the carrier with a sine, square, ramp, noise, or arbitrary waveform (pulse and dc are not allowed). Use the FM:INT:FUNC command to select the modulating waveshape.

4 Set the modulating frequency.

Set the modulating frequency to any value from 2 mHz to 20 kHz using the FM:INT:FREQ command.

5 Set the peak frequency deviation.

Set the frequency deviation to any value from 1 μ Hz to 10.05 MHz (limited to 150 kHz for ramps and 3.05 MHz for arbitrary waveforms) using the FM:DEV command.

6 Enable FM modulation.

After you have set up the other modulation parameters, use the FM:STAT ON command to enable FM.

FM Commands

Use the APPLy command or the equivalent FUNC, FREQ, VOLT, and VOLT:OFFS commands to configure the carrier waveform.





FM:SOURce { INTernal | EXTernal }
FM:SOURce?

Select the source of the modulating signal. The function generator will accept an internal or external modulation source. The default is INT. The :SOUR? query returns "INT" or "EXT".

- If you select the *External* source, the carrier waveform is modulated with an external waveform. The frequency deviation is controlled by the $\pm 5V$ signal level present on the rear-panel *Modulation In* connector. For example, if you have set the deviation to 100 kHz using the FM:DEV command, then a +5V signal level corresponds to a 100 kHz increase in frequency. Lower external signal levels produce less deviation and negative signal levels reduce the frequency below the carrier frequency.

FM:INTernal
:FUNction { SINusoid | SQUare | RAMP | NRAMp | TRIangle | NOISe | USER }
:FUNction?

Select the shape of the *modulating* waveform. Used only when the *Internal* modulation source is selected (FM:SOUR INT command). You can use noise as the modulating waveshape, but you *cannot* use noise, pulse, or dc as the carrier waveform. The default is SIN. The :FUNC? query returns "SIN", "SQU", "RAMP", "NRAMP", "TRI", "NOIS", or "USER".

- Select "SQU" for a square waveform with a *50% duty cycle*. 
- Select "RAMP" for a ramp waveform with *100% symmetry*. 
- Select "TRI" for a ramp waveform with *50% symmetry*. 
- Select "NRAMP" (negative ramp) for a ramp waveform with *0% symmetry*. 
- If you select an arbitrary waveform as the *modulating* waveshape ("USER"), the waveform is automatically limited to 4K points. Extra waveform points are removed using decimation.

Chapter 4 Remote Interface Reference
Frequency Modulation (FM) Commands

FM:INTernal:FREQUENCY { <frequency> | MINimum | MAXimum }
FM:INTernal:FREQUENCY? [MINimum | MAXimum]

Set the frequency of the *modulating* waveform. Used only when the *Internal* modulation source is selected (FM: SOUR INT command). Select from 2 mHz to 20 kHz. The default is 10 Hz. MIN = 2 mHz. MAX = 20 kHz. The :FREQ? query returns the internal modulating frequency in hertz.

FM:DEVIation { <peak deviation in Hz> | MINimum | MAXimum }
FM:DEVIation? [MINimum | MAXimum]

Set the peak frequency deviation in hertz. This value represents the peak variation in frequency of the *modulated* waveform from the carrier frequency. Select any value from 1 μ Hz to 10.05 MHz (limited to 150 kHz for ramps and 3.05 MHz for arbitrary waveforms). The default is 100 Hz. MIN = 1 μ Hz. MAX = based on the frequency of the carrier waveform as shown below. The :DEV? query returns the deviation in hertz.

$$\text{Max. Deviation} = \frac{\text{Carrier}}{2} \quad \text{For Carrier} < 10 \text{ MHz}$$

$$\text{Max. Deviation} = \frac{\text{Max. Frequency} - \text{Carrier}}{2} \quad \text{For Carrier} > 10 \text{ MHz}$$

- The *carrier frequency* must always be greater than or equal to the deviation. If you attempt to set the deviation to a value greater than the carrier frequency (with FM enabled), the function generator will automatically adjust the deviation to the maximum value allowed with the present carrier frequency. *From the remote interface, a "Data out of range" error will be generated and the deviation will be adjusted as described.*
- The sum of the *carrier frequency* and deviation must be less than or equal to the maximum frequency for the selected function **plus 100 kHz** (20.1 MHz for sine and square, 300 kHz for ramp, and 6.1 MHz for arbitrary waveforms). If you attempt to set the deviation to a value that is not valid, the function generator will automatically adjust it to the maximum value allowed with the present carrier frequency. *From the remote interface, a "Data out of range" error will be generated and the deviation will be adjusted as described.*

Chapter 4 Remote Interface Reference
Frequency Modulation (FM) Commands

- If the deviation causes the carrier waveform to exceed a frequency boundary for the current duty cycle (square waveform only), the function generator will automatically adjust the duty cycle to the maximum value allowed with the present carrier frequency. *From the remote interface, a “Settings conflict” error will be generated and the duty cycle will be adjusted as described.*
- If you select the *External* modulating source (FM: SOUR EXT command), the deviation is controlled by the $\pm 5V$ signal level present on the rear-panel *Modulation In* connector. For example, if you have set the frequency deviation to 100 kHz, then a +5V signal level corresponds to a 100 kHz increase in frequency. Lower external signal levels produce less deviation and negative signal levels reduce the frequency below the carrier frequency.

FM: STATE {OFF | ON}

FM: STATE?

Disable or enable FM. To avoid multiple waveform changes, you can enable FM *after* you have set up the other modulation parameters. The default is OFF. The :STAT? query returns “0” (OFF) or “1” (ON).

- The function generator will allow only one modulation mode to be enabled at a time. For example, you cannot enable FM and AM at the same time. When you enable FM, the previous modulation mode is turned off.
- The function generator will not allow FM to be enabled at the same time that sweep or burst is enabled. When you enable FM, the sweep or burst mode is turned off.

Phase Modulation (PM) Commands

See also "Phase Modulation" in chapter 3.

PM Overview

The following is an overview of the steps required to generate a PM waveform. The commands used for PM are listed on the next page.

1 Configure the carrier waveform.

Use the `APPLY` command or the equivalent `FUNC`, `FREQ`, `VOLT`, and `VOLT:OFFS` commands to select the function, frequency, amplitude, and offset of the carrier waveform. You can select a sine, square, ramp, or arbitrary waveform for the carrier (pulse, noise, and dc are not allowed).

2 Select the modulation source.

The function generator will accept an internal or external modulation source. Select the modulation source using the `PM:SOUR` command. *For an external source, you can skip steps 3 and 4 below.*

3 Select the shape of the modulating waveform.

You can modulate the carrier with a sine, square, ramp, noise, or arbitrary waveform (pulse and dc are not allowed). Use the `PM:INT:FUNC` command to select the modulating waveshape.

4 Set the modulating frequency.

Set the modulating frequency to any value from 2 mHz to 20 kHz using the `PM:INT:FREQ` command.

5 Set the phase deviation.

Set the phase deviation to any value from 0 to 360 degrees using the `PM:DEV` command.

6 Enable PM modulation.

After you have set up the other modulation parameters, use the `PM:STAT ON` command to enable PM.

PM Commands

Use the APPLy command or the equivalent FUNC, FREQ, VOLT, and VOLT:OFFS commands to configure the carrier waveform.





PM:SOURce {INTernal|EXTernal}
PM:SOURce?

Select the source of the modulating signal. The function generator will accept an internal or external modulation source. The default is INT. The :SOUR? query returns "INT" or "EXT".

- If you select the *External* source, the carrier waveform is modulated with an external waveform. The phase deviation is controlled by the $\pm 5V$ signal level present on the rear-panel *Modulation In* connector. For example, if you have set the phase deviation to 180 degrees using the PM:DEV command, then a +5V signal level corresponds to a 180 degree phase deviation. Lower external signal levels produce less deviation, and negative signal levels produce a negative phase shift.

PM:INTernal
:FUNction {SINusoid|SQUare|RAMP|NRAMP|TRIangle|NOISE|USER}
:FUNction?

Select the shape of the *modulating* waveform. Used only when the *Internal* modulation source is selected (PM:SOUR INT command). You can use noise as the modulating waveshape, but you *cannot* use noise, pulse, or dc as the carrier waveform. The default is SIN. The :FUNC? query returns "SIN", "SQU", "RAMP", "NRAMP", "TRI", "NOIS", or "USER".

- Select "SQU" for a square waveform with a 50% duty cycle. 
- Select "RAMP" for a ramp waveform with 100% symmetry. 
- Select "TRI" for a ramp waveform with 50% symmetry. 
- Select "NRAMP" (negative ramp) for a ramp waveform with 0% symmetry. 
- If you select an arbitrary waveform as the *modulating* waveshape ("USER"), the waveform is automatically limited to 4K points. Extra waveform points are removed using decimation.

PM:INTernal:FREQuency {<frequency> | MINimum | MAXimum}
PM:INTernal:FREQuency? [MINimum | MAXimum]

Set the frequency of the *modulating* waveform. Used only when the *Internal* modulation source is selected (PM:SOUR INT command). Select from 2 mHz to 20 kHz. The default is 10 Hz. MIN = 2 mHz. MAX = 20 kHz. The :FREQ? query returns the internal modulating frequency in hertz.

PM:DEVIation {<deviation in degrees> | MINimum | MAXimum}
PM:DEVIation? [MINimum | MAXimum]

Set the phase deviation in degrees. This value represents the peak variation in phase of the *modulated* waveform from the carrier waveform. Select any value from 0 to 360 degrees. The default is 180 degrees. MIN = 0 degrees. MAX = 360 degrees. The :DEV? query returns the phase deviation in degrees.

- If you select the *External* modulating source (PM:SOUR EXT command), the deviation is controlled by the $\pm 5V$ signal level present on the rear-panel *Modulation In* connector. For example, if you have set the frequency deviation to 180 degrees, then a +5V signal level corresponds to a 180 degree phase deviation. Lower external signal levels produce less deviation, and negative signal levels produce a negative phase shift.

PM:STATe {OFF | ON}
PM:STATe?

Disable or enable PM. To avoid multiple waveform changes, you can enable PM *after* you have set up the other modulation parameters. The default is OFF. The :STAT? query returns "0" (OFF) or "1" (ON).

- The function generator will allow only one modulation mode to be enabled at a time. For example, you cannot enable PM and AM at the same time. When you enable PM, the previous modulation mode is turned off.
- The function generator will not allow PM to be enabled at the same time that sweep or burst is enabled. When you enable PM, the sweep or burst mode is turned off.

Frequency-Shift Keying (FSK) Commands

See also “FSK Modulation” starting on page 89 in chapter 3.

FSK Overview

The following is an overview of the steps required to generate an FSK modulated waveform. The commands used for FSK are listed on the next page.

1 Configure the carrier waveform.

Use the `APPLY` command or the equivalent `FUNC`, `FREQ`, `VOLT`, and `VOLT:OFFS` commands to select the function, frequency, amplitude, and offset of the carrier waveform. You can select a sine, square, ramp, or arbitrary waveform for the carrier (pulse, noise, and dc are not allowed).

2 Select the FSK source.

The function generator will accept an internal or external FSK source. Select the FSK source using the `FSK:SOUR` command.

3 Select the FSK “hop” frequency.

Set the alternate (or “hop”) frequency to any value from 1 μ Hz to 20 MHz (limited to 200 kHz for ramps and 6 MHz for arbitrary waveforms) using the `FSK:FREQ` command.

4 Set the FSK rate.

Set the FSK rate to any value from 2 mHz to 100 kHz using the `FSK:INT:RATE` command (internal FSK source only). The FSK rate sets the pace at which the output frequency “shifts” between the carrier frequency and the hop frequency.

5 Enable FSK modulation.

After you have set up the other FSK parameters, use the `FSK:STAT ON` command to enable FSK modulation.

FSK Commands

Use the APPLY command or the equivalent FUNC, FREQ, VOLT, and VOLT:OFFS commands to configure the carrier waveform.

FSKey:SOURCE { **INT**ernal | **EXT**ernal }

FSKey:SOURCE?

Select an internal or external FSK source. The default is INT.

The :SOUR? query returns "INT" or "EXT".

- When the *Internal* source is selected, the rate at which the output frequency "shifts" between the carrier frequency and hop frequency is determined by the *FSK rate* specified (FSK:INT:RATE command).
- When the *External* source is selected, the output frequency is determined by the signal level on the rear-panel *Trig In* connector. When a logic *low* level is present, the *carrier* frequency is output. When a logic *high* level is present, the *hop* frequency is output.
- The maximum *external* FSK rate is 1 MHz.
- Note that the connector used for externally-controlled FSK waveforms (*Trig In*) is not the same connector that is used for externally-modulated AM, FM, PM, and PWM waveforms (*Modulation In*). When used for FSK, the *Trig In* connector *does not* have adjustable edge polarity and is not affected by the TRIG:SLOP command.

Chapter 4 Remote Interface Reference
Frequency-Shift Keying (FSK) Commands

FSKey:FREquency { <frequency> | **MINimum** | **MAXimum** }
FSKey:FREquency? [**MINimum** | **MAXimum**]

Set the FSK alternate (or “hop”) frequency. Select from 1 μ Hz to 20 MHz (limited to 200 kHz for ramps and 6 MHz for arbitrary waveforms). The default is 100 Hz. MIN = 1 μ Hz. MAX = 20 MHz. The :FREQ? query returns the “hop” frequency in hertz.

FSKey:INTernal:RATE { <rate in Hz> | **MINimum** | **MAXimum** }
FSKey:INTernal:RATE? [**MINimum** | **MAXimum**]

Set the rate at which the output frequency “shifts” between the carrier and hop frequency. Select from 2 mHz to 100 kHz. The default is 10 Hz. MIN = 2 mHz. MAX = 100 kHz. The :RATE? query returns the FSK rate in hertz.

- The FSK rate is only used when the *Internal* source is selected (FSK:SOUR INT command) and is ignored when the external source is selected (FSK:SOUR EXT command).
- The modulating waveform is a *square wave* with a 50% duty cycle.

FSKey:STATE { **OFF** | **ON** }
FSKey:STATE?

Disable or enable FSK modulation. To avoid multiple waveform changes, you can enable FSK *after* you have set up the other modulation parameters. The default is OFF. The :STAT? query returns “0” (OFF) or “1” (ON).

- The function generator will allow only one modulation mode to be enabled at a time. For example, you cannot enable FSK and AM at the same time. When you enable FSK, the previous modulation mode is turned off.
- The function generator will not allow FSK to be enabled at the same time that sweep or burst is enabled. When you enable FSK, the sweep or burst mode is turned off.

Pulse Width Modulation (PWM) Commands

See also “Pulse Width Modulation” in chapter 3.

PWM Overview

The following is an overview of the steps required to generate a PWM waveform. The PWM commands are listed on the next page.

1 Configure the carrier (pulse) waveform.

Use the APPLY command or the equivalent FUNC, FREQ, VOLT, and VOLT:OFFS commands to select the function, frequency, amplitude, and offset of the pulse waveform. PWM is supported only for *pulse*.

2 Select the modulation source.

The function generator will accept an internal or external modulation source. Select the modulation source using the PWM:SOUR command. *For an external source, you can skip steps 3 and 4 below.*

3 Select the shape of the modulating waveform.

You can modulate the carrier with a sine, square, ramp, noise, or arbitrary waveform (pulse and dc are not allowed). Use the PWM:INT:FUNC command to select the modulating waveshape.

4 Set the modulating frequency.

Set the modulating frequency to any value from 2 mHz to 20 kHz using the PWM:INT:FREQ command.

5 Set the pulse width or pulse duty cycle deviation.

Set the **Width Deviation** to a value from 0 to the current **Pulse Width** or **Period - Pulse Width**, whichever is smaller, using the PWM:DEV command. Or, set the **Duty Cycle Deviation** to a value from 0 to the current **Duty Cycle** or **100 - Duty Cycle**, whichever is smaller, using the PWM:DEV:DCYC command.

6 Enable PWM modulation.

After you have set up the other modulation parameters, use the PWM:STAT ON command to enable PWM.

PWM Commands

Use the APPLY command or the equivalent FUNC, FREQ, VOLT, and VOLT:OFFS commands to configure the carrier waveform.





PWM:SOURce { **INT**ernal | **EXT**ernal }
PWM:SOURce?

Select the source of the modulating signal. The function generator will accept an internal or external modulation source. The default is INT. The :SOUR? query returns "INT" or "EXT".

- If you select the *External* source, the carrier waveform is modulated with an external waveform. The pulse width or pulse duty cycle deviation is controlled by the $\pm 5V$ signal level present on the rear-panel *Modulation In* connector. For example, if you have set the pulse width deviation to 50 μs using the PWM:DEV command, then a +5V signal level corresponds to a 50 μs width increase. Lower external signal levels produce less deviation.

PWM:INTernal
: **FUN**ction { **SIN**usoid | **SQU**are | **RAMP** | **NRAMP** | **TRI**angle | **NOIS**e | **USER** }
: **FUN**ction?

Select the shape of the *modulating* waveform. Used only when the *Internal* modulation source is selected (PWM:SOUR INT command). (The carrier must be a pulse waveform for PWM.) The default is SIN. The :FUNC? query returns "SIN", "SQU", "RAMP", "NRAMP", "TRI", "NOIS", or "USER".

- Select "SQU" for a square waveform with a 50% duty cycle. 
- Select "RAMP" for a ramp waveform with 100% symmetry. 
- Select "TRI" for a ramp waveform with 50% symmetry. 
- Select "NRAMP" (negative ramp) for a ramp waveform with 0% symmetry. 
- If you select an arbitrary waveform as the *modulating* waveshape ("USER"), the waveform is automatically limited to 4K points. Extra waveform points are removed using decimation.

Chapter 4 Remote Interface Reference
Pulse Width Modulation (PWM) Commands

PWM:INTernal:FREQuency {<frequency>|MINimum|MAXimum}
PWM:INTernal:FREQuency? [MINimum|MAXimum]

Set the frequency of the *modulating* waveform. Used only when the *Internal* modulation source is selected (PWM:SOUR INT command). Select from 2 mHz to 20 kHz. The default is 10 Hz. MIN = 2 mHz. MAX = 20 kHz. The :FREQ? query returns the internal modulating frequency in hertz.

PWM:DEVIation {<deviation in seconds>|MINimum|MAXimum}
PWM:DEVIation? [MINimum|MAXimum]

Set the pulse width deviation in seconds. This value represents the variation in width (in seconds) from the pulse width of the carrier pulse waveform. The default is 10 μ s. MIN = 0 s. MAX = 1000 s (limited by the period, minimum pulse width, and edge time). The :DEV? query returns the pulse width deviation in seconds.

- The pulse width deviation cannot exceed the current pulse width.
- The pulse width deviation is also limited by the minimum pulse width (Wmin):

$$\text{Width Deviation} \leq \text{Pulse Width} - W_{\text{min}}$$

and

$$\text{Width Deviation} \leq \text{Period} - \text{Pulse Width} - W_{\text{min}}$$

where:

$$W_{\text{min}} = 20 \text{ ns for period} \leq 10 \text{ s.}$$

$$W_{\text{min}} = 200 \text{ ns for period} > 10 \text{ s, but} \leq 100 \text{ s.}$$

$$W_{\text{min}} = 2 \mu\text{s for period} > 100 \text{ s, but} \leq 1000 \text{ s.}$$

$$W_{\text{min}} = 20 \mu\text{s for period} > 1000 \text{ s.}$$

- The pulse width deviation is limited by the current edge time setting.

$$\text{Width Deviation} \leq \text{Pulse Width} - (1.6 \times \text{Edge Time})$$

and

$$\text{Width Deviation} \leq \text{Period} - \text{Pulse Width} - (1.6 \times \text{Edge Time})$$

Chapter 4 Remote Interface Reference
Pulse Width Modulation (PWM) Commands

- If you select the *External* modulating source (PWM:SOUR EXT command), the deviation is controlled by the $\pm 5V$ signal level present on the rear-panel *Modulation In* connector. For example, if you have set the width deviation to 10 μs , then a +5V signal level corresponds to a 10 μs deviation. Lower external signal levels produce less deviation, and negative signal levels produce negative deviation.

Note: *The operation of the PWM:DEV command is affected by the FUNC:PULS:HOLD command (see “Pulse Configuration Commands” on page 185 for further information). The FUNC:PULS:HOLD command determines whether pulse width (the default) or pulse duty cycle values are to be held constant as the period is varied. If the width is held, so is the width deviation. If the duty cycle is held, so is the duty cycle deviation. If duty cycle and duty cycle deviation are being held, width deviation values specified with the PWM:DEV command are automatically converted to the equivalent duty cycle deviation in percent.*

PWM:DEVIation:DCYCLE { <deviation in percent> | MINimum | MAXimum }
PWM:DEVIation:DCYCLE? [MINimum | MAXimum]

Set the duty cycle deviation in percent (percent of period). This value represents the peak variation in duty cycle from the duty cycle of the underlying pulse waveform. For example, if duty cycle is 10% and duty cycle deviation is 5%, the duty cycle of the modulated waveform will vary from 5% to 15%. The default is 1 percent. MIN is approximately 0%. MAX is approximately 100% (limited by the period, minimum pulse width, and edge time). The :DEV:DCYC? query returns the duty cycle deviation in percent.

- The duty cycle deviation cannot exceed the current pulse duty cycle.
- The duty cycle deviation is also limited by the minimum pulse width (Wmin):

$$\text{Duty Cycle Deviation} \leq \text{Duty Cycle} - 100 \times W_{\text{min}} \div \text{Period}$$

and

$$\text{Duty Cycle Deviation} \leq 100 - \text{Duty Cycle} - 100 \times W_{\text{min}} \div \text{Period}$$

where:

$$W_{\text{min}} = 20 \text{ ns for period} \leq 10 \text{ s.}$$

$$W_{\text{min}} = 200 \text{ ns for period} > 10 \text{ s, but} \leq 100 \text{ s.}$$

$$W_{\text{min}} = 2 \mu\text{s for period} > 100 \text{ s, but} \leq 1000 \text{ s.}$$

$$W_{\text{min}} = 20 \mu\text{s for period} > 1000 \text{ s.}$$

Chapter 4 Remote Interface Reference
Pulse Width Modulation (PWM) Commands

- The duty cycle deviation is also limited by the current edge time setting.

$$\text{Duty Cycle Dev} \leq \text{Duty Cycle} - (160 \times \text{Edge Time}) \div \text{Period}$$

and

$$\text{Duty Cycle Dev} \leq 100 - \text{Duty Cycle} - (160 \times \text{Edge Time}) \div \text{Period}$$

- If you select the *External* modulating source (PWM:SOUR EXT command), the deviation is controlled by the $\pm 5\text{V}$ signal level present on the rear-panel *Modulation In* connector. For example, if you have set the duty cycle deviation to 5 percent, a +5V signal level corresponds to a 5 percent deviation, that is an additional 5% of period added to the pulse duty cycle. Lower external signal levels produce less deviation, and negative signal levels reduce the duty cycle.

Note: *The operation of the PWM:DEV:DCYC command is affected by the FUNC:PULS:HOLD command (see “Pulse Configuration Commands” on page 185 for further information). The FUNC:PULS:HOLD command determines whether pulse width (the default) or pulse duty cycle values are to be held constant as the period is varied. If the width is held, so is the width deviation. If the duty cycle is held, so is the duty cycle deviation. If pulse width and width deviation are being held, duty cycle deviation values specified with the PWM:DEV:DCYC command are automatically converted to the equivalent width deviation in seconds.*

PWM:STATe {OFF|ON}
PWM:STATe?

Disable or enable PWM. To avoid multiple waveform changes, you can enable PWM *after* you have set up the other modulation parameters. The default is OFF. The :STAT? query returns “0” (OFF) or “1” (ON).

- The function generator will allow only one modulation mode to be enabled at a time. For example, you cannot enable PWM and AM at the same time. When you enable PWM, the previous modulation mode is turned off.
- The function generator will not allow PWM to be enabled at the same time that sweep or burst is enabled. When you enable PWM, the sweep or burst mode is turned off.
- PWM is allowed only when pulse is the selected function.

Frequency Sweep Commands

See also “Frequency Sweep” starting on page 99 in chapter 3.

Sweep Overview

The following is an overview of the steps required to generate a sweep. The commands used for sweep are listed on page 210.

1 Select the waveform shape, amplitude, and offset.

Use the APPLY command or the equivalent FUNC, FREQ, VOLT, and VOLT:OFFS commands to select the function, frequency, amplitude, and offset. You can select a sine, square, ramp, or arbitrary waveform (pulse, noise, and dc are not allowed).

2 Select the frequency boundaries of the sweep.

You can set the frequency boundaries using one of two methods.

- a *Start Frequency / Stop Frequency:* Use the FREQ:STAR command to set the start frequency and the FREQ:STOP command to set the stop frequency.

To sweep **up** in frequency, set the start frequency < stop frequency.

To sweep **down** in frequency, set the start frequency > stop frequency.

- b *Center Frequency / Frequency Span:* Use the FREQ:CENT command to set the center frequency and the FREQ:SPAN command to set the frequency span.

To sweep **up** in frequency, set a *positive* span.

To sweep **down** in frequency, set a *negative* span.

3 Select the sweep mode.

Use the SWE:SPAC command to select linear or logarithmic spacing for the sweep.

4 Set the sweep time.

Use the `SWE:TIME` command to set the number of seconds required to sweep from the start frequency to the stop frequency.

5 Select the sweep trigger source.

Use the `TRIG:SOUR` command to select the source from which the sweep will be triggered.

6 Set the marker frequency. (Optional)

If desired, you can set the frequency at which the signal on the front-panel *Sync* connector goes to a logic low during the sweep. Use the `MARK:FREQ` command to set the marker frequency to any value between the start frequency and stop frequency. Use the `MARK ON` command to enable the frequency marker.

7 Enable the sweep mode.

After you have set up the other sweep parameters, use the `SWE:STAT ON` command to enable the sweep mode.

Sweep Commands

FREQUENCY:START { <frequency> | MINimum | MAXimum }

FREQUENCY:START? [MINimum | MAXimum]

Set the start frequency (used in conjunction with the *stop frequency*). Select from 1 μ Hz to 20 MHz (limited to 200 kHz for ramps and 6 MHz for arbitrary waveforms). The default is 100 Hz. MIN = 1 μ Hz. MAX = 20 MHz. The :STAR? query returns the start frequency in hertz.

- To sweep **up** in frequency, set the start frequency < stop frequency.
To sweep **down** in frequency, set the start frequency > stop frequency.

FREQUENCY:STOP { <frequency> | MINimum | MAXimum }

FREQUENCY:STOP? [MINimum | MAXimum]

Set the stop frequency (used in conjunction with the *start frequency*). Select from 1 μ Hz to 20 MHz (limited to 200 kHz for ramps and 6 MHz for arbitrary waveforms). The default is 1 kHz. MIN = 1 μ Hz. MAX = 20 MHz. The :STOP? query returns the stop frequency in hertz.

Chapter 4 Remote Interface Reference
Frequency Sweep Commands

FREQUENCY:CENTER {<frequency> | MINimum | MAXimum}
FREQUENCY:CENTER? [MINimum | MAXimum]

Set the center frequency (used in conjunction with the *frequency span*). Select from 1 μ Hz to 20 MHz (limited to 200 kHz for ramps and 6 MHz for arbitrary waveforms). The default is 550 Hz. MIN = 1 μ Hz. MAX = based on the frequency span and maximum frequency for the selected function as shown below. The :CENT? query returns the center frequency in hertz.

$$\text{Center Frequency (max)} = \text{Max. Frequency} - \frac{\text{Span}}{2}$$

- The following equation shows the relationship between the center frequency and the start/stop frequency.

$$\text{Center Frequency} = \frac{|\text{Stop Frequency} - \text{Start Frequency}|}{2}$$

FREQUENCY:SPAN {<frequency> | MINimum | MAXimum}
FREQUENCY:SPAN? [MINimum | MAXimum]

Set the frequency span (used in conjunction with the *center frequency*). Select from 0 Hz to 20 MHz (limited to 200 kHz for ramps and 6 MHz for arbitrary waveforms). The default is 900 Hz. MIN = 0 Hz. MAX = based on the center frequency and maximum frequency for the selected function. The :SPAN? query returns the span in hertz (can be a positive or negative value).

$$\text{Frequency Span (max)} = 2 \times (\text{Max. Frequency} - \text{Center Frequency})$$

- To sweep **up** in frequency, set a *positive* frequency span.
To sweep **down** in frequency, set a *negative* frequency span.
- The following equation shows the relationship between the span and the start/stop frequency.

$$\text{Frequency Span} = \text{Stop Frequency} - \text{Start Frequency}$$

Chapter 4 Remote Interface Reference
Frequency Sweep Commands

SWEep:SPACing { **LINEar** | **LOGarithmic** }
SWEep:SPACing?

Select linear or logarithmic spacing for the sweep. The default is Linear. The :SPAC? query returns "LIN" or "LOG".

- For a *linear* sweep, the function generator varies the output frequency in a linear fashion during the sweep.
- For a *logarithmic* sweep, the function generator varies the output frequency in a logarithmic fashion during the sweep.

SWEep:TIME { <seconds> | **MINimum** | **MAXimum** }
SWEep:TIME? [**MINimum** | **MAXimum**]

Set the number of seconds required to sweep from the start frequency to the stop frequency. Select from 1 ms to 500 seconds. The default is 1 second. MIN = 1 ms. MAX = 500 seconds. The :TIME? query returns the sweep time in seconds.

- The number of discrete frequency points in the sweep is automatically calculated by the function generator and is based on the sweep time that you select.

SWEep:STATE { **OFF** | **ON** }
SWEep:STATE?

Disable or enable the sweep mode. To avoid multiple waveform changes, you can enable the sweep mode *after* you have set up the other sweep parameters. The default is OFF. The :STAT? query returns "0" (OFF) or "1" (ON).

- The function generator will not allow the sweep mode to be enabled at the same time that burst or any modulation mode is enabled. When you enable sweep, the burst or modulation mode is turned off.

TRIGger:SOURce { IMMEDIATE | EXTERNAL | BUS }
TRIGger:SOURce?

Select the source from which the function generator will accept a trigger. The function generator will accept an immediate internal trigger, a hardware trigger from the rear-panel *Trig In* connector, or a software (bus) trigger. The default is IMM. The :SOUR? query returns “IMM”, “EXT”, or “BUS”

- When the *Immediate* (internal) source is selected, the function generator outputs a continuous sweep at a rate determined by the sweep time specified (SWE:TIME command) **plus** 1 ms.
- When the *External* source is selected, the function generator will accept a hardware trigger applied to the rear-panel *Trig In* connector. The function generator initiates one sweep each time *Trig In* receives a TTL pulse with the edge polarity specified by the TRIG:SLOP command (see page 214). Note that the trigger period must be greater than or equal to the specified sweep time **plus** 1 ms.
- When the *Bus* (software) source is selected, the function generator initiates one sweep each time a bus trigger command is received. To trigger the function generator from the remote interface (GPIB, USB, or LAN), send the *TRG (trigger) command. The front-panel  key is illuminated when the function generator is waiting for a bus trigger.
- The APPLY command automatically sets the trigger source to *Immediate* (equivalent to TRIG:SOUR IMM command).
- To ensure synchronization when the *Bus* source is selected, send the *WAI (wait) command. When the *WAI command is executed, the function generator waits for all pending operations to complete before executing any additional commands. For example, the following command string guarantees that the first trigger is accepted and the operation is executed before the second trigger is recognized.

```
TRIG:SOUR BUS;*TRG;*WAI;*TRG;*WAI
```

- You can use the *OPC? (operation complete query) command or the *OPC (operation complete) command to signal when the sweep is complete. The *OPC? command returns “1” to the output buffer when the sweep is complete. The *OPC command sets the “Operation Complete” bit (bit 0) in the Standard Event register when the sweep is complete.

Chapter 4 Remote Interface Reference
Frequency Sweep Commands

TRIGger:SLOPe { POSitive|NEGative}
TRIGger:SLOPe?

Select whether the function generator uses the rising edge or falling edge of the trigger signal on the rear-panel *Trig In* connector for an externally-triggered sweep. The default is POS (rising edge). The :SLOP? query returns “POS” or “NEG”.

OUTPut:TRIGger:SLOPe { POSitive|NEGative}
OUTPut:TRIGger:SLOPe?

Select a rising or falling edge for the “trigger out” signal. When enabled using the **OUTP:TRIG** command (see below), a TTL-compatible square waveform with the specified edge is output from the rear-panel *Trig Out* connector at the beginning of the sweep. Select “POS” to output a pulse with a rising edge or select “NEG” to output a pulse with a falling edge. The default is POS. The :SLOP? query returns “POS” or “NEG”.

- When the *Immediate* (internal) trigger source is selected (**TRIG:SOUR IMM** command), the function generator outputs a square waveform with a 50% duty cycle (the rising edge is the sweep trigger) from the *Trig Out* connector. The period of the waveform is equal to the specified sweep time (**SWE:TIME** command).
- When the *External* trigger source is selected (**TRIG:SOUR EXT** command), the function generator automatically disables the “trigger out” signal. The rear-panel *Trig Out* connector cannot be used for both operations at the same time (an externally-triggered sweep uses the same connector to trigger the sweep).
- When the *Bus* (software) trigger source is selected (**TRIG:SOUR BUS** command), the function generator outputs a pulse (>1 μ s pulse width) from the *Trig Out* connector at the beginning of each sweep.

OUTPut:TRIGger { OFF|ON}
OUTPut:TRIGger?

Disable or enable the “trigger out” signal. When enabled, a TTL-compatible square waveform with the specified edge (**OUTP:TRIG:SLOP** command) is output from the rear-panel *Trig Out* connector at the beginning of the sweep. The default is OFF. The :TRIG? query returns “0” (OFF) or “1” (ON).

MARKer:FREQuency {<frequency>|MINimum|MAXimum}
MARKer:FREQuency? [MINimum|MAXimum]

Set the marker frequency. This is the frequency at which the signal on the front-panel *Sync* connector goes to a logic low during the sweep. The Sync signal always goes from low to high at the beginning of the sweep. Select from 1 μ Hz to 20 MHz (limited to 200 kHz for ramps and 6 MHz for arbitrary waveforms). The default is 500 Hz. MIN = the start or stop frequency (whichever is lower). MAX = the start frequency or stop frequency (whichever is higher). The :FREQ? query returns the marker frequency in hertz.

- When sweep is enabled, the marker frequency *must* be between the specified start frequency and stop frequency. If you attempt to set the marker frequency to a frequency not in this range, the function generator will automatically set the marker frequency equal to the start frequency or stop frequency (whichever is closer). *From the remote interface, a "Settings conflict" error will be generated and the marker frequency will be adjusted as described.*

MARKer {OFF|ON}
MARKer?

Disable or enable the frequency marker. When the frequency marker is disabled, the signal output from the *Sync* connector is the normal Sync signal for the carrier waveform (see "Sync Output Signal" on page 68). The default is OFF. The MARK? query returns "0" (OFF) or "1" (ON).

- The OUTP:SYNC command is overridden by the setting of the MARK command. Therefore, when the marker frequency is enabled (and the sweep mode is also enabled), the OUTP:SYNC command is ignored

Burst Mode Commands

See also “Burst Mode” starting on page 106 in chapter 3.

Burst Mode Overview

The following is an overview of the steps required to generate a burst. You can use burst in one of two modes as described below. The function generator enables one burst mode at a time.

- **Triggered Burst Mode:** In this mode (default), the function generator outputs a waveform with a specified number of cycles (*burst count*) each time a trigger is received. After the specified number of cycles have been output, the function generator stops and waits for the next trigger. You can configure the function generator to use an internal trigger to initiate the burst or you can provide an external trigger by pressing the front-panel **Trigger** key, by applying a trigger signal to the rear-panel *Trig In* connector, or by sending a software trigger command from the remote interface.
- **External Gated Burst Mode:** In this mode, the output waveform is either “on” or “off” based on the level of the external signal applied to the rear-panel *Trig In* connector. When the gate signal is *true*, the function generator outputs a continuous waveform. When the gate signal goes *false*, the current waveform cycle is completed and then the function generator stops while remaining at the voltage level corresponding to the starting burst phase of the selected waveform.

	Burst Mode (BURS:MODE)	Burst Count (BURS:NCYC)	Burst Period (BURS:INT:PER)	Burst Phase (BURS:PHAS)	Trigger Source (TRIG:SOUR)
Triggered Burst Mode: Internal Trigger	TRIGgered	Available	Available	Available	IMMediate
Triggered Burst Mode: External Trigger	TRIGgered	Available	Not Used	Available	EXTernal, BUS
Gated Burst Mode: External Trigger	GATed	Not Used	Not Used	Available	Not Used

1 Configure the burst waveform.

Use the APPLY command or the equivalent FUNC, FREQ, VOLT, and VOLT:OFFS commands to select the function, frequency, amplitude, and offset of the waveform. You can select a sine, square, ramp, pulse, or arbitrary waveform (noise is allowed only in the gated burst mode and dc is not allowed). For internally-triggered bursts, the minimum frequency is 2 MHz. For sine and square waveforms, frequencies above 6 MHz are allowed only with an “infinite” burst count.

2 Select the “triggered” or “gated” burst mode.

Select the *triggered* burst mode (called “N Cycle” on the front panel) or external *gated* burst mode using the BURS:MODE command.

3 Set the burst count.

Set the burst count (the number of cycles per burst) to any value between 1 and 50,000 cycles (or infinite) using the BURS:NCYC command. *Used in the triggered burst mode only.*

4 Set the burst period.

Set the burst period (the interval at which internally-triggered bursts are generated) to any value from 1 μ s to 500 seconds using the BURS:INT:PER command. *Used only in the triggered burst mode with an internal trigger source.*

5 Set the burst starting phase.

Set the starting phase of the burst to any value from -360 degrees to +360 degrees using the BURS:PHAS command.

6 Select the trigger source.

Select the trigger source using the TRIG:SOUR command. *Used in the triggered burst mode only.*

7 Enable the burst mode.

After you have set up the other burst parameters, use the BURS:STAT ON command to enable the burst mode.

Burst Mode Commands

Use the `APPLY` command or the equivalent `FUNC`, `FREQ`, `VOLT`, and `VOLT:OFFS` commands to configure the waveform. For internally-triggered bursts, the minimum frequency is 2 MHz. For sine and square waveforms, frequencies above 6 MHz are allowed only with an “infinite” burst count.

`BURSt:MODE {TRIGgered|GATed}`

`BURSt:MODE?`

Select the burst mode. In the *triggered* mode, the function generator outputs a waveform with a specified number of cycles (*burst count*) each time a trigger is received from the specified trigger source (`TRIG:SOUR` command). In the *gated* mode, the output waveform is either “on” or “off” based on the level of the external signal applied to the rear-panel *Trig In* connector. The default is `TRIG`. The `:MODE?` query returns “`TRIG`” or “`GAT`”.

- When the *gated* mode is selected, the waveform generator either runs or stops based on the logic level of the gate signal applied to the rear-panel *Trig In* connector. You can select the polarity of the *Trig In* connector using the `BURSt:GATE:POL` command (see page 223). When the gate signal is *true*, the function generator outputs a continuous waveform. When the gate signal goes *false*, the current waveform cycle is completed and then the function generator stops while remaining at the voltage level corresponding to the starting burst phase of the selected waveform. For a noise waveform, the output stops immediately when the gate signal goes false.
- When the *gated* mode is selected, the burst count, burst period, and trigger source are ignored (these parameters are used for the triggered burst mode only). If a manual trigger is received (`TRIG` command), it is ignored and no error will be generated.

Burst Mode Commands

BURSt:NCYCles {<# cycles> | INFINity | MINimum | MAXimum}

BURSt:NCYCles? [MINimum | MAXimum]

Set the number of cycles to be output per burst (*triggered burst mode only*). Select from 1 cycle to 50,000 cycles, in 1 cycle increments (*see the restrictions below*). The default is 1 cycle. MIN = 1 cycle. MAX = based on the burst period and frequency as shown below. Select INF to generate a continuous burst waveform. The :NCYC? query returns the burst count from 1 to 50,000 or "9.9E+37" (for an infinite count).

- If the *Immediate* trigger source is selected (TRIG:SOUR IMM command), the burst count must be less than the product of the maximum burst period and the waveform frequency as shown below.

$$\text{Burst Count} < \text{Maximum Burst Period} \times \text{Waveform Frequency}$$

- The function generator will automatically increase the burst period up to its maximum value to accommodate the specified burst count (but the waveform frequency *will not* be changed). *From the remote interface, a "Settings conflict" error will be generated and the burst period will be adjusted as described.*
- For sine and square waveforms, frequencies above 6 MHz are allowed only with an "infinite" burst count.
- When the *gated* burst mode is selected, the burst count is ignored. However, if you change the burst count while in the gated mode, the function generator remembers the new count and will use it when the triggered mode is selected.

Burst Mode Commands

BURSt:INTernal:PERiod { <seconds> | **MINimum** | **MAXimum** }

BURSt:INTernal:PERiod? [**MINimum** | **MAXimum**]

Set the burst period for internally-triggered bursts. The burst period defines time from the start of one burst to the start of the next burst. Select from 1 μ s to 500 seconds. The default is 10 ms. MAX = 500 s. MIN = based on the burst count and waveform frequency as shown below. The :PER? query returns the burst period in seconds.

- The burst period setting is used only when *Immediate* triggering is enabled (TRIG:SOUR IMM command). The burst period is ignored when manual or external triggering is enabled (or when the *gated* burst mode is selected).
- It is *not* possible to specify a burst period which is too short for the function generator to output with the specified burst count and frequency (see below). If the burst period is too short, the function generator will automatically adjust it as needed to continuously re-trigger the burst. *From the remote interface, a "Data out of range" error will be generated and the burst period will be adjusted as described.*

$$\text{Burst Period} > \frac{\text{Burst Count}}{\text{Waveform Frequency}} + 200 \text{ ns}$$

BURSt:PHASe { <angle> | **MINimum** | **MAXimum** }

BURSt:PHASe? [**MINimum** | **MAXimum**]

Set the starting phase for the burst in degrees or radians as specified by the previous UNIT:ANGL command. Select from -360 degrees to +360 degrees or -2π to $+2\pi$ radians. The default is 0 degrees (0 radians). MIN = -360 degrees (-2π radians). MAX = +360 degrees ($+2\pi$). The :PHAS? query returns the starting phase in degrees or radians.

- For sine, square, and ramp waveforms, 0 degrees is the point at which the waveform crosses zero volts (or the dc offset value) in a positive-going direction. For arbitrary waveforms, 0 degrees is the first waveform point downloaded to memory. This command has no effect on pulse or noise waveforms.
- The burst phase is also used in the *gated* burst mode. When the gate signal goes *false*, the current waveform cycle is completed and then the function generator stops. The output will remain at the voltage level corresponding to the starting burst phase.

BURSt:STATe {OFF|ON}
BURSt:STATe?

Disable or enable the burst mode. To avoid multiple waveform changes, you can enable the burst mode *after* you have set up the other burst parameters. The default is OFF. The :STAT? query returns “0” (OFF) or “1” (ON).

- The function generator will not allow the burst mode to be enabled at the same time that sweep or any modulation mode is enabled. When you enable burst, the sweep or modulation mode is turned off.

UNIT:ANGLE {DEGREE|RADIAN}
UNIT:ANGLE?

Select degrees or radians to set the starting phase for the burst with the BURS:PHAS command (remote interface only). The default is DEG. The :ANGL? query returns “DEG” or “RAD”.

- From the front panel, the starting phase is always displayed in degrees (radians are not available). If you set the starting phase in radians from the remote interface and then return to front-panel operation, you will see that the function generator converts the phase to degrees.

TRIGger:SOURce {IMMEDIATE|EXTERNAL|BUS}
TRIGger:SOURce?

Select the trigger source for the *triggered* burst mode only. In the triggered burst mode, the function generator outputs a waveform with the specified number of cycles (*burst count*) each time a trigger is received. After the specified number of cycles have been output, the function generator stops and waits for the next trigger. The default is IMM. The :SOUR? query returns “IMM”, “EXT”, or “BUS”

- When the *Immediate* (internal) source is selected, the frequency at which the burst is generated is determined by the *burst period* (BURS:INT:PER command).
- When the *External* source is selected, the function generator will accept a hardware trigger applied to the rear-panel *Trig In* connector. The function generator outputs the specified number of cycles each time *Trig In* receives a TTL pulse with the edge polarity specified by the TRIG:SLOP command (see page 222). External trigger signals that occur during a burst are ignored.

Burst Mode Commands

- When the *Bus* (software) source is selected, the function generator outputs one burst each time a bus trigger command is received. To trigger the function generator from the remote interface (GPIB, USB, or LAN), send the *TRG (trigger) command. The front-panel  key is illuminated when the function generator is waiting for a bus trigger.
- When the *External* or *Bus* trigger source is selected, the *burst count* and *burst phase* remain in effect but the *burst period* is ignored.
- The APPLY command automatically sets the trigger source to *Immediate* (equivalent to TRIG:SOUR IMM command).
- To ensure synchronization when the *Bus* source is selected, send the *WAI (wait) command. When the *WAI command is executed, the function generator waits for all pending operations to complete before executing any additional commands. For example, the following command string guarantees that the first trigger is accepted and the operation is executed before the second trigger is recognized.

```
TRIG:SOUR BUS;*TRG;*WAI;*TRG;*WAI
```

- You can use the *OPC? (operation complete query) command or the *OPC (operation complete) command to signal when the burst is complete. The *OPC? command returns “1” to the output buffer when the burst is complete. The *OPC command sets the “Operation Complete” bit (bit 0) in the Standard Event register when the burst is complete.

```
TRIGger:SLOPe {POSitive|NEGative}  
TRIGger:SLOPe?
```

Select whether the function generator uses the rising edge or falling edge of the trigger signal on the rear-panel *Trig In* connector for an externally-triggered burst. The default is POS (rising edge). The :SLOP? query returns “POS” or “NEG”.

BURSt:GATE:POLarity {NORMAL|INVerted}
BURSt:GATE:POLarity?

Select whether the function generator uses true-high or true-low logic levels on the rear-panel *Trig In* connector for an externally-gated burst. The default is NORM (true-high logic). The :POL? query returns "NORM" or "INV".

OUTPut:TRIGger:SLOPe {POSitive|NEGative}
OUTPut:TRIGger:SLOPe?

Select a rising or falling edge for the "trigger out" signal. When enabled using the OUTP:TRIG command (see below), a TTL-compatible square waveform with the specified edge is output from the rear-panel *Trig Out* connector at the beginning of the burst. Select "POS" to output a pulse with a rising edge or select "NEG" to output a pulse with a falling edge. The default is POS. The :SLOP? query returns "POS" or "NEG".

- When the *Immediate* (internal) trigger source is selected (TRIG:SOUR IMM command), the function generator outputs a square waveform with a 50% duty cycle from the *Trig Out* connector. The period of the waveform is equal to the specified burst period (BURS:INT:PER command).
- When the *External* trigger source is selected (TRIG:SOUR EXT command) *or* when the *Gated* mode is selected (BURS:MODE GAT command), the function generator automatically disables the "trigger out" signal. The rear-panel *Trig Out* connector cannot be used for both operations at the same time (an externally-triggered waveform uses the same connector to trigger the burst).
- When the *Bus* (software) trigger source is selected (TRIG:SOUR BUS command), the function generator outputs a pulse (>1 μ s pulse width) from the *Trig Out* connector at the beginning of each burst.

OUTPut:TRIGger {OFF|ON}
OUTPut:TRIGger?

Disable or enable the "trigger out" signal (used with burst and sweep only). When enabled, a TTL-compatible square waveform with the specified edge (OUTP:TRIG:SLOP command) is output from the rear-panel *Trig Out* connector at the beginning of the burst. The default is OFF. The :TRIG? query returns "0" (OFF) or "1" (ON).

Triggering Commands

Applies to Sweep and Burst only. See also “Triggering” starting on page 115 in chapter 3.

TRIGger:SOURce { IMMEDIATE | EXTERNAL | BUS }
TRIGger:SOURce?

Select the source from which the function generator will accept a trigger. The function generator will accept an immediate internal trigger, a hardware trigger from the rear-panel *Trig In* connector, or a software (bus) trigger. The default is IMM. The :SOUR? query returns “IMM”, “EXT”, or “BUS”

- When the *Immediate* (internal) source is selected, the function generator outputs continuously when the sweep mode or burst mode is enabled.
- When the *External* source is selected, the function generator will accept a hardware trigger applied to the rear-panel *Trig In* connector. The function generator initiates one sweep or outputs one burst each time *Trig In* receives a TTL pulse with the edge polarity specified by the TRIG:SLOP command (see page 225).
- When the *Bus* (software) source is selected, the function generator initiates one sweep or outputs one burst each time a bus trigger command is received. To trigger the function generator from the remote interface (GPIB, USB, or LAN) when the *Bus* source selected, send the *TRG (trigger) command. The front-panel  key is illuminated when the function generator is waiting for a bus trigger.
- The APPLY command automatically sets the trigger source to *Immediate* (equivalent to TRIG:SOUR IMM command).

- To ensure synchronization when the *Bus* source is selected, send the *WAI (wait) command. When the *WAI command is executed, the function generator waits for all pending operations to complete before executing any additional commands. For example, the following command string guarantees that the first trigger is accepted and the operation is executed before the second trigger is recognized.

```
TRIG:SOUR BUS;*TRG;*WAI;*TRG;*WAI
```

- You can use the *OPC? (operation complete query) command or the *OPC (operation complete) command to signal when the sweep or burst is complete. The *OPC? command returns “1” to the output buffer when the sweep or burst is complete. The *OPC command sets the “Operation Complete” bit (bit 0) in the Standard Event register when the sweep or burst is complete.

TRIGger

Trigger a sweep or burst from the remote interface. This command can be used with any of the available trigger sources (TRIG:SOUR command). For example, you can use the TRIG command to issue an immediate trigger while waiting for an external trigger.

*TRG

Trigger a sweep or burst from the remote interface *only* if the bus (software) trigger source is currently selected (TRIG:SOUR BUS command).

```
TRIGger:SLOPe {POSitive|NEGative}
```

```
TRIGger:SLOPe?
```

Select whether the function generator uses the rising edge or falling edge of the trigger signal on the rear-panel *Trig In* connector. The default is POS (rising edge). The :SLOP? query returns “POS” or “NEG”.

```
BURSt:GATE:POLarity {NORMal|INVerted}
```

```
BURSt:GATE:POLarity?
```

Select whether the function generator uses true-high or true-low logic levels on the rear-panel *Trig In* connector for an externally-gated burst. The default is NORM (true-high logic). The :POL? query returns “NORM” or “INV”.

Triggering Commands

OUTPut:TRIGger:SLOPe { POSitive|NEGative }

OUTPut:TRIGger:SLOPe?

Select a rising or falling edge for the “trigger out” signal. When enabled using the **OUTP:TRIG** command (see below), a TTL-compatible square waveform with the specified edge is output from the rear-panel *Trig Out* connector at the beginning of the sweep or burst. Select “POS” to output a pulse with a rising edge or select “NEG” to output a pulse with a falling edge. The default is POS. The **:SLOP?** query returns “POS” or “NEG”.

- When the *Immediate* (internal) trigger source is selected (**TRIG:SOUR IMM** command), the function generator outputs a square waveform with a 50% duty cycle from the *Trig Out* connector. The period of the waveform is equal to the specified sweep time (**SWE:TIME** command) or burst period (**BURS:INT:PER** command) **plus** 1 ms.
- When the *External* trigger source is selected (**TRIG:SOUR EXT** command), the function generator automatically disables the “trigger out” signal. The rear-panel *Trig Out* connector cannot be used for both operations at the same time (an externally-triggered waveform uses the same connector to trigger the sweep or burst).
- When the *Bus* (software) trigger source is selected (**TRIG:SOUR BUS** command), the function generator outputs a pulse (>1 μ s pulse width) from the *Trig Out* connector at the beginning of each sweep or burst.

OUTPut:TRIGger { OFF|ON }

OUTPut:TRIGger?

Disable or enable the “trigger out” signal (used for sweep and burst only). When enabled, a TTL-compatible square waveform with the specified edge (**OUTP:TRIG:SLOP** command) is output from the rear-panel *Trig Out* connector at the beginning of the sweep or burst. The default is OFF. The **:TRIG?** query returns “0” (OFF) or “1” (ON).

Arbitrary Waveform Commands

See also “Arbitrary Waveforms” starting on page 120 in chapter 3.

Arbitrary Waveform Overview

The following is an overview of the steps required to download and output an arbitrary waveform over the remote interface. The commands used for arbitrary waveforms are listed on page 229. Refer to chapter 7, “Tutorial”, for more information on the internal operation of downloading and outputting an arbitrary waveform.

Chapter 6, “Application Programs”, contains example programs which show the use of arbitrary waveforms. You may find it useful to refer to the programs after reading the following section in this chapter.

4

1 Download the waveform points into volatile memory.

You can download from 1 point (a dc signal) to 65,536 (64K) points per waveform. You can download the points as floating-point values, binary integer values, or decimal integer values. Use the DATA command to download floating-point values from -1.0 to +1.0. Use the DATA:DAC command to download binary integer or decimal integer values from -8191 to +8191.

To ensure that binary data is downloaded properly, you must select the order in which the bytes are downloaded using the FORM:BORD command.

2 Select the waveform frequency, amplitude, and offset.

Use the APPLY command or the equivalent FREQ, VOLT, and VOLT:OFFS commands to select the frequency, amplitude, and offset of the waveform.

3 Copy the arbitrary waveform to non-volatile memory.

You can output the arbitrary waveform directly from volatile memory or you can copy the waveform to non-volatile memory using the `DATA: COPY` command.

4 Select the arbitrary waveform to output.

You can select one of the five built-in arbitrary waveforms, one of four user-defined waveforms, or the waveform currently downloaded to volatile memory. Use the `FUNC: USER` command to select the waveform.

5 Output the selected arbitrary waveform.

Use the `FUNC USER` command to output the waveform previously selected with the `FUNC: USER` command.

The five built-in arbitrary waveforms are shown below.

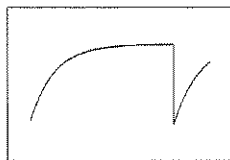

Exponential Rise

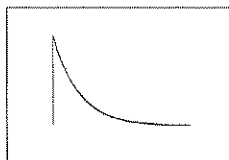

Exponential Fall

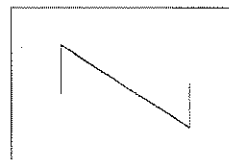

Negative Ramp

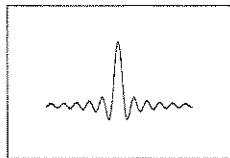

Sinc

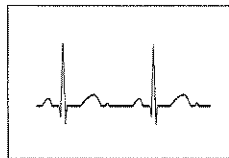

Cardiac

Arbitrary Waveform Commands

DATA VOLATILE, *<value>*, *<value>*, . . .

Download *floating-point* values from -1 to +1 into volatile memory.

You can download from 1 to 65,536 (64K) points per waveform.

The function generator takes the specified number of points and expands them to fill waveform memory. If you download *less than 16,384 (16K)* points, a waveform with 16,384 points is automatically generated. If you download *more than 16,384* points, a 65,536-point waveform is generated.

- The values -1 and +1 correspond to the *peak* values of the waveform (if the offset is 0 volts). For example, if you set the amplitude to 10 Vpp (0V offset), “+1” corresponds to +5V and “-1” corresponds to -5V.
- The maximum amplitude will be limited if the data points do not span the full range of the output DAC (Digital-to-Analog Converter). For example, the built-in “Sinc” waveform does not use the full range of values between ± 1 and therefore its maximum amplitude is 6.087 Vpp (into 50 ohms).
- Downloading floating-point values (using **DATA VOLATILE**) is slower than downloading binary values (using **DATA:DAC VOLATILE**) but is more convenient when using trigonometric functions which return values from -1 to +1.
- The **DATA** command overwrites the previous waveform in volatile memory (and no error will be generated). Use the **DATA:COPY** command to copy the waveform to *non-volatile* memory.
- Up to four user-defined waveforms can be stored in non-volatile memory. Use the **DATA:DEL** command to delete the waveform in volatile memory or any of the four user-defined waveforms in non-volatile memory. Use the **DATA:CAT?** command to list all waveforms currently stored in volatile and non-volatile memory (as well as the five built-in waveforms).
- After downloading the waveform data to memory, use the **FUNC:USER** command to choose the active waveform and the **FUNC USER** command to output it.
- The following statement shows how to use the **DATA** command to download seven points to volatile memory.

```
DATA VOLATILE, 1, .67, .33, 0, -.33, -.67, -1
```

Chapter 4 Remote Interface Reference
Arbitrary Waveform Commands

DATA:DAC VOLATILE, {<binary block>|<value>, <value>, . . . }

Download *binary* or *decimal* integer values from -8191 to +8191 into volatile memory. You can download from 1 to 65,536 (64K) points per waveform in IEEE-488.2 binary block format or as a list of values. The range of values corresponds to the values available using internal 14-bit DAC (Digital-to-Analog Converter) codes. The function generator takes the specified number of points and expands them to fill waveform memory. If you download *less than* 16,384 (16K) points, a waveform with 16,384 points is automatically generated. If you download *more than* 16,384 points, a 65,536-point waveform is generated.

- The values -8191 and +8191 correspond to the peak values of the waveform (if the offset is 0 volts). For example, if you set the output amplitude to 10 Vpp, “+8191” corresponds to +5V and “-8191” corresponds to -5V.
- The maximum amplitude will be limited if the data points do not span the full range of the output DAC. For example, the built-in “Sinc” waveform does not use the full range of values between ±8191 and therefore its maximum amplitude is 6.087 Vpp (into 50 ohms).
- The DATA:DAC command overwrites the previous waveform in volatile memory (and no error will be generated). Use the DATA: COPY command to copy the waveform to *non-volatile* memory.
- Up to four user-defined waveforms can be stored in non-volatile memory. Use the DATA: DEL command to delete the waveform in volatile memory or any of the four user-defined waveforms in non-volatile memory. Use the DATA: CAT? command to list all waveforms currently stored in volatile and non-volatile memory (as well as the five built-in waveforms).
- After downloading the waveform data to memory, use the FUNC: USER command to choose the active waveform and the FUNC USER command to output it.

- The following statement shows how to use the DATA:DAC command to download seven integer points using the binary block format (*see also "Using the IEEE-488.2 Binary Block Format" below*).

```
DATA:DAC VOLATILE, #214 Binary Data
```

- The following statement shows how to use the DATA:DAC command to download five integer points in decimal format.

```
DATA:DAC VOLATILE, 8191, 4096, 0, -4096, -8191
```

Using the IEEE-488.2 Binary Block Format

In the binary block format, a *block header* precedes the waveform data. The block header has the following format:

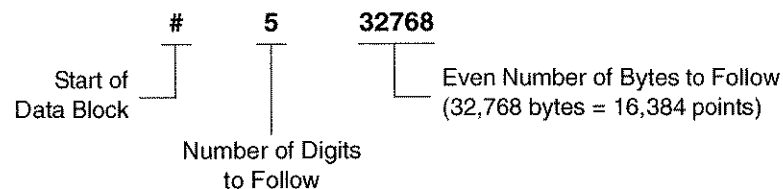

The function generator represents binary data as 16-bit integers, which are sent as two bytes. Therefore, **the total number of bytes is always twice the number of data points in the waveform** (and must always be an **even number**). For example, 32,768 bytes are required to download a waveform with 16,384 points.

Use the FORM:BORD command to select the byte order for binary transfers in block mode. If you specify FORM:BORD NORM (default), the most-significant byte (MSB) of each data point is assumed first. If you specify FORM:BORD SWAP, the least-significant byte (LSB) of each data point is assumed first. Most computers use the "swapped" byte order.

Chapter 4 Remote Interface Reference

Arbitrary Waveform Commands

FORMat:BORDER {**NORMal** | **SWAPped**}
FORMat:BORDER?

Used for binary block transfers only. Select the byte order for binary transfers in the block mode using the **DATA:DAC** command. The default is **NORM**. The **:BORDER?** query returns “**NORM**” or “**SWAP**”.

- In **NORM** byte order (default), the most-significant byte (MSB) of each data point is assumed first.
- In **SWAP** byte order, the least-significant byte (LSB) of each data point is assumed first. Most computers use the “swapped” byte order.
- The function generator represents binary data as signed 16-bit integers, which are sent as two bytes. Therefore, each waveform data point requires 16 bits, which must be transferred as two bytes on the function generator’s interfaces.

DATA:COPY <destination arb name> [, **VOLATILE**]

Copy the waveform from volatile memory to the specified name in non-volatile memory. The source for the copy is always “volatile”. You cannot copy **from** any other source and you cannot copy **to** “volatile”.

- The arb name may contain up to 12 characters. The first character *must* be a letter (A-Z), but the remaining characters can be numbers (0-9) or the underscore character (“_”). Blank spaces are not allowed. If you specify a name with more than 12 characters, a “Program mnemonic too long” error is generated.
- The **VOLATILE** parameter is optional and can be omitted. Note that the keyword “**VOLATILE**” *does not* have a short form.
- The following built-in waveform names are reserved and cannot be used with the **DATA:COPY** command: “**EXP_RISE**”, “**EXP_FALL**”, “**NEG_RAMP**”, “**SINC**”, and “**CARDIAC**”. If you specify one of the built-in waveforms, a “Cannot overwrite a built-in waveform” error is generated.
- The function generator does not distinguish between upper- and lower-case letters. Therefore, **ARB_1** and **arb_1** are the same name. All characters are converted to upper case.

- If you copy to a waveform name that already exists, the previous waveform is overwritten (and no error will be generated). However, you cannot overwrite any of the five built-in waveforms.
- Up to four user-defined waveforms can be stored in non-volatile memory. If memory is full and you try to copy a new waveform to non-volatile memory, a “Not enough memory” error is generated. Use the `DATA:DEL` command to delete the waveform in volatile memory or any of the four user-defined waveforms in non-volatile memory. Use the `DATA:CAT?` command to list all waveforms currently stored in volatile and non-volatile memory. The default selection is `EXP_RISE`.
- The following statement shows how to use the `DATA:COPY` command to copy the `VOLATILE` waveform into named storage “`ARB_1`”.

```
DATA:COPY ARB_1, VOLATILE
```

```
FUNCTION:USER {<arb name>|VOLATILE}  
FUNCTION:USER?
```

Select one of the five built-in arbitrary waveforms, one of four user-defined waveforms, or the waveform currently downloaded to volatile memory. The `:USER?` query returns “`EXP_RISE`”, “`EXP_FALL`”, “`NEG_RAMP`”, “`SINC`”, “`CARDIAC`”, “`VOLATILE`”, or the name of any user-defined waveforms in non-volatile memory. The default selection is “`EXP_RISE`”.

- Note that this command *does not* output the selected arbitrary waveform. Use the `FUNC USER` command (see the following page) to output the selected waveform.
- The names of the five built-in arbitrary waveforms are: “`EXP_RISE`”, “`EXP_FALL`”, “`NEG_RAMP`”, “`SINC`”, and “`CARDIAC`”.
- To select the waveform currently stored in volatile memory, specify the `VOLATILE` parameter. The keyword “`VOLATILE`” *does not* have a short form.
- If you select a waveform name that is not currently downloaded, a “Specified arb waveform does not exist” error is generated.

Arbitrary Waveform Commands

- The function generator does not distinguish between upper- and lower-case letters. Therefore, `ARB_1` and `arb_1` are the same name. All characters are converted to upper case.
- Use the `DATA:CAT?` command to list the names of the five built-in waveforms (non-volatile), "VOLATILE" if a waveform is currently downloaded to volatile memory, and the names of any user-defined waveforms (non-volatile).

FUNCTION USER

FUNCTION?

Select the arbitrary waveform function and output the current arbitrary waveform. When executed, this command outputs the arbitrary waveform currently selected by the `FUNC:USER` command (see the previous page). The selected waveform is output using the current frequency, amplitude, and offset voltage settings. The `FUNC?` query returns "SIN", "SQU", "RAMP", "PULS", "NOIS", "DC", or "USER".

- Use the `APPLY` command or the equivalent `FREQ`, `VOLT`, and `VOLT:OFFS` commands to select the frequency, amplitude, and offset of the waveform.
- The maximum amplitude will be limited if the data points do not span the full range of the output DAC (Digital-to-Analog Converter). For example, the built-in "SINC" waveform does not use the full range of binary values between ± 1 and therefore its maximum amplitude is 6.087 Vpp (into 50 ohms).
- If you select an arbitrary waveform as the *modulating* waveshape ("USER"), the waveform is automatically limited to 4K points. Extra waveform points are removed using decimation.

DATA:CATalog?

List the names of *all* waveforms currently available for selection. Returns the names of the five built-in waveforms (non-volatile memory), "VOLATILE" if a waveform is currently downloaded to volatile memory, and all user-defined waveforms downloaded to non-volatile memory.

- A series of quoted strings separated with commas is returned as shown in the example below.

```
"VOLATILE", "EXP_RISE", "EXP_FALL", "NEG_RAMP",  
"SINC", "CARDIAC", "TEST1_ARB", "TEST2_ARB"
```

- Use the DATA:DEL command to delete the waveform in volatile memory or any of the user-defined waveforms in non-volatile memory.

DATA:NVOLatile:CATalog?

List the names of all user-defined arbitrary waveforms downloaded to *non-volatile* memory. Returns the names of up to four waveforms.

- A series of quoted strings separated with commas is returned as shown in the example below. If no user-defined waveforms are currently downloaded, the command returns a null string (" ").

```
"TEST1_ARB", "TEST2_ARB", "TEST3_ARB", "TEST4_ARB"
```

- Use the DATA:DEL command to delete any of the user-defined waveforms in non-volatile memory.

DATA:NVOLatile:FREE?

Query the number of non-volatile memory slots available to store user-defined waveforms. Returns the number of memory slots available to store user-defined waveforms. Returns "0" (memory is full), "1", "2", "3", or "4".

Chapter 4 Remote Interface Reference

Arbitrary Waveform Commands

DATA:DELeTe <arb name>

Delete the specified arbitrary waveform from memory. You can delete the waveform in volatile memory or any of the four user-defined waveforms in non-volatile memory.

- You cannot delete the arbitrary waveform that is currently being output. If you attempt to delete this waveform, a “Not able to delete the currently selected active arb waveform” error is generated.
- You cannot delete any of the five built-in arbitrary waveforms. If you attempt to delete one of these waveforms, a “Not able to delete a built-in arb waveform” error is generated.
- Use the **DATA:DEL:ALL** command to delete the waveform in volatile memory and all user-defined non-volatile waveforms *all at once*. If one of the waveforms is currently being output, a “Not able to delete the currently selected active arb waveform” error is generated.

DATA:DELeTe:ALL

Delete all user-defined arbitrary waveforms from memory. This command deletes the waveform in volatile memory and all user-defined waveforms in non-volatile memory. The five built-in waveforms in non-volatile memory *are not* deleted.

- The colon before the **ALL** parameter is required (**DATA:DELeTe:ALL**). If you insert a space instead of a colon, the function generator will attempt to delete an arbitrary waveform with the name “ALL”. If no such waveform is stored in memory, a “Specified arb waveform does not exist” error is generated.
- Use the **DATA:DEL <arb name>** command to delete stored waveforms *one at a time*.
- You cannot delete the arbitrary waveform that is currently being output. If you attempt to delete this waveform, a “Not able to delete the currently selected active arb waveform” error is generated.
- You cannot delete any of the five built-in arbitrary waveforms. If you attempt to delete one of these waveforms, a “Not able to delete a built-in arb waveform” error is generated.

DATA:ATTRiBute:AVERAge? [*<arb name>*]

Query the *arithmetic average* of all data points for the specified arbitrary waveform ($-1 \leq \textit{average} \leq +1$). The default *arb name* is the arbitrary waveform currently active (selected with FUNC:USER command).

- If you query a waveform that is not currently stored in memory, a “Specified arb waveform does not exist” error is generated.

DATA:ATTRiBute:CFACTOR? [*<arb name>*]

Query the *crest factor* of all data points for the specified arbitrary waveform. Crest factor is the ratio of the peak value to the RMS value of the waveform. The default *arb name* is the arbitrary waveform currently active (selected with FUNC:USER command).

- If you query a waveform that is not currently stored in memory, a “Specified arb waveform does not exist” error is generated.

DATA:ATTRiBute:POINTs? [*<arb name>*]

Query the *number of points* in the specified arbitrary waveform. Returns a value from 1 to 65,536 points. The default *arb name* is the arbitrary waveform currently active (selected with FUNC:USER command).

- If you query a waveform that is not currently stored in memory, a “Specified arb waveform does not exist” error is generated.

DATA:ATTRiBute:PTPeak? [*<arb name>*]

Query the *peak-to-peak* value of all data points for the specified arbitrary waveform. The default *arb name* is the arbitrary waveform currently active (selected with FUNC:USER command).

- This command returns a value from “0” to “+1.0”, with “+1.0” indicating full amplitude available.
- The maximum amplitude will be limited if the data points do not span the full range of the output DAC (Digital-to-Analog Converter). For example, the built-in “Sinc” waveform does not use the full range of binary values between ± 1 and therefore its maximum amplitude is 6.087 Vpp (into 50 ohms).
- If you query a waveform that is not currently stored in memory, a “Specified arb waveform does not exist” error is generated.

State Storage Commands

The function generator has five storage locations in non-volatile memory to store instrument states. The locations are numbered 0 through 4. The function generator automatically uses location “0” to hold the state of the instrument at power down. You can also assign a user-defined name to each of the locations (1 through 4) for use from the front panel.

***SAV {0|1|2|3|4}**

Store (save) the current instrument state in the specified non-volatile storage location. Any state previously stored in the same location will be overwritten (and no error will be generated).

- You can store the instrument state in any of the five storage locations. However, you can only recall a state from a location that contains a previously-stored state.
- From the *remote interface* only, you can use storage location “0” to store a fifth instrument state (you cannot store to this location from the front panel). However, note that location “0” is automatically overwritten when power is cycled (the instrument state previously stored will be overwritten).
- The state storage feature “remembers” the selected function (including arbitrary waveforms), frequency, amplitude, dc offset, duty cycle, symmetry, as well as any modulation parameters in use.
- If you delete an arbitrary waveform from non-volatile memory after storing the instrument state, the waveform data is lost and the function generator *will not* output the waveform when the state is recalled. The built-in “exponential rise” waveform is output in place of the deleted waveform.

- When power is turned off, the function generator automatically stores its state in storage location “0”. You can configure the function generator to automatically recall the power-down state when power is restored. See the `MEM:STAT:REC:AUTO` command on page 241 for more information.
- The front-panel display state (`DISP` command) is saved when you store the instrument state. When you recall the instrument state, the front-panel display will return to the previous state.
- An instrument reset (`*RST` command) *does not* affect the configurations stored in memory. Once a state is stored, it remains until it is overwritten or specifically deleted.

`*RCL {0|1|2|3|4}`

Recall the instrument state stored in the specified non-volatile storage location. You cannot recall the instrument state from a storage location that is empty.

- When shipped from the factory, storage locations “1” through “4” are empty (location “0” has the power-on state).
- From the *remote interface* only, you can use location “0” to store a fifth instrument state (you cannot store to this location from the front panel). However, keep in mind that location “0” is automatically overwritten when power is cycled (the instrument state previously stored will be overwritten).

State Storage Commands

MEMory:STATe:NAME {0|1|2|3|4} [, <name>]

MEMory:STATe:NAME? {0|1|2|3|4}

Assign a custom name to the specified storage location. You can name a location from the front panel or over the remote interface, but you can only recall a state by name from the front panel (the *RCL command requires a numeric parameter). The :NAME? query returns a quoted string containing the name currently assigned to the specified storage location. If you have not assigned a user-defined name to the specified location, the default name is returned ("AUTO_RECALL", "STATE_1", "STATE_2", "STATE_3", or "STATE_4").

- The name can contain up to 12 characters. The first character *must* be a letter (A-Z), but the remaining characters can be letters, numbers (0-9), or the underscore character (" _"). Blank spaces are not allowed. An error is generated if you specify a name with more than 12 characters. An example is shown below.

```
MEM:STATE:NAME 1,TEST_WFORM_1
```

- From the front panel, you *cannot* assign a custom name to storage location "0".
- If you do not specify a name (note that the *name* parameter is optional), the default name is assigned to that state. This provides a way to clear a name (however, the stored state *is not* deleted).
- The function generator *will not* prevent you from assigning the *same* name to different storage locations. For example, you can assign the same name to locations "1" and "2".

MEMory:STATe:DELeTe {0|1|2|3|4}

Delete the contents of the specified storage location. If you have assigned a user-defined name to a location (MEM:STAT:NAME command), this command also removes the name that you assigned and restores the default name ("AUTO_RECALL", "STATE_1", "STATE_2", etc.). Note that you cannot recall the instrument state from a storage location that is empty. An error is generated if you attempt to recall a deleted state.

MEMory:STAtE:RECall:AUTO {OFF|ON}

MEMory:STAtE:RECall:AUTO?

Disable or enable the automatic recall of the power-down state from storage location "0" when power is turned on. Select "ON" to automatically recall the power-down state when power is turned on. Select "OFF" (default) to issue a reset (*RST command) when power is turned on (state "0" is not automatically recalled). The :AUTO? query returns "0" (OFF) or "1" (ON).

MEMory:STAtE:VALId? {0|1|2|3|4}

Query the specified storage location to determine if a valid state is currently stored in that location. You can use this command before sending the *RCL command to determine if a state has been previously stored in this location. Returns "0" if no state has been stored or if it has been deleted. Returns "1" if a valid state is stored in the specified location.

MEMory:NStates?

Query the total number of memory locations available for state storage. Always returns "5" (memory location "0" is included).

System-Related Commands

See also “System-Related Operations” starting on page 126 in chapter 3.

SYSTem:ERRor?

Read and clear one error from the function generator’s *error queue*. A record of up to 20 command syntax or hardware errors can be stored in the error queue. See chapter 5 for a complete listing of the error messages.

- Errors are retrieved in first-in-first-out (FIFO) order. The first error returned is the first error that was stored. Errors are cleared as you read them. The function generator beeps once each time an error is generated (unless disabled using the SYST:BEEP:STAT command).
- If more than 20 errors have occurred, the last error stored in the queue (the most recent error) is replaced with “Queue overflow”. No additional errors are stored until you remove errors from the queue. If no errors have occurred when you read the error queue, the function generator responds with “No error”.
- The error queue is cleared by the *CLS (clear status) command or when the power is cycled. The errors are also cleared when you read the queue. The error queue *is not* cleared by a reset (*RST command).
- Errors have the following format (the error string may contain up to 255 characters).

```
-113, "Undefined header"
```

***IDN?**

Read the function generator's identification string which contains four fields separated by commas. The first field is the manufacturer's name, the second field is the model number, the third field is the serial number, and the fourth field is a revision code which contains four numbers separated by dashes.

- The command returns a string with the following format (be sure to dimension a string variable with at least 50 characters).

Agilent Technologies,33220A,<serial number>,f.ff-b.bb-aa-p

f.ff = Firmware revision number
b.bb = Boot kernel revision number
aa = ASIC revision number
p = Printed circuit board revision number

DISPlay {OFF|ON}
DISPlay?

Disable or enable the function generator front-panel display. When it is disabled, the front-panel display is blanked (however, the bulb used to backlight the display remains enabled). The **DISP?** query returns "0" (OFF) or "1" (ON).

- With the front-panel display disabled, there will be some improvement in command execution speed from the remote interface.
- Sending a message to the front-panel display from the remote interface (**DISP:TEXT** command) overrides the display state. This means that you can display a message even if the display is disabled (remote interface errors are always displayed even if the display is disabled).
- The display is automatically enabled when power is cycled, after an instrument reset (***RST** command), or when you return to local (front panel) operation. Press the  key or execute the IEEE-488 GTL (*Go To Local*) command from the remote interface to return to the local state.
- The display state is saved when you store the instrument state using ***SAV** command. When you recall the instrument state using ***RCL** command, the front-panel display will return to the previous state.

System-Related Commands

DISPlay:TEXT <quoted string>

DISPlay:TEXT?

Display a text message on the function generator's front-panel display. Sending a text message to the display overrides the display state as set by the DISP command. The :TEXT? query reads the message sent to the front-panel display and returns a quoted string.

- You can use upper- or lower-case letters (A-Z), numbers (0-9), and any other character on a standard computer keyboard. Depending on the number of characters you specify in the string, the function generator will choose one of two font sizes to display the message. You can display approximately 12 characters in a large font and approximately 40 characters in a small font. An example is shown below.

```
DISP:TEXT 'Test in Progress...'
```

- While a message is displayed, information relating to the output waveform, such as frequency and amplitude, *is not* sent to the front-panel display.

DISPlay:TEXT:CLEAr

Clear the text message currently shown on the function generator's front-panel display.

- If the display is currently enabled (DISP ON command), the DISP:TEXT:CLEAR command will return the normal front-panel display mode.
- If the display is currently disabled (DISP OFF command), the DISP:TEXT:CLEAR command will clear the message but the display will remain disabled. To enable the display, send the DISP ON command, press the **Local** key, or send the GTL (*Go To Local*) command for GPIB or USB. (For LAN you can send the SYST:COMM:RLST LOC command.)

***RST**

Reset the function generator to its factory default state (see “Agilent 33220A Factory Default Settings” in chapter 3) independent of the MEM:STAT:REC:AUTO command setting. This command will abort a sweep or burst in progress and will re-enable the front-panel display if it was previously disabled (DISP OFF command).

***TST?**

Perform a complete self-test of the function generator. Returns “+0” (PASS) or “+1” (FAIL). If the test fails, one or more error messages will be generated to provide additional information on the failure. Use the SYST:ERR? command to read the error queue (see page 242).

SYSTEM:VERSION?

Query the function generator to determine the present SCPI version. Returns a string in the form “YYYY.V”, where “YYYY” represents the year of the version, and “V” represents a version number for that year (e.g., 1997.0).

SYSTEM:BEEPer

Issue a single beep immediately.

SYSTEM:BEEPer:STATe {OFF|ON}

SYSTEM:BEEPer:STATe?

Disable or enable the tone heard when an error is generated from the front-panel or over the remote interface. The current selection is stored in *non-volatile* memory. The :STAT? query returns “0” (OFF) or “1” (ON).

SYSTEM:KLOCK[:STATe] {OFF|ON}

Set front panel keyboard lock OFF (the default) or ON. With :KLOC ON, the front panel keyboard is locked, including the Local key unless it has been excluded. To lock the keyboard *without* locking the Local key, send SYST:KLOC:EXCL LOC *first*, before SYST:KLOC ON.

SYSTEM:KLOCK:EXCLude {NONE|LOCAL}

- Setting :EXCL NONE (the default) sets no exclusion, and SYST:KLOC ON locks the *entire* keyboard including the Local key.
- Setting :EXCL LOC excludes the Local key, and SYST:KLOC ON locks the keyboard, *except* the Local key.

System-Related Commands

SYSTEM:SECURITY:IMMEDIATE

Clears all instrument memory except for the boot parameters and calibration constants. Initializes all instrument settings to their *RST values. ***Destroys all user-defined state information, user-defined arbitrary waveforms, and user-defined I/O settings such as the IP address.*** The built-in arbitrary waveforms are not affected and the VOLATILE waveform persists until the power is turned off. This command is typically used to clear all memory before removing the instrument from a secure area. ***This command is not recommended for use in routine applications because of the possibility of unintended loss of data.***

*LRN?

Query the function generator and return a string of SCPI commands containing the current settings (learn string). You can then send the string back to the instrument to restore this state at a later time. For proper operation, do not modify the returned string before sending it to the function generator. The returned string will contain about 1,500 characters.

*OPC

Set the "Operation Complete" bit (bit 0) in the Standard Event register after all of the previous commands have been completed. Other commands may be executed before the bit is set. This command is used in the triggered sweep or triggered burst modes to provide a way to poll or interrupt the computer when the *TRG command is complete.

*OPC?

Return "1" to the output buffer after the previous commands have been completed. Other commands cannot be executed until this command completes.

*WAI

Wait for all pending operations to complete before executing any additional commands over the interface.

Interface Configuration Commands

See also "Remote Interface Configuration" on page 135 in chapter 3.

SYSTEM:COMMunicate:RLState {LOCAL|REMOte|RWLock}

Set the remote/local state of the function generator over the LAN interface from a Telnet or socket session. Provides control analogous to the IEEE-488.2 commands such as GTL (Go To Local) over the GPIB and USB interfaces.

- LOCAL - (The default). Sets the instrument state to local. Removes any annunciator and unlocks the front panel keyboard.
- REMote - Sets the instrument state to remote. Displays the remote annunciator and locks the keyboard (except the **LOCAL** key).
- RWLock - Sets the instrument state to remote with lock. Displays the rwl annunciator and locks the keyboard (including the **LOCAL** key).

Phase-Lock Commands (Option 001 Only)

The rear-panel *10 MHz In* and *10 MHz Out* connectors (present only if Option 001 is installed) allow synchronization between multiple Agilent 33220A function generators (see connection diagram below) or to an external 10 MHz clock signal. You can also control the phase offset from the front panel or over the remote interface.

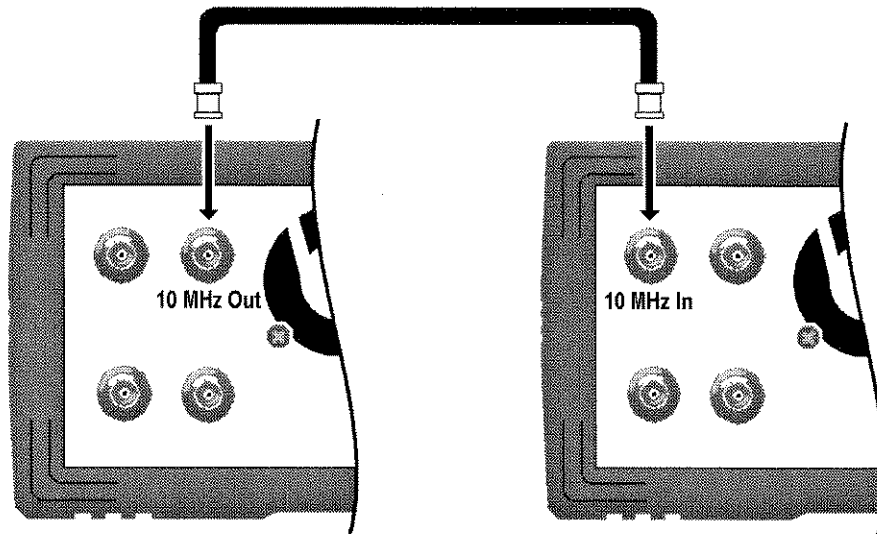

Note: You can use the phase lock commands described below to synchronize multiple 33220A instruments only if **all** of these instruments have Option 001, External Timebase Reference, installed. This option provides the “10 MHz Out” and “10 MHz In” back panel connectors and the circuitry required to synchronize the instruments.

PHASe {<angle> | MINimum | MAXimum}
PHASe? [MINimum | MAXimum]

Adjust the phase offset of the output waveform in degrees or radians as specified by the previous `UNIT:ANGL` command (not available for pulse and noise). Select from -360 degrees to +360 degrees or -2π to $+2\pi$ radians. The default is 0 degrees (0 radians). `MIN` = -360 degrees (-2π radians). `MAX` = +360 degrees ($+2\pi$ radians). The `PHAS?` query returns the phase offset in degrees or radians.

Chapter 4 Remote Interface Reference Phase-Lock Commands (Option 001 Only)

- The specified phase adjustment causes a “bump” or “hop” in the output waveform in order to change the phase relationship to the external signal to which it is currently locked.
- This phase adjustment for phase-lock applications is independent of the burst phase as set by the BURS:PHAS command (see page 220).

UNIT:ANGLE {DEGREE | RADIAN}
UNIT:ANGLE?

Select degrees or radians to set the phase offset value using the PHAS command (remote interface only). The default is DEG. The :ANGL? query returns “DEG” or “RAD”.

- From the front panel, the phase offset is always displayed in degrees (radians are not available). If you set the phase offset in radians from the remote interface and then return to front-panel operation, you will see that the function generator converts the phase offset to degrees.

PHASE:REFERENCE

Immediately set the zero-phase reference point without changing the output of the function generator. This command *does not* change the phase offset as set with the PHAS command – it only changes the phase reference. This command *does not* have a query form.

PHASE:UNLOCK:ERROR:STATE {OFF | ON}
PHASE:UNLOCK:ERROR:STATE?

Disable or enable the function generator from generating an error if the phase-lock is ever lost. The default is OFF. If the phase-lock is lost and the error is enabled, a “Reference phase-locked loop is unlocked” error is generated. The unlock error setting is *not* stored in *non-volatile* memory. That is, the setting will be *lost* when the power is cycled. The :STAT? query returns “0” (OFF) or “1” (ON).

The SCPI Status System

This section describes the structure of the SCPI status system used by the function generator. The status system records various conditions and states of the instrument in several register groups as shown on the following page. Each of the register groups is made up of several low-level registers called Condition registers, Event registers, and Enable registers which control the action of specific bits within the register group.

What is a Condition Register?

A *condition register* continuously monitors the state of the instrument. The bits in the condition register are updated in real time and the bits are not latched or buffered. This is a read-only register and bits are not cleared when you read the register. A query of a condition register returns a decimal value which corresponds to the binary-weighted sum of all bits set in that register.

What is an Event Register?

An *event register* latches the various events from changes in the condition register. There is no buffering in this register; while an event bit is set, subsequent events corresponding to that bit are ignored. This is a read-only register. Once a bit is set, it remains set until cleared by query command (such as `STAT:QUES:EVEN?`) or a `*CLS` (clear status) command. A query of this register returns a decimal value which corresponds to the binary-weighted sum of all bits set in that register.

What is an Enable Register?

An *enable register* defines which bits in the event register will be reported to the Status Byte register group. You can write to or read from an enable register. A `*CLS` (clear status) command *will not* clear the enable register but it does clear all bits in the event register. A `STAT:PRES` command clears all bits in the enable register. To enable bits in the enable register to be reported to the Status Byte register, you must write a decimal value which corresponds to the binary-weighted sum of the corresponding bits.

Agilent 33220A Status System

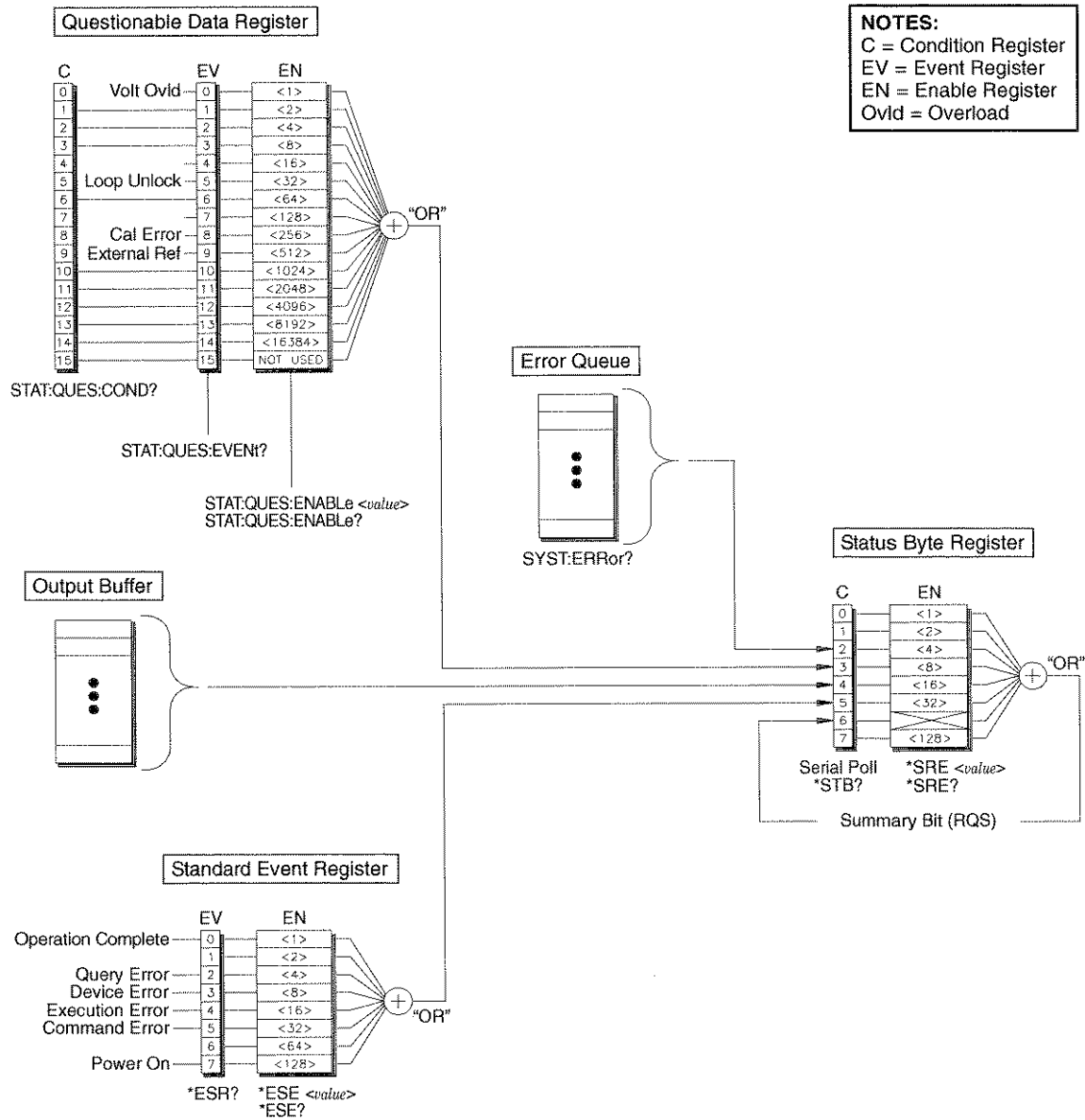

4

The Status Byte Register

The Status Byte summary register reports conditions from the other status registers. Data that is waiting in the function generator's output buffer is immediately reported on the "Message Available" bit (bit 4). Clearing an event register from one of the other register groups will clear the corresponding bits in the Status Byte condition register. Reading all messages from the output buffer, including any pending queries, will clear the "Message Available" bit. To set the enable register mask and generate an SRQ (service request), you must write a decimal value to the register using the *SRE command.

Bit Definitions – Status Byte Register

Bit Number	Decimal Value	Definition
0 <i>Not Used</i>	1	<i>Not Used. Returns "0".</i>
1 <i>Not Used</i>	2	<i>Not Used. Returns "0".</i>
2 Error Queue	4	One or more errors are stored in the Error Queue.
3 Questionable Data	8	One or more bits are set in the Questionable Data Register (bits must be enabled).
4 Message Available	16	Data is available in the instrument's output buffer.
5 Standard Event	32	One or more bits are set in the Standard Event Register (bits must be enabled).
6 Master Summary	64	One or more bits are set in the Status Byte Register (bits must be enabled).
7 <i>Not Used</i>	128	<i>Not Used. Returns "0".</i>

The Status Byte *condition register* is cleared when:

- You execute the *CLS (clear status) command.
- You read the event register from one of the other register groups (only the corresponding bits are cleared in the condition register).

The Status Byte *enable register* is cleared when:

- You execute the *SRE 0 command.
- You turn the power on and have previously configured the function generator to clear the enable register using the *PSC 1 command. Note that the enable register *will not* be cleared at power-on if you have configured the function generator using the *PSC 0 command.

Using Service Request (SRQ) and Serial Poll

You must configure your computer to respond to the IEEE-488 service request (SRQ) interrupt to use this capability. Use the Status Byte enable register (*SRE command) to select which condition bits will assert the IEEE-488 SRQ line. If bit 6 (RQS) transitions from a “0” to a “1”, then an IEEE-488 service request message is sent to your computer. The computer may then poll the instruments on the interface bus to identify which one is asserting the service request line (that is, the instrument with bit 6 set in its Serial Poll response).

When a Serial Poll is issued, bit 6 (RQS) is cleared in the Serial Poll response (no other bits are affected) and the service request line is cleared. The “Master Summary Bit” in the *STB? response is not cleared.

To obtain the Serial Poll response, send an IEEE-488 Serial Poll message. The instrument sends a one-byte binary response. Performing a Serial Poll is handled automatically by the IEEE-488 bus interface hardware.

Unlike ASCII commands, and some other GPIB commands, a Serial Poll is executed immediately and does not involve the instrument’s main processor. Therefore, the status indicated by a Serial Poll may not necessarily indicate the effect of the most recent command. Use the *OPC? command to guarantee that commands previously sent to the instrument have completed before executing a Serial Poll.

Using *STB? to Read the Status Byte

The *STB? command is similar to a Serial Poll but it is processed like any other ASCII instrument command. The *STB? command returns the same result as a Serial Poll but bit 6 *is not* cleared as long as the enabled conditions remain.

The *STB? command is not handled automatically by the IEEE-488 bus interface hardware and will be executed only after previous commands have completed. You cannot clear an SRQ using the *STB? command.

Using the Message Available Bit (MAV)

You can use the Status Byte “Message Available” bit (bit 4) to determine when data is available to read into your computer. The instrument subsequently clears bit 4 only after all messages have been read from the output buffer.

To Interrupt Your Computer Using SRQ

1. Send a Device Clear message to return the function generator to a responsive state and clear its output buffer (e.g., CLEAR 710).
2. Clear the event registers and error queue using the *CLS command.
3. Set up the enable register masks. Use the *ESE command to configure the Standard Event enable register and the *SRE command to configure the Status Byte enable register.
4. Send the *OPC? command and read the result to ensure synchronization.
5. Enable your computer’s IEEE-488 SRQ interrupt.

4

To Determine When a Command Sequence is Completed

1. Send a Device Clear message to return the function generator to a responsive state and clear its output buffer (e.g., CLEAR 710).
2. Clear the event registers and error queue using the *CLS command.
3. Enable the “Operation Complete” bit (bit 0) in the Standard Event register by executing the *ESE 1 command.
4. Send the *OPC? command and read the result to ensure synchronization.
5. Execute your command string to program the desired configuration, and then execute the *OPC command as the last command. When the command sequence is completed, the “Operation Complete” bit (bit 0) is set in the Standard Event register.
6. Use a Serial Poll to check to see when bit 5 (routed from the Standard Event register) is set in the Status Byte condition register. You could also configure the function generator for an SRQ interrupt by sending *SRE 32 (Status Byte enable register, bit 5).

The SCPI Status System**The Questionable Data Register**

The Questionable Data register group provides information about the quality or integrity of the function generator. Any or all of these conditions can be reported to the Questionable Data summary bit through the *enable register*. To set the enable register mask, you must write a decimal value to the register using the `STAT:QUES:ENABLE` command.

Bit Definitions – Questionable Data Register

Bit Number	Decimal Value	Definition
0 Voltage Overload	1	Voltage overload on OUTPUT connector. The Output has been disabled.
1 <i>Not Used</i>	2	<i>Not Used. Returns "0".</i>
2 <i>Not Used</i>	4	<i>Not Used. Returns "0".</i>
3 <i>Not Used</i>	8	<i>Not Used. Returns "0".</i>
4 <i>Not Used</i>	16	<i>Not Used. Returns "0".</i>
5 Loop Unlocked	32	Function generator has lost phase lock. Frequency accuracy will be affected.
6 <i>Not Used</i>	64	<i>Not Used. Returns "0".</i>
7 <i>Not Used</i>	128	<i>Not Used. Returns "0".</i>
8 Calibration Error	256	Error occurred during cal, or cal memory lost, or calibration is unsecured.
9 External Reference	512	External timebase is being used.
10 <i>Not Used</i>	1024	<i>Not Used. Returns "0".</i>
11 <i>Not Used</i>	2048	<i>Not Used. Returns "0".</i>
12 <i>Not Used</i>	4096	<i>Not Used. Returns "0".</i>
13 <i>Not Used</i>	8192	<i>Not Used. Returns "0".</i>
14 <i>Not Used</i>	16384	<i>Not Used. Returns "0".</i>
15 <i>Not Used</i>	32768	<i>Not Used. Returns "0".</i>

Chapter 4 Remote Interface Reference
The SCPI Status System

The Questionable Data *event register* is cleared when:

- You execute the *CLS (clear status) command.
- You query the event register using the STAT:QUES:EVEN? command.

The Questionable Data *enable register* is cleared when:

- You turn on the power (the *PSC command does not apply).
- You execute the STAT:PRES command.
- You execute the STAT:QUES:ENAB 0 command.

The Standard Event Register

The Standard Event register group reports the following types of events: power-on detected, command syntax errors, command execution errors, self-test or calibration errors, query errors, or the *OPC command has been executed. Any or all of these conditions can be reported to the Standard Event summary bit through the *enable register*. To set the enable register mask, you must write a decimal value to the register using the *ESE command.

Bit Definitions – Standard Event Register

Bit Number	Decimal Value	Definition
0 Operation Complete	1	All commands prior to and including *OPC have completed <u>and</u> the overlapped command (e.g., *TRG for burst) has completed.
1 <i>Not Used</i>	2	<i>Not Used. Returns "0".</i>
2 Query Error	4	The instrument tried to read the output buffer but it was empty. Or, a new command line was received before a previous query has been read. Or, both the input and output buffers are full.
3 Device Error	8	A self-test, cal, or other device-specific error has occurred (see chapter 5).
4 Execution Error	16	An execution error has occurred (see chapter 5).
5 Command Error	32	A command syntax error has occurred (see chapter 5).
6 <i>Not Used</i>	64	<i>Not Used. Returns "0".</i>
7 Power On	128	Power has been cycled on since the last time the event register was read or cleared.

The Standard *event register* is cleared when:

- You execute the *CLS command.
- You query the event register using the *ESR? command.

The Standard Event *enable register* is cleared when:

- You execute the *ESE 0 command.
- You turn the power on and have previously configured the function generator to clear the enable register using the *PSC 1 command. Note that the enable register *will not* be cleared at power-on if you have configured the function generator using the *PSC 0 command.

Status Reporting Commands

An application program is included in chapter 6 which shows the use of the Status System Registers. See page 301 for more information.

Status Byte Register Commands

See the table on page 252 for the register bit definitions.

*STB?

Query the summary (condition) register in this register group. This command is similar to a Serial Poll but it is processed like any other instrument command. This command returns the same result as a Serial Poll but the “Master Summary” bit (bit 6) *is not* cleared by the *STB? command.

*SRE <enable value>

*SRE?

Enable bits in the Status Byte to generate a Service Request. To enable specific bits, you must write a decimal value which corresponds to the binary-weighted sum of the bits in the register. The selected bits are summarized in the “Master Summary” bit (bit 6) of the Status Byte Register. If any of the selected bits change from “0” to “1”, a Service Request signal is generated. The *SRE? query returns a decimal value which corresponds to the binary-weighted sum of all bits enabled by the *SRE command.

- A *CLS (clear status) *does not* clear the enable register but it does clear all bits in the event register.
- A STATUS:PRESet *does not* clear the bits in the Status Byte enable register.
- A *PSC 0 preserves the contents of the enable register through power cycles.

Questionable Data Register Commands

See the table on page 256 for the register bit definitions.

STATUS:QUESTIONABLE:CONDITION?

Query the condition register in this group. This is a read-only register and bits are not cleared when you read the register. A query of this register returns a decimal value which corresponds to the binary-weighted sum of all bits set in the register.

STATUS:QUESTIONABLE[:EVENT]?

Query the event register in this register group. This is a read-only register. Once a bit is set, it remains set until cleared by this command or *CLS (clear status) command. A query of this register returns a decimal value which corresponds to the binary-weighted sum of all bits set in the register.

STATUS:QUESTIONABLE:ENABLE <enable value>

STATUS:QUESTIONABLE:ENABLE?

Enable bits in the enable register in this register group. The selected bits are then reported to the Status Byte. A *CLS (clear status) *will not* clear the enable register but it does clear all bits in the event register. The STATUS:PRESet command clears all bits in the enable register. To enable bits in the enable register, you must write a decimal value which corresponds to the binary-weighted sum of the bits you wish to enable in the register.

The :ENAB? query returns a decimal value which corresponds to the binary-weighted sum of all bits enabled by the STAT:QUES:ENAB command.

Standard Event Register Commands

See the table on page 258 for the register bit definitions.

*ESR?

Query the Standard Event Status Register. Once a bit is set, it remains set until cleared by a *CLS (clear status) command or queried by this command. A query of this register returns a decimal value which corresponds to the binary-weighted sum of all bits set in the register.

*ESE <enable value>

*ESE?

Enable bits in the Standard Event Status Register to be reported in the Status Byte. The selected bits are summarized in the "Standard Event" bit (bit 5) of the Status Byte Register. The *ESE? query returns a decimal value which corresponds to the binary-weighted sum of all bits enabled by the *ESE command.

- A *CLS (clear status) *does not* clear the enable register but it does clear all bits in the event register.
- A STATUS:PRESet *does not* clear the bits in the Status Byte enable register.
- A *PSC 0 preserves the contents of the enable register through power cycles.

Miscellaneous Status Register Commands

***CLS**

Clear the event register in all register groups. This command also clears the error queue and cancels a *OPC operation.

STATUS:PRESet

Clear all bits in the Questionable Data enable register and the Standard Operation enable register.

***PSC {0|1}**

***PSC?**

Power-On Status Clear. Clear the Standard Event enable register and Status Byte condition register at power on (*PSC 1). When *PSC 0 is in effect, these two registers *are not* cleared at power on. The default is *PSC 1. The *PSC? query returns the power-on status clear setting. Returns "0" (do not clear at power on) or "1" (clear at power on).

***OPC**

Set the "Operation Complete" bit (bit 0) in the Standard Event register after the previous commands have completed. When used with a bus-triggered sweep or burst, you may have the opportunity to execute commands *after* the *OPC command and *before* the "Operation Complete" bit is set in the register.

Calibration Commands

For an overview of the calibration features of the function generator, refer to “Calibration Overview” in chapter 3 starting on page 141. For a detailed discussion of the function generator’s calibration procedures, refer to chapter 4 in the Agilent 33220A *Service Guide*.

CALibration:SECure:STATE {OFF|ON}, <code>
CALibration:SECure:STATE?

Unsecure or secure the instrument for calibration. The calibration code may contain up to 12 characters. The :STAT? query returns “0” (OFF) or “1” (ON).

CALibration:SETup <0|1|2|3| . . . |94>
CALibration:SETup?

Configure the function generator’s internal state for each of the calibration steps to be performed. The :SET? query reads the calibration setup number and returns a value from “0” to “94”.

CALibration:VALue <value>
CALibration:VALue?

Specify the value of the known calibration signal as outlined in the calibration procedures in the Agilent 33220A *Service Guide*. Use the CAL:SET command to configure the function generator’s internal state for each of the calibration steps to be performed. The :VAL? query returns a number in the form “+1.0000000000000E+01”.

CALibration?

Perform a calibration of the instrument using the specified calibration value (CAL:VAL command). Before you can calibrate the function generator, you must unsecure it by entering the correct security code. Returns “0” (PASS) or “1” (FAIL).

CALibration:SECure:CODE *<new code>*

Enter a new security code. To change the security code, you must first unsecure the function generator using the old security code, and then enter a new code. The security code is stored in *non-volatile* memory.

- The calibration code may contain up to 12 characters. The first character *must* be a letter (A-Z), but the remaining characters can be letters, numbers (0-9), or the underscore character (“_”). You do not have to use all 12 characters, but the first character *must* always be a letter.

CALibration:COUNT?

Query the instrument to determine the number of times it has been calibrated. Note that your instrument was calibrated before it left the factory. When you receive your instrument from the factory, be sure to read the count to determine its initial value.

- The calibration count is stored in *non-volatile* memory. The count increments up to a maximum of “65,535” after which it rolls over to “0”. Since the value increments by one for each calibration point, a complete calibration may increase the value by many counts.

CALibration:STRing *<quoted string>*

CALibration:STRing?

Store a message in *non-volatile* calibration memory. Storing a message will overwrite any message previously stored in memory. The **:STR?** query reads the calibration message and returns a quoted string.

- The calibration message may contain up to 40 characters (additional characters are truncated). An example is shown below.

```
CAL:STR 'Cal Due: 01 June 2003'
```

- You can record a calibration message *only* from the remote interface and *only* when the instrument is unsecured. You can read the message either from the front panel or over the remote interface. You can *read* the calibration message whether the instrument is secured or unsecured.

An Introduction to the SCPI Language

SCPI (*Standard Commands for Programmable Instruments*) is an ASCII-based instrument command language designed for test and measurement instruments. Refer to “Simplified Programming Overview” starting on page 161, for an introduction to the basic techniques used to program the function generator over the remote interface.

SCPI commands are based on a hierarchical structure, also known as a *tree system*. In this system, associated commands are grouped together under a common node or root, thus forming *subsystems*. A portion of the `SOURCE` subsystem is shown below to illustrate the tree system.

```
SOURCE:
  FREQUENCY
    :START {<frequency>|MINimum|MAXimum}
    :START? [MINimum|MAXimum]

  FREQUENCY
    :STOP {<frequency>|MINimum|MAXimum}
    :STOP? [MINimum|MAXimum]

  SWEep
    :SPACing {LINear|LOGarithmic}
    :SPACing?

  SWEep
    :TIME {<seconds>|MINimum|MAXimum}
    :TIME? [MINimum|MAXimum]

  SWEep
    :STATE {OFF|ON}
    :STATE?
```

`SOURCE` is the root keyword of the command, `FREQUENCY` and `SWEep` are second-level keywords, and `START` and `STOP` are third-level keywords. A colon (:) separates a command keyword from a lower-level keyword.

Command Format Used in This Manual

The format used to show commands in this manual is illustrated below:

```
FREQuency { <frequency> | MINimum | MAXimum }
```

The command syntax shows most commands (and some parameters) as a mixture of upper- and lower-case letters. The upper-case letters indicate the abbreviated spelling for the command. For shorter program lines, you can send the abbreviated form. For better program readability, you can send the long form.

For example, in the above syntax statement, `FREQ` and `FREQUENCY` are both acceptable forms. You can use upper- or lower-case letters. Therefore, `FREQUENCY`, `freq`, and `Freq` are all acceptable. Other forms, such as `FRE` and `FREQUEN`, will generate an error.

- *Braces* ({ }) enclose the parameter choices for a given command string. The braces *are not* sent with the command string.
- A *vertical bar* (|) separates multiple parameter choices for a given command string.
- *Triangle brackets* (< >) indicate that you must specify a value for the enclosed parameter. For example, the above syntax statement shows the *frequency* parameter enclosed in triangle brackets. The brackets *are not* sent with the command string. You must specify a value for the parameter (such as "FREQ 5000").
- Some parameters are enclosed in *square brackets* ([]). The square brackets indicate that the parameter is optional and can be omitted. The brackets *are not* sent with the command string. If you do not specify a value for an optional parameter, the function generator chooses a default value.

Command Separators

A *colon* (:) is used to separate a command keyword from a lower-level keyword. You must insert a *blank space* to separate a parameter from a command keyword. If a command requires more than one parameter, you must separate adjacent parameters using a *comma* as shown below:

```
"APPL:SIN 5 KHZ, 3.0 VPP, -2.5 V"
```

A *semicolon* (;) is used to separate commands within the same subsystem, and can also minimize typing. For example, sending the following command string:

```
"FREQ:START 10; STOP 1000"
```

... is the same as sending the following two commands:

```
"FREQ:START 10"  
"FREQ:STOP 1000"
```

Use a colon *and* a semicolon to link commands from *different* subsystems. For example, in the following command string, an error is generated if you do not use both the colon *and* semicolon:

```
"SWE:STAT ON; :TRIG:SOUR EXT"
```

Using the *MIN* and *MAX* Parameters

You can substitute "MINimum" or "MAXimum" in place of a parameter for many commands. For example, consider the following command:

```
FREQuency {<frequency>|MINimum|MAXimum}
```

Instead of selecting a specific frequency, you can substitute MIN to set the frequency to its minimum value or MAX to set the frequency to its maximum value.

Querying Parameter Settings

You can query the current value of most parameters by adding a *question mark* (“?”) to the command. For example, the following command sets the output frequency to 5 kHz:

```
"FREQ 5000"
```

You can then query the frequency value by executing:

```
"FREQ?"
```

You can also query the minimum or maximum frequency allowed with the present function as follows:

```
"FREQ? MIN"  
"FREQ? MAX"
```

SCPI Command Terminators

A command string sent to the function generator *must* terminate with a *<new line>* character. The IEEE-488 *EOI* (End-Or-Identify) message is interpreted as a *<new line>* character and can be used to terminate a command string in place of a *<new line>* character. A *<carriage return>* followed by a *<new line>* is also accepted. Command string termination will *always* reset the current SCPI command path to the root level.

4

IEEE-488.2 Common Commands

The IEEE-488.2 standard defines a set of *common commands* that perform functions such as reset, self-test, and status operations. Common commands always begin with an asterisk (*), are three characters in length, and may include one or more parameters. The command keyword is separated from the first parameter by a *blank space*. Use a *semicolon* (;) to separate multiple commands as shown below:

```
"*RST; *CLS; *ESE 32; *OPC?"
```

SCPI Parameter Types

The SCPI language defines several different data formats to be used in program messages and response messages.

Numeric Parameters Commands that require numeric parameters will accept all commonly used decimal representations of numbers including optional signs, decimal points, and scientific notation. Special values for numeric parameters like `MINimum`, `MAXimum`, and `DEFault` are also accepted. You can also send engineering unit suffixes with numeric parameters (e.g., `Mhz` or `Khz`). If only specific numeric values are accepted, the function generator will automatically round the input numeric parameters. The following command uses a numeric parameter:

```
FREQuency {<frequency>|MINimum|MAXimum}
```

Discrete Parameters Discrete parameters are used to program settings that have a limited number of values (like `BUS`, `IMMEDIATE`, `EXTERNAL`). They have a short form and a long form just like command keywords. You can mix upper- and lower-case letters. Query responses will always return the short form in all upper-case letters. The following command uses discrete parameters:

```
SWEep:SPACing {LINear|LOGarithmic}
```

Boolean Parameters Boolean parameters represent a single binary condition that is either true or false. For a false condition, the function generator will accept “OFF” or “0”. For a true condition, the function generator will accept “ON” or “1”. When you query a boolean setting, the instrument will *always* return “0” or “1”. The following command uses a boolean parameter:

```
AM:STATE {OFF|ON}
```

String Parameters String parameters can contain virtually any set of ASCII characters. A string *must* begin and end with matching quotes; either with a single quote or a double quote. You can include the quote delimiter as part of the string by typing it twice without any characters in between. The following command uses a string parameter:

```
DISPlay:TEXT <quoted string>
```

Using Device Clear

Device Clear is an IEEE-488 low-level bus message that you can use to return the function generator to a responsive state. Different programming languages and IEEE-488 interface cards provide access to this capability through their own unique commands. The status registers, the error queue, and all configuration states are left unchanged when a Device Clear message is received. Device Clear performs the following actions.

- The function generator's input and output buffers are cleared.
- The function generator is prepared to accept a new command string.
- An overlapped command, if any, will be terminated with no "Operation Complete" indication (applies to the *TRG command). Any sweep or burst in progress will be aborted immediately.

Chapter 4 Remote Interface Reference
Using Device Clear

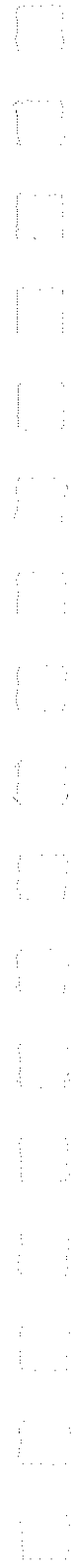

Error Messages

Command Errors

- 112 Program mnemonic too long**
A command header was received which contained more than the maximum 12 characters allowed. This error is also reported when a character-type parameter is too long. *Example:* OUTP:SYNCHRONIZATION ON
- 113 Undefined header**
A command was received that is not valid for this instrument. You may have misspelled the command or it may not be a valid command. If you are using the short form of the command, make sure that it is correctly abbreviated. *Example:* TRIGG:SOUR BUS
- 123 Exponent too large**
A numeric parameter was found whose exponent was larger than 32,759. *Example:* BURS:NCYCL 1E34000
- 124 Too many digits**
A numeric parameter was found whose mantissa contained more than 255 digits, excluding leading zeros.
- 128 Numeric data not allowed**
A numeric parameter was received but a character string was expected. *Example:* DISP:TEXT 123
- 131 Invalid suffix**
A suffix was incorrectly specified for a numeric parameter. You may have misspelled the suffix. *Example:* SWE:TIME 0.5 SECS
- 138 Suffix not allowed**
A suffix is not supported for this command. *Example:* BURS:NCYC 12 CYC
- 148 Character data not allowed**
A discrete parameter was received but a character string or numeric parameter was expected. Check the list of parameters to verify that you have used a valid parameter type. *Example:* DISP:TEXT ON
- 151 Invalid string data**
An invalid character string was received. Check to see if you have enclosed the character string in quotation marks and verify that the string contains valid ASCII characters. *Example:* DISP:TEXT 'TESTING (the ending quote is missing)

- 158 String data not allowed**
A character string was received but is not allowed for this command. Check the list of parameters to verify that you have used a valid parameter type. *Example:* BURS:NCYC 'TEN'
- 161 Invalid block data**
Applies only to the DATA:DAC VOLATILE command.
For a definite-length block, the number of bytes of data sent does not match the number of bytes that you specified in the block header. For an indefinite-length block, an EOI (End-or-Identify) was received without an accompanying *<new line>* character.
- 168 Block data not allowed**
Data was sent to the function generator in arbitrary block format but this command does not accept this format. Check to see if you have sent the correct data type with the command. *Example:* BURS:NCYC #10
- 170 to -178 Expression errors**
The function generator does not accept mathematical expressions.

Execution Errors

- 211** **Trigger ignored**
A Group Execute Trigger (GET) or *TRG was received but the trigger was ignored. Make sure that you have selected the proper trigger source and verify that the sweep or burst mode is enabled.
- 223** **Too much data**
An arbitrary waveform was specified that contains more than 65,536 waveform points. Verify the number of points in the DATA VOLATILE or DATA:DAC VOLATILE command.
- 221** **Settings conflict;
turned off infinite burst to allow immediate trigger source**
An infinite count burst is allowed only when the *external* or *bus* (software) trigger source is selected. The burst count has been set to the maximum N Cycle value (50,000 cycles).
- 221** **Settings conflict;
infinite burst changed trigger source to BUS**
An infinite count burst is allowed only when the *external* or *bus* (software) trigger source is selected. Sending the BURS:NCYC INF command has automatically changed the trigger source from *immediate* to *bus*.
- 221** **Settings conflict;
burst period increased to fit entire burst**
The number of cycles specified by the BURS:NCYC command takes priority over the burst period (as long as the burst period is not at its maximum value). The function generator has increased the burst period to accommodate the specified burst count or waveform frequency.
- 221** **Settings conflict;
burst count reduced to fit entire burst**
Since the burst period is currently at its maximum, the function generator has reduced the burst count to allow the specified waveform frequency.

- 221 **Settings conflict;
triggered burst not available for noise**
You cannot use the noise function in the *triggered* burst mode. Noise is allowed only in the *gated* burst mode.
- 221 **Settings conflict;
amplitude units changed to Vpp due to high-Z load**
The output units (VOLT:UNIT command) cannot be set to dBm if the output termination is currently set to “high impedance” (OUTP:LOAD command). The function generator has converted the units to Vpp.
- 221 **Settings conflict;
trigger output disabled by trigger external**
When the *external* trigger source is selected (TRIG:SOUR EXT command), the function generator automatically disables the “trigger out” signal. The rear-panel *Trig* connector cannot be used for both operations at the same time.
- 221 **Settings conflict;
trigger output connector used by FSK**
If you have enabled FSK and have selected the *external* source (FSK:SOUR EXT command), the “trigger out” signal cannot be enabled (OUTP:TRIG ON command). The rear-panel *Trig* connector cannot be used for both operations at the same time.
- 221 **Settings conflict;
trigger output connector used by burst gate**
If you have selected the gated burst mode (BURS:MODE GAT command) with burst enabled, the “trigger out” signal cannot be enabled (OUTP:TRIG ON command). The rear-panel *Trig* connector cannot be used for both operations at the same time.

Execution Errors

- 221** **Settings conflict;
trigger output connector used by trigger external**
When the *external* trigger source is selected (TRIG:SOUR EXT command), the function generator automatically disables the “trigger out” signal. The rear-panel *Trig* connector cannot be used for both operations at the same time.
- 221** **Settings conflict;
frequency reduced for user function**
For arbitrary waveforms, the output frequency is limited to 6 MHz. When you change to the arbitrary waveform function (APPL:USER or FUNC:USER command) from a function that allows a higher frequency, the function generator will automatically adjust the frequency to 6 MHz.
- 221** **Settings conflict;
frequency changed for pulse function**
For pulse waveforms, the output frequency is limited to 5 MHz. When you change to the pulse function (APPL:PULS or FUNC:PULS command) from a function that allows a higher frequency, the function generator will automatically adjust the frequency to 5 MHz.
- 221** **Settings conflict;
frequency reduced for ramp function**
For ramp waveforms, the output frequency is limited to 200 kHz. When you change to the ramp function (APPL:RAMP or FUNC:RAMP command) from a function that allows a higher frequency, the function generator will automatically adjust the frequency to 200 kHz.
- 221** **Settings conflict;
frequency made compatible with burst mode**
For an internally-triggered burst, the output frequency is limited to a minimum of 2 mHz. The function generator has adjusted the frequency to be compatible with the current settings.
- 221** **Settings conflict;
burst turned off by selection of other mode or modulation**
The function generator will allow only one modulation, sweep, or burst mode to be enabled at the same time. When you enable a modulation, sweep, or burst mode, all other modes are turned off.

- 221 **Settings conflict;**
FSK turned off by selection of other mode or modulation
The function generator will allow only one modulation, sweep, or burst mode to be enabled at the same time. When you enable a modulation, sweep, or burst mode, all other modes are turned off.
- 221 **Settings conflict;**
FM turned off by selection of other mode or modulation
The function generator will allow only one modulation, sweep, or burst mode to be enabled at the same time. When you enable a modulation, sweep, or burst mode, all other modes are turned off.
- 221 **Settings conflict;**
AM turned off by selection of other mode or modulation
The function generator will allow only one modulation, sweep, or burst mode to be enabled at the same time. When you enable a modulation, sweep, or burst mode, all other modes are turned off.
- 221 **Settings conflict;**
PM turned off by selection of other mode or modulation
The function generator will allow only one modulation, sweep, or burst mode to be enabled at the same time. When you enable a modulation, sweep, or burst mode, all other modes are turned off.
- 221 **Settings conflict;**
PWM turned off by selection of other mode or modulation
The function generator will allow only one modulation, sweep, or burst mode to be enabled at the same time. When you enable a modulation, sweep, or burst mode, all other modes are turned off.
- 221 **Settings conflict;**
sweep turned off by selection of other mode or modulation
The function generator will allow only one modulation, sweep, or burst mode to be enabled at the same time. When you enable a modulation, sweep, or burst mode, all other modes are turned off.
- 221 **Settings conflict;**
not able to modulate this function
The function generator cannot generate an AM, FM, PM, or FSK modulated waveform using the pulse, noise, or dc voltage functions.

Execution Errors

- 221** **Settings conflict;
PWM only available in pulse function**
The function generator cannot generate a PWM modulated waveform using any function other than pulse.
- 221** **Settings conflict;
not able to sweep this function**
The function generator cannot generate a sweep using the pulse, noise, or dc voltage functions.
- 221** **Settings conflict;
not able to burst this function**
The function generator cannot generate a burst using the dc voltage function.
- 221** **Settings conflict;
not able to modulate noise, modulation turned off**
The function generator cannot generate a modulated waveform using the noise function. The selected modulation mode has been turned off.
- 221** **Settings conflict;
not able to sweep pulse, sweep turned off**
The function generator cannot generate a sweep using the pulse function. The sweep mode has been turned off.
- 221** **Settings conflict;
not able to modulate dc, modulation turned off**
The function generator cannot generate a modulated waveform using the dc voltage function. The selected modulation mode has been turned off.
- 221** **Settings conflict;
not able to sweep dc, sweep turned off**
The function generator cannot generate a sweep using the dc voltage function. The sweep mode has been turned off.
- 221** **Settings conflict;
not able to burst dc, burst turned off**
The function generator cannot generate a burst using the dc voltage function. The burst mode has been turned off.

- 221** **Settings conflict;
not able to sweep noise, sweep turned off**
The function generator cannot generate a sweep using the noise function.
The sweep mode has been turned off.
- 221** **Settings conflict;
pulse width decreased due to period**
For a pulse waveform, the function generator will automatically adjust the waveform parameters in the following order as needed to generate a valid pulse: (1) edge time, (2) pulse width or duty cycle, and then (3) period.

In this case, the function generator has decreased the pulse width to accommodate the specified period (the edge time is already at its minimum setting).
- 221** **Settings conflict;
pulse duty cycle decreased due to period**
For a pulse waveform, the function generator will automatically adjust the waveform parameters in the following order as needed to generate a valid pulse: (1) edge time, (2) pulse width or duty cycle, and then (3) period.

In this case, the function generator has decreased the pulse duty cycle to accommodate the specified period (the edge time is already at its minimum setting).
- 221** **Settings conflict;
edge time decreased due to period**
For a pulse waveform, the function generator will automatically adjust the waveform parameters in the following order as needed to generate a valid pulse: (1) edge time, (2) pulse width or duty cycle, and then (3) period.

In this case, the function generator has decreased the edge time to accommodate the specified period and preserve the pulse width setting.
- 221** **Settings conflict;
pulse width increased due to large period**
For a pulse waveform, the minimum pulse width is 20 ns for periods up to 10 seconds. For periods above 10 seconds, the minimum pulse width is greater. The function generator has adjusted the pulse width to the new minimum determined by the current period. See “Pulse Configuration Commands” in chapter 4 for further information.

Execution Errors

-221

**Settings conflict;
edge time decreased due to pulse width**

For a pulse waveform, the function generator will automatically adjust the waveform parameters in the following order as needed to generate a valid pulse: (1) edge time, (2) pulse width or duty cycle, and then (3) period.

In this case, the function generator has decreased the edge time to accommodate the specified pulse width.

$$\text{Edge Time} \leq 0.625 \times \text{Pulse Width}$$

-221

**Settings conflict;
edge time decreased due to pulse duty cycle**

For a pulse waveform, the function generator will automatically adjust the waveform parameters in the following order as needed to generate a valid pulse: (1) edge time, (2) pulse width or duty cycle, and then (3) period.

In this case, the function generator has decreased the edge time to accommodate the specified pulse duty cycle.

$$\text{Edge Time} \leq 0.625 \times \text{Period} \times \text{Duty Cycle} \div 100$$

-221

**Settings conflict;
amplitude changed due to function**

In some cases, the amplitude limits are determined by the output units currently selected. This may occur when the units are *Vrms* or *dBm* due to the differences in crest factor for the various output functions.

For example, if you output a 5 *Vrms* square wave (into 50 ohms) and then change to the sine wave function, the function generator will automatically adjust the output amplitude to 3.536 *Vrms* (upper limit for sine waves in *Vrms*).

-221

**Settings conflict;
offset changed on exit from dc function**

In the dc voltage function, the voltage level is controlled by adjusting the offset voltage (the current amplitude is ignored). When you select a different function, the function generator will adjust the offset voltage as needed to be compatible with the current amplitude setting.

- 221** **Settings conflict;**
FM deviation cannot exceed carrier
The carrier frequency must always be greater than or equal to the frequency deviation. If you set the carrier to a value less than the deviation frequency (with FM enabled), the function generator will automatically adjust the deviation to the maximum value allowed with the present carrier frequency.
- 221** **Settings conflict;**
FM deviation exceeds max frequency
The sum of the carrier frequency and deviation must be less than or equal to the maximum frequency for the selected function *plus 100 kHz* (20.1 MHz for sine and square, 300 kHz for ramp, and 5.1 MHz for arbitrary waveforms). If you set the carrier to a value that is not valid, the function generator will automatically adjust the deviation to the maximum value allowed with the present carrier frequency.
- 221** **Settings conflict;**
PWM deviation decreased due to pulse parameters
The PWM deviation is limited by the pulse width or duty cycle, edge time, and period. The PWM deviation (width or duty cycle deviation) is adjusted to fit within these limits. See “Pulse Width Modulation (PWM Commands)” in chapter 4 for further information.
- 221** **Settings conflict;**
frequency forced duty cycle change
If the square wave function is selected and you change to a frequency that cannot produce the current duty cycle, the duty cycle is automatically adjusted to the maximum value for the new frequency. For example, if you currently have the duty cycle set to 70% and then change the frequency to 15 MHz, the function generator will automatically adjust the duty cycle to 60% (upper limit for this frequency).
- Duty Cycle: 20% to 80% (*frequency* ≤ 10 MHz)
 40% to 60% (*frequency* > 10 MHz)
- 221** **Settings conflict;**
marker forced into sweep span
The marker must be within the sweep span, between the start and stop frequency. The marker frequency is forced into that range.

Execution Errors

- 221** **Settings conflict;
selected arb is missing, changing selection to default**
If you delete an arbitrary waveform from non-volatile memory after storing the instrument state, the waveform data is lost and the function generator *will not* output the waveform when the state is recalled. The built-in “exponential rise” waveform is output in place of the deleted waveform.
- 221** **Settings conflict;
offset changed due to amplitude**
The relationship between offset voltage and output amplitude is shown below. V_{max} is the maximum peak voltage for the selected output termination (5 volts for a 50 Ω load or 10 volts for a high-impedance load). If the existing offset voltage is not valid, the function generator will automatically adjust it to the maximum dc voltage allowed with the amplitude specified.
- $$|V_{offset}| \leq V_{max} - \frac{V_{pp}}{2}$$
- 221** **Settings conflict;
amplitude changed due to offset**
The relationship between output amplitude and offset voltage is shown below. V_{max} is the maximum peak voltage for the selected output termination (5 volts for a 50 Ω load or 10 volts for a high-impedance load). If the existing amplitude is not valid, the function generator will automatically adjust it to the maximum value allowed with the offset voltage specified.
- $$V_{pp} \leq 2 \times (V_{max} - |V_{offset}|)$$
- 221** **Settings conflict;
low level changed due to high level**
You can set the levels to a positive or negative value, but note that the high level *must* always be greater than the low level. If you specify a high level that is less than the existing low level, the function generator will automatically set the low level to be 1 mV less than the high level.

- 221** **Settings conflict;**
high level changed due to low level
You can set the levels to a positive or negative value, but note that the high level *must* always be greater than the low level. If you specify a low level that is greater than the existing high level, the function generator will automatically set the high level to be 1 mV greater than the low level.
- 222** **Data out of range;**
value clipped to upper limit
The specified parameter is outside of the function generator's capability. The function generator has adjusted the parameter to the maximum value allowed. *Example:* PHAS 1000
- 222** **Data out of range;**
value clipped to lower limit
The specified parameter is outside of the function generator's capability. The function generator has adjusted the parameter to the minimum value allowed. *Example:* PHAS -1000
- 222** **Data out of range;**
pulse edge time limited by period; value clipped to upper limit
The specified edge time must fit within the existing period and width. The function generator will limit the edge time as needed to accommodate the existing period.
- 222** **Data out of range;**
pulse width limited by period; value clipped to ...
The specified pulse width must be less than the difference between the *period* and the *edge time* as shown below. The function generator will adjust the pulse width as needed to accommodate the specified period.
- $\text{Pulse Width} \leq \text{Period} - (1.6 \times \text{Edge Time})$
- 222** **Data out of range;**
pulse duty cycle limited by period; value clipped to ...
The specified pulse duty cycle must conform to the following period and edge time restriction. The function generator will adjust the pulse duty cycle as needed to accommodate the specified period.
- $\text{Duty Cycle} \leq 100 \times (\text{Period} - (1.6 \times \text{Edge Time})) \div \text{Period}$

Execution Errors

**-222 Data out of range;
large period limits minimum pulse width**
For a pulse waveform, the minimum pulse width is 20 ns for periods up to 10 seconds. For periods above 10 seconds, the minimum pulse width is greater. See "Pulse Configuration Commands" in chapter 4 for further information.

**-222 Data out of range;
pulse edge time limited by width; value clipped to ...**
The specified edge time must fit within the specified pulse width as shown below. The function generator will adjust the edge time as needed to accommodate the specified pulse width.

$$\text{Edge Time} \leq 0.625 \times \text{Pulse Width}$$

**-222 Data out of range;
pulse edge time limited by duty cycle; value clipped to ...**
The specified edge time must fit within the specified pulse duty cycle as shown below. The function generator will adjust the edge time as needed to accommodate the specified pulse duty cycle.

$$\text{Edge Time} \leq 0.625 \times \text{Period} \times \text{Duty Cycle} \div 100$$

**-222 Data out of range;
period; value clipped to ...**
This generic message indicates that the pulse period has been limited to an upper or lower boundary.

**-222 Data out of range;
frequency; value clipped to ...**
This generic message indicates that the waveform frequency has been limited to an upper or lower boundary.

**-222 Data out of range;
user frequency; value clipped to upper limit**
This generic message indicates that the waveform frequency has been limited to an upper boundary due to the selection of the arbitrary waveform function (APPL:USER or FUNC:USER command).

- 222 Data out of range;
ramp frequency; value clipped to upper limit**
This generic message indicates that the waveform frequency has been limited to an upper boundary due to the selection of the ramp waveform function (APPL:RAMP or FUNC:RAMP command).
- 222 Data out of range;
pulse frequency; value clipped to upper limit**
This generic message indicates that the waveform frequency has been limited to an upper boundary due to the selection of the pulse waveform function (APPL:PULS or FUNC:PULS command).
- 222 Data out of range;
burst period; value clipped to ...**
This generic message indicates that the burst period has been limited to an upper or lower boundary.
- 222 Data out of range;
burst count; value clipped to ...**
This generic message indicates that the burst count has been limited to an upper or lower boundary.
- 222 Data out of range;
burst period limited by length of burst; value clipped to lower limit**
It is *not* possible to specify a burst period which is too short for the function generator to output with the specified burst count and frequency (*see below*). If the burst period is too short, the function generator will automatically adjust it as needed to continuously re-trigger the burst.
- $$\text{Burst Period} > \frac{\text{Burst Count}}{\text{Waveform Frequency}} + 200 \text{ ns}$$
- 222 Data out of range;
burst count limited by length of burst; value clipped to upper limit**
If the *Immediate* trigger source is selected (TRIG:SOUR IMM command), the burst count must be less than the product of the burst period and the waveform frequency as shown below.

$$\text{Burst Count} < \text{Burst Period} \times \text{Waveform Frequency}$$

Execution Errors

- 222** **Data out of range;
amplitude; value clipped to ...**
This generic message indicates that the waveform amplitude has been limited to an upper or lower boundary.
- 222** **Data out of range;
offset; value clipped to ...**
This generic message indicates that the offset voltage has been limited to an upper or lower boundary.
- 222** **Data out of range;
frequency in burst mode; value clipped to ...**
This generic message indicates that the frequency has been limited to an upper or lower boundary as dictated by the burst period.
- 222** **Data out of range;
frequency in FM; value clipped to ...**
This generic message indicates that the carrier frequency has been limited to a lower boundary as determined by the FM:DEV command. The carrier frequency must always be greater than or equal to the frequency deviation.
- 222** **Data out of range;
marker confined to sweep span; value clipped to ...**
This generic message indicates that the specified marker frequency is outside the range of the start frequency and stop frequency. The marker frequency *must* be between the specified start frequency and stop frequency. If you attempt to set the marker frequency to a frequency not in this range, the function generator will automatically set the marker frequency equal to the start frequency or stop frequency (whichever is closer). This error is generated only when both the sweep mode and the marker frequency are enabled.
- 222** **Data out of range;
pulse width; value clipped to ...**
This generic message indicates that the desired pulse width is limited to an upper or lower boundary which is dictated by the instrument hardware.

- 222 Data out of range;
pulse edge time; value clipped to ...**
This generic message indicates that the desired edge time is limited to an upper or lower boundary which is dictated by the instrument hardware.
- 222 Data out of range;
FM deviation; value clipped to ...**
This generic message indicates that the desired FM deviation is limited to a lower or upper boundary as set by the current function's frequency.
- 222 Data out of range;
FM deviation limited by minimum frequency**
The frequency deviation is limited to the lower limit (1 μ Hz).
- 222 Data out of range;
FM deviation limited by maximum frequency; value clipped to upper limit**
The frequency deviation cannot exceed the carrier frequency, and is limited as follows: 10.05 MHz for sine or square wave carriers, 150 kHz for a ramp, or 3.05 MHz for an arbitrary waveform.
- 222 Data out of range;
PWM deviation**
The PWM deviation is limited. Width deviation can be from 0 to the width of the underlying pulse waveform. Duty cycle deviation can be from 0 to the duty cycle of the underlying pulse waveform. Both are further limited by the minimum pulse width and edge time parameters.
- 222 Data out of range;
PWM deviation limited by pulse parameters**
The PWM deviation is limited by the current pulse parameters. The PWM deviation (width or duty cycle) is set to accommodate the current pulse width or duty cycle, edge time, and period.

Chapter 5 Error Messages

Execution Errors

-222

**Data out of range;
duty cycle; value clipped to ...**

The square wave duty cycle is limited to values between 20% and 80% by instrument hardware.

-222

**Data out of range;
duty cycle limited by frequency; value clipped to upper limit**

The square wave duty cycle is limited to values between 40% and 60% when the frequency is greater than 10 MHz.

Duty Cycle: 20% to 80% (*frequency* ≤ 10 MHz)
40% to 60% (*frequency* > 10 MHz)

Device Dependent Errors

- 313 Calibration memory lost;
memory corruption detected**
The non-volatile memory used to store the function generator's calibration constants has detected a checksum error. This error may be the result of a device failure or extreme conditions such as lightning or strong magnetic fields.
- 314 Save/recall memory lost;
memory corruption detected**
The non-volatile memory used to store instrument states has detected a checksum error. This error may be the result of a device failure or extreme conditions such as lightning or strong magnetic fields.
- 315 Configuration memory lost;
memory corruption detected**
The non-volatile memory used to store the function generator's configuration settings (i.e., remote interface settings) has detected a checksum error. This error may be the result of a device failure or extreme conditions such as lightning or strong magnetic fields.
- 350 Queue overflow**
The error queue is full because more than 20 errors have occurred. No additional errors are stored until you remove errors from the queue. The error queue is cleared by the *CLS (clear status) command or when the power is cycled. The errors are also cleared when you read the queue. The error queue *is not* cleared by an instrument reset (*RST command).

Query Errors

- 410 Query INTERRUPTED**
A command was received but the output buffer contained data from a previous command (the previous data is lost).
- 420 Query UNTERMINATED**
The function generator was addressed to talk (i.e., to send data over the interface) but a command has not been received which sends data to the output buffer. For example, you may have executed an `APPLY` command (which does not generate data) and then attempted an “Enter” statement to read data from the interface.
- 430 Query DEADLOCKED**
A command was received which generates too much data to fit in the output buffer and the input buffer is also full. Command execution continues but all data is lost.
- 440 Query UNTERMINATED after indefinite response**
The `*IDN?` command must be the last query command within a command string. *Example:* `*IDN? ; :SYST:VERS?`

Instrument Errors

501 to 502

501: Cross-isolation UART framing error

502: Cross-isolation UART overrun error

These errors indicate an internal hardware failure. The isolation between chassis ground circuits and floating circuits is controlled by an optical isolation barrier and a serial link.

580

Reference phase-locked loop is unlocked

The PHAS:UNL:ERR:STAT has been enabled ("on") and the internal phase-locked loop that controls the frequency is currently unlocked. This error is most likely to occur when the external reference is out of lock range.

Self-Test Errors

The following errors indicate failures that may occur during a self-test. Refer to the Agilent 33220A *Service Guide* for more information.

601

Self-test failed; system logic

This error indicates a failure of the main processor (U101), system RAM (U102), or system ROM (U103).

603

Self-test failed; waveform logic

This error indicates that the waveform logic in the synthesis IC (U501) has failed.

604

Self-test failed; waveform memory bank

This error indicates that either the waveform RAM (U502) or the synthesis IC (U501) has failed.

605

Self-test failed; modulation memory bank

This error indicates that the modulation memory bank in the synthesis IC (U501) has failed.

606

Self-test failed; cross-isolation interface

This error indicates that the cross-isolation interface between the main processor (U101) and the synthesis IC (U501) has failed, or that the synthesis IC itself has failed.

619 to 621
623 to 625

619: Self-test failed; leading edge DAC

620: Self-test failed; trailing edge DAC

621: Self-test failed; square-wave threshold DAC

623: Self-test failed; dc offset DAC

624: Self-test failed; null DAC

625: Self-test failed; amplitude DAC

These errors indicate a malfunctioning system DAC (U801), or failed DAC multiplexer (U803) channels.

622

Self-test failed; time base calibration DAC

This error indicates that the time base calibration DAC in the synthesis IC (U501), or voltage controlled oscillator (U602), has failed.

- 626 to 629**
- 626: Self-test failed; waveform filter path select relay**
627: Self-test failed; -10 dB attenuator path
628: Self-test failed; -20 dB attenuator path
629: Self-test failed; +20 dB amplifier path
- These errors indicate that the specified relay is not being properly switched or the attenuator/amplifier is not providing the expected attenuation or gain. These self-tests use the internal ADC to verify that the output path relays, output amplifier (+20 dB), and output attenuators are operating properly.
- 630**
- Self-test failed; internal ADC over-range condition**
- This error indicates a probable ADC failure. The failure could be of the system ADC (U703), the ADC input multiplexer (U701), or the ADC input buffer amplifier (U702).
- 631**
- Self-test failed; internal ADC measurement error**
- This error indicates a probable ADC failure. The failure could be of the system ADC (U703), the ADC input multiplexer (U701), or the ADC input buffer amplifier (U702).
- 632**
- Self-test failed; square/pulse DAC test failure**
- This error indicates a probable failure of the square/pulse DAC (U1002).

Calibration Errors

The following errors indicate failures that may occur during a calibration. For more information on the calibration procedures, see chapter 4 in the *Agilent 33220A Service Guide*.

- 701 Calibration error; security defeated by hardware jumper**
The function generator's calibration security feature has been disabled by temporarily shorting the two "CAL ENABLE" pads on the internal circuit board, as described in the *Agilent 33220A Service Guide*.
- 702 Calibration error; calibration memory is secured**
A calibration cannot be performed when calibration memory is secured. To unsecure the instrument, use the `CAL:SEC:STAT ON` command with the correct security code.
- 703 Calibration error; secure code provided was invalid**
The security code specified with the `CAL:SEC:STAT ON` command is invalid.
- 706 Calibration error; provided value is out of range**
The calibration value specified with the `CAL:VAL` command is out of range.
- 707 Calibration error; signal input is out of range**
The internal analog-to-digital converter (ADC) has determined that the signal applied to the rear-panel *Modulation In* connector is out of range.
- 850 Calibration error; setup is invalid**
You have specified an invalid calibration setup number with the `CAL:SET` command. Refer to the *Agilent 33220A Service Guide* for more information on the calibration procedures.
- 851 Calibration error; setup is out of order**
Certain calibration setups must be performed in a specific sequence in order to be valid. Refer to the *Agilent 33220A Service Guide* for more information on the calibration procedures.

Arbitrary Waveform Errors

The following errors indicate failures that may occur during arbitrary waveform operation. Refer to “Arbitrary Waveform Commands” on page 227 for more information.

- 770 Nonvolatile arb waveform memory corruption detected**
The non-volatile memory used to store arbitrary waveforms has detected a checksum error. The arbitrary waveform cannot be retrieved from memory.
- 781 Not enough memory to store new arb waveform; use DATA:DELETE**
The four non-volatile memory locations already contain arbitrary waveforms. To store another waveform, you must first delete one of the stored waveforms using the DATA:DELEte command.
- 781 Not enough memory to store new arb waveform; bad sectors**
Due to a hardware error, there are no more memory locations available to store arbitrary waveforms. This error is likely the result of a failed Flash memory device.
- 782 Cannot overwrite a built-in waveform**
The following built-in waveform names are reserved and cannot be used with the DATA: COPY command: “EXP_RISE”, “EXP_FALL”, “NEG_RAMP”, “SINC”, and “CARDIAC”.
- 784 Name of source arb waveform for copy must be VOLATILE**
When using the DATA: COPY command, you cannot copy *from* any source other than “VOLATILE”.
- 785 Specified arb waveform does not exist**
The DATA: COPY command copies the waveform from volatile memory to the specified name in non-volatile memory. Before executing the DATA: COPY command, you must download the waveform using the DATA VOLATILE or DATA: DAC VOLATILE command.

786

Not able to delete a built-in arb waveform

You cannot delete any of the five built-in waveforms: "EXP_RISE", "EXP_FALL", "NEG_RAMP", "SINC", and "CARDIAC".

787

Not able to delete the currently selected active arb waveform

You cannot delete the arbitrary waveform that is currently being output (FUNC:USER command).

788

Cannot copy to VOLATILE arb waveform

The DATA:COPY command copies the waveform from volatile memory to the specified name in non-volatile memory. The source for the copy is always "VOLATILE". You cannot copy *from* any other source and you cannot copy *to* "VOLATILE".

800

Block length must be even

The function generator represents binary data as 16-bit integers, which are sent as two bytes (DATA:DAC VOLATILE command).

810

State has not been stored

The storage location that you specified in the *RCL command was not used in a previous *SAV command. You cannot recall the instrument state from a storage location that is empty.

Application Programs

Application Programs

This chapter contains several remote interface example programs to help you develop programs for your own application. Chapter 4, “Remote Interface Reference” starting on page 147, lists the syntax for the SCPI (*Standard Commands for Programmable Instruments*) commands available to program the function generator.

Introduction

Six example programs are included in this chapter to demonstrate controlling the Agilent 33220A using SCPI commands. All of these programs are written in Microsoft® Visual BASIC® 6.0 and use the Agilent VISA-COM objects.

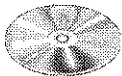

The BASIC programs in this chapter, and other example programs illustrating the use of several drivers and environments, are included on the “Agilent IntuiLink for the 33220A Waveform Generator” CD-ROM shipped with the function generator. For a detailed description of these programs, refer to the “readme” file in the “Examples” directory. The programs in this chapter are found in the “Examples\chapter6” subdirectory.

If you want to modify the example programs, or write your own programs and compile them, you will need to install the Agilent E2094 I/O Libraries software:

- **If you are using GPIB.** The Agilent E2094 I/O Libraries software is provided with Agilent GPIB I/O products. The software should have been loaded when you installed your GPIB interface card in your PC.
- **If you are using USB or LAN.** If you don’t have a copy, you can order the Agilent E2094 I/O Libraries software on CD-ROM. You must have version M (order Agilent product number E2094M) or a later version to support USB and LAN.

You can obtain the Agilent I/O Libraries through the Agilent Developer Network. Go to www.agilent.com/find/buyadn and purchase an ADN Professional Membership. This gives you the right to download the latest version of the Agilent I/O Libraries. Look for the Agilent I/O Libraries link under “Downloads” on the ADN web site.

Microsoft® and Visual BASIC® are U.S. registered trademarks of Microsoft Corporation.

Once you have installed the appropriate software components, see "Remote Interface Configuration" in chapter 3 for information on configuring your interface.

The programs listed in this chapter are protected by copyright.

Copyright © 2003 Agilent Technologies, Inc.

You have a royalty-free right to use, modify, reproduce and distribute the Sample Application Files (and/or any modified version) in any way you find useful, provided that you agree that Agilent has no warranty, obligations, or liability for any Sample Application Files.

Agilent Technologies provides programming examples for illustration only. All sample programs assume that you are familiar with the programming language being demonstrated and the tools used to create and debug procedures. Agilent support engineers can help explain the functionality of Agilent software components and associated commands, but they will not modify these samples to provide added functionality or construct procedures to meet your specific needs.

All of the sample application programs in this chapter are example programs intended for use with Microsoft Visual Basic 6.0 and the Agilent VISA-COM objects.

To use the IO object in another Visual Basic project,

1. Set the reference to include the libraries in the Project/References menu:
 - "VISA COM 1.0 Type Library", corresponds to VISACOM.tlb
 - "Agilent VISA COM Resource Manager 1.0", corresponds to AgtRM.DLL
 - "VISA COM 488.2 Formatted I/O 1.0", corresponds to the BasicFormattedIO.dll
2. Create the formatted I/O reference with a statement such as "Dim Fgen As VisaComLib.FormattedIO488".
3. Use "Set Fgen = New VisaComLib.FormattedIO488" to create the actual object.

Program Listings

Example: A Simple Sine Waveform

This program (found in the “Examples\chapter6\SimpleSine” subdirectory on the CD-ROM) selects the function as “sine,” and then sets the frequency, amplitude and offset of the waveform.

```
Private Sub cmdSimpleSine_Click()

    Dim io_mgr As VisaComLib.ResourceManager
    Dim Fgen As VisaComLib.FormattedIO488

    Set io_mgr = New AgilentRMLib.SRMCLs
    Set Fgen = New VisaComLib.FormattedIO488
    Set Fgen.IO = io_mgr.Open(txtIO.Text)

    On Error GoTo MyError

    ' This program sets up a waveform by selecting the waveshape
    ' and adjusting the frequency, amplitude, and offset.

    With Fgen

        .WriteString "*RST"           ' Reset the function generator
        .IO.Clear                     ' Clear errors and status registers

        .WriteString "FUNCTION SINusoid" ' Select waveshape
        ' Other options are SQUARE, RAMP, PULSE, NOISE, DC, and USER
        .WriteString "OUTPUT:LOAD 50"  ' Set the load impedance in Ohms
        ' (50 Ohms default)
        ' May also be INFINITY, as when using oscilloscope or DMM

        .WriteString "FREQUENCY 2500"  ' Set the frequency.
        .WriteString "VOLTage 1.2"     ' Set the amplitude in Vpp.
        ' Also see VOLTage:UNIT
        .WriteString "VOLTage:OFFSet 0.4" ' Set the offset in Volts
        ' Voltage may also be set as VOLTage:HIGH and VOLTage:LOW for low level
        ' and high level

        .WriteString "OUTPUT ON"      ' Turn on the instrument output

    End With

    Exit Sub

MyError:

    txtError = Err.Description & vbCrLf
    Resume Next

End Sub
```

Example: Amplitude Modulation

This program (found in the "Examples\chapter6\AMLowLevel" subdirectory on the CD-ROM) configures a waveform with amplitude modulation using lower-level SCPI commands. It also shows how to use the *SAV command to store the instrument configuration in the function generator's internal memory.

```
Private Sub cmdAMLowLevels_Click()

    Dim io_mgr As VisaComLib.ResourceManager
    Dim Fgen As VisaComLib.FormattedIO488

    Set io_mgr = New AgilentRMLib.SRMCLs
    Set Fgen = New VisaComLib.FormattedIO488
    Set Fgen.IO = io_mgr.Open(txtIO.Text)

    On Error GoTo MyError

    ' This program uses low-level SCPI commands to configure
    ' the function generator to output an AM waveform.
    ' This program also shows how to use "state storage" to
    ' store the instrument configuration in memory.

    With Fgen

        .WriteString "*RST"           ' Reset the function generator
        .IO.Clear                     ' Clear errors and status registers

        .WriteString "OUTPut:LOAD 50" ' Output termination is 50 Ohms
        .WriteString "FUNctIon:SHAPE SINusoid" ' Carrier shape is sine
        .WriteString "FREQuency 5000;VOLTage 5" ' Carrier freq is 5 kHz @ 5 Vpp
        .WriteString "AM:INTernal:FUNCTion SINusoid" ' Modulating shape is sine
        .WriteString "AM:INTernal:FREQuency 200" ' Modulation freq = 200 Hz
        .WriteString "AM:DEPTth 80" ' Modulation depth = 80%
        .WriteString "AM:STATe ON" ' Turn AM modulation on

        .WriteString "OUTPut ON" ' Turn on the instrument output
        .WriteString "*SAV 1" ' Store state in memory location 1

        ' Use the "*RCL 1" command to recall the stored state

    End With

    Exit Sub

MyError:

    txtError = Err.Description & vbCrLf
    Resume Next

End Sub
```

Chapter 6 Application Programs Program Listings

Example: Linear Sweep

This program (found in the “Examples\chapter6\LinearSweep” subdirectory on the CD-ROM) creates a linear sweep for a sine wave. It sets the start and stop frequencies, and the sweep time.

```
Private Sub cmdLinearSweep_Click()
    Dim io_mgr As VisaComLib.ResourceManager
    Dim Fgen As VisaComLib.FormattedIO488

    Set io_mgr = New AgilentRMLib.SRMC1s
    Set Fgen = New VisaComLib.FormattedIO488
    Set Fgen.IO = io_mgr.Open(txtIO.Text)

    On Error GoTo MyError

    ' This program sets up a linear sweep using a sinusoid
    ' waveform. It sets the start and stop frequency and sweep
    ' time.

    With Fgen
        .WriteString "*RST"           ' Reset the function generator
        .IO.Clear                     ' Clear errors and status registers

        .WriteString "FUNCTION SINusoid" ' Select waveshape

        .WriteString "OUTPut:LOAD 50"   ' Set the load impedance to
        ' 50 Ohms (default)
        .WriteString "VOLTage 1"        ' Set the amplitude to 1 Vpp.

        .WriteString "SWEep:SPACing LINear" ' Set Linear or LOG spacing
        .WriteString "SWEep:TIME 1"      ' Sweep time is 1 second
        .WriteString "FREQuency:START 100" ' Start frequency is 100 Hz
        .WriteString "FREQuency:STOP 20e3" ' Stop frequency is 20 kHz

        ' Frequency sweep limits may also be set as FREQuency:CENTer and
        ' FREQuency:SPAN on the 33250A
        ' For the 33250A, also see MARKer:FREQuency

        .WriteString "OUTPut ON"        ' Turn on the instrument output
        .WriteString "SWEep:STATe ON"   ' Turn sweep on
    End With

    Exit Sub

MyError:
    txtError = Err.Description & vbCrLf
    Resume Next

End Sub
```

Example: A Pulse Waveform

This program (found in the "Examples\chapter6\Pulse" subdirectory on the CD-ROM) configures a pulse waveform, setting pulse width, period, and high/low levels. The edge time is then incremented.

```
Private Declare Sub Sleep Lib "kernel32" (ByVal dwMilliseconds As Long)

Private Sub cmdPulse_Click()

    Dim io_mgr As VisaComLib.ResourceManager
    Dim Fgen As VisaComLib.FormattedIO488

    Set io_mgr = New AgilentRMLib.SRMClS
    Set Fgen = New VisaComLib.FormattedIO488
    Set Fgen.IO = io_mgr.Open(txtIO.Text)

    Dim I As Integer

    On Error GoTo MyError

    ' This program sets up a pulse waveshape and adjusts the edge
    ' time. It also shows the use of high and low voltage levels
    ' and period. The edge time is adjusted by 10 nsec increments.

    With Fgen

        .WriteString "*RST"           ' Reset the function generator
        .IO.Clear                     ' Clear errors & status registers
        .WriteString "FUNCTION PULSe" ' Select pulse waveshape

        .WriteString "OUTPut:LOAD 50" ' Set load impedance to 50 Ohms
                                        ' (default)
        .WriteString "VOLTage:LOW 0"   ' Low level = 0 V
        .WriteString "VOLTage:HIGH 0.75" ' High level = .75 V

        .WriteString "PULSe:PERiod 1e-3" ' 1 ms intervals
        .WriteString "PULSe:WIDTh 100e-6" ' Pulse width is 100 us
        .WriteString "PULSe:TRANSition 20e-9" ' Edge time is 20 ns
                                        ' (rise time = fall time)
        .WriteString "OUTPut ON"       ' Turn on the instrument output
    End With

    For I = 0 To 18
        ' Vary edge by 10 nsec steps
        .WriteString "PULSe:TRANSition " & (0.00000002 + I * 0.00000001)
        Sleep 300 ' Wait 300 msec
    Next I

    End With

    Exit Sub

MyError:

    txtError = Err.Description & vbCrLf
    Resume Next

End Sub
```

Example: Pulse Width Modulation (PWM)

This program (found in the "Examples\chapter6\PulseWidthMod" subdirectory on the CD-ROM) configures a pulse waveform with duty cycle, which is then slowly modulated by a triangle waveform.

```
Private Sub cmdPWM_Click()

    Dim io_mgr As VisaComLib.ResourceManager
    Dim Fgen As VisaComLib.FormattedIO488

    Set io_mgr = New AgilentRMLib.SRMClS
    Set Fgen = New VisaComLib.FormattedIO488
    Set Fgen.IO = io_mgr.Open(txtIO.Text)

    On Error GoTo MyError

    ' This program uses low-level SCPI commands to configure
    ' the function generator to output an PWM waveform.
    ' The pulse is set up with a duty cycle of 35% and a depth
    ' of 15%, and will vary in width from 20% to 50% with the
    ' modulation. The pulse may also be configured in time
    ' units (pulse width and deviation) rather than duty cycle
    ' if preferred.

    With Fgen

        .WriteString "*RST"           ' Reset the function generator
        .IO.Clear                     ' Clear errors & status registers

        .WriteString "OUTPut:LOAD 50" ' Output termination is 50 Ohms
        .WriteString "FUNCTION:SHApe PULSe" ' Carrier waveshape is pulse
        .WriteString "FREQuency 5000" ' Carrier frequency is 5 kHz
        .WriteString "VOLTage:LOW 0" ' Set parameters to 5 V TTL
        .WriteString "VOLTage:HIGh 5"
        .WriteString "FUNCTION:PULSe:DCYCLE 35" ' Begin with 35% duty cycle
        .WriteString "PWM:INTernal:FUNCTION TRIangle" ' Modulating waveshape
        ' is triangle

        .WriteString "PWM:INTernal:FREQuency 2" ' Modulation frequency is 2 Hz
        .WriteString "PWM:DEVIation:DCYCLE 15" ' Modulation depth is 15%
        .WriteString "PWM:SOURce INTernal" ' Use internal signal for
        ' modulation

        ' If using an external signal for PWM, connect the signal to the
        ' rear-panel BNC and use the command PWM:SOURce EXTernal
        .WriteString "PWM:STATe ON" ' Turn PWM modulation on

        .WriteString "OUTPut ON" ' Turn on the instrument output

    End With

    Exit Sub

MyError:

    txtError = Err.Description & vbCrLf
    Resume Next

End Sub
```

Example: Downloading an Arbitrary Waveform (ASCII)

This program (found in the "Examples\chapter6\ASCIIarb" subdirectory on the CD-ROM) downloads an arbitrary waveform to the function generator as ASCII data. Data values are in the range -1 to +1.

```
Private Sub cmdASCIIarb_Click()

    Dim io_mgr As VisaComLib.ResourceManager
    Dim Fgen As VisaComLib.FormattedIO488

    Set io_mgr = New AgilentRMLib.SRMCLs
    Set Fgen = New VisaComLib.FormattedIO488
    Set Fgen.IO = io_mgr.Open(txtIO.Text)

    Dim Waveform() As String
    Dim I As Integer
    Dim DataStr As String
    ReDim Waveform(1 To 4000)

    On Error GoTo MyError

    ' This program uses the arbitrary waveform function to
    ' download and output a square wave pulse with a calculated
    ' rise time and fall time. The waveform consists of 4000
    ' points downloaded to the function generator as ASCII data.

    With Fgen
        .WriteString "*RST"           ' Reset the function generator
        .IO.Clear                     ' Clear errors and status registers
        .IO.Timeout = 40000          ' Set timeout to 40 seconds for long
                                    ' download strings
    End With

    ' Compute waveform

    txtError.Text = ""
    txtError.SelText = "Computing Waveform..." & vbCrLf

    For I = 1 To 5
        Waveform(I) = Str$((I - 1) / 5) ' Set rise time (5 points)
    Next I

    For I = 6 To 205
        Waveform(I) = "1"             ' Set pulse width (200 points)
    Next I

    For I = 206 To 210
        Waveform(I) = Str$((210 - I) / 5) ' Set fall time (5 points)
    Next I

    For I = 211 To 4000
        Waveform(I) = "0"             ' Set remaining points to zero
    Next I

    DataStr = Join(Waveform, ",")     ' Create string from data array
```

Continued...

Chapter 6 Application Programs Program Listings

```
' Download data points to volatile memory

txtError.SelText = "Downloading Arb..." & vbCrLf

With Fgen
    .WriteString "DATA VOLATILE, " & DataStr
End With

txtError.SelText = "Download Complete" & vbCrLf

' Set up arbitrary waveform and output

With Fgen

    .WriteString "DATA:COPY PULSE, VOLATILE" ' Copy arb to non-volatile
                                                ' memory
    .WriteString "FUNCTION:USER PULSE"      ' Select the active arb waveform
    .WriteString "FUNCTION:SHAPE USER"      ' Output the selected arb waveform

    .WriteString "OUTPUT:LOAD 50"          ' Output termination is 50 Ohms
    .WriteString "FREQUENCY 5000;VOLTage 5" ' Output frequency is 5 kHz
                                                ' @ 5 Vpp
    .WriteString "OUTPUT ON"              ' Enable Output

End With

Exit Sub

MyError:

txtError = Err.Description & vbCrLf
Resume Next

End Sub
```

Tutorial

Tutorial

In order to achieve the best performance from the Agilent 33220A, it may be helpful for you to gain a better understanding of the internal operations of the instrument. This chapter describes basic signal-generation concepts and gives specific details on the internal operations of the function generator.

- Direct Digital Synthesis, *on page 313*
- Creating Arbitrary Waveforms, *on page 316*
- Square Waveform Generation, *on page 318*
- Pulse Waveform Generation, *on page 319*
- Signal Imperfections, *on page 320*
- Output Amplitude Control, *on page 322*
- Ground Loops, *on page 323*
- Attributes of AC Signals, *on page 325*
- Modulation, *on page 327*
- Frequency Sweep, *on page 332*
- Burst, *on page 333*

You can use an arbitrary waveform generator in a variety of applications where it might be otherwise difficult or impossible to generate complex output waveforms. With an arbitrary waveform generator, signal imperfections such as rise time, ringing, glitches, noise, and random timing variations can be easily simulated in a controlled manner.

Physics, chemistry, biomedicine, electronics, mechanics, and other fields can benefit from the versatility of an arbitrary waveform generator. Wherever things vibrate, pump, pulse, bubble, burst, or change with time in any way, there are possible applications – limited only by your ability to specify the waveform data.

Direct Digital Synthesis

The Agilent 33220A uses a signal-generation technique called *Direct Digital Synthesis* (DDS) for all waveform functions except pulse. As shown below, a stream of digital data representing the desired waveform is sequentially read from waveform memory and is applied to the input of a digital-to-analog converter (DAC). The DAC is clocked at the function generator's sampling frequency of 50 MHz and outputs a series of voltage steps approximating the desired waveform. A low-pass "anti-aliasing" filter then smooths the voltage steps to create the final waveform.

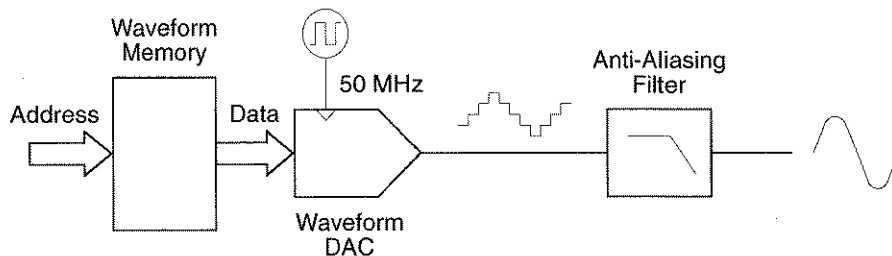

Direct Digital Synthesis Circuitry

The 33220A uses two anti-aliasing filters. An elliptical filter is used for continuous sine waves because of its nearly flat passband and sharp cutoff above 20 MHz. Since elliptical filters exhibit severe ringing for waveforms other than continuous sine waves, a linear-phase filter is used for all other waveform functions.

For standard waveforms, and arbitrary waveforms that are defined with fewer than 16,384 (16K) points, the function generator uses waveform memory that is 16K words deep. For arbitrary waveforms that are defined with more than 16K points, the function generator uses waveform memory that is 65,536 (64K) words deep.

Chapter 7 Tutorial

Direct Digital Synthesis

The 33220A represents amplitude values by 16,384 discrete voltage levels (or 14-bit vertical resolution). The specified waveform data is divided into samples such that one waveform cycle exactly fills waveform memory (see the illustration below for a sine wave). If you create an arbitrary waveform that does not contain exactly 16K or 64K points, the waveform is automatically “stretched” by repeating points or by interpolating between existing points as needed to fill waveform memory. Since all of waveform memory is filled with one waveform cycle, each memory location corresponds to a phase angle of $2\pi/16,384$ radians or $2\pi/65,536$ radians.

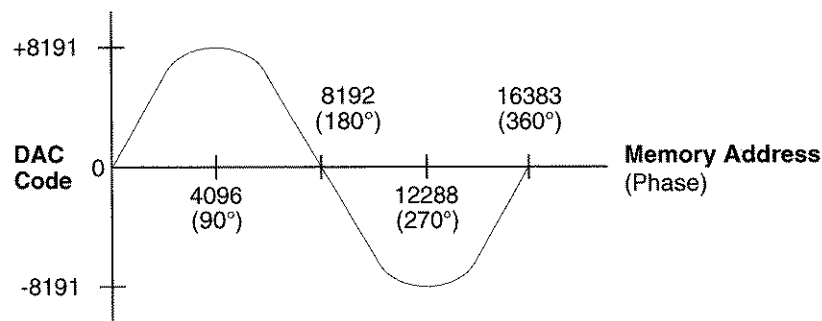

Sine Wave Representation in Waveform Memory

Direct digital synthesis (DDS) generators use a *phase accumulation* technique to control waveform memory addressing. Instead of using a counter to generate sequential memory addresses, an “adder” is used (see the following page). On each clock cycle, the constant loaded into the phase increment register (PIR) is added to the present result in the phase accumulator. The most-significant bits of the phase accumulator output are used to address waveform memory. By changing the PIR constant, the number of clock cycles required to step through the entire waveform memory changes, thus changing the output frequency.

The PIR determines how fast the phase value changes with time and thereby controls the frequency being synthesized. More bits in the phase accumulator result in finer frequency resolution. Since the PIR affects only the rate of change of the phase value (and not the phase itself), changes in waveform frequency are phase-continuous.

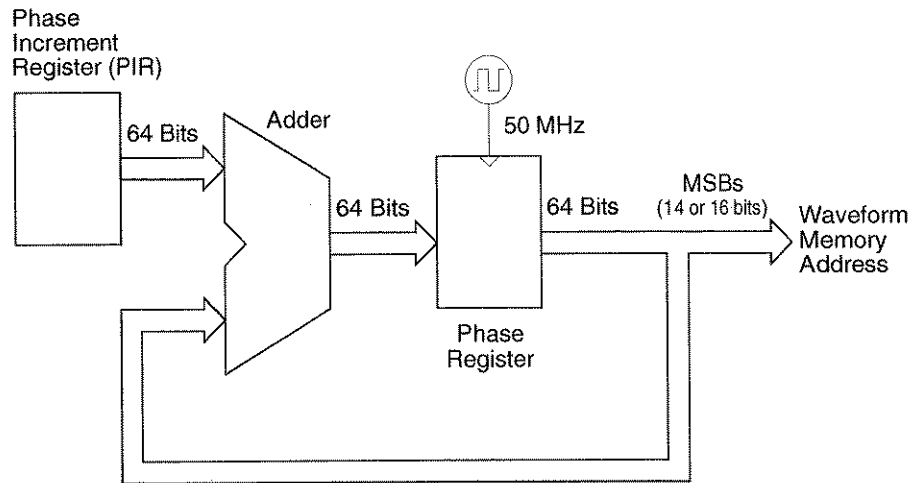

Phase Accumulator Circuitry

The 33220A uses a 64-bit phase accumulator which yields $2^{-64} \times 50$ MHz or 2.7 picohertz frequency resolution internally. Note that only the 14 or 16 most-significant bits of the Phase Register are used to address waveform memory. Therefore, when synthesizing low frequencies (less than 3.05 kHz for a typical, 16K point waveform), the address will not change in every clock cycle. However, at higher frequencies (greater than 3.05 kHz), the address will change by more than one location during each clock cycle and some points will be skipped. If too many points are skipped, a phenomenon known as “aliasing” will occur and the waveform output will become somewhat distorted.

The *Nyquist Sampling Theorem* states that in order to prevent aliasing, the highest frequency component of the desired output waveform must be **less than half** of the sampling frequency (25 MHz for the 33220A).

Creating Arbitrary Waveforms

The Agilent 33220A allows you to create arbitrary waveforms of up to 64 K points (65,536 points), and provides five built-in examples of arbitrary waveforms. You can create an arbitrary waveform from the front panel, or you can use the Agilent IntuiLink software provided on the CD-ROM included with the Agilent 33220A. The Agilent IntuiLink software allows you to create arbitrary waveforms using a graphical user interface on your PC, and then download them into the Agilent 33220A. You can also capture waveforms from your Agilent oscilloscope and import them into IntuiLink. Please see the online help included with the Agilent IntuiLink software for further information.

For most applications, it is not necessary to create an arbitrary waveform with a specific number of points since the function generator will repeat points (or interpolate) as necessary to fill waveform memory. For example, if you specify 100 points, each waveform point will be repeated an average of $16,384/100$ or 163.84 times. For the 33220A, you do not have to change the length of the waveform to change its output frequency. All you have to do is create a waveform of any length and then adjust the function generator's output frequency. However, in order to get the best results (and minimize voltage quantization errors), it is recommended that you use the full range of the waveform DAC.

When entering waveform points from the function generator's front panel, you are not required to enter the points at evenly-spaced intervals in time. You can always add additional points as needed where the waveform is more complex. From the front panel only, you can also use linear interpolation to smooth the transition between waveform points. These features make it possible to create useful arbitrary waveforms using a relatively small number of points.

With the 33220A, you can output an arbitrary waveform to an upper frequency limit of 6 MHz. However, note that the *useful* upper limit is usually less due to the function generator's bandwidth limitation and aliasing. Waveform components above the function generator's -3 dB bandwidth will be attenuated.

For example, consider an arbitrary waveform consisting of 10 cycles of a sine waveform. When you set the function generator's frequency to 1 MHz, the actual output frequency will be 10 MHz and the amplitude will be attenuated by approximately 3 dB. As you increase the frequency above 1 MHz, more attenuation will occur. At approximately 2.5 MHz, waveform distortion due to aliasing will become evident. Some aliasing will be present in most arbitrary waveforms, but whether or not it will be troublesome depends on your specific application.

When creating arbitrary waveforms, the function generator will always attempt to replicate the finite-length time record to produce a periodic version of the data in waveform memory. However, as shown below, it is possible that the shape and phase of a signal may be such that a discontinuity is introduced at the end point. When the waveshape is repeated for all time, this end-point discontinuity will introduce *leakage errors* in the frequency domain because many spectral terms are required to describe the discontinuity.

Leakage error is caused when the waveform record does not include an integral number of cycles of the fundamental frequency. Power from the fundamental frequency, and its harmonics, is transferred to the spectral components of the rectangular sampling function. You can reduce leakage errors by adjusting the window length to include an integer number of cycles or by including more cycles within the window to reduce the residual end-point discontinuity size. Some signals are composed of discrete, non-harmonically related frequencies. Since these signals are non-repetitive, all frequency components cannot be harmonically related to the window length. You should be careful in these situations to minimize end-point discontinuities and spectral leakage.

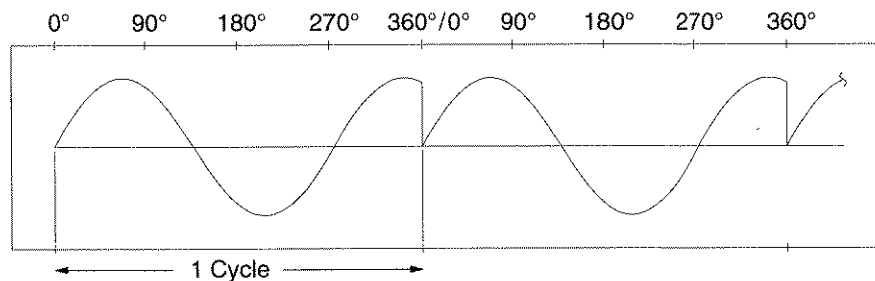

Arbitrary Waveform with Discontinuity

Chapter 7 Tutorial
Square Waveform Generation

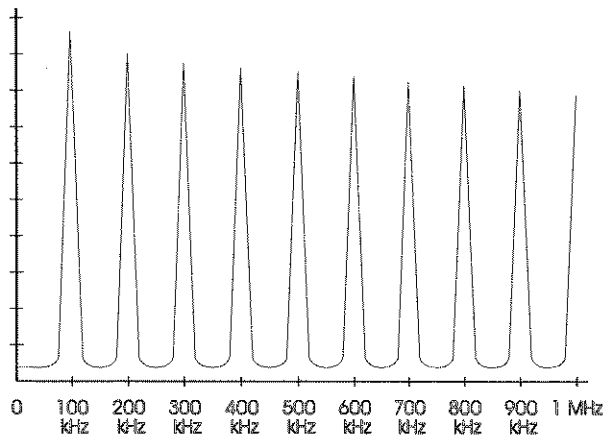

Spectrum of Above Waveform at 100 kHz

Square Waveform Generation

To eliminate distortion due to aliasing at higher frequencies, the 33220A uses a different waveform generation technique to create square waves. Square waveforms are created by routing a DDS-generated sine wave into a comparator. The digital output from the comparator is then used as the basis for the square wave output. The duty cycle of the waveform can be varied by changing the comparator's threshold.

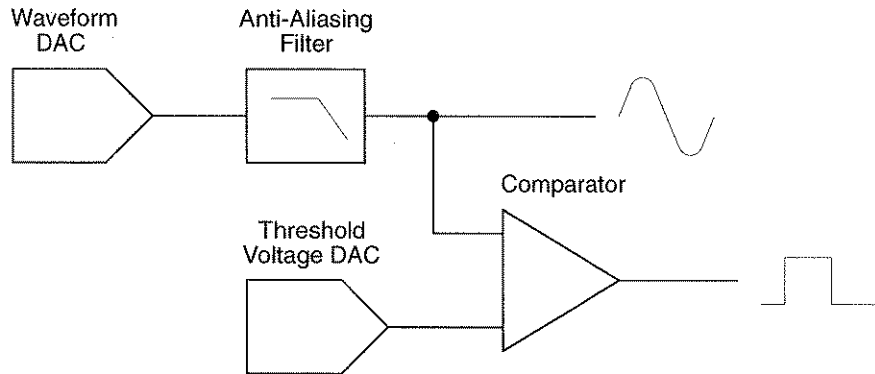

Square Waveform Generation Circuitry

Pulse Waveform Generation

To eliminate distortion due to aliasing at higher frequencies, the Agilent 33220A also uses a different waveform generation technique to create pulse waveforms. For pulse waveform generation, clock cycles are counted to derive both the period and the pulse width. To achieve fine period resolution, the clock frequency is varied from 95 to 100 MHz by a phase lock loop (PLL) circuit (which also multiplies the incoming frequency from the DDS by five). The rising and falling edge times are controlled by a circuit that varies the charging currents in a capacitor. Period, pulse width, and edge time are controlled independently, within certain limits. The pulse waveform generation circuitry is represented in the following block diagram.

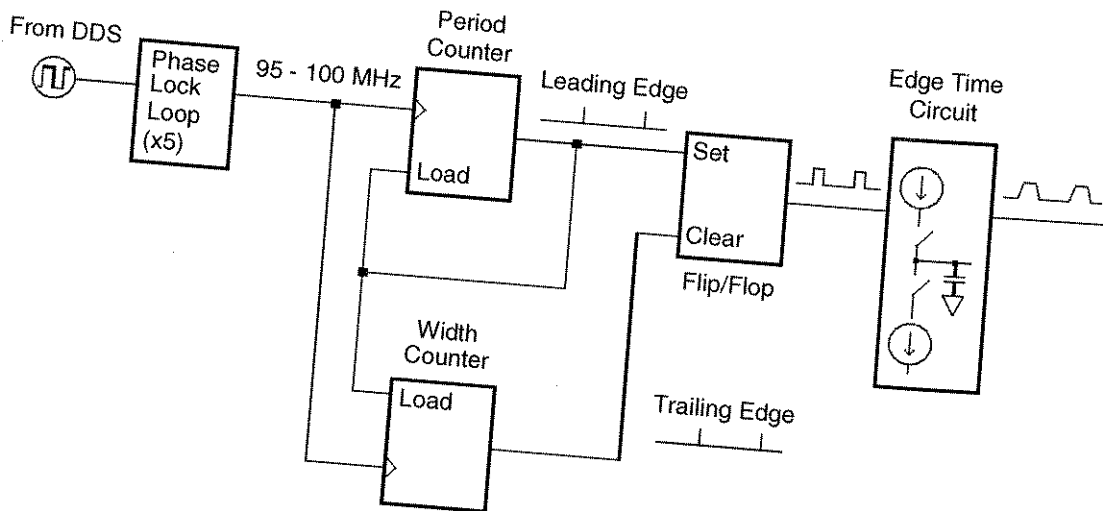

Pulse Waveform Generation Circuitry

Chapter 7 Tutorial Modulation

Phase Modulation (PM) PM is very similar to FM, but for PM, the *phase* of the carrier waveform is varied, rather than the *frequency*. The variation in phase of the modulated waveform from the carrier waveform is called the *phase deviation*, which can vary from 0 to 360 degrees. Note that since 360 degrees of deviation is equivalent to 0 degrees, the maximum effective deviation is at 180 degrees (the default).

Frequency-Shift Keying (FSK) FSK is similar to FM except the frequency alternates between two preset values. The rate at which the output shifts between the two frequencies (called the "carrier frequency" and the "hop frequency") is determined by the internal rate generator or the signal level on the rear-panel *Trig In* connector. Frequency changes are instantaneous and phase-continuous.

The internal modulating signal is a square waveform with 50% duty cycle. You can set the internal FSK rate from 2 mHz to 100 kHz.

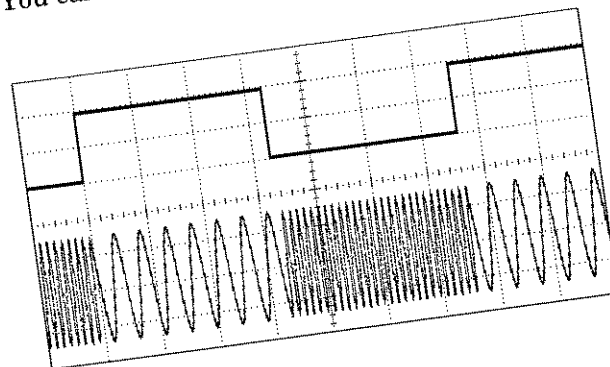

Frequency-Shift Keying

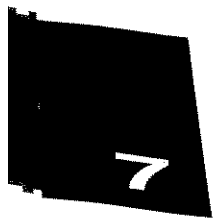
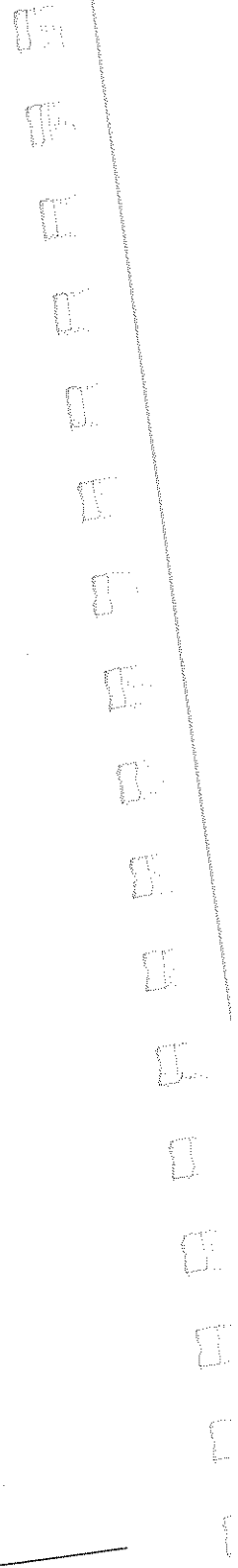

Pulse Width Modulation (PWM) PWM is used in digital audio applications, motor control circuitry, switching power supplies, and other control applications. The Agilent 33220A provides PWM for pulse waveforms, and PWM is the only type of modulation supported for pulse waveforms. For PWM, the amplitude of the modulating waveform is sampled digitally and used to control the pulse width or duty cycle of the pulse waveform.

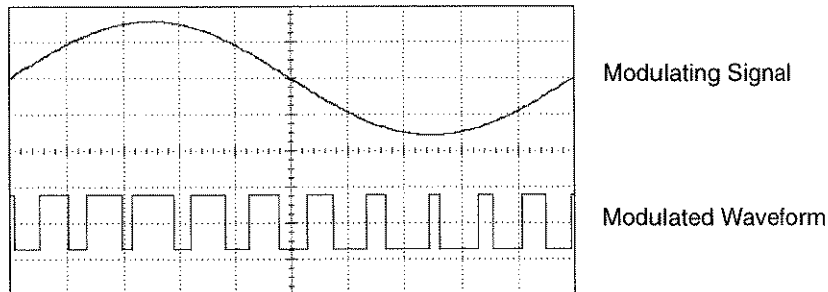

Pulse Width Modulation

The variation of pulse width in the modulated waveform from the pulse width of the pulse waveform is called the *width deviation*. The deviation can also be expressed in terms of duty cycle (as a percentage referenced to the period of the pulse waveform), which is called the *duty cycle deviation*. In PWM the deviation of width or duty cycle is symmetrical around the pulse width or duty cycle of the original pulse waveform. For example, if you specify a pulse waveform with a 10% duty cycle, and then specify PWM with a duty cycle deviation of 5%, the modulated waveform will have a pulse that varies in duty cycle from 5% to 15% under control of the modulating waveform.

Frequency Sweep

Frequency sweeping is similar to FM but no modulating waveform is used. Instead, the function generator sets the output frequency based on either a linear or logarithmic function. In a *linear* sweep, the output frequency changes in a constant “hertz per second” manner. In a *logarithmic* sweep, the output frequency changes in a constant “octaves per second” or “decades per second” manner. Logarithmic sweeps are useful for covering wide frequency ranges where resolution at low frequencies could be lost with a linear sweep.

You can generate a sweep using an *internal* trigger source or an *external* hardware trigger source. When the *internal* source is selected, the function generator outputs a continuous sweep at a rate determined by the *sweep time* specified. When the *external* source is selected, the function generator will accept a hardware trigger applied to the rear-panel *Trig In* connector. The function generator initiates one sweep each time *Trig In* receives a TTL pulse.

A sweep consists of a finite number of small frequency steps. Since each step takes the same amount of time, longer sweep times result in smaller steps and therefore better resolution. The number of discrete frequency points in the sweep is automatically calculated by the function generator and is based on the *sweep time* you select.

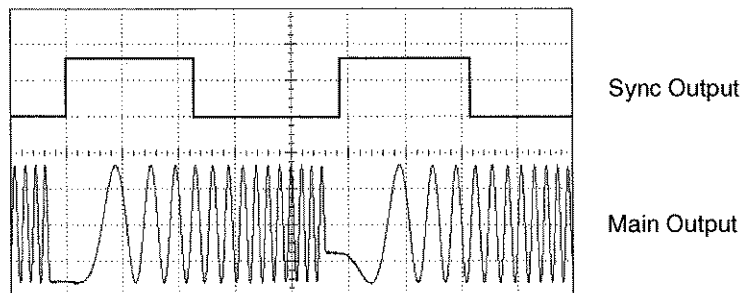

Frequency Sweep

For triggered sweeps, the trigger source can be an external signal, the  key, or a command received from the remote interface. The input for external trigger signals is the rear-panel *Trig In* connector. This connector accepts TTL-compatible levels and is referenced to chassis ground (not floating ground). When not used as an input, the *Trig In*

connector can be configured as an output to enable the 33220A to trigger other instruments at the same time as its internal trigger occurs.

Sync and Marker Signals The output from the front-panel *Sync* connector goes “high” at the beginning of each sweep. If you have *disabled* the Marker function, the Sync signal goes “low” at the midpoint of the sweep. However, if you have *enabled* the Marker function, the Sync signal goes “low” when the output frequency reaches the specified marker frequency. The marker frequency must be between the specified start frequency and stop frequency.

You can use the Marker function to identify a notable frequency in the response of a device under test (DUT) – for example, you may want to identify a resonance. To do this, connect the *Sync* output to one channel of your oscilloscope and connect the DUT output to another channel. Then, trigger the oscilloscope with the rising edge of the Sync signal to position the start frequency on the left side of the screen. Adjust the marker frequency until the falling edge of the Sync signal lines up with the interesting feature in the device’s response. You can then read the frequency from the front-panel display of the 33220A.

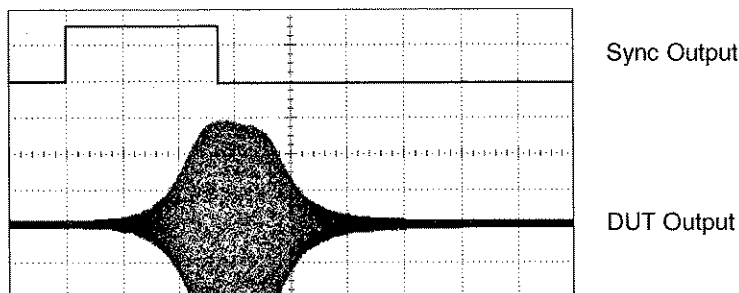

Sweep with Marker at DUT Resonance

Burst

You can configure the function generator to output a waveform with a specified number of cycles, called a *burst*. You can use burst in one of two modes: *N-Cycle Burst* (also called “triggered burst”) or *Gated Burst*.

Burst

N-Cycle Burst An N-Cycle burst consists of a specific number of waveform cycles (1 to 50,000) and is always initiated by a trigger event. You can also set the burst count to “Infinite” which results in a continuous waveform once the function generator is triggered.

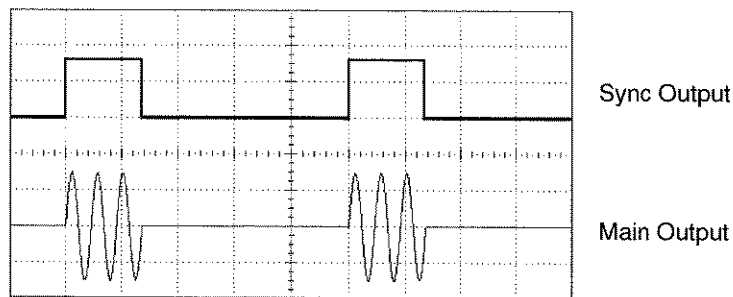
***Three-Cycle Burst Waveform***

For bursts, the trigger source can be an external signal, an internal timer, the **Trigger** key, or a command received from the remote interface. The input for external trigger signals is the rear-panel *Trig In* connector. This connector accepts TTL-compatible levels and is referenced to chassis ground (not floating ground). When not used as an input, the *Trig In* connector can be configured as an output to enable the 33220A to trigger other instruments at the same time as its internal trigger occurs.

An N-Cycle burst always begins and ends at the same point in the waveform, called the *start phase*. A starting phase of 0° corresponds to the beginning of the waveform record and 360° corresponds to the end of the waveform record.

Gated Burst In the Gated burst mode, the output waveform is either “on” or “off” based on the level of the external signal applied to the rear-panel *Trig In* connector. When the gate signal is *true*, the function generator outputs a continuous waveform. When the gate signal goes *false*, the current waveform cycle is completed and then the function generator stops while remaining at the voltage level corresponding to the starting burst phase of the selected waveform. For a noise waveform, the output stops immediately when the gate signal goes false.

Specifications

Chapter 8 Specifications
Agilent 33220A Function / Arbitrary Waveform Generator

Waveforms

Standard: Sine, Square, Ramp, Triangle, Pulse, Noise, DC

Built-in Arbitrary: Exponential rise, Exponential fall, Negative ramp, Sin(x)/x, Cardiac.

Waveform Characteristics

Sine

Frequency Range: 1 μ Hz - 20 MHz

Amplitude Flatness: [1], [2]

	(Relative to 1 kHz)
< 100 kHz	0.1 dB
100 kHz to 5 MHz	0.15 dB
5 MHz to 20 MHz	0.3 dB

Harmonic Distortion: [2], [3]

	< 1 Vpp	\geq 1 Vpp
DC to 20 kHz	-70 dBc	-70 dBc
20 kHz to 100 kHz	-65 dBc	-60 dBc
100 kHz to 1 MHz	-50 dBc	-45 dBc
1 MHz to 20 MHz	-40 dBc	-35 dBc

Total Harmonic Distortion: [2], [3]

DC to 20 kHz 0.04%

Spurious (Non-Harmonic) Distortion: [2], [4]

DC to 1 MHz -70 dBc
 1 MHz to 20 MHz -70 dBc +6 dB/octave

Phase Noise (10 kHz offset): -115 dBc / Hz, typical

Square

Frequency Range: 1 μ Hz to 20 MHz
 Rise/Fall Time: < 13 ns
 Overshoot: < 2%
 Variable Duty Cycle: 20% - 80% (to 10 MHz)
 40% - 60% (to 20 MHz)
 Asymmetry (@ 50% Duty): 1% of period + 5 ns
 Jitter: 300 ps + 100 ppm of period

Ramp, Triangle

Frequency Range: 1 μ Hz to 200 kHz
 Linearity: < 0.1% of peak output
 Variable Symmetry: 0.0% to 100.0%

Pulse

Frequency Range: 500 μ Hz to 5 MHz
 Pulse Width (period \leq 10 s): 20 ns minimum, 10 ns resolution

Variable Edge Time: < 13 ns to 100 ns

Overshoot: < 2%
 Jitter: 300 ps + 0.1 ppm of period

Noise

Bandwidth (-3dB): 9 MHz, typical

Arbitrary

Frequency Range: 1 μ Hz to 6 MHz
 Waveform Length: 2 to 64 K points
 Amplitude Resolution: 14 bits (including sign)
 Sample Rate: 50 MSa/s
 Minimum Rise/Fall Time: 35 ns, typical
 Linearity: < 0.1% of peak output
 Settling Time: < 250 ns to 0.5% of final value
 Jitter (RMS): 6 ns + 30 ppm
 Non-volatile Memory: Four waveforms

Chapter 8 Specifications

Agilent 33220A Function/Arbitrary Waveform Generator

Common Characteristics

Amplitude

Range:
 Into 50 Ω : 10 mVpp to 10 Vpp
 Into open circuit: 20 mVpp to 20 Vpp

Accuracy (at 1 kHz): ^{[1], [2]} $\pm 1\%$ of setting
 ± 1 mVpp

Units: Vpp, Vrms, dBm

Resolution: 4 digits

DC Offset

Range (peak AC + DC): ± 5 V into 50 Ω
 ± 10 V into open circuit

Accuracy: ^{[1], [2]} $\pm 2\%$ of offset setting
 $\pm 0.5\%$ of ampl. ± 2 mV

Resolution: 4 digits

Main Output

Impedance: 50 Ω typical

Isolation: 42 Vpk maximum to earth

Protection: Short-circuit protected, overload automatically disables main output

Internal Frequency Reference

Accuracy: ^[5] ± 10 ppm in 90 days,
 ± 20 ppm in 1 year

External Frequency Reference (Option 001)

Rear Panel Input:

Lock Range: 10 MHz \pm 500 Hz
 Level: 100 mVpp to 5 Vpp
 Impedance: 1 k Ω typical, AC coupled
 Lock Time: < 2 seconds

Rear Panel Output:

Frequency: 10 MHz
 Level: 632 mVpp (0 dBm), typical
 Impedance: 50 Ω typical, AC coupled

Phase Offset:

Range: +360 to -360 degrees
 Resolution: 0.001 degrees
 Accuracy: 20 ns

Modulation

AM

Carrier Waveforms: Sine, Square, Ramp, Arb

Source: Internal/External

Internal Modulation: Sine, Square, Ramp, Triangle, Noise, Arb (2 MHz to 20 kHz)

Depth: 0.0% to 120.0%

FM

Carrier Waveforms: Sine, Square, Ramp, Arb

Source: Internal/External

Internal Modulation: Sine, Square, Ramp, Triangle, Noise, Arb (2 MHz to 20 kHz)

Deviation: DC to 10 MHz

PM

Carrier Waveforms: Sine, Square, Ramp, Arb

Source: Internal/External

Internal Modulation: Sine, Square, Ramp, Triangle, Noise, Arb (2 MHz to 20 kHz)

Deviation: 0.0 to 360.0 degrees

PWM

Carrier Waveforms: Pulse

Source: Internal/External

Internal Modulation: Sine, Square, Ramp, Triangle, Noise, Arb (2 MHz to 20 kHz)

Deviation: 0% to 100% of pulse width

Chapter 8 Specifications
Agilent 33220A Function / Arbitrary Waveform Generator

FSK

Carrier Waveforms: Sine, Square, Ramp, Arb
 Source: Internal/External
 Internal Modulation: 50% duty cycle square (2 mHz to 100 kHz)

**External Modulation Input ^[6]
 (for AM, FM, PM, PWM)**

Voltage Range: ± 5 V full scale
 Input Resistance: 5 kΩ typical
 Bandwidth: DC to 20 kHz

Sweep

Waveforms: Sine, Square, Ramp, Arb
 Type: Linear or Logarithmic
 Direction: Up or Down
 Sweep Time: 1 ms to 500 s
 Trigger: Single, External or Internal
 Marker: Falling edge of Sync signal (programmable frequency)

Burst ^[7]

Waveforms: Sine, Square, Ramp, Triangle, Pulse, Noise, Arb
 Type: Counted (1 to 50,000 cycles), Infinite, Gated
 Start/Stop Phase: -360 to +360 degrees
 Internal Period: 1 μs to 500 s
 Gate Source: External Trigger
 Trigger Source: Single, External, or Internal

Trigger Characteristics

Trigger Input:
 Input Level: TTL compatible
 Slope: Rising or falling, selectable
 Pulse Width: > 100 ns
 Input Impedance: > 10 kΩ, DC coupled
 Latency: < 500 ns
 Jitter (RMS): 6 ns (3.5 ns for Pulse)
 Trigger Output:
 Level: TTL compatible into ≥ 1 kΩ
 Pulse Width: > 400 ns
 Output Impedance: 50 Ω, typical
 Maximum Rate: 1 MHz

Programming Times (typical)

Configuration Times

	USB	LAN	GPIB
Function Change	99 ms	100 ms	99 ms
Frequency Change	3 ms	5 ms	2 ms
Amplitude Change	36 ms	36 ms	36 ms
Select User Arb	111 ms	112 ms	109 ms

Arb Download Times (binary transfer)

	USB	LAN	GPIB
64 K points	101 ms	250 ms	356 ms
16 K points	26 ms	62 ms	87 ms
4 K points	8 ms	20 ms	22 ms

Download times do not include setup or output time.

Chapter 8 Specifications

Agilent 33220A Function / Arbitrary Waveform Generator

General

Power Supply:	CAT II 100 to 240 V @ 50/60 Hz (-5%, +10%) 100 to 120 V @ 400 Hz ($\pm 10\%$)
Power Consumption:	50 VA maximum
Operating Environment:	IEC 61010 Pollution Degree 2 Indoor Location
Operating Temperature:	0 °C to 55 °C
Operating Humidity:	5% to 80% RH, non-condensing
Operating Altitude:	Up to 3000 meters
Storage Temperature:	-30 °C to 70 °C
State Storage Memory:	Power off state automatically saved. Four user-configurable stored states.
Interface:	GPIO, USB, and LAN standard
Language:	SCPI - 1993, IEEE-488.2
Dimensions (W x H x D):	
Bench Top:	261.1 mm by 103.8 mm by 303.2 mm
Rack Mount:	212.8 mm by 88.3 mm by 272.3 mm
Weight:	3.4 kg (7.5 lbs)
Safety Designed to:	UL-1244, CSA 1010, EN61010
EMC Tested to:	MIL-461C, EN55011, EN50082-1
Vibration and Shock:	MIL-T-28800, Type III, Class 5
Acoustic Noise:	30 dBa
Warm-up Time:	1 hour
Warranty:	3 years standard

Note: Specifications are subject to change without notice. For the latest specifications, go to the Agilent 33220A product page and find the Product Datasheet.

www.agilent.com/find/33220A

This ISM device complies with Canadian ICES-001.

Cet appareil ISM est conforme à la norme NMB-001 du Canada.



Footnotes:

- ¹ Add 1/10th of output amplitude and offset specification per °C for operation outside the range of 18 °C to 28 °C.
- ² Autorange enabled.
- ³ DC offset set to 0 V.
- ⁴ Spurious distortion at low amplitude is limited by -75 dBm typical.
- ⁵ Add 1 ppm / °C (average) for operation outside the range 18 °C to 28 °C.
- ⁶ FSK uses trigger input (1 MHz maximum).
- ⁷ Sine and square waveforms above 6 MHz are allowed only with an "infinite" burst count.

Chapter 8 Specifications
Agilent 33220A Function / Arbitrary Waveform Generator

Product Dimensions

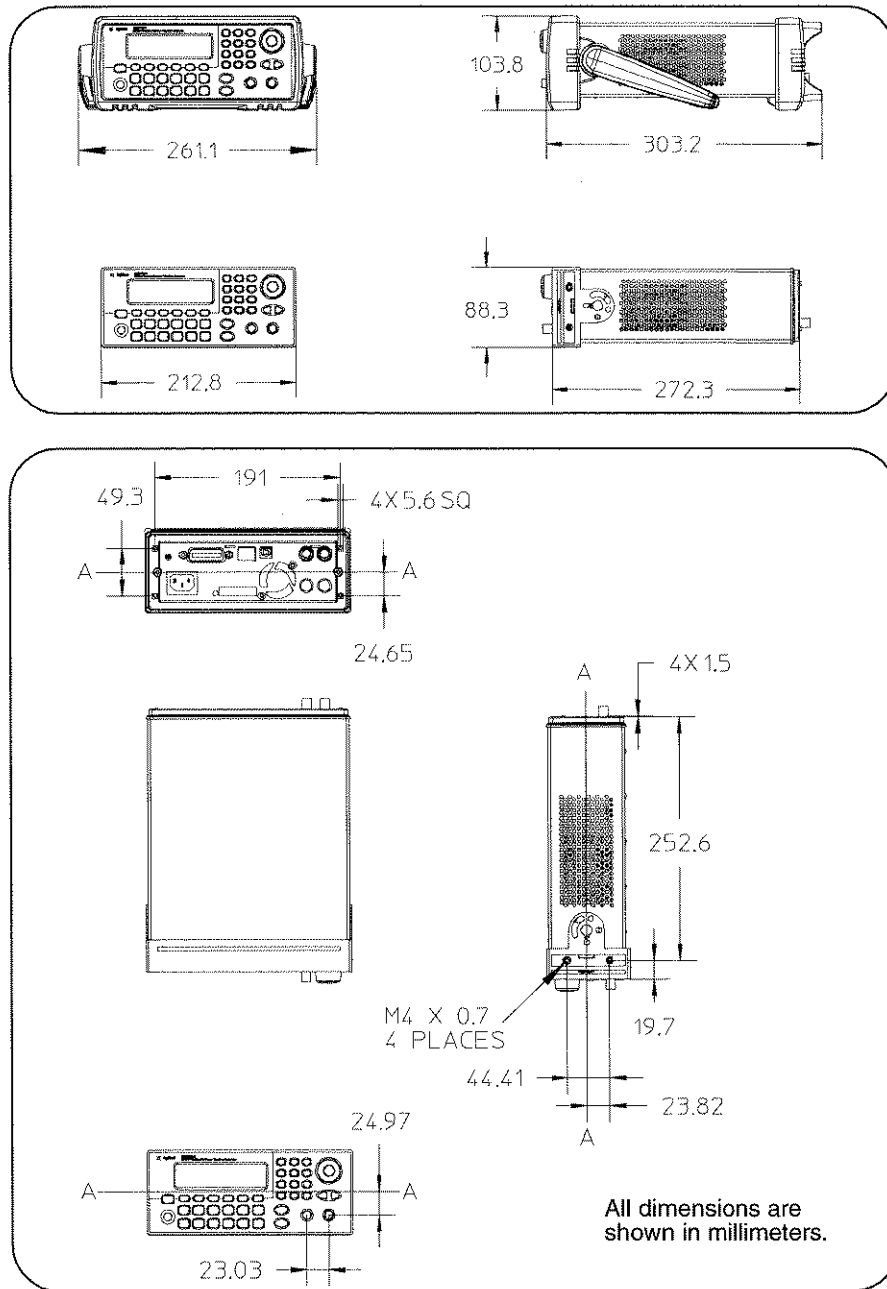

Index

If you have questions relating to the operation of the Agilent 33220A, call 1-800-452-4844 in the United States, or contact your nearest Agilent Technologies Office.

- 10 MHz In connector 248
- 10 MHz Out connector 248
- *CLS command 263
- *ESE command 262
- *IDN? command 243
- *LRN? command 245
- *OPC command 213, 222, 246, 263
- *OPC? command 213, 222, 246
- *PSC command 263
- *RCL command 239
- *RST command 245
- *SAV command 238
- *SRE command 260
- *STB? command 254, 260
- *TRG command 213, 222, 225
- *TST? command 245
- *WAI command 213, 222, 246

- A**
- ac connector 6
- address
 - GPIB 135
- Agilent Express 7
- air flow 30
- aliasing 315
- AM 74
 - carrier frequency 75
 - carrier waveform 75
 - front-panel operation 36
- INTernal
 - FREQUENCY command 192
 - FUNCTION command 191
 - modulating frequency 192
 - modulating source 78, 191
 - modulating waveform 76, 191
 - modulation depth 77, 328
 - modulation source 78
 - overview 190
 - SOURCE command 191
 - STATE command 192
 - tutorial description 327
- amplitude 18
 - arb waveform limitations 59, 166
 - dBm limitations 175
 - high / low level 176
 - load limitations 58, 165, 175
 - offset limitations 58, 175
 - range hold 66
 - tutorial description 322
 - unit limitations 58
 - units 62
- amplitude modulation 74, 79
 - carrier frequency 75
 - carrier waveform 75
 - front-panel operation 36
 - modulating frequency 192
 - modulating source 78, 191
 - modulating waveform 76
 - modulation depth 77, 328
 - modulation waveshape 191
 - overview 190
 - tutorial description 327
- amplitude units
 - converting 19
- angle, phase (burst) 220, 221
- anti-aliasing filters 313
- application programs 301
- APPLY
 - DC command 170
 - NOISE command 170
 - PULSE command 169
 - RAMP command 169
 - SINusoid command 169
 - SQUare command 169
 - USER command 170
- APPLY command 163
 - operations performed 163
- APPLY? command 171
- arbitrary waveform
 - downloading binary values 230
 - downloading floating-point values 229
 - downloading integer values 230
 - front-panel operation 26
- arbitrary waveform limitations 176
- arbitrary waveforms
 - amplitude limitations 166
 - as modulating waveshape 125
 - built-in waveforms 26, 228
 - calculating crest factor 237
 - creating from front panel 120
 - deleting from memory 236
 - error messages 299
 - front-panel rules 123
 - naming 124
 - overview 227
 - point interpolation 122
 - rules 125
 - tutorial description 316
- attenuator settings 179
- automatic power-down recall 241
- autorange 179, 322
- autoranging, amplitude 66

Index

- B**
- balun effect 324
 - beep
 - enable / disable 245, 246
 - beeper 130
 - binary block format 231
 - binary download, arbs 230
 - bit definitions
 - questionable data register 256
 - standard event register 258
 - status byte register 252
 - blank display 130
 - block format, binary 231
 - BNC
 - Modulation In 78, 84, 92, 98
 - brightness, display 131
 - built-in arb waveforms 228
 - built-in arbitrary waveforms
 - names 233
 - built-in help system 27
 - bulb-saver mode 130
 - bumpers, removing 29
 - BURSt
 - GATE
 - POLarity command 223, 225
 - INTernal
 - PERiod command 220
 - MODE command 218
 - NCYCLes command 219
 - PHASe command 220
 - STATe command 221
 - Burst 110
 - burst 106
 - burst count 110
 - burst count 219
 - burst period 111, 220
 - burst phase 112
 - burst type 107
 - external gated mode 107
 - external trigger source 118
 - front-panel operation 44
 - gate polarity 223, 225
 - gated burst 334
 - gated mode 216
 - modes available 216
 - n-cycle burst 333
 - overview 216
 - starting phase 220, 333
 - trigger delay 333
 - trigger out signal 114
 - trigger output 119
 - trigger source 113
 - triggered mode 107, 216
 - waveform frequency 109
 - burst phase
 - degrees vs. radians 221
 - bus
 - interface configuration 135
 - bus (software) trigger 213, 221, 224
 - bus trigger 117, 225
 - byte order, binary block transfers 232
- C**
- CALibration
 - COUNT? command 265
 - SECure
 - CODE command 265
 - STATe command 264
 - SETup command 264
 - STRing command 265
 - VALue command 264
 - calibration
 - commands 264
 - error messages 298
 - message 144
 - read count 143
 - reading count 265
 - securing 264
 - security code 141
 - setups 264
 - storing text message 265
 - unsecuring 264
 - calibration certificate 15
 - CALibration? command 264
 - cardiac waveform 228
 - carriage return 269
 - carrying handle
 - changing positions 16
 - carrying handle, removing 29
 - catalog
 - arbitrary waveforms 235
 - CD-ROM, connectivity software 15
 - CD-ROM, shipped with 33220A 302
 - center frequency, sweep 211
 - chassis ground 6
 - comma separator 133
 - command errors 129, 242
 - command parameter types 270
 - command reference 147
 - command summary 149
 - command terminators 269
 - command trigger 225
 - commands
 - PM 198
 - PWM 204
 - configuration
 - LAN 135
 - remote interface 135
 - USB 135
 - connector 248
 - Modulation In 78, 84, 92, 98

Index

Output 181
Sync Output 68
Sync output 215
Trig In 118
Trig Out 119
connector 10 MHz Out 248
context-sensitive help 27
contrast, display 131
count
 burst 219
count (burst) 110
crest factor 325
crest factor, arb waveforms 237
custom name
 stored states 240
custom names
 arbitrary waveforms 124
 stored states 127
cycle count
 burst 219
cycle count (burst) 110

D

DATA
 ATTRibute
 CFACtor? command
 237
 CATalog? command 235
 COPY command 232
 DAC VOLATILE command
 230
 DElete
 ALL command 236
 DElete command 236
 NVOLatile
 CATalog? command 235
 FREE? command 235
DATA VOLATILE command 229
dBc 320

dBm 62, 184, 326
dc offset
 amplitude limitations 60,
 167, 177
 arb waveform limitations
 167
 arbitrary waveform
 limitations 61, 177
 front-panel selection 20
 load limitations 60, 167, 177
dc voltage 176
 front-panel selection 20
DC volts
 setting 22
DDS 313
decimal point 133
default settings 145
degrees 220
delete arb waveforms 236
delete stored states 240
depth (AM) 192
depth, AM modulation 328
deviation (FM) 96, 97, 195
deviation (PM) 199
deviation (FM) 83
deviation, FM modulation 329
device clear 271
DHCP On/Off 136
digits separator 133
dimensions
 product 340
direct digital synthesis 313
DISplay
 TEXT
 CLEar command 244
 TEXT command 244
display 243
 contrast 131
 displaying message 132, 244

 enable / disable 132, 243
 number format 133
 overview 4
display brightness 131
display bulb saver mode 130
DISplay command 243
display, graph mode 25
DNS server 139
domain name 139
duty cycle 64
 definition 64, 180
 frequency limitations 57, 64,
 174, 180
 front-panel selection 23
 modulation limits 180

E

edge time 189
 definition 189
edge time, pulse 24, 73
end-or-identify message 269
EOI 269
error
 on phase unlock 249
error messages 273
errors 129, 242
 "data out of range" errors
 287
 "settings conflict" errors 278
 arbitrary waveform errors
 299
 calibration errors 298
 device dependent errors 293
 execution errors 278
 instrument errors 295
 number allowed 242
 query errors 294
 self-test errors 296

Index

examples

- programming 301
- exponential fall waveform 228
- exponential rise waveform 228
- external gated burst 107
- external gated mode, burst 216
- external reference 248
- external source
 - AM 78
 - FSK 92
 - PWM 98
- external trigger 117, 213, 221, 224
- external trigger source 118, 119

F

- filters, anti-aliasing 313
- firmware revision 134
- floating-point download, arbs 229
- FM 79
 - carrier frequency 81
 - carrier waveform 80
 - deviation 329
 - DEVIation command 96, 97, 195
 - frequency deviation 83, 96, 97, 195
- INTERNAL
 - FREQuency command 195
 - FUNCTion command 194
- modulating frequency 82, 195
- modulating source 84, 194
- modulating waveform 82, 194
- overview 193

- SOURce command 194
- STATe command 196
- tutorial description 327
- FORMat
 - BORDER command 232
- FREQuency
 - CENTER command 211
 - SPAN command 211
 - STARt command 210
 - STOP command 210
- frequency
 - burst limitation 57
 - duty cycle limitations 57, 174
 - front-panel selection 17
 - function limitations 57, 164, 174
 - sweep time 102
- FREQuency command 174
- frequency deviation (FM) 83, 96, 97, 195, 329
- frequency modulation
 - carrier frequency 81
 - carrier waveform 80
 - deviation 329
 - frequency deviation 83, 96, 97, 195
 - modulating frequency 82, 195
 - modulating source 84, 194
 - modulating waveform 82
 - modulation waveshape 194
 - overview 193
 - tutorial description 327
- frequency span, sweep 211
- frequency sweep 99, 332
 - center frequency 101, 211
 - external trigger source 118
 - frequency span 101, 211

- front-panel operation 40, 42
- linear vs. logarithmic 102, 332
- linear vs. logarithmic spacing 212
- marker frequency 103, 215
- overview 208
- spacing 102
- start frequency 100
- stop frequency 100, 210
- sweep time 212
- trigger out signal 105
- trigger output 119
- trigger source 104
- frequency sweeps
 - Sync signal 100, 101
- FREQuency? command 174
- frequency-shift keying
 - see FSK
- frequency-shift keying, See FSK 38
- front panel
 - connectors 3
 - creating arb waveforms 120
 - display overview 4
 - number entry 5
 - overview 3
- front-panel
 - display enable/disable 132, 243
 - number format 133
- front-panel menu
 - quick reference 33
- front-panel menu operation 31
- front-panel selection 18
- FSK 89
 - "hop" frequency 91, 202
 - carrier frequency 90
 - front-panel operation 38

Index

- FSK rate 39, 91
 - modulating source 92, 201
 - modulating waveform 90
 - modulation source 92
 - overview 200
 - SOURce command 201
 - tutorial description 327
 - FSK rate 39, 202
 - FSKKey
 - FREQuency command 202
 - INTernal FSK rate 202
 - STATe command 202
 - FUNcTION
 - PULSe
 - DCYCLE command 188
 - HOLD command 186
 - TRANSition command 189
 - WIDTH command 187
 - RAMP
 - SYMMetry command 181
 - SYMMetry? command 181
 - SQUare
 - DCYCLE command 180
 - DCYCLE? command 180
 - USER command 233
 - function
 - allowed with modulation 55
 - amplitude limitations 56
 - frequency limitations 56
 - modulation modes allowed 172
 - pulse period limitations 186
 - FUNcTION command 172
 - FUNcTION USER command 234
 - FUNcTION? command 172
- G**
 - gate burst 334
 - gate polarity (burst) 223, 225
 - gated burst 107
 - gated burst mode 216
 - gateway address 138
 - gaussian noise 170
 - GPIB
 - address 135
 - connector 6
 - default address 48
 - front-panel configuration 48
 - setting address 48
 - graph mode 25
 - ground loops 323
- H**
 - handle
 - changing positions 16
 - handle, removing 29
 - harmonic distortion 336
 - header, binary block 231
 - heart waveform 228
 - help system 27
 - language selection 28
 - high impedance load 63
 - high level 178
 - high Z load 35, 63
 - high-level
 - setting 21
 - hop frequency 38, 91, 202
 - host name 138
- I**
 - ID string 243
 - IEEE-488
 - address 135
 - connector 6
 - default address 48
 - front-panel configuration 48
 - setting address 48
 - IEEE-488 binary block format 231
 - IEEE-488 service request 254
 - immediate trigger 213, 221, 224
 - impedance, load 35
 - imperfections, signal 320
 - instrument calibration
 - commands 264
 - error messages 298
 - reading count 265
 - securing 264
 - storing text message 265
 - instrument errors 129, 242
 - instrument ID string 243
 - instrument overview 2
 - instrument reset 35, 245
 - instrument self test 131
 - instrument self-test 245
 - instrument specifications 335
 - instrument state
 - recall power-down state 241
 - instrument state storage 126, 238
 - naming 127
 - power-down recall 126
 - instrument states
 - naming from front panel 47
 - storing from front-panel 47
 - instrument stored states
 - default names 240
 - deleting from memory. 240

Index

- integer download, arbs 230
 - interface (bus) trigger 117
 - interface configuration 135
 - interface errors 129, 242
 - internal trigger 116, 213, 221, 224
 - interpolation 122
 - invert waveform 67
 - IP address 137
- J**
- jitter 321
- L**
- LAN
 - connector 6
 - current configuration 140
 - DHCP 136
 - DNS server 139
 - domain name 139
 - front-panel configuration 49
 - gateway 138
 - host name 138
 - IP address 137
 - subnet mask 137
 - LAN configuration 135
 - language
 - SCPI overview 266
 - language, help system 28
 - LCD display 4
 - bulb-saver mode 130
 - leakage errors 317
 - learn string 245
 - linear interpolation 122
 - linear sweep 212
 - load 35, 63
 - load impedance 323
 - load termination 35
- local language, help 28
 - local operation (LAN) 247
 - logarithmic sweep 212
 - low level 178
 - low-level
 - setting 21
- M**
- manual trigger 116
 - MARKer
 - FREQuency command 215
 - marker frequency 103, 215
 - marker signal 333
 - MAV 255
 - MEMory
 - NSStates? command 241
 - STATe
 - DELeTe command 240
 - NAME command 240
 - RECall
 - AUTO command 241
 - VALid? command 241
 - menu
 - quick reference 33
 - menu operation 31
 - message
 - calibration 144, 265
 - message available (MAV) 255
 - messages
 - error 273
 - modulation 36, 89
 - AM 74
 - FM 79
 - FSK 89
 - PM 85
 - PWM 93
 - tutorial description 327
 - modulation depth (AM) 77, 192, 328
 - modulation depth, percent
 - modulation 36
 - Modulation In connector 78, 84, 92, 98
 - modulation source
 - AM 78
 - FSK 92
 - PWM 98
- N**
- name
 - defaults for stored states 240
 - stored states 240
 - names
 - arbitrary waveforms 124
 - stored states 127
 - naming stored states
 - front-panel operation 47
 - narrowband FM 329
 - n-cycle burst 333
 - negative ramp waveform 228
 - negative trigger slope 214, 222, 225
 - new line 269
 - noise 170
 - number entry 5
 - number keypad 5
 - number of cycles, burst 219
 - number of errors allowed 242
 - numeric entry 5
 - nyquist sampling theorem 315

Index

O

offset

- amplitude limitations 60, 167, 177
- arb waveform limitations 167
- arbitrary waveform limitations 61, 177
- front-panel selection 20
- load limitations 60, 167, 177

operation complete 246

OUTPut

- TRIGger SLOPe command 214, 223, 226
- TRIGger command 214, 223, 226

output

- connector 66
- enable/disable 66, 181
- polarity 67

output amplitude

- arb waveform limitations 166
- arbitrary waveform limitations 59, 176
- dBm limitations 175
- front-panel selection 18
- high / low level 176
- load limitations 58, 165, 175
- offset limitations 58, 175
- range hold 66
- tutorial description 322
- unit limitations 58
- units 62

OUTPut command 181

Output connector 181

- output frequency burst limitations 57

- duty cycle limitations 57, 174

- front-panel selection 17
- function limitations 57, 164, 174

output function

- allowed with modulation 55
- amplitude limitations 56
- frequency limitations 56
- modulation modes allowed 172
- pulse period limitations 186

output impedance 323

output load 63

output overload 181

- output period front-panel selection 17

output resistance 35

output termination 35, 63, 323

- output units 62 dBm limitation 184

output waveform

- polarity 67

overheating 30

overload, output 181

overload, voltage 66

overview

- display 4
- front panel 3
- front-panel menus 33
- number entry 5
- product 2
- rear panel 6

overview, programming 161

P

parameter types 270

password, calibration 141

peak frequency deviation (FM) 83, 96, 97, 195

peak voltage 325

peak-to-peak voltage 325

percent modulation (AM) 77, 192, 328

period

- burst mode 111
- front-panel selection 17
- pulse waveform 70

period, pulse 185

PHASe

REFeRence command 249

UNLock

ERRor

- STATe command 249

phase (burst) 112

PHASe command 248

phase errors 321

phase lock 248

error on unlock 249

phase offset 248

rear-panel connections 248

phase modulation

- carrier frequency 86
- carrier waveform 86
- modulating frequency 199
- modulating source 88, 198
- modulating waveform 87
- modulation waveshape 198
- overview 197
- phase deviation 88, 199

phase noise 321, 336

phase offset

- phase lock 248

phase quantization errors 321

phase units

- burst phase 221

Index

- phase, burst 220
 PM 87
 carrier frequency 86
 carrier waveform 86
 commands 198
 DEVIation command 199
 INT command 198
 INTernal
 FREQuency command 199
 FUNCTion command 198
 modulating frequency 199
 modulating source 88, 198
 modulating waveform 87
 modulation 85
 modulation waveshape 198
 overview 197
 phase deviation 88, 199
 SOURce command 198
 STATe command 199
 point interpolation 122
 polarity 67
 polarity, trigger 214, 222, 225
 polarity, waveform 67
 positive trigger slope 214, 222, 225
 power connector 6
 power cord 15
 power switch 15
 power-down recall 126, 241
 product dimensions 340
 product overview 2
 product specifications 335
 programming commands 147
 programming examples 301
 programming overview 161
 PULSe
 PERiod command 185
 pulse
 front-panel configuration 24
 pulse duty cycle
 definition 188
 pulse edge time 73
 pulse period 185
 function limitations 186
 pulse waveform
 edge time 189
 pulse waveforms
 pulse period 70
 tutorial description 318
 pulse width 24, 71, 72, 187
 definition 185, 187
 pulse width modulation 93
 duty cycle deviation 97, 206
 modulating frequency 205
 modulating source 98, 204
 modulating waveform 95
 modulation waveshape 204
 overview 203
 pulse waveform 94
 width deviation 96, 205
 PWM 93
 commands 204
 DEVIation
 DCYClE command 206
 DEVIation command 205
 duty cycle deviation 97, 206
 INTernal
 FREQuency command 205
 FUNCTion command 204
 modulating frequency 205
 modulating source 98, 204
 modulating waveform 95
 modulation source 98
 modulation waveshape 204
 overview 203
 pulse waveform 94
 width deviation 96, 205
 overview 203
 pulse waveform 94
 SOURce command 204
 STATe command 207
 width deviation 96, 205
- Q**
- quantization errors 321
 questionable data register
 bit definitions 256
 commands 261
 operation 256
 queue, error 129, 242
 quick reference, commands 149
 quick start 13
- R**
- rack mounting kits 30
 radians 220
 ramp waveform
 symmetry 65, 181
 range hold 179, 322
 range hold, amplitude 66
 rear panel
 connectors 6
 overview 6
 recalling stored state 239
 reference, external 248
 register diagram, status
 registers 251
 registers, status 250
 remote (bus) trigger 117
 remote errors 129, 242
 "data out of range" errors 287
 "settings conflict" errors 278
 arbitrary waveform errors 299
-

Index

- calibration errors 298
 - execution errors 278
 - instrument errors 295
 - query errors 294
 - self-test errors 296
 - remote interface
 - command reference 147
 - command summary 149
 - configuration 135
 - remote trigger 225
 - remove arb waveforms 236
 - remove stored state 240
 - reset 35, 245
 - resistance, load 35, 323
 - revision, firmware 134
 - RMS voltage 325
 - root-mean-square 325
 - rubber bumpers, removing 29
- S**
- SCPI
 - command terminators 269
 - language overview 266
 - parameter types 270
 - SCPI command reference 147
 - SCPI command summary 149
 - SCPI status system 250
 - SCPI version 134, 245
 - screen 4
 - displaying message 132, 244
 - number format 133
 - screen blank 130
 - screen contrast 131
 - screen enable / disable 132, 243
 - screen saver mode 130
 - security
 - calibration 141
 - self test 131
 - self-test 245
 - error messages 296
 - serial poll 254
 - service request (SRQ) 254
 - settings
 - default 145
 - shipping contents 15
 - shock hazard 6
 - signal imperfections 320
 - sin(x)/x waveform 228
 - sinc waveform 228
 - sinewave spectral purity 336
 - slope (trigger)
 - trigger input 214
 - trigger output 214
 - slope, trigger 214, 222, 225
 - burst 113
 - sweep 104
 - softkey labels 4
 - software (bus) trigger 117, 213, 221, 224
 - software revision 134
 - software, connectivity 15
 - sound (beeper) 130
 - specifications 335
 - spurs 321
 - square wave
 - duty cycle 180
 - duty cycle selection 23
 - square waveform
 - duty cycle 64
 - square waveforms
 - tutorial description 318
 - SRQ 254
 - standard event register
 - bit definitions 258
 - commands 262
 - operation 258
 - start frequency, sweep 210
 - starting phase (burst) 112
 - starting phase, burst 220
 - state storage 126, 238
 - front-panel operation 47
 - naming 127
 - naming from front panel 47
 - naming location 240
 - power-down recall 126
 - STATus
 - PRESet command 263
 - QUEStionable
 - CONDition? command 261
 - ENABle command 261
 - QUEStionable? command 261
 - status byte register
 - bit definitions 252
 - commands 260
 - operation 252
 - status registers 250
 - condition register 250
 - enable register 250
 - event register 250
 - questionable data register 256
 - register diagram 251
 - standard event register 258
 - status byte register 252
 - status system 250
 - stop frequency, sweep 210
 - stored state
 - recall power-down state 241
 - stored states 126, 238
 - default names 240
 - deleting from memory 240
 - front-panel operation 47
 - naming 127
 - naming from front panel 47
 - power-down recall 126

- strings
 - error 273
- subnet mask 137
- support, technical 7
- swapped byte order 232
- SWEep
 - SPACing command 212
 - STATe command 212
 - TIME command 212
- sweep 99, 332
 - center frequency 101, 211
 - external trigger source 118
 - frequency span 101, 211
 - front-panel operation 40, 42
 - linear vs. logarithmic 102, 332
 - linear vs. logarithmic spacing 212
 - marker frequency 103, 215
 - overview 208
 - spacing 102
 - start frequency 100, 210
 - stop frequency 100, 210
 - sweep time 102, 212
 - trigger out signal 105
 - trigger output 119
 - trigger source 104
- sweeps
 - Sync signal 100, 101
- symmetry 65
 - definition 65
- symmetry definition 181
- Sync connector 215
- Sync signal
 - enable/disable 69
- sync signal 333
 - for all waveform functions 68
- Sync connector 68
- syntax, SCPI commands 149
- SYSTEM
 - BEEPer
 - STATe command 245
 - BEEPer command 245, 246
 - COMMunicate
 - RLSTate command 247
 - ERRor? command 242
 - VERSion? command 245
- system error 129, 242
- T
- technical support 7
- temperature overload 30
- terminal
 - 10 MHz In 248
 - 10 MHz Out 248
 - Modulation In 78, 84, 92, 98
 - Output 181
 - Sync Output 68
 - Sync output 215
 - Trig In 118
 - Trig Out 119, 214, 223, 226
- termination 35, 63
- termination, load 323
- terminators, command 269
- test 131, 245
- text message
 - calibration 144, 265
- time, sweep 212
- tone
 - enable / disable 245, 246
- transition time, pulse 189
- translated language, help system 28
- Trig In connector 118
- Trig Out connector 119, 214, 223, 226
- TRIGger
 - SLOPe command 214, 222, 225
 - SOURce command 213, 221, 224
- trigger
 - burst 113
 - bus (software) 221, 224
 - external 213, 221, 224
 - immediate (internal) 213, 221, 224
 - software (bus) 213
 - sweep 104
 - trigger out signal (burst) 114
 - trigger out signal (sweep) 105
- TRIGger command 225
- trigger output signal 214, 223, 226
- trigger slope 214, 222, 225
 - burst 113
 - sweep 104
- trigger input 214
- trigger output 214
- trigger source 213
- triggering
 - burst 114
 - external source 117
 - front-panel operation 46
 - internal source 116
 - manual source 116
 - software (bus) source 117
 - sweep 105
 - Trig In connector 118
 - Trig Out connector 119
 - trigger sources 115, 213, 221, 224
- tutorial 311
- TXCO timebase 248

Index

U

UNIT

ANGLE command 249

units

as part of command 184

burst phase 221

converting voltage 19

units, amplitude 62

units, voltage 165

USB

connector 6

USB configuration 135

V

version, SCPI 134, 245

VOLTage

HIGH command 178

HIGH? command 178

LOW command 178

LOW? command 178

OFFSet command 177

OFFSet? command 177

RANGe

AUTO command 179

AUTO? command 179

UNIT command 184

voltage autorange 179, 322

voltage autoranging 66

VOLTage command 175

voltage overload 66

voltage units 62, 165, 184

converting 19

VOLTage? command 175

vpp 62, 184

vrms 62, 184

W

waveform imperfections 320

waveform invert 67

waveform output

connector 66

enable/disable 66, 181

polarity 67

waveform polarity 67

waveform tutorial 311

waveforms

point interpolation 122

wideband FM 329

width, pulse

definition 187

Z

zero-phase reference 249

Index



Manufacturer's Name: Agilent Technologies, Incorporated

Manufacturer's Address: 815 14th Street SW
Loveland, Colorado 80537
USA

Declares, that the product

Product Name: 20 MHz Function/Arbitrary Waveform Generator
Model Number: 33220A
Product Options: This declaration covers all options of the above product(s).

Conforms with the following European Directives:

The product herewith complies with the requirements of the Low Voltage Directive 73/23/EEC and the EMC Directive 89/336/EEC (including 93/68/EEC) and carries the CE Marking accordingly.

Conforms with the following product standards:

EMC	Standard	Limit
	IEC 61326:1997+A1:1998 + A2 :2000 / EN 61326:1997+A1:1998 + A2 :2001 [1]	Group 1 Class A 4kV CD, 8kV AD 3 V/m, 80-1000 MHz 0.5kV signal lines, 1kV power lines 0.5 kV line-line, 1 kV line-ground 3V, 0.15-80 MHz Dips: 30% 10ms; 60% 100ms Interrupt > 95%@5000ms
	CISPR 11:1990 / EN 55011:1991	
	IEC 61000-4-2:1995+A1:1998 / EN 61000-4-2:1995	
	IEC 61000-4-3:1995 / EN 61000-4-3:1995	
	IEC 61000-4-4:1995 / EN 61000-4-4:1995	
	IEC 61000-4-5:1995 / EN 61000-4-5:1995	
	IEC 61000-4-6:1996 / EN 61000-4-6:1996	
	IEC 61000-4-11:1994 / EN 61000-4-11:1994	
	Canada: ICES-001:1998 [2] Australia/New Zealand: AS/NZS 2064.1	

[1] This product was tested in a typical configuration with Agilent Technologies test systems.
[2] This ISM device complies with Canadian ICES-001-1998.
Cet appareil ISM est conforme à la norme NMB-001-1998 du Canada

Safety IEC 61010-1:2001 / EN 61010-1:2001
Canada: CSA C22.2 No. 1010.1:1992
UL 3111-1: 1994

21 February 2003

Date

Ray Corson
Product Regulations Program Manager

For further information, please contact your local Agilent Technologies sales office, agent or distributor.

Free Manuals Download Website

<http://myh66.com>

<http://usermanuals.us>

<http://www.somanuals.com>

<http://www.4manuals.cc>

<http://www.manual-lib.com>

<http://www.404manual.com>

<http://www.luxmanual.com>

<http://aubethermostatmanual.com>

Golf course search by state

<http://golfingnear.com>

Email search by domain

<http://emailbydomain.com>

Auto manuals search

<http://auto.somanuals.com>

TV manuals search

<http://tv.somanuals.com>