

Washer/Extractor

AC Adjustable Frequency
Drive Information
For Allen-Bradley Model Numbers:

160
1305
1336
PowerFlex 40
PowerFlex 400

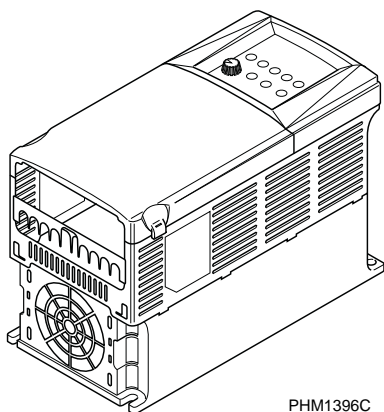

PHM1396C

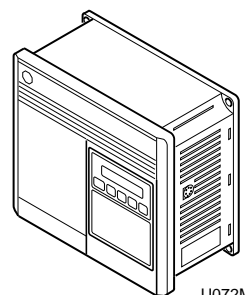

U072M

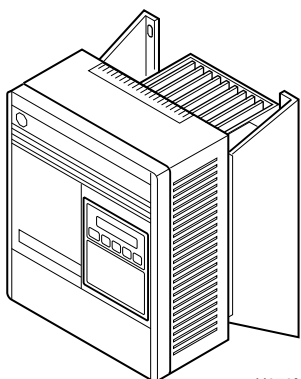

U073M

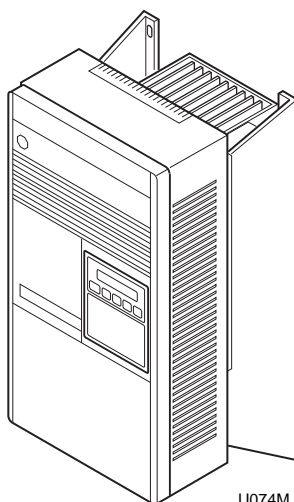

U074M

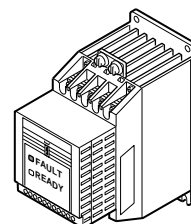

U071M

Table of Contents

General Information	3
Nameplate Location.....	4
General Inspection.....	5
Storage.....	5
PowerFlex 40 and 400 Drive Control Logic	6
Installation/Wiring.....	6
Input Power Conditioning.....	6
Electrical Interference.....	7
Terminal Block Access.....	8
Power Terminal Block Description.....	9
Control Terminal Blocks Description and Control Logic.....	10
AC Drive Diagnostics/Parameter Viewing.....	28
PowerFlex Integrated Keypad.....	28
Fault Display and Troubleshooting Information.....	32
Allen-Bradley Drive Fault Codes.....	33
Troubleshooting Suggestions.....	35
Allen-Bradley 160-Series AC Drives	36
Installation/Wiring.....	36
Input Power Conditioning.....	36
Electrical Interference.....	37
Terminal Block Access.....	39
Power Terminal Block Description.....	40
Control Terminal Blocks Description and Control Logic.....	41
160 Series Drive Control Logic Chart.....	42
AC Drive Diagnostics/Parameter Viewing.....	51
160 Program Keypad Module (PKM or Parameter Unit).....	51
CopyCat Keypad.....	54
Fault Display and Troubleshooting Information.....	58
Fault Code Identification.....	58
Allen-Bradley Drive Fault Codes.....	59
Troubleshooting Suggestions.....	61
Allen-Bradley 1305-Series AC Drives	62
Installation/Wiring.....	62
Input Power Conditioning.....	62
Electrical Interference.....	63
Terminal Block Access.....	64
Power Terminal Block Description.....	65
Control Terminal Blocks Description and Control Logic.....	65
AC Drive Diagnostics/Parameter Viewing.....	73
Human Interface Module (HIM or Parameter Unit).....	73
HIM Structure Chart – Series A 3.00, Series B 1.01 or Later Versions.....	75
HIM Structure Chart – Earlier Versions.....	76
Fault Display and Troubleshooting Information.....	80
Fault Code Identification.....	80
Allen-Bradley Drive Fault Codes.....	81
Troubleshooting Suggestions.....	83

© Copyright 2010, Alliance Laundry Systems LLC

All rights reserved. No part of the contents of this book may be reproduced or transmitted in any form or by any means without the expressed written consent of the publisher.

Allen-Bradley 1336-Series AC Drives	84
Installation/Wiring.....	84
Input Power Conditioning.....	84
Electrical Interference.....	85
Terminal Block Access.....	86
Power Terminal Block Description.....	87
Control Terminal Blocks Description and Control Logic.....	88
AC Drive Diagnostics/Parameter Viewing.....	98
Human Interface Module (HIM or Parameter Unit).....	98
HIM Structure Chart – Series A 3.00, Series B 1.01 or Later Versions.....	100
HIM Structure Chart – Earlier Versions.....	101
Fault Display and Troubleshooting Information.....	105
Fault Code Identification.....	105
Allen-Bradley Drive Fault Codes.....	107
Troubleshooting Suggestions.....	109

General Information

- This drive contains ESD (Electrostatic Discharge) sensitive parts and assemblies. Static control precautions are required when installing, testing, or servicing this assembly. Component damage may result if ESD control procedures are not followed.
- An incorrectly applied or installed drive can result in component damage or a reduction in product life. Wiring or application errors, such as incorrect or inadequate AC supply or excessive ambient temperatures, may result in malfunction of the system.
- This drive contains power storage devices that retain their charge for a time after the removal of main power. Extreme caution should be used when working in and around the drive. It is recommended that main disconnect power to the drive remain off for three minutes prior to approaching connections.

Warnings specific to a particular subject will appear in the manual with the discussion of that subject.

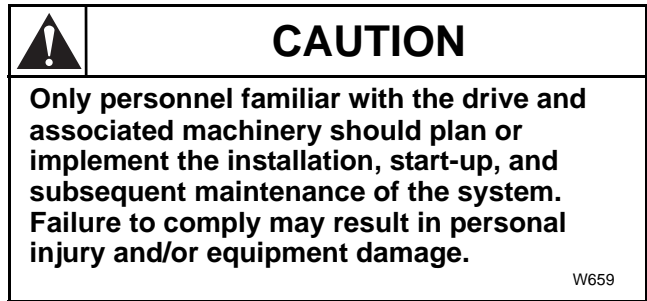

General Information

Nameplate Location

Pertinent drive information used in obtaining information on drive operation or replacement is located on the nameplate shown in *Figures 1 through 4*.

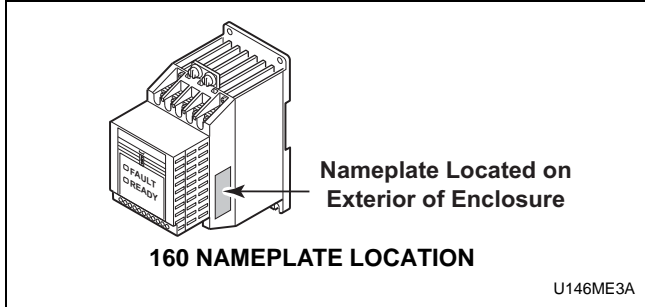

Figure 1

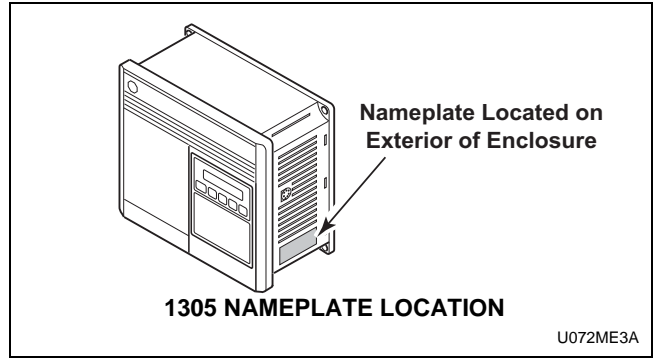

Figure 2

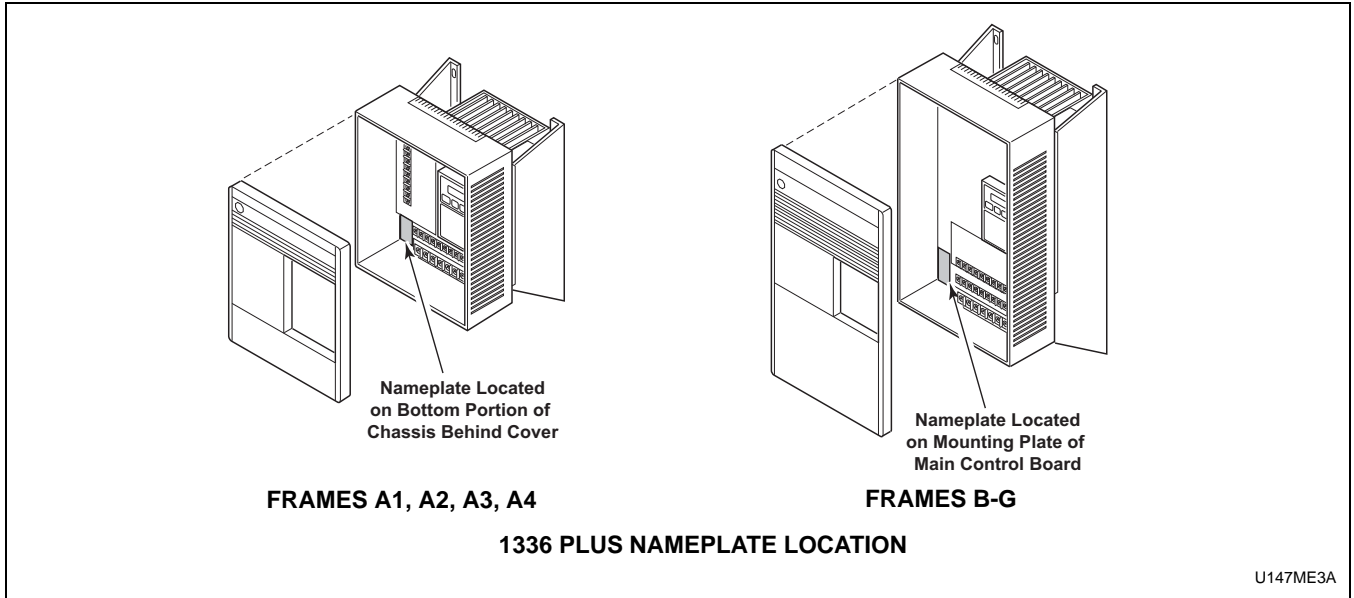

Figure 3

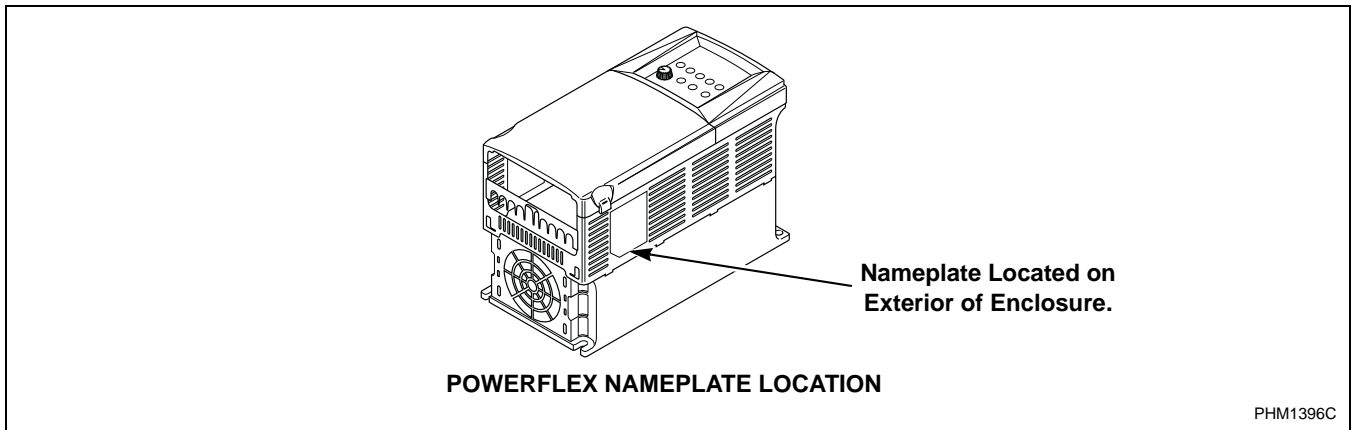

Figure 4

General Inspection

Upon delivery, verify the item's nameplate catalog number against the purchase order.

Before the installation and start-up of the drive, a general inspection of the mechanical integrity (i.e., loose parts, wires, connections, etc.) should be made.

Storage

The drive should remain in its shipping container prior to installation. If the equipment is not to be used for a period of time, it must be stored according to the following instructions in order to maintain warranty coverage:

- Store in a clean, dry location.
- Store within an ambient temperature range of -40 to 70 degrees C.
- Store within a relative humidity range of 0 to 95 percent.
- Do not store equipment where it could be exposed to a corrosive atmosphere.
- Do not store equipment in a construction area.

PowerFlex 40 and 400 Drive Control Logic

Installation/Wiring

	CAUTION
<p>An incorrectly installed system can result in component damage or reduction in product life. The most common causes are:</p> <ol style="list-style-type: none"> 1. Wiring AC line to drive output or control terminals. 2. EXTERNAL voltage application to control terminals. 3. Incorrect or inadequate AC supply. <p>Contact factory for assistance with application or wiring.</p>	
W660	

Input Power Conditioning

The drive is suitable for direct connection to input power within the rated voltage of the drive. Listed in *Table 1* are certain input power conditions which may cause component damage or reduction in product life. If any of the conditions exist, as described in *Table 1*, install one of the devices listed under the heading *Corrective Action* on the line side of the drive.

IMPORTANT: Only one device per branch circuit is required. It should be mounted closest to the branch and sized to handle the total current of the branch circuit.

Input Power Condition	Corrective Action
Low Line impedance (less than 1% line reactance)	<ul style="list-style-type: none"> • Install Line Reactor • or Isolation Transformer • or Bus Inductor – 5.5 & 11kW (7.5 & 15 HP) drives only
Greater than 120 kVA supply transformer	
Line has power factor correction capacitors	<ul style="list-style-type: none"> • Install Line Reactor • or Isolation Transformer
Line has frequent power interruptions	
Line has intermittent noise spikes in excess of 6000V (lightning)	
Phase to ground voltage exceeds 125% of normal line to line voltage	<ul style="list-style-type: none"> • Remove MOV jumper to ground. • or Install Isolation Transformer with grounded secondary if necessary
Ungrounded distribution system	
240V open delta configuration (stinger leg) ⁽¹⁾	<ul style="list-style-type: none"> • Install Line Reactor
<p>⁽¹⁾ For drives applied on an open delta with a middle phase grounded neutral system, the phase opposite the phase that is tapped in the middle to the neutral or earth is referred to as the “stinger leg,” “high leg,” “red leg,” etc. This leg should be identified throughout the system with red or orange tape on the wire at each connection point. The stinger leg should be connected to the center Phase B on the reactor.</p>	

Table 1

Electrical Interference

EMI

Careful attention must be given to the arrangement of power and ground connections to the drive to avoid interference with nearby sensitive equipment. Be sure to replace all ground connections to their appropriate locations.

RFI

Drives can be installed with an RFI filter, which controls high-frequency conducted emissions into the main supply lines.

Where it is essential that very low emission levels must be achieved or if conformity with standards is required, the optional RFI filter may be present. *Figure 5* displays an electrical schematic for various RFI configurations. *Table 2* shows associated RFI filter part numbers.

	<h2>CAUTION</h2>
<p>ELECTRIC SHOCK HAZARD! Service and maintenance to be performed only by an authorized technician. Disconnect power before opening any access panels.</p>	
W661	

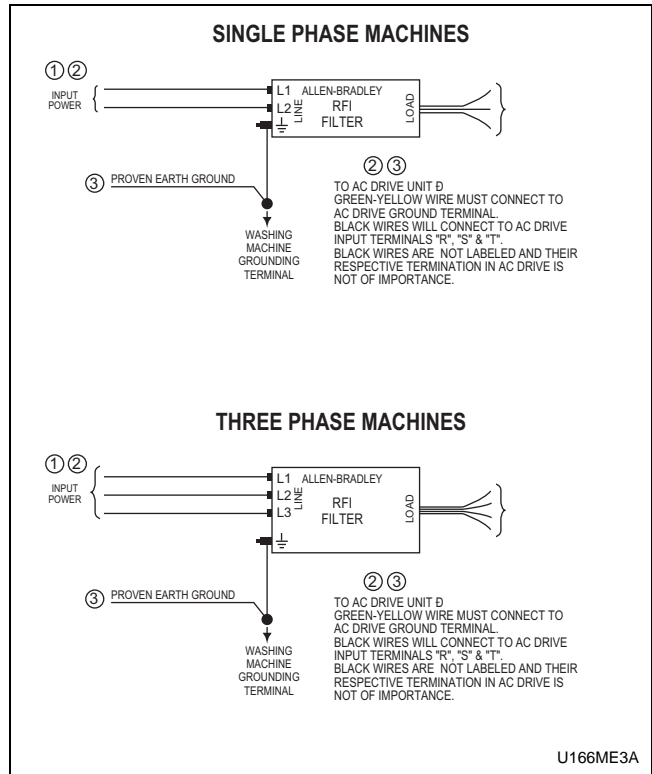



Figure 5

RFI Filter Part Number Information			
Drive P/N	Drive Catalog	Machine Voltage	Filter P/N
F8044301 and F8168603	22B-B017N104xx	200-240V 50-60Hz 3 phase	F8053901
F8044401 and F8168604	22B-D010N104xx	380-480V 50-60Hz 3 phase	F8053902
F8044701 and F8168601	22B-B012N104xx	200-240V 50-60 Hz 3 Phase	F8053901
F8044901 and F8168602	22B-D6P0N104xx	380-480V 50-60 Hz 3 Phase	F8053902
C002501 and F8168701	22B-B024N104xx	200-240V 50-60 Hz 3 Phase	F8054001
C002502 and F8168702	22B-D012N104xx	380-480V 50-60 Hz 3 Phase	F8054002
C002507 and F8168705	22B-D024N104xx	380-480V 50-60 Hz 3 Phase	C002569
C002502, F200309300 and F8168703	22B-B033N104Axx	200-240V 50-60Hz 3 phase	F8054001
C002506, F200309400 and F8168704	22B-D017N104Axx	380-480V 50-60Hz 3 phase	F8054002

Table 2

Terminal Block Access

	WARNING
<p>To reduce risk of electric shock, severe injury or death, allow machine power to remain off for three minutes minimum prior to working in and around AC drive. Proceed with caution.</p>	
<small>W662</small>	

Opening the Cover

1. Press and hold in the tabs on each side of the cover. Refer to *Figure 6*.
2. Pull the cover out and up to release.

The following information illustrates the terminal block designations for each of the drive models.

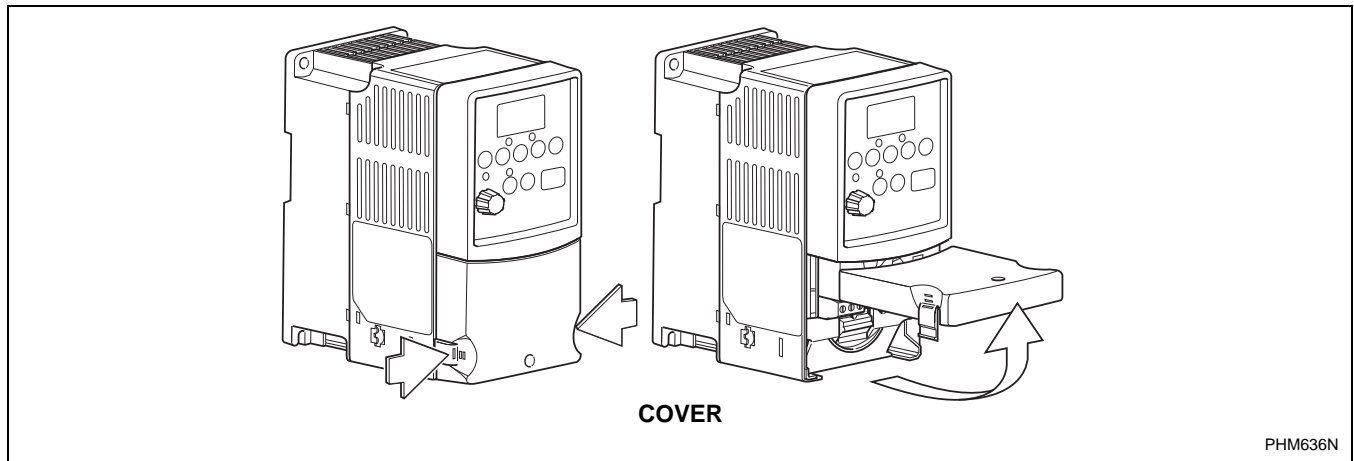

Figure 6

Power Terminal Block

The drive utilizes a finger guard over the power wiring terminals. To remove:

1. Press in and hold the locking tab.
2. Slide finger guard down and out. Refer to *Figure 7*.
3. Replace the finger guard when wiring is complete.

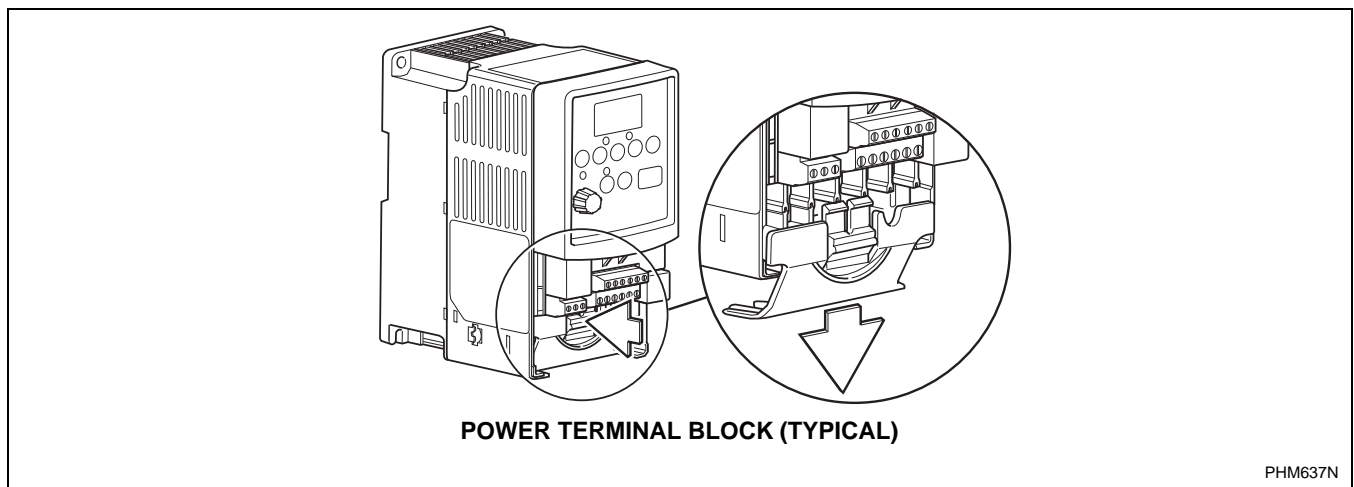

Figure 7

Power Terminal Block Description

PowerFlex 40

Input and Output Power Terminals (TB1)

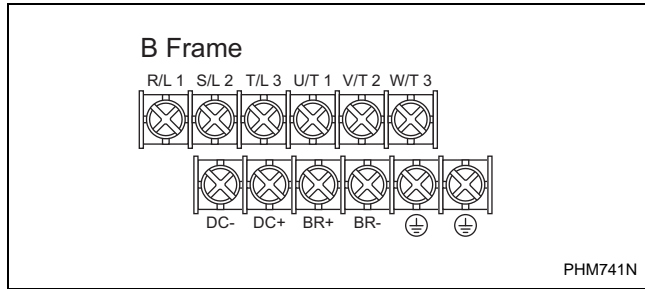

Figure 8

PowerFlex 40

Power Block Terminal (TB1)

Terminal	Description
R/L1, S/L2, T/L3	Single-phase or 3-phase Power Input
U/T1, V/T2, W/T3	3-phase Motor Output
DC-1, DC+, -DC	DC Bus Connection
⊕	Ground Connection (PE)

Table 3

PowerFlex 40

Power Terminal Block

Torque	1.7-2.2 N-m (16-19 lb-in)
Max Wire Size	5.3 mm ² (10 AWG)
Min Wire Size	1.3 mm ² (16 AWG)

Table 4

PowerFlex 400

Input and Output Power Terminals (TB1)

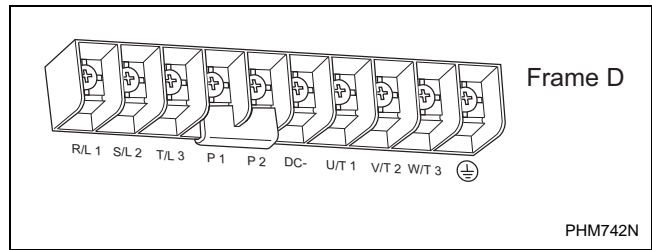

Figure 9

PowerFlex 400

PowerFlex Power Block Terminal (TBI)

Terminal	Description
R/L1, S/L2, T/L3	3-phase Power Input
U/T1, V/T2, W/T3	3-phase Motor Output
P1, P3	DC Bus inductor connection jumper or Bus inductor must be present for drive to power-up.
P2, DC-	DC Bus Connection
⊕	Ground Connection (PE)

Table 5

PowerFlex 400

Power Terminal Block

Torque	5.1N-m (45 lb-in)
Max Wire Size	33.6 mm ² (2 AWG)
Min Wire Size	8.4 mm ² (8 AWG)

Table 6

Control Terminal Blocks Description and Control Logic

	WARNING
<p>To reduce risk of electric shock, severe injury or death, allow machine power to remain off for three minutes minimum prior to working in and around AC drive. Proceed with caution.</p>	
<small>W662</small>	

NOTE: Do not connect AC drive digital common, analog common, or common terminals to chassis ground.

Input Mode Parameter

The control terminal functions are determined in part by the “Start Source” parameter #36. Changing this parameter affects the function of some terminals.

Speed Selection

Motor speeds on digitally-controlled AC drives are controlled by solid state or mechanical switch closure inputs to Digital In 1, Digital In 2, and Digital In 3 terminals. Similarly, motor rotation direction is controlled by inputs to Start/Run FWD and Direction/Run REV terminals. Refer to *Figure 10*.

An inactive control input terminal (H) will measure approximately 24v DC while an active control input terminal (L) will measure less than 1v DC. When a control input (i.e., Digital In 1, 2, 3, 4, Fwd, Rev, or Stop) is connected to a common terminal (terminal 4), the voltage on the control input terminal is reduced to near zero and the input is activated.

Tables 8 – 14 designate the speed and rotation direction based on inputs to the control terminals. The AC drive’s input status parameters display of 1s and 0s at various machine actions can be viewed while monitoring parameter #13 and/or #14. When the control input terminal voltage is high (inactive) the status display will read “0” (logic 0). When the control input terminal voltage is low (active) the status will read “1” (logic 1).

Balance Output

The AC drive balance output signal is transmitted to the machine controller by the operation of an on-board normally open relay or transistor. Refer to *Figure 10*. The AC drive will analyze the wash load distribution during certain drain steps and communicate the severity of load imbalance to the machine controller. The machine controller then determines if the load is suitably distributed for the programmed spin speed. The severity of load imbalance is communicated digitally by the on-board relay or transistor using a series of pulses or continuous open or closed state.

	CAUTION
<p>Never permanently jumper the AC drive balance output terminals or short the wires in these terminals together. This will override the balance detection routine and cause the wash cycle to abort, potentially causing machine damage or personal injury in the process.</p>	
<small>W671</small>	

Stop/Enable Input

The Stop Input function is machine dependent. The input is typically used to disable the drive either when the frame vibration safety limit switch has been tripped or when the loading door has been opened. Refer to the applicable machine electrical schematic for details on the connection of this input. When the Stop Input signal is interrupted, the control input signals must be removed and reapplied to restart the motor operation.

Sink/Source Switch

The PowerFlex series of drives include a DIP Switch that will allow the drive input signals to be wired as “sink” or “source”. This switch should be set to the sink mode on all Alliance Laundry equipment made at the time of this publication. Setting this switch in the source mode will cause the drive to not operate and be mistaken as a failed drive.

0-10V/0-20m A Switch

The PowerFlex series of drives include a DIP switch that will allow the drive analog input signals to be wired as a 0-10V/0-20 mA switch. This switch should be set to the 0-10V mode on all Alliance Laundry Equipment made at the time of this publication. Setting this switch in the 0-20 mA mode may cause the drive to not operate and be mistaken as a failed drive.

Fault Code Display

Refer to Fault Display and Troubleshooting Information.

PowerFlex 40 and 400 Drive Control Logic

PowerFlex 40 Control Terminal Block Designations

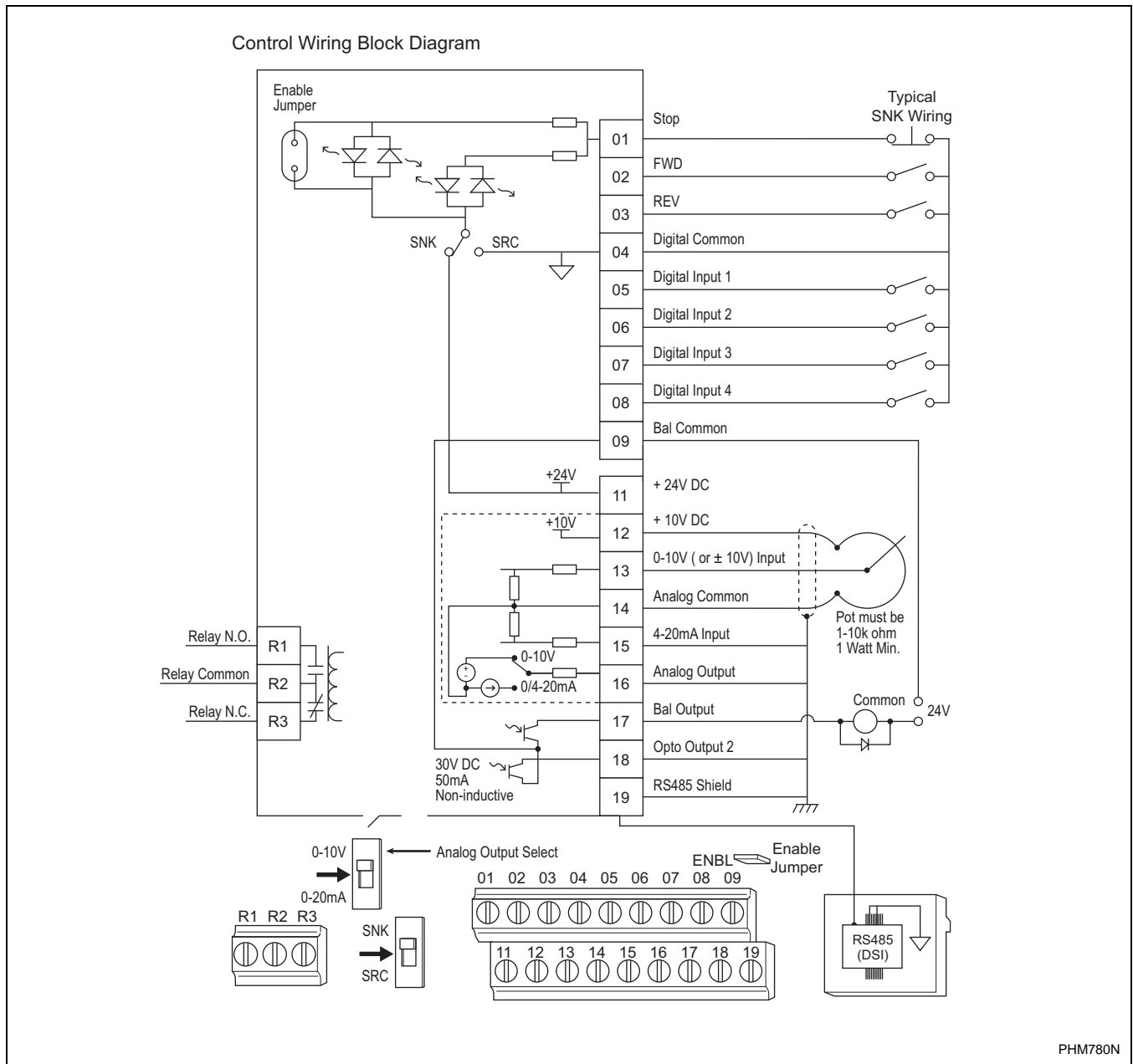

Figure 10

Control Input/Output Terminal Block

Torque	0.5-0.8 N-m (4.4-7.0 lb-in)
Max Wire Size	1.3 mm ² (16 AWG)
Min Wire Size	0.13 mm ² (26 AWG)

Table 7

PowerFlex 400 Control Terminal Block Designations

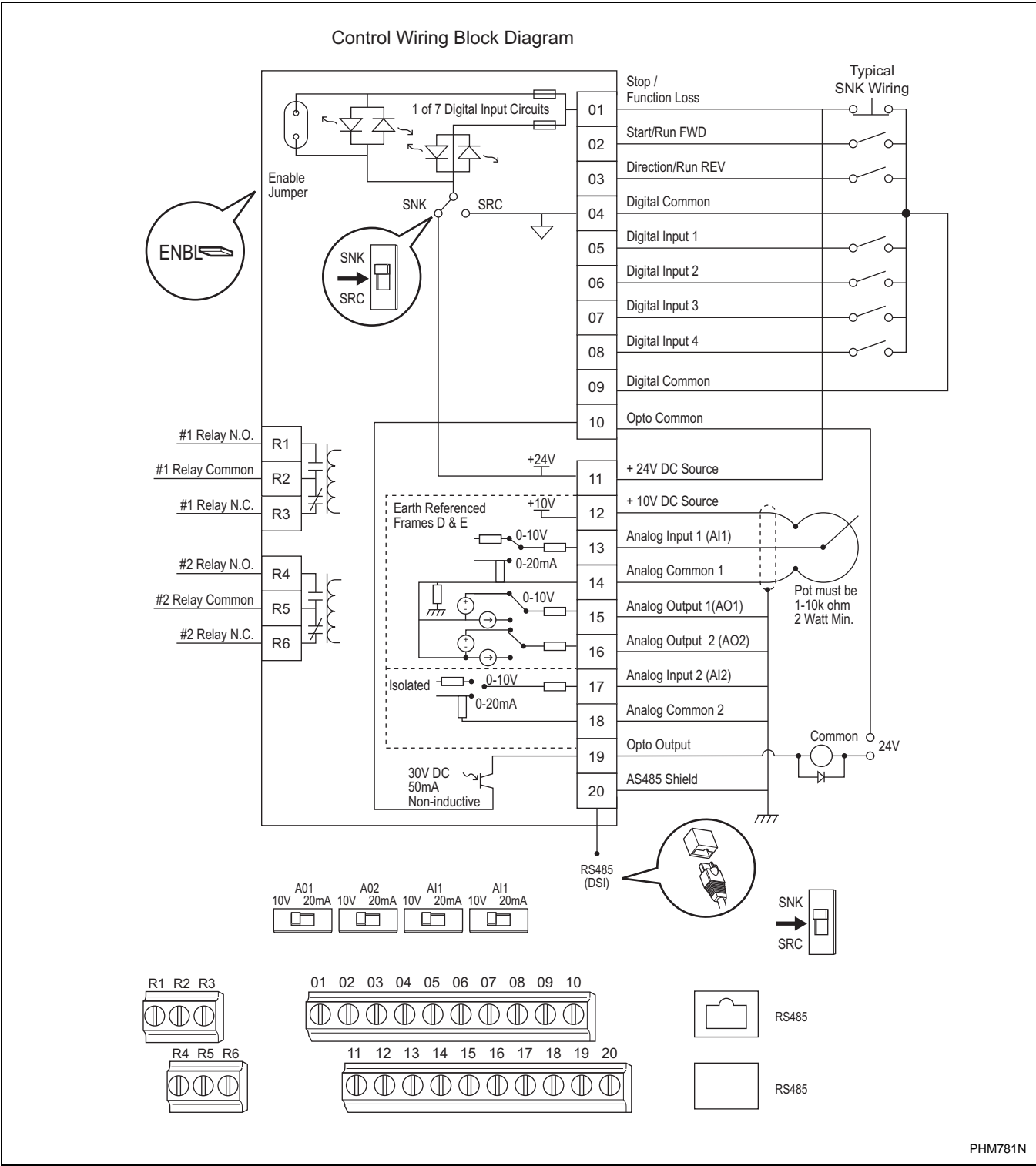

Figure 11

PHM781N

PowerFlex 40 and 400 Drive Control Logic

PowerFlex 40 Drive Control Logic Chart

**Cabinet Hardmount
“A” control, “B” control, “V” Control and EDC/Netmaster Control**

H – Signal Voltage High (approximately 24V DC) L – Signal Voltage Low (less than 1V DC)								0 = No signal received 1 = Signal received							
		Digital In 3	Digital In 2	Digital In 1	Stop	Rev	Fwd	Digital Input Status – Parameter d014				Control Input Status – Parameter d013			
DC Volt Meter Red Probe Terminal Location		07	06	05	01	03	02								
DC Volt Meter Black Probe Terminal Location		04	04	04	04	04	04								
Action	Frequency Preset Parameter #	Terminal #07 (SW3)	Terminal #06 (SW2)	Terminal #05 (SW1)	Terminal #01 (Stop)	Terminal #03 (STR)	Terminal #02 (STF)	*Digital In 4	Digital In 3 (SW3)	Digital In 2 (SW2)	Digital In 1 (SW1)	DB Trans On	Stop	Rev (STR)	Fwd (STF)
Idle	N/A	H	H	H	L/H	H	H	0	0	0	0	0	0/1	0	0
1/2 Wash Speed Forward	71	H	H	L	L	H	L	*1	0	0	1	0	1	0	1
1/2 Wash Speed Reverse	71	H	H	L	L	L	H	0	0	0	1	0	1	1	0
Wash Speed Forward	72	H	L	H	L	H	L	*1	0	1	0	0	1	0	1
Wash Speed Reverse	72	H	L	H	L	L	H	0	0	1	0	0	1	1	0
Distribution Speed	74	L	H	H	L	H	L	*1	1	0	0	0	1	0	1
Spin 1	73	H	L	L	L	H	L	*1	0	1	1	0	1	0	1
Spin 2	76	L	L	H	L	H	L	*1	1	1	0	0	1	0	1
Spin 3	75	L	H	L	L	H	L	*1	1	0	1	0	1	0	1

*If digital in 4 is wired to the Forward Input terminal #02, this input will be a “1” whenever the drive receives a forward command. Disregard otherwise.

**Cabinet Hardmount
Galaxy control, Quantum control and UniMac Software Control**

H – Signal Voltage High (approximately 24V DC) L – Signal Voltage Low (less than 1V DC)								0 = No signal received 1 = Signal received							
		Digital In 3	Digital In 2	Digital In 1	Stop	Rev	Fwd	Digital Input Status – Parameter d014				Control Input Status – Parameter d013			
DC Volt Meter Red Probe Terminal Location		07	06	05	01	03	02								
DC Volt Meter Black Probe Terminal Location		04	04	04	04	04	04								
Action	Frequency Preset Parameter #	Terminal #07 (SW3)	Terminal #06 (SW2)	Terminal #05 (SW1)	Terminal #01 (Stop)	Terminal #03 (STR)	Terminal #02 (STF)	*Digital In 4	Digital In 3 (SW3)	Digital In 2 (SW2)	Digital In 1 (SW1)	DB Trans On	Stop	Rev	Fwd
Idle	N/A	H	H	H	L/H	H	H	0	0	0	0	0	0/1	0	0
Reduced Wash speed (ccw)	70	H	H	H	L	L	H	0	0	0	0	0	1	1	0
Reduced Wash Speed (cw)	70	H	H	H	L	H	L	0	0	0	0	0	1	0	1
Wash Speed (ccw)	72	H	L	H	L	L	H	0	0	1	0	0	1	1	0
Wash Speed (cw)	72	H	L	H	L	H	L	0	0	1	0	0	1	0	1
Distribution Speed 1 (ccw)	71	H	H	L	L	L	H	0	0	0	1	0	1	1	0
Extract Speed 1 (ccw)	76	L	L	H	L	L	H	0	1	1	0	0	1	1	0
Extract Speed 2 (ccw)	75	L	H	L	L	L	H	0	1	0	1	0	1	1	0
Extract Speed 3 (ccw)	73	H	L	L	L	L	H	0	0	1	1	0	1	1	0
Extract Speed 4 (ccw)	77	L	L	L	L	L	H	0	1	1	1	0	1	1	0
Extract Speed 5 (ccw)	74	L	H	H	L	L	H	0	1	0	0	0	1	1	0

Table 8

PowerFlex 40 Drive Control Logic Chart

Pocket Hardmount - 35 lb through 125 lb Capacity
UniLinc control and M30 control

H – Signal Voltage High (approximately 24V DC) L – Signal Voltage Low (less than 1V DC)								0 = No signal received 1 = Signal received							
		Digital In 3	Digital In 2	Digital In 1	Stop	Rev	Fwd	Digital Input Status – Parameter d014				Control Input Status – Parameter d013			
DC Volt Meter Red Probe Terminal Location		07	06	05	01	03	02	Digital In 4	Digital In 3	Digital In 2	Digital In 1	DB Trans On	Stop	Rev	Fwd
DC Volt Meter Black Probe Terminal Location		04	04	04	04	04	04	Digital In 4	Digital In 3	Digital In 2	Digital In 1	DB Trans On	Stop	Rev	Fwd
Action	Frequency Preset Parameter #	Terminal #07	Terminal #06	Terminal #05	Terminal #01	Terminal #03	Terminal #02	Digital In 4	Digital In 3	Digital In 2	Digital In 1	DB Trans On	Stop	Rev	Fwd
Idle	N/A	H	H	H	L/H	H	H	0	0	0	0	0	0/1	0	0
Reduced Wash Speed (cw)	70	H	H	H	L	H	L	0	0	0	0	0	1	0	1
Reduced Wash Speed (ccw)	70	H	H	H	L	L	H	0	0	0	0	0	1	1	0
Wash Speed (cw)	72	H	L	H	L	H	L	0	0	1	0	0	1	0	1
Wash Speed (ccw)	72	H	L	H	L	L	H	0	0	1	0	0	1	1	0
Distribution Speed (cw)	71	H	H	L	L	H	L	0	0	0	1	0	1	0	1
Extract Speed 1 (ccw)	76	L	L	H	L	H	L	0	1	1	0	0	1	0	1
Extract Speed 2 (ccw)	75	L	H	L	L	H	L	0	1	0	1	0	1	0	1
Extract Speed 3 (ccw)	73	H	L	L	L	H	L	0	0	1	1	0	1	0	1
Extract Speed 4 (ccw)	77	L	L	L	L	H	L	0	1	1	1	0	1	0	1
Extract Speed 5 (ccw)	74	L	H	H	L	H	L	0	1	0	0	0	1	0	1

Pocket Hardmount - 150 Capacity
Terminator control Control

H – Signal Voltage High (approximately 24V DC) L – Signal Voltage Low (less than 1V DC)								0 = No signal received 1 = Signal received							
		Digital In 3	Digital In 2	Digital In 1	Stop	Rev	Fwd	Digital Input Status – Parameter d014				Control Input Status – Parameter d013			
DC Volt Meter Red Probe Terminal Location		07	06	05	01	03	02	Digital In 4	Digital In 3	Digital In 2	Digital In 1	DB Trans On	Stop	Rev	Fwd
DC Volt Meter Black Probe Terminal Location		04	04	04	04	04	04	Digital In 4	Digital In 3	Digital In 2	Digital In 1	DB Trans On	Stop	Rev	Fwd
Action	Frequency Preset Parameter #	Terminal #07	Terminal #06	Terminal #05	Terminal #01	Terminal #03	Terminal #02	Digital In 4	Digital In 3	Digital In 2	Digital In 1	DB Trans On	Stop	Rev	Fwd
Idle	N/A	H	H	H	L/H	H	H	0	0	0	0	0	0/1	0	0
Reduced Wash speed (ccw)	70	H	H	H	L	L	H	0	0	0	0	0	1	1	0
Reduced Wash Speed (cw)	70	H	H	H	L	H	L	0	0	0	0	0	1	0	1
Wash Speed (ccw)	72	H	L	H	L	L	H	0	0	1	0	0	1	1	0
Wash Speed (cw)	72	H	L	H	L	H	L	0	0	1	0	0	1	0	1
Distribution Speed (ccw)	71	H	H	L	L	L	H	0	0	0	1	0	1	1	0
Very Low Extract (ccw)	76	L	L	H	L	L	H	0	1	1	0	0	1	1	0
Low Extract (ccw)	75	L	H	L	L	L	H	0	1	0	1	0	1	1	0
Medium Extract (ccw)	73	H	L	L	L	L	H	0	0	1	1	0	1	1	0
High Extract (ccw)	77	L	L	L	L	L	H	0	1	1	1	0	1	1	0
Very High Extract (ccw)	74	L	H	H	L	L	H	0	1	0	0	0	1	1	0

Table 9

PowerFlex 40 and 400 Drive Control Logic

PowerFlex 40 Drive Control Logic Chart

**Pocket Hardmount
“V” control and “A” control - Designs 7 and 8**

H – Signal Voltage High (approximately 24V DC) L – Signal Voltage Low (less than 1V DC)								0 = No signal received 1 = Signal received							
		Digital In 3	Digital In 2	Digital In 1	Stop	Rev	Fwd	Digital Input Status – Parameter d014				Control Input Status – Parameter d013			
DC Volt Meter Red Probe Terminal Location		07	06	05	01	03	02								
DC Volt Meter Black Probe Terminal Location		04	04	04	04	04	04								
Action	Frequency Preset Parameter #	Terminal #07 (SW3)	Terminal #06 (SW2)	Terminal #05 (SW1)	Terminal #01 (Stop)	Terminal #03 (STR)	Terminal #02 (STF)	*Digital In 4	Digital In 3 (SW3)	Digital In 2 (SW2)	Digital In 1 (SW1)	DB Trans On	Stop	Rev (STR)	Fwd (STF)
Idle	N/A	H	H	H	L/H	H	H	0	0	0	0	0	0/1	0	0
1/2 Wash Speed Forward	71	H	H	L	L	H	L	*1	0	0	1	0	1	0	1
1/2 Wash Speed Reverse	71	H	H	L	L	L	H	0	0	0	1	0	1	1	0
Wash Speed Forward	72	H	L	H	L	H	L	*1	0	1	0	0	1	0	1
Wash Speed Reverse	72	H	L	H	L	L	Ha	0	0	1	0	0	1	1	0
Distribution Speed	74	L	H	H	L	H	L	*1	1	0	0	0	1	0	1
Spin 1 Extract	73	H	L	L	L	H	L	*1	0	1	1	0	1	0	1
Spin 2 Extract	76	L	L	H	L	H	L	*1	1	1	0	0	1	0	1
Spin 3 Extract	75	L	H	L	L	H	L	*1	1	0	1	0	1	0	1

*If digital in 4 is wired to the Forward Input terminal #02, this input will be a “1” whenever the drive receives a forward command. Disregard otherwise.

**Pocket Hardmount
WE-6 control - Design 5 and Earlier**

H – Signal Voltage High (approximately 24V DC) L – Signal Voltage Low (less than 1V DC)								0 = No signal received 1 = Signal received							
		Digital In 3	Digital In 2	Digital In 1	Stop	Rev	Fwd	Digital Input Status – Parameter d014				Control Input Status – Parameter d013			
DC Volt Meter Red Probe Terminal Location		07	06	05	01	03	02								
DC Volt Meter Black Probe Terminal Location		04	04	04	04	04	04								
Action	Frequency Preset Parameter #	Terminal #07 (SW3)	Terminal #06 (SW2)	Terminal #05 (SW1)	Terminal #01 (Stop)	Terminal #03 (STR)	Terminal #02 (STF)	*Digital In 4	Digital In 3 (SW3)	Digital In 2 (SW2)	Digital In 1 (SW1)	DB Trans On	Stop	Rev (STR)	Fwd (STF)
Idle	N/A	H	H	H	L/H	H	H	0	0	0	0	0	0/1	0	0
1/2 Wash Speed Forward	74	L	H	L	L	H	H	*1	1	0	0	0	1	0	1
1/2 Wash Speed Reverse	74	L	H	H	L	L	H	0	1	0	0	0	1	1	0
Wash Speed Forward	72	H	L	H	L	H	H	*1	0	1	0	0	1	0	1
Wash Speed Reverse	72	H	L	H	L	L	H	0	0	1	0	0	1	1	0
Distribution Speed	71	H	H	L	L	H	L	*1	0	0	1	0	1	0	1
Medium Extract/Spray Rinse	76	L	L	H	L	H	H	*1	1	1	0	0	1	0	1
High 1 Extract	75	L	H	H	L	H	L	*1	1	0	1	0	1	0	1
High 2 Extract	73	H	L	L	L	H	L	*1	0	1	1	0	1	0	1
High 3 Extract	77	L	L	L	L	H	L	*1	1	1	1	0	1	0	1

*If digital in 4 is wired to the Forward Input terminal #02, this input will be a “1” whenever the drive receives a forward command. Disregard otherwise.

Table 10

**Pocket Hardmount
WE-6 control - Design 6, 7 and 8**

H – Signal Voltage High (approximately 24V DC) L – Signal Voltage Low (less than 1V DC)								0 = No signal received 1 = Signal received							
		Digital In 3	Digital In 2	Digital In 1	Stop	Rev	Fwd	Digital Input Status – Parameter d014				Control Input Status – Parameter d013			
DC Volt Meter Red Probe Terminal Location		07	06	05	01	03	02								
DC Volt Meter Black Probe Terminal Location		04	04	04	04	04	04								
Action	Frequency Preset Parameter #	Terminal #07 (SW3)	Terminal #06 (SW2)	Terminal #05 (SW1)	Terminal #01 (Stop)	Terminal #03 (STR)	Terminal #02 (STF)	*Digital In 4	Digital In 3 (SW3)	Digital In 2 (SW2)	Digital In 1 (SW1)	DB Trans On	Stop	Rev (STR)	Fwd (STF)
Idle	N/A	H	H	H	L/H	H	H	0	0	0	0	0	0/1	0	0
1/2 Wash Speed Forward	70	H	H	H	L	H	L	*1	0	0	0	0	1	0	1
1/2 Wash Speed Reverse	70	H	H	H	L	L	H	0	0	0	0	0	1	1	0
Wash Speed Forward	72	H	L	H	L	H	L	*1	0	1	0	0	1	0	1
Wash Speed Reverse	72	H	L	H	L	L	H	0	0	1	0	0	1	1	0
Distribution Speed	71	H	H	L	L	H	L	*1	0	0	1	0	1	0	1
Medium Extract/Spray Rinse	76	L	L	H	L	H	L	*1	1	1	0	0	1	0	1
Extract Speed 1	75	L	H	L	L	H	L	*1	1	0	1	0	1	0	1
Extract Speed 2	73	H	L	L	L	H	L	*1	0	1	1	0	1	0	1
Extract Speed 3 (default)	77	L	L	L	L	H	L	*1	1	1	1	0	1	0	1
Extract Speed 3 (maximum)	74	L	L	H	L	H	L	*1	1	0	0	0	1	0	1

*If digital in 4 is wired to the Forward Input terminal #02, this input will be a "1" whenever the drive receives a forward command. Disregard otherwise.

Table 11

PowerFlex 40 and 400 Drive Control Logic

PowerFlex 40 Drive Control Logic Chart

Cabinet Freestanding WE-6 control

H – Signal Voltage High (approximately 24V DC) L – Signal Voltage Low (less than 1V DC)								0 = No signal received 1 = Signal received							
		Digital In 3	Digital In 2	Digital In 1	Stop	Rev	Fwd	Digital Input Status – Parameter d014				Control Input Status – Parameter d013			
DC Volt Meter Red Probe Terminal Location		07	06	05	01	03	02								
DC Volt Meter Black Probe Terminal Location		04	04	04	04	04	04								
Action	Frequency Preset Parameter #	Terminal #07 (SW3)	Terminal #06 (SW2)	Terminal #05 (SW1)	Terminal #01 (Stop)	Terminal #03 (STR)	Terminal #02 (STF)	*Digital In 4	Digital In 3 (SW3)	Digital In 2 (SW2)	Digital In 1 (SW1)	DB Trans On	Stop	Rev (STR)	Fwd (STF)
Idle	N/A	H	H	H	L/H	H	H	0	0	0	0	0	0/1	0	0
1/2 Wash Speed Forward	74	L	H	H	L	H	L	*1	1	0	0	0	1	0	1
1/2 Wash Speed Reverse	74	L	H	H	L	L	H	0	1	0	0	0	1	1	0
Wash Speed Forward	72	H	L	H	L	H	L	*1	0	1	0	0	1	0	1
Wash Speed Reverse	72	H	L	H	L	L	H	0	0	1	0	0	1	1	0
Distribution Speed	71	H	H	L	L	H	L	*1	0	0	1	0	1	0	1
Medium Extract	76	L	L	H	L	H	L	*1	1	1	0	0	1	0	1
High 1 Extract	75	L	H	L	L	H	L	*1	1	0	1	0	1	0	1
High 2 Extract	73	H	L	L	L	H	L	*1	0	1	1	0	1	0	1
High 3 Extract	77	L	L	L	L	H	L	*1	1	1	1	0	1	0	1

*If digital in 4 is wired to the Forward Input terminal #02, this input will be a "1" whenever the drive receives a forward command. Disregard otherwise.

Table 12

PowerFlex 400 Drive Control Logic Chart

Cabinet Freestanding (250 Model Only) WE-6 control

H – Signal Voltage High (greater than 10V DC) L – Signal Voltage Low (less than 1V DC)								0 = No signal received 1 = Signal received							
		Digital In 3	Digital In 2	Digital In 1	Fwd	Stop	Rev	Control Input Status – Parameter d302							
DC Volt Meter Red Probe Terminal Location		07	06	05	02	01	03								
DC Volt Meter Black Probe Terminal Location		04	04	04	04	04	04								
Action	Frequency Preset Parameter #	Terminal #07 (SW3)	Terminal #06 (SW2)	Terminal #05 (SW1)	Terminal #02 (STF)	Terminal #01 (Stop)	Terminal #03 (STR)	Not Used	*Digital In 4	Digital In 3 (SW3)	Digital In 2 (SW2)	Digital In 1 (SW1)	Stop	Rev (STR)	Fwd (STF)
Idle	N/A	H	H	H	H	L or H	H	0	0	0	0	0	0/1	0	0
1/2 Wash Speed Forward	355	L	H	H	L	L	H	0	*1	1	0	0	1	0	1
1/2 Wash Speed Reverse	355	L	H	H	H	L	L	0	0	1	0	0	1	1	0
Wash Speed Forward	145	H	L	H	L	L	H	0	*1	0	1	0	1	0	1
Wash Speed Reverse	145	H	L	H	H	L	L	0	0	0	1	0	1	1	0
Distribution Speed	144	H	H	L	L	L	H	0	*1	0	0	1	1	0	1
Medium Extract	357	L	L	H	L	L	H	0	*1	1	1	0	1	0	1
High 1 Extract	356	L	H	L	L	L	H	0	*1	1	0	1	1	0	1
High 2 Extract	146	H	L	L	L	L	H	0	*1	0	1	1	1	0	1
High 3 Extract	358	L	L	L	L	L	H	0	*1	1	1	1	1	0	1

*If digital in 4 is wired to the Forward Input terminal #02, this input will be a "1" whenever the drive receives a forward command. Disregard otherwise.

Table 13

PowerFlex 40 Drive Control Logic Chart

Pocket Hardmount - IPH, IP and CP Models
PS40 control

H – Signal Voltage High (approximately 24V DC) L – Signal Voltage Low (less than 1V DC)				0 = No signal received 1 = Signal received			
	Stop	Rev	Fwd	Control Input Status – Parameter d013			
DC Volt Meter Red Probe Terminal Location	01	03	02				
DC Volt Meter Black Probe Terminal Location	04	04	04				
Action	Terminal #01	Terminal #03	Terminal #02	DB Trans On	Stop	Rev	Fwd
Idle	L	H	H	0	1	0	0
Wash Speed Forward	L	H	L	0	1	0	1
Wash Speed Reverse	L	L	H	0	1	1	0
Distribution Speed	L	H	L	0	1	0	1
Low Spin Speed	L	H	L	0	1	0	1
Medium Spin Speed	L	H	L	0	1	0	1
High Spin Speed	L	H	L	0	1	0	1
SmartSpin	L	L	L	0	1	1	1

NOTE: IPH models use analog signals to control speed - refer to parameter d002 (command freq.) and d020 (analog input %) to verify speed input signal.

Table 14

PowerFlex 40 and 400 Drive Control Logic

Computer Output Boards

Connections identified on these figures set speed and direction of the drive.

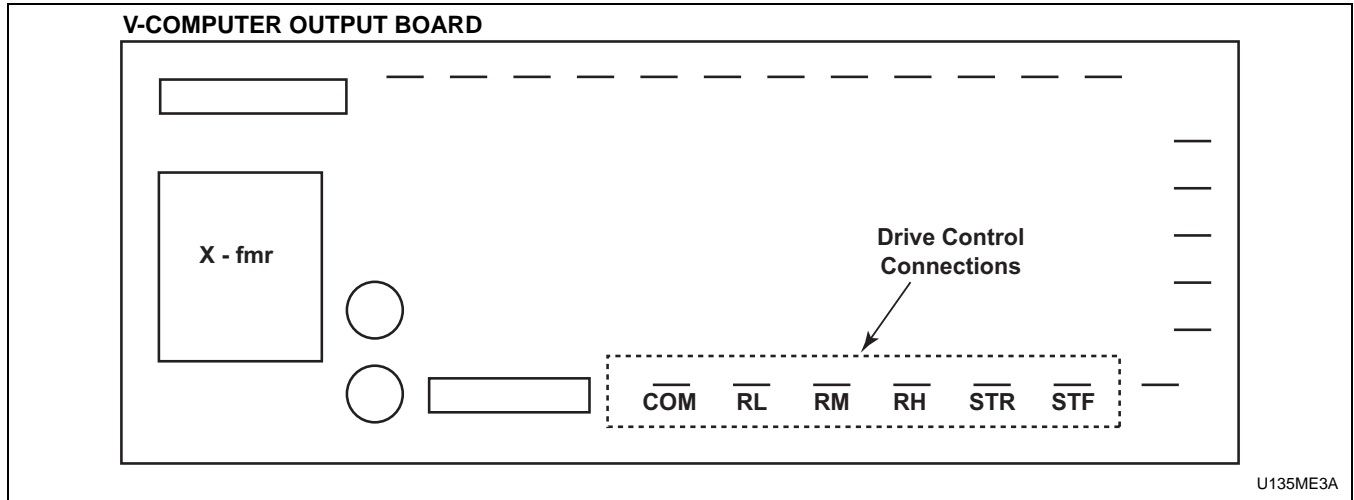

Figure 12

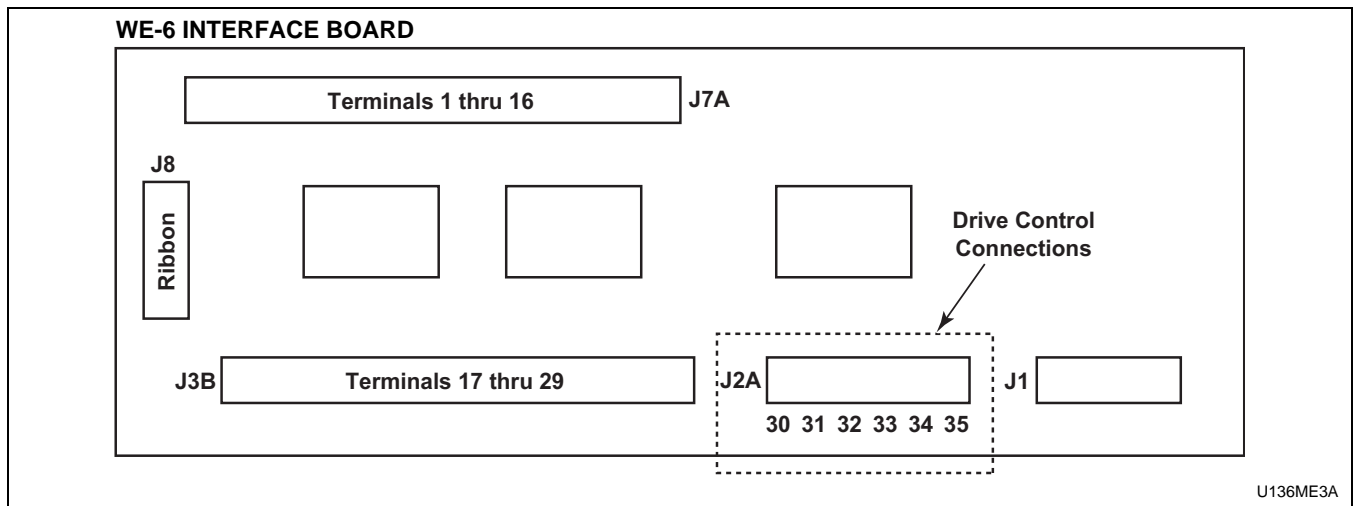

Figure 13

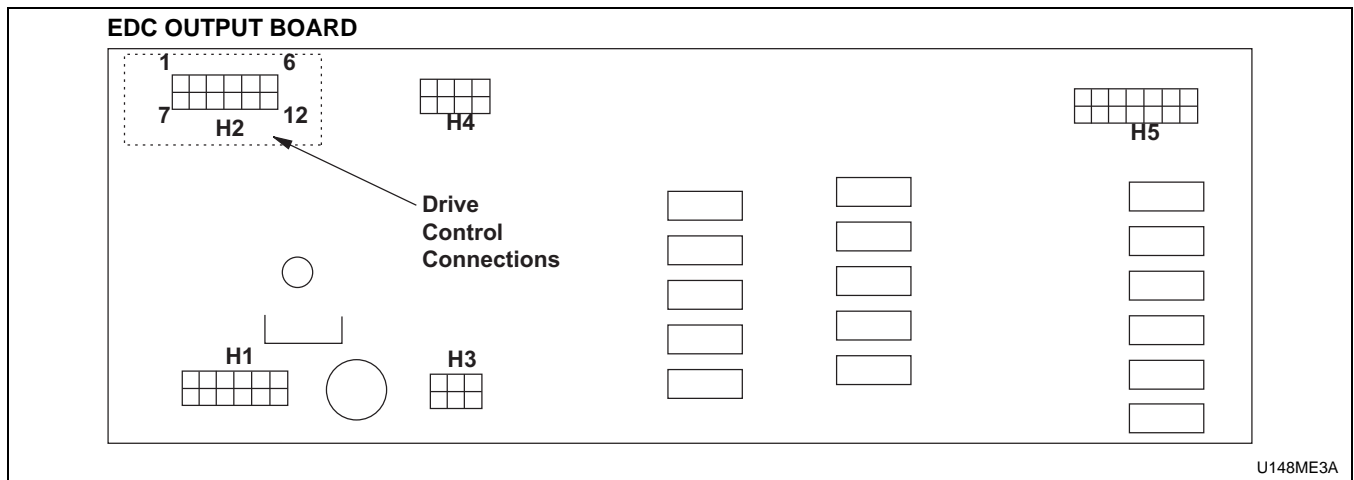

Figure 14

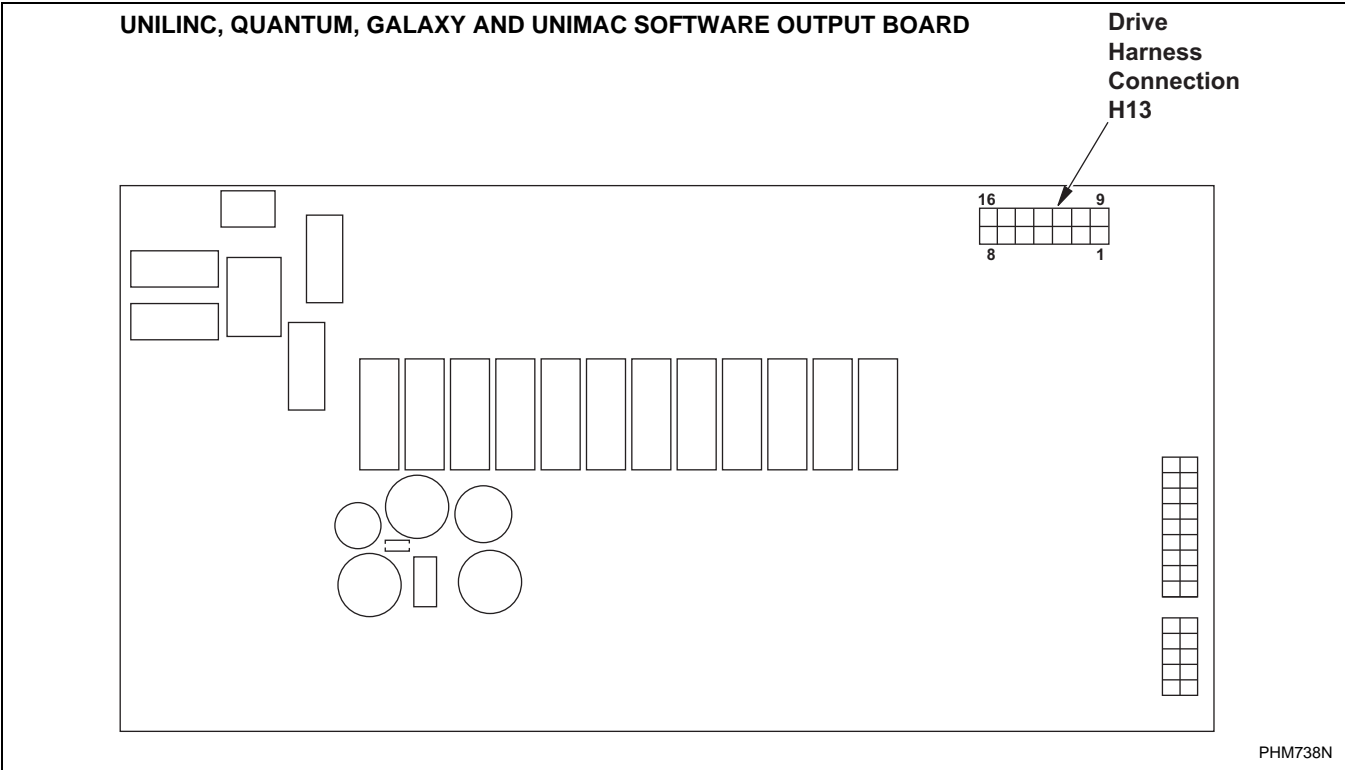

Figure 15

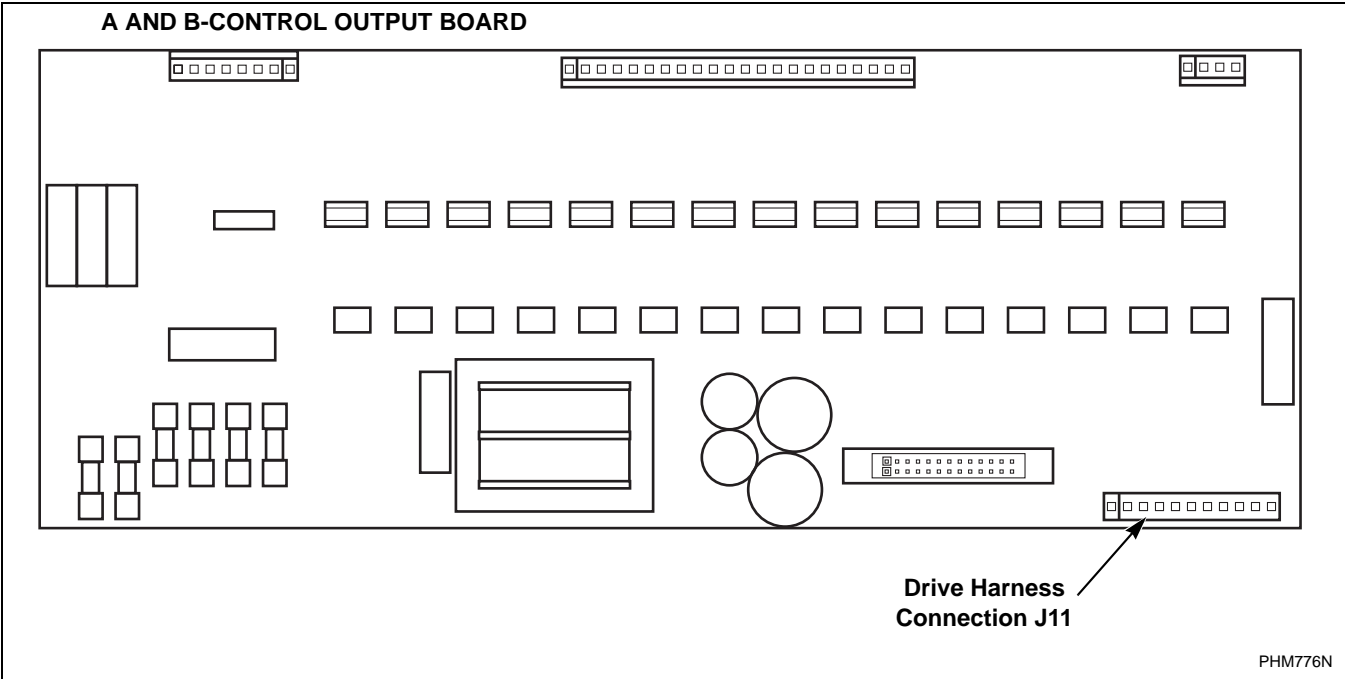

Figure 16

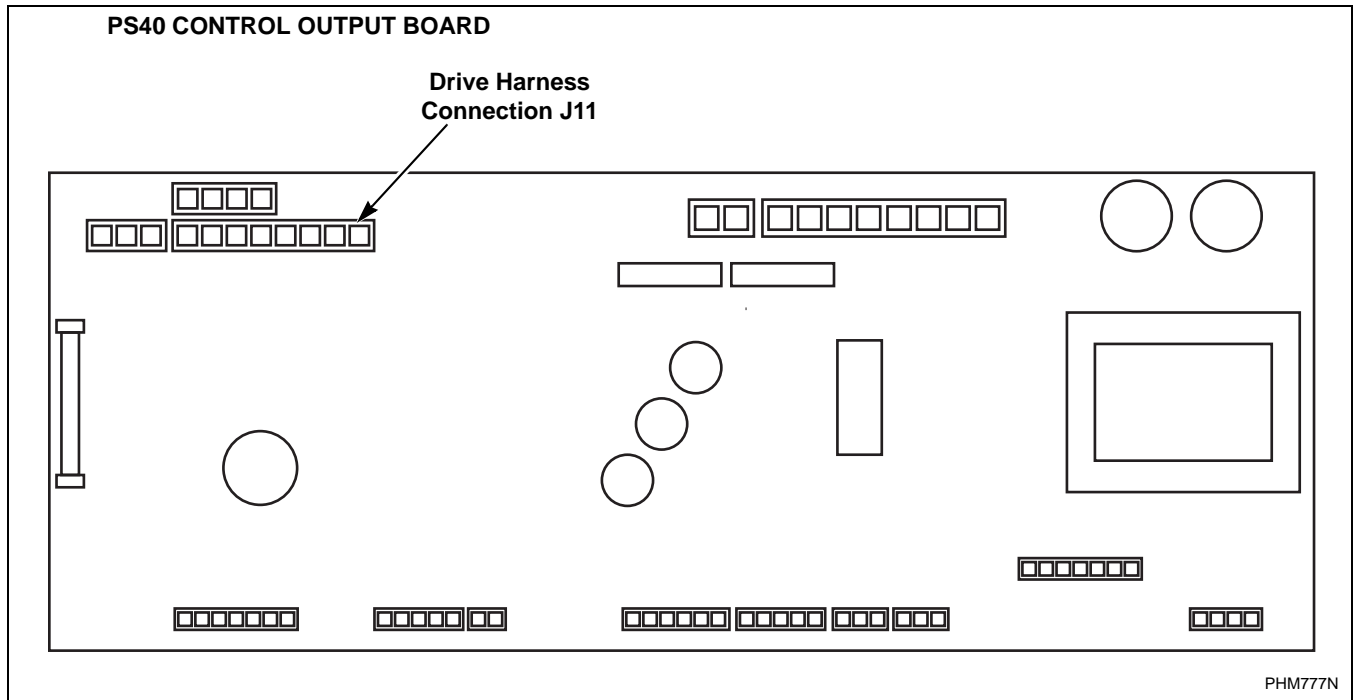

Figure 17

PHM777N

Control Wire

During troubleshooting, if the wire path between the control board and the drive is uncertain, refer to *Table 15* for wire connection numbers.

Control Wire Connection Reference Table.

Output Board Terminal	
V-Control F370314, F8206501 and F370447-6, etc.	
STF	02
STR	03
RH	07
RM	06
RL	05
COM	04
WE-6 Interface Board P/N: F370577, F0370446-xx	
J2A-30	04
J2A-31	06
J2A-32	02
J2A-33	07
J2A-34	05
J2A-35	03
EDC – Output Board P/N: F370433	
H2-7	07
H2-8	06
H2-9	05
H2-10	04
H2-11	03
H2-12	02

Table 15 (continued)

Table 15 (continued)

UniLinc Control– Output Board F8108001	
H13-2	04
H13-3	07
H13-4	06
H13-5	05
H13-6	03
H13-7	02
Output Board Terminal	
A and B-Control P/N: F0370448xx	
J11-1-8/STF	02
J11-1-7/STR	03
J11-1-6/RH	07
J11-1-5/RM	06
J11-1-4/RL	03
J11-1-3/COM	04
PS40 Main Board P/N: C000281	
C12 OV, R-, L-	01, 04, 14
C12 0-10v	13
C12 R+	02
C12 L+	03
Jumper	N/A

Table 15

PowerFlex 40 and 400 Drive Control Logic

PowerFlex Drive Parameters

PowerFlex 40 Parameter Group and Number	PowerFlex 400 Parameter Group and Number	Parameter Description	Function
d001	b001	Output Frequency	Displays instantaneous output frequency (in Hz).
d002	b002	Command Frequency	Displays command output frequency (in Hz).
d003	b003	Output Current	Displays output current (in Amps).
d004	b004	Output Voltage	Displays output voltage (in VAC).
d005	b005	DC Bus Voltage	Displays DC Bus capacitor voltage (in VDC).
d006	b006	Drive Status	Read from left to right, the four bits indicate the drive's condition (decelerating, accelerating, forward and running). "0" = false and "1" = true
d007	d307	Fault 1 Code	Memory location for the most recent fault. Refer to <i>Table 20</i> for a list of most fault codes. Repetitive faults are stored only once.
d008	d308	Fault 2 Code	Memory location for the 2nd most recent fault. Refer to <i>Table 20</i> for a list of most fault codes. Repetitive faults are stored only once.
d009	d309	Fault 3 Code	Memory location for the 3rd most recent fault. Refer to <i>Table 20</i> for a list of most fault codes. Repetitive faults are stored only once.
d010	b008	Process Display	Not applicable to Alliance Laundry Systems' equipment. Refer to the manual supplied with the PowerFlex drive for detailed information.
d012	d301	Control Source	Read from left to right, the digits indicate the active source of the Speed Reference (P038) and Start Source (P036) command.
d013	d302	Control Input Status	Refer to <i>Table 8</i> through <i>Table 14</i> for Control Status Input diagnostics.
d014	d302	Digital Input Status	Refer to <i>Table 8</i> through <i>Table 14</i> for Digital Input Status diagnostics.
d015	d303	Communication Status	Not applicable to Alliance Laundry Systems' equipment. Refer to the manual supplied with the PowerFlex drive for detailed information.

Table 16 (continued)

Table 16 (continued)

PowerFlex 40 Parameter Group and Number	PowerFlex 400 Parameter Group and Number	Parameter Description	Function
d016	d320	Control Firmware Version	Displays the AC drive's firmware version. For PowerFlex 40 drives, this will be 70.xx, 80.xx or 90.xx. For PowerFlex 400 drives, this will be 14.01.
d017	d321	Drive Type	Displays the numeric code of the drive's rating (e.g., 4508 = 5hp 200V drive)
d018	b012	Elapsed Run Time	Displays the accumulated time the drive has output power. The display is in 10-hour increments (e.g., a display of 1 represents a value of 10 hours).
d019	d319	Testpoint Data	Displays a hexadecimal value of the "Testpoint Selection" in parameter A102.
d020	d305	Analog In (0-10V)	Displays the value (in percentage) of the voltage at terminal 13(e.g., 100.0%=10V)
d021	d306	Analog In (4-20mA)	Displays the value (in percentage) of the current at terminal 15 (e.g., 0.0%=4mA; 100.0%=20mA)
d022	b010	Output Power	Displays the kilowatts present at terminals U, V and W (in kW).
d023	d318	Output Power Factor	Displays the angle in electrical degrees between the motor voltage and the motor current.
d024	b014	Drive Temperature	Displays the present operating temperature (in Celsius) of the drive's internal power devices. Refer to Fault 008 in <i>Table 20</i> .
d025	N/A	Counter Status	Not applicable to Alliance Laundry Systems' equipment. Refer to the manual supplied with the PowerFlex drive for detailed information.
d026	N/A	Timer Status	Not applicable to Alliance Laundry Systems' equipment. Refer to the manual supplied with the PowerFlex drive for detailed information.
d028	N/A	Step Logic Status	Not applicable to Alliance Laundry Systems' equipment. Refer to the manual supplied with the PowerFlex drive for detailed information.

Table 16 (continued)

Table 16 (continued)

PowerFlex 40 Parameter Group and Number	PowerFlex 400 Parameter Group and Number	Parameter Description	Function
d029	b013	Torque Current	Displays the present value of the motor's torque current (in Amps).
d030	N/A	OL Level	Displays the real-time motor overload progression (100% = F007 Fault).
P041	P041	Reset to Defaults	NOTE: This will reset the drive's parameters back to the factory-default values, requiring the AC drive to be re-programmed. This will not reset A193. (0 = Not Active; 1 = Reset - Induces Fault F048).
A101	A198	Parameter Lock	Allows parameter modification. 0 = Parameters Unlocked 1= Parameters Locked See also parameters A192 and A193.
A152	N/A	Limited Frequency	Displays the maximum allowable frequency (in Hz) based on DC Bus voltage. The drive output frequency may be limited due to low input voltage conditions to alleviate potential motor stalling.
A164	R261	Balance State	Displays the balance detection algorithm progression (See A187 and A188). (0 = Algorithm not active; 1 = programmed pause time; 2 = programmed sample time; 3 = programmed filter time; 4 = result obtained)
A187	N/A	SmartSpin Frequency	Displays the commanded SmartSpin frequency (in Hz) as determined from Balance Result A188.
A188	R285	Balance Result	Displays the numeric value indicating severity of load imbalance. A balance result value will be displayed only when A164 = 4, otherwise the display will be 0.
A192	N/A	Parameter CRC-16	Displays the numeric code culminating from the value of all of the parameters. This is intended as a quick reference and is used to validate the parameter settings for a specific application.

Table 16 (continued)

Table 16 (continued)

PowerFlex 40 Parameter Group and Number	PowerFlex 400 Parameter Group and Number	Parameter Description	Function
A193	N/A	Counter	This counter will increment each time parameter A192 changes. This is intended as a quick reference to show if any parameter has been changed after factory programming, even if a parameter was changed and then restored to the ALS-specified value.

NOTE: The above parameters and descriptions are based on firmware version 90.06 and may differ or be missing from earlier versions of PowerFlex drive firmware. Refer to parameter d016 for the firmware's version.

NOTE: All PowerFlex drives used in Alliance Laundry Systems' equipment are custom-developed with unique features and parameters. Parameter information provided within the Allen-Bradley PowerFlex series AC drive manual will differ and may not be relevant.

Table 16

AC Drive Diagnostics/Parameter Viewing

PowerFlex Integrated Keypad

The PowerFlex series AC drives have an integral keypad that can be used for viewing and editing parameter values. No external parameter unit is required, however an external hand-held parameter unit is available (22-HIM-A3) that can provide a user-friendly method of viewing and editing parameter values in hard-to-access locations.

Integral Keypad

The integral keypad displays several main menu group selections such as “d”, “P”, and “A” as described below. Within the Display Group is a fault storage buffer that stores the last three AC drive fault codes. Refer to the Fault Display and Troubleshooting Information Section for more information.

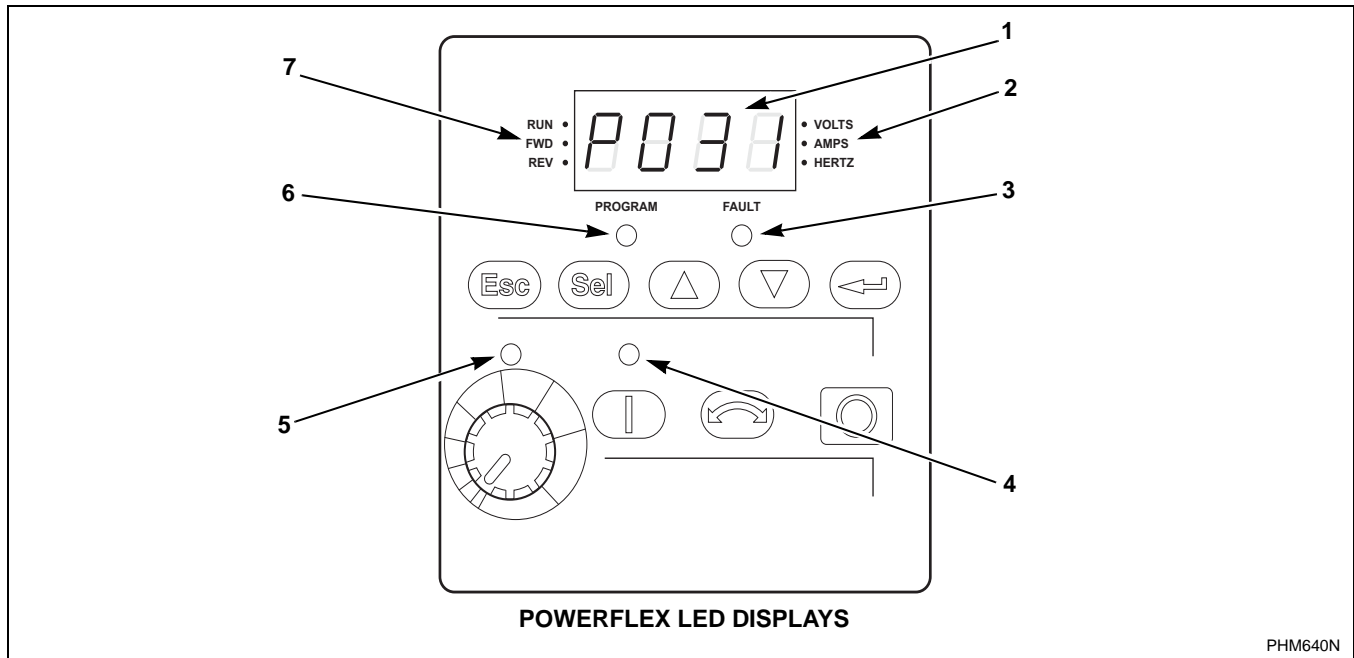

Number	LED	LED State	Description
1	Display	Steady Red	Indicates parameter number, parameter value, or fault code.
		Flashing Red	Single digit flashing indicates that digit can be edited. All digits flashing indicates a fault condition. See table below.
2	Displayed Units	Steady Red	Indicates the units of the parameter value being displayed.
3	Fault Status	Flashing Red	Indicates drive is faulted.
4	Start Key Status	Steady Green	Indicates Start key on Integral Keypad is active. The Reverse key is also active unless disabled by A095 (Reverse Disable).
5	Pot Status	Steady Green	Indicates potentiometer on Integral Keypad is active.
6	Program Status	Steady Red	Indicates parameter value can be changed.
7	Run/Direction Status	Steady Red	Indicates drive is running and commanded motor direction.
		Flashing Red	Drive has been commanded to change direction. Indicates actual motor direction while decelerating to zero.

Figure 18

PowerFlex 40 Alphanumeric LED Display Groups			
Menu	Description	Menu	Description
d	Display Group (View Only). Consists of commonly viewed drive operating conditions.	A	Advanced Program Group. Consists of remaining programmable functions.
P	Basic Program Group. Consists of most commonly used programmable functions.	F	Fault Designator. Consists of list of codes for specific fault conditions. Displayed only when fault is present.

Table 17

PowerFlex 400 Alphanumeric LED Display Groups			
Menu	Description	Menu	Description
b	Basic Display	A	Advanced Program
C	Communications	T	Terminal Block
d	Advanced Display	R	Aux Relay Card
P	Basic Program		

Table 18

PowerFlex 40 and 400 Drive Control Logic

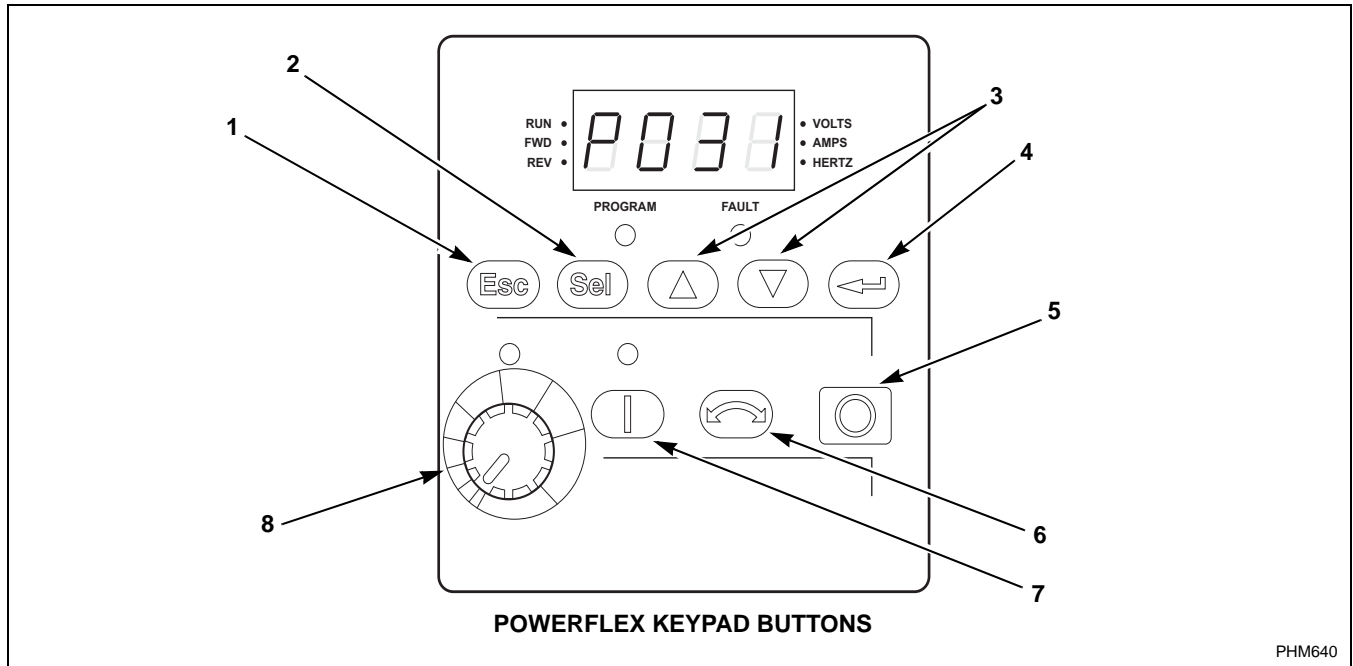

PHM640

Number	Name	Description
1	Escape	Back one step in programming menu. Cancel a change to a parameter value and exit Program Mode.
2	Select	Advance one step in programming menu. Select a digit when viewing parameter value.
3	Up Arrow Down Arrow	Scroll through groups and parameters. Increase/decrease the value of a flashing digit.
4	Enter	Advance one step in programming menu. Save a change to a parameter value.
5	Stop	Used to stop the drive or clear a fault. This key is always active. Controlled by parameter <u>P037</u> (Stop Mode).
6	Reverse	Used to reverse direction of the drive. Default is active. Controlled by parameters <u>P036</u> (Start Source) and <u>A095</u> (Reverse Disable).
7	Start	Used to start the drive. Default is active. Controlled by parameters <u>P036</u> (Start Source).
8	Potentiometer	Used to control speed of drive. Default is active. Controlled by parameter <u>P038</u> (Speed Reference).

Figure 19

Viewing and Editing Parameters

The last user-selected Display Group parameter is saved when power is removed and is displayed by default when power is reapplied.

The following is an example of basic integral keypad and display functions. This example provides basic navigation instructions and illustrates how to program the first Program Group parameter.













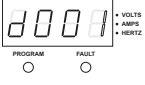



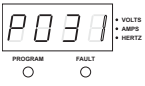



Step	Description	Key(s)	Example Displays
1	When power is applied, the last user-selected Display Group parameter number is briefly displayed with flashing characters. The display then defaults to that parameter's current value. (Example shows the value of d001 [Output Freq.] with the drive stopped.)		
2	Press Esc or Sel until the Group Menu letter begins to flash.	 or 	
3	Press the Up Arrow or Down Arrow to scroll through the group menu (d, P and A).	 or 	
4	Press Enter or Sel to enter a group. The right digit of the last viewed parameter in that group will flash.	 or 	
5	Press the Up Arrow or Down Arrow to scroll through the parameters that are in the group.	 or 	
6	Press Enter or Sel to view the value of a parameter. If you do not want to edit the value, press Esc to return to the parameter number.	 or 	
7	Press Enter or Sel to enter program mode to edit the parameter value. The right digit will flash and the Program LED will illuminate if the parameter can be edited.	 or 	
8	Press the Up Arrow or Down Arrow to change the parameter value. If desired, press Sel to move from digit to digit or bit to bit. The digit or bit that you can change will flash.	 or 	
9	Press Esc to cancel a change. The digit will stop flashing, the previous value is restored and the Program LED will turn off. OR Press Enter to save a change. The digit will stop flashing and the Program LED will turn off.	 	
10	Press Esc to return to the parameter list. Continue to press Esc to back out of the programming menu. If pressing Esc does not change the display, then d001 (Output Frequency) is displayed. Press Enter or Sel to enter the group menu.		

Table 19

Fault Display and Troubleshooting Information

This section provides information to guide users in understanding drive fault conditions and general troubleshooting procedures for Allen-Bradley drives. Included is a listing and description of the various drive faults with possible solutions, when applicable. For any questions regarding fault conditions, consult with the factory.

Each drive is equipped with a fault indicator light which illuminates when a fault condition exists.

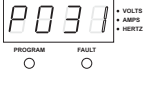
Clearing Faults

When a fault occurs, the cause must be corrected before the fault can be cleared. Resetting a fault will not correct the cause of the fault condition. After corrective action has been taken, simply cycling power to the drive will clear the fault.

When a fault occurs, the fault indicator light on the integral keypad will illuminate. The fault code will immediately be indicated on the display, such as "F005". The last three fault codes are also stored in the fault memory location as indicated in *Table 12*. Repetitive faults of the same fault code will only be recorded once.

Refer to Viewing and Editing Parameters section of AC Drive Diagnostics/Parameter Viewing chapter for details on how to access parameter values.

Once a fault code is identified, refer to the AC drive manual for the most up-to-date explanation of codes. *Table 20* also contains an abbreviated list of typical fault codes.

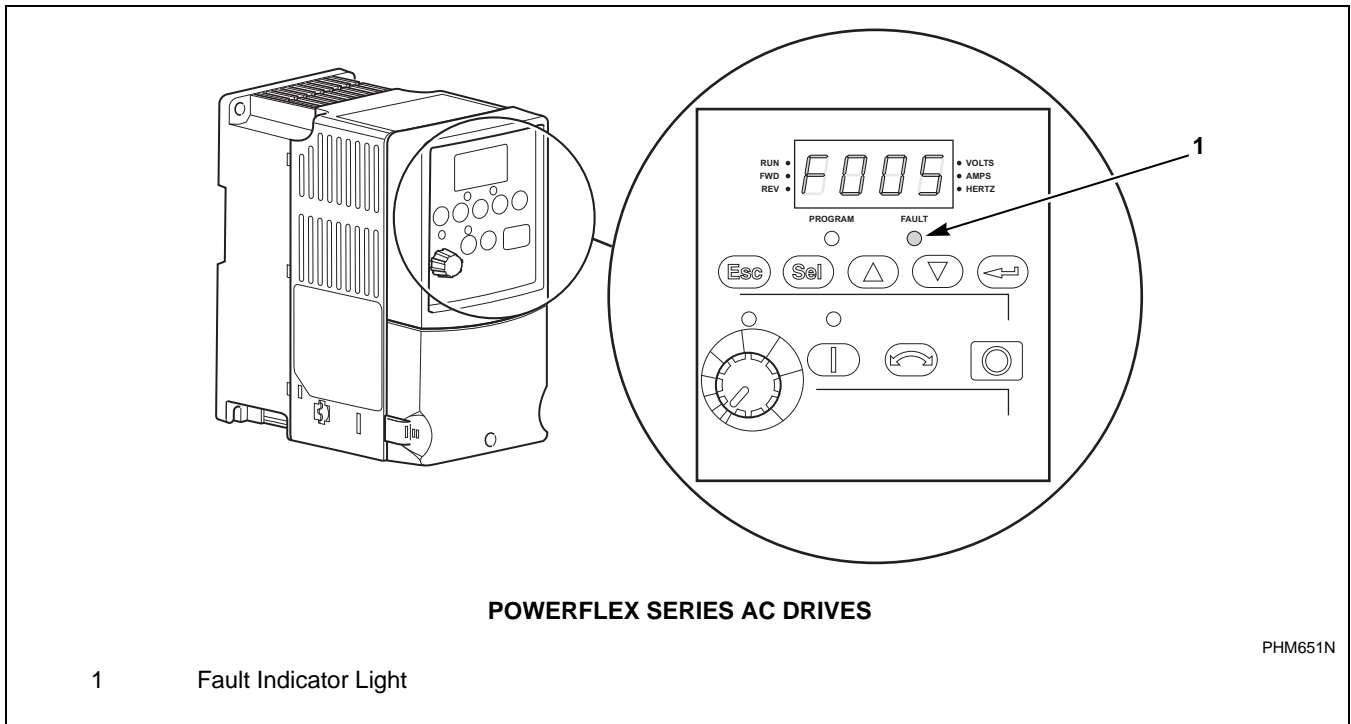

Figure 20

Allen-Bradley Drive Fault Codes

Allen-Bradley Drive Fault Codes			
	Fault	Description	Corrective Action/ Remarks
003	Power Loss Fault	DC Bus voltage remains below 85% nominal for longer than .5 seconds.	Monitor incoming AC line for low voltage or line power interruption.
004	Under Voltage Fault	DC Bus voltage fell below minimum.	Monitor AC incoming AC line for low voltage or line power interruption.
005	Over Voltage Fault	DC Bus maximum voltage exceeded.	Monitor the AC line for high line voltage or transient conditions. High voltage can result from motor regeneration. Buck transformer may be required.
006	Motor Stall	Motor has stalled. Motor load is excessive.	Check motor wiring and connection terminals. Check wash basket freedom of movement and excess belt tension.
007	Motor Overload Fault	Internal electronic overload trip. Excessive motor load exists.	Check motor wiring and connection terminals. Check wash basket freedom of movement and excess belt tension.
008	Over Temperature Fault	Excessive heat detected by heatsink transducer.	Clear blocked or dirty heatsink fins. Check ambient temperature. Check for blocked or nonoperating fan.
012	Overcurrent Fault	Overcurrent detected in instantaneous hardware trip circuit.	Check short circuit at the controller output or excessive load conditions at motor.
024	Unable to Decelerate	DC Bus regulation prevents machine from decelerating typically due to high input voltage, motor regeneration or unstable motor operation.	Verify DC Bus (d005) is less than 340V for 200-240V applications or 680V for 380-480V applications. Check for an imbalanced wash load. Check for proper speed increment through all extract speeds.
033	Max Retries Fault	Controller failed to reset fault within the number of retries.	Fault exists that must be corrected before further operation. Check "Fault Buffer 1" on 1305 and 1336 for specific fault that triggered max retries fault.
038	Phase U Fault	Phase-to-ground fault detected between controller and motor in Phase U.	Check wiring between the drive and motor. Check for grounded phase.

Table 20 (continued)

Table 20 (continued)

Allen-Bradley Drive Fault Codes (continued)			
	Fault	Description	Corrective Action Remarks
039	Phase V Fault	Phase to ground fault detected between controller and motor in Phase V.	Check wiring between the drive and motor. Check for grounded phase.
040	Phase W Fault	Phase to ground fault detected between controller and motor in Phase W.	Check wiring between the drive and motor. Check for grounded phase.
041	UV Short Fault	Excessive current has been detected between two controller output terminals.	Check motor and external wiring to the controller output terminals for shorted condition.
042	UW Short Fault	Excessive current has been detected between two controller output terminals.	Check motor and external wiring to the controller output terminals for shorted condition.
043	VW Short Fault	Excessive current has been detected between two controller output terminals.	Check motor and external wiring to the controller output terminals for shorted condition.
048	Reset to Default Values	Parameters were reset to the factory default values.	Verify or re-load the Alliance Laundry Systems specified parameters.
063	Software Over-current	Instantaneous (100 ms) trip based on ALS-specified maximum current setting.	Check for a locked motor or basket. Check for correct motor, basket and pulley combination. Check for an intermittent signal at the drive's input terminals.
064	Drive Overload	The drive's current rating has been exceeded by 150% for 1 minute or by 200% for 3 seconds.	Verify that the parameters are compatible with the motor and pulley combination. Check for a restriction in the basket's rotation. Check for a poor or improper connection in the motor circuit.
100	Parameter Checksum	There is an internal checksum discrepancy.	Reset the drive's parameters to the default factory settings and re-load the ALS-specified parameters.

Table 20

Troubleshooting Suggestions

Important Considerations

- Drive cooling is extremely important to the overall service life of the product. Extreme care should be used to keep cooling air paths clean. Drive cabinet enclosures have been designed to optimize cooling. Keep cabinet doors closed and panels installed to maintain proper operation.
- Resetting a fault will not correct the cause of the fault condition. Corrective action must be taken prior to resetting a fault. Many drive error codes are reset by cycling power to the drive. The fault may not reappear until drive operation is initiated.
- Drive to motor wiring is critical to proper drive operation. Loose or bad connections can generate heat and increase current output from drive. These problems can manifest themselves in operation by many fault codes indicating overcurrent condition and maximum retries fault.

Problem/Corrective Action

Problem:

Wash basket does not rotate.

Corrective Action

1. Ensure computer control display on washer is showing proper operation.
2. Check power circuit, supply voltage, fuses and disconnects.
3. Verify drive to motor wires are damage free, properly connected and torqued to specifications.
4. Check belt tension and condition.
5. Verify no mechanical problems exist (i.e., binding, motion restriction).
6. Check control input signals. Refer to applicable table of inputs.

Problem:

Drive started but wash basket is not rotating.

Corrective Action

1. Verify drive to motor wires are damage-free, properly connected and torqued to specifications.
2. Verify no mechanical problems exist (i.e., binding, motion restriction).
3. Check control input signals. Refer to applicable table of inputs.

Problem:

Wash basket not accelerating properly.

Corrective Action

1. Verify drive to motor wires are damage-free, properly connected and torqued to specifications.
2. Verify speed selection control wire connections. Refer to applicable table.

Allen-Bradley 160-Series AC Drives

Installation/Wiring

	CAUTION
<p>An incorrectly installed system can result in component damage or reduction in product life. The most common causes are:</p> <ol style="list-style-type: none"> 1. Wiring AC line to drive output or control terminals. 2. EXTERNAL voltage application to control terminals. 3. Incorrect or inadequate AC supply. <p>Contact factory for assistance with application or wiring.</p>	
W660	

Input Power Conditioning

The drive is suitable for direct connection to input power within the rated voltage of the drive. Listed in *Table 21* are certain input power conditions which may cause component damage or reduction in product life. If any of the conditions exist, as described in *Table 21*, install one of the devices listed under the heading *Corrective Action* on the line side of the drive.

IMPORTANT: Only one device per branch circuit is required. It should be mounted closest to the branch and sized to handle the total current of the branch circuit.

Input Power Condition	Corrective Action
Low Line impedance (less than 1% line reactance)	<ul style="list-style-type: none"> • Install Line Reactor • or Isolation Transformer • or Bus Inductor – 5.5 & 11kW (7.5 & 15 HP) drives only
Greater than 120 kVA supply transformer	
Line has power factor correction capacitors	<ul style="list-style-type: none"> • Install Line Reactor • or Isolation Transformer
Line has frequent power interruptions	
Line has intermittent noise spikes in excess of 6000V (lightning)	
Phase to ground voltage exceeds 125% of normal line to line voltage	<ul style="list-style-type: none"> • Remove MOV jumper to ground. • or Install Isolation Transformer with grounded secondary if necessary
Ungrounded distribution system	
240V open delta configuration (stinger leg) ⁽¹⁾	<ul style="list-style-type: none"> • Install Line Reactor
<p>⁽¹⁾ For drives applied on an open delta with a middle phase grounded neutral system, the phase opposite the phase that is tapped in the middle to the neutral or earth is referred to as the “stinger leg,” “high leg,” “red leg,” etc. This leg should be identified throughout the system with red or orange tape on the wire at each connection point. The stinger leg should be connected to the center Phase B on the reactor.</p>	

Table 21

Electrical Interference

EMI

Careful attention must be given to the arrangement of power and ground connections to the drive to avoid interference with nearby sensitive equipment. Be sure to replace all ground connections to their appropriate locations.

RFI

Drives can be installed with an RFI filter, which controls high-frequency conducted emissions into the main supply lines.

Where it is essential that very low emission levels must be achieved or if conformity with standards is required, the optional RFI filter may be present.

Figure 21 displays an electrical schematic for various RFI configurations. shows associated RFI filter part numbers.



CAUTION

ELECTRIC SHOCK HAZARD! Service and maintenance to be performed only by an authorized technician. Disconnect power before opening any access panels.

W661

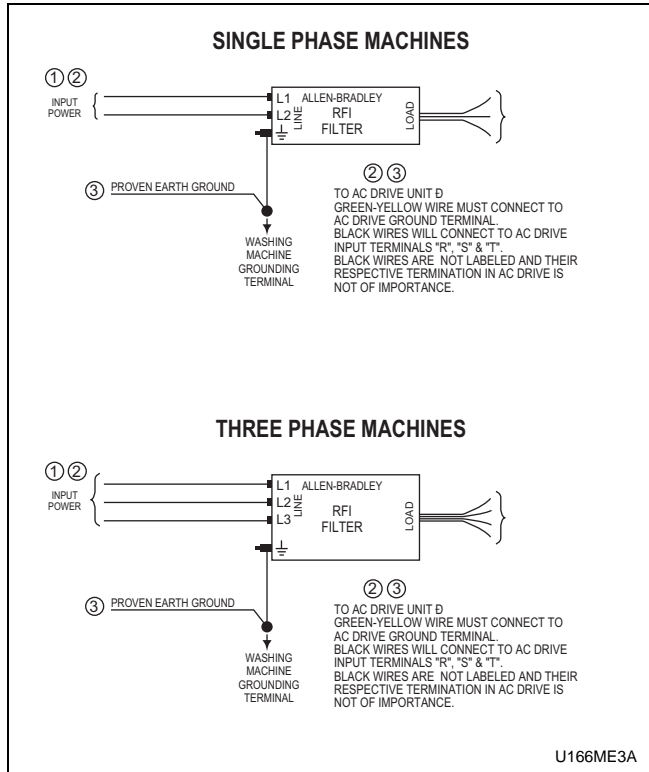

Figure 21

Allen-Bradley 160-Series AC Drives

RFI Filter Part Number Information			
Drive P/N	Drive Catalog	Machine Voltage	Filter P/N
Series A or Series B*			
370839	160-AA04 Series A or B	200-240V/1 Phase	330277
370839	160-AA04 Series A or B	200-240V/3 Phase	330276
370840	160-BA03 Series A or B	380-480V/3 Phase	330275
370841	160-AA08 Series A or B	200-240-V/1 Phase	330277
370841	160-AA08 Series A or B	200-240V/3 Phase	330276
370842	160-BA04 Series A or B	380-480V/3 Phase	330275
Series C			
370855	160-AA04 Series C	200-240V/1 Phase	330282
370855	160-AA04 Series C	200-240V/3 Phase	330281
370856	160-BA03 Series C	380-480V/3 Phase	330281
370857	160-AA08 Series C	200-240V/1 Phase	330285
370857	160-AA08 Series C	200-240V/3 Phase	330280
370858	160-BA04 Series C	380-480V/3 Phase	330281
370843	160-AA12 Series C	200-240V/1 Phase	Not Available
370843	160-AA12 Series C	200-240V/3 Phase	330280
370844	160-BA06 Series C	380-480V/3 Phase	330280
370853	160-AA18 Series C	200-240V/1 Phase	Not Available
370853	160-AA18 Series C	200-240V/3 Phase	330284
370854	160-BA10 Series C	380-480V/3 Phase	330283

*Applies to *C 18–50 lb. models or *F 18–25 lb. models built before July 1999 with Series A or B drives. If Series A or B drive was replaced with a Series C drive, refer to the Series C section.

Table 22

Terminal Block Access

	WARNING
<p>To reduce risk of electric shock, severe injury or death, allow machine power to remain off for three minutes minimum prior to working in and around AC drive. Proceed with caution.</p>	
<p>W662</p>	

The following information illustrates the terminal block designations for each of the drive models.

The power and control terminal blocks are located externally. Refer to *Figure 22*.

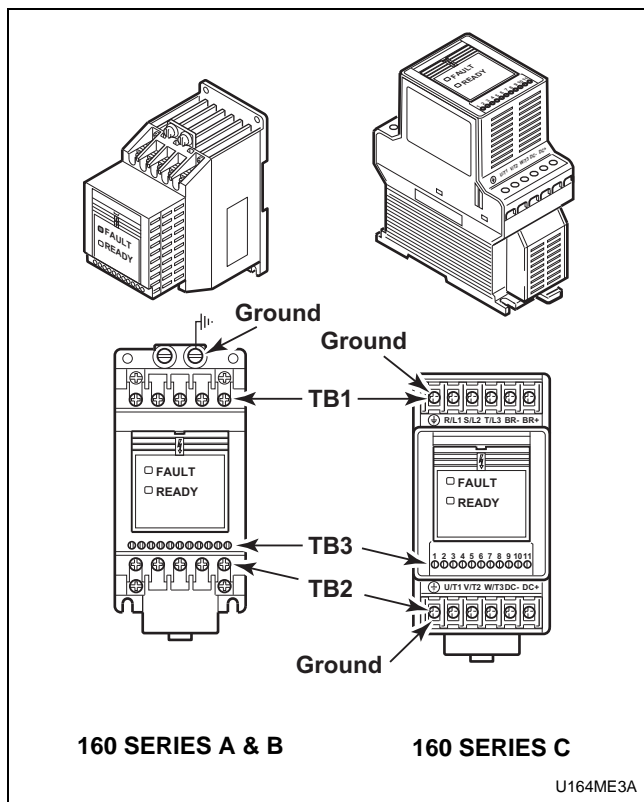

Figure 22

Power Terminal Block Description

Input and output power connections are performed through two separate terminal blocks. Refer to Figure 23.

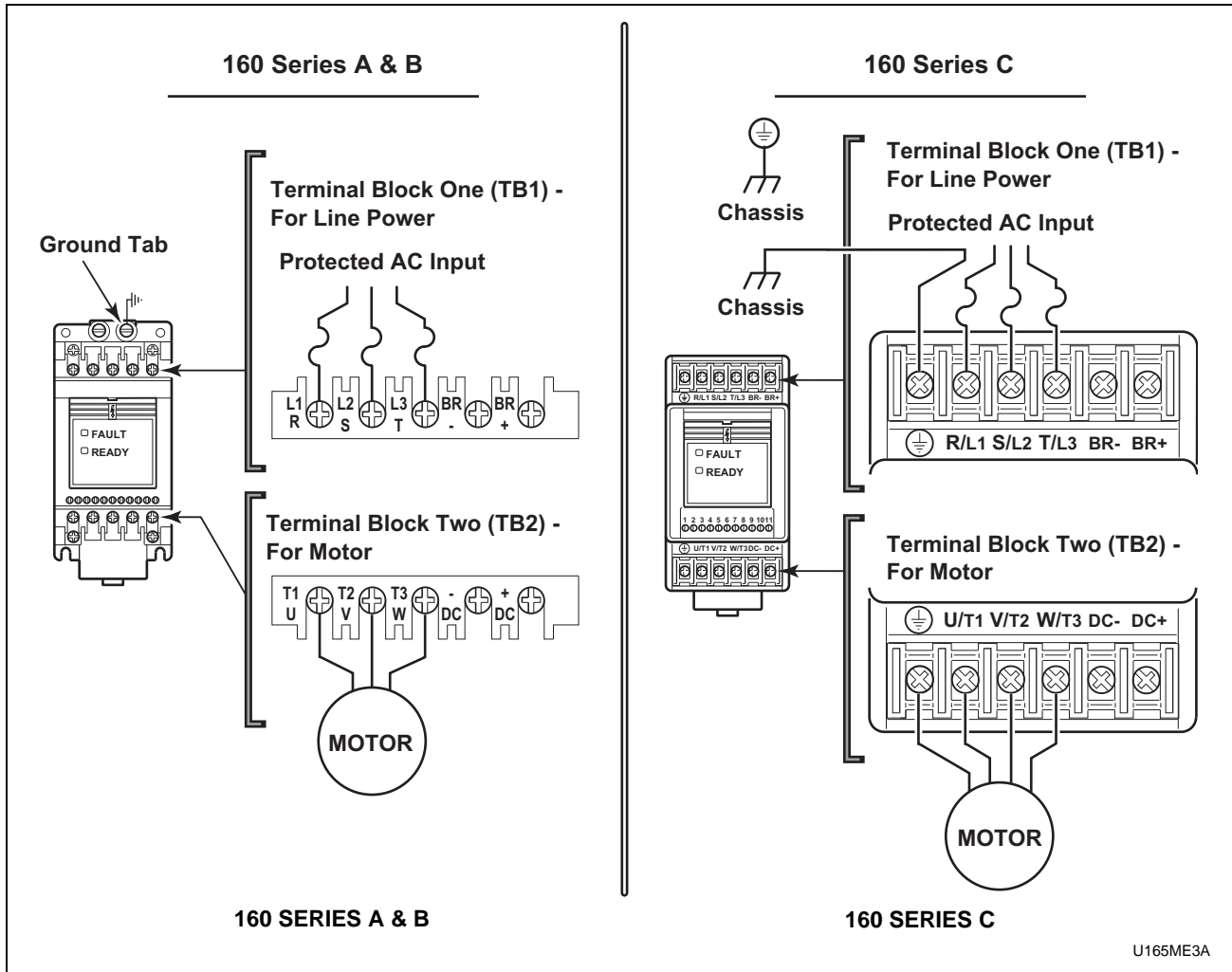

Figure 23

A-B 160 Power Block Terminal (TB1, TB2, GRD)

Terminals	Description
GRD	Earth Ground
R, S, T (L1, L2, L3)	AC Input Line Terminals
BR+, BR-	Dynamic Brake Resistor Option – Refer to instructions with option
DC+, DC-	Capacitor Module Option
U, V, W (T1, T2, T3)	Motor Connection

Table 23

A-B 160 Torque Specifications

Terminal	Screw Size	Max/Min Wire Size mm ² (AWG)	Max/Min Torque N-m (lb-in)
TB1 & TB2 Series A & B	M4	4/0.75 (12/18)	1.81/1.35 (16/12)
4.0 kW (7.5 HPDP) Series C	M4	5.26 – 3.31 (10 – 12)	1.35 – 0.90 (12 – 8)
All Other Ratings Series C	M4	3.31 – 0.82 (12 – 18)	1.35 – 0.90 (12 – 8)

Table 24

Control Terminal Blocks Description and Control Logic

Control Terminal Block (TB3) Function

	WARNING
<p>To reduce risk of electric shock, severe injury or death, allow machine power to remain off for three minutes minimum prior to working in and around AC drive. Proceed with caution.</p>	
W662	

	CAUTION
<p>The controller is supplied with an internal power supply. Dry contacts or open collectors are required for discrete control inputs. If an external voltage is applied, component failure could occur.</p>	
W663	

Input Mode Parameter

The control terminal functions are determined in part by the Input Mode parameter #46. Changing this parameter affects the function of some terminals. All machines equipped with A-B 160 drives use Input Mode "1".

NOTE: If Input Mode is changed, power must be cycled to the drive for the change to take effect.

Speed Selection

Motor speeds on digitally-controlled AC drives are controlled by solid state or relay switch closure inputs to SW1, SW2, and SW3 in conjunction with STR and STF (direction) inputs. Refer to *Figure 24* and *Table 25*.

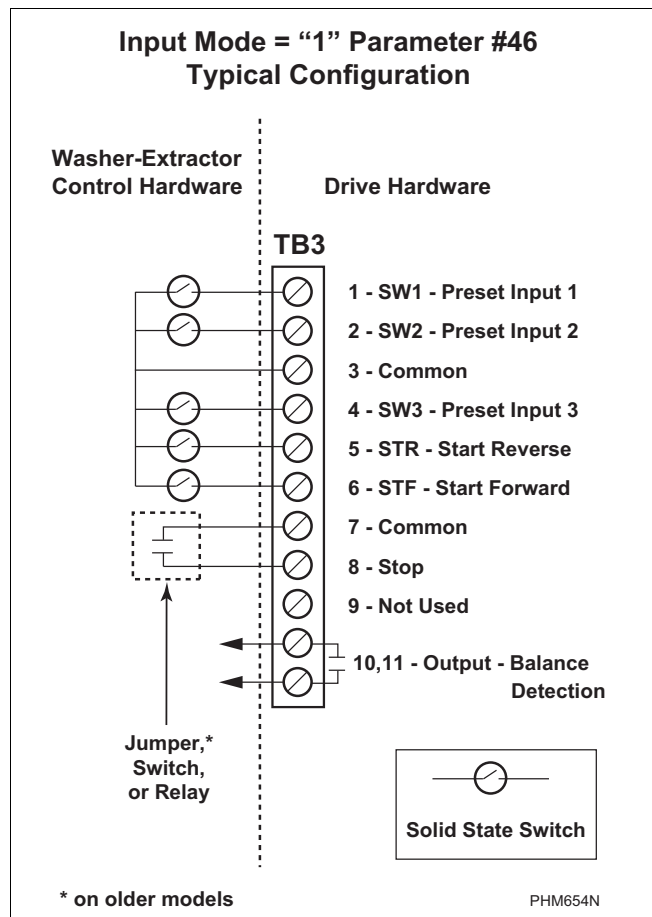

Figure 24

Control Terminal Block Designations

Terminal Number	Signal	Machine Use
1, 3	SW1	Preset Speed Input #1
2, 3	SW2	Preset Speed Input #2
4, 3	SW3	Preset Speed Input #3
5, 3	STR	Reverse Motion
6, 7	STF	Forward Motion
8, 7	Stop	Safety Device
9, 10	Programmable Output 1 Normally Closed	Not Used
10, 11	Programmable Output 1 Normally Open	Balance Output

Table 25

Allen-Bradley 160-Series AC Drives

160 Series Drive Control Logic Chart

The following truth table (Tables 26 - 30) designates the preset speed selection based on the inputs to the control terminals. A disconnected control terminal will seek the high signal voltage condition (greater than 10V DC).

To activate a control input (i.e., SW1, SW2, etc.), the terminal is connected to a common terminal (TB3-3 or TB3-7) to lower the signal voltage to a low condition (less than 1 Volt DC).

Pocket Hardmount V Control and A control

H – Control Voltage High (greater than 10V DC) L – Control Voltage Low (less than 1V DC)								0 = No signal received 1 = Signal received							
		SW3	SW2	SW1	STF	Stop	STR	Preset Status – Parameter 15				Input Status – Parameter 12			
DC Volt Meter Red Probe Terminal Location		4	2	1	6	8	5								
DC Volt Meter Black Probe Terminal Location		3	3	3	3	3	3								
Action	Frequency Preset Parameter #	Terminal #4 (SW3)	Terminal #2 (SW2)	Terminal #1 (SW1)	Terminal #6 (STF)	Terminal #8 (Stop)	Terminal #5 (STR)	Not Used	SW3	SW2	SW1	Not Used	STF	Stop	STR
Idle	N/A	H	H	H	H	L/H	H	0	0	0	0	0	0	0/1	0
1/2 Wash Speed Forward	62	H	H	L	L	L	H	0	0	0	1	0	1	1	0
1/2 Wash Speed Reverse	62	H	H	L	H	L	L	0	0	0	1	0	0	1	1
Wash Speed Forward	63	H	L	H	L	L	H	0	0	1	0	0	1	1	0
Wash Speed Reverse	63	H	L	H	H	L	L	0	0	1	0	0	0	1	1
Distribution Speed	65	L	H	H	L	L	H	0	1	0	0	0	1	1	0
Spin 1	64	H	L	L	L	L	H	0	0	1	1	0	1	1	0
Spin 2	67	L	L	H	L	L	H	0	1	1	0	0	1	1	0
Spin 3	66	L	H	L	L	L	H	0	1	0	1	0	1	1	0

Pocket Hardmount WE-6 Control - Design 5 and Earlier

H – Control Voltage High (greater than 10V DC) L – Control Voltage Low (less than 1V DC)								0 = No signal received 1 = Signal received							
		SW3	SW2	SW1	STF	Stop	STR	Preset Status – Parameter 15				Input Status – Parameter 12			
DC Volt Meter Red Probe Terminal Location		4	2	1	6	8	5								
DC Volt Meter Black Probe Terminal Location		3	3	3	3	3	3								
Action	Frequency Preset Parameter #	Terminal #4 (SW3)	Terminal #2 (SW2)	Terminal #1 (SW1)	Terminal #6 (STF)	Terminal #8 (Stop)	Terminal #5 (STR)	Not Used	SW3	SW2	SW1	Not Used	STF	Stop	STR
Idle	N/A	H	H	H	H	L/H	H	0	0	0	0	0	0	0/1	0
1/2 Wash Speed Forward	65	L	H	H	L	L	H	0	1	0	0	0	1	1	0
1/2 Wash Speed Reverse	65	L	H	H	H	L	L	0	1	0	0	0	0	1	1
Wash Speed Forward	63	H	L	H	L	L	H	0	0	1	0	0	1	1	0
Wash Speed Reverse	63	H	L	H	H	L	L	0	0	1	0	0	0	1	1
Distribution Speed	62	H	H	L	L	L	H	0	0	0	1	0	1	1	0
Medium Extract/Spray Rinse	67	L	L	H	L	L	H	0	1	1	0	0	1	1	0
High 1 Extract	66	L	H	L	L	L	H	0	1	0	1	0	1	1	0
High 2 Extract	64	H	L	L	L	L	H	0	0	1	1	0	1	1	0
High 3 Extract	68	L	L	L	L	L	H	0	1	1	1	0	1	1	0

Table 26

**Pocket Hardmount
WE-6 Control Designs 6, 7 and 8**

H – Control Voltage High (greater than 10V DC) L – Control Voltage Low (less than 1V DC)								0 = No signal received 1 = Signal received							
		SW3	SW2	SW1	STF	Stop	STR	Preset Status – Parameter 15				Input Status – Parameter 12			
DC Volt Meter Red Probe Terminal Location		4	2	1	6	8	5								
DC Volt Meter Black Probe Terminal Location		3	3	3	3	3	3								
Action	Frequency Preset Parameter #	Terminal #4 (SW3)	Terminal #2 (SW2)	Terminal #1 (SW1)	Terminal #6 (STF)	Terminal #8 (Stop)	Terminal #5 (STR)	Not Used	SW3	SW2	SW1	Not Used	STF	Stop	STR
Idle	N/A	H	H	H	H	L/H	H	0	0	0	0	0	0	0/1	0
1/2 Wash Speed Forward	61	H	H	H	L	L	H	0	0	0	0	0	1	1	0
1/2 Wash Speed Reverse	61	H	H	H	H	L	L	0	0	0	0	0	0	1	1
Wash Speed Forward	63	H	L	H	L	L	H	0	0	1	1	0	1	1	0
Wash Speed Reverse	63	H	L	H	H	L	L	0	0	1	0	0	0	1	1
Distribution Speed	62	H	H	L	L	L	H	0	0	0	1	0	1	1	0
Medium Extract/Spray Rinse	67	L	H	L	L	L	H	0	1	0	1	0	1	1	0
Extract Speed 1	66	L	H	L	L	L	H	0	1	0	0	0	1	1	0
Extract Speed 2	64	H	L	L	L	L	H	0	0	1	1	0	1	1	0
Extract Speed 3 (Default)	68	L	L	L	L	L	H	0	1	1	1	0	1	1	0
Extract Speed 3 (Maximum)	65	L	H	H	L	L	H	0	1	0	0	0	1	1	0

Table 27

Allen-Bradley 160-Series AC Drives

160 Series Drive Control Logic Chart

Cabinet Hardmount
 A Control, B control, V control and EDC/Netmaster control

H – Control Voltage High (greater than 10V DC) L – Control Voltage Low (less than 1V DC)								0 = No signal received 1 = Signal received							
		SW3	SW2	SW1	STF	Stop	STR	Preset Status – Parameter 15				Input Status – Parameter 12			
DC Volt Meter Red Probe Terminal Location		4	2	1	6	8	5								
DC Volt Meter Black Probe Terminal Location		3	3	3	3	3	3								
Action	Frequency Preset Parameter #	Terminal #4 (SW3)	Terminal #2 (SW2)	Terminal #1 (SW1)	Terminal #6 (STF)	Terminal #8 (Stop)	Terminal #5 (STR)	Not Used	SW3	SW2	SW1	Not Used	STF	Stop	STR
Idle	N/A	H	H	H	H	L/H	H	0	0	0	0	0	0	0/1	0
1/2 Wash Speed Forward	62	H	H	L	L	L	H	0	0	0	1	0	1	1	0
1/2 Wash Speed Reverse	62	H	H	L	H	L	L	0	0	0	1	0	0	1	1
Wash Speed Forward	63	H	L	H	L	L	H	0	0	1	0	0	1	1	0
Wash Speed Reverse	63	H	L	H	H	L	L	0	0	1	0	0	0	1	1
Distribution Speed	65	L	H	H	L	L	H	0	1	0	0	0	1	1	0
Spin 1	64	H	L	L	L	L	H	0	0	1	1	0	1	1	0
Spin 2	67	L	L	H	L	L	H	0	1	1	0	0	1	1	0
Spin 3	66	L	H	L	L	L	H	0	1	0	1	0	1	1	0

Table 28

160 Series Drive Control Logic Chart

**Cabinet Freestanding - 18 lb. and 25 lb.
P Control, V control and EDC/Netmaster control**

H – Control Voltage High (greater than 10V DC) L – Control Voltage Low (less than 1V DC)								0 = No signal received 1 = Signal received							
		SW3	SW2	SW1	STF	Stop	STR	Preset Status – Parameter 15				Input Status – Parameter 12			
DC Volt Meter Red Probe Terminal Location		4	2	1	6	8	5								
DC Volt Meter Black Probe Terminal Location		3	3	3	3	3	3								
Action	Frequency Preset Parameter #	Terminal #4 (SW3)	Terminal #2 (SW2)	Terminal #1 (SW1)	Terminal #6 (STF)	Terminal #8 (Stop)	Terminal #5 (STR)	Not Used	SW3	SW2	SW1	Not Used	STF	Stop	STR
Idle	N/A	H	H	H	H	L/H	H	0	0	0	0	0	0	0/1	0
1/2 Wash Speed Forward	62	H	H	L	L	L	H	0	0	0	1	0	1	1	0
1/2 Wash Speed Reverse	62	H	H	L	H	L	L	0	0	0	1	0	0	1	1
Wash Speed Forward	63	H	L	H	L	L	H	0	0	1	0	0	1	1	0
Wash Speed Reverse	63	H	L	H	H	L	L	0	0	1	0	0	0	1	1
Distribution Speed	65	L	H	H	L	L	H	0	1	0	0	0	1	1	0
Spin 1	64	H	L	L	L	L	H	0	0	1	1	0	1	1	0
Spin 2	67	L	L	H	L	L	H	0	1	1	0	0	1	1	0
Spin 3	66	L	H	L	L	L	H	0	1	0	1	0	1	1	0

**Cabinet Freestanding
WE-6 Control**

H – Control Voltage High (greater than 10V DC) L – Control Voltage Low (less than 1V DC)								0 = No signal received 1 = Signal received							
		SW3	SW2	SW1	STF	Stop	STR	Preset Status – Parameter 15				Input Status – Parameter 12			
DC Volt Meter Red Probe Terminal Location		4	2	1	6	8	5								
DC Volt Meter Black Probe Terminal Location		3	3	3	3	3	3								
Action	Frequency Preset Parameter #	Terminal #4 (SW3)	Terminal #2 (SW2)	Terminal #1 (SW1)	Terminal #6 (STF)	Terminal #8 (Stop)	Terminal #5 (STR)	Not Used	SW3	SW2	SW1	Not Used	STF	Stop	STR
Idle	N/A	H	H	H	H	L/H	H	0	0	0	0	0	0	0/1	0
1/2 Wash Speed Forward	65	L	H	H	L	L	H	0	1	0	0	0	1	1	0
1/2 Wash Speed Reverse	65	L	H	H	H	L	L	0	1	0	0	0	0	1	1
Wash Speed Forward	63	H	L	H	L	L	H	0	0	1	0	0	1	1	0
Wash Speed Reverse	63	H	L	H	H	L	L	0	0	1	0	0	0	1	1
Distribution Speed	62	H	H	L	L	L	H	0	0	0	1	0	1	1	0
Medium Extract	67	L	L	H	L	L	H	0	1	1	0	0	1	1	0
High 1 Extract	66	L	H	L	L	L	H	0	1	0	1	0	1	1	0
High 2 Extract	64	H	L	L	L	L	H	0	0	1	1	0	1	1	0
High 3 Extract	68	L	L	L	L	L	H	0	1	1	1	0	1	1	0

Table 29

Allen-Bradley 160-Series AC Drives

160 Series Drive Control Logic Chart

Pocket Hardmount - IPH, IP and CP Models PS40 control

H – Control Voltage High (greater than 10V DC) L – Control Voltage Low (less than 1V DC)				0 = No signal received 1 = Signal received			
	Fwd	Stop	Rev	Control Input Status – Parameter 12			
DC Volt Meter Red Probe Terminal Location	06	08	05				
DC Volt Meter Black Probe Terminal Location	03	03	03				
Action	Terminal #06 (STF)	Terminal #08 (Stop)	Terminal #05 (STR)	Not Used	STF	Stop	STR
Idle	H	L	H	0	0	1	0
Wash Speed Forward	L	L	H	0	1	1	0
Wash Speed Reverse	H	L	L	0	0	1	1
Distribution Speed	L	L	H	0	1	1	0
Low Spin Speed	L	L	H	0	1	1	0
Medium Spin Speed	L	L	H	0	1	1	0
High Spin Speed	L	L	H	0	1	1	0
SmartSpin	L	L	L	0	1	1	1

NOTE: These models use analog signals to control speed – refer to parameter #6 (command freq.) and parameter #16 (analog input %) to verify speed input signal.

Table 30

The Preset and Input Status displays of 1s and 0s represent the drive's display of parameters #12 and #15. These inputs can be viewed in the status display with a Program Key Module (Parameter Unit). Refer to the AC drive Diagnostics/Parameter Viewing Section. Parameter #15 displays the Preset Status and Parameter #12 displays the Input Status. When voltage is high (inactive) for an input, the status display will read "0" (Logic 0). When voltage is low (active) for an input, the status display will read "1" (Logic 1). *Table 31* contains the correct display value for each function. The first digit in the Preset and Input Status parameters do not correspond to a control input function.

Balance Output

The AC Drive Balance Output is transmitted to the machine controller by the closure of an on-board normally open mechanical relay shown in *Figure 24*. This action occurs at distribution speed connecting TB3-10 and TB3-11 when the drive detects an acceptable balance condition.



CAUTION

MACHINE DAMAGE AND/OR PERSONAL INJURY. Balance output terminals TB3-10 and TB3-11 should never be jumpered. This action will force the machine beyond designed tolerances.

W669

A secondary out-of-balance switch has been added to some machine models to prevent an extreme out-of-balance load from spinning. The switch opens the STOP input which disables the drive. The control inputs must be removed and reapplied to the drive for motion to resume after a STOP input has been interrupted.

Control Terminal (TB3) Torque Specifications

Max/Min Wire Size mm ² (AWG)	Maximum Torque N-m (lb-in)
2.5/0.5 (14/22)	0.8/0.4 (8/4)

Table 31

Allen-Bradley 160-Series AC Drives

Computer Output Boards

Connections identified on these figures set speed and direction of the drive.

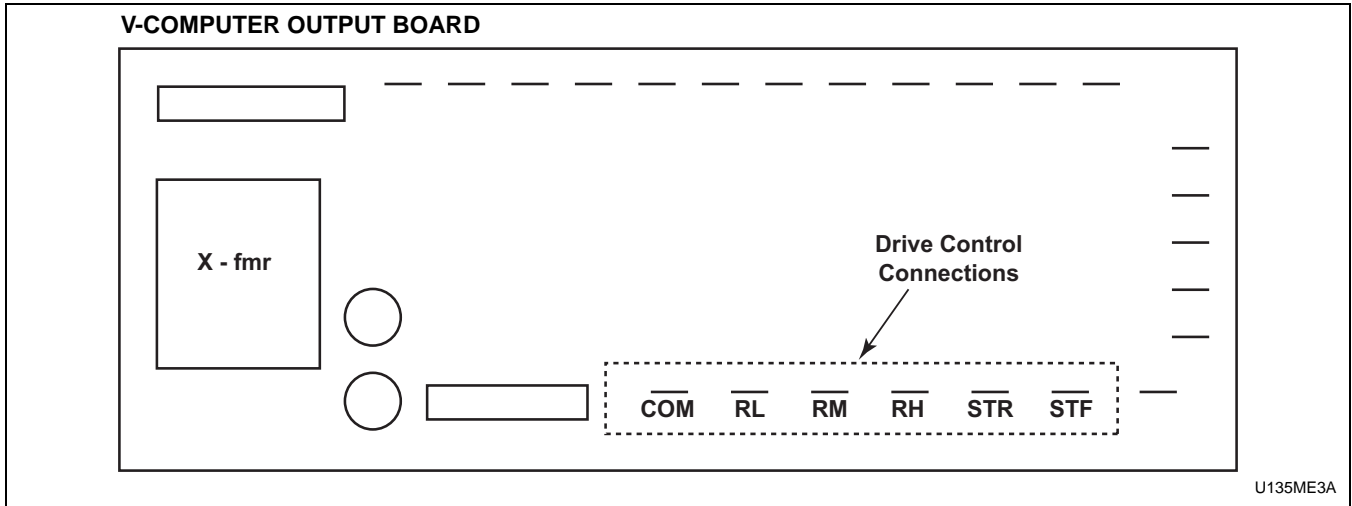

Figure 25

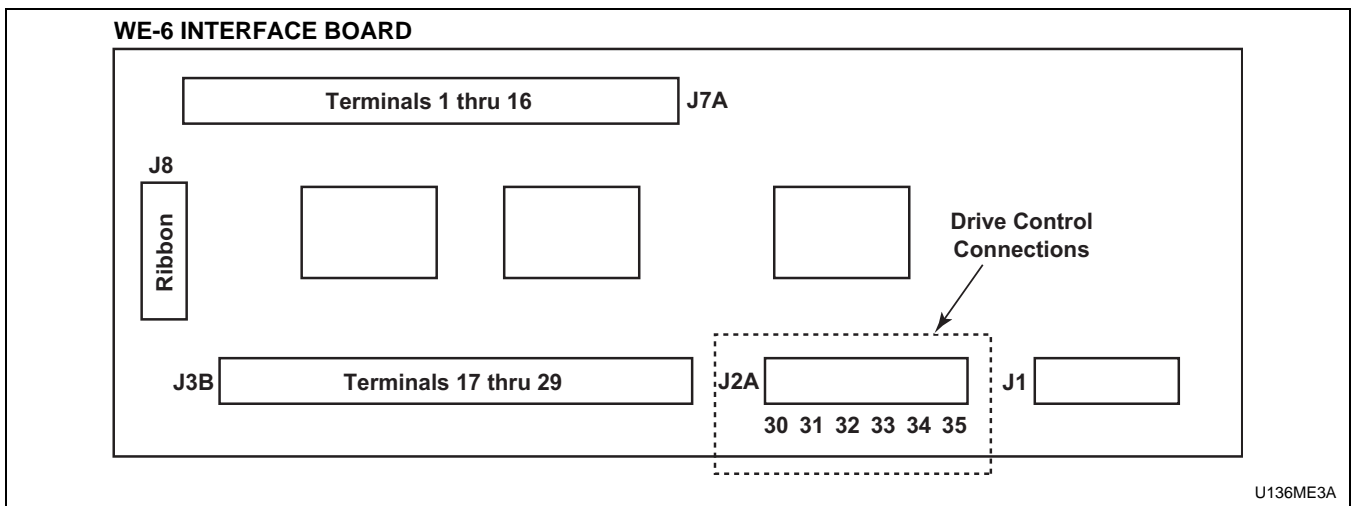

Figure 26

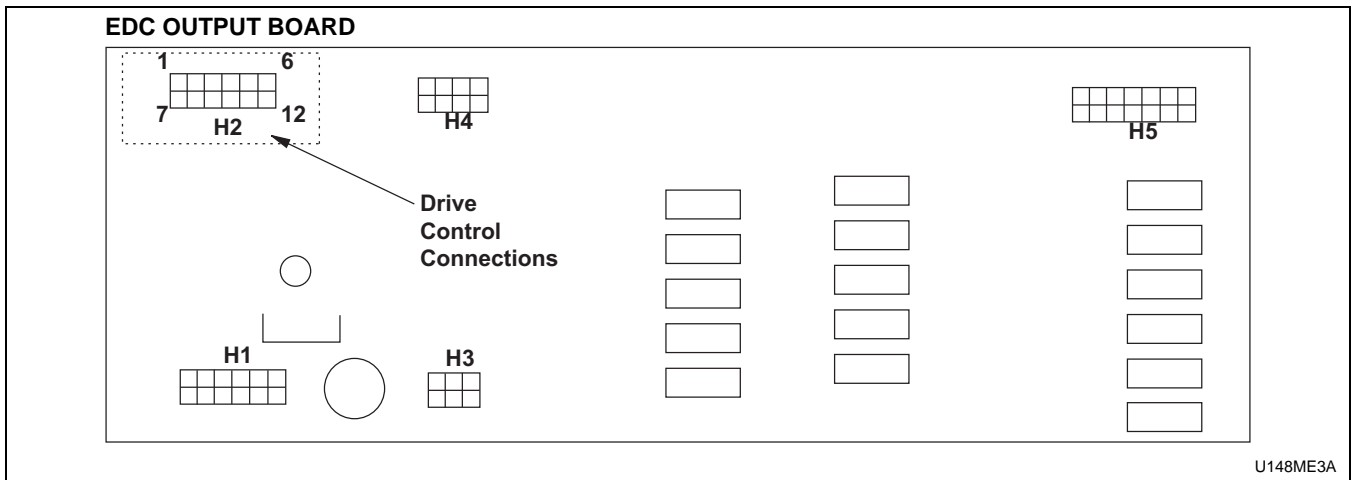

Figure 27

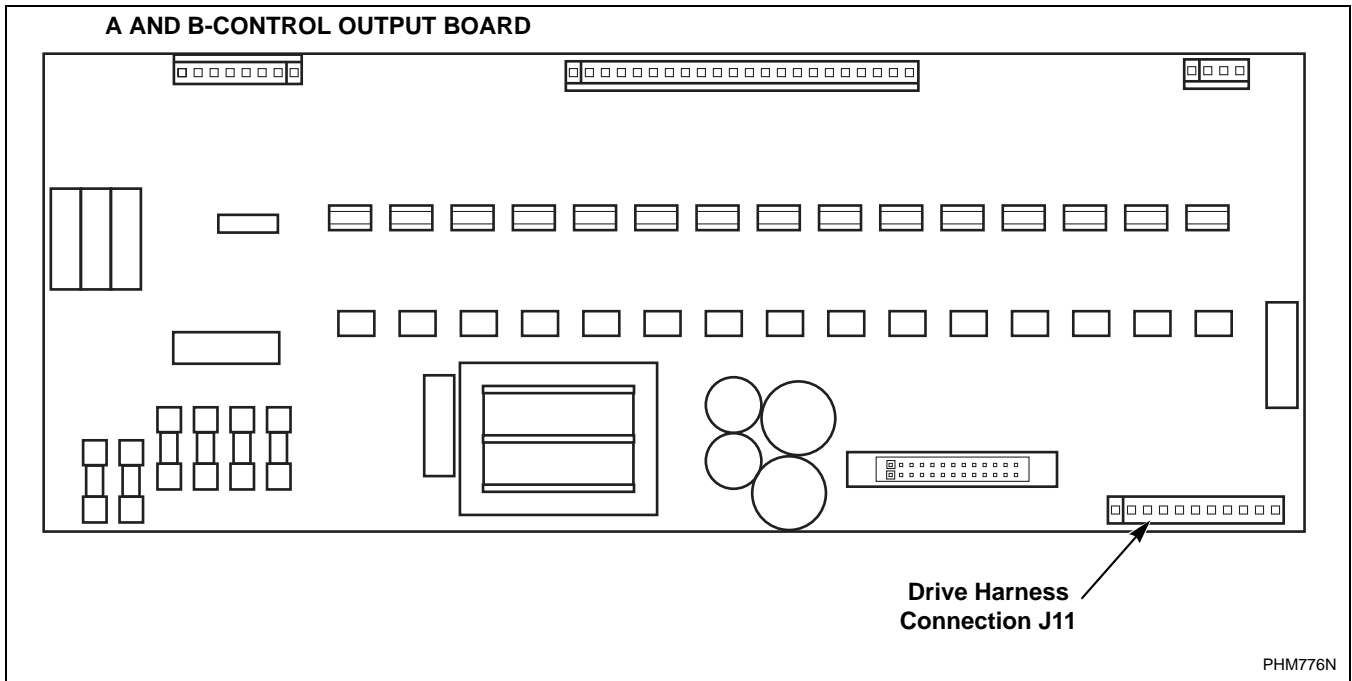

Figure 28

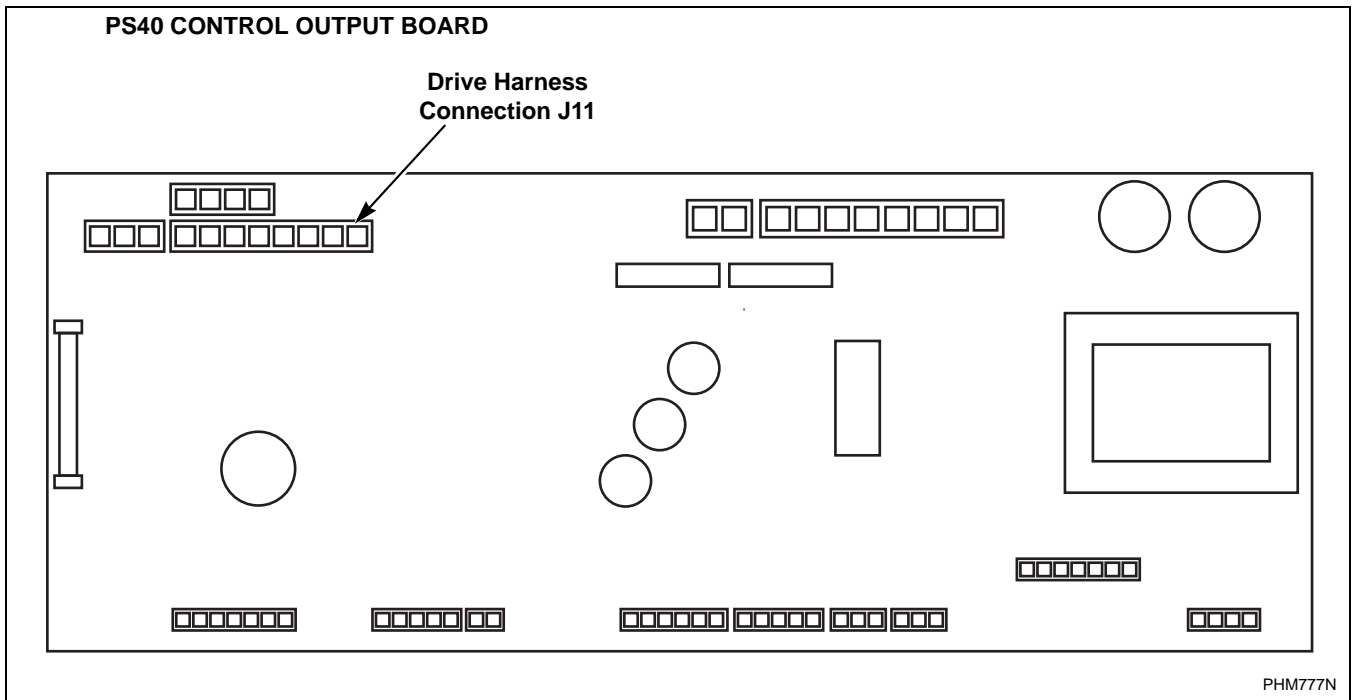

Figure 29

Allen-Bradley 160-Series AC Drives

Control Wire

During troubleshooting, if the wire path between the control board and the drive is uncertain, refer to *Table 32* for wire connection numbers.

Control Wire Connection Reference Table.

Output Board Terminal	
V-Control F370314, F8206501 and F370447-6, etc.	
STF	6
STR	5
RH	4
RM	2
RL	1
COM	3
WE-6 Interface Board P/N: F370577, F0370446-xx	
J2A-30	3
J2A-31	2
J2A-32	6
J2A-33	4
J2A-34	1
J2A-35	5
EDC – Output Board P/N: F370433	
H2-7	4
H2-8	2
H2-9	1
H2-10	3
H2-11	5
H2-12	6

Table 32 (continued)

Table 32 (continued)

Output Board Terminal	
A and B-Control P/N: F0370448xx	
J11-1-8/STF	6
J11-1-7/STR	5
J11-1-6/RH	4
J11-1-5/RM	2
J11-1-4/RL	1
J11-1-3/COM	3
PS40 Main Board P/N: C000281	
C12 OV, R-, L-	3
C12 0-10v	2
C12 R+	6
C12 L+	5
Jumper	7 and 8



Table 32

AC Drive Diagnostics/Parameter Viewing

160 Program Keypad Module (PKM or Parameter Unit)

Installation/Removal

The following are instructions for installing/removing the Program Keypad Module (P/N F370851) for parameter viewing and basic troubleshooting. Refer to *Table 31*.

	CAUTION
<p>Users are prohibited from changing parameter values unless specifically instructed by the washer-extractor manufacturer. Modification to parameter values may present potential harmful operating conditions for both hardware and personnel.</p>	
W673	
	WARNING
<p>To reduce risk of electric shock, severe injury or death, allow machine power to remain off for three minutes minimum prior to working in and around AC drive. Proceed with caution.</p>	
W662	

Installing the PKM

1. Remove power from the machine at main disconnect. Delay approximately three minutes.
2. Insert a small screwdriver into slot, pry back, and remove status display cover. Refer to *Figure 30*.
3. Insert the PKM bottom end first and then press the symbol  at the top of the module until the module is fully seated. The module is fully seated when its face is flush with the edges of its surrounding case.

Removing the PKM

1. Remove power from the machine at main disconnect. Delay approximately three minutes.
2. Insert small screwdriver into slot, pry back, and pivot module out. Avoid bending or twisting contact pins located underneath center portion of the module (*Figure 30*).
3. Reinstall the status display cover.

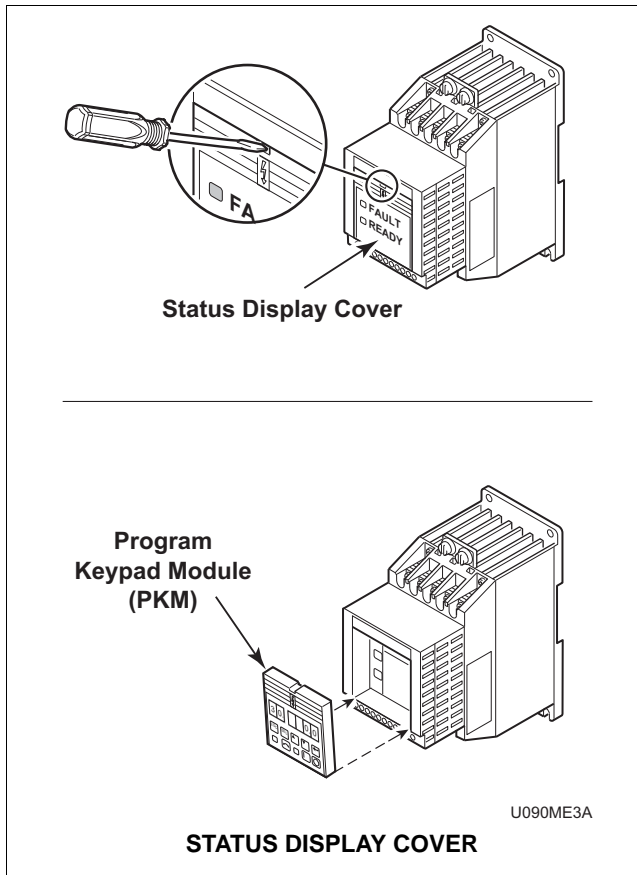

Figure 30

Program Keypad Module (PKM) Operation

The PKM contains a six-digit display on the front. The parameter number is displayed as the left two digits and the value obtained from the right four digits (Figure 31).

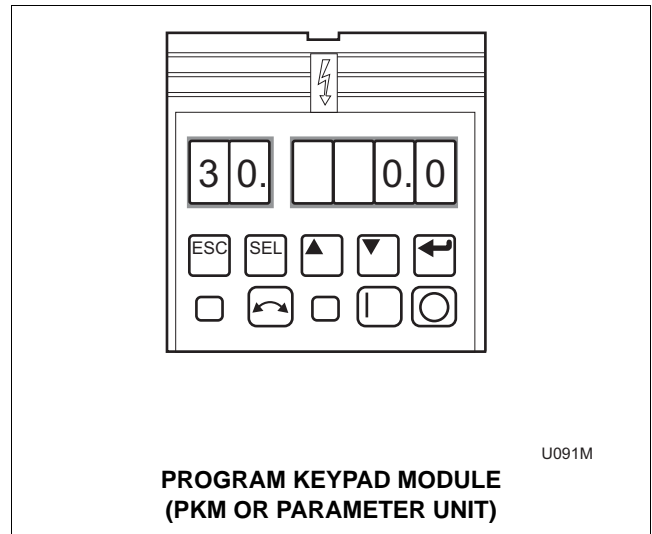







Figure 31



PKM – Key Explanation

-  **Escape** key. Use to return to last or original position.
-  **Select** key. Use to move cursor position.
-  **Up** arrow key. Scroll up.
-  **Down** arrow key. Scroll down.
-  **Enter** key. Use to enter program selection or new parameter value.

The PKM displays two groups of parameters: display and program. The parameters are listed in . The Display Group shows commonly viewed conditions that are helpful for troubleshooting problems. The Program Group contains parameters used to match the drive to a particular motor and application.

Viewing a Display Group

(Parameters #1 – 16 for Series A & B or Parameters #1 – 19 for Series C)

1. Install PKM on A-B 160 drive. Refer to “Installation/Removal”.
2. Turn on machine power.
3. Select the desired parameter by pressing the **Up** and **Down** arrow keys  . The parameter value is shown in the last four digits of the display.





	CAUTION
<p>Users are prohibited from changing parameter values unless specifically instructed by the washer-extractor manufacturer. Modification to parameter values may present potential harmful operating conditions for both hardware and personnel.</p>	
W673	

Viewing a Program Group

(Parameters #30 – 80 for Series A & B or Parameters #30 – 86 for Series C)

1. Install PKM on A-B 160 drive. Refer to “Installation/Removal.”
2. Turn on machine power.
3. The PKM begins in Display. Press the **ESC** key  to enter the Program Group.

NOTE: Confirmation of the mode is presented by a decimal point after the second parameter digit.

4. Parameter #30 should be displayed if entering the program group for the first time.
5. From this point, parameters #30 – 80 can be viewed by pressing the **Up** and **Down** arrow keys  .



6. To exit the Program Group, press the **ESC** key .

Display Mode Parameter Set

1	Output Frequency
2	Output Voltage
3	Output Current
4	Output Power
5	Bus Voltage
6	Frequency Command
7	Last Fault
8	Heatsink Temperature
9	Controller Status
10	Controller Type
11	Control Version
12	Input Status
13	Power Factor Angle
14	Memory Probe Address
15	Preset Status
16	Balance Angle
*17	Fault Buffer 0
*18	Fault Buffer 1
*19	Fault Buffer 2

Table 33

CopyCat Keypad

(For use with A-B 160 Series C Drives
P/N F370843, F370844, and
F370853 – F370858)

The operation of the CopyCat Keypad requires the installation of the 160 Series C Parameter Unit Kit (F798751). The kit includes the following parts.

- F370733 – Remote Programming Adapter (RPA)
- F370732 – Connector Cable (Note: This cable is different than P/N F370716 used with the HIM units on the 1305 and 1336 Model Drives).
- F370734 – CopyCat Keypad

	CAUTION
<p>Users are prohibited from changing parameter values unless specifically instructed by the washer-extractor manufacturer. Modification to parameter values may present potential harmful operating conditions for both hardware and personnel.</p>	
W673	

	WARNING
<p>To reduce risk of electric shock, severe injury or death, allow machine power to remain off for three minutes minimum prior to working in and around AC drive. Proceed with caution.</p>	
W662	

Remote Programming Adapter (RPA) Installation/Removal

Installing the RPA

1. Remove power from machine at main disconnect. Delay for approximately three minutes.
2. Insert a small screwdriver into slot, pry back, and remove status display cover. Refer to *Figure 32*.

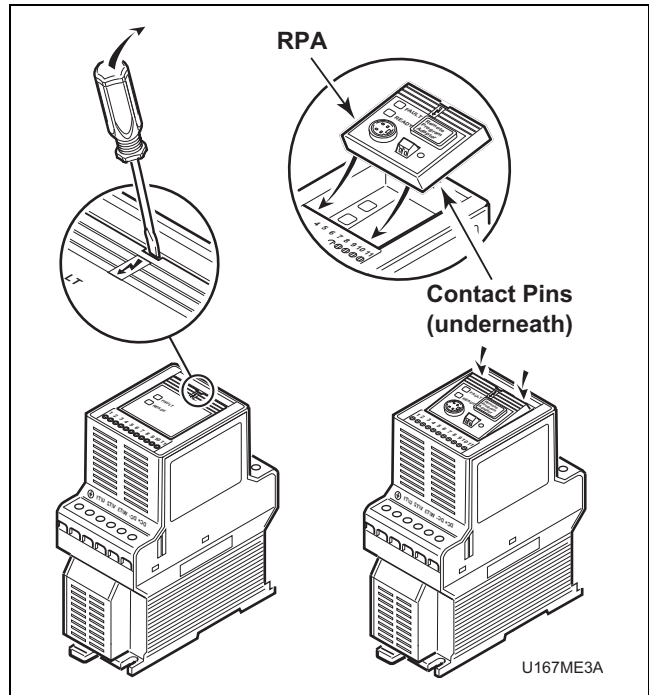



Figure 32

3. Insert the RPA bottom end first and then press the symbol  at the top of the adapter until its face is flush with the edges of its surrounding case.

	CAUTION
<p>It is required that the RPA be earth grounded to improve noise immunity and to guard the CopyCat Keypad against hazardous DC bus potential voltages.</p>	
W667	

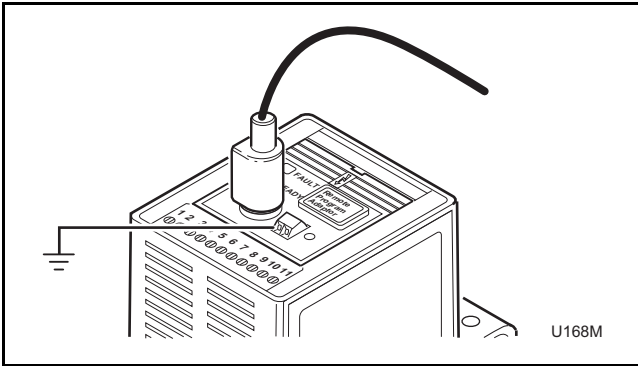

Figure 33

	WARNING
<p>A hazard of electric shock exists if the RPA is not tied to earth ground. Failure to provide an earth ground connection can result in severe personal injury or death.</p>	
W668	

Removing the RPA

1. Remove power from machine at main disconnect. Delay approximately three minutes.
2. Insert small screwdriver into slot, pry back, and pivot module out. Avoid bending or twisting contact pins located underneath center portion of the module. Refer to *Figure 32*.
3. Reinstall the status display cover.

Connector Cable

To remove the cable from the drive or the CopyCat Keypad, pull back on the plastic housing of the cable connector. Refer to *Figure 34*. The connector cable has a locking mechanism to ensure the cable will not be accidentally disconnected.

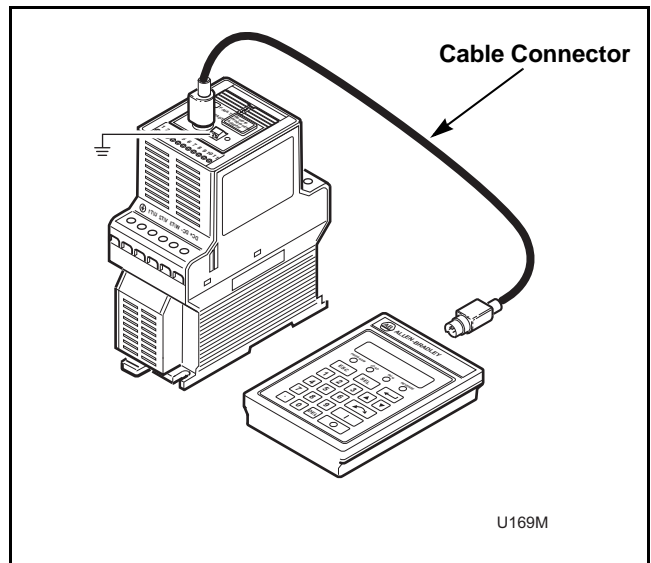

Figure 34

CopyCat Keypad Operation

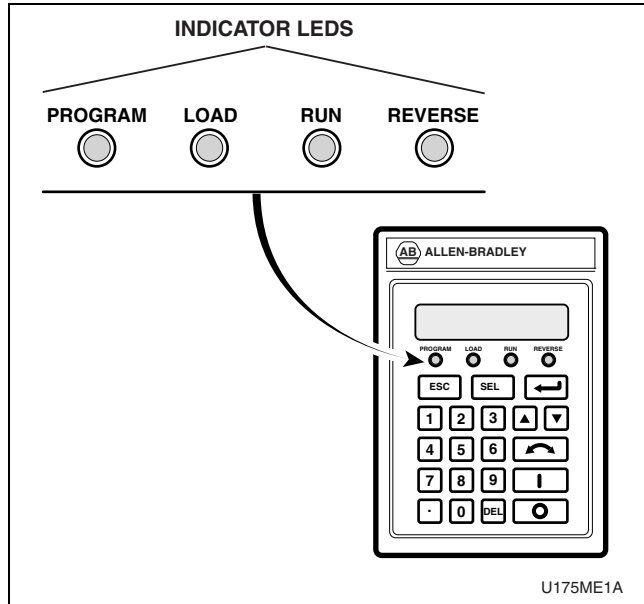

Figure 35

CopyCat Keypad – Key Explanation

Indicator LEDs. Indicate mode of operation.

ESC **Escape** key. Use to navigate a menu structure. Press to select mode of operation or, in Edit mode, to cancel an edit sequence.

SEL **Select** key. In Program mode, press to use Up or Down arrow keys to edit a parameter value.

▲ ▼ **Up and Down** arrow keys. In Program mode, use to scroll parameter numbers or change a parameter value. In Load mode, use to select a menu option. In Display mode, use to scroll through display parameters.

Numeric keys. Numbers 0 through 9, decimal point, and Delete keys enable direct entry of parameter values.



↵ **Enter** key. Press to save a new parameter value.

	<h2>CAUTION</h2>
<p>Users are prohibited from changing parameter values unless specifically instructed by the washer-extractor manufacturer. Modification to parameter values may present potential harmful operating conditions for both hardware and personnel.</p>	
W673	

Selecting a Parameter

There are two methods for selecting and viewing Display and Program Group parameters: scrolling through the parameters or entering the parameter number with the numeric keypad.

Scroll Parameter List

1. Connect CopyCat Keypad to Drive. Refer to “Installation/Removal” in this section.
2. Turn on machine power.
3. For Display Group parameters (#1 – 19), press the **Escape** key  until the Program LED and Load LED are both off; for Program Group parameters (#30 – 86), press the **Escape** key until the Program LED lights.
4. Press the **Up** or **Down** arrow key   to scroll to the next or previous parameter. Press and hold the **Up** or **Down** arrow key to increase scrolling speed.

Enter Parameter Number

1. Connect CopyCat Keypad to Drive. Refer to “Installation/Removal”.
2. Turn on machine power.
3. For Display Group parameters (#1 – 19), press the **Escape** key  until the Program LED and Load LED are both off; for Program Group parameters (#30 – 86), press the **Escape** key until the Program LED lights.

4. Enter the desired two-digit parameter number using the numeric keys.

The display shows the parameter number entered. For example: >17.

Output Current
P-03: 0.00 >17



To correct an entry, press the **Delete** key .

5. Press the Enter key , and the newly selected parameter name, number and value are displayed.

Fault Buffer 0
P-17: Under Volt

If the parameter number entered does not exist, an error message is displayed.

ERROR, No
Parameter P-33

6. Press the **Enter** key  or the **Escape** key  to return to the previous parameter.

NOTE: Ensure the parameter to be displayed is in the group that is currently being displayed: Display Group (#1 – 19) or Program Group (#30 – 86). Refer to Step 3.

Fault Display and Troubleshooting Information

This section provides information to guide users in understanding drive fault conditions and general troubleshooting procedures for Allen-Bradley drives. Included is a listing and description of the various drive faults with possible solutions, when applicable. For any questions regarding fault conditions, consult with the factory.

Each drive is equipped with a fault indicator light which illuminates when a fault condition exists.

Fault Code Identification

A-B 160

When a fault occurs, the fault indicator light will illuminate on the front cover of the A-B 160 drive, as shown in *Figure 36*. To view the fault type, the PKM or CopyCat Keypad must be installed. The A-B 160 fault number is located in parameter #07. Refer to PKM or CopyCat Keypad installation and operation. The PKM will flash the display when a fault is present as shown below (i.e., Fault Code 22). Cross reference the number in *Table 34* for fault identification and possible corrective action.

In addition, A-B 160 Series C fault codes are stored in a fault buffer with the capability to store up to three fault codes. If more than three faults are identified, the least recent fault is deleted to make room for the additional fault. "Fault Buffer 0" is the most recent fault. The faults are viewed using a PKM as shown below. Refer to PKM installation and operation.

The fault parameters are identified as follows:

"Last Fault"	Parameter #7	Most Recent
"Fault Buffer 0"	Parameter #17	Most Recent (same as Parameter #7)
"Fault Buffer 1"	Parameter #18	—
"Fault Buffer 2"	Parameter #19	—

Fault Parameter		Fault Code	
0	7		2 2

Clearing Faults

When a fault occurs, the cause must be corrected before the fault can be cleared. Resetting a fault will not correct the cause of the fault condition. After corrective action has been taken, simply cycling power to the drive will clear the fault.

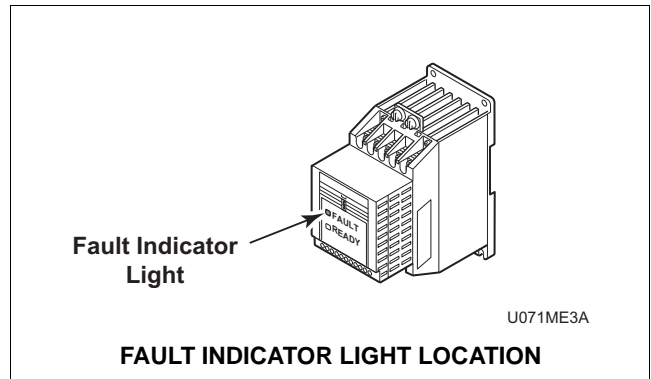

Figure 36

Allen-Bradley Drive Fault Codes

Allen-Bradley Drive Fault Codes			
	Fault	Description	Corrective Action/ Remarks
03	Power Loss Fault	DC Bus voltage remains below 85% nominal for longer than 0.005 seconds.	Monitor incoming AC line for low voltage or line power interruption.
04	Under Voltage Fault	DC Bus voltage fell below minimum.	Monitor AC incoming AC line for low voltage or line power interruption.
05	Over Voltage Fault	DC Bus maximum voltage exceeded.	Monitor the AC line for high line voltage or transient conditions. High voltage can result from motor regeneration. Buck transformer may be required.
06	Motor Stall	Motor has stalled. Motor load is excessive.	Check motor wiring and connection terminals. Check wash basket freedom of movement and excess belt tension.
07	Motor Overload Fault	Internal electronic overload trip. Excessive motor load exists.	Check motor wiring and connection terminals. Check wash basket freedom of movement and excess belt tension.
08	Over Temperature Fault	Excessive heat detected by heatsink transducer.	Clear blocked or dirty heatsink fins. Check ambient temperature. Check for blocked or nonoperating fan.
11	Serial Fault	Drive lost communication with controlling device.	HIM removed while power applied, cycle power to clear.
12	Overcurrent Fault	Overcurrent detected in instantaneous hardware trip circuit.	Check short circuit at the controller output or excessive load conditions at motor.
20	IPM Overtemp Fault	Internal power module thermal limit exceeded.	Check for blocked or dirty heatsink fins. Check ambient air. Check fan operation or filter blockage.
22	Controller Reset Fault	Stop input not present.	Check stop input into control terminal board. Close door and ensure any jumpers are placed correctly.
32	EEPROM Fault	EEProm has invalid data.	Consult the factory for further instructions.
33	Max Retries Fault	Controller failed to reset fault within the number of retries.	Fault exists that must be corrected before further operation. Check "Fault Buffer 1" on 1305 and 1336 for specific fault that triggered max retries fault.
38	Phase U Fault	Phase-to-ground fault detected between controller and motor in Phase U.	Check wiring between the drive and motor. Check for grounded phase.

Table 34 (continued)

Table 34 (continued)

Allen-Bradley Drive Fault Codes (continued)			
	Fault	Description	Corrective Action Remarks
39	Phase V Fault	Phase to ground fault detected between controller and motor in Phase V.	Check wiring between the drive and motor. Check for grounded phase.
40	Phase W Fault	Phase to ground fault detected between controller and motor in Phase W.	Check wiring between the drive and motor. Check for grounded phase.
41	UV Short Fault	Excessive current has been detected between two controller output terminals.	Check motor and external wiring to the controller output terminals for shorted condition.
42	UW Short Fault	Excessive current has been detected between two controller output terminals.	Check motor and external wiring to the controller output terminals for shorted condition.
43	VW Short Fault	Excessive current has been detected between two controller output terminals.	Check motor and external wiring to the controller output terminals for shorted condition.
48	Reset to Default Values	Parameters were reset to the factory default values.	Verify and re-load the desired parameters.

Table 34

Troubleshooting Suggestions

Important Considerations

- Drive cooling is extremely important to the overall service life of the product. Extreme care should be used to keep cooling air paths clean. Drive cabinet enclosures have been designed to optimize cooling. Keep cabinet doors closed and panels installed to maintain proper operation.
- Resetting a fault will not correct the cause of the fault condition. Corrective action must be taken prior to resetting a fault. Many drive error codes are reset by cycling power to the drive. The fault may not reappear until drive operation is initiated.
- Drive to motor wiring is critical to proper drive operation. Loose or bad connections can generate heat and increase current output from drive. These problems can manifest themselves in operation by many fault codes indicating overcurrent condition and maximum retries fault.

Problem/Corrective Action

Problem:

Wash basket does not rotate.

Corrective Action

1. Ensure computer control display on washer is showing proper operation.
2. Check power circuit, supply voltage, fuses and disconnects.
3. Verify drive to motor wires are damage free, properly connected and torqued to specifications.
4. Check belt tension and condition.
5. Verify no mechanical problems exist (i.e., binding, motion restriction).
6. Check control input signals. Refer to applicable table of inputs.

Problem:

Drive started but wash basket is not rotating.

Corrective Action

1. Verify drive to motor wires are damage-free, properly connected and torqued to specifications.
2. Verify no mechanical problems exist (i.e., binding, motion restriction).
3. Check control input signals. Refer to applicable table of inputs.

Problem:

Wash basket not accelerating properly.

Corrective Action

1. Verify drive to motor wires are damage-free, properly connected and torqued to specifications.
2. Verify speed selection control wire connections. Refer to applicable table.

Problem:

Drive gives Serial Fault (F10) when HIM is removed from the drive.

Corrective Action

1. Cycle power to drive to clear the fault.

When a HIM is disconnected with the drive powered, communication is lost and a fault results. Always remove power from the drive prior to HIM or PKM removal or installation.

Problem:

Drive displays fault code #22 (i.e., "0722").

Corrective Action

1. Verify connection between TB3 terminals 7 and 8.

This fault is most likely caused by the absence of the Stop Input.

Allen-Bradley 1305-Series AC Drives

Installation/Wiring

	CAUTION
<p>An incorrectly installed system can result in component damage or reduction in product life. The most common causes are:</p> <ol style="list-style-type: none"> 1. Wiring AC line to drive output or control terminals. 2. EXTERNAL voltage application to control terminals. 3. Incorrect or inadequate AC supply. <p>Contact factory for assistance with application or wiring.</p>	
W660	

Input Power Conditioning

The drive is suitable for direct connection to input power within the rated voltage of the drive. Listed in *Table 35* are certain input power conditions which may cause component damage or reduction in product life. If any of the conditions exist, as described in *Table 35*, install one of the devices listed under the heading *Corrective Action* on the line side of the drive.

IMPORTANT: Only one device per branch circuit is required. It should be mounted closest to the branch and sized to handle the total current of the branch circuit.

Input Power Condition	Corrective Action
Low Line impedance (less than 1% line reactance)	<ul style="list-style-type: none"> • Install Line Reactor • or Isolation Transformer • or Bus Inductor – 5.5 & 11kW (7.5 & 15 HP) drives only
Greater than 120 kVA supply transformer	
Line has power factor correction capacitors	<ul style="list-style-type: none"> • Install Line Reactor • or Isolation Transformer
Line has frequent power interruptions	
Line has intermittent noise spikes in excess of 6000V (lightning)	
Phase to ground voltage exceeds 125% of normal line to line voltage	<ul style="list-style-type: none"> • Remove MOV jumper to ground. • or Install Isolation Transformer with grounded secondary if necessary
Ungrounded distribution system	
240V open delta configuration (stinger leg) ⁽¹⁾	<ul style="list-style-type: none"> • Install Line Reactor
<p>⁽¹⁾ For drives applied on an open delta with a middle phase grounded neutral system, the phase opposite the phase that is tapped in the middle to the neutral or earth is referred to as the “stinger leg,” “high leg,” “red leg,” etc. This leg should be identified throughout the system with red or orange tape on the wire at each connection point. The stinger leg should be connected to the center Phase B on the reactor.</p>	

Table 35

Electrical Interference

EMI

Careful attention must be given to the arrangement of power and ground connections to the drive to avoid interference with nearby sensitive equipment. Be sure to replace all ground connections to their appropriate locations.

RFI

Drives can be installed with an RFI filter, which controls high-frequency conducted emissions into the main supply lines.

Where it is essential that very low emission levels must be achieved or if conformity with standards is required, the optional RFI filter may be present. *Figure 37* displays an electrical schematic for various RFI configurations. *Table 39* shows associated RFI filter part numbers.

	CAUTION
<p>ELECTRIC SHOCK HAZARD! Service and maintenance to be performed only by an authorized technician. Disconnect power before opening any access panels.</p>	
W661	

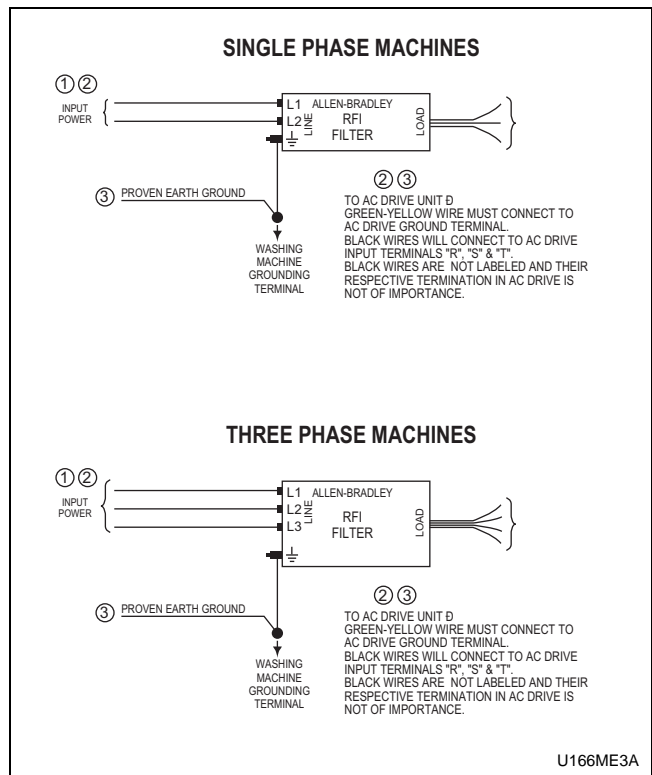



Figure 37

RFI Filter Part Number Information			
Drive P/N	Drive Catalog	Machine Voltage	Filter P/N
370815	1305-AA12	200-240V/1 Phase	Not Available
370815	1305-AA12	200-240V/3 Phase	330272
370816	1305-BA06	380-480V/3 Phase	330271
370818	1305-BA09	380-480V/3 Phase	330272

Table 36

Terminal Block Access

	<h2 style="margin: 0;">WARNING</h2>
<p>To reduce risk of electric shock, severe injury or death, allow machine power to remain off for three minutes minimum prior to working in and around AC drive. Proceed with caution.</p>	
<small>W662</small>	

The following information illustrates the terminal block designations for each of the drive models.

To access the power and control terminal blocks, refer to *Figure 38* and perform the following procedure:

1. Remove power from the machine at main disconnect.

2. Lower hinged panel located below HIM or blank front cover.
3. For drives equipped with a blank front panel, slide panel downward and remove it from drive. Skip to Step 5.
4. For drives equipped with a Human Interface Module (HIM), press retaining lever directly beneath the HIM and slide the HIM downward to remove it from drive.
5. Loosen front panel fastener by rotating counterclockwise 90 degrees. Refer to *Figure 38*.
6. Holding upper corners of front panel, pull top of panel down 90 degrees and lift off.

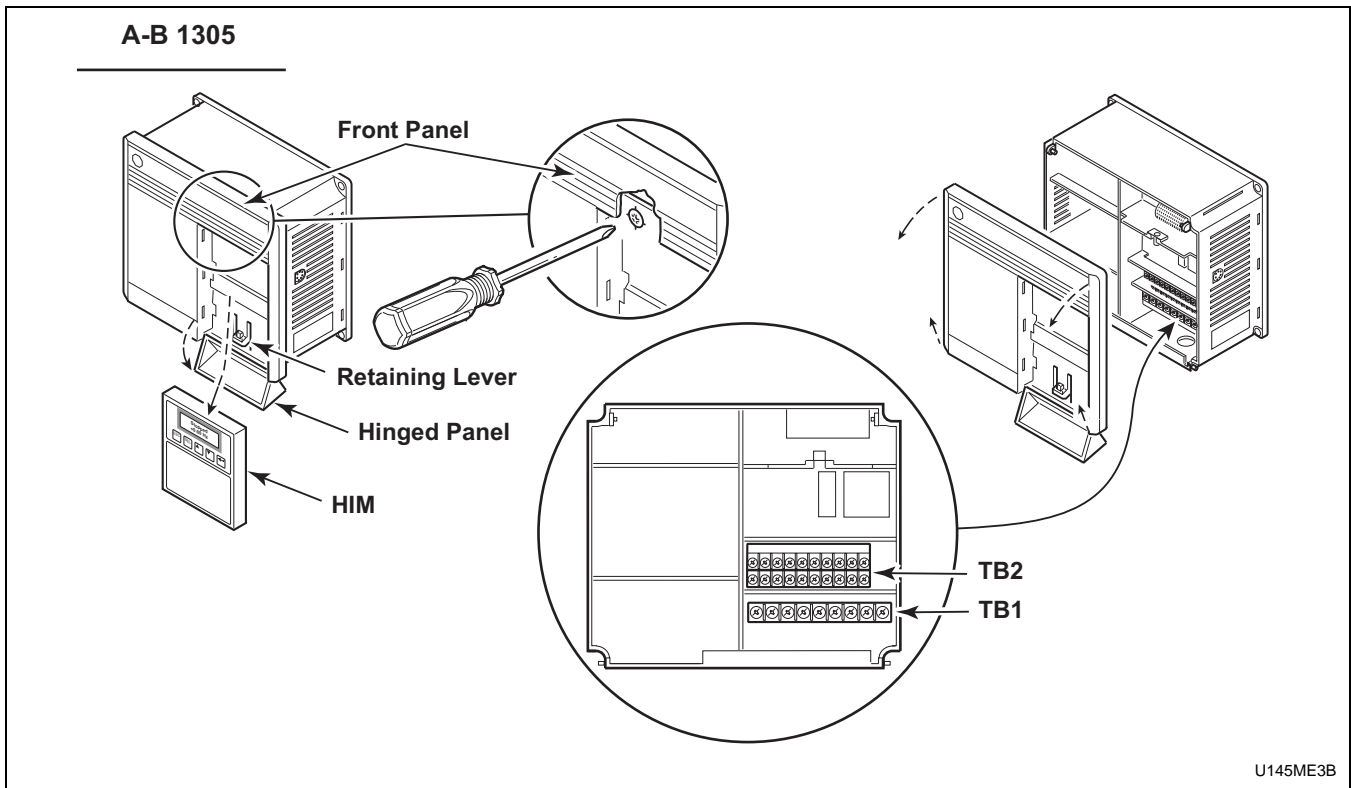

Figure 38

Power Terminal Block Description

Input and output power connections are performed through a ten-position terminal block, TB1. Refer to *Figure 39*.

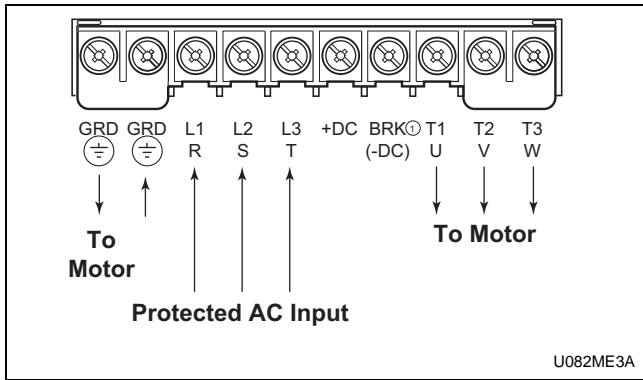

Figure 39

Power Block Terminal (TB1)

Terminals	Description
GRD	Earth Ground
R, S, T (L1, L2, L3)	AC Input Line Terminals
+DC, BRK (or -DC)	Dynamic Brake Option – Refer to instructions with option
U, V, W (T1, T2, T3)	Motor Connection

Table 37

Torque Specifications

Terminal	Screw Size	Max/Min Wire Size mm ² (AWG)	Max/Min Torque N-m (lb-in)
TB1 (0.37 to 0.75 kW 1/2 to 1 HP)	M4	3.5/0.75 (12/18)	0.90 (8)
TB1 (All except above)	M4	4/0.75 (10/18)	1.81 (16)
TB2 (All)	M3.5	1.5/0.20 (14/24)	0.90 (8)

Table 38

Control Terminal Blocks Description and Control Logic

Control terminal functions are unique to each Allen-Bradley Drive. Each drive’s control terminal is addressed independently.

Control Terminal Block (TB2) Function

WARNING

To reduce risk of electric shock, severe injury or death, allow machine power to remain off for three minutes minimum prior to working in and around AC drive. Proceed with caution.

W662

CAUTION

The controller is supplied with an internal 5V supply. Dry contacts or open collectors are required for discrete control inputs. If an external voltage is applied, component failure could occur.

W670

Input Mode Parameter

The control terminal functions are determined in part by the Input Mode parameter #21. Changing this parameter affects the function of some terminals. All machines equipped with 1305 drives use Input Mode “UNIMAC”.

NOTE: If the Input Mode is changed, power must be cycled to the drive for the change to take effect.

Speed Selection

Motor speeds are controlled by solid state or mechanical switch closure inputs to SW1, SW2 and SW3 in conjunction with STR and STF (direction) inputs. Refer to *Figure 40* and *Table 39*.

Table 44 designates the preset speed selection based on the inputs to the control terminals. A disconnected control terminal will seek the high control voltage condition (approx. 5 Volts DC). To activate a control input (i.e., SW1, SW2, etc.), the terminal is connected to a common terminal (TB2-7, TB2-12, or TB2-15) to lower the control voltage to a low condition (less than 1 Volt DC).

Allen-Bradley 1305-Series AC Drives

The Input Status' display of 1s and 0s represents the drive's display of parameter #55. These inputs can be viewed in the status display with a Human Interface Module (HIM or parameter unit). Parameter #55 displays the Input Status. When voltage is high (inactive) for an input, the status display will read "0" (Logic 0). When voltage is low (active) for an input, the status display will read "1" (Logic 1).

Table 44 contains the correct display value for each function.

The first digit in the Input Status parameter does not correspond to a control input function. Refer to Table 44.

NOTE: The Preset Speed logic is specific to the type of computer the machine is equipped with (i.e., WE-6 or V-Control).

Balance Output

The Balance Output is transmitted to the machine controller by the closure of a normally open mechanical relay shown in Figure 40. This action occurs at distribution speed connecting TB2-9 and TB2-10 when the drive detects an acceptable balance condition.

	CAUTION
<p>MACHINE DAMAGE AND/OR PERSONAL INJURY. Balance output terminals TB2-9 and TB2-10 should never be jumpered. This action will force machine beyond designated tolerances.</p>	
W664	

A secondary out-of-balance switch has been added to some machine models to prevent an extreme out-of-balance load from spinning. The switch opens the Enable or STOP input which disables the drive. The control inputs must be removed and reapplied to the drive for motion to resume after a STOP or Enable input has been interrupted.

Jumpered Inputs

Carefully review electrical schematics when replacing a drive. Some machine models jumper the STOP and/or ENABLE inputs to the drive (refer to Figure 40).

NOTE: Verify that inputs are jumpered. Wire or metal clip jumpers may be used and can be easily overlooked during a replacement.

	CAUTION
<p>MACHINE DAMAGE AND/OR PERSONAL INJURY. Never jumper inputs if not previously configured with jumpers as identified on the applicable electrical schematic. Jumpering these inputs will override safety features.</p>	
W665	

Running Status

Some machines require an output from the drive indicating the drive is running. TB2-19 and TB2-20 connect to the computer (V-Computer, EDC). The drive connects the two terminals with a solid state switch to indicate the drive is running.

Control Terminal Block Designations

Terminal Number	Signal	Typical Machine Use
1, 2, 3	External Speed Pot	Specialty Machines Only
2, 3	0 – 10V Analog Input	Specialty Machines Only
4, 3	4 – 20mA Analog Input	Specialty Machines Only
5, 3	0 – 10V Analog Output	Specialty Machines Only
6, 7	STF	Forward Motion
8, 7	Stop	Out-of-Balance Switch or Jumper
9, 10	Programmable Output 1 Normally Open	Balance Relay
11, 12	Drive Enable	Emergency Stop Disable Out-of-Balance Switch or Jumper
13, 12	STR	Reverse Motion
14, 15	Jog	Unused
16, 15	SW1	Preset Speed Input #1
17, 15	SW2	Preset Speed Input #2
18, 15	SW3	Preset Speed Input #3
19, 20	Programmable Output 2 Normally Open	Drive running output

Table 39

**Input Mode = "UniMac" Parameter #21
Typical Configuration**

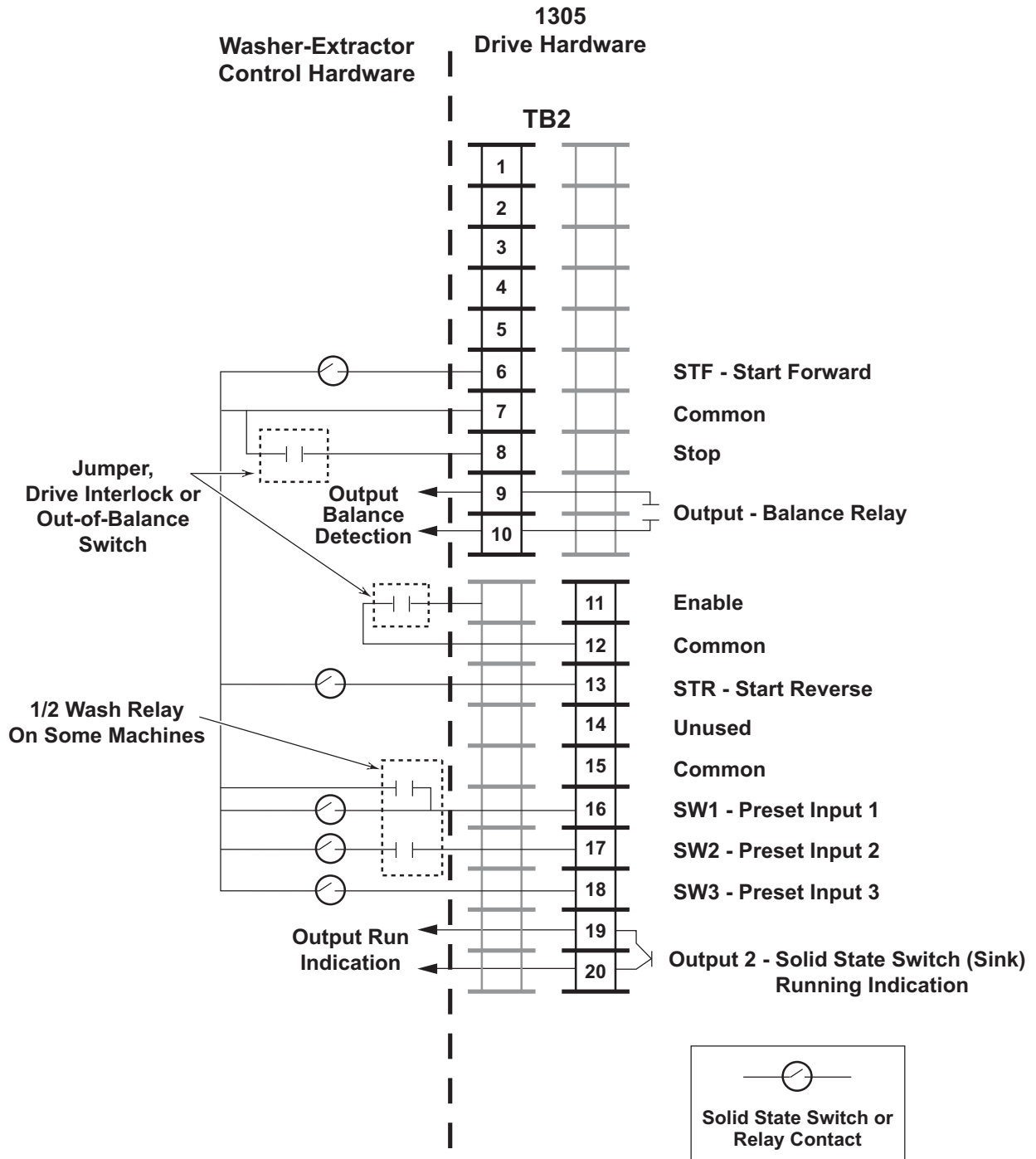

- | | | | |
|---|--|---|---------------------------------|
| 1 | Jumper Balance Switch or Drive Interlock Relay | 3 | 1/2 Wash Relay on some machines |
| 2 | Jumper or Motor Overtemp Switch | 4 | Fault Indicator Light |

PHM665N

Figure 40

Allen-Bradley 1305-Series AC Drives

Control Logic Chart

Pocket Hardmount V Control

H – Control Voltage High (approximately 5V DC) L – Control Voltage Low (less than 1V DC)								0 = No Signal Received 1 = Signal Received							
		SW3	SW2	SW1	Rev	Stop	Fwd	Input Status - Parameter #55							
DC Volt Meter Red Probe Terminal Location		18	17	16	13	8	6								
DC Volt Meter Black Probe Terminal Location		7	7	7	7	7	7								
Action	Frequency Preset Parameter	Terminal #18 (SW3)	Terminal #17 (SW2)	Terminal #16 (SW1)	Terminal #13 (STR)	Terminal #8 (Stop)	Terminal #6 (STF)	Not Used	SW3	SW2	SW1	Not Used	Rev (STR)	Stop	Fwd (STF)
Idle	N/A	H	H	H	H	L/H	H	0	0	0	0	0	0	0/1	0
1/2 Wash Speed Forward	27	H	H	L	H	L	L	0	0	0	1	0	0	1	1
1/2 Wash Speed Reverse	27	H	H	L	L	L	H	0	0	0	1	0	1	1	0
Wash Speed Forward	28	H	L	H	H	L	L	0	0	1	0	0	1	1	0
Wash Speed Reverse	28	H	L	H	L	L	H	0	1	0	0	0	0	1	1
Distribution Speed	73	L	H	H	H	L	L	0	1	0	0	0	0	1	1
Spin 1	29	L	L	H	H	L	L	0	1	1	1	0	0	1	1
Spin 2	75	L	L	H	H	L	L	0	1	1	0	0	0	1	1
Spin 3	74	L	H	L	H	L	L	0	1	0	1	0	0	1	1

Pocket Hardmount WE-6 Control

H – Control Voltage High (approximately 5V DC) L – Control Voltage Low (less than 1V DC)								0 = No Signal Received 1 = Signal Received							
		SW3	SW2	SW1	Rev	Stop	Fwd	Input Status - Parameter #55							
DC Volt Meter Red Probe Terminal Location		18	17	16	13	8	6								
DC Volt Meter Black Probe Terminal Location		7	7	7	7	7	7								
Action	Frequency Preset Parameter	Terminal #18 (SW3)	Terminal #17 (SW2)	Terminal #16 (SW1)	Terminal #13 (STR)	Terminal #8 (Stop)	Terminal #6 (STF)	Not Used	SW3	SW2	SW1	Not Used	Rev (STR)	Stop	Fwd (STF)
Idle	N/A	H	H	H	H	L/H	H	0	0	0	0	0	0	0/1	0
Half-Wash Speed Forward	73	L	H	H	H	L	L	0	1	0	0	0	0	1	1
Half-Wash Speed Reverse	73	L	H	H	L	L	L	0	1	0	0	0	1	1	0
Wash Speed Forward	28	H	L	H	H	L	L	0	0	1	0	0	0	1	1
Wash Speed Reverse	28	H	L	H	L	L	H	0	0	1	0	0	1	1	0
Distribution Speed	27	H	H	L	H	L	L	0	0	1	0	0	1	1	0
Medium Extract/Spray Rinse	75	L	L	H	H	L	L	0	1	1	0	0	0	1	1
High 1 Extract	74	H	L	L	H	L	L	0	1	0	1	0	0	1	1
High 2 Extract	29	H	L	L	H	L	L	0	0	1	1	0	0	1	1
High 3 Extract	76	L	L	L	H	L	L	0	1	1	1	0	0	1	1

Table 40

Control Terminal (TB2) Torque Specifications

Max/Min Wire Size mm ² AWG	Maximum Torque N-m (lb-in)
1.5/0.20 (14/24)	0.90 (8)

Table 41

1305-Series Drive Control Logic Chart

**Cabinet Hardmount
V-Control and EDC/Netmaster Control**

H – Control Voltage High (approximately 5V DC) L – Control Voltage Low (less than 1V DC)								0 = No Signal Received 1 = Signal Received							
		SW3	SW2	SW1	Rev	Stop	Fwd	Input Status - Parameter #55							
DC Volt Meter Red Probe Terminal Location		18	17	16	13	8	6								
DC Volt Meter Black Probe Terminal Location		7	7	7	7	7	7								
Action	Frequency Preset Parameter	Terminal #18 (SW3)	Terminal #17 (SW2)	Terminal #16 (SW1)	Terminal #13 (STR)	Terminal #8 (Stop)	Terminal #6 (STF)	Not Used	SW3	SW2	SW1	Not Used	Rev (STR)	Stop	Fwd (STF)
Idle	N/A	H	H	H	H	L/H	H	0	0	0	0	0	0	0/1	0
1/2 Wash Speed Forward	27	H	H	L	H	L	L	0	0	0	1	0	0	1	1
1/2 Wash Speed Reverse	27	H	H	L	L	L	H	0	0	0	1	0	1	1	0
Wash Speed Forward	28	H	L	H	H	L	L	0	0	1	0	0	0	1	1
Wash Speed Reverse	28	H	L	H	L	L	H	0	0	1	0	0	1	1	0
Distribution Speed	73	L	H	H	H	L	L	0	1	0	0	0	0	1	1
Spin 1	29	H	L	L	H	L	L	0	0	1	0	0	0	1	1
Spin 2	75	L	L	H	H	L	L	0	1	1	0	0	0	1	1
Spin 3	74	L	H	L	H	L	L	0	1	0	1	0	0	1	1

Table 42

Allen-Bradley 1305-Series AC Drives

1305-Series Drive Control Logic Chart

Cabinet freestanding

P Control, V Control and EDC/Netmaster Control

H – Control Voltage High (approximately 5V DC) L – Control Voltage Low (less than 1V DC)								0 = No Signal Received 1 = Signal Received							
		SW3	SW2	SW1	Rev	Stop	Fwd	Input Status - Parameter #55							
DC Volt Meter Red Probe Terminal Location		18	17	16	13	8	6								
DC Volt Meter Black Probe Terminal Location		7	7	7	7	7	7								
Action	Frequency Preset Parameter	Terminal #18 (SW3)	Terminal #17 (SW2)	Terminal #16 (SW1)	Terminal #13 (STR)	Terminal #8 (Stop)	Terminal #6 (STF)	Not Used	SW3	SW2	SW1	Not Used	Rev (STR)	Stop	Fwd (STF)
Idle	N/A	H	H	H	H	L/H	H	0	0	0	0	0	0	0/1	0
1/2 Wash Speed Forward	27	H	H	L	H	L	L	0	0	0	1	0	0	1	1
1/2 Wash Speed Reverse	27	H	H	L	L	L	H	0	0	0	1	0	1	1	0
Wash Speed Forward	28	H	L	H	H	L	L	0	0	1	0	0	0	1	1
Wash Speed Reverse	28	H	L	H	L	L	H	0	0	1	0	0	1	1	0
Distribution Speed	73	L	H	H	H	L	L	0	1	0	0	0	0	1	1
Spin 1	29	H	L	L	H	L	L	0	0	1	1	0	0	1	1
Spin 2	75	L	L	H	H	L	L	0	1	1	0	0	0	1	1
Spin 3	74	L	H	L	H	L	L	0	1	0	1	0	0	1	1

Cabinet Freestanding WE-6 Control

H – Control Voltage High (approximately 5 V DC) L – Control Voltage Low (less than 1 V DC)								0 = No Signal Received 1 = Signal Received							
		SW3	SW2	SW1	Rev	Stop	Fwd	Input Status - Parameter #55							
DC Volt Meter Red Probe Terminal Location		18	17	16	13	8	6								
DC Volt Meter Black Probe Terminal Location		7	7	7	7	7	7								
Action	Frequency Preset Parameter	Terminal #18 (SW3)	Terminal #17 (SW2)	Terminal #16 (SW1)	Terminal #13 (STR)	Terminal #8 (Stop)	Terminal #6 (STF)	Not Used	SW3	SW2	SW1	Not Used	Rev (STR)	Stop	Fwd (STF)
Idle	N/A	H	H	H	H	L/H	H	0	0	0	0	0	0	0/1	0
Half-Wash Speed Forward	73	L	H	H	H	L	L	0	1	0	0	0	0	1	1
Half-Wash Speed Reverse	73	L	H	H	L	L	H	0	1	0	0	0	1	1	0
Wash Speed Forward	28	H	L	H	H	L	L	0	0	1	0	0	0	1	1
Wash Speed Reverse	28	H	L	H	L	L	H	0	0	1	0	0	1	1	0
Distribution Speed	27	H	H	L	H	L	L	0	0	1	0	0	0	1	1
Medium Extract	75	L	L	H	H	L	L	0	1	1	0	0	0	1	1
High 1 Extract	74	L	H	L	H	L	L	0	1	0	1	0	0	1	1
High 2 Extract	29	H	L	L	H	L	L	0	0	1	1	0	0	1	1
High 3 Extract	76	L	L	L	H	L	L	0	1	1	1	0	0	1	1

Table 43

Computer Output Boards

Connections identified on these figures set speed and direction of the drive.

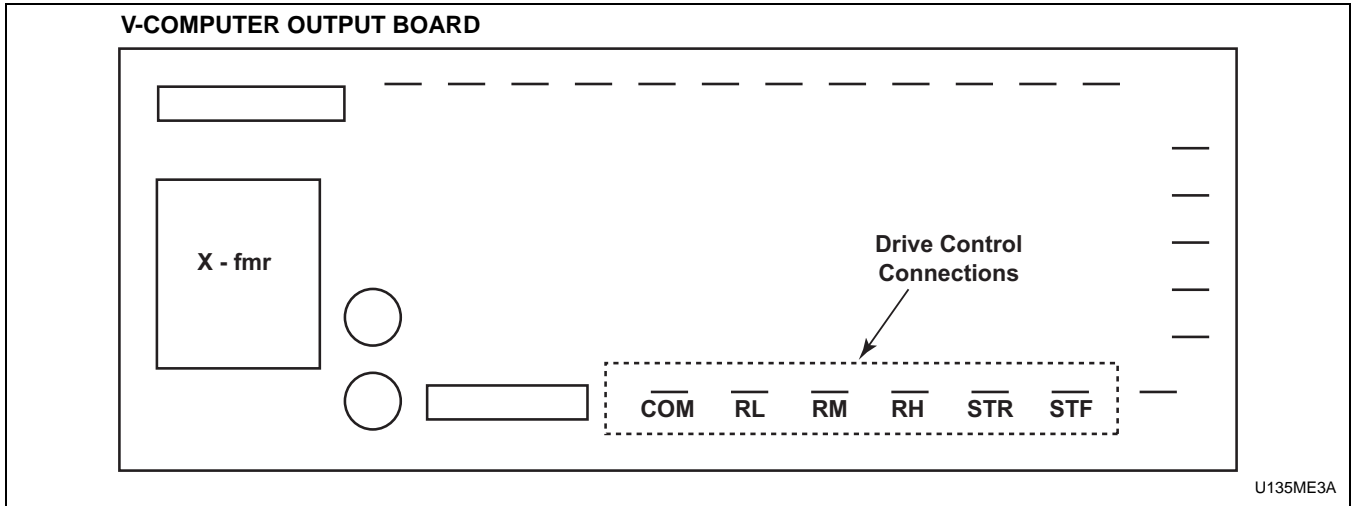

Figure 41

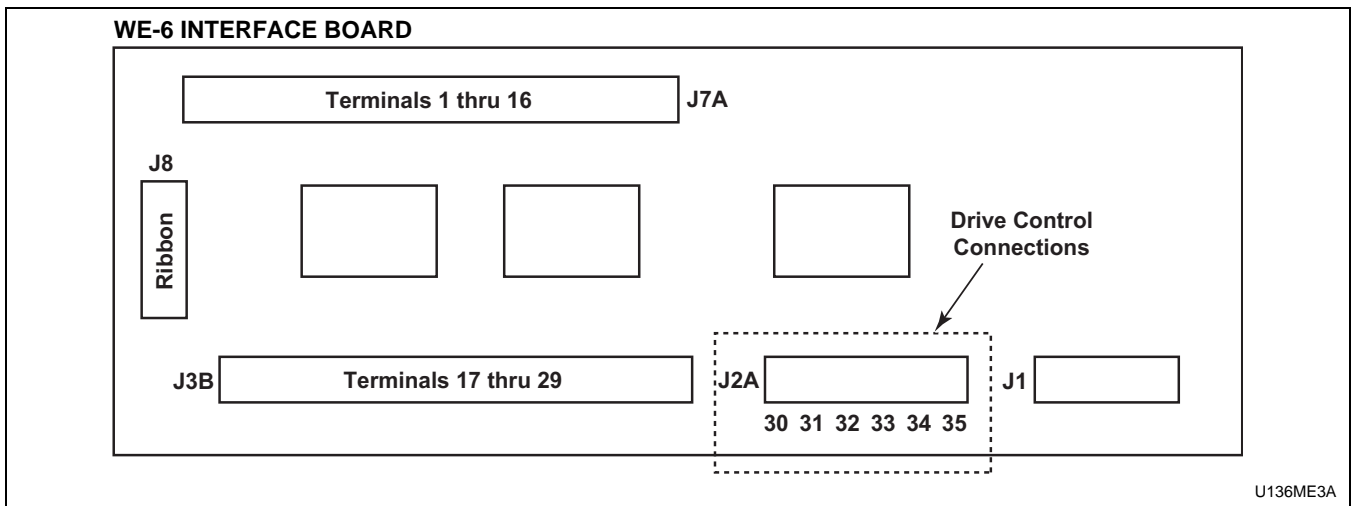

Figure 42

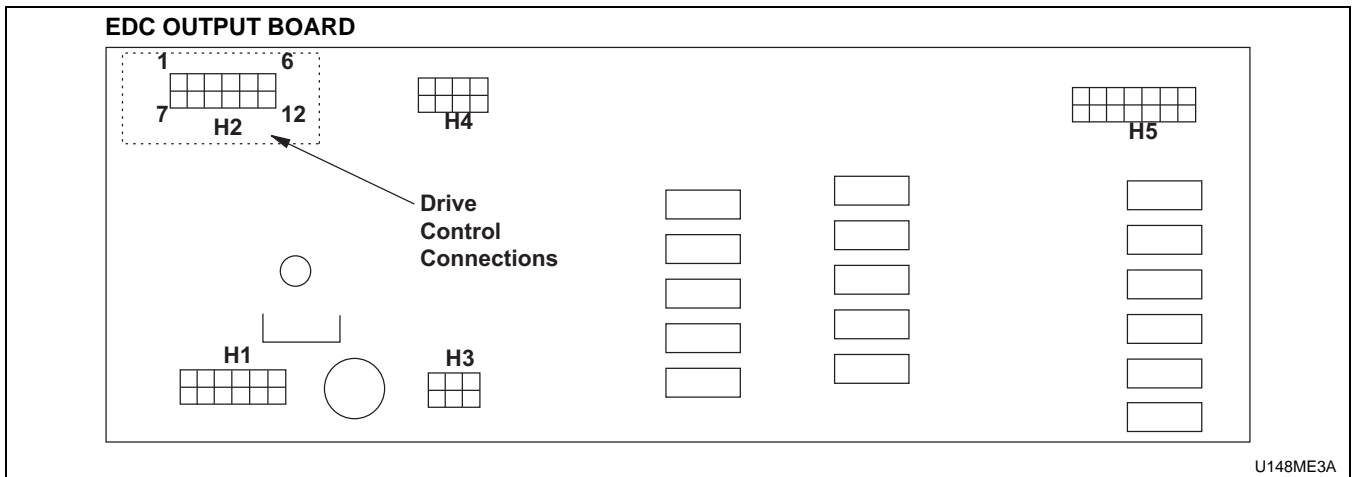

Figure 43

Allen-Bradley 1305-Series AC Drives

Control Wire

During troubleshooting, if the wire path between the control board and the drive is uncertain, refer to *Table 44* for wire connection numbers.

Control Wire Connection Reference Table.

Output Board Terminal	
V-Control F370314, F8206501 and F370447-6, etc.	
STF	6
STR	13
RH	18
RM	17
RL	16
COM	7
WE-6 Interface Board P/N: F370577, F0370446-xx	
J2A-30	7
J2A-31	17
J2A-32	6
J2A-33	18
J2A-34	16
J2A-35	13
EDC – Output Board P/N: F370433	
H2-7	18
H2-8	17
H2-9	16
H2-10	7
H2-11	13
H2-12	6

Table 44

AC Drive Diagnostics/Parameter Viewing

Human Interface Module (HIM or Parameter Unit)

Installation/Removal

The following are instructions for installing/removing the Human Interface Module (P/N F370597) on the drive for parameter viewing and basic troubleshooting. The parameter unit (F370597) and instructions (F232120) are included in the Parameter Kit (P/N F744501).

	CAUTION
<p>Users are prohibited from changing parameter values unless specifically instructed by the washer-extractor manufacturer. Modification to parameter values may present potential harmful operating conditions for both hardware and personnel.</p>	
W673	

	WARNING
<p>To reduce risk of electric shock, severe injury or death, allow machine power to remain off for three minutes minimum prior to working in and around AC drive. Proceed with caution.</p>	
W662	

Installing the HIM

1. Remove power from machine at main disconnect. Delay approximately three minutes.
2. Lower the hinged panel located below the HIM.

3. Slide blank panel cover toward base of drive and remove it. Place top edge of HIM approximately 1/2 inch from top edge of the cover. Push inward on bottom of HIM and slide HIM up (toward the top of the drive) into position.

Removing the HIM

1. Remove power from machine at main disconnect. Delay approximately three minutes.
2. Lower hinged panel located below HIM.
3. Press retaining lever located directly beneath HIM. Slide HIM downward and remove it from drive.
4. Reinstall blank panel cover. Close hinged panel.

External HIM Connection

The HIM unit can be installed using an adapter cable (P/N P370716). This method of attaching the HIM uses an external connector shown in *Figure 44*. The HIM unit operates in the same manner in this configuration.

NOTE: If the HIM is removed while the drive is powered, a communication fault (Serial Fault #10) will occur and the drive will be disabled. Cycle power to the drive to reset the fault condition.

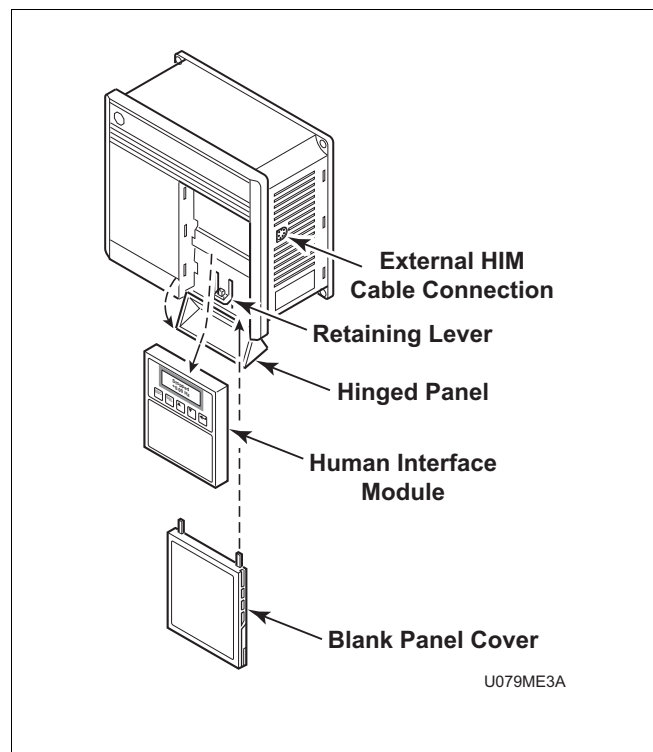

Figure 44

Allen-Bradley 1305-Series AC Drives

Human Interface Module (HIM) Operation

When power is first applied to the drive, the HIM will cycle through a series of displays. The displays will show drive name, HIM ID number, and communications status. Upon completion, the Status Display will be displayed. If a fault condition exists, it will appear on the display.

NOTE: If “Not Enabled” is displayed, the Enable input is not active. Check that the door is closed and locked, or that all necessary jumpers are in place. Refer to Section 2 of this manual.

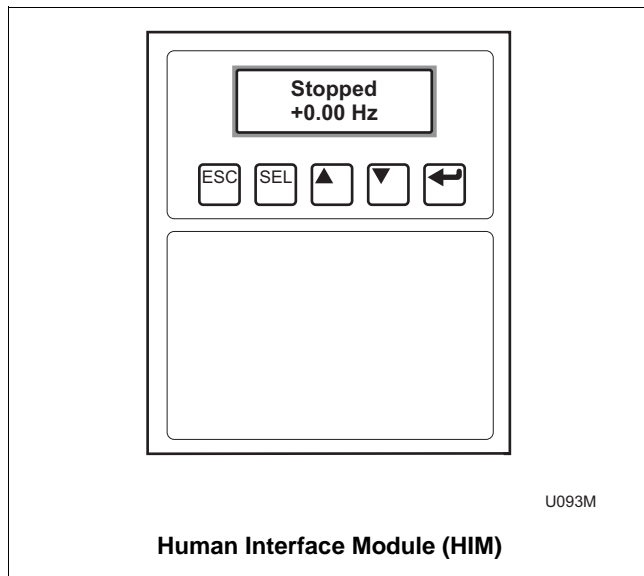





Figure 45

HIM – Key Explanation

 **Escape** key. Use to return to last or original position.

 **Select** key. Use to move cursor position.

 **Up** arrow key. Scroll up.

 **Down** arrow key. Scroll down.

 **Enter** key. Use to enter program selection or new parameter value.

The structure charts on the following pages illustrate how to navigate between the levels to obtain information necessary for troubleshooting for earlier and later HIM versions.

The HIM Structure is broken into 4 levels: Operator Level, Mode Level, Group Level (Main File for earlier versions), and Parameter Level.

In the Group Level (Main File for earlier versions), only three Groups are used: Metering, Faults, and Linear List. Most diagnostic information is found in Metering or Faults.

HIM Structure Chart – Series A 3.00, Series B 1.01 or Later Versions

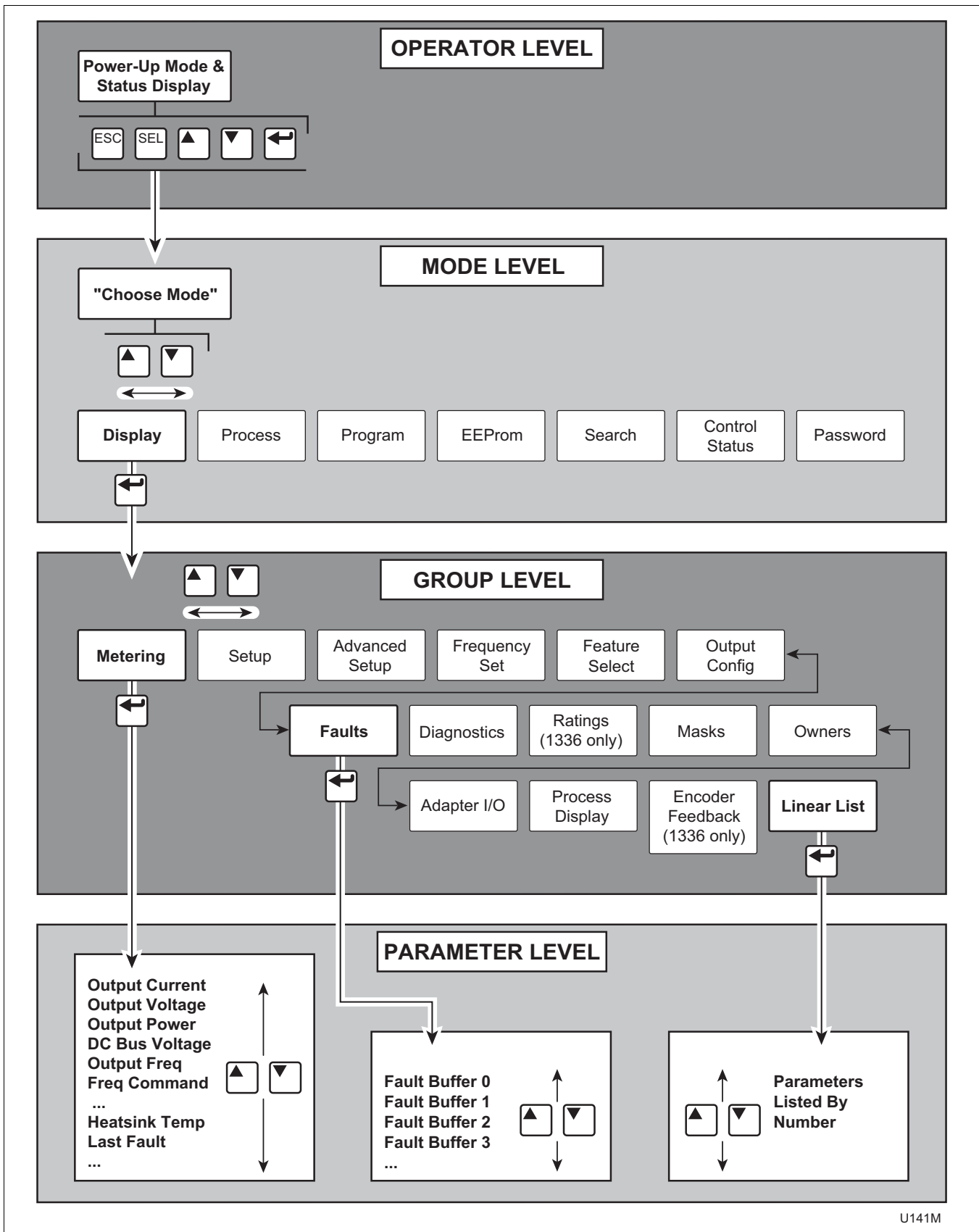

HIM Structure Chart – Earlier Versions

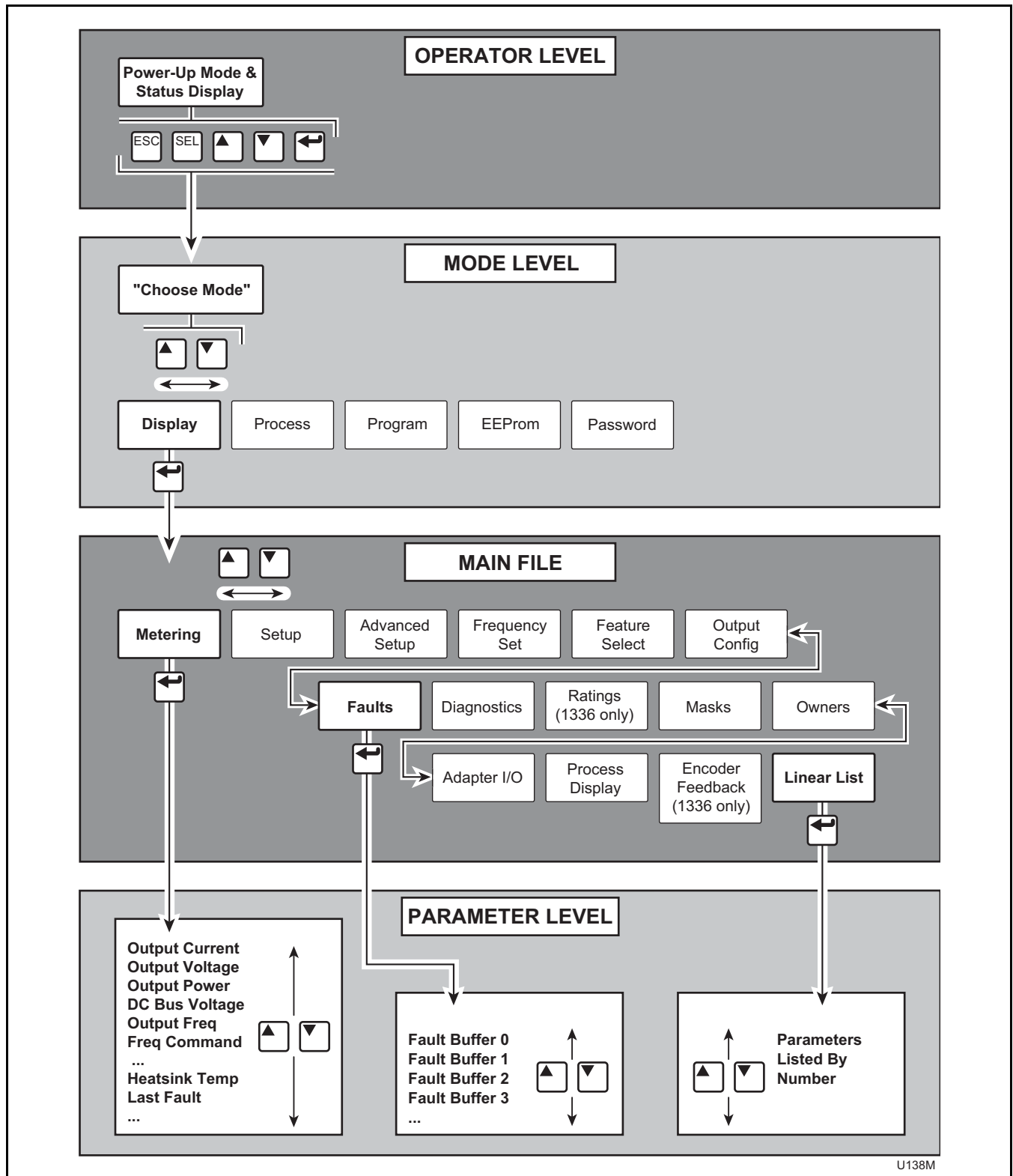

NOTE: The following programming instructions include information for two versions of HIMs (Human Interface Modules or parameter units). Refer to the nameplate information on the back of HIM to determine which programming information to use.

Displaying Metering Information

1. Install the HIM on the A-B drive.
2. Turn on machine power.
3. After three to five seconds of initialization, display will show the status display. If drive is in a faulted condition, fault will appear in display; otherwise, drive will read current status. Refer to examples below.

Faulted Drive

Fault Description
Fault Number

Examples of Faults

Serial Fault
F 10





Max Retries Fault
F 33

Normal Condition



Status of Drive
Frequency Commanded

Example of Normal Condition

Stopped
+0.00 Hz

4. Press any key to enter Mode Level,
     . Display will read:

Choose Mode
Display

5. Use the **Up** and **Down** arrow keys   to select “Display” if not displayed immediately.



6. Press the **Enter** key  to choose Group Level. Display will read:

Choose Group
Metering

For earlier HIM versions, press the **Enter** key



- For earlier HIM versions, press the **Enter** key  to choose Main File. Display will read:

Metering
Main File

7. Use the **Up** and **Down** arrow keys   to select “Metering” if not displayed immediately.

8. Press the **Enter** key  to choose Parameter Level. Display now shows parameters under the “Metering” Group.

Output Current
0.00 Amps

9. Use the **Up** and **Down** arrow keys   to select desired parameter display.

10. From this point, press the **Escape** key  to move display up one Level (i.e., press the **Escape** key three times to return to Operator Level).

Allen-Bradley 1305-Series AC Drives

Displaying Fault Buffers

1. Install the HIM on the A-B drive.
2. Turn on machine power.
3. After three to five seconds of initialization, display will show the status display. If drive is in a faulted condition, fault will appear in display; otherwise, drive will read current status. Refer to examples below.

Faulted Drive

Fault Description
Fault Number

Examples of Faults

Serial Fault
F 10





Max Retries Fault
F 33

Normal Condition



Status of Drive
Frequency Commanded

Example of Normal Condition

Stopped
+0.00 Hz

4. Press any key to enter Mode Level,
    . Display will read:

Choose Mode
Display

5. Use the **Up** and **Down** arrow keys   to select "Display" if not displayed immediately.

6. Press the **Enter** key  to choose Group Level. Display will read:



Choose Group
Faults

For earlier HIM versions, press the **Enter** key





to choose Main File. Display will read:

Faults
Main File

7. Use the **Up** and **Down** arrow keys   to select "Faults."
8. Press the **Enter** key  to choose Parameter Level. Display now shows parameters under the "Faults" Group.

Fault Buffer 0
48

9. Use the **Up** and **Down** arrow keys   to select desired fault buffer display.
10. From this point, press the **Escape** key  to move display up one Level (i.e., press the **Escape** key three times to return to Operator Level).

Displaying Linear List of Parameters

1. Install the HIM on the A-B drive.
2. Turn on machine power.
3. After three to five seconds of initialization, display will show the status display. If drive is in a faulted condition, fault will appear in display; otherwise, drive will read current status. Refer to examples below.

Faulted Drive

Fault Description
Fault Number

Examples of Faults

Serial Fault
F 10

Max Retries Fault
F 33

Normal Condition



Status of Drive
Frequency Commanded

Example of Normal Condition

Stopped
+0.00 Hz

4. Press any key to enter Mode Level,
     . Display will read:

Choose Mode
Display

5. Use the **Up** and **Down** arrow keys   to select "Display" if not displayed immediately.



6. Press the **Enter** key  to choose Group Level. Display will read:

Choose Group
Linear List

For earlier HIM versions, press the **Enter** key



-  to choose Main File. Display will read:

Linear List
Main File

7. Use the **Up** and **Down** arrow keys   to select "Linear List."

8. Press the **Enter** key  to choose Parameter Level. Display now shows all parameters in numerical order.

Output Voltage
0 VIts 1

9. Use the **Up** and **Down** arrow keys   to select desired parameter display.

10. From this point, press the **Escape** key  to move display up one Level (i.e., press the **Escape** key three times to return to Operator Level).

Fault Display and Troubleshooting Information

This section provides information to guide users in understanding drive fault conditions and general troubleshooting procedures for Allen-Bradley drives. Included is a listing and description of the various drive faults with possible solutions, when applicable. For any questions regarding fault conditions, consult with the factory.

Each drive is equipped with a fault indicator light which illuminates when a fault condition exists.

Fault Code Identification

When the A-B 1305 drives encounter a fault, an LED is illuminated. Refer to *Figure 46* and *Figure 45*, respectively. These LEDs are viewed with the front cover removed. To view the specific fault description, the HIM (parameter unit) must be installed. Refer to HIM installation and operation.

Once the HIM is installed, the current fault condition is displayed as shown below with the corresponding fault code. Cross reference the number in *Table 45* for fault identification and possible corrective action.



In addition, A-B 1305 fault codes are stored in a fault buffer with the capability to store up to four fault codes. If more than four faults are identified, the least recent fault is deleted to make room for the additional fault. "Fault Buffer 0" is the most recent fault. The faults are viewed using a HIM as shown below. Refer to HIM installation and operation

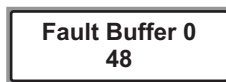

The fault parameters are identified as follows:

"Last Fault"	Parameter #4	Most Recent
"Fault Buffer 0"	Parameter #86	Most Recent (same as Parameter #4)
"Fault Buffer 1"	Parameter #87	—
"Fault Buffer 2"	Parameter #88	—
"Fault Buffer 3"	Parameter #89	Least Recent

Clearing Faults

When a fault occurs, the cause must be corrected before the fault can be cleared. Resetting a fault will not correct the cause of the fault condition. After corrective action has been taken, simply cycling power to the drive will clear the fault.

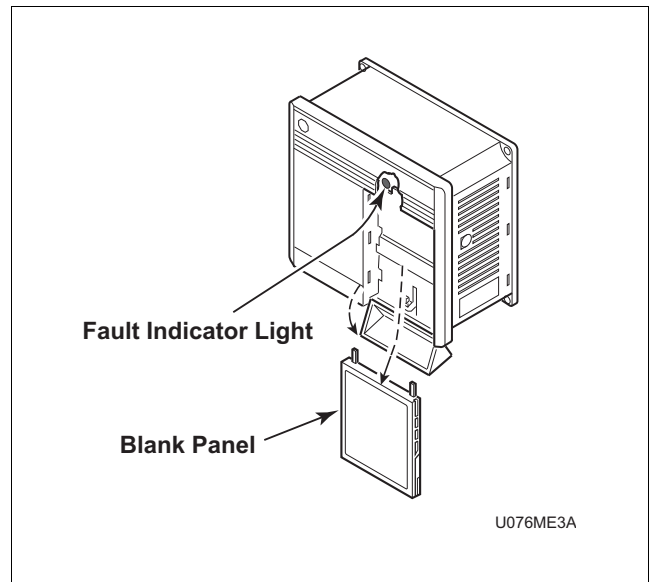

Figure 46

Allen-Bradley Drive Fault Codes

Allen-Bradley Drive Fault Codes			
	Fault	Description	Corrective Action/ Remarks
03	Power Loss Fault	DC Bus voltage remains below 85% nominal for longer than .5 seconds.	Monitor incoming AC line for low voltage or line power interruption.
04	Under Voltage Fault	DC Bus voltage fell below minimum.	Monitor AC incoming AC line for low voltage or line power interruption.
05	Over Voltage Fault	DC Bus maximum voltage exceeded.	Monitor the AC line for high line voltage or transient conditions. High voltage can result from motor regeneration. Buck transformer may be required.
06	Motor Stall	Motor has stalled. Motor load is excessive.	Check motor wiring and connection terminals. Check wash basket freedom of movement and excess belt tension.
07	Motor Overload Fault	Internal electronic overload trip. Excessive motor load exists.	Check motor wiring and connection terminals. Check wash basket freedom of movement and excess belt tension.
08	Over Temperature Fault	Excessive heat detected by heatsink transducer.	Clear blocked or dirty heatsink fins. Check ambient temperature. Check for blocked or nonoperating fan.
10	Serial Fault	Drive lost communication with controlling device.	HIM removed while power applied, cycle power to clear.
12	Overcurrent Fault	Overcurrent detected in instantaneous hardware trip circuit.	Check short circuit at the controller output or excessive load conditions at motor.
22	Controller Reset Fault	Stop input not present.	Check stop input into control terminal board. Close door and ensure any jumpers are placed correctly.
32	EEPROM Fault	EEProm has invalid data.	Consult the factory for further instructions.
33	Max Retries Fault	Controller failed to reset fault within the number of retries.	Fault exists that must be corrected before further operation. Check "Fault Buffer 1" on 1305 and 1336 for specific fault that triggered max retries fault.
38	Phase U Fault	Phase-to-ground fault detected between controller and motor in Phase U.	Check wiring between the drive and motor. Check for grounded phase.

Table 45 (continued)

Table 45 (continued)

Allen-Bradley Drive Fault Codes (continued)			
	Fault	Description	Corrective Action Remarks
39	Phase V Fault	Phase to ground fault detected between controller and motor in Phase V.	Check wiring between the drive and motor. Check for grounded phase.
40	Phase W Fault	Phase to ground fault detected between controller and motor in Phase W.	Check wiring between the drive and motor. Check for grounded phase.
41	UV Short Fault	Excessive current has been detected between two controller output terminals.	Check motor and external wiring to the controller output terminals for shorted condition.
42	UW Short Fault	Excessive current has been detected between two controller output terminals.	Check motor and external wiring to the controller output terminals for shorted condition.
43	VW Short Fault	Excessive current has been detected between two controller output terminals.	Check motor and external wiring to the controller output terminals for shorted condition.
44	IPM Current Fault	Internal power module overcurrent limit exceeded.	Check for short circuit at the drive output or excessive load conditions at the motor, specifically cable capacitance to ground.
45	IPM Overtemp Fault	Internal power module thermal limit exceeded.	Check for blocked or dirty heatsink fins. Check ambient air. Check fan operation or filter blockage.
48	Reset to Default Values	Parameters were reset to the factory default values.	Verify and re-load the desired parameters.

Table 45

Troubleshooting Suggestions

Important Considerations

- Drive cooling is extremely important to the overall service life of the product. Extreme care should be used to keep cooling air paths clean. Drive cabinet enclosures have been designed to optimize cooling. Keep cabinet doors closed and panels installed to maintain proper operation.
- Resetting a fault will not correct the cause of the fault condition. Corrective action must be taken prior to resetting a fault. Many drive error codes are reset by cycling power to the drive. The fault may not reappear until drive operation is initiated.
- Drive to motor wiring is critical to proper drive operation. Loose or bad connections can generate heat and increase current output from drive. These problems can manifest themselves in operation by many fault codes indicating overcurrent condition and maximum retries fault.

Problem/Corrective Action

Problem:

Wash basket does not rotate.

Corrective Action

1. Ensure computer control display on washer is showing proper operation.
2. Check power circuit, supply voltage, fuses and disconnects.
3. Verify drive to motor wires are damage free, properly connected and torqued to specifications.
4. Check belt tension and condition.
5. Verify no mechanical problems exist (i.e., binding, motion restriction).
6. Check control input signals. Refer to applicable table of inputs.

Problem:

Drive started but wash basket is not rotating.

Corrective Action

1. Verify drive to motor wires are damage-free, properly connected and torqued to specifications.
2. Verify no mechanical problems exist (i.e., binding, motion restriction).
3. Check control input signals. Refer to applicable table of inputs.

Problem:

Wash basket not accelerating properly.

Corrective Action

1. Verify drive to motor wires are damage-free, properly connected and torqued to specifications.
2. Verify speed selection control wire connections. Refer to applicable table.

Problem:

Drive gives Serial Fault (F10) when HIM is removed from the drive.

Corrective Action

1. Cycle power to drive to clear the fault.

When a HIM is disconnected with the drive powered, communication is lost and a fault results. Always remove power from the drive prior to HIM or PKM removal or installation.

Problem:

HIM displays “Pin ID Error” or “Network Error.”

Corrective Action

1. Place the HIM directly on the drive.

This communication error with the drive may be the result of a bad cable or connector that establishes communication with the HIM.

Problem:

HIM displays “Not Enabled.”

Corrective Action

1. Verify the jumper connecting the control terminal “Enable” to “Common” is present and is not loose.

This connection must be present to enable the drive.

Allen-Bradley 1336-Series AC Drives

Installation/Wiring

	CAUTION
<p>An incorrectly installed system can result in component damage or reduction in product life. The most common causes are:</p> <ol style="list-style-type: none"> 1. Wiring AC line to drive output or control terminals. 2. EXTERNAL voltage application to control terminals. 3. Incorrect or inadequate AC supply. <p>Contact factory for assistance with application or wiring.</p>	
W660	

Input Power Conditioning

The drive is suitable for direct connection to input power within the rated voltage of the drive. Listed in *Table 46* are certain input power conditions which may cause component damage or reduction in product life. If any of the conditions exist, as described in *Table 46*, install one of the devices listed under the heading *Corrective Action* on the line side of the drive.

IMPORTANT: Only one device per branch circuit is required. It should be mounted closest to the branch and sized to handle the total current of the branch circuit.

Input Power Condition	Corrective Action
Low Line impedance (less than 1% line reactance)	<ul style="list-style-type: none"> • Install Line Reactor • or Isolation Transformer • or Bus Inductor – 5.5 & 11kW (7.5 & 15 HP) drives only
Greater than 120 kVA supply transformer	
Line has power factor correction capacitors	<ul style="list-style-type: none"> • Install Line Reactor • or Isolation Transformer
Line has frequent power interruptions	
Line has intermittent noise spikes in excess of 6000V (lightning)	
Phase to ground voltage exceeds 125% of normal line to line voltage	<ul style="list-style-type: none"> • Remove MOV jumper to ground. • or Install Isolation Transformer with grounded secondary if necessary
Ungrounded distribution system	
240V open delta configuration (stinger leg) ⁽¹⁾	<ul style="list-style-type: none"> • Install Line Reactor
<p>⁽¹⁾ For drives applied on an open delta with a middle phase grounded neutral system, the phase opposite the phase that is tapped in the middle to the neutral or earth is referred to as the “stinger leg,” “high leg,” “red leg,” etc. This leg should be identified throughout the system with red or orange tape on the wire at each connection point. The stinger leg should be connected to the center Phase B on the reactor.</p>	

Table 46

Electrical Interference

EMI

Careful attention must be given to the arrangement of power and ground connections to the drive to avoid interference with nearby sensitive equipment. Be sure to replace all ground connections to their appropriate locations.

RFI

Drives can be installed with an RFI filter, which controls high-frequency conducted emissions into the main supply lines.

Where it is essential that very low emission levels must be achieved or if conformity with standards is required, the optional RFI filter may be present. *Figure 47* displays an electrical schematic for various RFI configurations. *Table 47* shows associated RFI filter part numbers.

	CAUTION
<p>ELECTRIC SHOCK HAZARD! Service and maintenance to be performed only by an authorized technician. Disconnect power before opening any access panels.</p>	
W661	

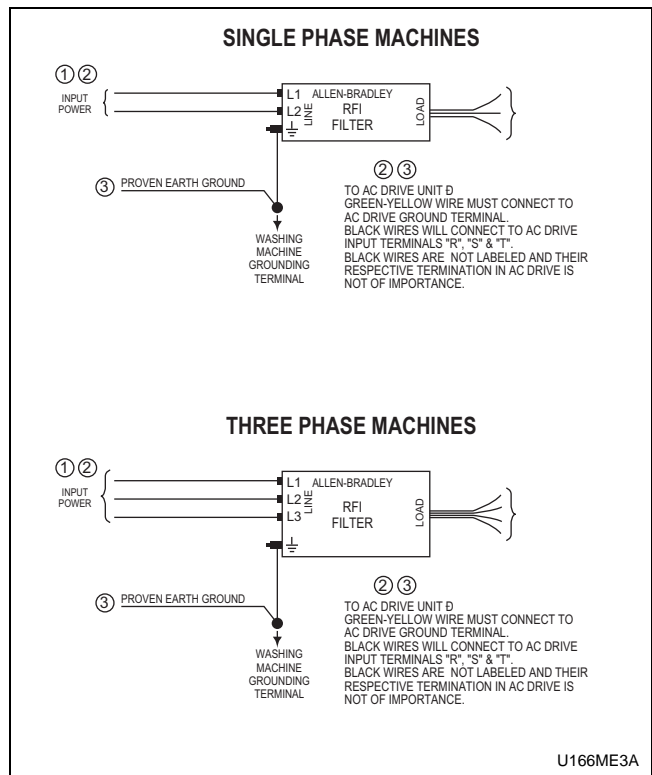



Figure 47

RFI Filter Part Number Information			
Drive P/N	Drive Catalog	Machine Voltage	Filter P/N
370838	1336-AQF50	200-240V/1 Phase	Not Available
370838	1336-AQF50	200-240V/3 Phase	330274
370835	1336-BRF50	380-480V/3 Phase	330273
370837	1336-AQF100	200-240V/3 Phase	Not Available
370834	1336-BRF100	380-480V/3 Phase	330274
370828	1336-AO15	200-240V/3 Phase	330268
370825	1336-BO25	380-480V/3 Phase	330268

Table 47

Terminal Block Access

	WARNING
<p>To reduce risk of electric shock, severe injury or death, allow machine power to remain off for three minutes minimum prior to working in and around AC drive. Proceed with caution.</p>	
<small>W662</small>	

The following information illustrates the terminal block designations for each of the drive models.

To access the power and control terminal blocks, perform the following procedure:

1. Remove power from machine at main disconnect. Verify power light is off.
2. Loosen the front cover fastener located at the base of the front cover. Refer to *Figure 48*.
3. Lift off cover.

NOTE: HIM unit extension unit cable inserts into separate port for 1305 and 1336 A-B drives.

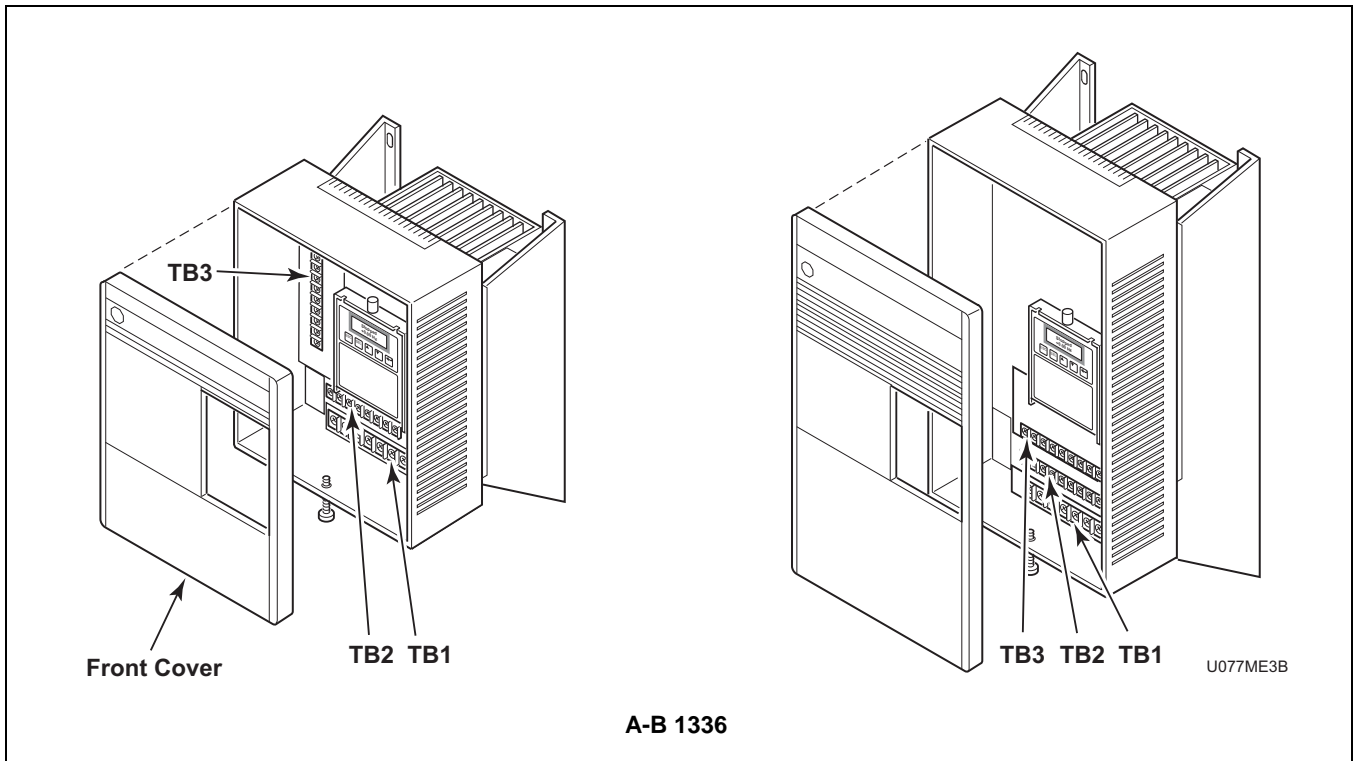

Figure 48

Power Terminal Block Description

Input and output connections are performed through terminal block TB1. Refer to *Figure 49*.

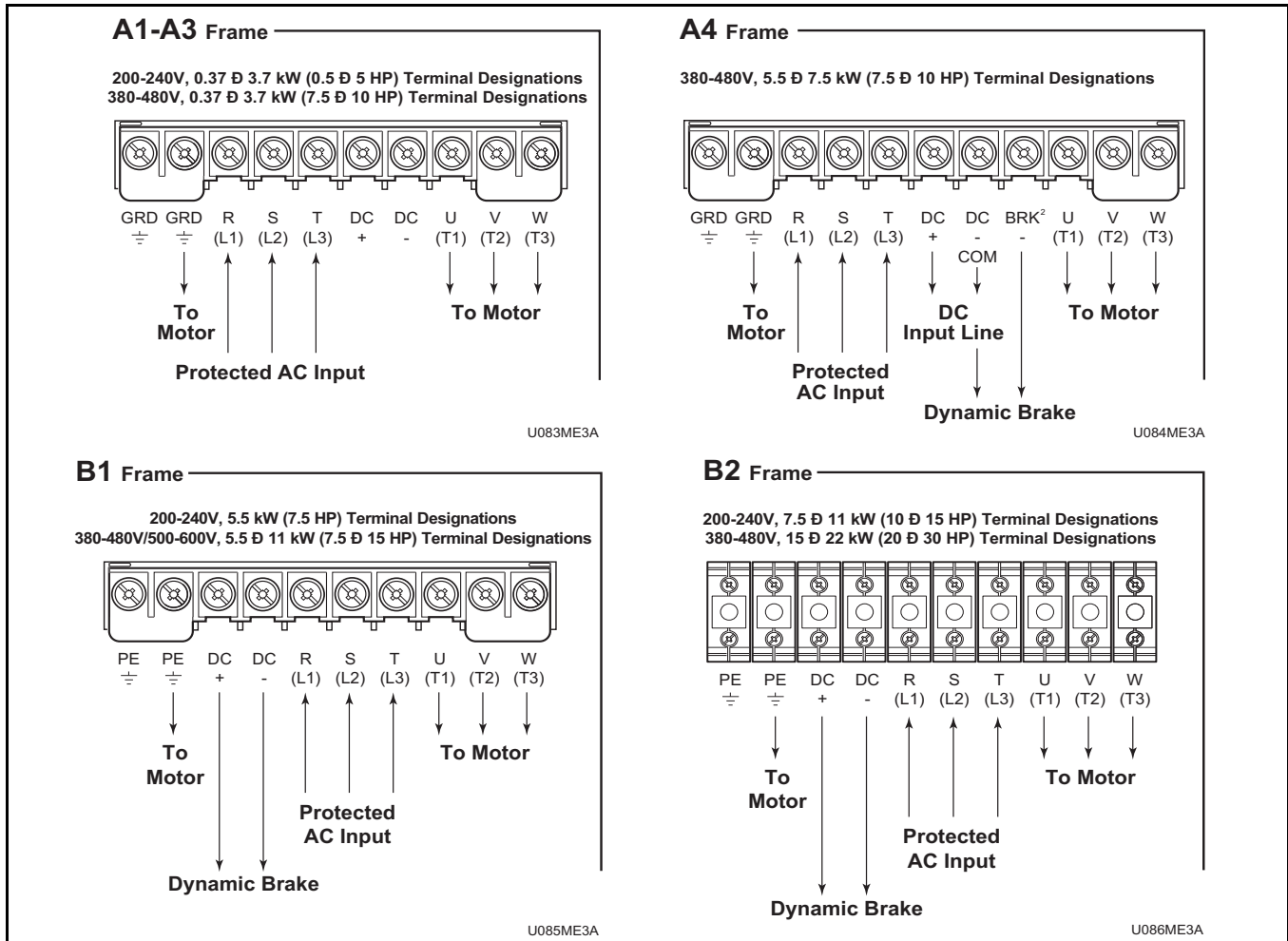

Figure 49

Power Block Terminal (TB1)

Terminal	Description
PE	Potential Earth Ground
R (L1), S (L2), T (L3)	AC Line Input Terminals
+DC, -DC	DC Bus Terminals
U (T1), V (T2), W (T3)	Motor Connection

Table 48

Torque Specifications

Drive Frame Size	Max./Min. Wire Size* mm ² (AWG)	Maximum Torque N-m (lb.-in.)
A1-A4	5.3/0.8 (10/18)	1.81 (16)
B1	8.4/0.8 (8/18)	1.81 (16)
B2	13.3/0.5 (6/20)	1.70 (15)

* Wire sizes given are maximum/minimum sizes that TB1 will accept – these are not recommendations.

Table 49

Control Terminal Blocks Description and Control Logic

Control terminal functions are unique to each Allen-Bradley Drive. Each drive's control terminal is addressed independently.

Control Terminal (TB2/TB3) Function

	WARNING
<p>To reduce risk of electric shock, severe injury or death, allow machine power to remain off for three minutes minimum prior to working in and around AC drive. Proceed with caution.</p>	
W662	

	WARNING
<p>The controller is supplied with an internal 5V supply. Dry contacts or open collectors are required for discrete control inputs. If an external voltage is applied, component failure could occur.</p>	
W670	

NOTE: Do not connect drive common terminals (TB2 or TB3) to ground. There must be no ground potential difference between source and drive.

Input Mode Parameter

The control terminal functions are determined in part by the Input Mode parameter #21. Changing this parameter affects the function of some terminals. All machines equipped with A-B 1336 drives use Input Mode "12".

NOTE: If the Input Mode is changed, power must be cycled to the drive for the change to take effect.

Speed Selection

Motor speeds are controlled by solid state or mechanical switch closure inputs to SW1, SW2, and SW3 in conjunction with STR and STF (direction) inputs. Refer to *Figure 50* and *Table 50*.

Table 50 designates the preset speed selection based on the inputs to the control terminals. A disconnected control terminal will seek the high control voltage condition (approx. 5 Volts DC). To activate a control input (i.e., SW1, SW2, etc.), the terminal is connected to a common terminal (TB3-21, TB3-25, or TB3-29) to lower the control voltage to a low condition (less than 1 Volt DC).

The Input Status' display of 1s and 0s represents the drive's display of parameter #55. These inputs can be viewed in the status display with a Human Interface Module (HIM or parameter unit). Parameter #55 displays the Input Status. When voltage is *high* (inactive) for an input, the status display will read "0" (Logic 0). When voltage is *low* (active) for an input, the status display will read "1" (Logic 1).

Table 50 contains the correct display value for each function. The sixth display digit from the left in Input Status parameter does not correspond to a control input function. Refer to *Table 50*.

NOTE: The Preset Speed logic is specific to the type of computer the machine is equipped with (i.e., WE-6 or V-Computer).

Balance Output

The AC drive Balance Output is transmitted to the machine controller by the closure of an on-board normally open mechanical relay shown in *Figure 50*. This action occurs at distribution speed connecting TB3-16 and TB3-17 when the drive detects an acceptable balance condition.

	CAUTION
<p>MACHINE DAMAGE AND/OR PERSONAL INJURY. Balance output terminals TB2-16 and TB2-17 should never be jumpered. This action will force machine beyond designed tolerances.</p>	
W666	

Stop Input (Door Interlock /Out-of-Balance Switch)

The Stop Input function is machine dependent. The input is used in some machines to disable the drive in case of an excessive out-of-balance condition; in others, the input is used to disable the drive when the door is open. Refer to the applicable electrical schematic to see the correct wiring of this input. The control inputs must be removed and reapplied to the drive for motion after a STOP input has been interrupted.

Jumpered Inputs

Carefully review electrical schematics when replacing a drive. Some machine models jumper the STOP, Motor Temp Input, and/or ENABLE inputs to the drive (refer to *Figure 50*).

NOTE: Wire or metal clip jumpers may be used and can be easily overlooked during a replacement.

	CAUTION
MACHINE DAMAGE AND/OR PERSONAL INJURY. Never jumper inputs if not previously configured with jumpers as identified on the applicable electrical schematic. Jumpering these inputs will override safety features.	
<small>W665</small>	

Fault Indicator Light

The A-B 1336 is equipped with a mechanical relay which transitions when a drive fault occurs. Some machines use this contact for lighting an external indicator light. This relay is used to switch the neutral (AC common) lead to the fault indicator light and connects between TB3-13 and TB3-14. Refer to *Figure 50*.

Motor Thermal Protection

On some machines the motor is equipped with a thermal protection switch. Switch inputs are placed between TB3-24 and TB3-25. If an over-temp occurs, the switch is opened triggering a drive fault indicator light to illuminate. If no thermal switch is present, the connections are jumpered. This input can be viewed in the Input Status parameter. For normal operation, logic input for "Motor Temp" remains "1". If the logic input is "0", a jumper is missing or an over-temp condition exists with the motor.

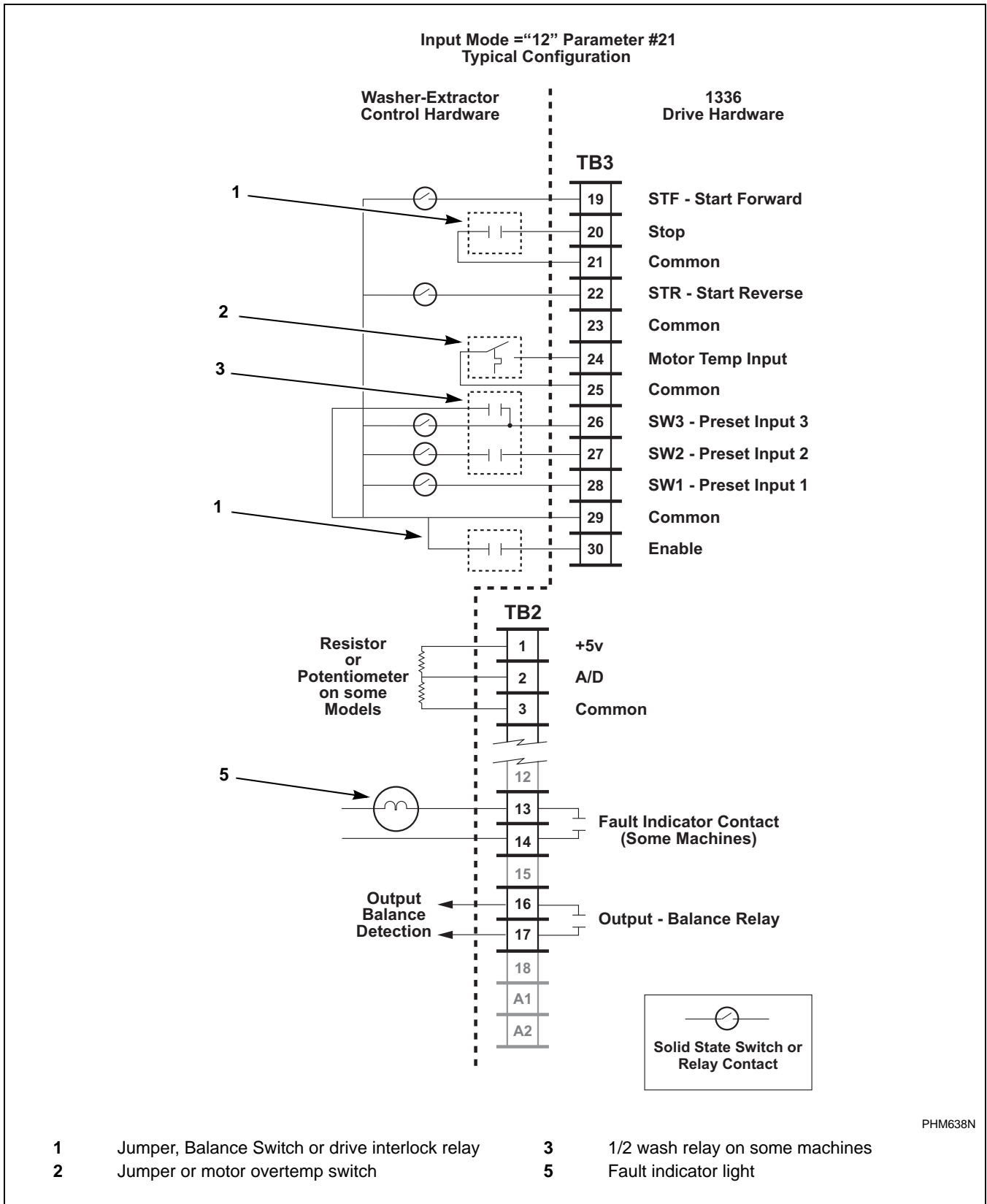

Figure 50

PHM638N

Control Terminal Block Designations

Terminal Number	Signal	Machine Use
TE	True Earth	Not Used
1, 2, 3	External Speed Pot	Select Machines Only
4	Signal Common	Specialty Machines Only
5	0 – 10V DC Input	Specialty Machines Only
6	4 – 20 mA Input	Specialty Machines Only
7, 8	Pulse Input for Frequency	Specialty Machines Only
9	Analog Output	Not Used
10, 11	Programmable Contact	Not Used
11, 12	Run Contact	Not Used
13, 14	Fault Contact NO	Fault Indicator Light (Some Machines)
14, 15	Fault Contact NC	Not Used
16, 17	Alarm Contact NO	Balance Relay
17, 18	Alarm Contact NC	Not Used
A1, A2	Future Use	Not Used
19, 29	STF	Forward Motion
20, 21	Stop	Drive Balance Switch Interlock Relay or Jumper
21	Common	
22, 29	STR	Reverse Motion
23, 21	Input	Not Used
24, 25	Input	Motor Thermal Switch (Some Machines)
25	Common	
28, 29	SW1	Preset Speed Input #1
27, 29	SW2	Preset Speed Input #2
26, 29	SW3	Preset Speed Input #3
29	Common	
30, 29	Enable	Balance Switch, Drive Interlock or Jumper

Table 50

Torque Specifications

Max/Min Wire Size mm ² (AWG)	Maximum Torque N-m (lb-in)
2.1/0.3 (14/22)	1.36 (12)

Table 51

Allen-Bradley 1336-Series AC Drives

Allen-Bradley 1336-Series 1336-Series Drive Control Logic Chart

Pocket Hardmount WE-6 Control - Design 5 and Earlier

H – Signal Voltage High (approximately 5V DC) L – Signal Voltage Low (less than 1V DC)								0 = No Signal Received 1 = Signal Received							
		SW2	SW1	SW3	Rev	Stop	Fwd	Input Status – Parameter #55							
DC Volt Meter Red Probe Terminal Location		27	28	26	22	20	19								
DC Volt Meter Black Probe Terminal Location		29	29	29	29	29	29								
Action	Frequency Preset Parameter #	Terminal #27 (SW2)	Terminal #28 (SW1)	Terminal #26 (SW3)	Terminal #22 (STR)	Terminal #20 (Stop)	Terminal #19 (STF)	SW2	SW1	SW3	Auxiliary	Rev (STR)	Not Used	Stop	Fwd (STF)
Idle	N/A	H	H	H	H	L/H	H	0	0	0	1	0	0	0/1	0
1/2 Wash Speed Forward	73	H	H	L	H	L	L	0	0	1	1	0	0	1	1
1/2 Wash Speed Reverse	73	H	H	L	L	L	H	0	0	1	1	1	0	1	0
Wash Speed Forward	28	L	H	H	H	L	L	1	0	0	1	0	0	1	1
Wash Speed Reverse	28	L	H	H	L	L	H	1	0	0	1	1	0	1	0
Distribution Speed	27	H	L	H	H	L	L	0	1	0	1	0	0	1	1
Medium Extract/Spray Rinse	75	L	H	L	H	L	L	1	0	1	1	0	0	1	1
High 1 Extract	74	H	L	L	H	L	L	0	1	1	1	0	0	1	1
High 2 Extract	29	L	L	H	H	L	L	1	1	0	1	0	0	1	1
High 3 Extract	76	L	L	L	H	L	L	1	1	1	1	0	0	1	1

Pocket Hardmount WE-6 Control Designs 6, 7 and 8

H – Signal Voltage High (approximately 5V DC) L – Signal Voltage Low (less than 1V DC)								0 = No Signal Received 1 = Signal Received							
		SW2	SW1	SW3	Rev	Stop	Fwd	Input Status – Parameter #55							
DC Volt Meter Red Probe Terminal Location		27	28	26	22	20	19								
DC Volt Meter Black Probe Terminal Location		29	29	29	29	29	29								
Action	Frequency Preset Parameter #	Terminal #27 (SW2)	Terminal #28 (SW1)	Terminal #26 (SW3)	Terminal #22 (STR)	Terminal #20 (Stop)	Terminal #19 (STF)	SW2	SW1	SW3	Auxiliary	Rev (STR)	Not Used	Stop	Fwd (STF)
Idle	N/A	H	H	H	H	L/H	H	0	0	0	1	0	0	0/1	0
1/2 Wash Speed Forward	73	H	H	H	H	L	L	0	0	0	1	0	0	1	1
1/2 Wash Speed Reverse	73	H	H	H	L	L	H	0	0	0	1	1	0	1	0
Wash Speed Forward	28	L	H	H	H	L	L	1	0	0	1	0	0	1	1
Wash Speed Reverse	28	L	H	H	L	L	H	1	0	0	1	1	0	1	0
Distribution Speed	27	H	L	H	H	L	L	0	1	0	1	0	0	1	1
Medium Extract/Spray Rinse	75	L	H	L	H	L	L	1	0	1	1	0	0	1	1
High Extract Speed 1	74	H	L	L	H	L	L	0	1	1	1	0	0	1	1
High Extract Speed 2	29	H	L	L	L	L	H	0	0	1	1	0	0	1	1
High Extract Speed 3 (Default)	76	H	H	L	H	L	L	1	1	1	1	0	0	1	1
High Extract Speed 3 (Maximum)	76	H	H	L	H	L	L	0	0	1	1	0	0	1	1

Table 52

1336-Series Drive Control Logic Chart

**Cabinet Freestanding
WE-6 Control**

H – Control Voltage High (approximately 5 V DC) L – Control Voltage Low (less than 1 V DC)								0 = No Signal Received 1 = Signal Received							
		SW2	SW1	SW3	Rev	Stop	Fwd	Input Status - Parameter #55							
DC Volt Meter Red Probe Terminal Location		27	28	26	22	20	19								
DC Volt Meter Black Probe Terminal Location		29	29	29	29	29	29								
Action	Frequency Preset Parameter	Terminal #27 (SW2)	Terminal #28 (SW1)	Terminal #26 (SW3)	Terminal #22 (STR)	Terminal #20 (Stop)	Terminal #19 (STF)	SW2	SW1	SW3	Auxiliary	Rev (STR)	Not Used	Stop	Fwd (STF)
Idle	N/A	H	H	H	H	L/H	H	0	0	0	1	0	0	0/1	0
Half-Wash Speed Forward	73	H	H	L	H	L	L	0	0	1	1	0	0	1	1
Half-Wash Speed Reverse	73	H	H	L	L	L	H	0	0	1	1	1	0	1	0
Wash Speed Forward	28	L	H	H	H	L	L	1	0	0	1	0	0	1	1
Wash Speed Reverse	28	L	H	H	L	L	H	1	0	0	1	1	0	1	0
Distribution Speed	27	H	L	H	H	L	L	0	1	0	1	0	0	1	1
Medium Extract	75	L	H	L	H	L	L	1	0	1	1	0	0	1	1
High 1 Extract	74	H	L	L	H	L	L	0	1	1	1	0	0	1	1
High 2 Extract	29	L	L	H	H	L	L	1	1	0	1	0	0	1	1
High 3 Extract	76	L	L	L	H	L	L	1	1	1	1	0	0	1	1

Table 53

Allen-Bradley 1336-Series AC Drives

1336-Series Drive Control Logic Chart

Cabinet Hardmount A Control and V Control

H – Control Voltage High (greater than 10V DC) L – Control Voltage Low (less than 1V DC)								0 = No signal received 1 = Signal received							
		SW2	SW1	SW3	Rev	Stop	Fwd	Input Status – Parameter 55							
DC Volt Meter Red Probe Terminal Location		27	28	26	22	20	19								
DC Volt Meter Black Probe Terminal Location		29	29	29	29	29	29								
Action	Frequency Preset Parameter #	Terminal #27 (SW2)	Terminal #28 (SW1)	Terminal #26 (SW3)	Terminal #22 (STR)	Terminal #20 (Stop)	Terminal #19 (STF)	SW2	SW1	SW3	Auxiliary	Rev (STR)	Not Used	Stop	Fwd (STF)
Idle	N/A	H	H	H	H	L/H	H	0	0	0	1	0	0	0/1	0
1/2 Wash Speed Forward	73	H	H	L	H	L	L	0	0	1	1	0	0	1	1
1/2 Wash Speed Reverse	73	H	H	L	L	L	H	0	0	1	1	1	0	1	0
Wash Speed Forward	28	L	H	H	H	L	L	1	0	0	1	0	0	1	1
Wash Speed Reverse	28	L	H	H	L	L	H	1	0	0	1	1	0	1	0
Distribution Speed	27	H	L	H	H	L	L	0	1	0	1	0	0	1	1
Spin 1	75	L	H	L	H	L	L	1	0	1	1	0	0	1	1
Spin 2	29	L	L	H	H	L	L	1	1	0	1	0	0	1	1
Spin 3	74	H	L	L	H	L	L	0	1	1	1	0	0	1	1

Table 54

Computer Output Boards

Connections identified on these figures set speed and direction of the drive.

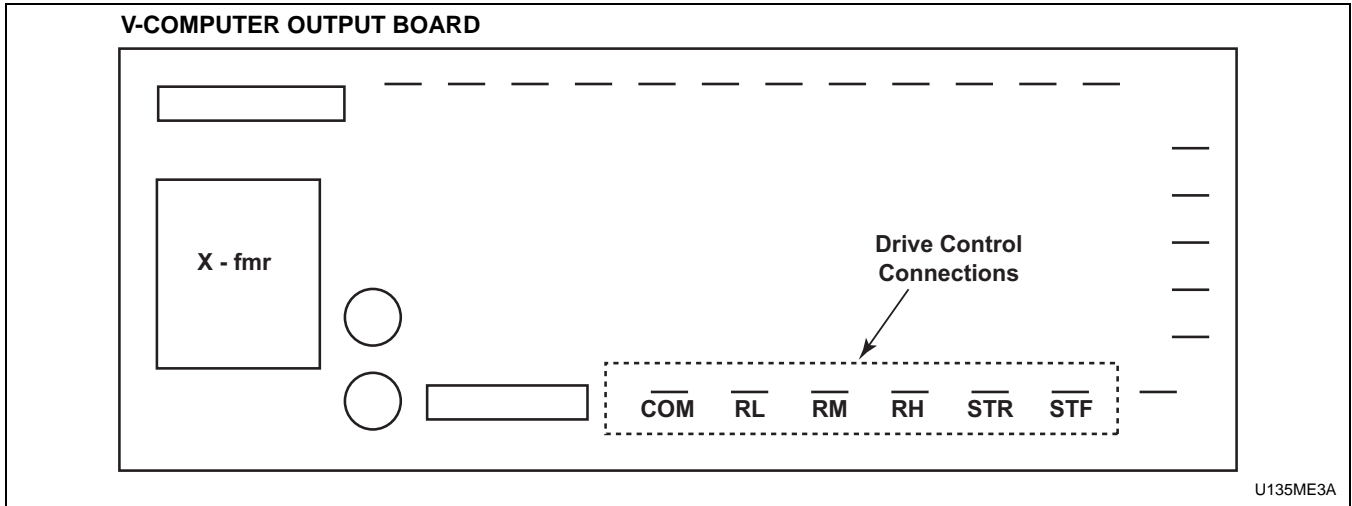

Figure 51

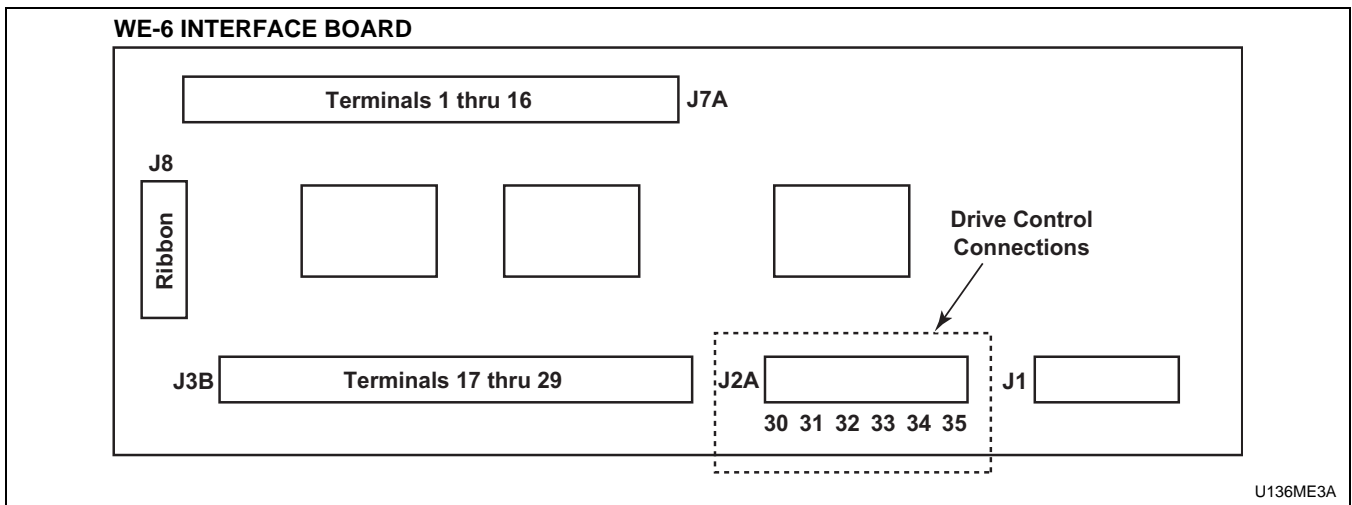

Figure 52

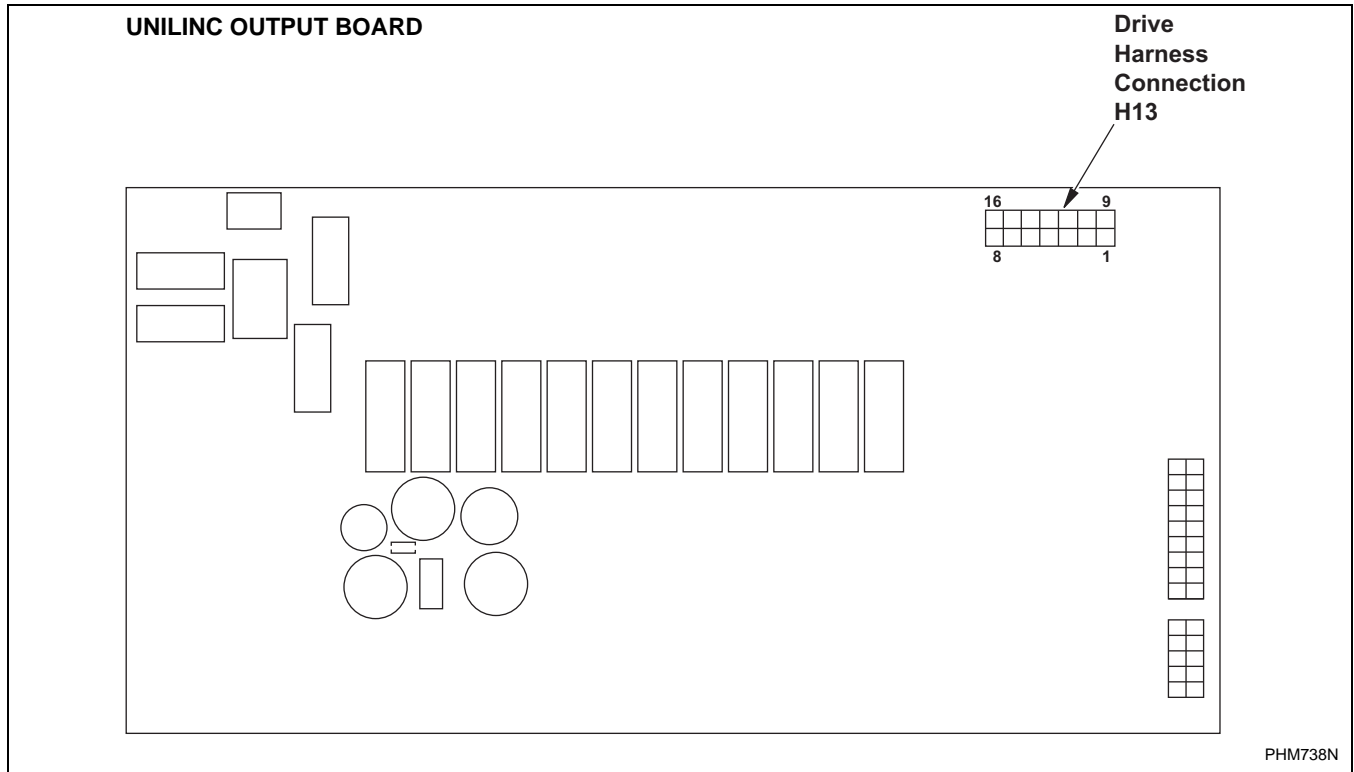

Figure 53

Control Wire

During troubleshooting, if the wire path between the control board and the drive is uncertain, refer to *Table 55* for wire connection numbers.

Control Wire Connection Reference Table.

Output Board Terminal	
V-Control F370314, F8206501 and F370447-6, etc.	
STF	19
STR	22
RH	28
RM	27
RL	26
COM	29
WE-6 Interface Board P/N: F370577, F0370446-xx	
J2A-30	29
J2A-31	27
J2A-32	19
J2A-33	26
J2A-34	28
J2A-35	22
UniLinc Control– Output Board F8108001	
H13-2	29
H13-3	28
H13-4	27
H13-5	26
H13-6	22
H13-7	19

Table 55

AC Drive Diagnostics/Parameter Viewing

Human Interface Module (HIM or Parameter Unit)

Installation/Removal

The following are instructions for installing/removing the Human Interface Module (P/N F370597) on the drive for parameter viewing and basic troubleshooting. The parameter unit (F370597) and instructions (F232120) are included in the Parameter Kit (P/N F744501).

	CAUTION
<p>Users are prohibited from changing parameter values unless specifically instructed by the washer-extractor manufacturer. Modification to parameter values may present potential harmful operating conditions for both hardware and personnel.</p>	
W673	

	WARNING
<p>To reduce risk of electric shock, severe injury or death, allow machine power to remain off for three minutes minimum prior to working in and around AC drive. Proceed with caution.</p>	
W662	

Installing the HIM

1. Remove power from machine at main disconnect. Delay approximately three minutes.
2. Remove the front cover.
3. Slide blank panel cover toward base of drive and remove it. Place top edge of HIM approximately 1/2 inch from top edge of the cover. Push inward on bottom of HIM and slide HIM up (toward the top of the drive) into position.

Removing the HIM

1. Remove power from machine at main disconnect. Delay approximately three minutes.
2. Remove front cover.
3. Press retaining lever located directly beneath HIM. Slide HIM downward and remove it from drive.
4. Replace front cover.

External HIM Connection

The HIM unit can be installed using an adapter cable (P/N P370716). This method of attaching the HIM uses an external connector shown in *Figure 54*. The HIM unit operates in the same manner in this configuration.

NOTE: If the HIM is removed while the drive is powered, a communication fault (Serial Fault #10) will occur and the drive will be disabled. Cycle power to the drive to reset the fault condition.

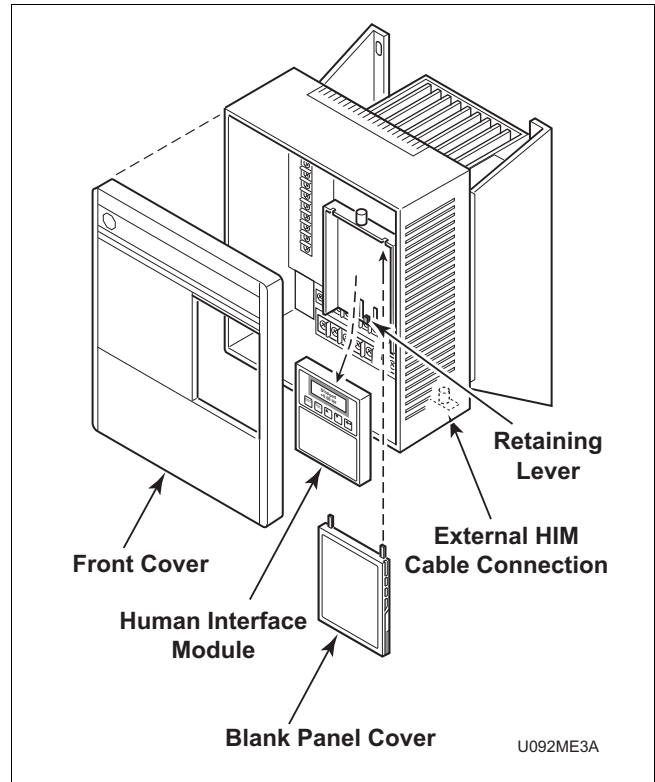

Figure 54

Human Interface Module (HIM) Operation

When power is first applied to the drive, the HIM will cycle through a series of displays. The displays will show drive name, HIM ID number, and communications status. Upon completion, the Status Display will be displayed. If a fault condition exists, it will appear on the display.

NOTE: If “Not Enabled” is displayed, the Enable input is not active. Check that the door is closed and locked, or that all necessary jumpers are in place. Refer to Section 2 of this manual.

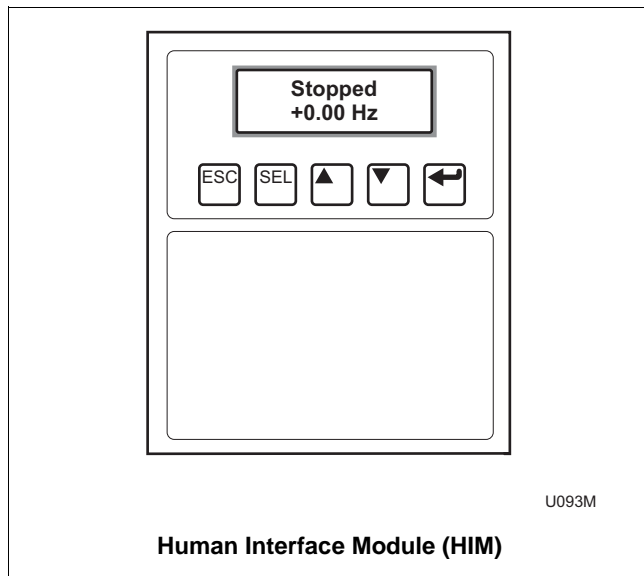





Figure 55

HIM – Key Explanation

 **Escape** key. Use to return to last or original position.

 **Select** key. Use to move cursor position.

 **Up** arrow key. Scroll up.

 **Down** arrow key. Scroll down.

 **Enter** key. Use to enter program selection or new parameter value.

The structure charts on the following pages illustrate how to navigate between the levels to obtain information necessary for troubleshooting for earlier and later HIM versions.

The HIM Structure is broken into 4 levels: Operator Level, Mode Level, Group Level (Main File for earlier versions), and Parameter Level.

In the Group Level (Main File for earlier versions), only three Groups are used: Metering, Faults, and Linear List. Most diagnostic information is found in Metering or Faults.

**HIM Structure Chart – Series A 3.00,
Series B 1.01 or Later Versions**

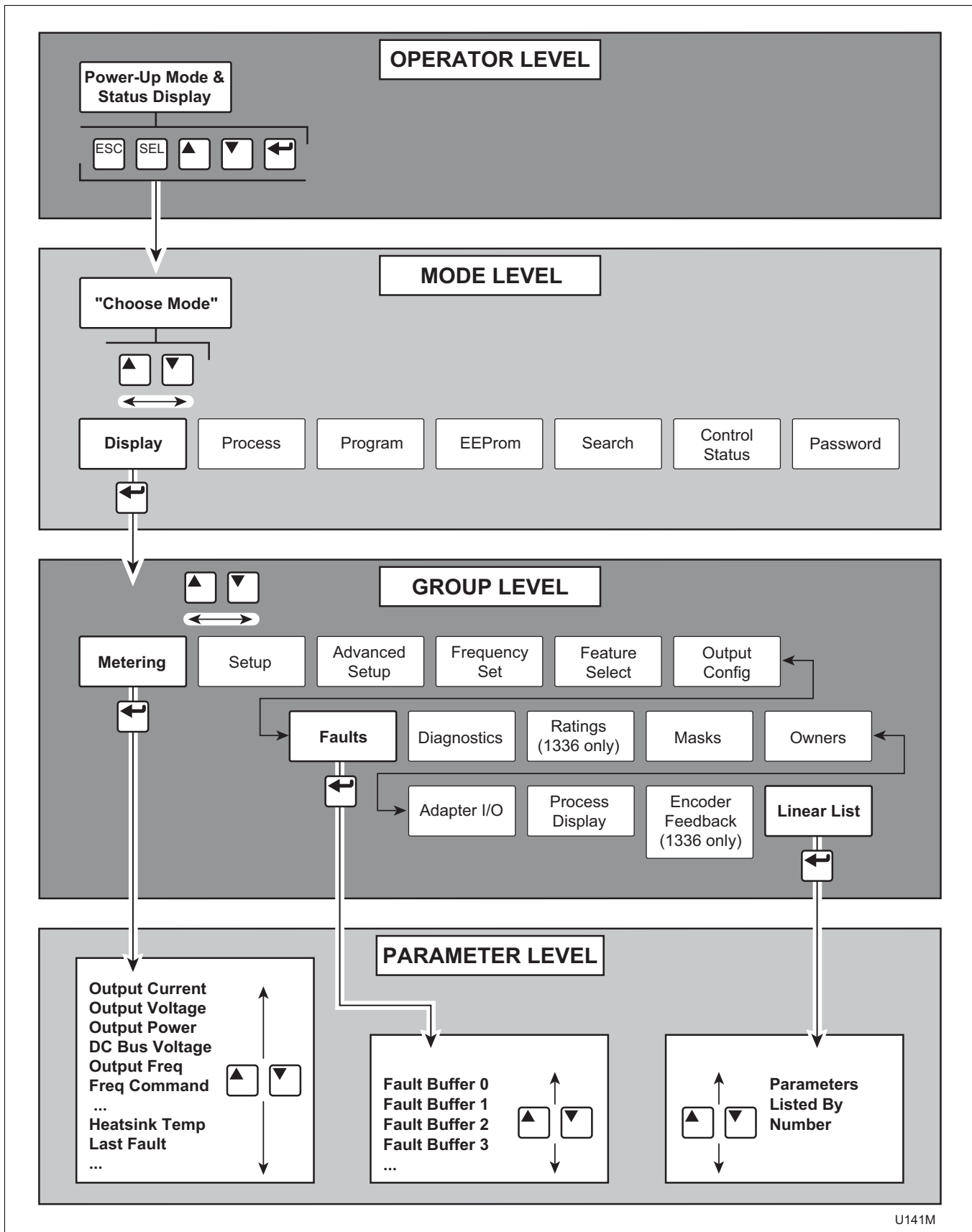

U141M

HIM Structure Chart – Earlier Versions

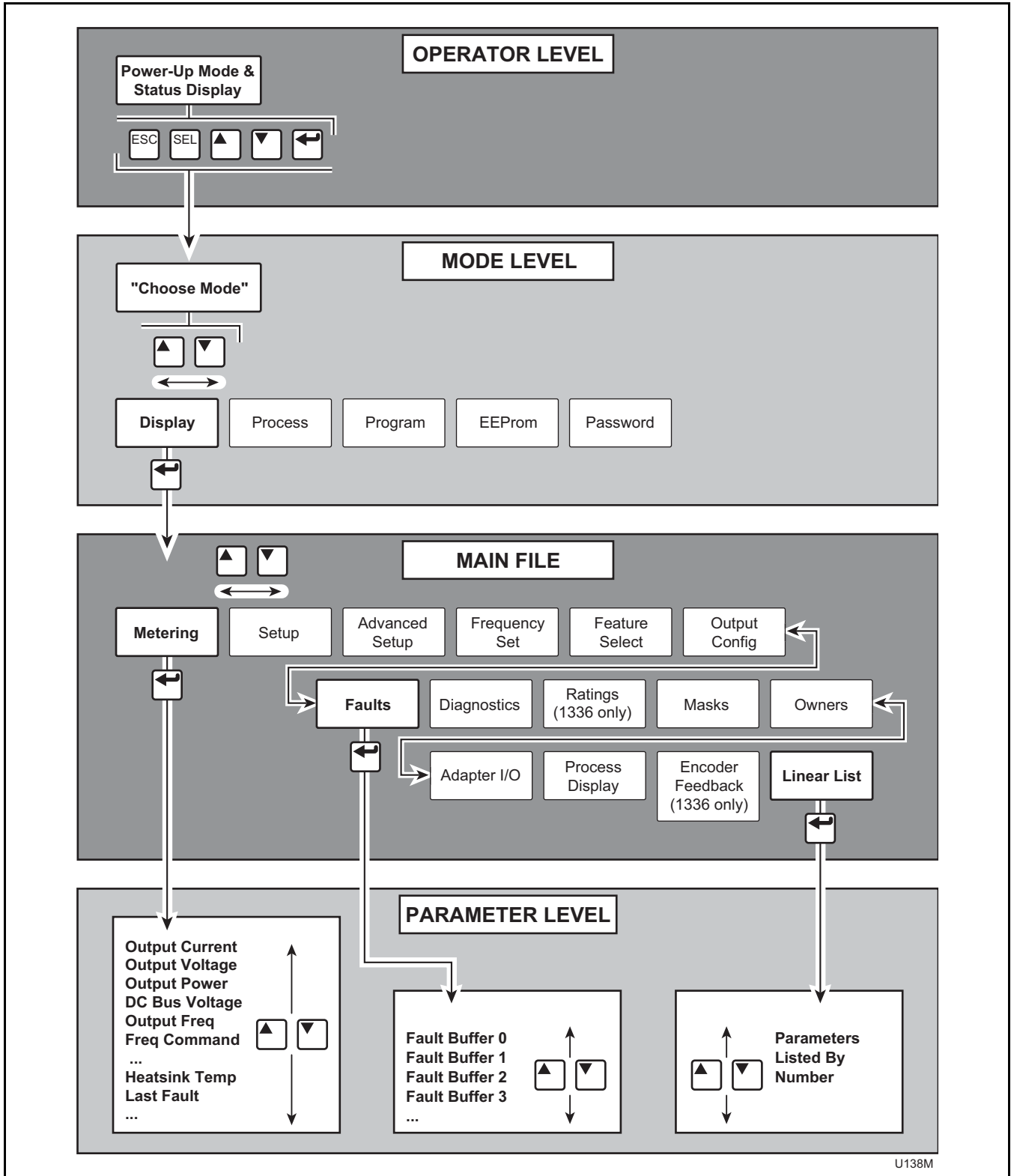

Allen-Bradley 1336-Series AC Drives

Displaying Metering Information

1. Install the HIM on the A-B drive.
2. Turn on machine power.
3. After three to five seconds of initialization, display will show the status display. If drive is in a faulted condition, fault will appear in display; otherwise, drive will read current status. Refer to examples below.

Faulted Drive

Fault Description
Fault Number

Examples of Faults

Serial Fault
F 10





Max Retries Fault
F 33

Normal Condition



Status of Drive
Frequency Commanded

Example of Normal Condition

Stopped
+0.00 Hz

4. Press any key to enter Mode Level,
    . Display will read:

Choose Mode
Display

5. Use the **Up** and **Down** arrow keys   to select “Display” if not displayed immediately.



6. Press the **Enter** key  to choose Group Level. Display will read:

Choose Group
Metering

For earlier HIM versions, press the **Enter** key



-  to choose Main File. Display will read:

Metering
Main File

7. Use the **Up** and **Down** arrow keys   to select “Metering” if not displayed immediately.

8. Press the **Enter** key  to choose Parameter Level. Display now shows parameters under the “Metering” Group.

Output Current
0.00 Amps

9. Use the **Up** and **Down** arrow keys   to select desired parameter display.

10. From this point, press the **Escape** key  to move display up one Level (i.e., press the **Escape** key three times to return to Operator Level).

Displaying Fault Buffers

1. Install the HIM on the A-B drive.
2. Turn on machine power.
3. After three to five seconds of initialization, display will show the status display. If drive is in a faulted condition, fault will appear in display; otherwise, drive will read current status. Refer to examples below.

Faulted Drive

Fault Description
Fault Number

Examples of Faults

Serial Fault
F 10





Max Retries Fault
F 33

Normal Condition



Status of Drive
Frequency Commanded

Example of Normal Condition

Stopped
+0.00 Hz

4. Press any key to enter Mode Level,
    . Display will read:

Choose Mode
Display

5. Use the **Up** and **Down** arrow keys   to select "Display" if not displayed immediately.

6. Press the **Enter** key  to choose Group Level. Display will read:



Choose Group
Faults

For earlier HIM versions, press the **Enter** key





to choose Main File. Display will read:

Faults
Main File

7. Use the **Up** and **Down** arrow keys   to select "Faults."

8. Press the **Enter** key  to choose Parameter Level. Display now shows parameters under the "Faults" Group.

Fault Buffer 0
48

9. Use the **Up** and **Down** arrow keys   to select desired fault buffer display.

10. From this point, press the **Escape** key  to move display up one Level (i.e., press the **Escape** key three times to return to Operator Level).

Allen-Bradley 1336-Series AC Drives

Displaying Linear List of Parameters

1. Install the HIM on the A-B drive.
2. Turn on machine power.
3. After three to five seconds of initialization, display will show the status display. If drive is in a faulted condition, fault will appear in display; otherwise, drive will read current status. Refer to examples below.

Faulted Drive

Fault Description
Fault Number

Examples of Faults

Serial Fault
F 10





Max Retries Fault
F 33

Normal Condition



Status of Drive
Frequency Commanded

Example of Normal Condition

Stopped
+0.00 Hz

4. Press any key to enter Mode Level,
    . Display will read:

Choose Mode
Display

5. Use the **Up** and **Down** arrow keys   to select “Display” if not displayed immediately.

6. Press the **Enter** key  to choose Group Level. Display will read:



Choose Group
Linear List

For earlier HIM versions, press the **Enter** key





to choose Main File. Display will read:

Linear List
Main File

7. Use the **Up** and **Down** arrow keys   to select “Linear List.”

8. Press the **Enter** key  to choose Parameter Level. Display now shows all parameters in numerical order.

Output Voltage
0 VIts 1

9. Use the **Up** and **Down** arrow keys   to select desired parameter display.

10. From this point, press the **Escape** key  to move display up one Level (i.e., press the **Escape** key three times to return to Operator Level).

Fault Display and Troubleshooting Information

This section provides information to guide users in understanding drive fault conditions and general troubleshooting procedures for Allen-Bradley drives. Included is a listing and description of the various drive faults with possible solutions, when applicable. For any questions regarding fault conditions, consult with the factory.

Each drive is equipped with a fault indicator light which illuminates when a fault condition exists.

Fault Code Identification

When the A-B 1336 drives encounter a fault, an LED is illuminated. Refer to *Figure 45*. These LEDs are viewed with the front cover removed. To view the specific fault description, the HIM (parameter unit) must be installed. Refer to HIM installation and operation.

In addition, A-B 1336 fault codes are stored in a fault buffer with the capability to store up to four fault codes. If more than four faults are identified, the least recent fault is deleted to make room for the additional fault. "Fault Buffer 0" is the most recent fault. The faults are viewed using a HIM as shown below. Refer to HIM installation and operation.

<p>Fault Buffer 0 48</p>

The fault parameters are identified as follows:

"Last Fault"	Parameter #4	Most Recent
"Fault Buffer 0"	Parameter #86	Most Recent (same as Parameter #4)
"Fault Buffer 1"	Parameter #87	—
"Fault Buffer 2"	Parameter #88	—
"Fault Buffer 3"	Parameter #89	Least Recent

NOTE: FOR A-B 1336 ONLY. During normal operating conditions (no faults present, drive running) the fault contacts at TB2-13 & 14 are open, and the contacts at TB2-14 & 15 are closed. When a fault occurs, the state of these contacts will change. On some machine models, this contact is connected to a fault indicator light.

Allen-Bradley 1336-Series AC Drives

Clearing Faults

When a fault occurs, the cause must be corrected before the fault can be cleared. Resetting a fault will not correct the cause of the fault condition. After corrective action has been taken, simply cycling power to the drive will clear the fault.

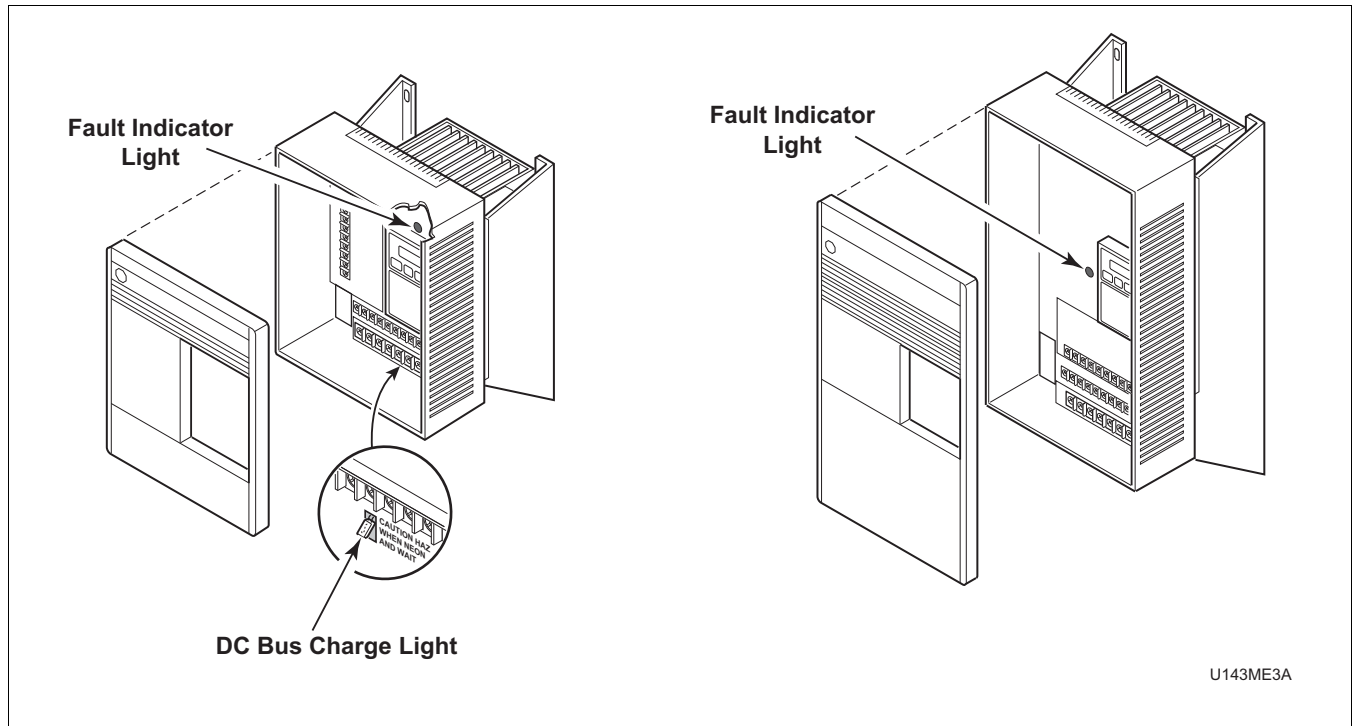

Figure 56

Allen-Bradley Drive Fault Codes

Allen-Bradley Drive Fault Codes			
	Fault	Description	Corrective Action/ Remarks
02	Motor Temp Fault	The motor thermal switch path is open.	Motor temperature high. Check for: ambient air, cooling fan blockage or operation, break in switch wire path (not on all machines).
03	Power Loss Fault	DC Bus voltage remains below 85% nominal for longer than .5 seconds.	Monitor incoming AC line for low voltage or line power interruption.
04	Under Voltage Fault	DC Bus voltage fell below minimum.	Monitor AC incoming AC line for low voltage or line power interruption.
05	Over Voltage Fault	DC Bus maximum voltage exceeded.	Monitor the AC line for high line voltage or transient conditions. High voltage can result from motor regeneration. Buck transformer may be required.
06	Motor Stall	Motor has stalled. Motor load is excessive.	Check motor wiring and connection terminals. Check wash basket freedom of movement and excess belt tension.
07	Motor Overload Fault	Internal electronic overload trip. Excessive motor load exists.	Check motor wiring and connection terminals. Check wash basket freedom of movement and excess belt tension.
08	Over Temperature Fault	Excessive heat detected by heatsink transducer.	Clear blocked or dirty heatsink fins. Check ambient temperature. Check for blocked or nonoperating fan.
10	Serial Fault	Drive lost communication with controlling device.	HIM removed while power applied, cycle power to clear.
12	Overcurrent Fault	Overcurrent detected in instantaneous hardware trip circuit.	Check short circuit at the controller output or excessive load conditions at motor.
22	Controller Reset Fault	Stop input not present.	Check stop input into control terminal board. Close door and ensure any jumpers are placed correctly.
32	EEPROM Fault	EEProm has invalid data.	Consult the factory for further instructions.
33	Max Retries Fault	Controller failed to reset fault within the number of retries.	Fault exists that must be corrected before further operation. Check "Fault Buffer 1" on 1305 and 1336 for specific fault that triggered max retries fault.
38	Phase U Fault	Phase-to-ground fault detected between controller and motor in Phase U.	Check wiring between the drive and motor. Check for grounded phase.

Table 56 (continued)

Table 56 (continued)

Allen-Bradley Drive Fault Codes (continued)			
	Fault	Description	Corrective Action Remarks
39	Phase V Fault	Phase to ground fault detected between controller and motor in Phase V.	Check wiring between the drive and motor. Check for grounded phase.
40	Phase W Fault	Phase to ground fault detected between controller and motor in Phase W.	Check wiring between the drive and motor. Check for grounded phase.
41	UV Short Fault	Excessive current has been detected between two controller output terminals.	Check motor and external wiring to the controller output terminals for shorted condition.
42	UW Short Fault	Excessive current has been detected between two controller output terminals.	Check motor and external wiring to the controller output terminals for shorted condition.
43	VW Short Fault	Excessive current has been detected between two controller output terminals.	Check motor and external wiring to the controller output terminals for shorted condition.
57	Ground Warning	A current path to ground in excess of 2A has been detected at one or more of the drive output terminals.	Check motor and external wiring to drive output terminals for a grounded condition.
48	Reset to Default Values	Parameters were reset to the factory default values.	Verify and re-load the desired parameters.

Table 56

Troubleshooting Suggestions

Important Considerations

- Drive cooling is extremely important to the overall service life of the product. Extreme care should be used to keep cooling air paths clean. Drive cabinet enclosures have been designed to optimize cooling. Keep cabinet doors closed and panels installed to maintain proper operation.
- Resetting a fault will not correct the cause of the fault condition. Corrective action must be taken prior to resetting a fault. Many drive error codes are reset by cycling power to the drive. The fault may not reappear until drive operation is initiated.
- Drive to motor wiring is critical to proper drive operation. Loose or bad connections can generate heat and increase current output from drive. These problems can manifest themselves in operation by many fault codes indicating overcurrent condition and maximum retries fault.

Problem/Corrective Action

Problem:

Wash basket does not rotate.

Corrective Action

1. Ensure computer control display on washer is showing proper operation.
2. Check power circuit, supply voltage, fuses and disconnects.
3. Verify drive to motor wires are damage free, properly connected and torqued to specifications.
4. Check belt tension and condition.
5. Verify no mechanical problems exist (i.e., binding, motion restriction).
6. Check control input signals. Refer to applicable table of inputs.

Problem:

Drive started but wash basket is not rotating.

Corrective Action

1. Verify drive to motor wires are damage-free, properly connected and torqued to specifications.
2. Verify no mechanical problems exist (i.e., binding, motion restriction).
3. Check control input signals. Refer to applicable table of inputs.

Problem:

Wash basket not accelerating properly.

Corrective Action

1. Verify drive to motor wires are damage-free, properly connected and torqued to specifications.
2. Verify speed selection control wire connections. Refer to applicable table.

Problem:

Drive gives Serial Fault (F10) when HIM is removed from the drive.

Corrective Action

1. Cycle power to drive to clear the fault.

When a HIM is disconnected with the drive powered, communication is lost and a fault results. Always remove power from the drive prior to HIM or PKM removal or installation.

Problem:

HIM displays “Pin ID Error” or “Network Error.”

Corrective Action

1. Place the HIM directly on the drive.

This communication error with the drive may be the result of a bad cable or connector that establishes communication with the HIM.

Problem:

HIM displays “Not Enabled.”

Corrective Action

1. Verify the jumper connecting the control terminal “Enable” to “Common” is present and is not loose.

This connection must be present to enable the drive.

Free Manuals Download Website

<http://myh66.com>

<http://usermanuals.us>

<http://www.somanuals.com>

<http://www.4manuals.cc>

<http://www.manual-lib.com>

<http://www.404manual.com>

<http://www.luxmanual.com>

<http://aubethermostatmanual.com>

Golf course search by state

<http://golfingnear.com>

Email search by domain

<http://emailbydomain.com>

Auto manuals search

<http://auto.somanuals.com>

TV manuals search

<http://tv.somanuals.com>