

Washer-Extractor

Pocket Hardmount

Variable-Speed

WE-6 Control

Refer to Page 9 for Model Identification

— Operation/Maintenance —

NOTA: El manual en español aparece después del manual en inglés.

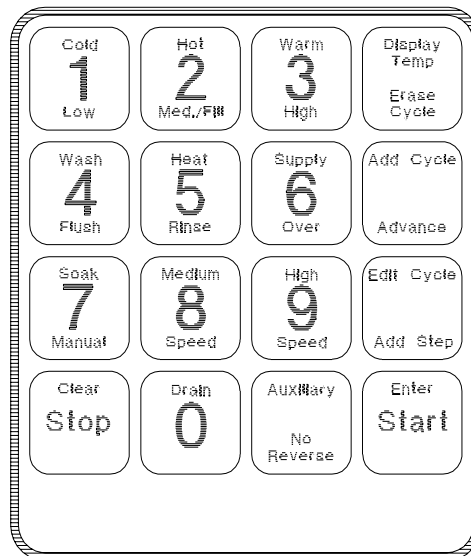

MC010J

Keep These Instructions for Future Reference.

(If this machine changes ownership, this manual must accompany machine.)



www.comlaundry.com

Part No. F232201R4
December 2005

Table of Contents

Safety Information	3
Explanation of Safety Messages.....	3
Important Safety Instructions	3
Safety Decals	5
Operator Safety	6
Safe Operating Environment	6
Environmental Conditions	6
Machine Location	7
Input and Output Services.....	7
AC Inverter Drive	8
Introduction	9
Model Identification	9
Nameplate Location.....	9
Replacement Parts	9
Customer Service.....	9
Operation	11
Machine Familiarization Guide	11
Theory of Operation	13
Emergency Stop Button	14
Drain Steps.....	14
LED Display	14
Operational Keypad	17
Pre-Operating Instructions.....	19
Operating Instructions	19
Stop Routine	22
Basket Jog Feature (UW150 Models Only).....	23
Temperature Display	23
Error Recovery Routine.....	24
Maintenance	25
Daily	25
Beginning of Day	25
End of Day	26
Weekly	26
Monthly.....	27
Quarterly	28
Care of Stainless Steel	29
Daily Preventive Maintenance Checklist.....	30
Weekly Preventive Maintenance Checklist	31
Monthly Preventive Maintenance Checklist.....	32
Quarterly Preventive Maintenance Checklist	33

© Copyright 2005, Alliance Laundry Systems LLC

All rights reserved. No part of the contents of this book may be reproduced or transmitted in any form or by any means without the expressed written consent of the publisher.

Safety Information

Explanation of Safety Messages

Precautionary statements (“DANGER,” “WARNING,” and “CAUTION”), followed by specific instructions, are found in this manual and on machine decals. These precautions are intended for the personal safety of the operator, user, servicer, and those maintaining the machine.

	DANGER
DANGER indicates the presence of a hazard that will cause severe personal injury, death, or substantial property damage if the danger is ignored.	

	WARNING
WARNING indicates the presence of a hazard that can cause severe personal injury, death, or substantial property damage if the warning is ignored.	

	CAUTION
CAUTION indicates the presence of a hazard that will or can cause minor personal injury or property damage if the caution is ignored.	

Additional precautionary statements (“IMPORTANT” and “NOTE”) are followed by specific instructions.

IMPORTANT: The word “IMPORTANT” is used to inform the reader of specific procedures where minor machine damage will occur if the procedure is not followed.

NOTE: The word “NOTE” is used to communicate installation, operation, maintenance or servicing information that is important but not hazard related.

Important Safety Instructions

	WARNING
To reduce the risk of fire, electric shock, serious injury or death to persons when using your washer, follow these basic precautions:	
W023	

1. Read all instructions before using the washer.
2. Refer to the GROUNDING INSTRUCTIONS in the INSTALLATION manual for the proper grounding of the washer.
3. Do not wash textiles that have been previously cleaned in, washed in, soaked in, or spotted with gasoline, kerosene, waxes, cooking oils, dry-cleaning solvents, or other flammable or explosive substances as they give off vapors that could ignite or explode.
4. Do not add gasoline, dry-cleaning solvents, or other flammable or explosive substances to the wash water. These substances give off vapors that could ignite or explode.
5. Under certain conditions, hydrogen gas may be produced in a hot water system that has not been used for two weeks or more. HYDROGEN GAS IS EXPLOSIVE. If the hot water system has not been used for such a period, before using a washing machine or combination washer-dryer, turn on all hot water faucets and let the water flow from each for several minutes. This will release any accumulated hydrogen gas. The gas is flammable, do not smoke or use an open flame during this time.
6. Do not allow children to play on or in the washer. Close supervision of children is necessary when the washer is used near children. This is a safety rule for all appliances.
7. Before the washer is removed from service or discarded, remove the door to the washing compartment.
8. Do not reach into the washer if the wash drum is moving.

Safety Information

9. Do not install or store the washer where it will be exposed to water and/or weather.
10. Do not tamper with the controls.
11. Do not repair or replace any part of the washer, or attempt any servicing unless specifically recommended in the user-maintenance instructions or in published user-repair instructions that the user understands and has the skills to carry out.
12. To reduce the risk of an electric shock or fire, DO NOT use an extension cord or an adapter to connect the washer to the electrical power source.
13. Use washer only for its intended purpose, washing textiles.
14. Never wash machine parts or automotive parts in the machine. This could result in serious damage to the basket.
15. ALWAYS disconnect the washer from electrical supply before attempting any service. Disconnect the power cord by grasping the plug, not the cord.
16. Install the washer according to the INSTALLATION INSTRUCTIONS. All connections for water, drain, electrical power and grounding must comply with local codes and be made by licensed personnel when required.
17. To reduce the risk of fire, textiles which have traces of any flammable substances such as vegetable oil, cooking oil, machine oil, flammable chemicals, thinner, etc., or anything containing wax or chemicals such as in mops and cleaning cloths, must not be put into the washer. These flammable substances may cause the fabric to catch on fire by itself.
18. Do not use fabric softeners or products to eliminate static unless recommended by the manufacturer of the fabric softener or product.
19. Keep washer in good condition. Bumping or dropping the washer can damage safety features. If this occurs, have washer checked by a qualified service person.
20. Replace worn power cords and/or loose plugs.
21. Be sure water connections have a shut-off valve and that fill hose connections are tight. CLOSE the shut-off valves at the end of each wash day.
22. Loading door MUST BE CLOSED any time the washer is to fill, tumble or spin. DO NOT bypass the loading door switch by permitting the washer to operate with the loading door open.
23. Always read and follow manufacturer's instructions on packages of laundry and cleaning aids. Heed all warnings or precautions. To reduce the risk of poisoning or chemical burns, keep them out of the reach of children at all times (preferably in a locked cabinet).
24. Always follow the fabric care instructions supplied by the textile manufacturer.
25. Never operate the washer with any guards and/or panels removed.
26. DO NOT operate the washer with missing or broken parts.
27. DO NOT bypass any safety devices.
28. Failure to install, maintain, and/or operate this washer according to the manufacturer's instructions may result in conditions which can produce bodily injury and/or property damage.

NOTE: The WARNINGS and IMPORTANT SAFETY INSTRUCTIONS appearing in this manual are not meant to cover all possible conditions and situations that may occur. Common sense, caution and care must be exercised when installing, maintaining, or operating the washer.

Any problems or conditions not understood should be reported to the dealer, distributor, service agent or the manufacturer.

	WARNING
<p>This machine must be installed, adjusted, and serviced by qualified electrical maintenance personnel familiar with the construction and operation of this type of machinery. They must also be familiar with the potential hazards involved. Failure to observe this warning may result in personal injury and/or equipment damage, and may void the warranty.</p>	
SW004	

	CAUTION
<p>Ensure that the machine is installed on a level floor of sufficient strength and that the recommended clearances for inspection and maintenance are provided. Never allow the inspection and maintenance space to be blocked.</p>	
SW020	

	CAUTION
<p>Be careful around the open door, particularly when loading from a level below the door. Impact with door edges can cause personal injury.</p>	
SW025	

	WARNING
<p>Never touch internal or external steam pipes, connections, or components. These surfaces can be extremely hot and will cause severe burns. The steam must be turned off and the pipe, connections, and components allowed to cool before the pipe can be touched.</p>	
SW014	

	WARNING
<p>This machine must be installed, adjusted, and serviced by qualified electrical maintenance personnel familiar with the construction and operation of this type of machinery. They must also be familiar with the potential hazards involved. Failure to observe this warning may result in personal injury and/or equipment damage, and may void the warranty.</p>	
SW004	

Safety Decals

Safety decals appear at crucial locations on the machine. Failure to maintain legible safety decals could result in injury to the operator or service technician.

To provide personal safety and keep the machine in proper working order, follow all maintenance and safety procedures presented in this manual. If questions regarding safety arise, contact the manufacturer immediately.

Use manufacturer-authorized spare parts to avoid safety hazards.

Operator Safety

	WARNING
NEVER insert hands or objects into basket until it has completely stopped. Doing so could result in serious injury.	
SW012	

To ensure the safety of machine operators, the following maintenance checks must be performed daily:

1. Prior to operating the machine, verify that all warning signs are present and legible. Missing or illegible signs must be replaced immediately. Make certain that spares are available.
2. Check door interlock before starting operation of the machine:
 - a. Attempt to start the machine with the door open. The machine should not start with the door open.
 - b. Close the door without locking it and attempt to start the machine. The machine should not start with the door unlocked.
 - c. Close and lock the door and start a cycle. Attempt to open the door while the cycle is in progress. The door should not open.If the door lock and interlock are not functioning properly, call a service technician.
3. Do not attempt to operate the machine if any of the following conditions are present:
 - a. The door does not remain securely locked during the entire cycle.
 - b. Excessively high water level is evident.
 - c. Machine is not connected to a properly grounded circuit.

Do not bypass any safety devices in the machine.

	WARNING
Never operate the machine with a bypassed or disconnected balance system. Operating the machine with severe out-of-balance loads could result in personal injury and serious equipment damage.	
SW039	

Safe Operating Environment

Safe operation requires an appropriate operating environment for both the operator and the machine. If questions regarding safety arise, contact the manufacturer immediately.

Environmental Conditions

- *Ambient Temperature.* Water in the machine will freeze at temperatures of 32°F (0°C) or below.

Temperatures above 120°F (50°C) will result in more frequent motor overheating and, in some cases, malfunction or premature damage to solid state devices that are used in some models. Special cooling devices may be necessary.

Water pressure switches are affected by increases and decreases in temperature. Every 25°F (10°C) change in temperature will have a 1% effect on the water level.

- *Humidity.* Relative humidity above 90% may cause the machine's electronics or motors to malfunction or may trip the ground fault interrupter. Corrosion problems may occur on some metal components in the machine.

If the relative humidity is below 30%, belts and rubber hoses may eventually develop dry rot. This condition can result in hose leaks, which may cause safety hazards external to the machine in conjunction with adjacent electrical equipment.

- *Ventilation.* The need for make-up air openings for such laundry room accessories as dryers, ironers, water heaters, etc., must be evaluated periodically. Louvers, screens, or other separating devices may reduce the available air opening significantly.
- *Radio Frequency Emissions.* A filter is available for machines in installations where floor space is shared with equipment sensitive to radio frequency emissions.
- *Elevation.* If the machine is to be operated at elevations of over 3280 feet (1000 m) above sea level, pay special attention to water levels and electronic settings (particularly temperature) or desired results may not be achieved.
- *Chemicals.* Keep stainless steel surfaces free of chemical residues.

	DANGER
<p>Do not place volatile or flammable fluids in any machine. Do not clean the machine with volatile or flammable fluids such as acetone, lacquer thinners, enamel reducers, carbon tetrachloride, gasoline, benzene, naphtha, etc. Doing so could result in serious personal injury and/or damage to the machine.</p>	
SW002	

- *Water Damage.* Do not spray the machine with water. Short circuiting and serious damage may result. Repair immediately all seepage due to worn or damaged gaskets, etc.

Machine Location

- *Foundation.* The concrete floor must be of sufficient strength and thickness to handle the floor loads generated by the high extract speeds of the machine. Refer to Installation manual.
- *Service/Maintenance Space.* Provide sufficient space to allow comfortable performance of service procedures and routine preventive maintenance.

Consult installation instructions for specific details.

	CAUTION
<p>Replace all panels that are removed to perform service and maintenance procedures. Do not operate the machine with missing guards or with broken or missing parts. Do not bypass any safety devices.</p>	
SW019	

Input and Output Services

- *Water Pressure.* Best performance will be realized if water is provided at a pressure of 30 – 85 psi (2.0 – 5.7 bar). Although the machine will function properly at lower pressure, increased fill times will occur. Water pressure higher than 100 psi (6.7 bar) may result in damage to machine plumbing. Component failure(s) and personal injury could result.
- *Steam Heat (Optional) Pressure.* Best performance will be realized if steam is provided at a pressure of 30 – 80 psi (2.0 – 5.4 bar). Steam pressure higher than 125 psi (8.5 bar) may result in damage to steam components and may cause personal injury.

For machines equipped with optional steam heat, install piping in accordance with approved commercial steam practices. Failure to install the supplied steam filter may void the warranty.

- *Drainage System.* Provide drain lines or troughs large enough to accommodate the total number of gallons that could be dumped if all machines on the site drained at the same time from the highest attainable level. If troughs are used, they should be covered to support light foot traffic.
- *Power.* For personal safety and for proper operation, the machine must be grounded in accordance with state and local codes. The ground connection must be to a proven earth ground, not to conduit or water pipes. Do not use fuses in place of the circuit breaker. An easy-access cutoff switch should also be provided.

	WARNING
<p>Ensure that a ground wire from a proven earth ground is connected to the ground lug near the input power block on this machine. Without proper grounding, personal injury from electric shock could occur and machine malfunctions may be evident.</p>	
SW008	

Always disconnect power and water supplies before a service technician performs any service procedure. Where applicable, steam and/or compressed air supplies should also be disconnected before service is performed.

Safety Information

AC Inverter Drive

Machines equipped with the AC inverter drive require special attention with regard to the operating environment.

- An especially dusty or linty environment will require more frequent cleaning of the AC inverter drive cooling fan filter and of the AC inverter drive itself.
- Power line fluctuations from sources such as uninterruptible power supplies (UPS) can adversely affect machines equipped with the AC inverter drive. Proper suppression devices should be utilized on the incoming power to the machine to avoid problems.
- A clean power supply free from voltage spikes and surges is absolutely essential for machines equipped with the AC inverter drive. Nonlinear inconsistencies (peaks and valleys) in the power supply can cause the AC inverter drive to generate nuisance errors.

If voltage is above 240 Volt for 200 Volt installation, ask the power company to correct. As an alternative, a step-down transformer kit is available from the distributor. If voltage is above 480 Volt for 400 Volt installations, a buckboost transformer is required.

- Sufficient space to perform service procedures and routine preventive maintenance is especially important for machines equipped with the AC inverter drive.

This manual is designed as a guide to operating and maintaining the Pocket Hardmount washer-extractor equipped with the AC inverter drive.

NOTE: All information, illustrations, and specifications contained in this manual are based on the latest product information available at the time of printing. We reserve the right to make changes at any time without notice.

Introduction

Model Identification

Information in this manual is applicable to these models:

UW35PV*	UW100PV*
UW60PV*	UW125PV*
UW80PV*	UW150PV*

* This manual applies to models with U5, U6, U7 or U8 in the 8th and 9th, or 9th and 10th positions in the model number (e.g., UW60PVXU80001).

Nameplate Location

The nameplate is located on cagewrap, on side of AC Inverter Drive Compartment and on Electric Heat Contractor Box (if equipped). Always provide the machine's serial number and model number when ordering parts or when seeking technical assistance. Refer to *Figure 1*.

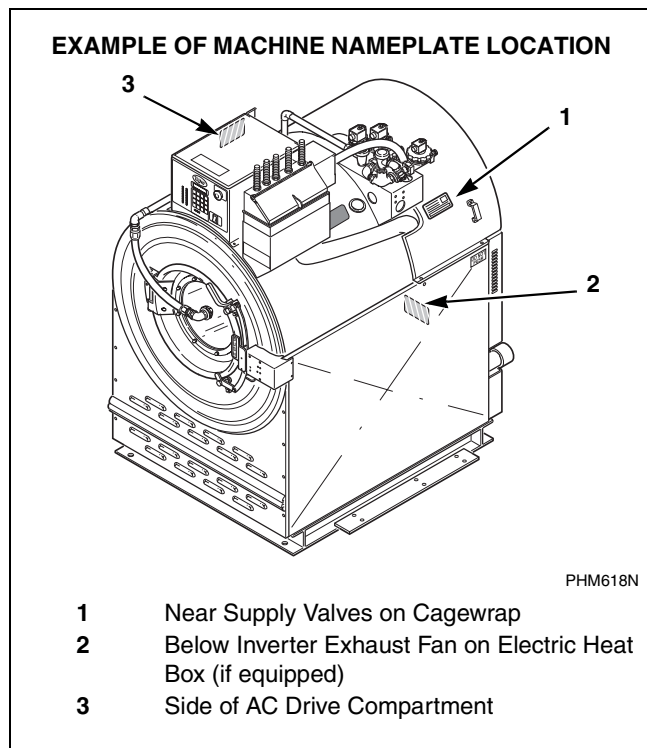

Figure 1

Replacement Parts

If literature or replacement parts are required, contact the source from which the washer-extractor was purchased or contact Alliance Laundry Systems LLC at (920) 748-3950 for the name of the nearest authorized parts distributor. A parts manual may be ordered by returning the reply card provided with each washer-extractor.

Customer Service

For technical assistance, contact your local distributor or call:

(920) 748-3121
Ripon, Wisconsin

A record of each washer-extractor is on file with the manufacturer. Always provide the machine's serial number and model number when ordering parts or when seeking technical assistance. Refer to *Figure 1*.

Introduction

Model Number Familiarization Guide	
Sample Model Number: UW60PVXU80001	
UW	Model Number Prefix
60	Washer-Extractor Capacity (pounds dry weight of laundry)
P	Type of Electrical Control P = WE-6 Control
V	Washer-Extractor Speed Capabilities V = 7 Speeds
X	Electrical Characteristics
U8	Design Series J = Jog Feature (UW 150 Models only)
0001	Option Identification (varies from machine to machine)

Model No.	UW60PVXU80001			
Serial No.	000000000000			
Voltage	200 – 240	Amps	14	
Circuit Breaker	20 Amps			
Hz	50 – 60	Wire	2/3	Phase 1/3
Max. Load	60 LB	27 KG	Max. Speed	813 RPM
Elec. Heating	N/A		Steam Press.	N/A PSI 0.0 BAR
Drawings:				
ETL Listed Conforms To ANSI/UL Std. 1206, 3rd Ed Certified To CAN/CSA Std. C22.2 No.53-1968				

EXAMPLE OF NAMEPLATE

PHM533R

Figure 2

Operation

Machine Familiarization Guide

The machine familiarization guide in *Figure 3* and *Figure 4* identifies major operational features of the UWPV washer-extractor.

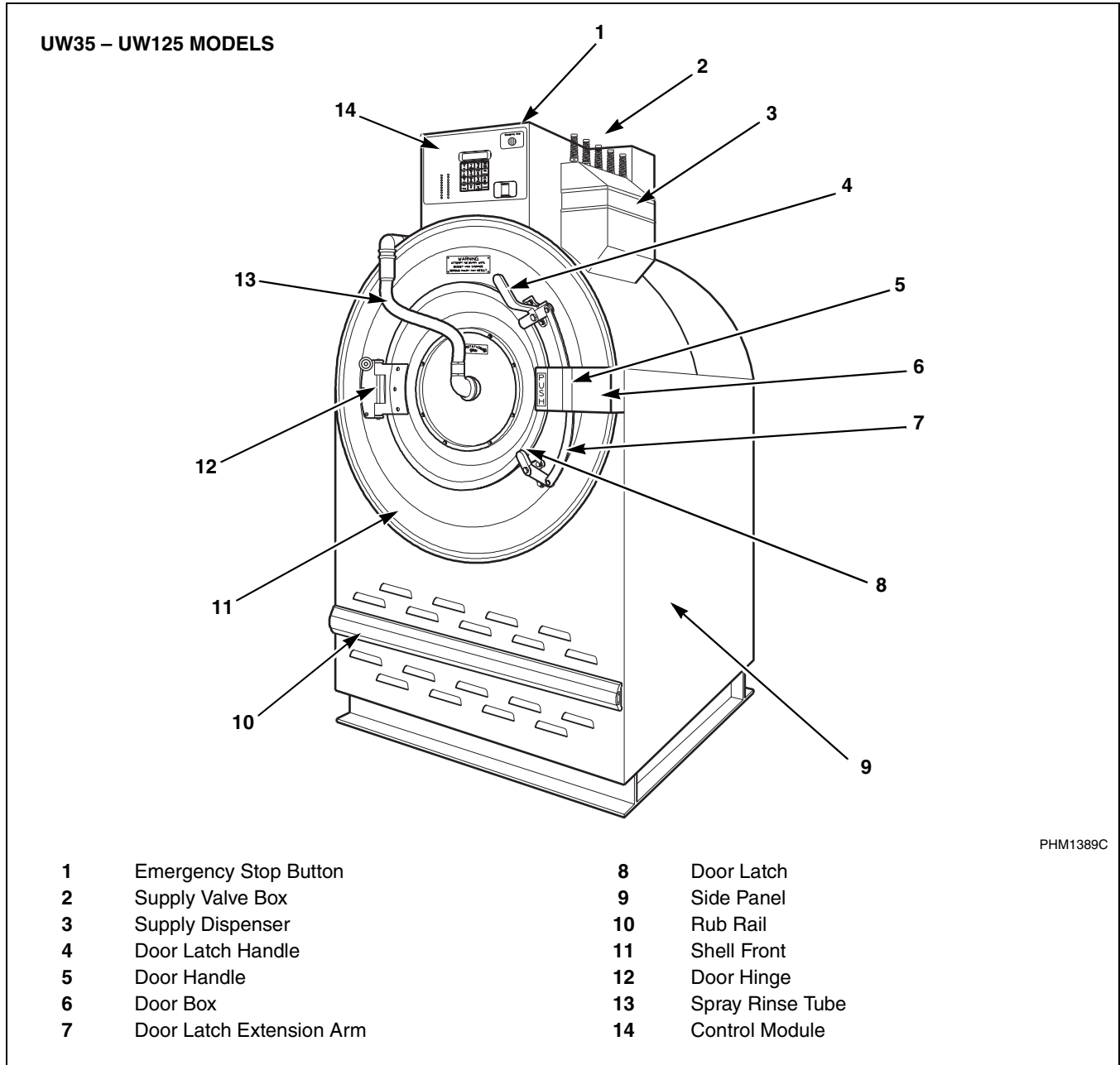

Figure 3

Operation

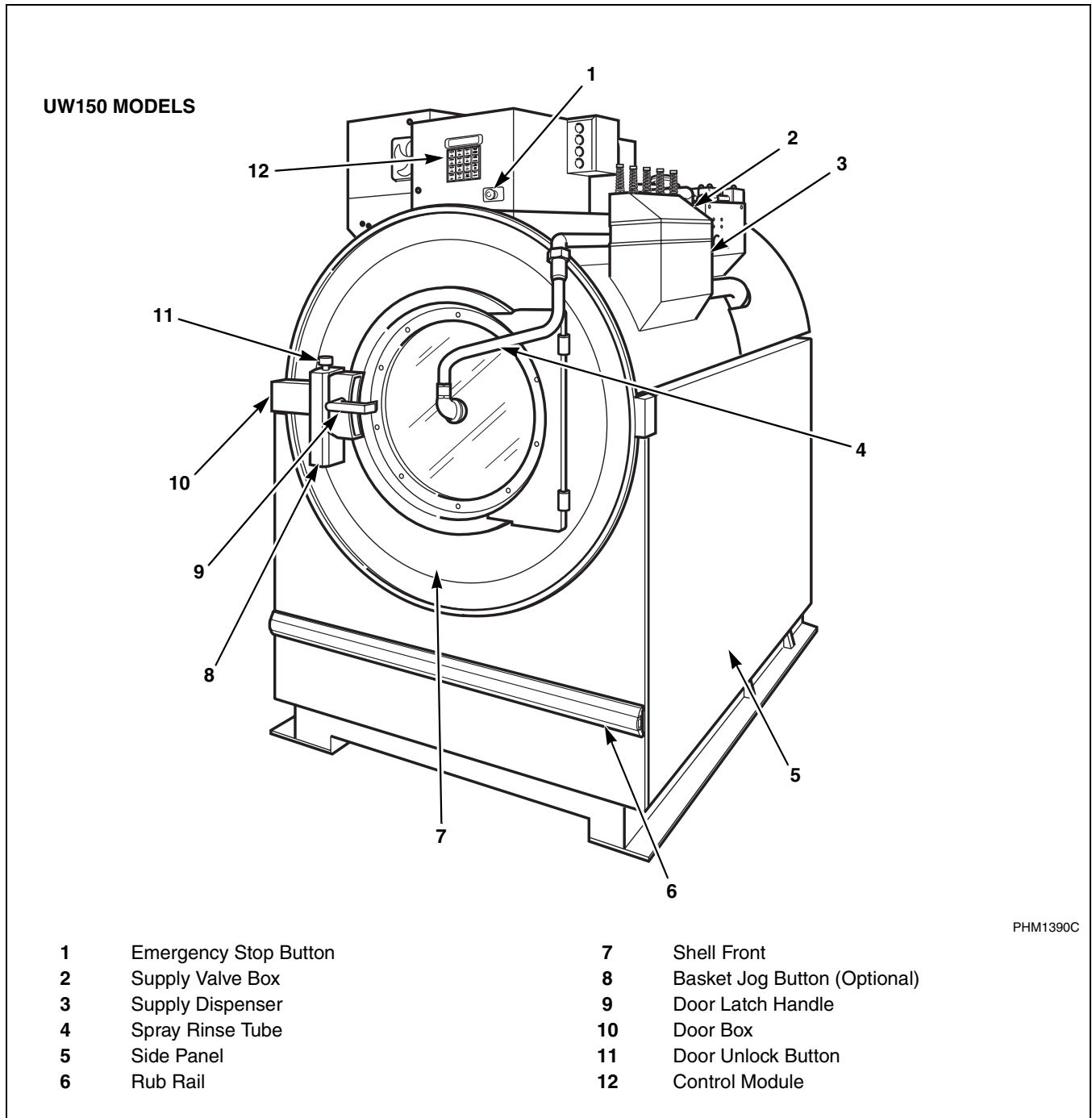

Figure 4

Theory of Operation

The design of the washer-extractor emphasizes performance reliability and long service life. The cylinder, shell, and main body panels are fabricated of stainless steel.

Electrical controls for the washer-extractor are housed in a separate enclosure located on the top of the machine. Removing the screws from the module cover, lifting the cover, and pulling to the rear provides access to the control module. This module contains the WE-6 control, contactors, water-level switch, and other control components.

The cylinder is driven by a V-drive system supported via the shaft by two flange-mounted spherical roller bearings bolted to the A-frame.

The cylinder is constructed with four lifters or ribs that lift the laundry from the bath solution when the cylinder rotates at slow speed and then allow the laundry to tumble back into the bath. This mechanical action accomplishes the washing function. The cylinder is perforated, allowing the water to drain from within during the wash and extract steps.

The spray rinse feature consists of a fiber-reinforced clear hose connected to the center of the door glass and to both a hot and cold water inlet valve. A hemispherically-shaped spray nozzle inside the door glass produces a fan-action water spray which disperses rinse water throughout the load.

All UWPV washer-extractors use an AC inverter drive control which provides seven preset motor speeds using a single motor. The AC drive interface board converts motor logic from the WE-6 control to the correct signals for the AC inverter drive. In addition, all logic inputs to the control are routed through this board.

The operator can select from among 39 preprogrammed cycles. Cycle 39 is a test cycle used to verify proper operation of the washer-extractor. With the exception of Cycle 01, the remaining cycles are complete wash cycles or specialty cycles designed to handle various fabrics at specific water temperatures and levels. Cycle 01 is designed to test an external chemical injection supply system.

Programmable custom cycles are another feature of the UWPV.

The vibration switch system utilizes a micro-switch mounted between the faces of the A-frame to signal the WE-6 control that the load imbalance is too great for high extract speeds. Depending on the design series, the vibration switch will perform in either of two ways. If the washer-extractor utilizes ONLY the

vibration switch to detect an out-of-balance load, the switch will signal the WE-6 control to slow the motor speed, allowing the load to re-distribute, and then resume the spin speed programmed. The control will attempt to redistribute the load in this manner up to three times. On the third attempt, if an imbalance condition is still detected, the control will abort the spin speed step(s) and advance to the next non-spin speed step.

However, if the washer-extractor is equipped with BOTH the vibration switch and the AC inverter drive balance detection systems, the function of the switch is slightly different. The inverter drive will monitor load imbalance conditions and the control. If the load is not balanced to spin at the programmed spin speed, control will attempt to re-distribute the load. After three unsuccessful attempts to balance the load, control will limit the spin speed (on models with the WE-6 Firmware ID Code of "ARWCxx" the WE-6 display will alternately flash the programmed spin speed and the substituted spin speed). During the spin step, if the vibration switch detects a severe imbalance, due to improper installation or improper loading of the washer, the control will abort the remaining portion of the cycle and stop the machine. The display will flash "BAL/DR" while aborting the cycle until the door has been opened.

Water enters the washer-extractor through electromechanical water valves controlled by the microcomputer. The microcomputer also controls the drain and the door lock. In addition, it selects the water levels according to the programmed cycle. Vacuum breakers are installed in the water-inlet plumbing to prevent backflow of water.

The standard production UW35PV and UW60PV use a single drain valve. (Dual drains are available as an option.) The UW80PV, UW100PV, UW125PV and UW150PV use dual drain valves. The dual drains open and close together under control of the WE-6 control. The drain valve is normally open, which means that it closes only when power is applied, thus allowing the machine to drain in the event of a power failure.

A door-lock system prevents opening of the stainless steel door when a cycle is in progress. It also prevents operation of the washer-extractor when the door is open. The door box contains the door-lock microswitch, door-closed magnetic switch, and the door-unlock solenoid.

On later design models equipped with a rotation sensor, the door lock system will allow door to unlock soon after basket stops at the end of the cycle.

Display Interpretations	
HRWC__ ARWC__	Program identification code (ROM). This is an example only.
DONE	End of cycle
DOOR	Door not locked problem
EMTY	Empty problem
FILL	Fill problem
SDLY	Spin coast delay
NEXT	Select cycle or open door or select program
NCYC	Cycle not available
STOP	Stop button pressed or cycle ended
A1	Auxiliary output #1
A2	Auxiliary output #2
A3	Signal
CF	Cold flush
CH	Cold fill to high level
CM	Cold fill to medium level
CL	Cold fill to low level
CO	Cold fill to overflow
CR	Cold rinse
CY	Cycle number
D1	Drain #1
D5	Identical to Drain #1 without rebalance attempts – reduces drain time. Do not program an H3 spin after this step.
Da	Drain to optional reuse tank A
Db	Drain to optional reuse tank B
F	Heat select temperature in ° Fahrenheit
C	Heat select temperature in ° Centigrade
HF	Hot flush
HH	Hot fill to high level
HM	Hot fill to medium level
aL	Fill from reuse tank A to low level
SEt UP	Perform model setup routine
aM	Fill from reuse tank A to medium level

Table 1

Display Interpretations	
aH	Fill from reuse tank A to high level
bL	Fill from reuse tank B to low level
bM	Fill from reuse tank B to medium level
bH	Fill from reuse tank B to high level
HL	Hot fill to low level
HO	Hot fill to overflow
HR	Hot rinse
H1	High speed #1
H2	High speed #2
H3	High speed #3 (default)
H3	High speed #3 (maximum)
HT	Heat (steam or electric)
--M	Minutes (used when programming time)
--S	Seconds (used when programming time)
MS	Medium speed spin
SK	Soak
S1	Supply #1 (Detergent)
S2	Supply #2 (Bleach)
S3	Supply #3 (Sour)
S4	Supply #4 (Softener)
S5	Supply #5 (Specialty)
TH	Controlled temperature fill to high level
TM	Controlled temperature fill to medium level
TL	Controlled temperature fill to low level
TO	Controlled temperature overflow
W1	Wash 1 (normal reversing)
W2	Wash 2 (gentle reversing)
W3	Wash 3 (no agitation)
W4	Wash 4 (medium reversing action)
TEST?/ SPEED	Test rotation sensor
W5	Wash 5 (temp.-controlled cool-down)

Table 1

Operation

Display Interpretations	
W6	Wash 6 (extra low agitation)
W7	Wash 7 (no agitation, drain 1 open, no refill)
WD	Wash drain step – shortest drain time. Use only if not followed by a spin step. Drain 1 open, no rotation.
WF	Warm flush
WH	Warm fill to high level
WM	Warm fill to medium level
WL	Warm fill to low level
WO	Warm fill to overflow level
WR	Warm rinse
•	Left dot–poor balance condition
•	Second dot from left–door lock switch
•	Third dot from left–Program Mode
•	Fourth dot from left–high level reached
•	Fifth dot from left–medium level reached
•	Right dot–low level reached
EXISTS	Cycle already in memory
EDIT?	Do you want to edit the cycle?
TEMP	Over-temperature-limit condition
OVERHT	Open or shorted temperature input circuit or temperature out of computer’s allowable limits
WATER	Water in washer-extractor at end of cycle
°FAR	Temperature in degrees Fahrenheit
°CEN	Temperature in degrees Centigrade
MANUAL	Manual Mode enabled
NO MAN	Manual Mode disabled
1DRAIN	One drain capability selected
2DRAIN	Second independent drain enabled (via Auxiliary 2 output–precludes control of recirculation pump via Auxiliary 2, if selected). This should not be confused with the “dual drain” option.
ADV	Advance (skip steps) feature enabled

Table 1

Display Interpretations	
NO ADV	Advance feature disabled
WET CL	Wet clean function for Auxiliary 1 output (1/2 wash speed) and Auxiliary 2 output (recirculation pump) enabled (see “2DRAIN.”)
NO WCL	Wet clean function for Auxiliary 1 and 2 disabled (Auxiliary 1 and 2 are timed outputs.)
S BAL	“Short” balance routine–active only if inverter drive load balance sensing is utilized.
L BAL	“Long” balance routine–active only if AC inverter drive load balance sensing is utilized.
DRTEMP	Temperature is above 160°F in drain to reuse tank A or B step.
BAL DR* (flashing at the end of cycle)	Cycle aborted due to extreme out-of-balance condition or door is unstable.

Table 1

* Design U6 and greater models

Operational Keypad

The control includes sixteen keypads. Refer to *Figure 6*. These functions are available to the operator and are intended to control operation of the washer-extractor. Refer to *Table 2*.

Operational Keypad	
Keypad	Description
Numbers 0–9	Press to select cycle number.
Display Temp*	Press and hold. Display will show and update sump temperature in degrees Fahrenheit or Centigrade.
Advance	Press to cause computer to skip to the next step in the cycle. The computer will not advance past drain step. (The Advance keypad is enabled at the factory and can be disabled at the laundry site.)
Stop	Press to immediately abort the cycle and initiate the Stop Routine.
Start	Press to start selected cycle or to restart a step following a “FILL” or “EMPTY” alarm. See Error Recovery Routine in this section of the manual.
Manual	See Manual Mode Control Feature at the end of this section.

Table 2

* If cycle in a spin coast delay, display shows speed of basket.

Operation

Located to the left of the control keypad are 20 LED indicator lights for the control outputs. During the time that a cycle is running, one or more of these lights will be on to indicate steps in use. Refer to *Figure 6*.

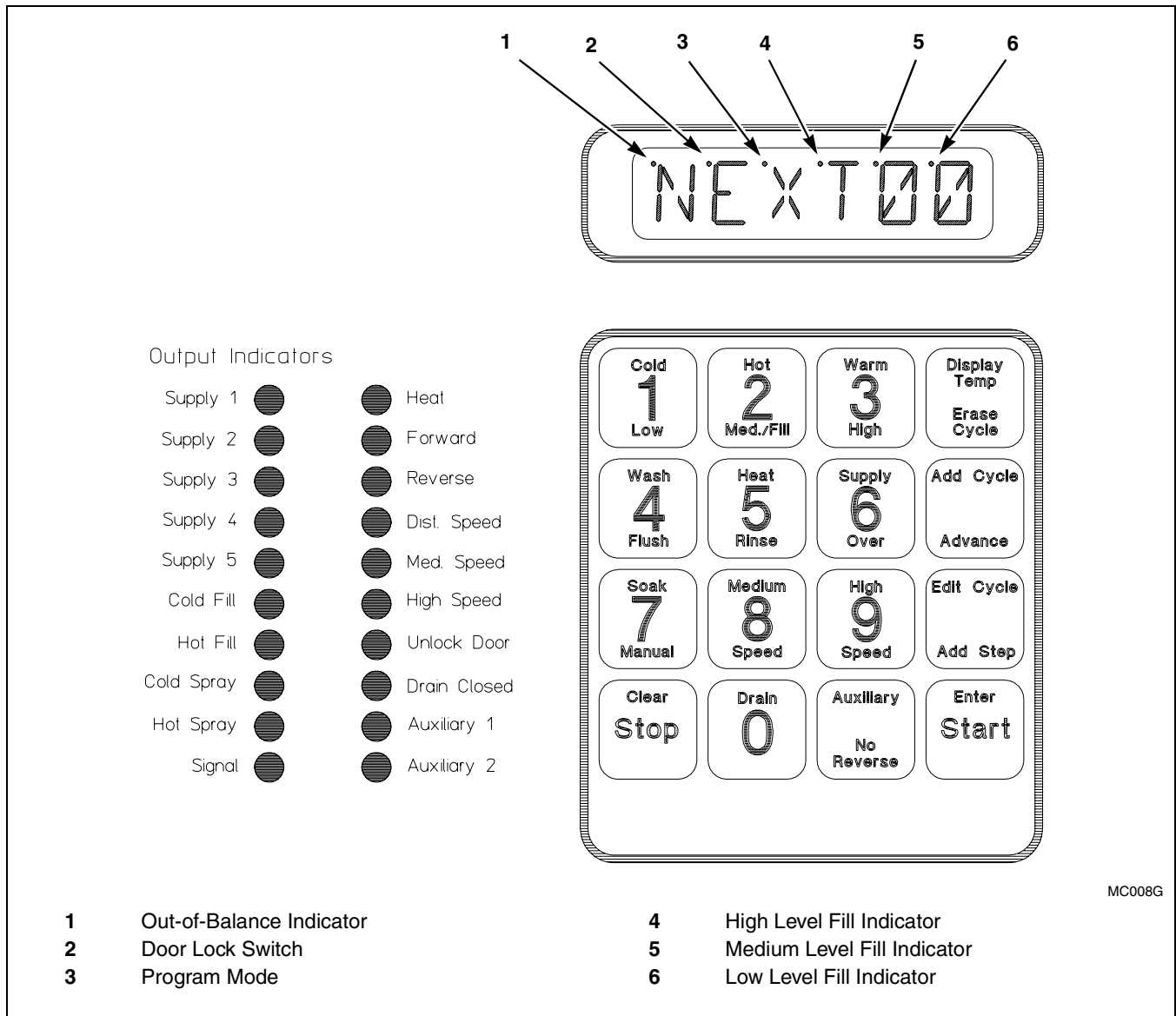

Figure 6

Pre-Operating Instructions

1. Press and release emergency stop button to direct power to control module. Models with the rotation sensor will display WE-6 Firmware ID code HRWC18 and later or ARWCO1 and later. Machine must perform a speed test. For models without rotation sensor, proceed to step 1 of *Operating Instructions*.
2. Display shows size of machine and will flash “TEST?” and “SPEED” for 15 seconds.
3. Push Start keypad during the 15 seconds. Machine will test rotation sensing for 15 seconds.
4. Display will flash “POWER” and “WAIT” one time and will display “NEXT00.”

NOTE: If START is not pushed while display flashes “TEST?” and “SPEED” or if rotation sensing fails, then display flashes “POWER” and “WAIT” before showing “NEXT00” for approximately 2 minutes.

Operating Instructions

1. When display shows “NEXT00,” washer-extractor is ready to be loaded with laundry.
2. On UW35 – UW125 models, use left hand to press and hold the door unlock button located on the lower right front of the control panel. Refer to *Figure 7*.

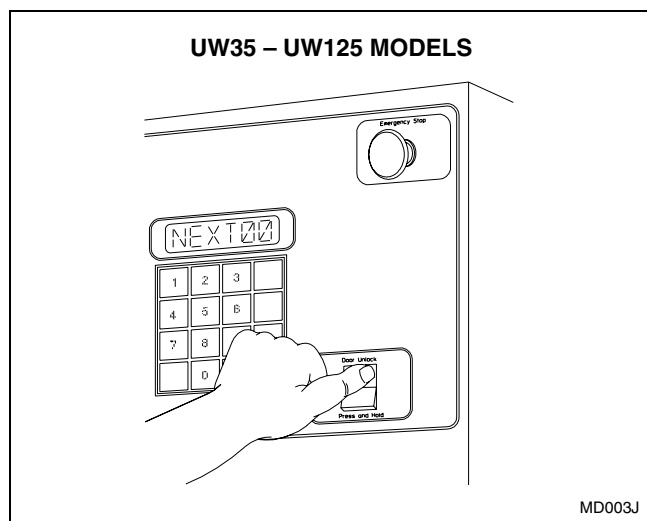
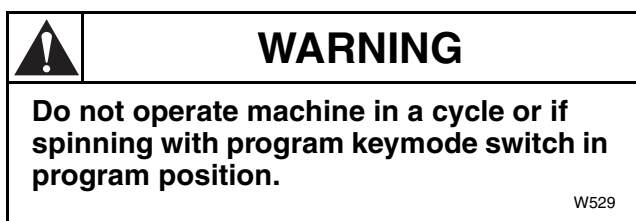
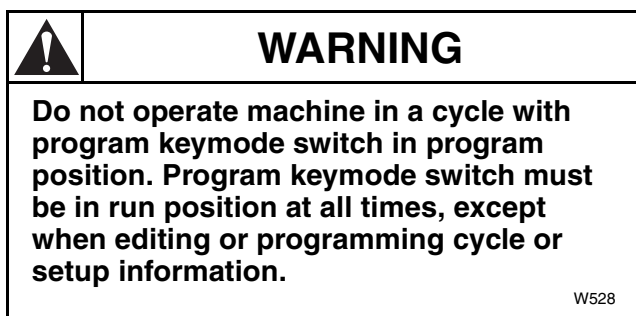

Figure 7



3. On UW35 – UW125 models, use right hand to turn door handle clockwise and swing the door left to open. Refer to *Figure 8*.

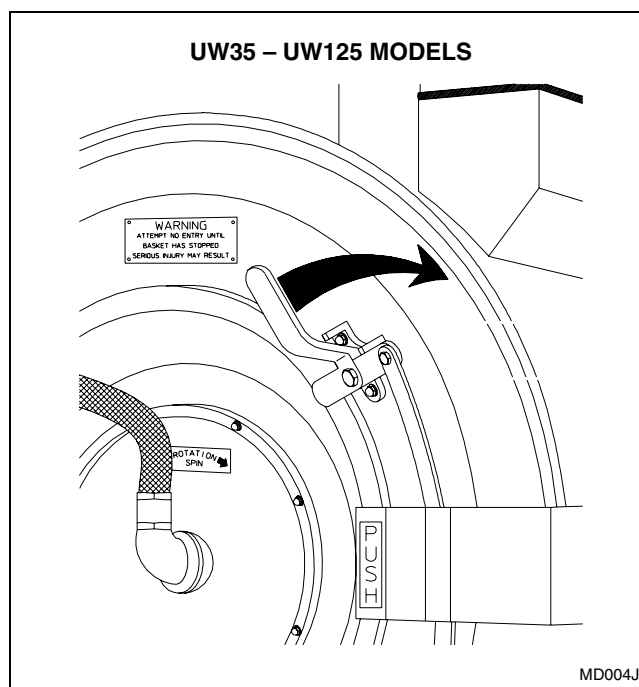

Figure 8

Operation

4. On UW150 models, use left hand to press and hold the door unlock button located on the door box. Refer to *Figure 9*.

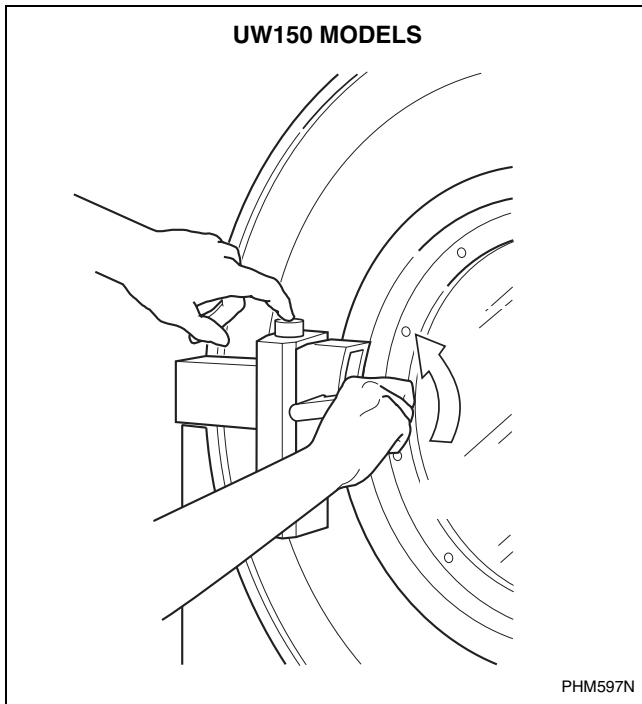

Figure 9

5. On UW150 models, use right hand to turn door handle counterclockwise and swing the door right to open. Refer to *Figure 9*.

6. Load the washer-extractor to full capacity whenever possible, but do not exceed the rated dry-weight capacity of the machine if the fabric to be washed is quite dense, closely woven, and heavily soiled.

Overloading can result in an inferior wash. The operator may need to experiment to determine load size based on fabric content, soil content, and level of cleanliness required. Do not underload the machine. Underloading can result in premature bearing and sealing failure and out-of-balance situations.

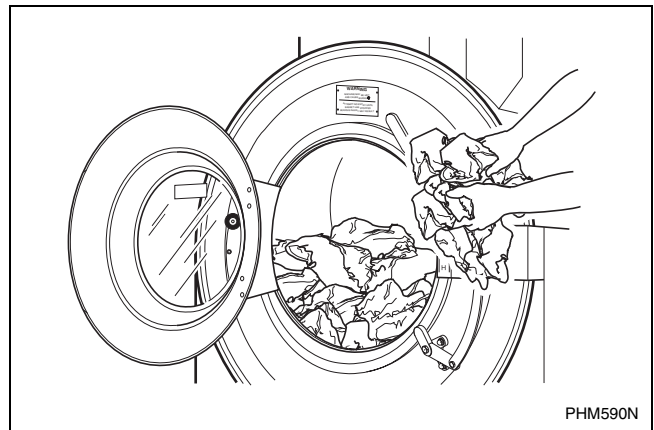



Figure 10

	CAUTION
<p>Be careful around the open door, particularly when loading from a level below the door. Impact with door edges can cause personal injury.</p>	
SW025	

NOTE: When washing items which may disintegrate or fragment, such as mop heads or sponges, use laundry nets to prevent drain blockage.

IMPORTANT: To prevent out-of-balance conditions, premature wear or damage to machine when using laundry nets, use several small nets in a load.

7. When loading is complete, ensure that all fabric is inside the basket. Then close and lock the door.
8. Add dry supplies are placed in the supply dispenser compartment cups prior to the start of each cycle.

Liquid supplies can be injected directly into the supply dispenser by an external chemical supply system.

NOTE: Supply dispenser compartment cups must *not* be removed when an external chemical injection supply system is attached to the washer-extractor.

9. Find the cycle number of the desired wash cycle from the preprogrammed cycle charts in the Programming section of this manual. Cycle numbers must be two-digit numbers from 01 to 39.

NOTE: Press keypads at their centers just hard enough to activate them.

Press the numbers desired on the keyboard and note that these numbers are displayed after “NEXT.”

When keypads are pressed on the keyboard, a signal will be heard. If an error is made, press the numbers again. As numbers are entered, they move from right to left on the display.

10. To start the selected cycle, press the Start keypad. If the selected cycle number is not in the control memory, the display will show “NCYC.” If this happens, select another cycle. Otherwise, the display will now show the first step. For example, if the display reads “HL01,” “HL” represents a hot fill to low level, and “01” indicates that this is the first step of the cycle.

As the cycle proceeds, the display will show the function being executed, the step number, and the cycle number selected. Pressing the Edit Cycle keypad while the cycle is running will cause the display to show the remaining cycle time in minutes. Pressing this keypad again will return the display to normal.

To begin the cycle at any step other than the first step, press the Advance keypad to advance through the cycle to the desired starting point. (The Advance keypad is enabled at the factory and can be disabled at the laundry site.) Then press the Start keypad.

It is possible to skip to the next step in a cycle, with the exception of a drain step: drain steps must be allowed time to complete.

When the display shows the step desired to begin the cycle, press the Start keypad.

If the door is not locked, the display will indicate “CLOSE” and “DOOR.” If this occurs, be sure the door is closed and locked and press the Start keypad again.

If the LED indicator lights for the control outputs indicate that one or more outputs are activated but the washer-extractor is not functioning according to the output or outputs indicated, contact a service technician.

As water fills the washer-extractor, one or more of the indicator lights located to the left of the keyboard will come on and stay on until the required water level is reached. LED dots located in the upper left corner of the last three digits on the right of the display will illuminate to indicate the water level(s) reached:

- When the indicator dot in the last digit on the right is lit, the low water level has been reached.
- When the dot in the next-to-the-last digit is lit, medium water level (optional) has been reached.
- When the dot over the third digit from the right has been lit, high level has been reached.

11. The cycle will continue until its completion. Then the display will read “DONE.”

Stop Routine

	WARNING
NEVER insert hands or objects into basket until it has completely stopped. Doing so could result in serious injury.	
<small>SW012</small>	

The operator can select the agitation which will be in effect for the STOP routine “shakeout.” To minimize cycle time, if rotation has stopped, the control shakeout time is brief. This will help prevent tangling of the load and provide maximum control. Three agitations are available for the STOP routine. They are as follows:

Wash 1

- 12 seconds forward
- 3 seconds pause
- 12 seconds reverse
- 3 seconds pause

Wash 2

- 3 seconds forward
- 27 seconds pause
- 3 seconds reverse
- 27 seconds pause

Wash 3

- no rotation

To select the agitation in the stop routine, program a Wash 1, 2, or 3 step for 1 second. *The washer-extractor will begin refilling to the most recent water level if the time is more than 1 second.* If the most recent wash type was Wash 4, 6, or 7, the WE-6 will default to no agitation (Wash 3) during the stop routine.

NOTE: If the desired action is not programmed in the final cycle step, the control will default to the most recent action in the cycle. If the cycle stops prematurely, the most recent action at the time the cycle is interrupted will be in effect during the stop routine.

The display will read “W1-cc,” “W2-cc,” or “W3-cc” for Wash 1, Wash 2, or Wash 3 action during the shakeout portion of the stop routine until the final 10 seconds. (The “cc” here stands for the current cycle number and will be represented by numbers in the actual display.) During the final seconds, the display reads “STOPcc.” The display will then read “DONEcc.” At that point, the door can be opened. If rotation is sensed, control does not allow door to open.

In stop routine, the coast time ensures a minimum time for coast. After the minimum, the control determines if rotation sensor is working, then a short shake-out routine begins when cylinder rotation stops. At the end of shake-out routine, “STOPxx” displays briefly, then displays “donExx”, if there is no rotation. If rotation is sensed, control does NOT show “donE” and prevents door from being opened. When no rotation is sensed, door can be opened.

NOTE: If control detects that rotation sensor is not working upon entering the stop routine, all stop procedure times default to maximum values. Refer to Programming manual for additional information.

Basket Jog Feature (UW150 Models Only)

Some UW150 models may be equipped with a basket jog feature. This feature allows the basket to rotate very slowly while the door is open for easy clothes removal. To operate the jog feature:

1. With the door open, press and HOLD the door unlock button.
2. While holding the door unlock button, press the jog operation button located on the bottom of the door box. Refer to *Figure 11*.

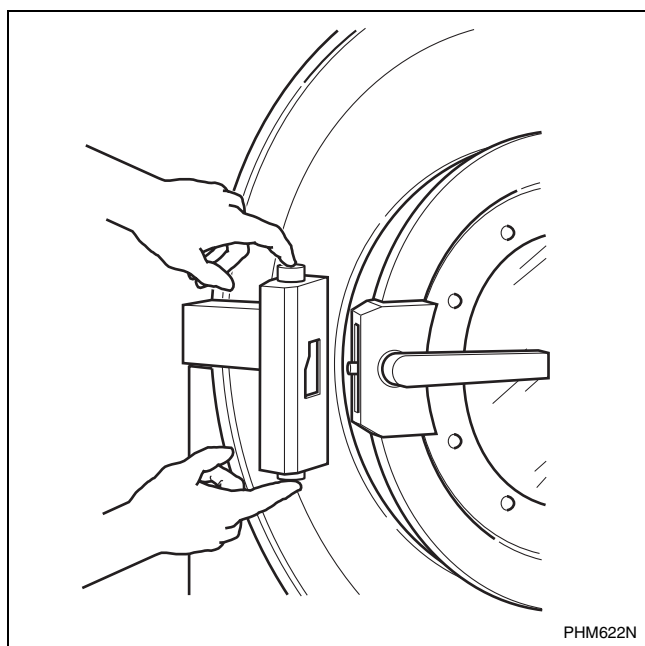

Figure 11

The jog feature is deactivated when the loading door is closed, the emergency stop button is pressed or when the cagewrap or rear panel is removed.

	WARNING
<p>To avoid personal injury, do NOT reach into the basket while it is rotating. Keep all personnel at a safe distance from the machine while using the basket Jog Feature.</p>	
W641	

Temperature Display

The temperature display can be prompted to display in Fahrenheit or Centigrade. Refer to Programming Manual.

To display temperature, press the Display Temp keypad. The display will read “F” or “C” and the temperature as long as the keypad is pressed. The control will update the display automatically.

Operation

Error Recovery Routine

When the control detects an error, it will stop running the current step and display a message to indicate what type of error was found:

- “FILL” indicates that the washer-extractor did not fill within the allotted time.
- “EMPTY” indicates that the washer-extractor did not drain in the allotted time.
- “TEMP” indicates that the temperature sensor has recognized a temperature above the programmed value.
- “MEMR” indicates that the control has detected a problem with the cycle information. The cycle must be edited.
- “WATER” indicates that the WE-6 control senses low, medium, or high water level at the end of the stop routine.
- “DRTEMP” indicates that the WE-6 has detected water temperature over 160°F in a “drain to reuse” step. Instead of draining to a tank, the control gives this error message. The cycle must be edited so the temperature is below 160°F upon entering a reuse drain step (“Da” or “Db”).

All outputs remain off while the message displays, and the door cannot be unlocked.

NOTE: The WE-6 control will not allow the door to be opened while there is water in the washer-extractor.

Each of these errors is considered to be recoverable. The operator has two minutes to respond to the error condition (except in the case of “WATER”). During this time, the control will turn the signal (buzzer) relay on and off at the rate of one second on and one second off to alert the operator to the error condition. The washer-extractor may be restarted by pressing the Start keypad. Pressing the Start keypad will restart the cycle step for the originally programmed time period. “WATER” will remain displayed until the error is corrected. The cycle may be aborted by pressing the Stop keypad. After aborting the cycle, the control will go to the normal stop routine. If the operator does not respond to the error condition within the allocated two minutes, the control will automatically abort the cycle.

NOTE: The “TEMP” alarm can be recovered only after the temperature falls below the alarm level.

Certain error conditions are considered to be non-recoverable:

- If the door opens during a cycle, the control will display “DOOR.” The operator must close the door.
Then, after the control has detected that the door is closed, it will automatically abort the cycle and go to the normal stop routine.
- “OVERHT” will be displayed when the control detects an open or shorted temperature input circuit or temperatures are outside of the washer-extractor’s allowable limits. Contact a service technician.

Maintenance

Routine maintenance maximizes operating efficiency and minimizes downtime. The maintenance procedures described below will prolong the life of the machine and help prevent accidents.

	WARNING
Be careful when handling sheet-metal parts. Sharp edges can cause personal injury. Wear safety glasses and gloves, use the proper tools, and provide adequate lighting.	
SW035	

	CAUTION
Replace all panels that are removed to perform service and maintenance procedures. Do not operate the machine with missing guards or with broken or missing parts. Do not bypass any safety devices.	
SW019	

Daily, weekly, monthly, and quarterly checklists are provided at the end of this section. Laminate the checklists to preserve them for repeated copying. Operators and technicians are encouraged to add checks specific to their washer-extractor's particular application. Where possible, space is provided on the checklists for this purpose.

The following maintenance procedures must be performed regularly at the required intervals.

Daily

Beginning of Day

1. Inspect water inlet valve hose connections on the back of the washer-extractor for leaks.
2. Inspect steam hose connections for leaks (where applicable).

	WARNING
To reduce the risk of electrical shock, serious injury or death, disconnect the electrical power to washer-extractor before examining the wiring.	
W636	

3. Verify that insulation is intact on all external wires and that all connections are secure. If bare wire is evident, call a service technician.
4. Check door interlock before starting operation:
 - a. Attempt to start the washer with the door open. The washer should not start with the door open.
 - b. Close the door without locking it and attempt to start the washer. The washer should not start with the door unlocked.
 - c. Close and lock the door and start a cycle. Attempt to open the door while the cycle is in progress. The door should not open.If the door lock and interlock are not functioning properly, call a service technician.
5. If the washer-extractor is equipped with the Premium Wet Clean Module, inspect all water recirculation pipe connections and ensure that they are tight and do not leak.

Maintenance

End of Day

1. Clean the AC drive filter:
 - a. Snap off the external plastic cover which contains the filter.
 - b. Remove the foam filter from the cover.
 - c. Wash the filter with warm water and allow to air dry. Filter can be vacuumed clean.
2. Clean the door gasket of residual detergent and all foreign matter.
3. Clean automatic supply dispenser and lid inside and out with mild detergent. Rinse with clean water.
4. Clean powder dispenser and lid with mild detergent. Rinse with clean water.
5. Clean washer's top, front, and side panels with mild detergent. Rinse with clean water.
6. Leave loading door open at the end of each day to allow moisture to evaporate.
7. If the washer-extractor is equipped with the Premium Wet Clean Module, clean the water recirculation filter, located in the canister, of all debris.

NOTE: Unload the washer-extractor promptly after each completed cycle to prevent moisture buildup. Leave loading door open at the end of each completed cycle to allow moisture to evaporate.

Weekly

1. Check the washer-extractor for leaks.
 - a. Start an unloaded cycle to fill the washer-extractor.
 - b. Verify that door and door gasket do not leak.
 - c. Verify that the drain valve is operating and that the drain system is free from obstruction. If water does not leak out during the prewash segment, drain valve is closed and functioning properly.

Monthly

NOTE: Disconnect power to the washer-extractor at its source before performing the monthly maintenance procedures.

1. Each month OR after every 200 hours of operation, lubricate bearings. (Locate the bearing lubrication decal at the rear of the right side of the machine, as viewed from the front of the washer-extractor.)

The grease must have the following characteristics:

- NLGI Grade 2
- Lithium-based
- Water-insoluble
- Anti-rusting
- Anti-oxidizing
- Mechanically stable

The grease must have adequate base oil viscosity with one of the following ratings:

- ISO VG 150 (135 – 165 cSt at 40°C or 709 – 871 SUS at 100°F)
- ISO VG 220 (198 – 242 cSt at 40°C or 1047 – 1283 SUS at 100°F)
- An SAE 40 rating is also acceptable as long as the cSt or SUS values are within the specified ranges.

Pump the grease gun slowly, permitting only 2 strokes.

2. Use the following procedures to determine if V-belts require replacement or adjustment. Call a qualified service technician in either case.
 - a. Check V-belts for uneven wear and frayed edges.
 - b. After disconnecting power to the washer-extractor and removing all panels necessary for access to the drive belt, use one of the following methods to verify that V-belts are properly tensioned.

- **Tension Gauge.** Loosen motor mounting bolts and slide motor along motor plate to change belt span length. The belt tension on UW35 – UW125 models should be between 70 and 90 pounds (± 5 pounds). The belt tension on the UW150 should be between 130 and 150 pounds (± 5 pounds). (Set initial tension toward the high end of this range.) The UW150 uses a swing mount motor with an adjustable spring used for tensioning.
- **Deflection.** Refer to *Figure 12*. Loosen motor mounting bolts and slide motor along motor plate to change belt span length. Belt tension measurements should be taken as close to the center of the belt span as possible. For every inch of span length, the belt should deflect 1/64 inch (0.40 mm). Thus, a belt with span length of 50 inches should deflect 50/64 inch (19.84 mm). An initial (run-in) force of 5.25 pounds should be used to set the belt tension. An operating (normal) force of 3.5 pounds should be used after the washer-extractor has been operated for a few hours.

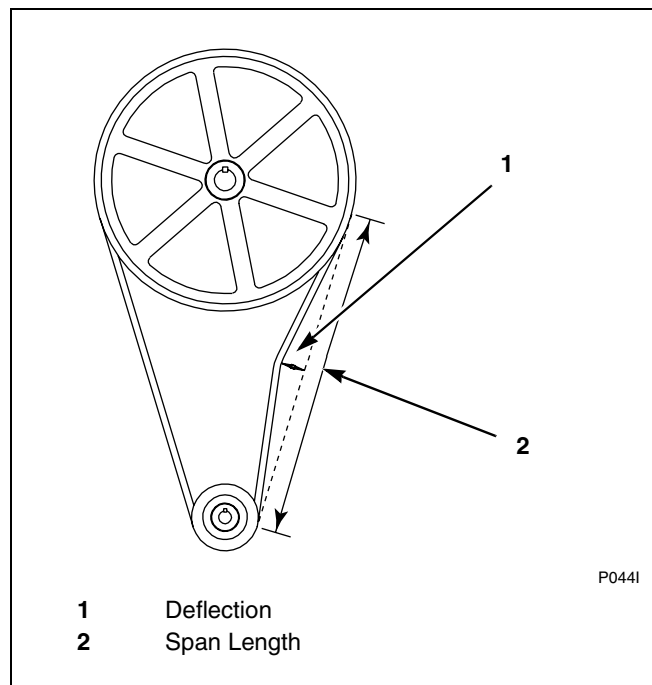

Figure 12

Maintenance

- c. Verify that V-belts are properly aligned by checking pulley alignment. Place a straightedge across both pulley faces. The straightedge should make contact with the pulleys in four places. Refer to *Figure 13*.

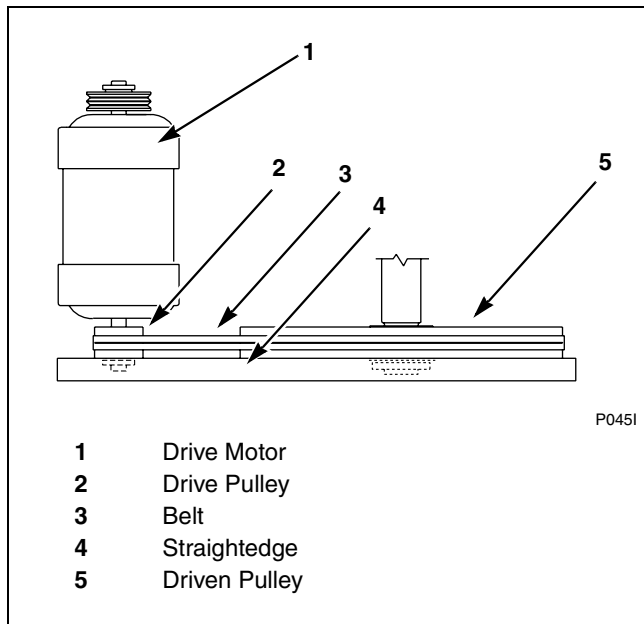

Figure 13

3. Remove back panel and check overflow hose and drain hose for leaks.
4. Unlock the hinged lid and check the supply dispenser hoses and hose connections.
5. Clean inlet hose filter screens:
 - a. Turn water off and allow valve to cool, if necessary.
 - b. Unscrew inlet hose and remove filter screen.
 - c. Clean with soapy water and reinstall. Replace if worn or damaged.
6. Tighten motor mounting bolt locknuts and bearing bolt locknuts, if necessary.
7. Use compressed air to clean lint from motor.
8. Clean interior of washer-extractor, both basket and shell, by wiping with a water-soaked sponge or cloth.
9. Use compressed air to ensure that all electrical components are free of moisture and dust.
10. Remove chemical supply components and check for residual chemicals. Clean as necessary and replace.

Quarterly

NOTE: Disconnect power to the washer-extractor before performing the quarterly maintenance procedures.

1. Tighten door hinges and fasteners, if necessary.
2. Tighten anchor bolts, if necessary.
3. Verify that the drain motor shield is in place and secure.
4. Check all painted surfaces for bare metal. (Matching gray paint is available from the manufacturer.)
 - If bare metal is showing, paint with primer or solvent-based paint.
 - If rust appears, remove it with sandpaper or by chemical means. Then paint with primer or solvent-based paint.
5. Clean steam filter, where applicable.
 - a. Turn off steam supply and allow time for the valve to cool.
 - b. Unscrew nut.
 - c. Remove element and clean.
 - d. Replace element and nut.

Care of Stainless Steel

- Remove dirt and grease with detergent and water. Thoroughly rinse and dry after washing.
 - Avoid contact with dissimilar metals to prevent galvanic corrosion when salty or acidic solutions are present.
 - Do not allow salty or acidic solutions to evaporate and dry on stainless steel. Wipe clean of any residues.
 - Rub in the direction of the polish lines or “grain” of the stainless steel to avoid scratch marks when using abrasive cleaners. Use stainless steel wool or soft, non-metal bristle brushes. Do not use ordinary steel wool or steel brushes.
 - Remove discoloration or heat tint from overheating by scouring with a powder or by employing special chemical solutions.
- Do not leave sanitizers or sterilizing solutions on stainless steel equipment for prolonged periods of time.
 - When an external chemical supply is used, ensure no siphoning of chemicals occurs when the washer-extractor is not in use. Highly concentrated chemicals can cause severe damage to stainless steel and other components with the machine. Damage of this kind is not covered by the manufacturer’s warranty. Locate the pump below the washer-extractor’s injection point to prevent siphoning of chemicals into the machine.
 - If the stainless steel appears to be rusting the source of the rust may actually be an iron or steel part not made of stainless steel, such as a nail or screw. Tip: Paint all carbon steel parts with a heavy protective coating. Stainless steel fasteners should be used whenever possible.

Maintenance

Daily Preventive Maintenance Checklist

Machine _____	Week of: _____						
Operator _____	Days						
Checks	1	2	3	4	5	6	7
Observe All Safety Warnings! Disconnect power to the machine before performing the daily maintenance procedures.							
Beginning of Day							
1. Inspect water inlet valve hose connections on the back of the washer-extractor for leaks.							
2. Inspect steam hose connections for leaks, where applicable.							
3. Verify that insulation is intact on all external wires and that all connections are secure.							
4. Inspect door lock and interlock before starting operation:							
a. Attempt to start the washer with door open.							
b. Close the door without locking it and attempt to start the washer.							
c. Close and lock the door, start a cycle, and attempt to open the door while the cycle is in progress.							
5. Inspect all water recirculation pipe connections, if applicable.							
End of Day							
1. Clean the AC drive box filter(s).							
2. Clean the door gasket of all foreign matter.							
3. Clean automatic supply dispenser and lid.							
4. Clean the washer's top, front, and side panels.							
5. Leave loading door open at the end of each day to allow moisture to evaporate.							
6. Clean water recirculation filter, if applicable.							
NOTE: Unload the machine promptly <i>after each completed cycle</i> to prevent moisture buildup. Leave loading door open after each completed cycle to allow moisture to evaporate.							

Weekly Preventive Maintenance Checklist

Machine _____	Month _____				
Operator _____	Week Ending:				
Checks	/	/	/	/	/
Observe All Safety Warnings! Disconnect power to the machine before performing the weekly maintenance procedures.					
1. Check the washer-extractor for leaks:					
a. Start an unloaded cycle to fill the machine.					
b. Verify that door and door gasket do not leak.					
c. Verify that the drain valve is operating.					
2.					
3.					
4.					
5.					
6.					
7.					

Monthly Preventive Maintenance Checklist

Machine _____ Operator _____	Month			
Checks				
Observe All Safety Warnings! Disconnect power to the machine before performing the monthly maintenance procedures.				
1. Each month OR every 200 hours of operation, lubricate bearings.				
2. Clean the AC drive fins.				
3. Determine if V-belts require replacement or adjustment:				
a. Check V-belts for uneven wear and frayed edges.				
b. Verify that V-belts are properly tensioned.				
c. Verify that V-belts are properly aligned.				
4. Remove back panel and check hoses for leaks.				
5. Unlock the hinged lid and check supply dispenser hoses and connections.				
6. Clean inlet hose filter screens. Replace if worn or damaged.				
7. Tighten motor mounting bolt locknuts and bearing bolt locknuts, if necessary.				
8. Use compressed air to clean lint from motor.				
9. Clean interior of washer-extractor, both basket and shell, by wiping with a water-soaked sponge or cloth.				
10. Use compressed air to clean moisture and dust from all electrical components.				
11.				
12.				
13.				
14.				

Quarterly Preventive Maintenance Checklist

Machine _____ Operator _____	Quarter			
Checks				
Observe All Safety Warnings! Disconnect power to the machine before performing the quarterly maintenance procedures.				
1. Tighten door hinges and fasteners, if necessary.				
2. Tighten anchor bolts, if necessary.				
3. Verify that the drain motor shield is in place and secure.				
4. Check all painted surfaces for bare metal. Repair, if necessary.				
5. Clean steam filter, if applicable.				
6.				
7.				
8.				
9.				
10.				
11.				

Free Manuals Download Website

<http://myh66.com>

<http://usermanuals.us>

<http://www.somanuals.com>

<http://www.4manuals.cc>

<http://www.manual-lib.com>

<http://www.404manual.com>

<http://www.luxmanual.com>

<http://aubethermostatmanual.com>

Golf course search by state

<http://golfingnear.com>

Email search by domain

<http://emailbydomain.com>

Auto manuals search

<http://auto.somanuals.com>

TV manuals search

<http://tv.somanuals.com>