

# NetMaster

## Topload Washer

Refer to Page 7 for Model Numbers

— Programming

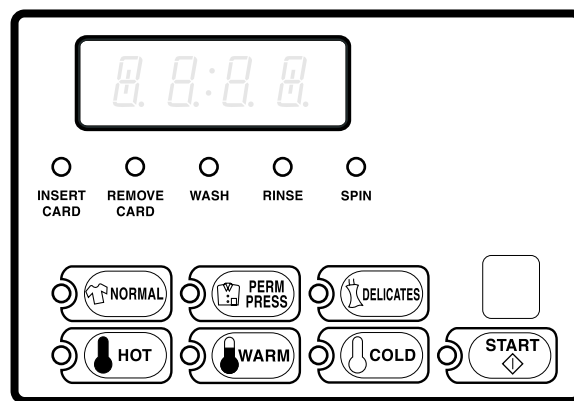

C8321

### Keep These Instructions for Future Reference.

(If this machine changes ownership, this manual must accompany machine.)



[www.comlaundry.com](http://www.comlaundry.com)

Part No. 210140R2  
October 2006





## WARNING

Failure to install, maintain, and/or operate this machine according to the manufacturer's instructions may result in conditions which can produce bodily injury and/or property damage.

W030

**NOTE: The WARNING and IMPORTANT instructions appearing in this manual are not meant to cover all possible conditions and situations that may occur. It must be understood that common sense, caution, and carefulness are factors which cannot be built into these washers. These factors MUST BE supplied by the person(s) installing, maintaining, or operating the washer.**

Always contact the distributor, service agent, or the manufacturer about any problems or conditions you do not understand.



# Table of Contents

<b>Model Identification</b> .....	7
<b>Preliminary Information</b> .....	9
About the Control .....	9
Glossary of Terms.....	9
Power Failure Recovery .....	9
Communications .....	9
Infra-red Communications (Optional) .....	9
<b>NetMaster Identification</b> .....	11
Select Cycle Pads.....	11
Select Wash Temp Pads.....	11
<b>VFD Display Identification</b> .....	13
Light Emitting Diodes (LEDs) .....	13
<b>Washer Operation</b> .....	15
Start Up.....	15
Ready Mode.....	15
Cycle Sequence.....	15
Opening the Washer Lid.....	15
Signals.....	15
Changing Cycles.....	15
<b>NetMaster Special Features</b> .....	17
Programming NetMaster .....	17
Collecting Audit Information .....	17
Testing Machine and NetMaster Functions.....	17
Sales Floor Feature .....	17
Rapid Advance Feature.....	17
Clearing the NetMaster Vend Feature .....	17
Communications Mode.....	17
Coin Drop .....	17
Start Pulse Operation .....	18
Service Door and Coin Vault Openings .....	18
Break-In Alarm.....	18
Special Vend.....	18
Lucky Cycle.....	18
Site Code Pricing .....	18
Special Cycle .....	18
<b>Opening the Service Door</b>	
<b>(Coin Models Only)</b> .....	19
<b>Entering the Manual Mode</b> .....	21
How to Enter the Manual Mode .....	21
<b>Programming NetMaster</b> .....	23
What Can Be Programmed? .....	23
Programmable Options Available.....	23
1. Audio Signal “+001” .....	24
2. Reg. Hot Wash Vend Price “+002” .....	26
3. Reg. Warm Wash Vend Price “+003” .....	28
4. Reg. Cold Wash Vend Price “+004” .....	30
5. Site Code #1 Hot Wash Vend Price “+005” .....	32
6. Site Code #1 Warm Wash Vend Price “+006” .....	34
7. Site Code #1 Cold Wash Vend Price “+007” .....	36
8. Special Cycle Vend Price “+008” .....	38
9. Special Vend A Days Enable “+009” .....	40
10. Special Vend A Start Hour “+010” .....	45
11. Special Vend A Length in Hours “+011” .....	46
12. Special Vend A Start Month “+012” .....	47
13. Special Vend A Start Date “+013” .....	48
14. Special Vend A End Month “+014” .....	49
15. Special Vend A End Date “+015” .....	50

© Copyright 2006, Alliance Laundry Systems LLC

All rights reserved. No part of the contents of this book may be reproduced or transmitted in any form or by any means without the expressed written consent of the publisher.

16. Special Vend A Site Code #1 "+016"	51
17. Special Vend A Reg. Hot Wash Vend Price "+017"	53
18. Special Vend A Reg. Warm Wash Vend Price "+018"	55
19. Special Vend A Reg. Cold Wash Vend Price "+019"	57
20. Special Vend A Auto-Shutdown Enable "+020"	59
21. Coin #1 Value "+021"	60
22. Coin #2 Value "+022"	62
23. Start Pulse Value "+023"	64
24. Default Cycle/Temperature "+024"	66
25. Power Fail Reset "+025"	68
26. Set Real-Time Clock Minutes "+026"	70
27. Set Real-Time Clock Hours "+027"	71
28. Set Real-Time Clock Day "+028"	72
29. Set Real-Time Clock Date "+029"	73
30. Set Real-Time Clock Month "+030"	74
31. Set Real-Time Clock Year "+031"	75
32. Set Real-Time Clock Century "+032"	76
33. Normal Wash Agitate Time "+033"	77
34. Normal Extra Rinse Agitate Time "+034"	78
35. Normal Rinse Agitate Time "+035"	79
36. Normal Final Spin Time "+036"	80
37. Permanent Press Wash Agitate Time "+037"	81
38. Permanent Press Extra Rinse Agitate Time "+038"	82
39. Permanent Press Rinse Agitate Time "+039"	83
40. Permanent Press Final Spin Time "+040"	84
41. Delicate Wash Agitate Time "+041"	85
42. Delicate Extra Rinse Agitate Time "+042"	86
43. Delicate Rinse Agitate Time "+043"	87
44. Delicate Final Spin Time "+044"	88
45. Warm Rinse Enable/Disable "+045"	89
46. Control Configuration Data #1 "+046"	90
47. Control Configuration Data #3 "+047"	94
48. Lucky Option "+048"	96
49. Special Cycle Option "+049"	97
50. Special Cycle Extra Wash Time "+050"	99
51. Special Cycle Extra Extra-Rinse Time "+051"	100
52. Smart Card Maximum Value "+052"	101
53. Site Code #1 "+053"	103
54. Error Code Programming Parameter "+054"	105
55. Start Pulse Mode "+055"	107
<b>Collecting Audit Information</b>	109
<b>Manual Reset</b>	111
<b>Testing Machine and</b>	
<b>Electronic Control Functions</b>	113
Diagnostic Test Descriptions	114
<b>Error Codes</b>	117
<b>Sales Floor Feature</b>	121
<b>Rapid Advance Feature</b>	123
<b>Clear Vend Feature</b>	125
<b>Power Fail Recovery</b>	127
Power Fail Reset Disabled	127
Power Fail Reset Enabled	127
<b>Communications Mode</b>	129
Infra-red Communications	129

Card Reader Communications	
(Card Models Only).....	129
Network Communications .....	129
<b>Default Washer Settings</b> .....	131
Default Settings .....	131
Default Cycle .....	131





# Model Identification

Information in this manual is applicable to these washer models:

HWTB21	SWTB20
HWTF21	SWTB21
NWTF21	SWTC20
SWLB20	SWTC21
SWLB21	SWTF20
SWLF20	SWTF21
SWLF21	SWTH20
SWTA21	SWTH21
SWTBA0	SWTJ21
SWTBA1	



# Preliminary Information

## About the Control

NetMaster on the commercial washer is an advanced, programmable computer that lets the owner control most machine features by pressing a sequence of SELECT CYCLE and SELECT WASH TEMP pads. Refer to *Figure 1*.

NetMaster allows the owner to program custom cycles, set vend prices, retrieve audit information, program and run diagnostic cycles, and program special vend features. Washers shipped from the factory have a default cycle and wash temperature setting of PERM PRESS, WARM built in. However, the owner can change the default cycle, or any cycle, as needs permit.

**IMPORTANT: In the event of a power failure, NetMaster will not have to be reprogrammed. It is designed with a memory system that will remember how it was programmed (for a minimum of six years) until the electrical power is restored.**

**IMPORTANT: It is extremely important that the washer has a positive ground and that all mechanical and electrical connections to NetMaster are made before applying power to or operating the washer.**

## Glossary of Terms

The following are a few terms and abbreviations to learn. These are referred to throughout the instructions.

VFD - Vacuum Fluorescent Display.  
This term refers to the window area of the control that displays words and values.

LED - Light Emitting Diode.  
This term refers to the lights on the keypads and status words of the control.

## Power Failure Recovery

If a cycle is in progress and the power fails, the cycle status is saved in memory for a minimum of six years without power. When the power recovers, the washer will resume into the previously active cycle if so programmed by the owner.

The owner may program a special feature called POWER FAIL RESET which sets a maximum power failure duration. To program this feature, refer to *Programming NetMaster, option 25*.

If the length of the power failure is greater than the POWER FAIL RESET time, the control will end the cycle and the display will revert back to the ready mode. If the washtub is full of water, the control will

move to the Rinse Spin cycle and prompt the user to press the START pad. Once the START pad is pressed, the control will spin out the cycle.

## Communications

NetMaster may be programmed manually, by the Micro-Wand IIIE™, by the Network, or by a Smart Card.

## Infra-red Communications (Optional)

The Micro-Wand allows the owner to program and retrieve information from NetMaster without touching the keypad. The Micro-Wand greatly expands the programming options available to the owner. However, the Micro-Wand is not required to program and operate the washer. The operation of the Micro-Wand and the advanced features available are covered separately in the Micro-Wand IIIE™ instruction manual.

## Smart Card Reader Communications (Card Models Only)

The control will accept communication with a Card Reader in order to perform vending transactions when a card is inserted to pay for cycles. The card reader can also allow the owner to program and collect audit information.

For detailed information on Smart Card Reader Communications, refer to the Smart Card Setup Module in the NetMaster Smart Card Suite software package.

## Network Communications

The control will also accept communication with a Network Interface Board which allows the control to be linked to a personal computer. This network link allows an owner to program, collect data and run diagnostics on any machine.

For detailed information on Network Communications, refer to the Network instruction manual.



# NetMaster Identification

## Select Cycle Pads (Refer to Figure 1)

SELECT CYCLE pads are used to select the specific washer cycle. These pads include NORMAL, PERM PRESS, and DELICATES. These pads allow the user to select a cycle other than the default cycle (PERM PRESS). The SELECT CYCLE keypads are not active after the first fill cycle of the washer. The selected cycle is indicated by the light (LED) on the pad. Pressing the START pad will confirm the selection and the cycle will begin. When the Smart Card is used, the START pad flashes. Pressing the START pad will start the cycle and deduct the vend price from the card.

## Select Wash Temp Pads (Refer to Figure 1)

SELECT WASH TEMP pads are used to select the temperature of the water used for the wash fill. These pads include HOT, WARM, and COLD. These pads allow the user to select a water temperature other than the default setting (WARM). The SELECT WASH TEMP pads are active only during the first fill cycle of the washer. The selected temperature is indicated by the light (LED) on the pad.

Both the SELECT WASH TEMP pads and the SELECT CYCLE pads are used in various combinations for programming cycles, retrieving audit information, running diagnostic tests, and other hidden operations. These instructions cover the manual programming and data retrieval options.

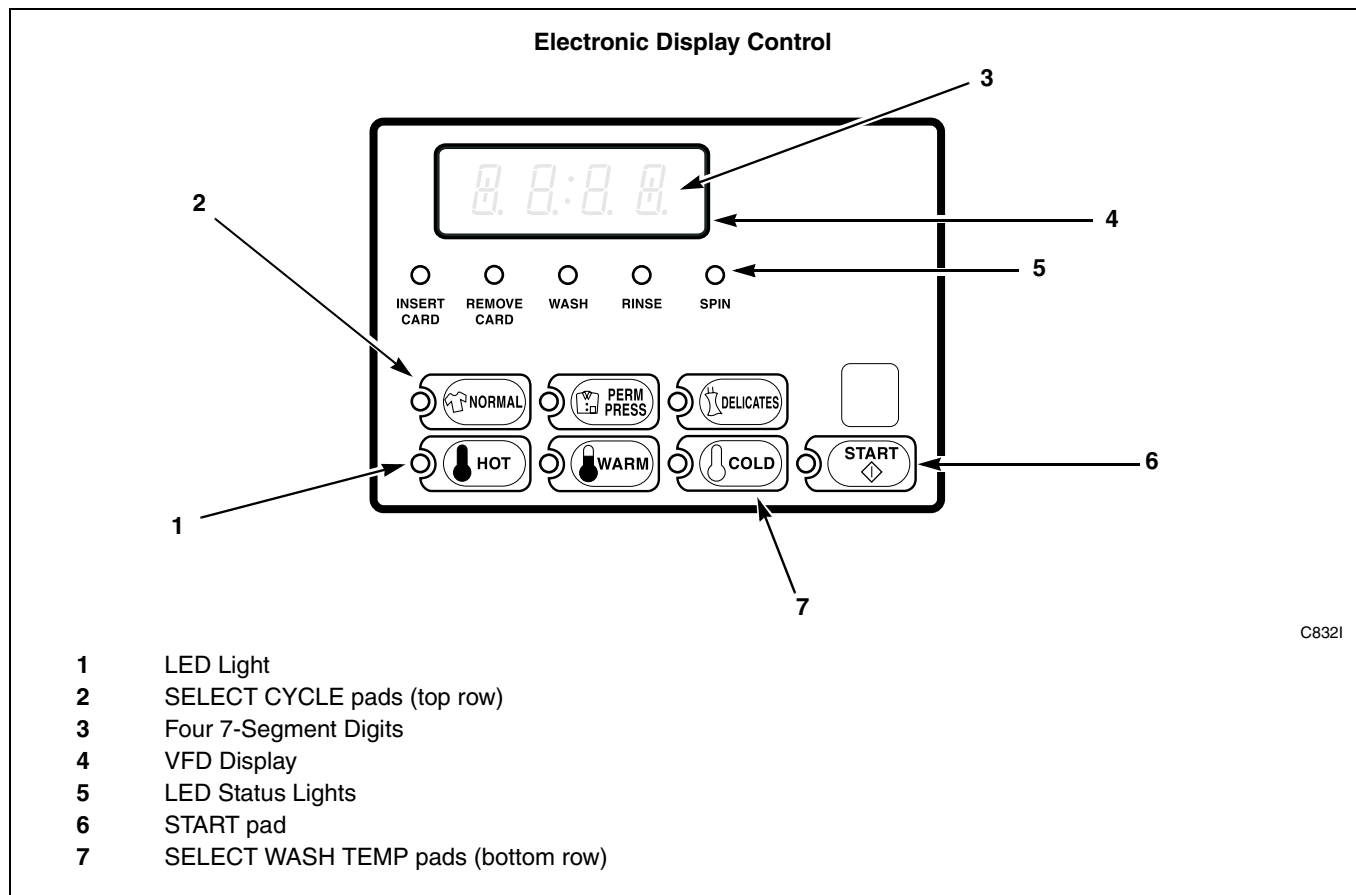

Figure 1



# VFD Display Identification

## Light Emitting Diodes (LEDs) (Refer to *Figure 1*)

LIGHT EMITTING DIODES (LEDs) are used to indicate the chosen cycle, wash temperature and cycle status. See below for information on each LED.

### **CYCLE LED (NORMAL, PERM PRESS or DELICATES)**

*CYCLE* LED will remain lit the entire cycle.

### **WASH TEMP LED (HOT, WARM or COLD)**

*WASH TEMP* LED will remain on until the end of the cycle or will change to a rinse temperature if programmed to do so.

### **WASH LED**

*WASH* LED is lit at the beginning of a Wash cycle and will remain lit until the wash cycle is complete.

### **RINSE LED**

*RINSE* LED is lit at the beginning of the Rinse or Extra Rinse cycle and will remain lit until the cycle is complete.

### **SPIN LED**

*SPIN* LED is lit for all Spin cycles.

## **INSERT COINS/CARD LED**

*INSERT COINS/CARD* LED prompts the user for coins or a card to satisfy the vend price. Four digits and decimal point show the vend price remaining to be satisfied. The vend price displayed will decrease with each coin inserted. If a new wash temp is selected during the first fill of the wash cycle and it requires additional vend, the *INSERT COINS/CARD* light will flash one (1) second on and one (1) second off, and the display will show the vend price remaining to be satisfied.

## **REMOVE CARD LED (Card Models Only)**

*REMOVE CARD* LED flashes one second on and one second off after the START pad has been pressed and the vend has been deducted from the card. It will also flash when a card is inserted and no vend amount is required.

## **Four 7-Segment Digits**

The 7-SEGMENT DIGITS are used to display the time remaining in a cycle, vend price, error messages and descriptive codes. When displaying the time remaining the colon will flash, and when displaying the vend price the decimal point may be lit. During diagnostic testing or manual programming of the control, these digits will display descriptive codes and values (as described in *Entering the Manual Mode*).





# Washer Operation

## Start Up

When power is applied to the washer, the control will display *INSERT COINS/CARD*, the decimal point, and the vend price. The *INSERT COINS/CARD* light will remain lit until the vend price has been satisfied. The default cycle setting is PERM PRESS, the default wash water fill temperature is WARM, and the default rinse water temperature is COLD. The LEDs will be lit on PERM PRESS and WARM at the start of the cycle. Refer to *Figure 2*. These default settings are owner programmable. Refer to *Programming NetMaster*.

## Ready Mode

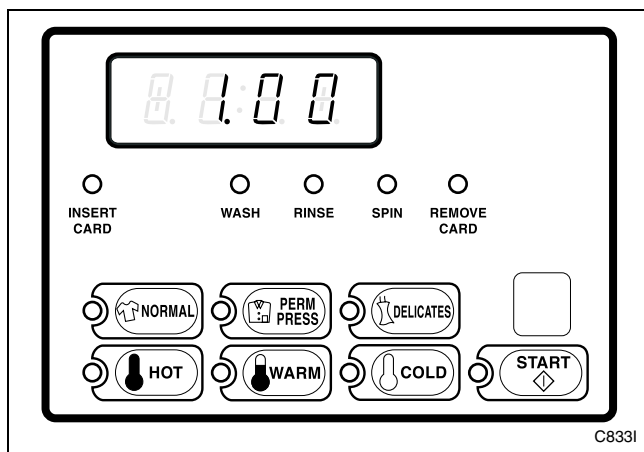

Figure 2

To start the cycle, the user must press the START keypad.

The user will be able to select a different cycle or wash water temperature by pressing a cycle pad when the machine is in the ready mode or in the first fill cycle. If not enough vend is entered to satisfy the vend price, the control will display the remaining vend price needed to start the cycle. If the first fill was interrupted to change the temperature (which requires more money), and the vend price is not satisfied within 1 minute, the washer control will go back to the first selection and the cycle will restart. After the first fill, all key presses will be ignored, allowing the washer to go through the complete cycle.

When a cycle is complete, the control will display “:00” until the lid is opened, a key is pressed, or a coin/card is entered. When one of these three options occur, the display will revert back to the ready mode. Refer to *Figure 2*.

## Cycle Sequence

Upon the start of a cycle, NetMaster will display the total cycle time. The appropriate LEDs will light while the machine passes through different cycle steps. Any

coin entered after the first fill cycle will be added to the total coin counter, but the user will not be able to change cycles or water temperature.

## Opening the Washer Lid

If the washer lid is opened anytime except the last three minutes of a cycle, the VFD will display “Lid” and the timer will stop. Once the lid is closed, the cycle will restart from the point of interruption. If the lid is opened in the final three minutes of the final spin cycle, the timer will continue to count down to the end of the cycle. The cycle operation will stop and the VFD will display “Lid”. When the timer reaches 0 minutes, the control will return to the “Ready” mode. Refer to *Figure 2*.

## Signals

There are four options when a signal can be used during the washer operation. These four options are listed below:

- 1. End of Cycle Signal**  
By default, this signal is turned off. If turned on, the signal sounds for three (3) seconds at the end of a cycle.
- 2. Signal On Keypad Depression**  
By default, this signal is turned on and sounds for a quarter of a second each time a keypad is pressed.
- 3. Signal On Coin Drop/Card Insertion**  
By default, this signal is turned on and will sound for a quarter of a second each time a coin or card is entered.
- 4. Signal for Card Removal (Card Models Only)**  
By default, this signal is turned on and will sound one second on and one second off when the *REMOVE CARD* LED is flashing.

**NOTE:** Refer to *Programming NetMaster* to program signal options.

## Changing Cycles

Cycles and wash temperatures can be changed anytime during the first fill cycle. After the first fill cycle, all key presses are ignored.

Selecting a higher priced wash temperature will stop the first fill cycle, and *INSERT COINS/CARD* will flash one (1) second on and one (1) second off until the vend price has been satisfied. After the vend price has been satisfied, the cycle will restart with the new wash temperature. If the vend price is not satisfied within 1 minute, the washer control will go back to the previously set wash temperature.



# NetMaster Special Features

## Programming NetMaster

NetMaster allows the washer owner to program the control with the use of the keypad. Audit, diagnostic, cycle and vend information may be programmed and retrieved by pressing combinations of the Select Cycle and Select Wash Temp pads.

For details on programming cycle and vend information, refer to *Programming NetMaster*.

## Collecting Audit Information

The control will store audit information in its memory that can be retrieved by pressing various combinations of Select Cycle and Select Wash Temp pads. NetMaster will record coins entered, total wash cycles, and total start pulses.

For more information on the audit features, refer to *Collecting Audit Information*.

**NOTE: Additional audit information is retrievable with the Micro-Wand IIIIE, the Card Reader or the Network. Refer to the appropriate instruction manual.**

## Testing Machine and NetMaster Functions

Special programmable diagnostic features built into NetMaster allow the owner to run specific diagnostic tests. By opening and closing the service door and then pressing various sequences of Select Cycle and Select Wash Temp pads, the owner may perform the following tests:

- Control Software Version Number
- Service Door Opening Test
- Coin Vault Opening Test
- Coin Drop #1 Input Test
- Coin Drop #2 Input Test
- Lid Switch Input Test
- Pressure Switch Opening Test
- Show Fill Time Test
- Show Drain Time Test
- Start Pulse Test
- Configuration Display Tests

For detailed information on running diagnostic tests, refer to *Testing Machine and NetMaster Functions*.

## Sales Floor Feature

NetMaster washer has a built-in sales floor routine used to display all LED lights and the four digits with the colon and decimal point. This function is designed to show potential customers the high-tech features of NetMaster and to verify that all segments of the VFD work.

For detailed information on using the Sales Floor feature, refer to *Sales Floor Feature*.

## Rapid Advance Feature

This feature allows the user to quickly advance through active cycles or advance into a cycle from the ready mode. This feature is useful when tests must be performed immediately on a washer currently in an active cycle. In this case, the user can quickly advance through the cycles to the ready mode. At this point, the user can perform the required tests and then return the washer to the point it was interrupted.

For detailed information on using the Rapid Advance feature, refer to *Rapid Advance Feature*.

## Clearing the NetMaster Vend Feature

This feature allows the user to return NetMaster back to the ready mode if coins have been entered but the full vend price has not yet been satisfied. Refer to *Figure 2*.

For more information on using the Clear Vend feature, refer to *Clear Vend Feature*.

## Communications Mode

This feature allows the washer control to communicate with the Micro-Wand IIIIE, the Card Reader or the Network. This allows the washer control to be programmed and have its data read without using the keypad.

For more detailed information on using the Communications Mode feature, refer to *Communications Mode*.

## Coin Drop

The control will accept pulses from a single or dual coin drop to satisfy vend price. Each coin drop will have the ability to start or run a cycle.

### Start Pulse Operation

The control will accept pulses from a central card reader system. The machine can be programmed to receive a single start pulse or multiple start pulses, or the Start Pulse Option can be turned off. The Start Pulse Mode allows the machine to go from the “Ready” mode to the “START” mode after single or multiple pulses are received.

### Service Door and Coin Vault Openings

The control will capture the times and dates of the openings of the Coin Vault and the Service Door. The information is saved in memory. An open service door combined with various keypad presses allows the control to enter manual modes of operation if the Break-In Alarm is not on. These modes include Manual Programming, Audit Collection and Diagnostics.

### Break-In Alarm

This feature allows the owner to program the machine to signal a network alarm if the service door or coin vault is opened without disabling the alarm first. To avoid the alarm during coin collections, the alarm must be disabled.

### Special Vend

This feature allows the owner to program the control to allow programmable vend prices for specific hours and dates.

For details on programming Special Vend, refer to *Programming NetMaster*.

### Lucky Cycle

This feature allows the owner to program the machine to provide a free vend cycle to customers after a certain number of cycles have occurred.

For details on programming the Lucky Cycle Option, refer to *Programming NetMaster*.

### Site Code Pricing

This feature allows owners to program the control to accept site codes for special vending that are specific to select groups or individuals when using cards.

For details on programming the site code options, refer to *Programming NetMaster*.

### Special Cycle

This feature allows the owner to offer extra features to customers for an added vend price. Features available include extra wash time, extra rinse time, and a warm rinse temperature.

For details on programming the Special Cycle option, refer to *Programming NetMaster*.

# Opening the Service Door (Coin Models Only)

Manually programming NetMaster requires the user to open and close the service door. Opening and closing the service door trips a switch allowing access to various programming options, diagnostics and audit capabilities.

The service door is located on the top of the meter case. Refer to *Figure 3*.

**NOTE:** For card models, the manual programming option is accessed by disconnecting and reconnecting a plug behind the control panel, or by inserting the appropriate card into the card reader.

	<b>WARNING</b>
<b>Any disassembly requiring the use of tools must be performed by a suitably qualified service person.</b>	
<small>W299</small>	

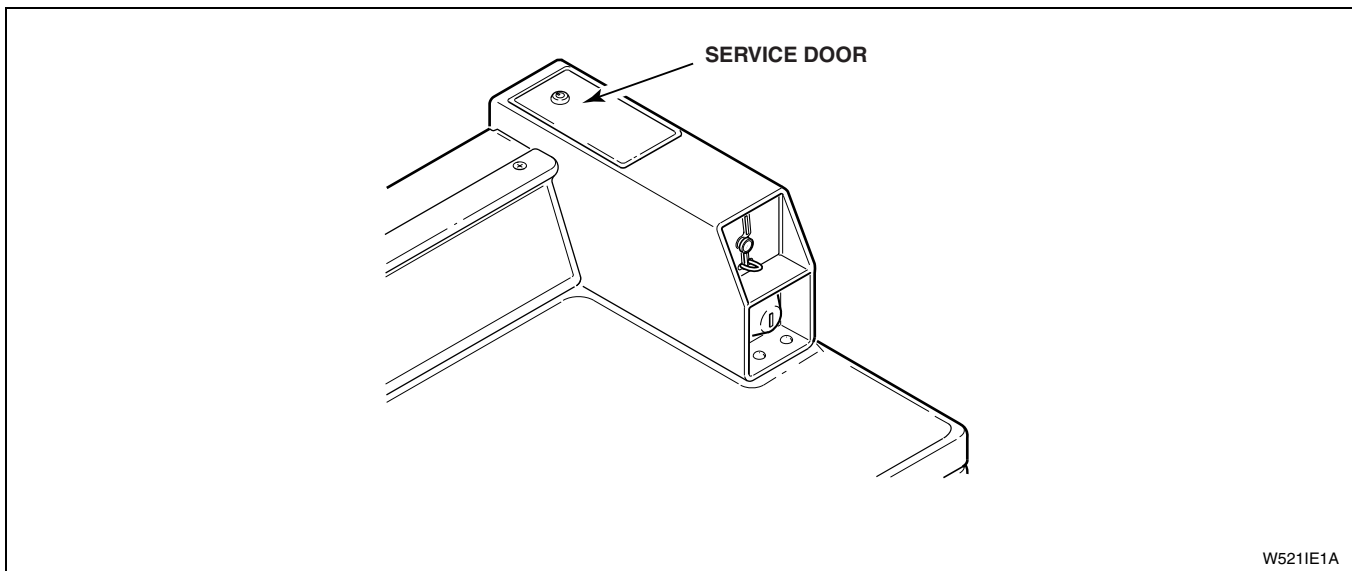

Figure 3



# Entering the Manual Mode

For programming, testing, and retrieving information from NetMaster, it is often necessary to enter the Manual Mode by following the four simple steps below.

## How to Enter the Manual Mode

1. Be sure the washer is in the ready mode before continuing to step 2. Refer to *Figure 2*. If the washer is in an active cycle, rapid advance through the cycle. Refer to **Rapid Advance Feature**. If coins or a card has been entered, refer to **Clear Vend Feature**.
2. Open the service door. Refer to **Opening the Service Door**.
3. While pressing and holding the NORMAL keypad with one hand, press the HOT keypad with the other hand.
4. The VFD display will show “rAPd”. Refer to *Figure 4*.

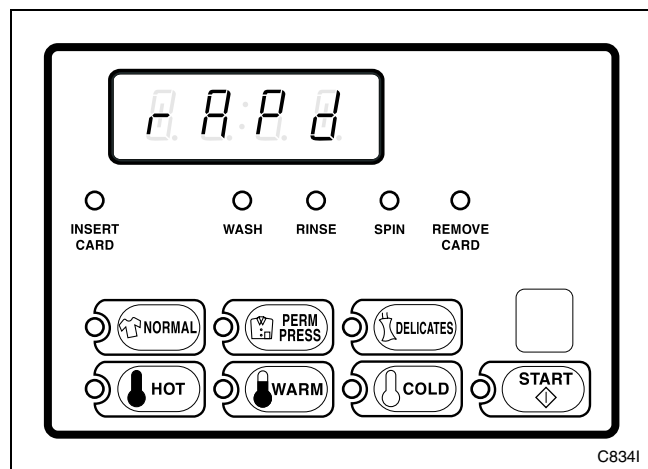

Figure 4

5. Press the DELICATES (+) or the COLD (-) keypad to scroll through the options until the desired option appears in the VFD.
6. Press the START (enter) keypad.

Manual Mode is broken into two groups: Manual Programming and Manual Rapid Advance/Diagnostics. Manual Programming can only be turned on or off with the Micro-Wand IIIE, the Smart Card Reader or the Network. Refer to the appropriate instruction manual. Manual Rapid Advance/Diagnostics can be turned on and off using the Micro-Wand IIIE, by manual programming (refer to *option 47 of Programming NetMaster*), with the Smart Card Reader, or with the Network.

By default, both groups are turned “ON”.

The manual features available in each group are as follows (the menu displayed on the VFD in this mode is in parenthesis).

## Manual Programming

Manual Programming (PrOg)

Manual Read Audit (AudT)

Manual Reset (rSET)

## Rapid Advance/Diagnostics

Rapid Advance (rAPd)

Show Mode (SHOW)

Diagnostic Tests (dIAG)

If a group is turned “OFF”, the feature menu will still appear, but the features in the group cannot be entered.





# Programming NetMaster

## What Can Be Programmed?

This feature allows the owner to program cycle parameters, standard vend pricing, special vends and other features by using the keypads. The control must have the Manual Programming Mode enabled, which is the factory default. This mode can only be turned OFF and ON by using the Micro-Wand IIIIE, the Smart Card Reader or the Network. Refer to this section when programming NetMaster.

This section offers a detailed description of all 55 options available to program.

Each description includes instructions on when and why the option might be used and, more importantly, how to program the option.

For more advanced users, a quick reference list of the options available through the programming mode is located on this page.

**NOTE: The three numbers in the Option column of the Programmable Options list are what will be shown in the VFD display when that option is selected.**

## Programmable Options Available

OPTION	DESCRIPTION
001	Audio Signal
002	Reg. Hot Wash Vend Price
003	Reg. Warm Wash Vend Price
004	Reg. Cold Wash Vend Price
005	Site Code #1 Reg. Hot Wash Vend Price
006	Site Code #1 Reg. Warm Wash Vend Price
007	Site Code #1 Reg. Cold Wash Vend Price
008	Special Cycle Vend Price
009	Special Vend A Days Enable
010	Special Vend A Start Hour
011	Special Vend A Length in Hours
012	Special Vend A Start Month
013	Special Vend A Start Date
014	Special Vend A End Month
015	Special Vend A End Date
016	Special Vend A Site Code #1
017	Special Vend A Reg. Hot Wash Vend Price
018	Special Vend A Reg. Warm Wash Vend Price

OPTION	DESCRIPTION
019	Special Vend A Reg. Cold Wash Vend Price
020	Special Vend A Auto-Shutdown Enable
021	Coin #1 Value
022	Coin #2 Value
023	Start Pulse Value
024	Default Cycle/Temperature
025	Power Fail Reset
026	Set Real-Time Clock Minutes
027	Set Real-Time Clock Hours
028	Set Real-Time Clock Day
029	Set Real-Time Clock Date
030	Set Real-Time Clock Month
031	Set Real-Time Clock Year
032	Set Real-Time Clock Century
033	Normal Wash Agitate Time
034	Normal Extra Rinse Agitate Time
035	Normal Rinse Agitate Time
036	Normal Final Spin Time
037	Perm Press Wash Agitate Time
038	Perm Press Extra Rinse Agitate Time
039	Perm Press Rinse Agitate Time
040	Perm Press Final Spin Time
041	Delicate Wash Agitate Time
042	Delicate Extra Rinse Agitate Time
043	Delicate Rinse Agitate Time
044	Delicate Final Spin Time
045	Warm Rinse Enable/Disable
046	Control Configuration Data #1
047	Control Configuration Data #3
048	Lucky Option
049	Special Cycle Option
050	Special Cycle Extra Wash Time
051	Special Cycle Extra Extra-Rinse Time
052	Smart Card Maximum Value
053	Site Code #1
054	Error Code Programming Parameter
055	Start Pulse Mode

## Programming NetMaster

### 1. Audio Signal “+001”

This option allows the owner to program when the signal will sound.

There are four occasions when a signal may sound during the washer operation. These four occasions are listed below:

#### 1. End of Cycle Signal

By default, the signal is turned off. If turned on, the signal will sound for three seconds at the end of a cycle.

#### 2. Keypad Depression Signal

By default, this signal is turned on and will sound for a quarter of a second. This signal will sound each time a keypad is pressed.

#### 3. Coin Input/Card Insertion Signal

By default, this signal is turned on and will sound for a quarter of a second each time a coin or card is entered.

#### 4. Remove Card Signal (Card Models Only)

By default, this signal is turned on and will sound one second on and one second off when the REMOVE CARD LED is flashing.

### How to Program the Audio Signal

- Control must be in Manual Mode. Refer to *Entering the Manual Mode*.
- Press the DELICATES (+) or the COLD (-) keypad until “PrOg” appears in the VFD. Press the START (enter) keypad.

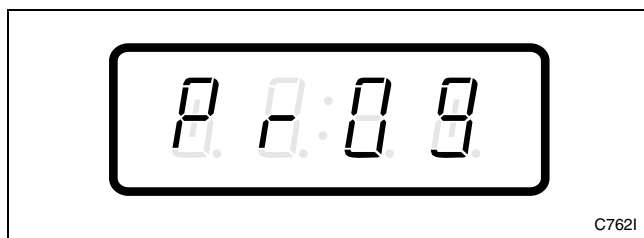

Figure 5

- “+001” will appear in the VFD. Press the START (enter) keypad. A number will appear in the VFD. This number corresponds to the current Audio Signal Programming Value.

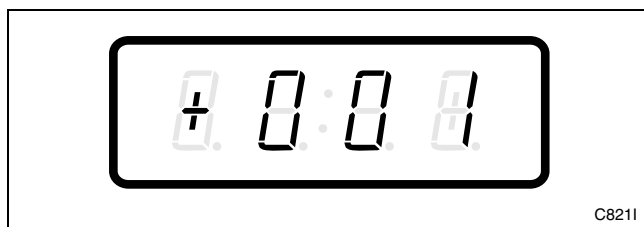

Figure 6

- Locate the desired number in the first column of *Table 1* on the following page.
- Press the DELICATES (+) or the COLD (-) keypad to increase or decrease the current number until correct. Refer to *Figure 7*.

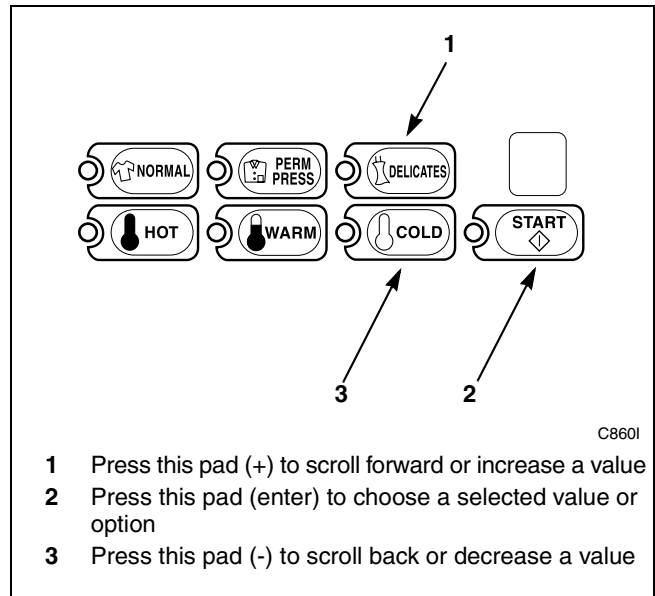

Figure 7

For Example: A user might wish to have the signal sound only when a keypad is pressed. Entering the number “1” in step 5 would turn off all the options except KEYPAD. In this instance, the signal would sound only when a keypad is pressed.

- Press the START (enter) keypad when the correct number appears in the VFD. The next option, “+002”, will appear in the VFD.

**NOTE: To program “+002” (Reg. Hot Wash Vend Price), refer to option 2. To program other options, refer to the appropriate section.**

### How to Exit Programming Feature

1. Be sure the control shows a programmable option, not a value.
2. While pressing and holding the NORMAL keypad with one hand, press the PERM PRESS keypad with the other hand. The control will revert back to the ready mode. Refer to *Figure 2*.

### How to Read *Table 1*

To determine the correct number required to program the Audio Signal, use the following chart. The Signal Value column contains the number required in step 5. The other columns correspond to individual options.

Each column of options contains a unique combination of the words “ON” and “OFF” that indicates if that column’s option is turned on or off when the Signal Value is entered. Select the desired combination of options and enter the number found in the Signal Value column.

Signal Value	Remove Card	Coin/Card Input	End of Cycle	Key Pressed
0	OFF	OFF	OFF	OFF
1	OFF	OFF	OFF	ON
2	OFF	OFF	ON	OFF
3	OFF	OFF	ON	ON
4	OFF	ON	OFF	OFF
5	OFF	ON	OFF	ON
6	OFF	ON	ON	OFF
7	OFF	ON	ON	ON
8	ON	OFF	OFF	OFF
9	ON	OFF	OFF	ON
10	ON	OFF	ON	OFF
11	ON	OFF	ON	ON
12	ON	ON	OFF	OFF
13	ON	ON	OFF	ON
14	ON	ON	ON	OFF
15	ON	ON	ON	ON

Table 1

## 2. Reg. Hot Wash Vend Price “+002”

This option allows the owner to set the vend price for a hot wash. This vend price will be displayed in the VFD when HOT is selected.

### How to Program the Reg. Hot Wash Vend Price

1. Control must be in Manual Mode. Refer to *Entering the Manual Mode*.
2. Press the DELICATES (+) or the COLD (-) keypad until “PrOg” appears in the VFD. Press the START (enter) keypad and “+001” will appear in the VFD.

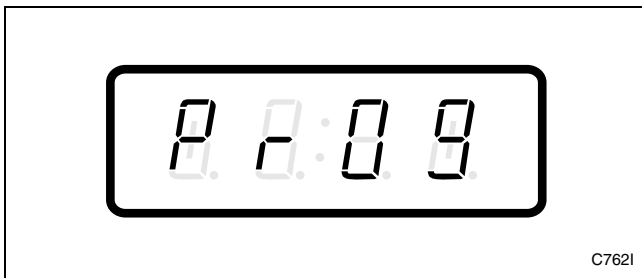

Figure 8

3. Press the DELICATES (+) or the COLD (-) keypad to scroll through the programmable options until “+002” appears in the VFD. Refer to *Figure 9*.

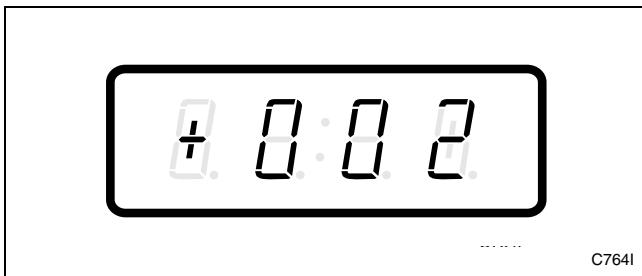

Figure 9

4. When “+002” appears in the VFD, press the START (enter) keypad. There are five digits in the Reg. Hot Wash Vend Price. The fifth digit will appear in the VFD and will flash one second on, one second off. Refer to *Figure 10*.

**NOTE: If the vend price is \$100.00 or more, the fifth digit is “1”. If the vend price is \$99.99 or less, the fifth digit is “0”.**

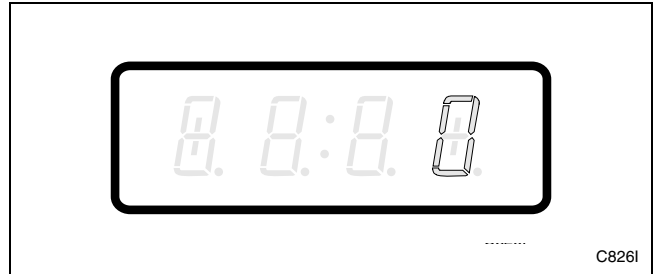

Figure 10

5. Press the DELICATES (+) or the COLD (-) keypad to increase or decrease the value of the fifth digit. Refer to *Figure 11*.

**NOTE: The vend price can be set from 1 to 65,535.**

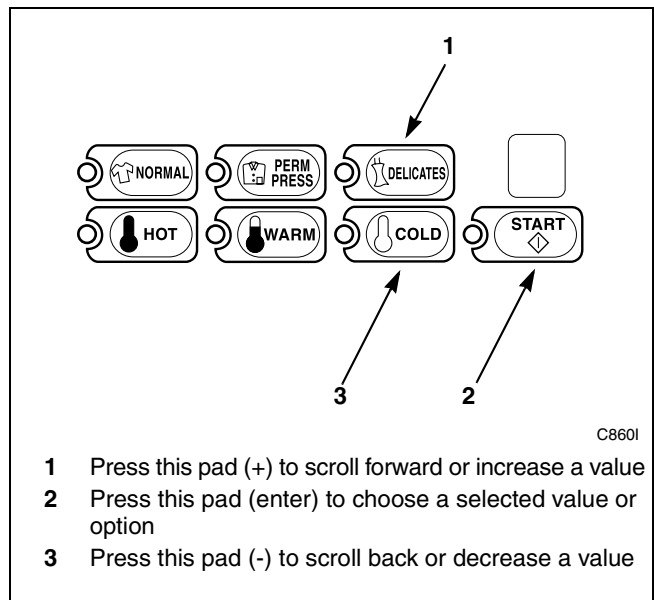

Figure 11

6. Press the START (enter) keypad to enter the fifth digit and display remaining four digits. The active digit will flash one second on and one second off. Refer to *Figure 12*.

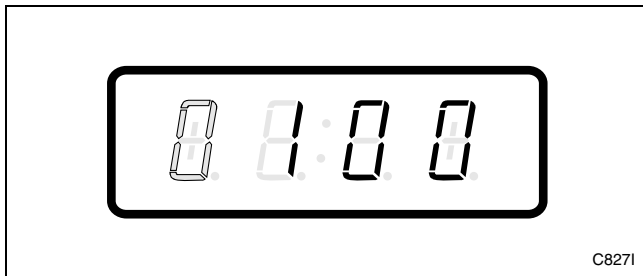

Figure 12

7. Press the DELICATES (+) or the COLD (-) keypad to increase or decrease the value of the active digit and the START (enter) keypad to enter the value of the digit and advance to the next digit.
8. Press the START (enter) keypad with the last active digit. The next option, “+003”, will appear in the VFD.

**NOTE: To program “+003” (Reg. Warm Wash Vend Price), refer to *option 3*. To program other options, refer to the appropriate section.**

## How to Exit Programming Feature

1. Be sure the control shows a programmable option, not a value.
2. While pressing and holding the NORMAL keypad with one hand, press the PERM PRESS keypad with the other hand. The control will revert back to the ready mode. Refer to *Figure 2*.

### 3. Reg. Warm Wash Vend Price “+003”

This option allows the owner to set the vend price for a warm wash. This vend price will be displayed in the VFD when WARM is selected.

#### How to Program the Reg. Warm Wash Vend Price

1. Control must be in Manual Mode. Refer to *Entering the Manual Mode*.
2. Press the DELICATES (+) or the COLD (-) keypad until “PrOg” appears in the VFD. Press the START (enter) keypad and “+001” will appear in the VFD.

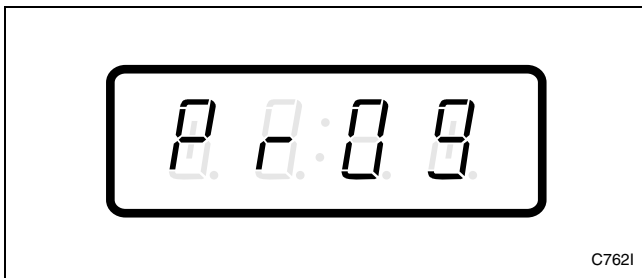

Figure 13

3. Press the DELICATES (+) or the COLD (-) keypad to scroll through the programmable options until “+003” appears in the VFD. Refer to *Figure 14*.

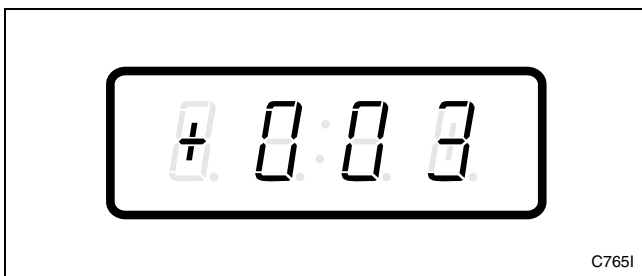

Figure 14

4. When “+003” appears in the VFD, press the START (enter) keypad. There are five digits in the Reg. Warm Wash Vend Price. The fifth digit will appear in the VFD and will flash one second on, one second off. Refer to *Figure 15*.

**NOTE: If the vend price is \$100.00 or more, the fifth digit is “1”. If the vend price is \$99.99 or less, the fifth digit is “0”.**

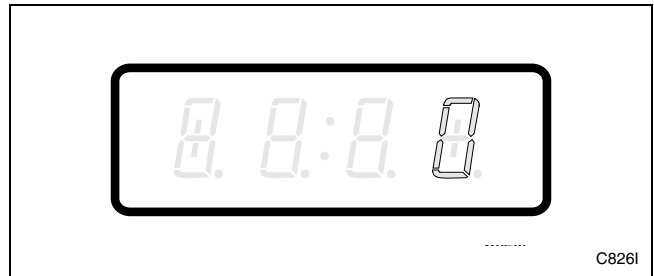
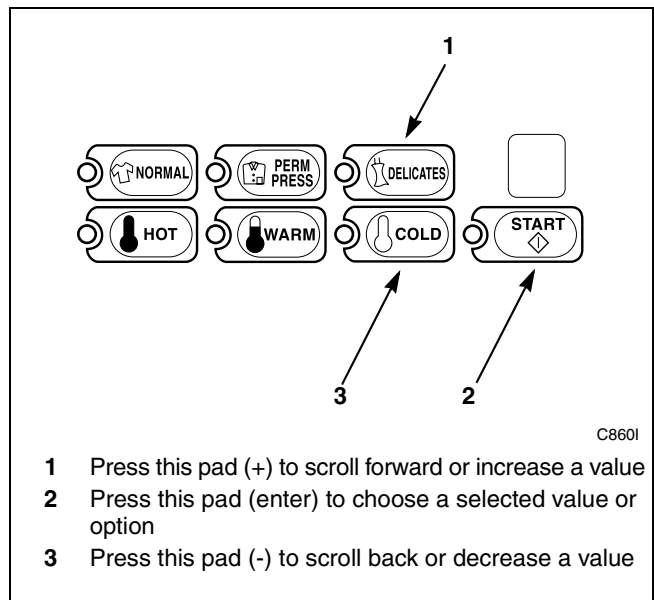

Figure 15

5. Press the DELICATES (+) or the COLD (-) keypad to increase or decrease the value of the fifth digit. Refer to *Figure 16*.

**NOTE: The vend price can be set from 1 to 65,535.**



- 1 Press this pad (+) to scroll forward or increase a value
- 2 Press this pad (enter) to choose a selected value or option
- 3 Press this pad (-) to scroll back or decrease a value

Figure 16

6. Press the START (enter) keypad to enter the fifth digit and display remaining four digits. The active digit will flash one second on and one second off. Refer to *Figure 17*.

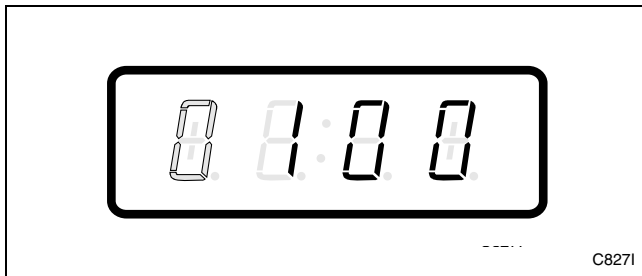

Figure 17

7. Press the DELICATES (+) or the COLD (-) keypad to increase or decrease the value of the active digit and the START (enter) keypad to enter the value of the digit and advance to the next digit.
8. Press the START (enter) keypad with the last active digit. The next option, “+004”, will appear in the VFD.

**NOTE: To program “+004” (Reg. Cold Wash Vend Price), refer to *option 4*. To program other options, refer to the appropriate section.**

## How to Exit Programming Feature

1. Be sure the control shows a programmable option, not a value.
2. While pressing and holding the NORMAL keypad with one hand, press the PERM PRESS keypad with the other hand. The control will revert back to the ready mode. Refer to *Figure 2*.

#### 4. Reg. Cold Wash Vend Price “+004”

This option allows the owner to set the vend price for a cold wash. This vend price will be displayed in the VFD when COLD is selected.

#### How to Program the Reg. Cold Wash Vend Price

1. Control must be in Manual Mode. Refer to *Entering the Manual Mode*.
2. Press the DELICATES (+) or the COLD (-) keypad until “PrOg” appears in the VFD. Press the START (enter) keypad and “+001” will appear in the VFD.

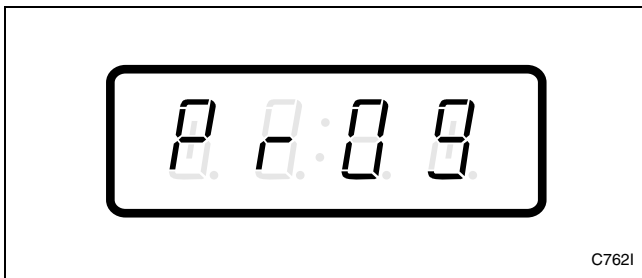

Figure 18

3. Press the DELICATES (+) or the COLD (-) keypad to scroll through the programmable options until “+004” appears in the VFD. Refer to *Figure 19*.

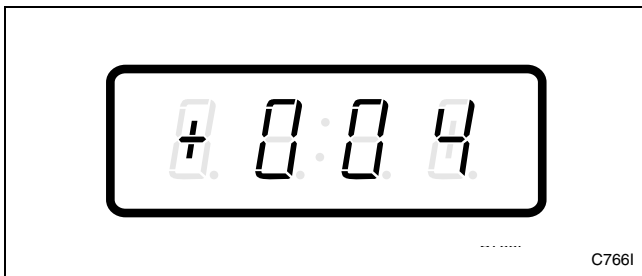

Figure 19

4. When “+004” appears in the VFD, press the START (enter) keypad. There are five digits in the Reg. Cold Wash Vend Price. The fifth digit will appear in the VFD and will flash one second on, one second off. Refer to *Figure 20*.

**NOTE: If the vend price is \$100.00 or more, the fifth digit is “1”. If the vend price is \$99.99 or less, the fifth digit is “0”.**

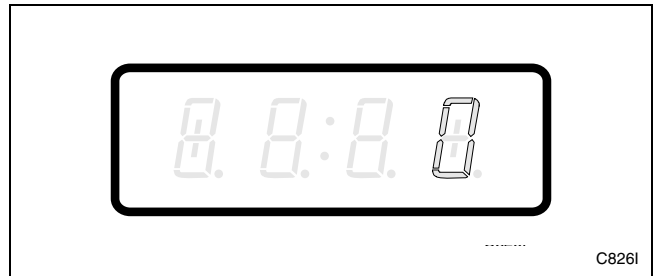

Figure 20

5. Press the DELICATES (+) or the COLD (-) keypad to increase or decrease the value of the fifth digit. Refer to *Figure 21*.

**NOTE: The vend price can be set from 1 to 65,535.**

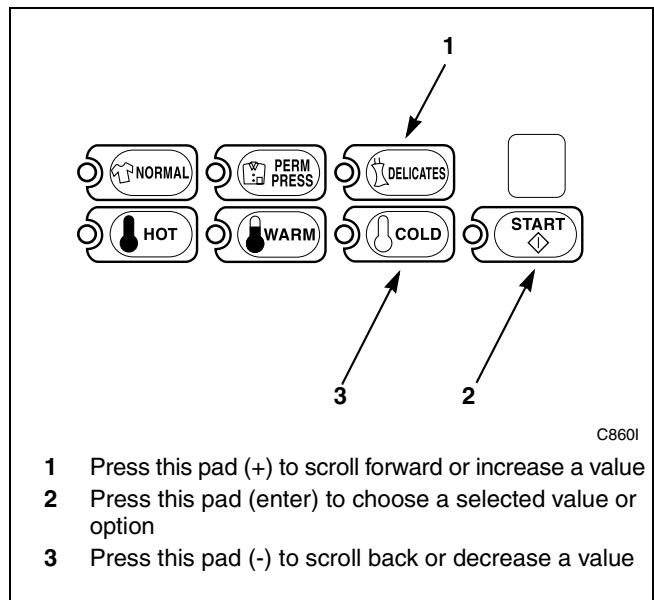

Figure 21



6. Press the START (enter) keypad to enter the fifth digit and display remaining four digits. The active digit will flash one second on and one second off. Refer to *Figure 22*.

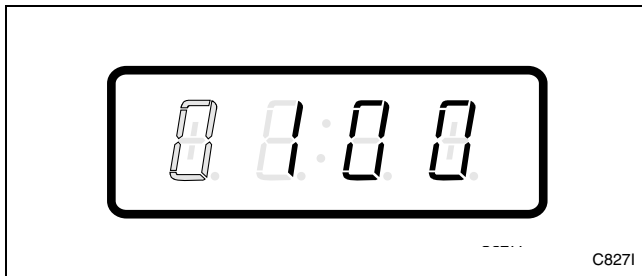

Figure 22

7. Press the DELICATES (+) or the COLD (-) keypad to increase or decrease the value of the active digit and the START (enter) keypad to enter the value of the digit and advance to the next digit.
8. Press the START (enter) keypad with the last active digit. The next option, “+005”, will appear in the VFD.

**NOTE: To program “+005” (Site Code #1 Reg. Hot Wash Vend Price), refer to *option 5*. To program other options, refer to the appropriate section.**

## How to Exit Programming Feature

1. Be sure the control shows a programmable option, not a value.
2. While pressing and holding the NORMAL keypad with one hand, press the PERM PRESS keypad with the other hand. The control will revert back to the ready mode. Refer to *Figure 2*.

## 5. Site Code #1 Hot Wash Vend Price "+005"

This option allows the owner to set the vend price for a hot wash when cards with a special site code are used by specific groups or individuals.

### How to Program the Site Code #1 Hot Wash Vend Price

1. Control must be in Manual Mode. Refer to *Entering the Manual Mode*.
2. Press the DELICATES (+) or the COLD (-) keypad until "PrOg" appears in the VFD. Press the START (enter) keypad and "+001" will appear in the VFD.

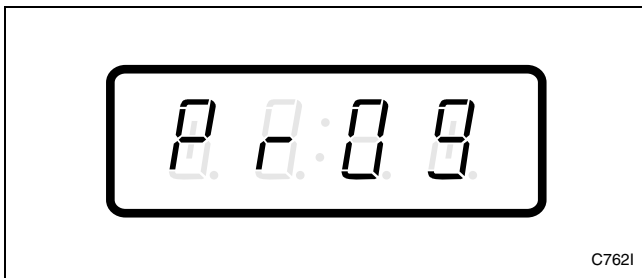

Figure 23

3. Press the DELICATES (+) or the COLD (-) keypad to scroll through the programmable options until "+005" appears in the VFD. Refer to *Figure 24*.

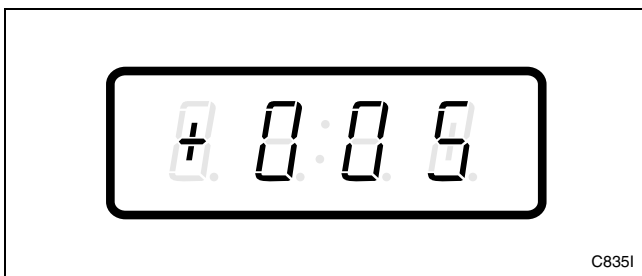

Figure 24

4. When "+005" appears in the VFD, press the START (enter) keypad. There are five digits in the Site Code #1 Hot Wash Vend Price. The fifth digit will appear in the VFD and will flash one second on, one second off. Refer to *Figure 25*.

**NOTE: If the vend price is \$100.00 or more, the fifth digit is "1". If the vend price is \$99.99 or less, the fifth digit is "0".**

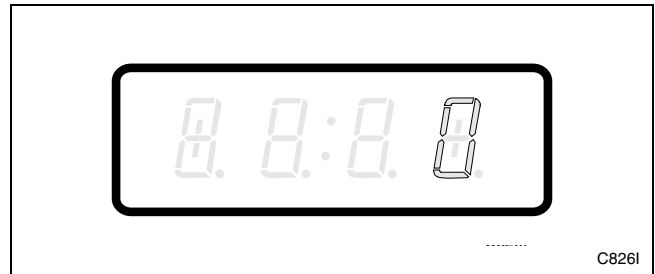
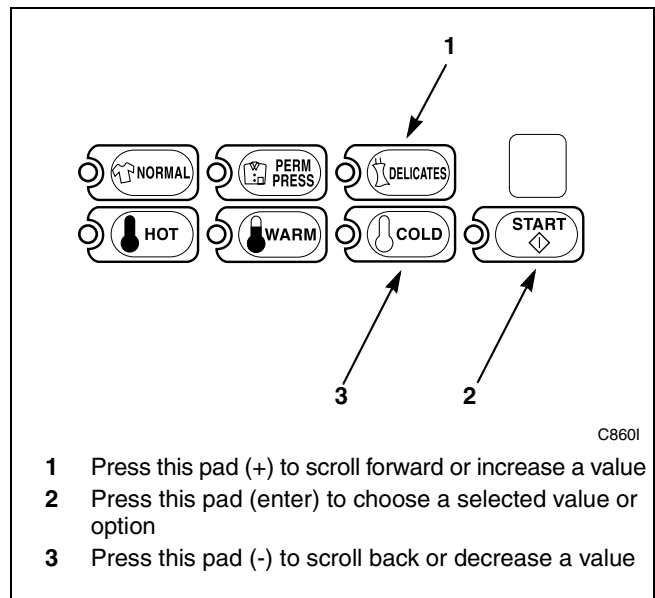

Figure 25

5. Press the DELICATES (+) or the COLD (-) keypad to increase or decrease the value of the fifth digit. Refer to *Figure 26*.

**NOTE: The vend price can be set from 0 to 65,535.**



- 1 Press this pad (+) to scroll forward or increase a value
- 2 Press this pad (enter) to choose a selected value or option
- 3 Press this pad (-) to scroll back or decrease a value

Figure 26

6. Press the START (enter) keypad to enter the fifth digit and display remaining four digits. The active digit will flash one second on and one second off. Refer to *Figure 27*.

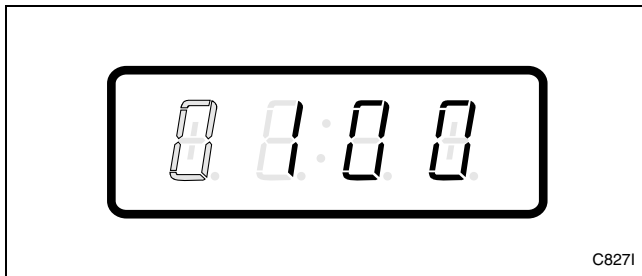

Figure 27

7. Press the DELICATES (+) or the COLD (-) keypad to increase or decrease the value of the active digit and the START (enter) keypad to enter the value of the digit and advance to the next digit.
8. Press the START (enter) keypad with the last active digit. The next option, “+006”, will appear in the VFD.

**NOTE: To program “+006” (Site Code #1 Warm Wash Vend Price), refer to *option 6*. To program other options, refer to the appropriate section.**

## How to Exit Programming Feature

1. Be sure the control shows a programmable option, not a value.
2. While pressing and holding the NORMAL keypad with one hand, press the PERM PRESS keypad with the other hand. The control will revert back to the ready mode. Refer to *Figure 2*.

## 6. Site Code #1 Warm Wash Vend Price “+006”

This option allows the owner to set the vend price for a warm wash when cards with a special site code are used by specific groups or individuals.

### How to Program the Site Code #1 Warm Wash Vend Price

1. Control must be in Manual Mode. Refer to *Entering the Manual Mode*.
2. Press the DELICATES (+) or the COLD (-) keypad until “PrOg” appears in the VFD. Press the START (enter) keypad and “+001” will appear in the VFD.

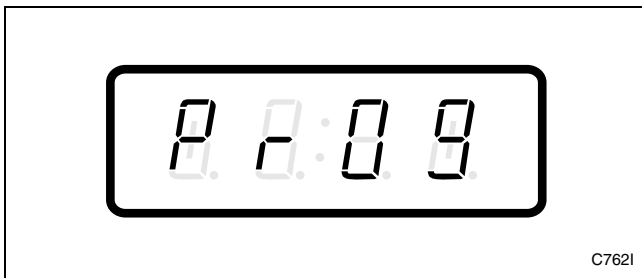

Figure 28

3. Press the DELICATES (+) or the COLD (-) keypad to scroll through the programmable options until “+006” appears in the VFD. Refer to *Figure 29*.



Figure 29

4. When “+006” appears in the VFD, press the START (enter) keypad. There are five digits in the Site Code #1 Warm Wash Vend Price. The fifth digit will appear in the VFD and will flash one second on, one second off. Refer to *Figure 30*.

**NOTE: If the vend price is \$100.00 or more, the fifth digit is “1”. If the vend price is \$99.99 or less, the fifth digit is “0”.**

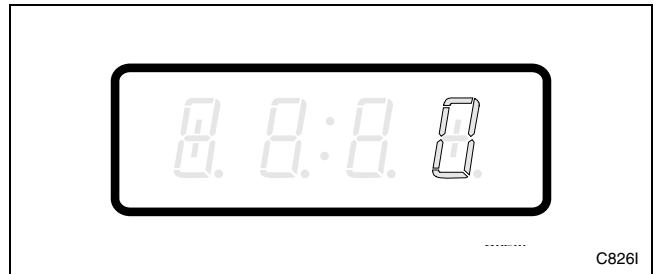
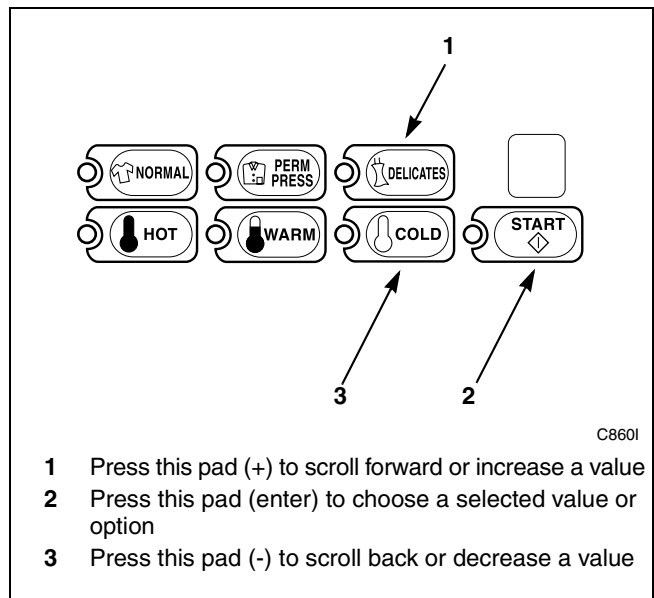

Figure 30

5. Press the DELICATES (+) or the COLD (-) keypad to increase or decrease the value of the fifth digit. Refer to *Figure 31*.

**NOTE: The vend price can be set from 0 to 65,535.**



- 1 Press this pad (+) to scroll forward or increase a value
- 2 Press this pad (enter) to choose a selected value or option
- 3 Press this pad (-) to scroll back or decrease a value

Figure 31

6. Press the START (enter) keypad to enter the fifth digit and display remaining four digits. The active digit will flash one second on and one second off. Refer to *Figure 32*.

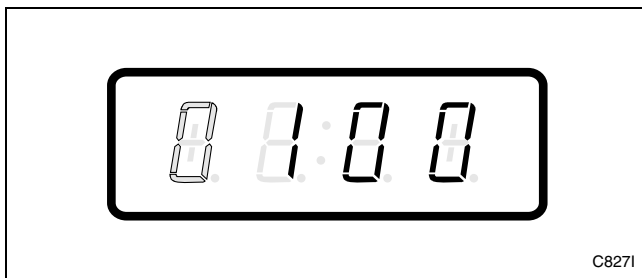

Figure 32

7. Press the DELICATES (+) or the COLD (-) keypad to increase or decrease the value of the active digit and the START (enter) keypad to enter the value of the digit and advance to the next digit.
8. Press the START (enter) keypad with the last active digit. The next option, “+007”, will appear in the VFD.

**NOTE: To program “+007” (Site Code #1 Cold Wash Vend Price), refer to *option 7*. To program other options, refer to the appropriate section.**

## How to Exit Programming Feature

1. Be sure the control shows a programmable option, not a value.
2. While pressing and holding the NORMAL keypad with one hand, press the PERM PRESS keypad with the other hand. The control will revert back to the ready mode. Refer to *Figure 2*.

## 7. Site Code #1 Cold Wash Vend Price “+007”

This option allows the owner to set the vend price for a cold wash when cards with a special site code are used by specific groups or individuals.

### How to Program the Site Code #1 Cold Wash Vend Price

1. Control must be in Manual Mode. Refer to *Entering the Manual Mode*.
2. Press the DELICATES (+) or the COLD (-) keypad until “PrOg” appears in the VFD. Press the START (enter) keypad and “+001” will appear in the VFD.

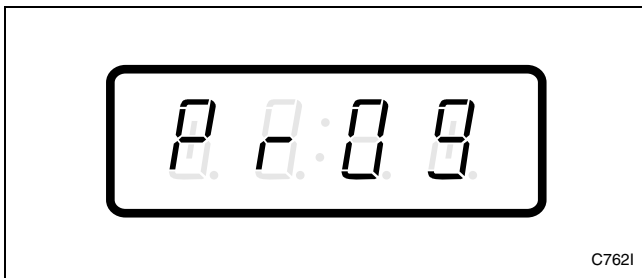

Figure 33

3. Press the DELICATES (+) or the COLD (-) keypad to scroll through the programmable options until “+007” appears in the VFD. Refer to *Figure 34*.

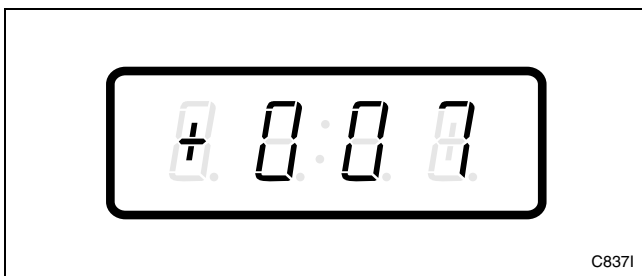

Figure 34

4. When “+007” appears in the VFD, press the START (enter) keypad. There are five digits in the Site Code #1 Cold Wash Vend Price. The fifth digit will appear in the VFD and will flash one second on, one second off. Refer to *Figure 35*.

**NOTE: If the vend price is \$100.00 or more, the fifth digit is “1”. If the vend price is \$99.99 or less, the fifth digit is “0”.**

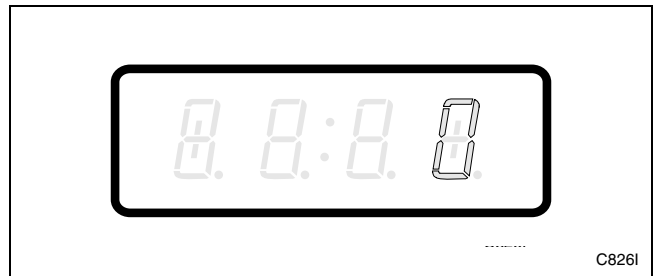
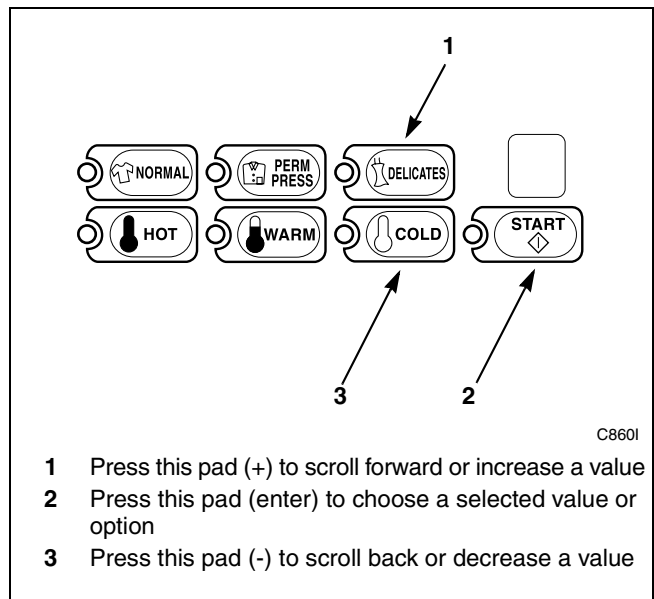

Figure 35

5. Press the DELICATES (+) or the COLD (-) keypad to increase or decrease the value of the fifth digit. Refer to *Figure 36*.

**NOTE: The vend price can be set from 0 to 65,535.**



- 1 Press this pad (+) to scroll forward or increase a value
- 2 Press this pad (enter) to choose a selected value or option
- 3 Press this pad (-) to scroll back or decrease a value

Figure 36

6. Press the START (enter) keypad to enter the fifth digit and display remaining four digits. The active digit will flash one second on and one second off. Refer to *Figure 37*.

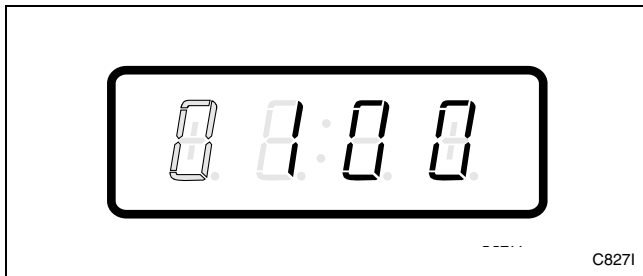

Figure 37

7. Press the DELICATES (+) or the COLD (-) keypad to increase or decrease the value of the active digit and the START (enter) keypad to enter the value of the digit and advance to the next digit.
8. Press the START (enter) keypad with the last active digit. The next option, “+008”, will appear in the VFD.

**NOTE: To program “+008” (Special Cycle Vend Price), refer to *option 8*. To program other options, refer to the appropriate section.**

## How to Exit Programming Feature

1. Be sure the control shows a programmable option, not a value.
2. While pressing and holding the NORMAL keypad with one hand, press the PERM PRESS keypad with the other hand. The control will revert back to the ready mode. Refer to *Figure 2*.

## 8. Special Cycle Vend Price “+008”

This option allows the owner to program the machines to offer extra features to the customers for an added vend price. This vend price will be displayed in the VFD for 30 seconds starting 5 seconds after the start (refer to *option 49*) of the first fill/agitate. Refer to *option 49, 50* and *51* for programming these features.

### How to Program Special Cycle Vend Price

1. Control must be in Manual Mode. Refer to *Entering the Manual Mode*.
2. Press the DELICATES (+) or the COLD (-) keypad until “PrOg” appears in the VFD. Press the START (enter) keypad and “+001” will appear in the VFD.

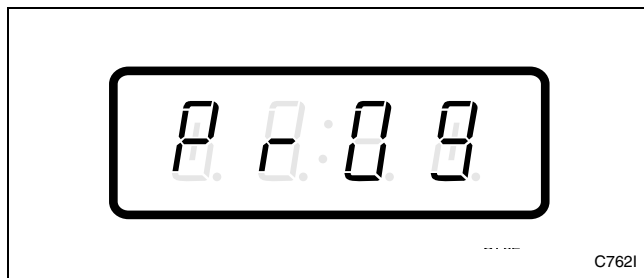

Figure 38

3. Press the DELICATES (+) or the COLD (-) keypad to scroll through the programmable options until “+008” appears in the VFD. Refer to *Figure 39*.

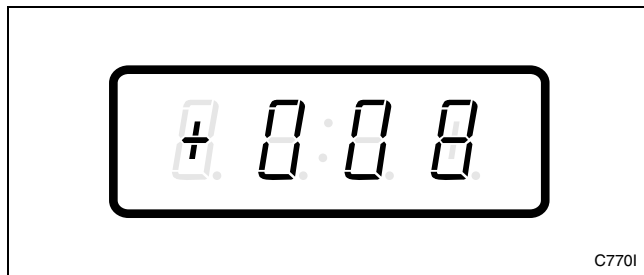

Figure 39

4. When “+008” appears in the VFD, press the START (enter) keypad. There are five digits in the Special Cycle Vend Price. The fifth digit will appear in the VFD and will flash one second on, one second off. Refer to *Figure 40*.

**NOTE: If the vend price is \$100.00 or more, the fifth digit is “1”. If the vend price is \$99.99 or less, the fifth digit is “0”.**

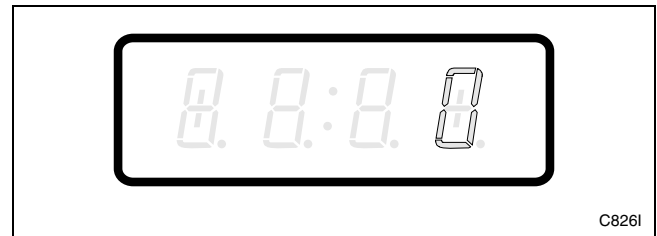
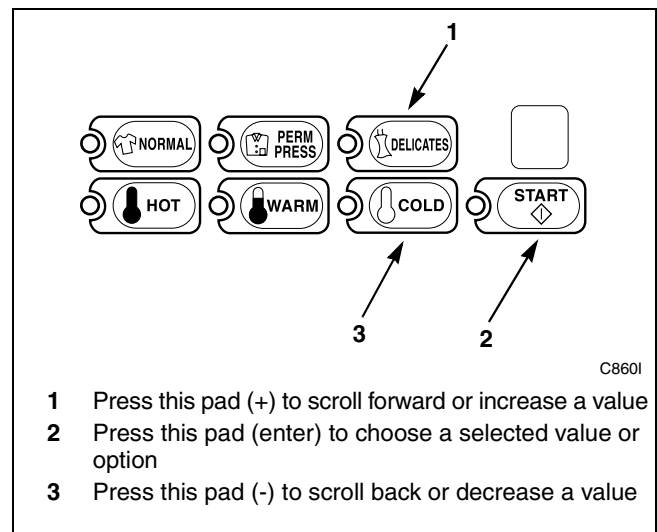

Figure 40

5. Press the DELICATES (+) or the COLD (-) keypad to increase or decrease the current number until correct. Refer to *Figure 41*.

**NOTE: The vend price can be set from 1 to 65,535.**



- 1 Press this pad (+) to scroll forward or increase a value
- 2 Press this pad (enter) to choose a selected value or option
- 3 Press this pad (-) to scroll back or decrease a value

Figure 41

6. Press the START (enter) keypad to enter the fifth digit and display the remaining four digits. The active digit will flash one second on and one second off. Refer to *Figure 42*.

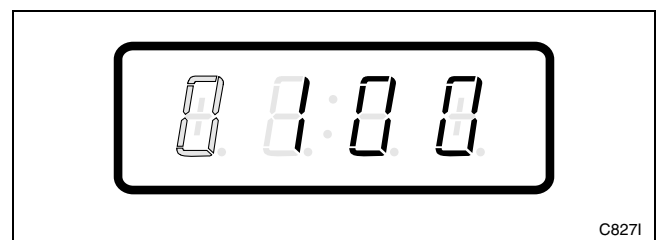

Figure 42



7. Press the DELICATES (+) or the COLD (-) keypad to increase or decrease the value of the active digit and the START (enter) keypad to enter the value of the digit and advance to the next digit.
8. Press the START (enter) keypad with the last active digit. The next option, "+009", will appear in the VFD.

**NOTE: To program "+009" (Special Vend A Days Enable), refer to *option 9*. To program other options, refer to the appropriate section.**

## How to Exit Programming Feature

1. Be sure the control shows a programmable option, not a value.
2. While pressing and holding the NORMAL keypad with one hand, press the PERM PRESS keypad with the other hand. The control will revert back to the ready mode. Refer to *Figure 2*.

## 9. Special Vend A Days Enable “+009”

This option allows the owner to set the day or days of a special vend.

Special Vend A is used to change the standard vend prices for special occasions or to turn the machine off. The special vend can be programmed to start and end on a specific day or days of the week.

The owner may also turn the Special Vend A option on or off if desired.

### How to Program Special Vend A Days Enable

- Control must be in Manual Mode. Refer to *Entering the Manual Mode*.
- Press the DELICATES (+) or the COLD (-) keypad until “PrOg” appears in the VFD. Press the START (enter) keypad and “+001” will appear in the VFD.

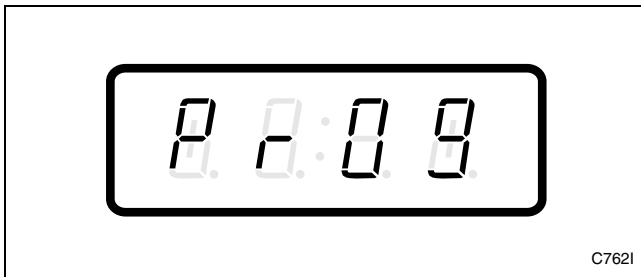

Figure 43

- Press the DELICATES (+) or the COLD (-) keypad to scroll through the programmable options until “+009” appears in the VFD. Refer to *Figure 44*.

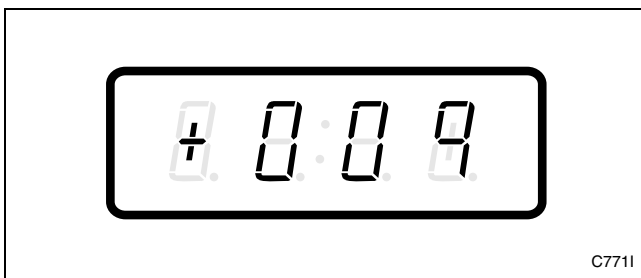

Figure 44

- When “+009” appears in the VFD, press the START (enter) keypad. A number will appear in the VFD that corresponds to the current Special Vend A Days Enable Programming Value.
- Locate the desired number in the first column of *Table 2* on the following pages.
- Press the DELICATES (+) or the COLD (-) keypad to increase or decrease the current number until correct. Refer to *Figure 45*.

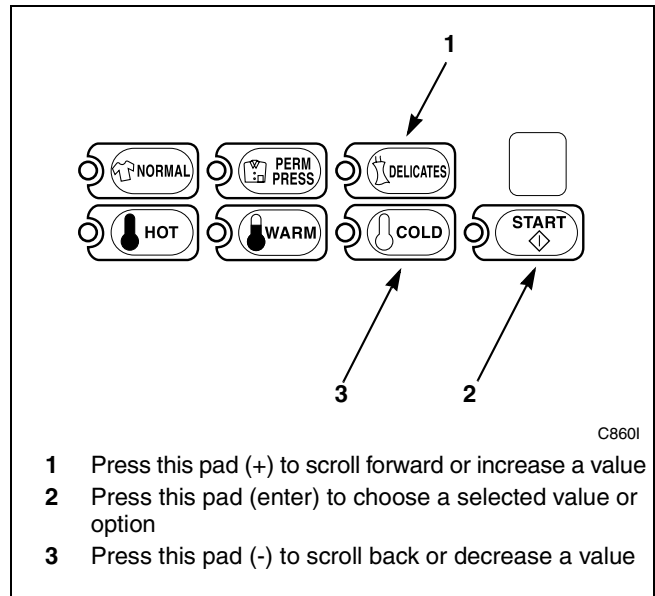

Figure 45

- Press the START (enter) keypad when the correct number appears in the VFD. The next option, “+010”, will appear in the VFD.

**NOTE: To program “+010” (Special Vend A Start Hour), refer to *option 10*. To program other options, refer to the appropriate section.**

### How to Exit Programming Feature

- Be sure the control shows a programmable option, not a value.
- While pressing and holding the NORMAL keypad with one hand, press the PERM PRESS keypad with the other hand. The control will revert back to the ready mode. Refer to *Figure 2*.

**How to Read Table 2**

To determine the correct number required to program the Special Vend A Days Enable, use the following table. The “SPA” Value column contains the number required in step 6. The other columns correspond to individual days.

Each column of days contains a unique combination of the words “ON” and “OFF” that indicates if that column’s day is turned on or off when the “SPA” value is entered. Select the desired combination of days and enter the number found in the “SPA” value column.

“+009”								
“SPA” VALUE	SAT	FRI	THUR	WED	TUE	MON	SUN	ON/OFF
0	OFF	OFF	OFF	OFF	OFF	OFF	OFF	OFF
3	OFF	OFF	OFF	OFF	OFF	OFF	ON	ON
5	OFF	OFF	OFF	OFF	OFF	ON	OFF	ON
7	OFF	OFF	OFF	OFF	OFF	ON	ON	ON
9	OFF	OFF	OFF	OFF	ON	OFF	OFF	ON
11	OFF	OFF	OFF	OFF	ON	OFF	ON	ON
13	OFF	OFF	OFF	OFF	ON	ON	OFF	ON
15	OFF	OFF	OFF	OFF	ON	ON	ON	ON
17	OFF	OFF	OFF	ON	OFF	OFF	OFF	ON
19	OFF	OFF	OFF	ON	OFF	OFF	ON	ON
21	OFF	OFF	OFF	ON	OFF	ON	OFF	ON
23	OFF	OFF	OFF	ON	OFF	ON	ON	ON
25	OFF	OFF	OFF	ON	ON	OFF	OFF	ON
27	OFF	OFF	OFF	ON	ON	OFF	ON	ON
29	OFF	OFF	OFF	ON	ON	ON	OFF	ON
31	OFF	OFF	OFF	ON	ON	ON	ON	ON
33	OFF	OFF	ON	OFF	OFF	OFF	OFF	ON
35	OFF	OFF	ON	OFF	OFF	OFF	ON	ON
37	OFF	OFF	ON	OFF	OFF	ON	OFF	ON
39	OFF	OFF	ON	OFF	OFF	ON	ON	ON
41	OFF	OFF	ON	OFF	ON	OFF	OFF	ON
43	OFF	OFF	ON	OFF	ON	OFF	ON	ON
45	OFF	OFF	ON	OFF	ON	ON	OFF	ON
47	OFF	OFF	ON	OFF	ON	ON	ON	ON
49	OFF	OFF	ON	ON	OFF	OFF	OFF	ON
51	OFF	OFF	ON	ON	OFF	OFF	ON	ON
53	OFF	OFF	ON	ON	OFF	ON	OFF	ON
55	OFF	OFF	ON	ON	OFF	ON	ON	ON
57	OFF	OFF	ON	ON	ON	OFF	OFF	ON
59	OFF	OFF	ON	ON	ON	OFF	ON	ON
61	OFF	OFF	ON	ON	ON	ON	OFF	ON
63	OFF	OFF	ON	ON	ON	ON	ON	ON
65	OFF	ON	OFF	OFF	OFF	OFF	OFF	ON
67	OFF	ON	OFF	OFF	OFF	OFF	ON	ON
69	OFF	ON	OFF	OFF	OFF	ON	OFF	ON

Table 2

**Programming NetMaster**

<b>“+009” (continued)</b>								
<b>“SPA” VALUE</b>	<b>SAT</b>	<b>FRI</b>	<b>THUR</b>	<b>WED</b>	<b>TUE</b>	<b>MON</b>	<b>SUN</b>	<b>ON/OFF</b>
71	OFF	ON	OFF	OFF	OFF	ON	ON	ON
73	OFF	ON	OFF	OFF	ON	OFF	OFF	ON
75	OFF	ON	OFF	OFF	ON	OFF	ON	ON
77	OFF	ON	OFF	OFF	ON	ON	OFF	ON
79	OFF	ON	OFF	OFF	ON	ON	ON	ON
81	OFF	ON	OFF	ON	OFF	OFF	OFF	ON
83	OFF	ON	OFF	ON	OFF	OFF	ON	ON
85	OFF	ON	OFF	ON	OFF	ON	OFF	ON
87	OFF	ON	OFF	ON	OFF	ON	ON	ON
89	OFF	ON	OFF	ON	ON	OFF	OFF	ON
91	OFF	ON	OFF	ON	ON	OFF	ON	ON
93	OFF	ON	OFF	ON	ON	ON	OFF	ON
95	OFF	ON	OFF	ON	ON	ON	ON	ON
97	OFF	ON	ON	OFF	OFF	OFF	OFF	ON
99	OFF	ON	ON	OFF	OFF	OFF	ON	ON
101	OFF	ON	ON	OFF	OFF	ON	OFF	ON
103	OFF	ON	ON	OFF	OFF	ON	ON	ON
105	OFF	ON	ON	OFF	ON	OFF	OFF	ON
107	OFF	ON	ON	OFF	ON	OFF	ON	ON
109	OFF	ON	ON	OFF	ON	ON	OFF	ON
111	OFF	ON	ON	OFF	ON	ON	ON	ON
113	OFF	ON	ON	ON	OFF	OFF	OFF	ON
115	OFF	ON	ON	ON	OFF	OFF	ON	ON
117	OFF	ON	ON	ON	OFF	ON	OFF	ON
119	OFF	ON	ON	ON	OFF	ON	ON	ON
121	OFF	ON	ON	ON	ON	OFF	OFF	ON
123	OFF	ON	ON	ON	ON	OFF	ON	ON
125	OFF	ON	ON	ON	ON	ON	OFF	ON
127	OFF	ON	ON	ON	ON	ON	ON	ON
129	ON	OFF	OFF	OFF	OFF	OFF	OFF	ON
131	ON	OFF	OFF	OFF	OFF	OFF	ON	ON
133	ON	OFF	OFF	OFF	OFF	ON	OFF	ON
135	ON	OFF	OFF	OFF	OFF	ON	ON	ON
137	ON	OFF	OFF	OFF	ON	OFF	OFF	ON
139	ON	OFF	OFF	OFF	ON	OFF	ON	ON
141	ON	OFF	OFF	OFF	ON	ON	OFF	ON
143	ON	OFF	OFF	OFF	ON	ON	ON	ON
145	ON	OFF	OFF	ON	OFF	OFF	OFF	ON
147	ON	OFF	OFF	ON	OFF	OFF	ON	ON
149	ON	OFF	OFF	ON	OFF	ON	OFF	ON
151	ON	OFF	OFF	ON	OFF	ON	ON	ON
153	ON	OFF	OFF	ON	ON	OFF	OFF	ON
155	ON	OFF	OFF	ON	ON	OFF	ON	ON
157	ON	OFF	OFF	ON	ON	ON	OFF	ON
159	ON	OFF	OFF	ON	ON	ON	ON	ON
161	ON	OFF	ON	OFF	OFF	OFF	OFF	ON

Table 2

"+009" (continued)								
"SPA" VALUE	SAT	FRI	THUR	WED	TUE	MON	SUN	ON/OFF
163	ON	OFF	ON	OFF	OFF	OFF	ON	ON
165	ON	OFF	ON	OFF	OFF	ON	OFF	ON
167	ON	OFF	ON	OFF	OFF	ON	ON	ON
169	ON	OFF	ON	OFF	ON	OFF	OFF	ON
171	ON	OFF	ON	OFF	ON	OFF	ON	ON
173	ON	OFF	ON	OFF	ON	ON	OFF	ON
175	ON	OFF	ON	OFF	ON	ON	ON	ON
177	ON	OFF	ON	ON	OFF	OFF	OFF	ON
179	ON	OFF	ON	ON	OFF	OFF	ON	ON
181	ON	OFF	ON	ON	OFF	ON	OFF	ON
183	ON	OFF	ON	ON	OFF	ON	ON	ON
185	ON	OFF	ON	ON	ON	OFF	OFF	ON
187	ON	OFF	ON	ON	ON	OFF	ON	ON
189	ON	OFF	ON	ON	ON	ON	OFF	ON
191	ON	OFF	ON	ON	ON	ON	ON	ON
193	ON	ON	OFF	OFF	OFF	OFF	OFF	ON
195	ON	ON	OFF	OFF	OFF	OFF	ON	ON
197	ON	ON	OFF	OFF	OFF	ON	OFF	ON
199	ON	ON	OFF	OFF	OFF	ON	ON	ON
201	ON	ON	OFF	OFF	ON	OFF	OFF	ON
203	ON	ON	OFF	OFF	ON	OFF	ON	ON
205	ON	ON	OFF	OFF	ON	ON	OFF	ON
207	ON	ON	OFF	OFF	ON	ON	ON	ON
209	ON	ON	OFF	ON	OFF	OFF	OFF	ON
211	ON	ON	OFF	ON	OFF	OFF	ON	ON
213	ON	ON	OFF	ON	OFF	ON	OFF	ON
215	ON	ON	OFF	ON	OFF	ON	ON	ON
217	ON	ON	OFF	ON	ON	OFF	OFF	ON
219	ON	ON	OFF	ON	ON	OFF	ON	ON
221	ON	ON	OFF	ON	ON	ON	OFF	ON
223	ON	ON	OFF	ON	ON	ON	ON	ON
225	ON	ON	ON	OFF	OFF	OFF	OFF	ON
227	ON	ON	ON	OFF	OFF	OFF	ON	ON
229	ON	ON	ON	OFF	OFF	ON	OFF	ON
231	ON	ON	ON	OFF	OFF	ON	ON	ON
233	ON	ON	ON	OFF	ON	OFF	OFF	ON
235	ON	ON	ON	OFF	ON	OFF	ON	ON
237	ON	ON	ON	OFF	ON	ON	OFF	ON
239	ON	ON	ON	OFF	ON	ON	ON	ON
241	ON	ON	ON	ON	OFF	OFF	OFF	ON
243	ON	ON	ON	ON	OFF	OFF	ON	ON
245	ON	ON	ON	ON	OFF	ON	OFF	ON
247	ON	ON	ON	ON	OFF	ON	ON	ON
249	ON	ON	ON	ON	ON	OFF	OFF	ON
251	ON	ON	ON	ON	ON	OFF	ON	ON
253	ON	ON	ON	ON	ON	ON	OFF	ON

Table 2

## Programming NetMaster

"+009" (continued)								
"SPA" VALUE	SAT	FRI	THUR	WED	TUE	MON	SUN	ON/OFF
255	ON	ON	ON	ON	ON	ON	ON	ON

Table 2

## 10. Special Vend A Start Hour “+010”

This option allows the owner to set the hour that Special Vend A will begin.

### How to Program Special Vend A Hour

1. Control must be in Manual Mode. Refer to *Entering the Manual Mode*.
2. Press the DELICATES (+) or the COLD (-) keypad until “PrOg” appears in the VFD. Press the START (enter) keypad and “+001” will appear in the VFD.

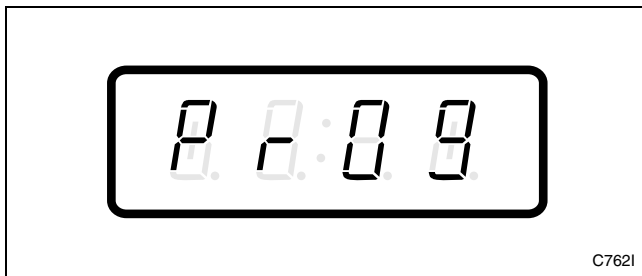

Figure 46

3. Press the DELICATES (+) or the COLD (-) keypad to scroll through the programmable options until “+010” appears in the VFD. Refer to *Figure 47*.

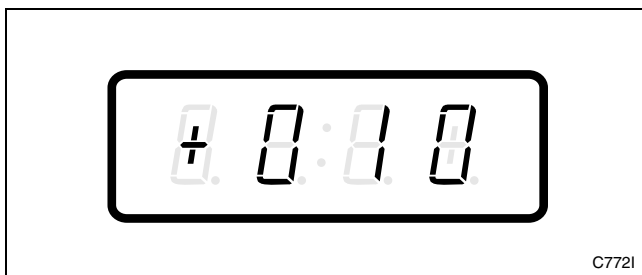

Figure 47

4. When “+010” appears in the VFD, press the START (enter) keypad. The current start time (in military time) will appear in the VFD.

**NOTE: The hours will be displayed in military time.**

5. Press the DELICATES (+) or the COLD (-) keypad to increase or decrease the start hour to the desired hour. Refer to *Figure 48*.

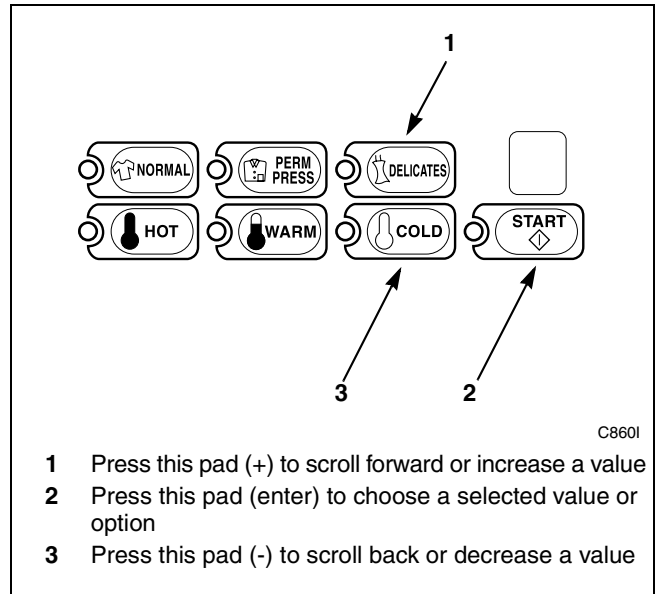

Figure 48

6. Press the START (enter) keypad when the correct hour appears in the VFD. The next option, “+011”, will appear in the VFD.

**NOTE: To program “+011” (Special Vend A Length in Hours), refer to *option 11*. To program other options, refer to the appropriate section.**

### How to Exit Programming Feature

1. Be sure the control shows a programmable option, not a value.
2. While pressing and holding the NORMAL keypad with one hand, press the PERM PRESS keypad with the other hand. The control will revert back to the ready mode. Refer to *Figure 2*.

## 11. Special Vend A Length in Hours “+011”

This option allows the owner to set the length in hours for Special Vend A.

### How to Program Special Vend A Length in Hours

1. Control must be in Manual Mode. Refer to *Entering the Manual Mode*.
2. Press the DELICATES (+) or the COLD (-) keypad until “PrOg” appears in the VFD. Press the START (enter) keypad and “+001” will appear in the VFD.

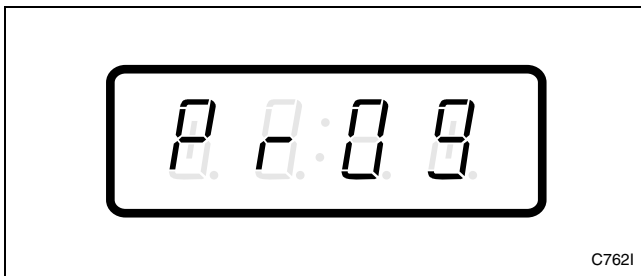

Figure 49

3. Press the DELICATES (+) or the COLD (-) keypad to scroll through the programmable options until “+011” appears in the VFD. Refer to *Figure 50*.

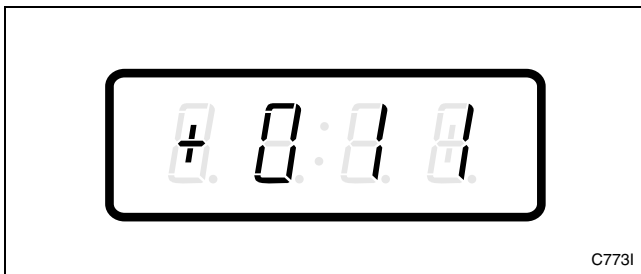
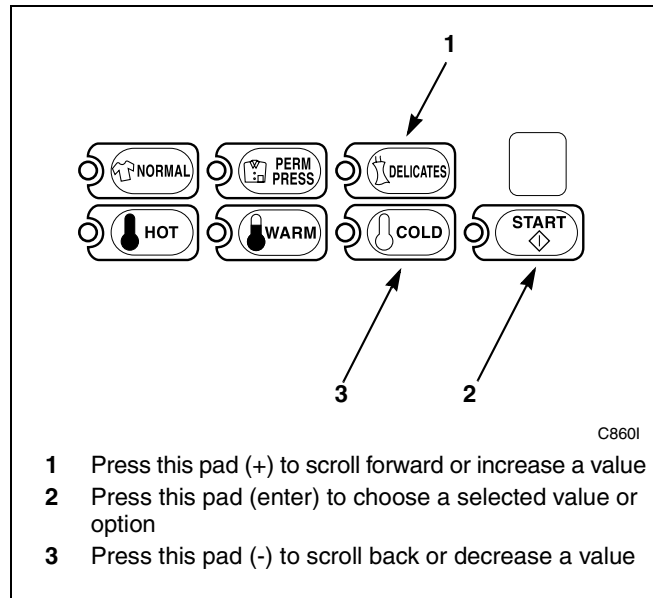

Figure 50

4. When “+011” appears in the VFD, press the START (enter) keypad. The current length in hours will appear in the VFD.

5. Press the DELICATES (+) or the COLD (-) keypad to increase or decrease the current length of hours to the desired number of hours. Refer to *Figure 51*.



- 1 Press this pad (+) to scroll forward or increase a value
- 2 Press this pad (enter) to choose a selected value or option
- 3 Press this pad (-) to scroll back or decrease a value

Figure 51

6. Press the START (enter) keypad when the correct hour appears in the VFD. The next option, “+012”, will appear in the VFD.

**NOTE: To program “+012” (Special Vend A Start Month), refer to *option 12*. To program other options, refer to the appropriate section.**

### How to Exit Programming Feature

1. Be sure the control shows a programmable option, not a value.
2. While pressing and holding the NORMAL keypad with one hand, press the PERM PRESS keypad with the other hand. The control will revert back to the ready mode. Refer to *Figure 2*.



## 12. Special Vend A Start Month “+012”

This option allows the owner to set the month that Special Vend A will begin.

**NOTE: If Special Vend A Start Month, Start Date, End Month, or End Date are programmed to zero (default is zero), the special Vend A will be active every week on the days programmed in option 9.**

### How to Program Special Vend A Start Month

1. Control must be in Manual Mode. Refer to *Entering the Manual Mode*.
2. Press the DELICATES (+) or the COLD (-) keypad until “PrOg” appears in the VFD. Press the START (enter) keypad and “+001” will appear in the VFD.

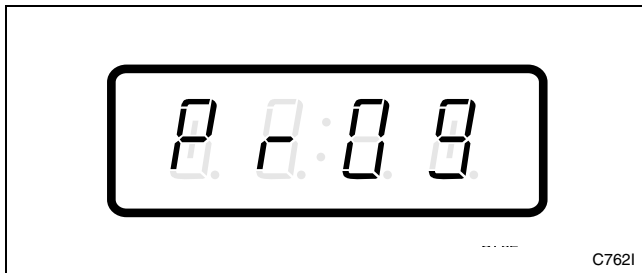

Figure 52

3. Press the DELICATES (+) or the COLD (-) keypad to scroll through the programmable options until “+012” appears in the VFD. Refer to *Figure 53*.

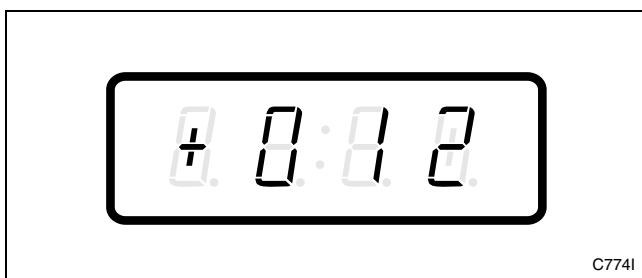

Figure 53

4. When “+012” appears in the VFD, press the START (enter) keypad. The current start month will appear in the VFD.

5. Press the DELICATES (+) or the COLD (-) keypad to increase or decrease the start month to the desired month. Refer to *Figure 54*.

If “0” is selected and Special Vend A is on, Special Vend A will occur at the time and days of week selected, regardless of the month.

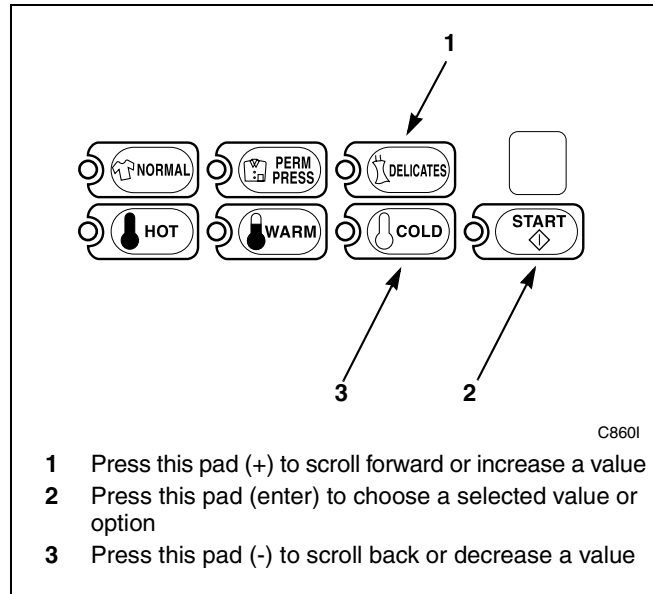

Figure 54

6. Press the START (enter) keypad when the correct month appears in the VFD. The next option, “+013”, will appear in the VFD.

**NOTE: To program “+013” (Special Vend A Start Date), refer to option 13. To program other options, refer to the appropriate section.**

### How to Exit Programming Feature

1. Be sure the control shows a programmable option, not a value.
1. While pressing and holding the NORMAL keypad with one hand, press the PERM PRESS keypad with the other hand. The control will revert back to the ready mode. Refer to *Figure 2*.

### 13. Special Vend A Start Date “+013”

This option allows the owner to set the date that Special Vend A will begin.

#### How to Program Special Vend A Start Date

1. Control must be in Manual Mode. Refer to *Entering the Manual Mode*.
2. Press the DELICATES (+) or the COLD (-) keypad until “PrOg” appears in the VFD. Press the START (enter) keypad and “+001” will appear in the VFD.

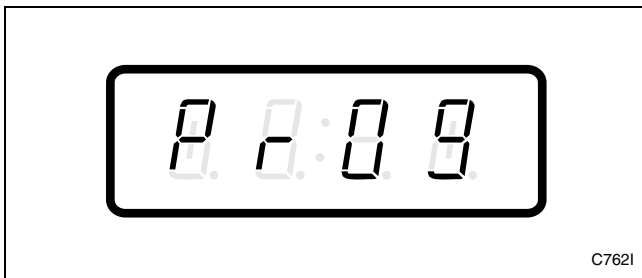

Figure 55

3. Press the DELICATES (+) or the COLD (-) keypad to scroll through the programmable options until “+013” appears in the VFD. Refer to *Figure 56*.

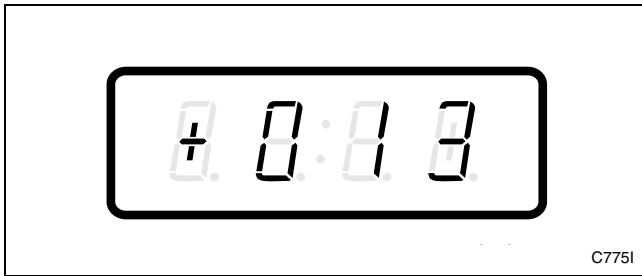
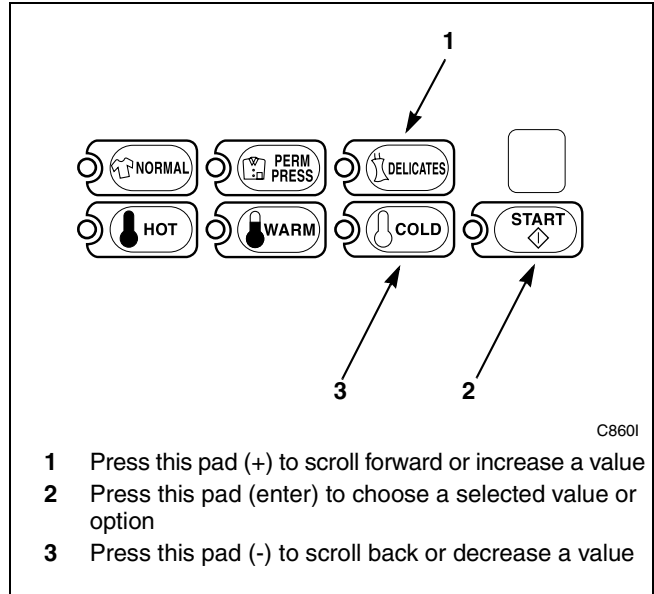

Figure 56

4. When “+013” appears in the VFD, press the START (enter) keypad. The current start date will appear in the VFD.

5. Press the DELICATES (+) or the COLD (-) keypad to increase or decrease the start date to the desired date. Refer to *Figure 57*.

If “0” is selected and Special Vend A is on, Special Vend A will occur at the time or days of week selected, regardless of the date.



- 1 Press this pad (+) to scroll forward or increase a value
- 2 Press this pad (enter) to choose a selected value or option
- 3 Press this pad (-) to scroll back or decrease a value

Figure 57

6. Press the START (enter) keypad when the correct date appears in the VFD. The next option, “+014”, will appear in the VFD.

**NOTE: To program “+014” (Special Vend A End Month), refer to *option 14*. To program other options, refer to the appropriate section.**

#### How to Exit Programming Feature

1. Be sure the control shows a programmable option, not a value.
2. While pressing and holding the NORMAL keypad with one hand, press the PERM PRESS keypad with the other hand. The control will revert back to the ready mode. Refer to *Figure 2*.

## 14. Special Vend A End Month “+014”

This option allows the owner to set the month that Special Vend A will end.

### How to Program Special Vend A End Month

1. Control must be in Manual Mode. Refer to *Entering the Manual Mode*.
2. Press the DELICATES (+) or the COLD (-) keypad until “PrOg” appears in the VFD. Press the START (enter) keypad and “+001” will appear in the VFD.

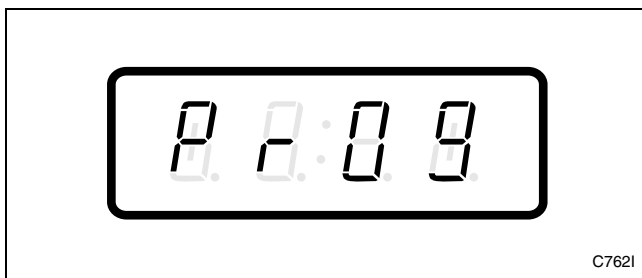

Figure 58

3. Press the DELICATES (+) or the COLD (-) keypad to scroll through the programmable options until “+014” appears in the VFD. Refer to *Figure 59*.

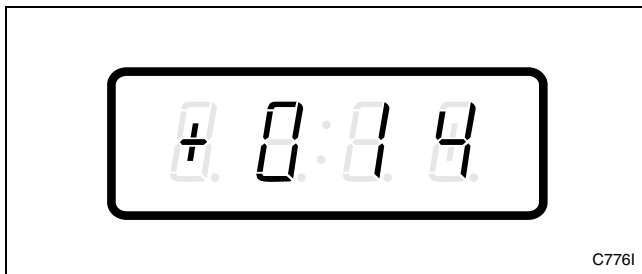
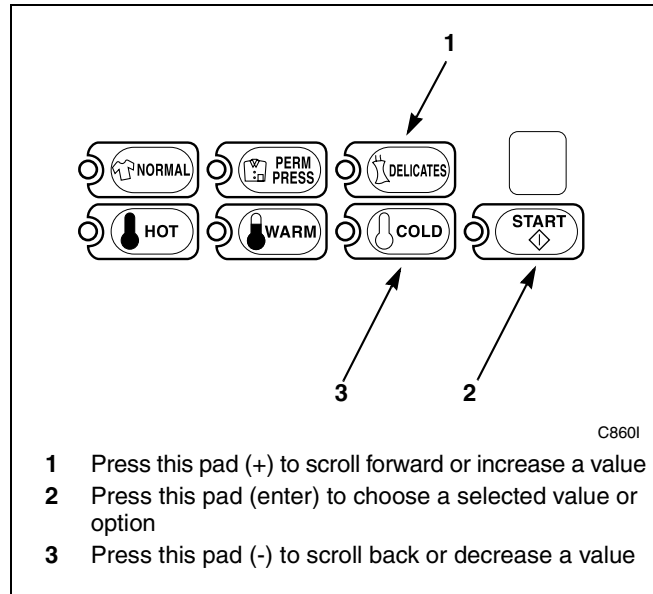

Figure 59

4. When “+014” appears in the VFD, press the START (enter) keypad. The current end month will appear in the VFD.

5. Press the DELICATES (+) or the COLD (-) keypad to increase or decrease the end month to the desired month. Refer to *Figure 60*.

If “0” is selected and Special Vend A is on, Special Vend A will occur at the time or day of week selected, regardless of the month.



- 1 Press this pad (+) to scroll forward or increase a value
- 2 Press this pad (enter) to choose a selected value or option
- 3 Press this pad (-) to scroll back or decrease a value

Figure 60

6. Press the START (enter) keypad when the correct month appears in the VFD. The next option, “+015”, will appear in the VFD.

**NOTE: To program “+015” (Special Vend A End Date), refer to *option 15*. To program other options, refer to the appropriate section.**

### How to Exit Programming Feature

1. Be sure the control shows a programmable option, not a value.
2. While pressing and holding the NORMAL keypad with one hand, press the PERM PRESS keypad with the other hand. The control will revert back to the ready mode. Refer to *Figure 2*.

## 15. Special Vend A End Date “+015”

This option allows the owner to set the date that Special Vend A will end.

### How to Program Special Vend A End Date

1. Control must be in Manual Mode. Refer to *Entering the Manual Mode*.
2. Press the DELICATES (+) or the COLD (-) keypad until “PrOg” appears in the VFD. Press the START (enter) keypad and “+001” will appear in the VFD.

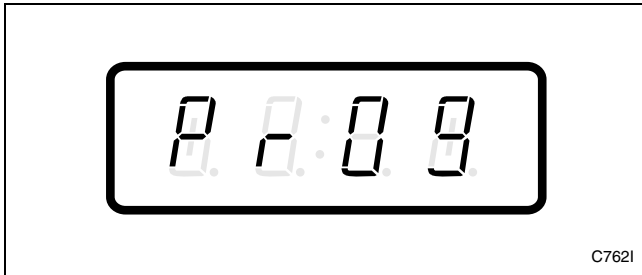

Figure 61

3. Press the DELICATES (+) or the COLD (-) keypad to scroll through the programmable options until “+015” appears in the VFD. Refer to *Figure 62*.

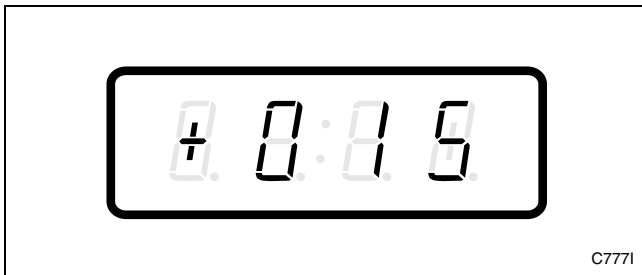
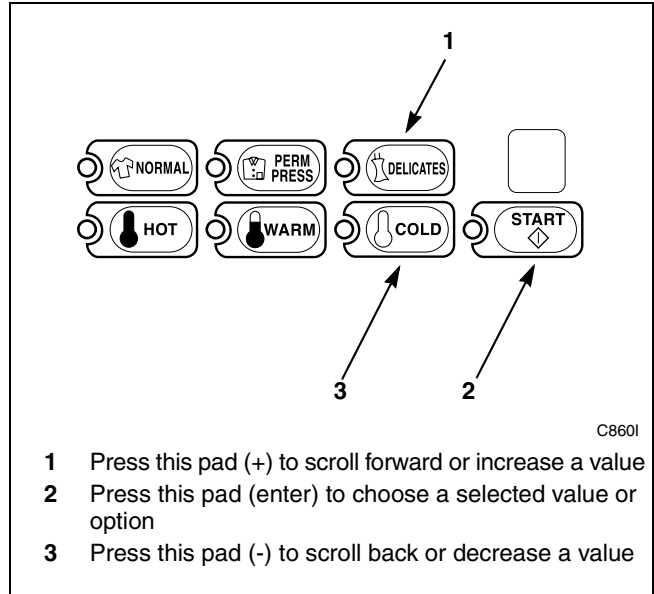

Figure 62

4. When “+015” appears in the VFD, press the START (enter) keypad. The current end date will appear in the VFD.

5. Press the DELICATES (+) or the COLD (-) keypad to increase or decrease the end date to the desired date. Refer to *Figure 63*.

If “0” is selected and Special Vend A is on, Special Vend A will occur at the time or days of week selected, regardless of the date.



- 1 Press this pad (+) to scroll forward or increase a value
- 2 Press this pad (enter) to choose a selected value or option
- 3 Press this pad (-) to scroll back or decrease a value

Figure 63

6. Press the START (enter) keypad when the correct date appears in the VFD. The next option, “+016”, will appear in the VFD.

**NOTE: To program “+016” (Special Vend A Site Code #1), refer to *option 16*. To program other options, refer to the appropriate section.**

### How to Exit Programming Feature

1. Be sure the control shows a programmable option, not a value.
2. While pressing and holding the NORMAL keypad with one hand, press the PERM PRESS keypad with the other hand. The control will revert back to the ready mode. Refer to *Figure 2*.

## 16. Special Vend A Site Code #1 “+016”

This option allows the owner to program the machines to accept site codes for Special Vend A that are specific to select groups or individuals when using cards. It also allows the owner to only give Special Vend A pricing for a card with this site code. If Special Vend A site code is zero, then Special Vend A pricing will apply to all cards.

### How to Program the Special Vend A Site Code #1

1. Control must be in Manual Mode. Refer to *Entering the Manual Mode*.
2. Press the DELICATES (+) or the COLD (-) keypad until “PrOg” appears in the VFD. Press the START (enter) keypad and “+001” will appear in the VFD.

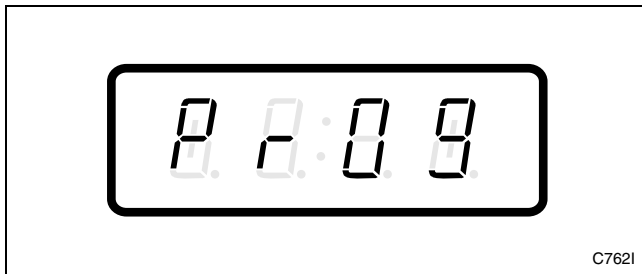

Figure 64

3. Press the DELICATES (+) or the COLD (-) keypad to scroll through the programmable options until “+016” appears in the VFD. Refer to *Figure 65*.

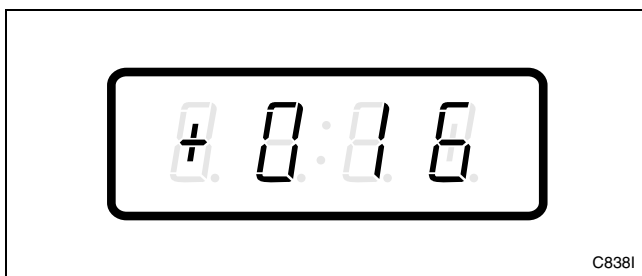

Figure 65

4. When “+016” appears in the VFD, press the START (enter) keypad. There are five digits in the Special Vend A Site Code #1. The fifth digit will appear in the VFD and will flash one second on, one second off. Refer to *Figure 66*.

**NOTE: If the Special Vend A Site Code #1 price is 10000 or more, the fifth digit is “1”. If the Special Vend A Site Code #1 price is 9999 or less, the fifth digit is “0”.**

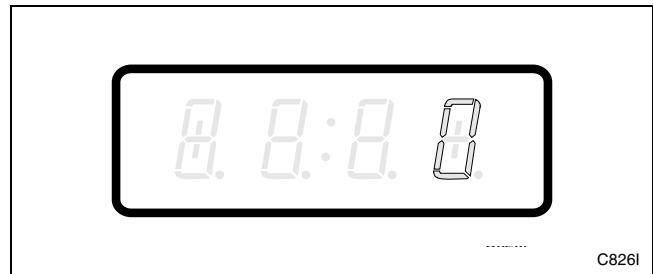
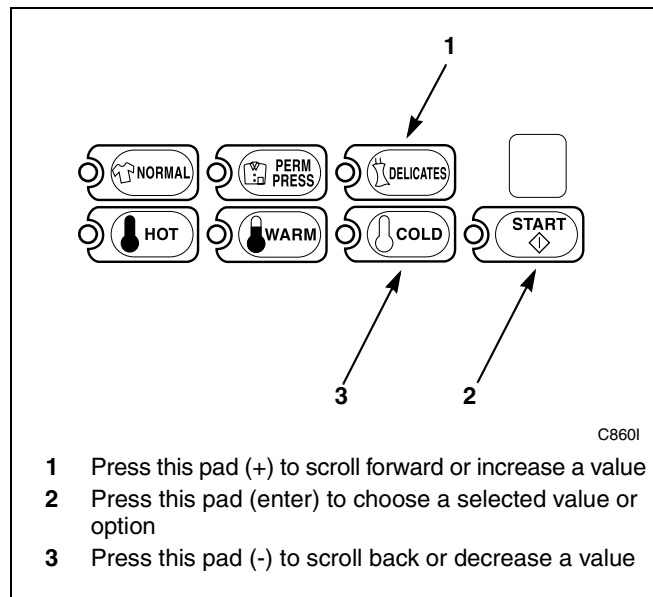

Figure 66

5. Press the DELICATES (+) or the COLD (-) keypad to increase or decrease the value of the fifth digit. Refer to *Figure 67*.

**NOTE: The coin value can be set from 1 to 65,535.**



- 1 Press this pad (+) to scroll forward or increase a value
- 2 Press this pad (enter) to choose a selected value or option
- 3 Press this pad (-) to scroll back or decrease a value

Figure 67

## Programming NetMaster

6. Press the START (enter) keypad to enter the fifth digit and display remaining four digits. The active digit will flash one second on and one second off. Refer to *Figure 68*.

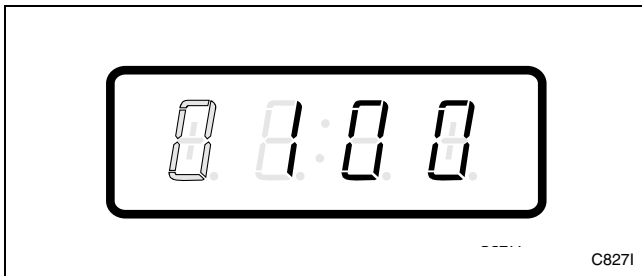

Figure 68

7. Press the DELICATES (+) or the COLD (-) keypad to increase or decrease the value of the active digit and the START (enter) keypad to enter the value of the digit and advance to the next digit.
8. Press the START (enter) keypad with the last active digit. The next option, "+017", will appear in the VFD.

**NOTE: To program "+017" (Special Vend A Reg. Hot Wash Vend Price), refer to *option 17*. To program other options, refer to the appropriate section.**

## How to Exit Programming Feature

1. Be sure the control shows a programmable option, not a value.
2. While pressing and holding the NORMAL keypad with one hand, press the PERM PRESS keypad with the other hand. The control will revert back to the ready mode. Refer to *Figure 2*.

## 17. Special Vend A Reg. Hot Wash Vend Price “+017”

This option allows the owner to set the vend price for a Hot Wash in Special Vend A.

### How to Program Special Vend A Reg. Hot Wash Vend Price

1. Control must be in Manual Mode. Refer to *Entering the Manual Mode*.
2. Press the DELICATES (+) or the COLD (-) keypad until “PrOg” appears in the VFD. Press the START (enter) keypad and “+001” will appear in the VFD.

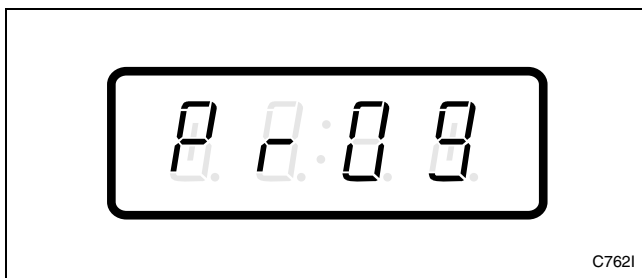

Figure 69

3. Press the DELICATES (+) or the COLD (-) keypad to scroll through the programmable options until “+017” appears in the VFD. Refer to *Figure 70*.

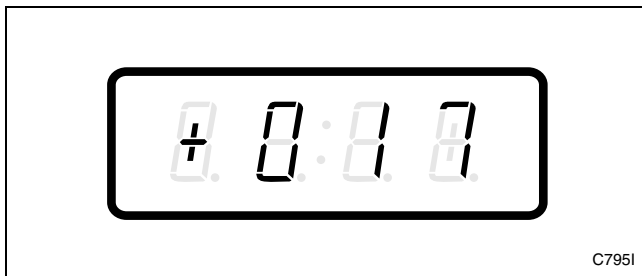

Figure 70

4. When “+017” appears in the VFD, press the START (enter) keypad. There are five digits in the Special Vend A Reg. Hot Wash Vend Price. The fifth digit will appear in the VFD and will flash one second on and one second off. Refer to *Figure 71*.

**NOTE: If the vend price is \$100.00 or more, the fifth digit is “1”. If the vend price is \$99.99 or less, the fifth digit is “0”.**

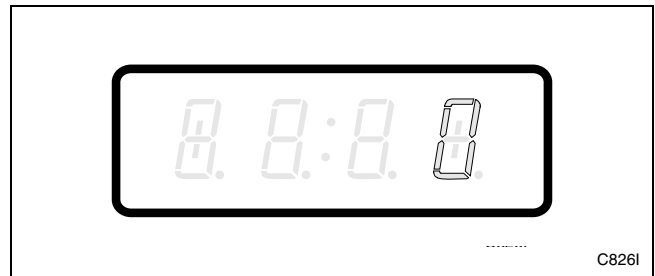
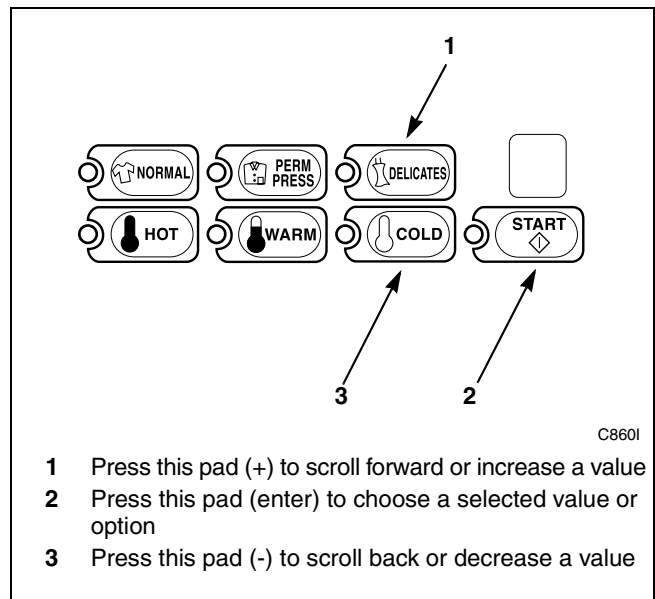

Figure 71

5. Press the DELICATES (+) or the COLD (-) keypad to increase or decrease the value of the fifth digit. Refer to *Figure 72*.

**NOTE: The vend price can be set from 0 to 65,535.**



- 1 Press this pad (+) to scroll forward or increase a value
- 2 Press this pad (enter) to choose a selected value or option
- 3 Press this pad (-) to scroll back or decrease a value

Figure 72

## Programming NetMaster

6. Press the START (enter) keypad to enter the fifth digit and display remaining four digits. The active digit will flash one second on and one second off. Refer to *Figure 73*.

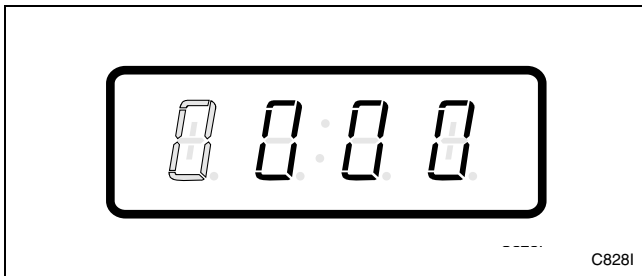

Figure 73

7. Press the DELICATES (+) or the COLD (-) keypad to increase or decrease the value of the active digit and the START keypad to enter the value of the digit and advance to the next digit.
8. Press the START (enter) keypad with the last active digit. The next option, "+018", will appear in the VFD.

**NOTE: To program "+018" (Special Vend A Reg. Warm Wash Vend Price), refer to *option 18*. To program other options, refer to the appropriate section.**

## How to Exit Programming Feature

1. Be sure the control shows a programmable option, not a value.
2. While pressing and holding the NORMAL keypad with one hand, press the PERM PRESS keypad with the other hand. The control will revert back to the ready mode. Refer to *Figure 2*.



## 18. Special Vend A Reg. Warm Wash Vend Price “+018”

This option allows the owner to set the vend price for a Warm Wash in Special Vend A.

### How to Program Special Vend A Reg. Warm Wash Vend Price

1. Control must be in Manual Mode. Refer to *Entering the Manual Mode*.
2. Press the DELICATES (+) or the COLD (-) keypad until “PrOg” appears in the VFD. Press the START (enter) keypad and “+001” will appear in the VFD.

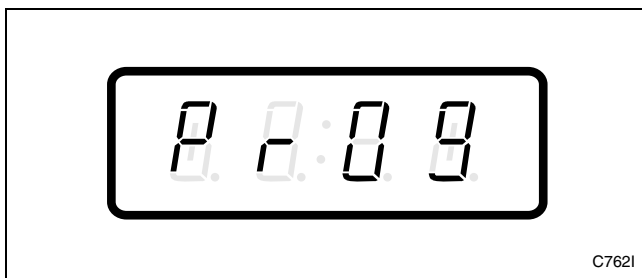

Figure 74

3. Press the DELICATES (+) or the COLD (-) keypad to scroll through the programmable options until “+018” appears in the VFD. Refer to *Figure 75*.

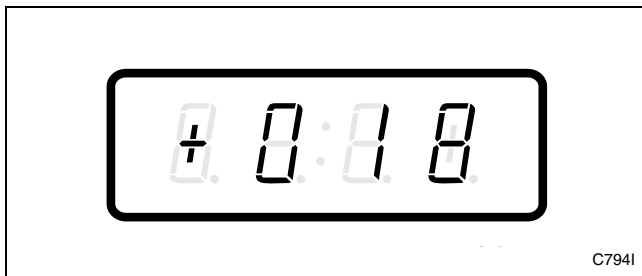

Figure 75

4. When “+018” appears in the VFD, press the START (enter) keypad. There are five digits in the Special Vend A Reg. Warm Wash Vend Price. The fifth digit will appear in the VFD and will flash one second on and one second off. Refer to *Figure 76*.

**NOTE: If the vend price is \$100.00 or more, the fifth digit is “1”. If the vend price is \$99.99 or less, the fifth digit is “0”.**

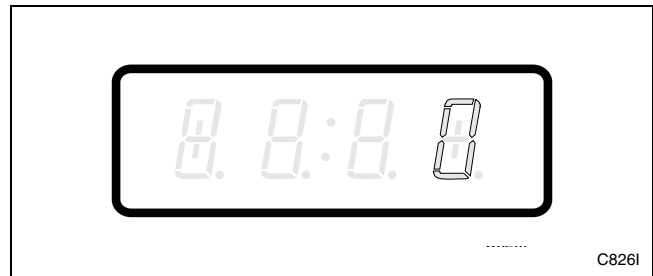
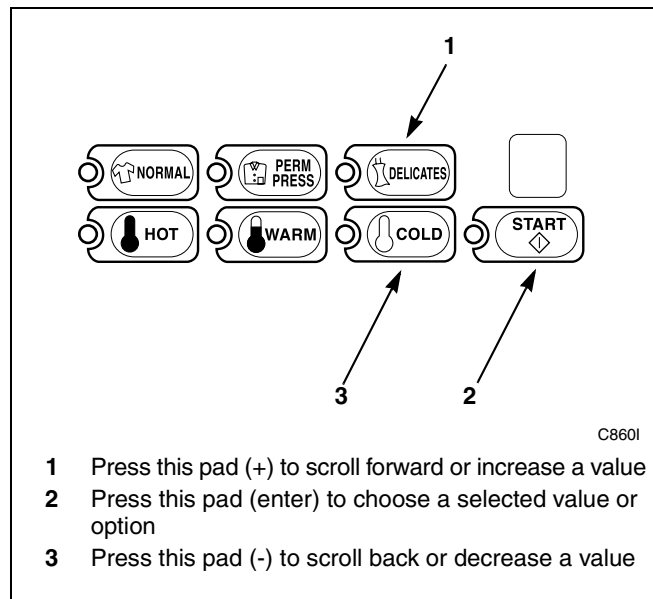

Figure 76

5. Press the DELICATES (+) or the COLD (-) keypad to increase or decrease the value of the fifth digit. Refer to *Figure 77*.

**NOTE: The vend price can be set from 0 to 65,535.**



- 1 Press this pad (+) to scroll forward or increase a value
- 2 Press this pad (enter) to choose a selected value or option
- 3 Press this pad (-) to scroll back or decrease a value

Figure 77

## Programming NetMaster

6. Press the START (enter) keypad to enter the fifth digit and display remaining four digits. The active digit will flash one second on and one second off. Refer to *Figure 78*.

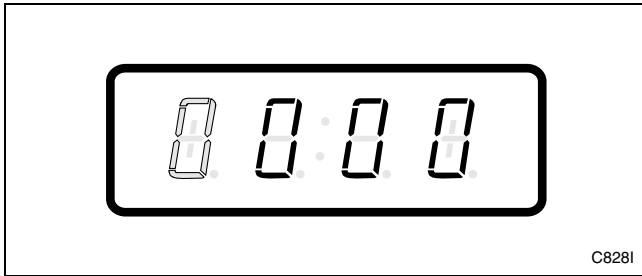

Figure 78

7. Press the DELICATES (+) or the COLD (-) keypad to increase or decrease the value of the active digit and the START (enter) keypad to enter the value of the digit and advance to the next digit.
8. Press the START (enter) keypad with the last active digit. The next option, "+019", will appear in the VFD.

**NOTE: To program "+019" (Special Vend A Reg. Cold Wash Vend Price), refer to *option 19*. To program other options, refer to the appropriate section.**

## How to Exit Programming Feature

1. Be sure the control shows a programmable option, not a value.
2. While pressing and holding the NORMAL keypad with one hand, press the PERM PRESS keypad with the other hand. The control will revert back to the ready mode. Refer to *Figure 2*.

## 19. Special Vend A Reg. Cold Wash Vend Price “+019”

This option allows the owner to set the vend price for a Cold Wash in Special Vend A.

### How to Program Special Vend A Reg. Cold Wash Vend Price

1. Control must be in Manual Mode. Refer to *Entering the Manual Mode*.
2. Press the DELICATES (+) or the COLD (-) keypad until “PrOg” appears in the VFD. Press the START (enter) keypad and “+001” will appear in the VFD.

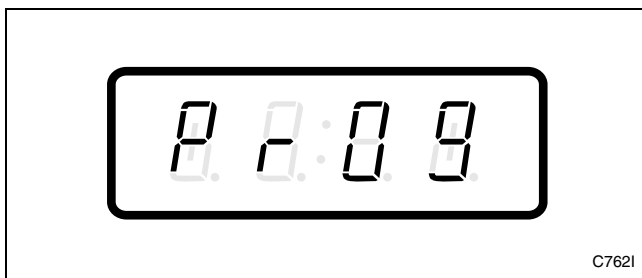

Figure 79

3. Press the DELICATES (+) or the COLD (-) keypad to scroll through the programmable options until “+019” appears in the VFD. Refer to *Figure 80*.

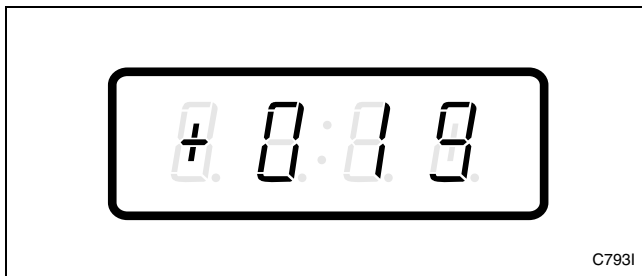

Figure 80

4. When “+019” appears in the VFD, press the START (enter) keypad. There are five digits in the Special Vend A Reg. Cold Wash Vend Price. The fifth digit will appear in the VFD and will flash one second on and one second off. Refer to *Figure 81*.

**NOTE: If the vend price is \$100.00 or more, the fifth digit is “1”. If the vend price is \$99.99 or less, the fifth digit is “0”.**

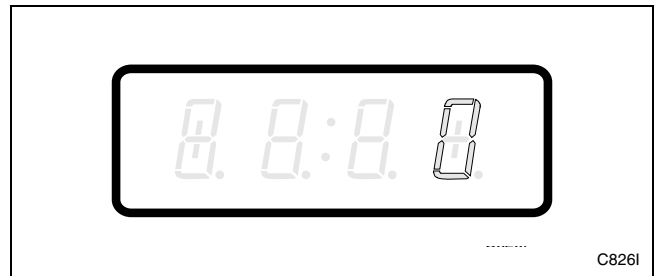
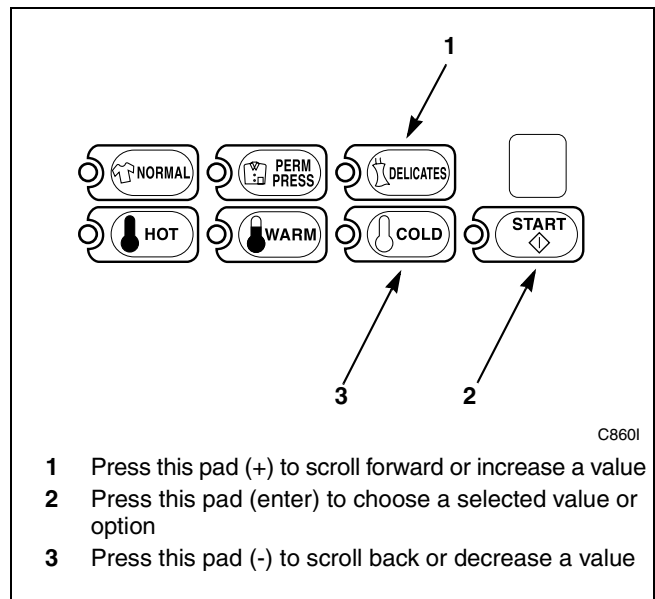

Figure 81

5. Press the DELICATES (+) or the COLD (-) keypad to increase or decrease the value of the fifth digit. Refer to *Figure 82*.

**NOTE: The vend price can be set from 0 to 65,535.**



- 1 Press this pad (+) to scroll forward or increase a value
- 2 Press this pad (enter) to choose a selected value or option
- 3 Press this pad (-) to scroll back or decrease a value

Figure 82

## Programming NetMaster

6. Press the START (enter) keypad to enter the fifth digit and display remaining four digits. The active digit will flash one second on and one second off. Refer to *Figure 83*.

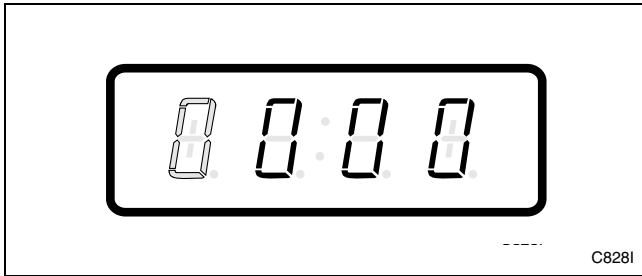

Figure 83

7. Press the DELICATES (+) or the COLD (-) keypad to increase or decrease the value of the active digit and the START keypad to enter the value of the digit and advance to the next digit.
8. Press the START (enter) keypad with the last active digit. The next option, "+020", will appear in the VFD.

**NOTE: To program "+020" (Special Vend A Auto-Shutdown Enable), refer to *option 20*. To program other options, refer to the appropriate section.**

## How to Exit Programming Feature

1. Be sure the control shows a programmable option, not a value.
2. While pressing and holding the NORMAL keypad with one hand, press the PERM PRESS keypad with the other hand. The control will revert back to the ready mode. Refer to *Figure 2*.

## 20. Special Vend A Auto-Shutdown Enable “+020”

This option, when turned on, will force the control to shutdown during the Programmed Special Vend A time period, preventing customers from starting a new cycle after a selected time. “OFF” is displayed on the VFD when Auto-Shutdown is active.

### How to Program Special Vend A Auto-Shutdown Enable

1. Control must be in Manual Mode. Refer to *Entering the Manual Mode*.
2. Press the DELICATES (+) or the COLD (-) keypad until “PrOg” appears in the VFD. Press the START (enter) keypad and “+001” will appear in the VFD.

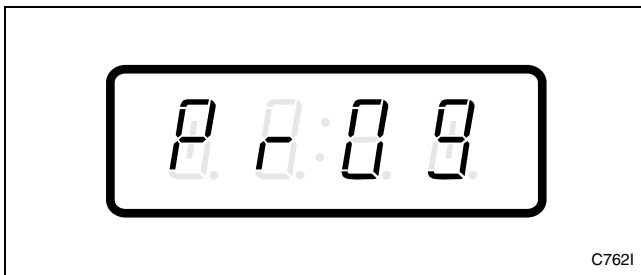

Figure 84

3. Press the DELICATES (+) or the COLD (-) keypad to scroll through the programmable options until “+020” appears in the VFD. Refer to *Figure 85*.

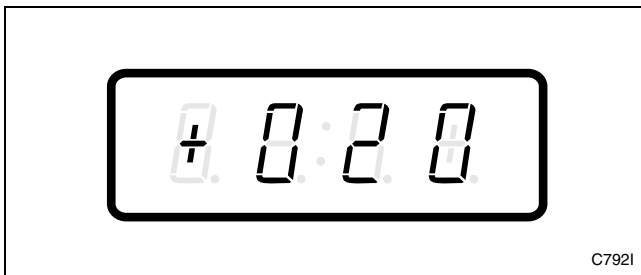
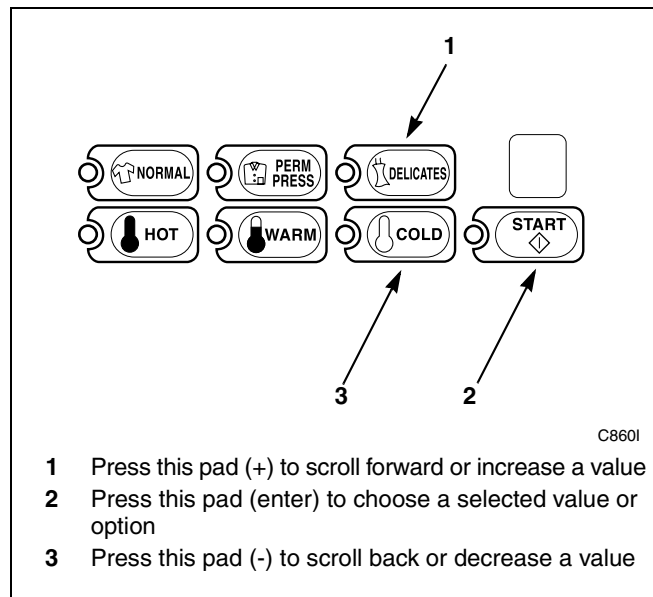

Figure 85

4. When “+020” appears in the VFD, press the START (enter) keypad. The current Special Vend A Auto-Shutdown Enable parameter value will appear in the VFD. “0” will be displayed when Auto-Shutdown is disabled and “255” will be displayed when Auto-Shutdown is enabled.

5. Press the DELICATES (+) or the COLD (-) keypad to increase or decrease the current value displayed in the VFD to the desired value. Refer to *Figure 86*.



- 1 Press this pad (+) to scroll forward or increase a value
- 2 Press this pad (enter) to choose a selected value or option
- 3 Press this pad (-) to scroll back or decrease a value

Figure 86

6. Press the START (enter) keypad when the correct value appears in the VFD. The next option, “+021”, will appear in the VFD.

**NOTE: To program “+021” (Coin #1 Value), refer to option 21. To program other options, refer to the appropriate section.**

### How to Exit Programming Feature

1. Be sure the control shows a programmable option, not a value.
2. While pressing and holding the NORMAL keypad with one hand, press the PERM PRESS keypad with the other hand. The control will revert back to the ready mode. Refer to *Figure 2*.

## 21. Coin #1 Value “+021”

This option allows the owner to set a specific numerical value for a coin entered. For example, in the United States the coin value for one quarter would be measured in cents (25). Therefore, the coin value entered for one quarter would be 00025.

If the Reg. Hot Wash Vend Price (*option 2*) is set for “.75”, and the Coin Value is set for “00025”, the vend price displayed will decrease by .25 for each coin entered.

### How to Program Coin #1 Value

1. Control must be in Manual Mode. Refer to *Entering the Manual Mode*.
2. Press the DELICATES (+) or the COLD (-) keypad until “PrOg” appears in the VFD. Press the START (enter) keypad and “+001” will appear in the VFD.

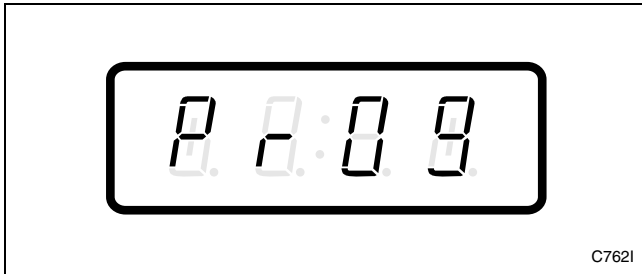

Figure 87

3. Press the DELICATES (+) or the COLD (-) keypad to scroll through the programmable options until “+021” appears in the VFD. Refer to *Figure 88*.

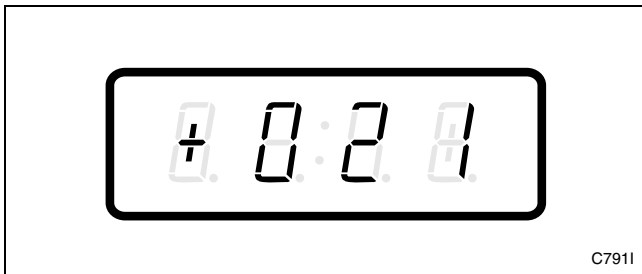

Figure 88

4. When “+021” appears in the VFD, press the START (enter) keypad. There are five digits in the Coin #1 Value. The fifth digit will appear in the VFD and will flash one second on and one second off. Refer to *Figure 89*.

**NOTE: If the coin value is \$100.00 or more, the fifth digit is “1”. If the coin value is \$99.99 or less, the fifth digit is “0”.**

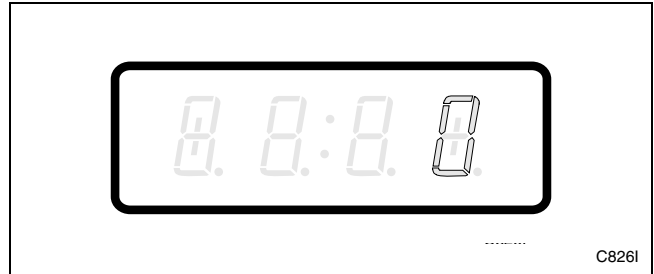
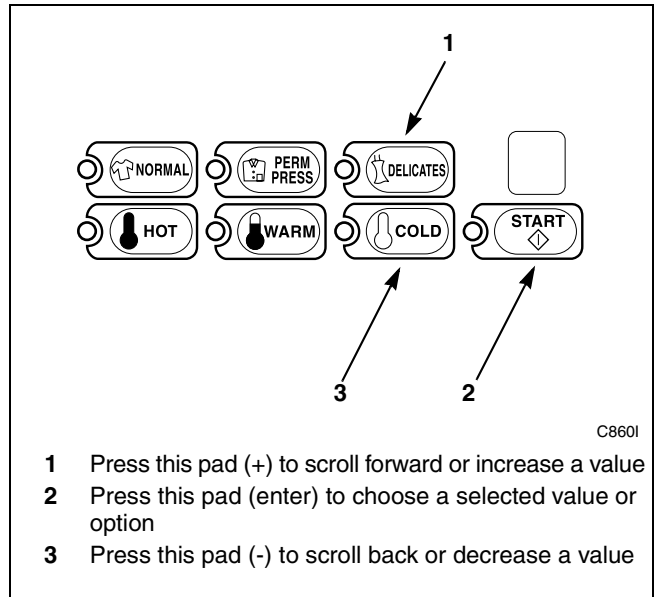

Figure 89

5. Press the DELICATES (+) or the COLD (-) keypad to increase or decrease the value of the fifth digit. Refer to *Figure 90*.

**NOTE: The coin value can be set from 1 to 65,535.**



- 1 Press this pad (+) to scroll forward or increase a value
- 2 Press this pad (enter) to choose a selected value or option
- 3 Press this pad (-) to scroll back or decrease a value

Figure 90

6. Press the START (enter) keypad to enter the fifth digit and display remaining four digits. The active digit will flash one second on and one second off. Refer to *Figure 91*.

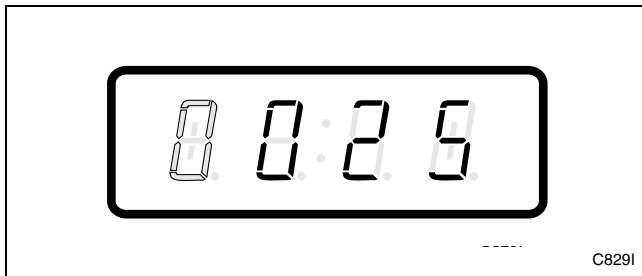

Figure 91

7. Press the DELICATES (+) or the COLD (-) keypad to increase or decrease the value of the active digit and the START (enter) keypad to enter the value of the digit and advance to the next digit.
8. Press the START (enter) keypad with the last active digit. The next option, "+022", will appear in the VFD.

**NOTE: To program "+022" (Coin #2 Value), refer to *option 22*. To program other options, refer to the appropriate section.**

## How to Exit Programming Feature

1. Be sure the control shows a programmable option, not a value.
2. While pressing and holding the NORMAL keypad with one hand, press the PERM PRESS keypad with the other hand. The control will revert back to the ready mode. Refer to *Figure 2*.

## 22. Coin #2 Value “+022”

This option allows the owner to set a specific numerical value for a coin entered when using the dual coin drop. For example, the coin value for a dollar coin would be measured in cents (1.00). Therefore, the coin value entered for one dollar coin would be 00100.

If the Reg. Hot Wash Vend Price (*option 2*) is set for “2.00”, and the Coin Value is set for “00100”, the vend price displayed will decrease by 1.00 for each dollar coin entered.

### How to Program Coin #2 Value

1. Control must be in Manual Mode. Refer to *Entering the Manual Mode*.
2. Press the DELICATES (+) or the COLD (-) keypad until “PrOg” appears in the VFD. Press the START (enter) keypad and “+001” will appear in the VFD.

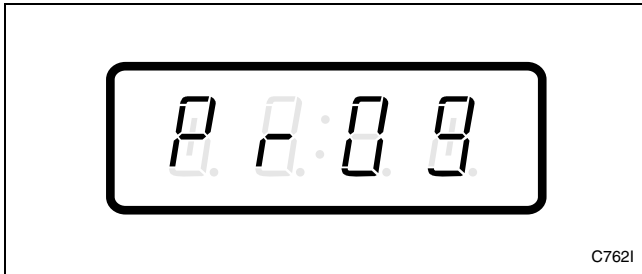

Figure 92

3. Press the DELICATES (+) or the COLD (-) keypad to scroll through the programmable options until “+022” appears in the VFD. Refer to *Figure 93*.

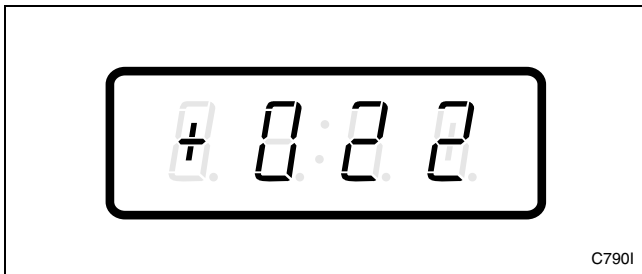

Figure 93

4. When “+022” appears in the VFD, press the START (enter) keypad. There are five digits in the Coin #2 Value. The fifth digit will appear in the VFD and will flash one second on and one second off. Refer to *Figure 94*.

**NOTE: If the coin value is \$100.00 or more, the fifth digit is “1”. If the coin value is \$99.99 or less, the fifth digit is “0”.**

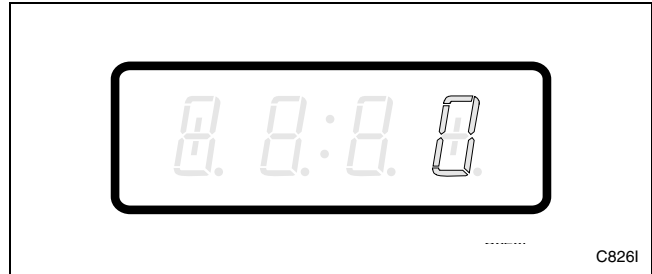
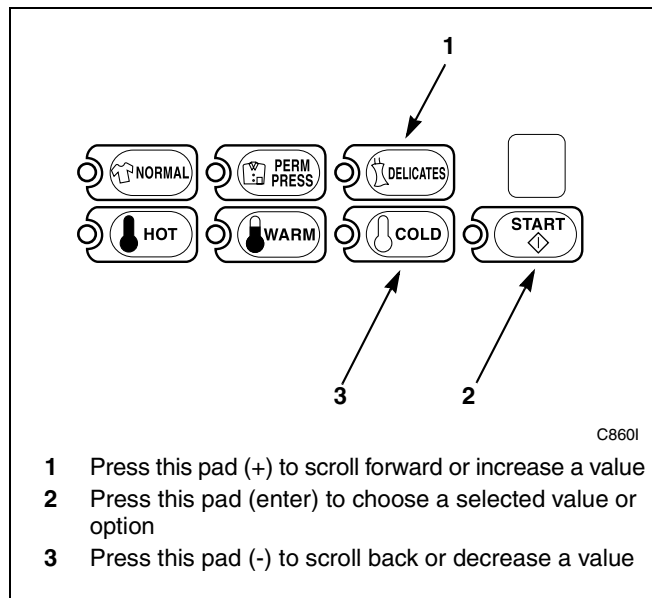

Figure 94

5. Press the DELICATES (+) or the COLD (-) keypad to increase or decrease the value of the fifth digit. Refer to *Figure 95*.

**NOTE: The coin value can be set from 1 to 65,535.**



- 1 Press this pad (+) to scroll forward or increase a value
- 2 Press this pad (enter) to choose a selected value or option
- 3 Press this pad (-) to scroll back or decrease a value

Figure 95



6. Press the START (enter) keypad to enter the fifth digit and display remaining four digits. The active digit will flash one second on and one second off. Refer to *Figure 96*.

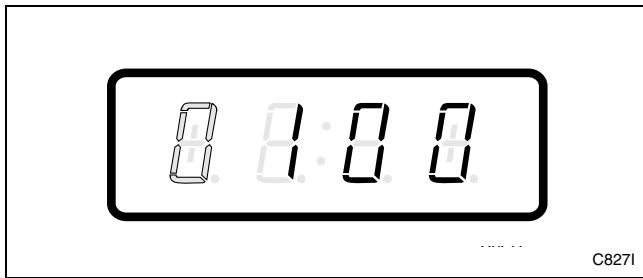

Figure 96

7. Press the DELICATES (+) or the COLD (-) keypad to increase or decrease the value of the active digit and the START (enter) keypad to enter the value of the digit and advance to the next digit.
8. Press the START (enter) keypad with the last active digit. The next option, “+023”, will appear in the VFD.

**NOTE: To program “+023” (Start Pulse Value), refer to *option 23*. To program other options, refer to the appropriate section.**

## How to Exit Programming Feature

1. Be sure the control shows a programmable option, not a value.
2. While pressing and holding the NORMAL keypad with one hand, press the PERM PRESS keypad with the other hand. The control will revert back to the ready mode. Refer to *Figure 2*.

### 23. Start Pulse Value “+023”

This option allows the owner to program the value of the Start Pulse if used for multiple pulses with an after-market central card reader or pay system. Refer to *option 55* for additional information.

#### How to Program Start Pulse Value

1. Control must be in Manual Mode. Refer to *Entering the Manual Mode*.
2. Press the DELICATES (+) or the COLD (-) keypad until “PrOg” appears in the VFD. Press the START (enter) keypad and “+001” will appear in the VFD.

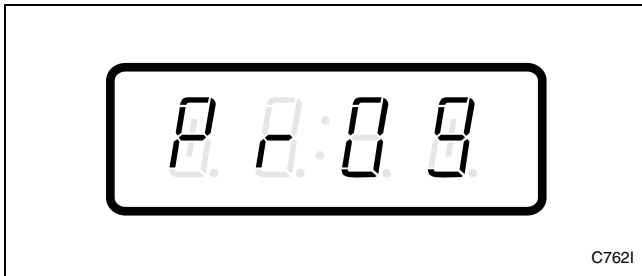

Figure 97

3. Press the DELICATES (+) or the COLD (-) keypad to scroll through the programmable options until “+023” appears in the VFD. Refer to *Figure 98*.



Figure 98

4. When “+023” appears in the VFD, press the START (enter) keypad. There are five digits in the Start Pulse Value. The fifth digit will appear in the VFD and will flash one second on and one second off. Refer to *Figure 99*.

**NOTE: If the Start Pulse Value is \$100.00 or more, the fifth digit is “1”. If the Start Pulse Value is \$99.99 or less, the fifth digit is “0”.**

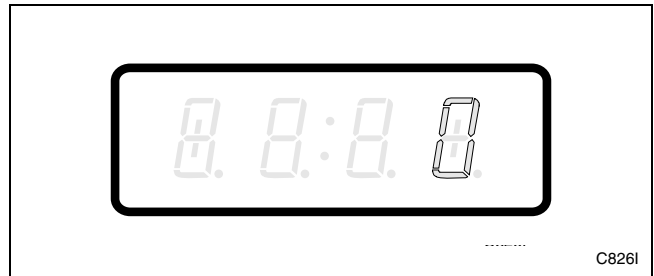
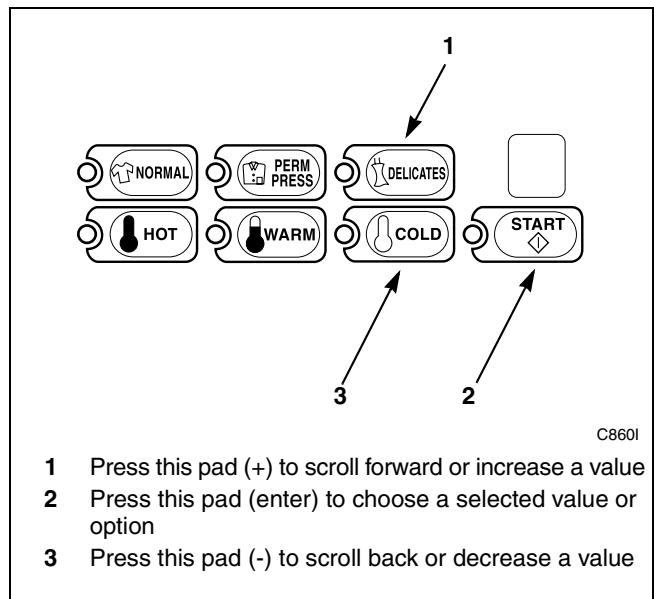

Figure 99

5. Press the DELICATES (+) or the COLD (-) keypad to increase or decrease the value of the fifth digit. Refer to *Figure 100*.

**NOTE: The Start Pulse Value can be set from 1 to 65,535.**



- 1 Press this pad (+) to scroll forward or increase a value
- 2 Press this pad (enter) to choose a selected value or option
- 3 Press this pad (-) to scroll back or decrease a value

Figure 100

6. Press the START (enter) keypad to enter the fifth digit and display remaining four digits. The active digit will flash one second on and one second off. Refer to *Figure 101*.

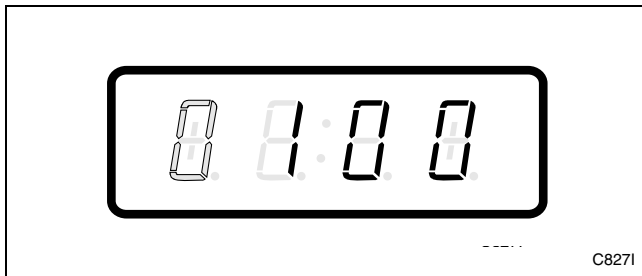

Figure 101

7. Press the DELICATES (+) or the COLD (-) keypad to increase or decrease the value of the active digit and the START (enter) keypad to enter the value of the digit and advance to the next digit.
8. Press the START (enter) keypad with the last active digit. The next option, “+024”, will appear in the VFD.

**NOTE: To program “+024” (Default Cycle/Temperature), refer to *option 24*. To program other options, refer to the appropriate section.**

## How to Exit Programming Feature

1. Be sure the control shows a programmable option, not a value.
2. While pressing and holding the NORMAL keypad with one hand, press the PERM PRESS keypad with the other hand. The control will revert back to the ready mode. Refer to *Figure 2*.

## 24. Default Cycle/Temperature “+024”

This option allows the owner to set the default cycle and temperature the machine will enter when in the ready mode. When programming the default cycle, refer to *Table 3* on the following page.

### How to Program Default Cycle/Temperature

1. Control must be in Manual Mode. Refer to *Entering the Manual Mode*.
2. Press the DELICATES (+) or the COLD (-) keypad until “PrOg” appears in the VFD. Press the START (enter) keypad and “+001” will appear in the VFD.

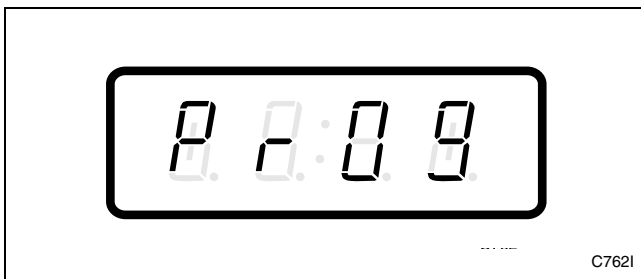

Figure 102

3. Press the DELICATES (+) or the COLD (-) keypad to scroll through the programmable options until “+024” appears in the VFD. Refer to *Figure 103*.

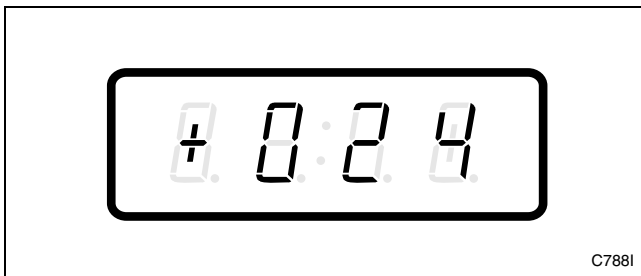
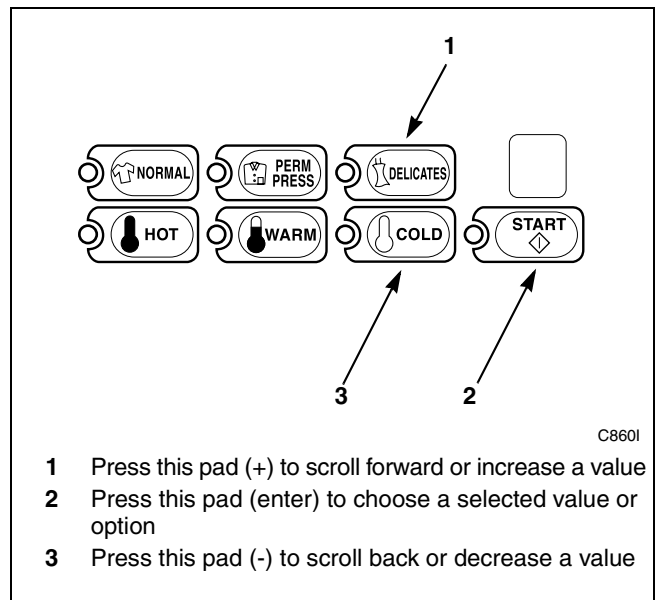

Figure 103

4. When “+024” appears in the VFD, press the START (enter) keypad. A number will appear in the VFD. This number corresponds to the current default cycle value.

5. Press the DELICATES (+) or the COLD (-) keypad to increase or decrease the current number to the desired number selected from *Table 3* on the following page. Refer to *Figure 104*.



- 1 Press this pad (+) to scroll forward or increase a value
- 2 Press this pad (enter) to choose a selected value or option
- 3 Press this pad (-) to scroll back or decrease a value

Figure 104

6. Press the START (enter) keypad when the correct number appears in the VFD. The next option, “+025”, will appear in the VFD.

**NOTE: To program “+025” (Power Fail Reset), refer to option 25. To program other options, refer to the appropriate section.**

### How to Exit Programming Feature

1. Be sure the control shows a programmable option, not a value.
2. While pressing and holding the NORMAL keypad with one hand, press the PERM PRESS keypad with the other hand. The control will revert back to the ready mode. Refer to *Figure 2*.

**How to Read Table 3**

To determine the correct number required to program Default Cycle/Temperature, use the following table. The Default Value column contains the number required in step 5. The other columns correspond to individual options.

column's option is turned on or off when the Default Value is entered. Select the desired combination of options and enter the number found in the Default Value column.

Each column of options contains a unique combination of the words "ON" and "OFF" that indicates if that

<b>"+024"</b>						
<b>Default Value</b>	<b>Normal Cycle</b>	<b>Perm Press Cycle</b>	<b>Delicate Cycle</b>	<b>Hot Wash</b>	<b>Warm Wash</b>	<b>Cold Wash</b>
9	OFF	OFF	ON	OFF	OFF	ON
10	OFF	OFF	ON	OFF	ON	OFF
12	OFF	OFF	ON	ON	OFF	OFF
17	OFF	ON	OFF	OFF	OFF	ON
18	OFF	ON	OFF	OFF	ON	OFF
20	OFF	ON	OFF	ON	OFF	OFF
33	ON	OFF	OFF	OFF	OFF	ON
34	ON	OFF	OFF	OFF	ON	OFF
36	ON	OFF	OFF	ON	OFF	OFF

Table 3

## 25. Power Fail Reset “+025”

This option allows the owner to set the amount of time NetMaster will store active cycle information in the event of a power failure. The default setting for Power Fail Reset is OFF. If Power Fail Reset is turned OFF, the cycle will be saved for up to six years.

### How to Program Power Fail Reset

1. Control must be in Manual Mode. Refer to *Entering the Manual Mode*.
2. Press the DELICATES (+) or the COLD (-) keypad until “PrOg” appears in the VFD. Press the START (enter) keypad and “+001” will appear in the VFD.

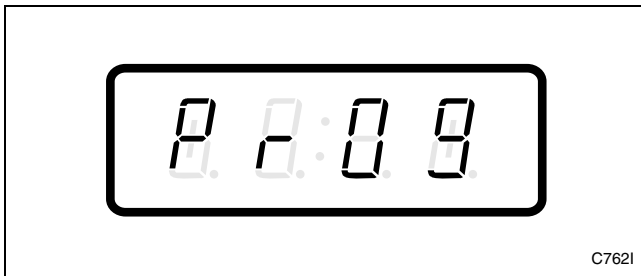

Figure 105

3. Press the DELICATES (+) or the COLD (-) keypad to scroll through the programmable options until “+025” appears in the VFD. Refer to *Figure 106*.

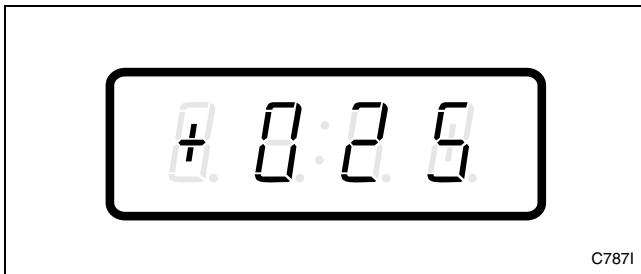
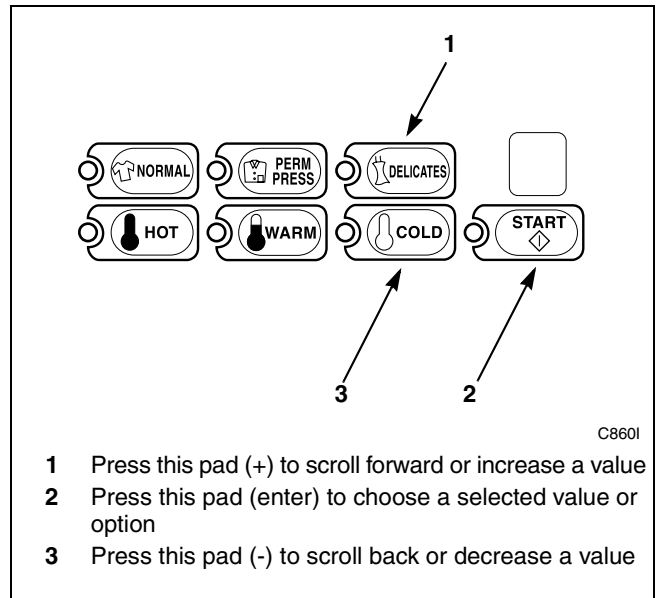

Figure 106

4. When “+025” appears in the VFD, press the START (enter) keypad. A number will appear in the VFD. This number corresponds to the current Power Fail Reset setting.

5. Press the DELICATES (+) or the COLD (-) keypad to increase or decrease the current number to the desired number selected from *Table 4*. Refer to *Figure 107*.



- 1 Press this pad (+) to scroll forward or increase a value
- 2 Press this pad (enter) to choose a selected value or option
- 3 Press this pad (-) to scroll back or decrease a value

Figure 107

6. Press the START (enter) keypad when the correct number appears in the VFD. The next option, “+026”, will appear in the VFD.

**NOTE: To program “+026” (Set Real-Time Clock Minutes), refer to *option 26*. To program other options, refer to the appropriate section.**

### How to Exit Programming Feature

1. Be sure the control shows a programmable option, not a value.
2. While pressing and holding the NORMAL keypad with one hand, press the PERM PRESS keypad with the other hand. The control will revert back to the ready mode. Refer to *Figure 2*.

**How to Read Table 4**

Use this table to set the amount of time for Power Fail Reset.

The table range begins at 0 and ends at 255. Numbers entered between 0 and 127 turn the option OFF. If a number in this range is entered, the current cycle status will be saved for up to six years. When power is restored, the cycle will begin where it was interrupted.

If 133 is entered, the current cycle will be saved for up to five minutes. If power is not restored within five minutes, the control will erase the cycle status. The minimum power failure time is five minutes. The maximum power fail reset time is 127 minutes.

<b>“+025”</b>	
<b>NUMBER TO ENTER IN STEP 6</b>	<b>POWER FAIL RESET TIME</b>
000 – 127	Turned OFF Cycle will be saved for a minimum of 6 years
133	5 minutes without power before cycle is lost
. . . add one minute for every number up to	
255	127 minutes without power before cycle is lost

Table 4

## 26. Set Real-Time Clock Minutes “+026”

This option allows the owner to set NetMaster’s internal clock to the correct time in minutes.

### How to Program the Clock Minutes

1. Control must be in Manual Mode. Refer to *Entering the Manual Mode*.
2. Press the DELICATES (+) or the COLD (-) keypad until “PrOg” appears in the VFD. Press the START (enter) keypad and “+001” will appear in the VFD.

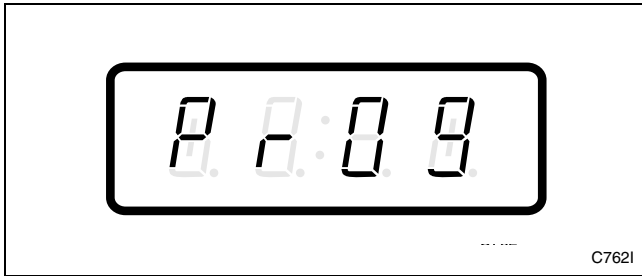

Figure 108

3. Press the DELICATES (+) or the COLD (-) keypad to scroll through the programmable options until “+026” appears in the VFD. Refer to *Figure 109*.

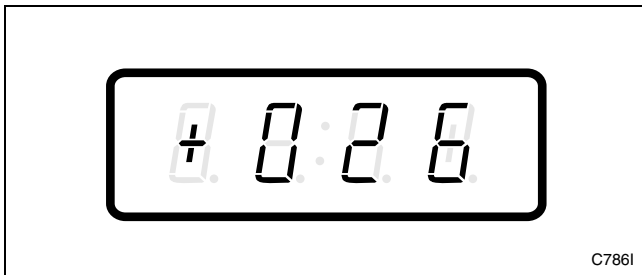

Figure 109

4. When “+026” appears in the VFD, press the START (enter) keypad. The current time in minutes will appear in the VFD.

5. Press the DELICATES (+) or the COLD (-) keypad to increase or decrease the minutes to the correct time. Refer to *Figure 110*.

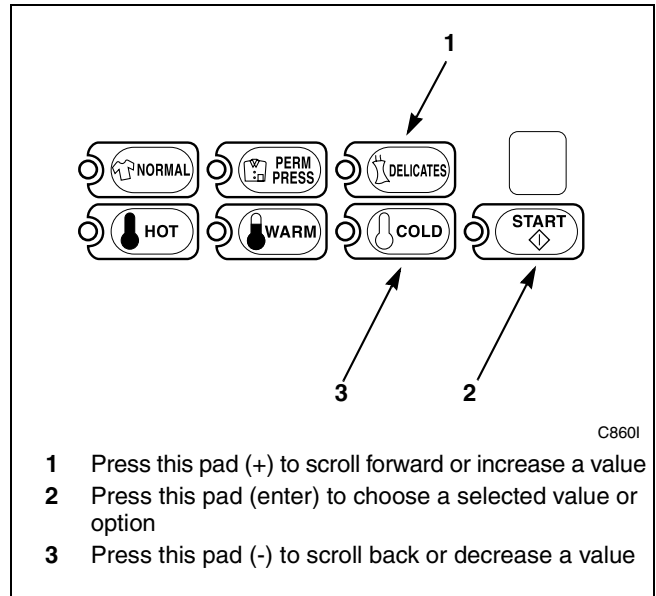

Figure 110

6. Press the START (enter) keypad when the correct time in minutes appears in the VFD. The next option, “+027”, will appear in the VFD.

**NOTE: To program “+027” (Set Real-Time Clock Hours), refer to *option 27*. To program other options, refer to the appropriate section.**

### How to Exit Programming Feature

1. Be sure the control shows a programmable option, not a value.
2. While pressing and holding the NORMAL keypad with one hand, press the PERM PRESS keypad with the other hand. The control will revert back to the ready mode. Refer to *Figure 2*.



## 27. Set Real-Time Clock Hours “+027”

This option allows the owner to set NetMaster’s internal clock to the correct time in hours.

### How to Program the Clock Hours

1. Control must be in Manual Mode. Refer to *Entering the Manual Mode*.
2. Press the DELICATES (+) or the COLD (-) keypad until “PrOg” appears in the VFD. Press the START (enter) keypad and “+001” will appear in the VFD.

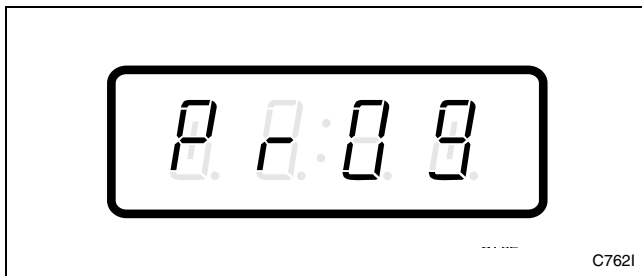

Figure 111

3. Press the DELICATES (+) or the COLD (-) keypad to scroll through the programmable options until “+027” appears in the VFD. Refer to *Figure 112*.

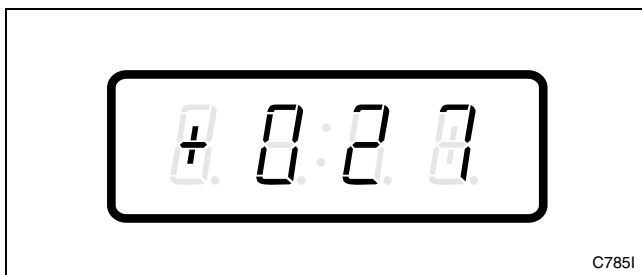

Figure 112

4. When “+027” appears in the VFD, press the START (enter) keypad. The current time in hours will appear in the VFD.

**NOTE: The hours will be displayed in military time.**

5. Press the DELICATES (+) or the COLD (-) keypad to increase or decrease the hours to the correct time. Refer to *Figure 113*.

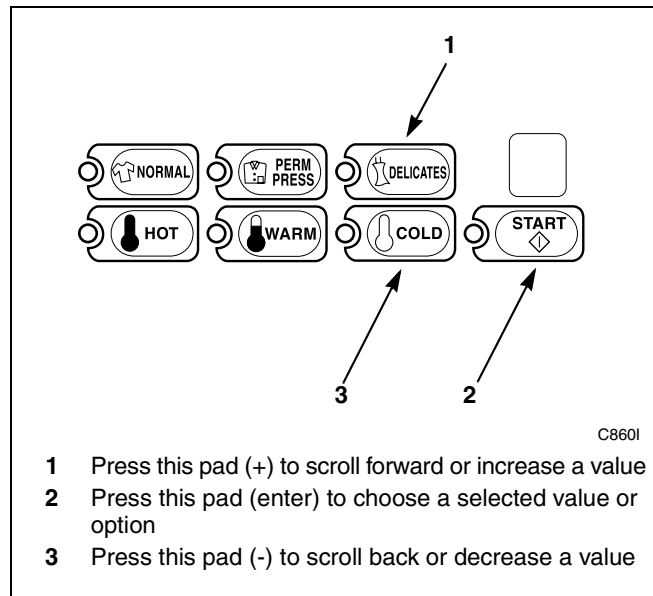

Figure 113

6. Press the START (enter) keypad when the correct time in hours appears in the VFD. The next option, “+028”, will appear in the VFD.

**NOTE: To program “+028” (Set Real-Time Clock Day), refer to option 28. To program other options, refer to the appropriate section.**

### How to Exit Programming Feature

1. Be sure the control shows a programmable option, not a value.
2. While pressing and holding the NORMAL keypad with one hand, press the PERM PRESS keypad with the other hand. The control will revert back to the ready mode. Refer to *Figure 2*.

## 28. Set Real-Time Clock Day “+028”

This option allows the owner to set NetMaster’s internal clock to the correct day of the week.

### How to Program the Clock Day

1. Control must be in Manual Mode. Refer to *Entering the Manual Mode*.
2. Press the DELICATES (+) or the COLD (-) keypad until “PrOg” appears in the VFD. Press the START (enter) keypad and “+001” will appear in the VFD.

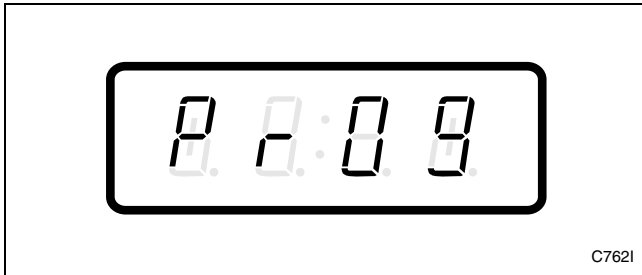

Figure 114

3. Press the DELICATES (+) or the COLD (-) keypad to scroll through the programmable options until “+028” appears in the VFD. Refer to *Figure 115*.

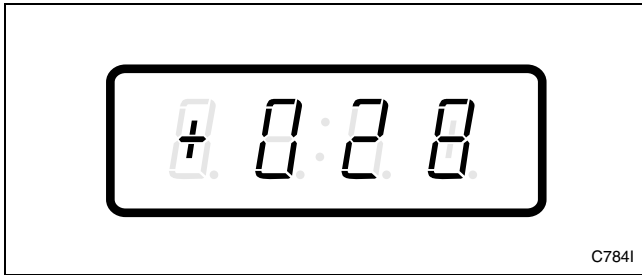
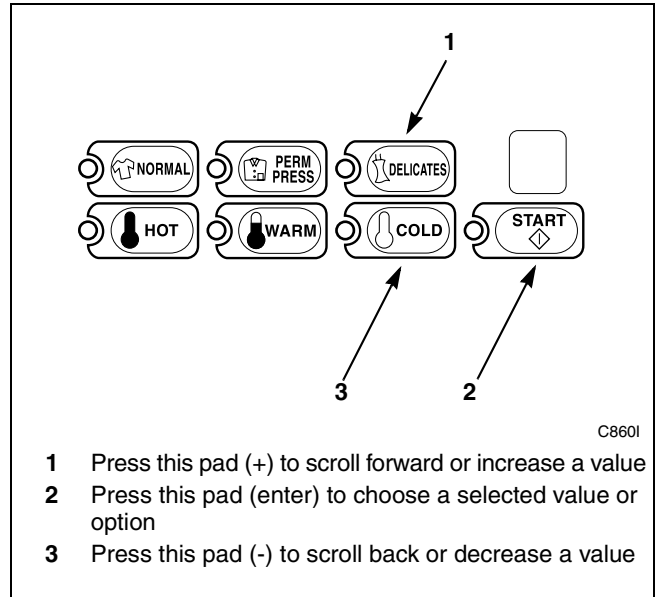

Figure 115

4. When “+028” appears in the VFD, press the START (enter) keypad. The current day of the week will appear in the VFD.

5. Press the DELICATES (+) or the COLD (-) keypad to increase or decrease the day until correct. Refer to *Figure 116*.

**NOTE: Sunday is considered day one (001), Monday is day two (002) and so on.**



- 1 Press this pad (+) to scroll forward or increase a value
- 2 Press this pad (enter) to choose a selected value or option
- 3 Press this pad (-) to scroll back or decrease a value

Figure 116

6. Press the START (enter) keypad when the correct day appears in the VFD. The next option, “+029”, will appear in the VFD.

**NOTE: To program “+029” (Set Real-Time Clock Date), refer to *option 29*. To program other options, refer to the appropriate section.**

### How to Exit Programming Feature

1. Be sure the control shows a programmable option, not a value.
2. While pressing and holding the NORMAL keypad with one hand, press the PERM PRESS keypad with the other hand. The control will revert back to the ready mode. Refer to *Figure 2*.

## 29. Set Real-Time Clock Date “+029”

This option allows the owner to set NetMaster’s internal clock to the correct day of the month.

### How to Program the Clock Date

1. Control must be in Manual Mode. Refer to *Entering the Manual Mode*.
2. Press the DELICATES (+) or the COLD (-) keypad until “PrOg” appears in the VFD. Press the START (enter) keypad and “+001” will appear in the VFD.

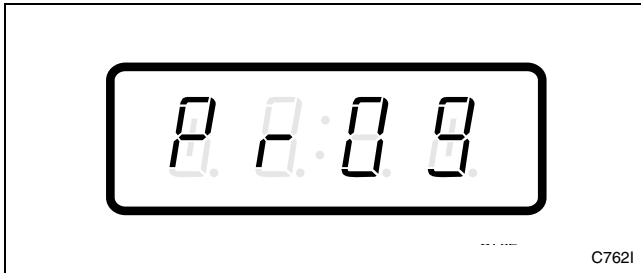

Figure 117

3. Press the DELICATES (+) or the COLD (-) keypad to scroll through the programmable options until “+029” appears in the VFD. Refer to *Figure 118*.

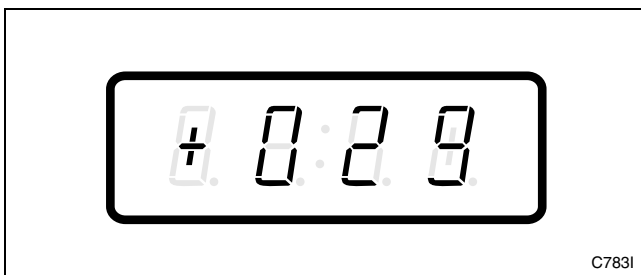
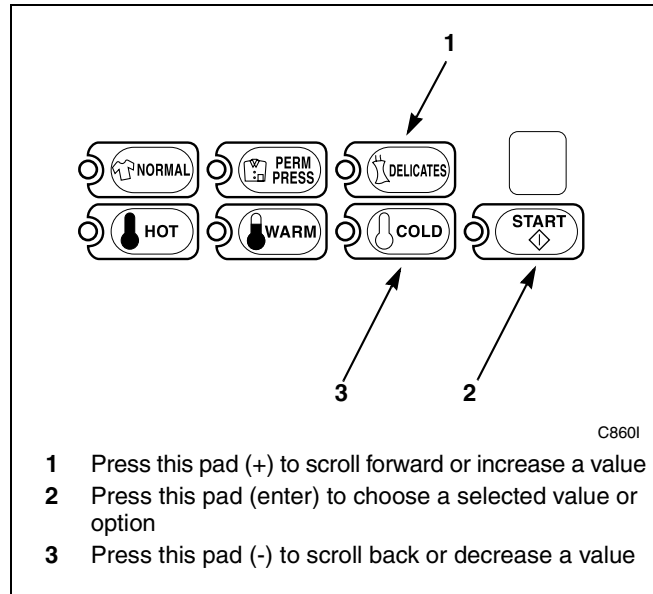

Figure 118

4. When “+029” appears in the VFD, press the START (enter) keypad. The current day of the month will appear in the VFD.

5. Press the DELICATES (+) or the COLD (-) keypad to increase or decrease the day of the month until correct. Refer to *Figure 119*.



- 1 Press this pad (+) to scroll forward or increase a value
- 2 Press this pad (enter) to choose a selected value or option
- 3 Press this pad (-) to scroll back or decrease a value

Figure 119

6. Press the START (enter) keypad when the correct day of the month appears in the VFD. The next option, “+030”, will appear in the VFD.

**NOTE: To program “+030” (Set Real-Time Clock Month), refer to option 30. To program other options, refer to the appropriate section.**

### How to Exit Programming Feature

1. Be sure the control shows a programmable option, not a value.
2. While pressing and holding the NORMAL keypad with one hand, press the PERM PRESS keypad with the other hand. The control will revert back to the ready mode. Refer to *Figure 2*.

### 30. Set Real-Time Clock Month “+030”

This option allows the owner to set NetMaster’s internal clock to the correct month.

#### How to Program the Clock Month

1. Control must be in Manual Mode. Refer to *Entering the Manual Mode*.
2. Press the DELICATES (+) or the COLD (-) keypad until “PrOg” appears in the VFD. Press the START (enter) keypad and “+001” will appear in the VFD.

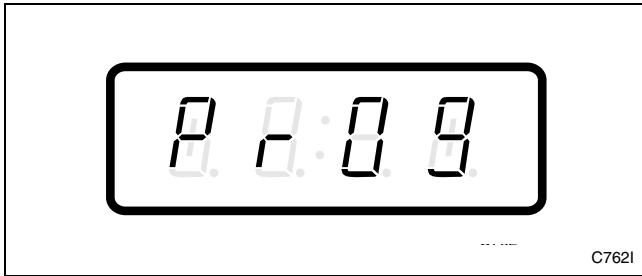

Figure 120

3. Press the DELICATES (+) or the COLD (-) keypad to scroll through the programmable options until “+030” appears in the VFD. Refer to *Figure 121*.

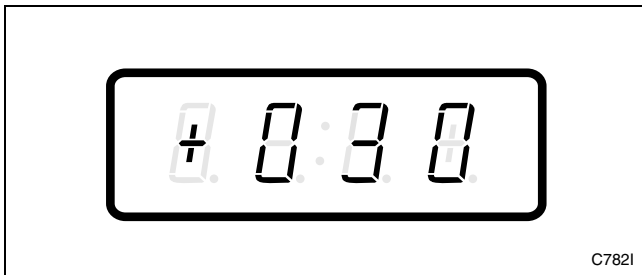
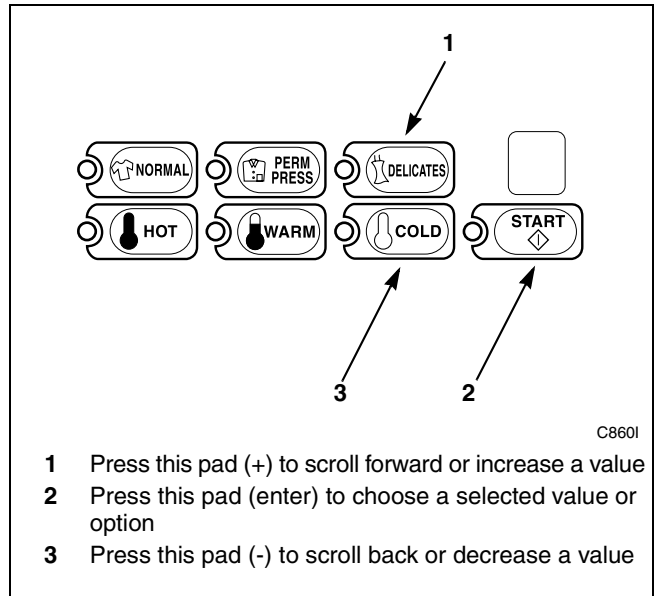

Figure 121

4. When “+030” appears in the VFD, press the START (enter) keypad. The current month will appear in the VFD.

5. Press the DELICATES (+) or the COLD (-) keypad to increase or decrease the month until correct. Refer to *Figure 122*.



- 1 Press this pad (+) to scroll forward or increase a value
- 2 Press this pad (enter) to choose a selected value or option
- 3 Press this pad (-) to scroll back or decrease a value

Figure 122

6. Press the START (enter) keypad when the correct month appears in the VFD. The next option, “+031”, will appear in the VFD.

**NOTE: To program “+031” (Set Real-Time Clock Year), refer to *option 31*. To program other options, refer to the appropriate section.**

#### How to Exit Programming Feature

1. Be sure the control shows a programmable option, not a value.
2. While pressing and holding the NORMAL keypad with one hand, press the PERM PRESS keypad with the other hand. The control will revert back to the ready mode. Refer to *Figure 2*.

### 31. Set Real-Time Clock Year “+031”

This option allows the owner to set NetMaster’s internal clock to the correct year.

#### How to Program the Clock Year

1. Control must be in Manual Mode. Refer to *Entering the Manual Mode*.
2. Press the DELICATES (+) or the COLD (-) keypad until “PrOg” appears in the VFD. Press the START (enter) keypad and “+001” will appear in the VFD.

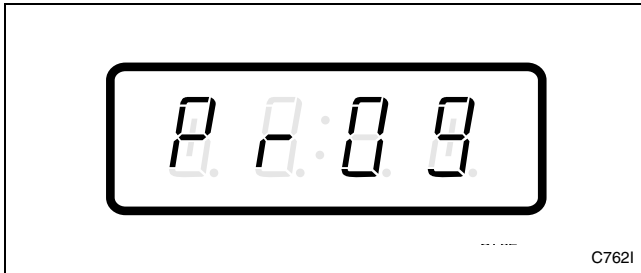

Figure 123

3. Press the DELICATES (+) or the COLD (-) keypad to scroll through the programmable options until “+031” appears in the VFD. Refer to *Figure 124*.

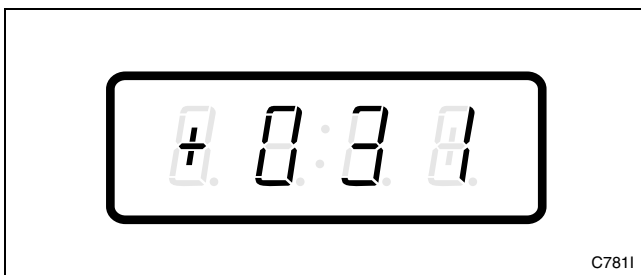

Figure 124

4. When “+031” appears in the VFD, press the START (enter) keypad. The current year will appear in the VFD.

5. Press the DELICATES (+) or the COLD (-) keypad to increase or decrease the year until correct. Refer to *Figure 125*.

**NOTE: The year 2000 is “00”, the year 2001 is “01” and so on.**

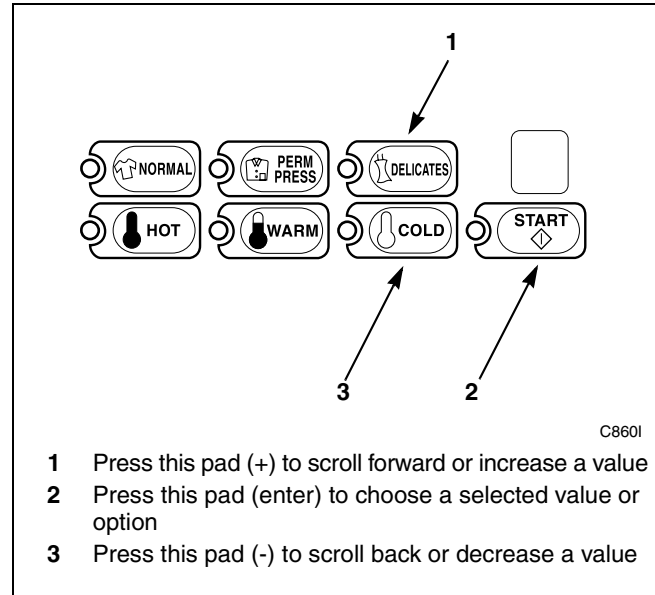

Figure 125

6. Press the START (enter) keypad when the correct year appears in the VFD. The next option, “+032”, will appear in the VFD.

**NOTE: To program “+032” (Set Real-Time Clock Century), refer to *option 32*. To program other options, refer to the appropriate section.**

#### How to Exit Programming Feature

1. Be sure the control shows a programmable option, not a value.
2. While pressing and holding the NORMAL keypad with one hand, press the PERM PRESS keypad with the other hand. The control will revert back to the ready mode. Refer to *Figure 2*.

### 32. Set Real-Time Clock Century “+032”

This option allows the owner to set NetMaster’s internal clock to the correct century.

#### How to Program the Clock Century

1. Control must be in Manual Mode. Refer to *Entering the Manual Mode*.
2. Press the DELICATES (+) or the COLD (-) keypad until “PrOg” appears in the VFD. Press the START (enter) keypad and “+001” will appear in the VFD.

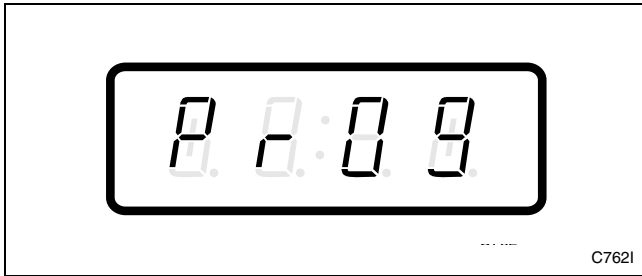

Figure 126

3. Press the DELICATES (+) or the COLD (-) keypad to scroll through the programmable options until “+032” appears in the VFD. Refer to *Figure 127*.

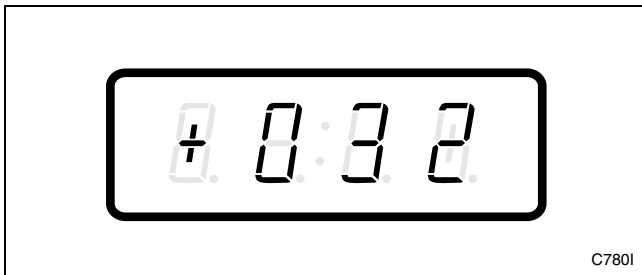
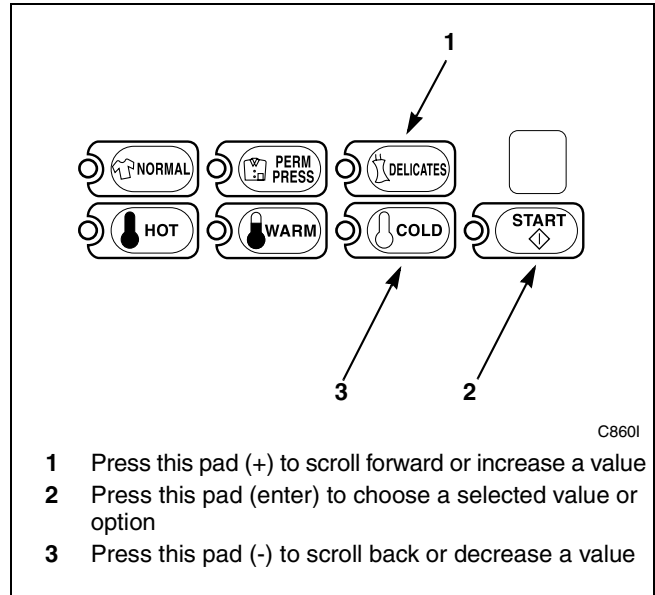

Figure 127

4. When “+032” appears in the VFD, press the START (enter) keypad. The current century will appear in the VFD.

5. Press the DELICATES (+) or the COLD (-) keypad to increase or decrease the century until correct. Refer to *Figure 128*.

**NOTE: The digits “20” are used for century.**



- 1 Press this pad (+) to scroll forward or increase a value
- 2 Press this pad (enter) to choose a selected value or option
- 3 Press this pad (-) to scroll back or decrease a value

Figure 128

6. Press the START (enter) keypad when the correct century appears in the VFD. The next option, “+033”, will appear in the VFD.

**NOTE: To program “+033” (Normal Wash Agitate Time), refer to *option 33*. To program other options, refer to the appropriate section.**

#### How to Exit Programming Feature

1. Be sure the control shows a programmable option, not a value.
2. While pressing and holding the NORMAL keypad with one hand, press the PERM PRESS keypad with the other hand. The control will revert back to the ready mode. Refer to *Figure 2*.

### 33. Normal Wash Agitate Time “+033”

This option allows the owner to set the amount of wash agitate time for the Normal cycle.

#### How to Program Normal Wash Agitate Time

1. Control must be in Manual Mode. Refer to *Entering the Manual Mode*.
2. Press the DELICATES (+) or the COLD (-) keypad until “PrOg” appears in the VFD. Press the START (enter) keypad and “+001” will appear in the VFD.

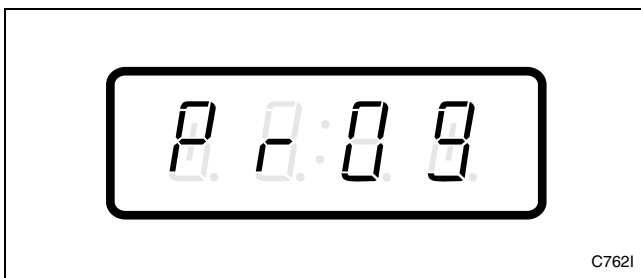

Figure 129

3. Press the DELICATES (+) or the COLD (-) keypad to scroll through the programmable options until “+033” appears in the VFD. Refer to *Figure 130*.

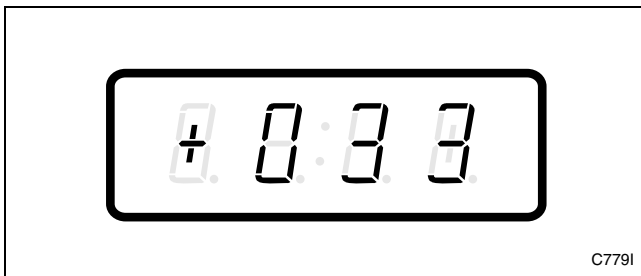

Figure 130

4. When “+033” appears in the VFD, press the START (enter) keypad. The current number of minutes set for the Normal Wash Agitate Time will appear in the VFD.

5. Press the DELICATES (+) or the COLD (-) keypad to increase or decrease the current number of minutes displayed in the VFD to the desired number of minutes. Refer to *Figure 131*.

**NOTE: The Normal Wash Agitate Time can be set from zero (0) to 15 minutes.**

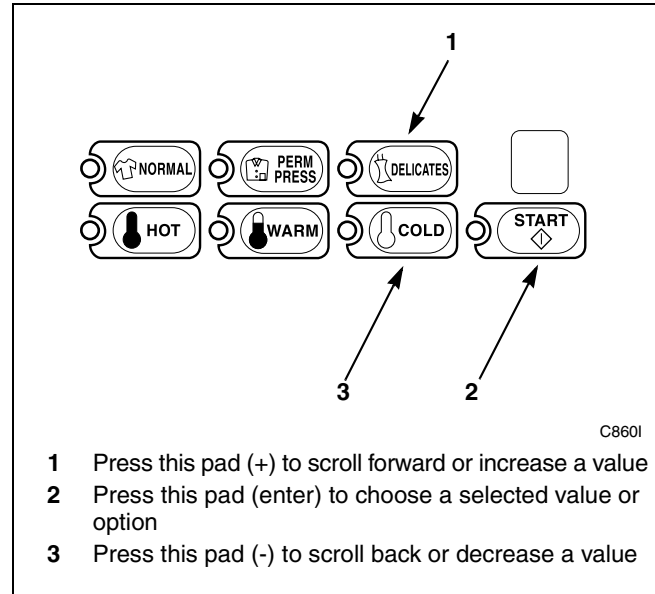

Figure 131

6. Press the START (enter) keypad when the correct number of minutes appears in the VFD. The next option, “+034”, will appear in the VFD.

**NOTE: To program “+034” (Normal Extra Rinse Agitate Time), refer to *option 34*. To program other options, refer to the appropriate section.**

#### How to Exit Programming Feature

1. Be sure the control shows a programmable option, not a value.
2. While pressing and holding the NORMAL keypad with one hand, press the PERM PRESS keypad with the other hand. The control will revert back to the ready mode. Refer to *Figure 2*.

### 34. Normal Extra Rinse Agitate Time “+034”

This option allows the owner to set the amount of extra rinse agitate time for the Normal cycle.

#### How to Program Normal Extra Rinse Agitate Time

1. Control must be in Manual Mode. Refer to *Entering the Manual Mode*.
2. Press the DELICATES (+) or the COLD (-) keypad until “PrOg” appears in the VFD. Press the START (enter) keypad and “+001” will appear in the VFD.

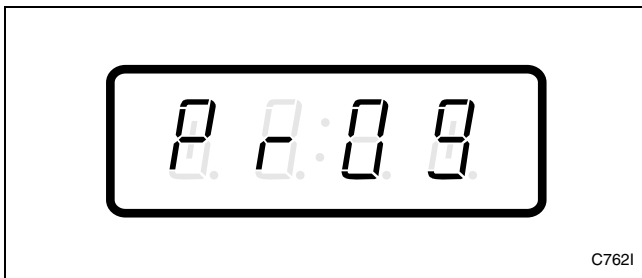

Figure 132

3. Press the DELICATES (+) or the COLD (-) keypad to scroll through the programmable options until “+034” appears in the VFD. Refer to *Figure 133*.



Figure 133

4. When “+034” appears in the VFD, press the START (enter) keypad. The current number of minutes set for the Normal Extra Rinse Agitate Time will appear in the VFD.

5. Press the DELICATES (+) or the COLD (-) keypad to increase or decrease the current number of minutes displayed in the VFD to the desired number of minutes. Refer to *Figure 134*.

**NOTE: The Normal Extra Rinse Agitate Time can be set from zero (0) to 15 minutes.**

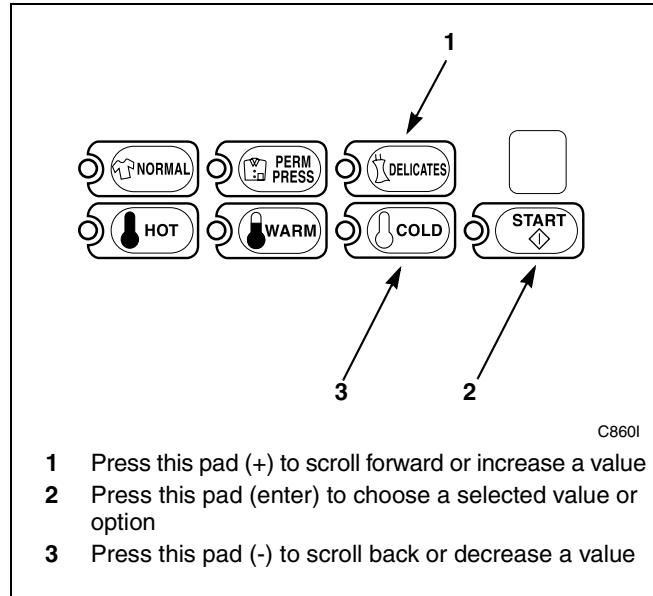

Figure 134

6. Press the START (enter) keypad when the correct number of minutes appears in the VFD. The next option, “+035”, will appear in the VFD.

**NOTE: To program “+035” (Normal Rinse Agitate Time), refer to *option 35*. To program other options, refer to the appropriate section.**

#### How to Exit Programming Feature

1. Be sure the control shows a programmable option, not a value.
2. While pressing and holding the NORMAL keypad with one hand, press the PERM PRESS keypad with the other hand. The control will revert back to the ready mode. Refer to *Figure 2*.



### 35. Normal Rinse Agitate Time “+035”

This option allows the owner to set the amount of time for a rinse agitate in the Normal cycle.

#### How to Program Normal Rinse Agitate Time

1. Control must be in Manual Mode. Refer to *Entering the Manual Mode*.
2. Press the DELICATES (+) or the COLD (-) keypad until “PrOg” appears in the VFD. Press the START (enter) keypad and “+001” will appear in the VFD.

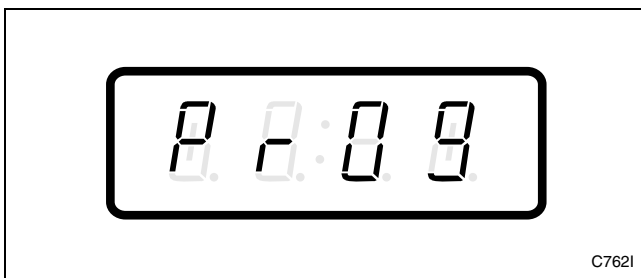

Figure 135

3. Press the DELICATES (+) or the COLD (-) keypad to scroll through the programmable options until “+035” appears in the VFD. Refer to *Figure 136*.

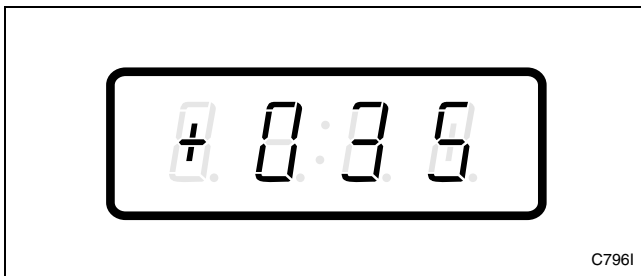

Figure 136

4. When “+035” appears in the VFD, press the START (enter) keypad. The current number of minutes set for the Normal Rinse Agitate Time will appear in the VFD.

5. Press the DELICATES (+) or the COLD (-) keypad to increase or decrease the current number of minutes displayed in the VFD to the desired number of minutes. Refer to *Figure 137*.

**NOTE: The Normal Rinse Agitate Time can be set from zero (0) to 15 minutes.**

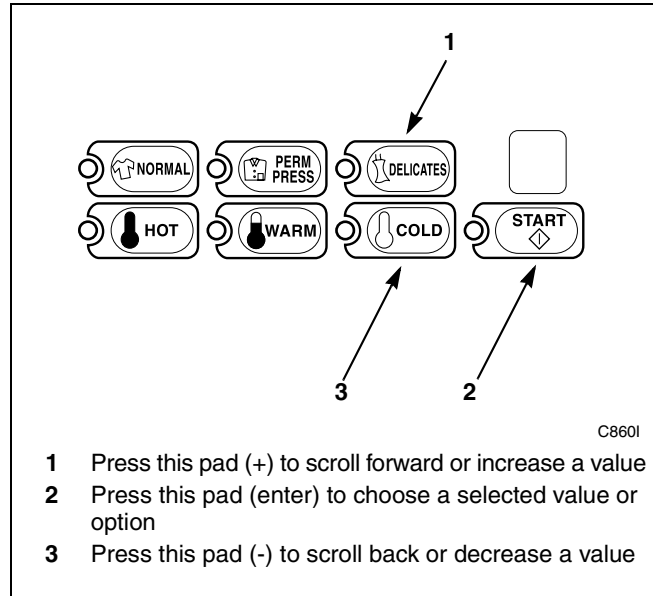

Figure 137

6. Press the START (enter) keypad when the correct number of minutes appears in the VFD. The next option, “+036”, will appear in the VFD.

**NOTE: To program “+036” (Normal Final Spin Time), refer to *option 36*. To program other options, refer to the appropriate section.**

#### How to Exit Programming Feature

1. Be sure the control shows a programmable option, not a value.
2. While pressing and holding the NORMAL keypad with one hand, press the PERM PRESS keypad with the other hand. The control will revert back to the ready mode. Refer to *Figure 2*.

### 36. Normal Final Spin Time “+036”

This option allows the owner to set the amount of time for a final spin in the Normal cycle.

#### How to Program Normal Final Spin Time

1. Control must be in Manual Mode. Refer to *Entering the Manual Mode*.
2. Press the DELICATES (+) or the COLD (-) keypad until “PrOg” appears in the VFD. Press the START (enter) keypad and “+001” will appear in the VFD.

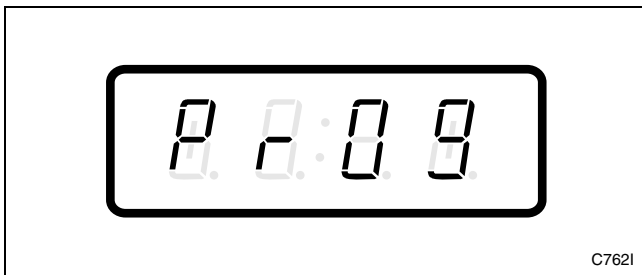

Figure 138

3. Press the DELICATES (+) or the COLD (-) keypad to scroll through the programmable options until “+036” appears in the VFD. Refer to *Figure 139*.

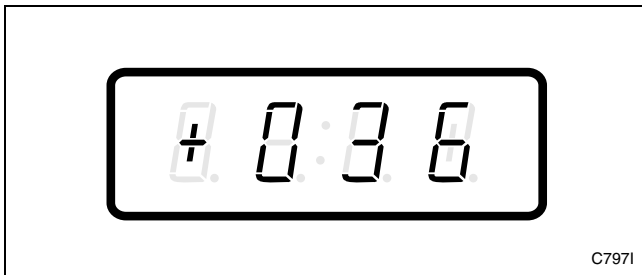
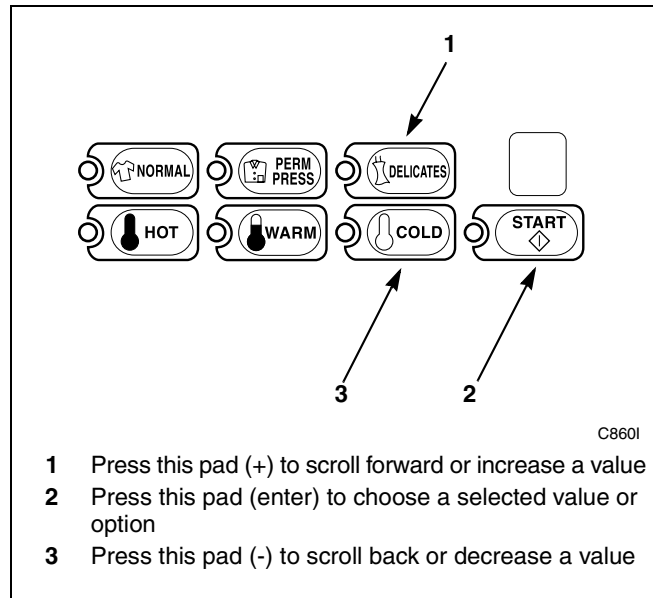

Figure 139

4. When “+036” appears in the VFD, press the START (enter) keypad. The current number of minutes set for the Normal Final Spin Time will appear in the VFD.

5. Press the DELICATES (+) or the COLD (-) keypad to increase or decrease the current number of minutes displayed in the VFD to the desired number of minutes. Refer to *Figure 140*.

**NOTE: The Normal Final Spin Time can be set from zero (0) to 15 minutes.**



- 1 Press this pad (+) to scroll forward or increase a value
- 2 Press this pad (enter) to choose a selected value or option
- 3 Press this pad (-) to scroll back or decrease a value

Figure 140

6. Press the START (enter) keypad when the correct number of minutes appears in the VFD. The next option, “+037”, will appear in the VFD.

**NOTE: To program “+037” (Permanent Press Wash Agitate Time), refer to *option 37*. To program other options, refer to the appropriate section.**

#### How to Exit Programming Feature

1. Be sure the control shows a programmable option, not a value.
2. While pressing and holding the NORMAL keypad with one hand, press the PERM PRESS keypad with the other hand. The control will revert back to the ready mode. Refer to *Figure 2*.

### 37. Permanent Press Wash Agitate Time “+037”

This option allows the owner to set the amount of wash agitate time for the Permanent Press cycle.

#### How to Program Permanent Press Wash Agitate Time

1. Control must be in Manual Mode. Refer to *Entering the Manual Mode*.
2. Press the DELICATES (+) or the COLD (-) keypad until “PrOg” appears in the VFD. Press the START (enter) keypad and “+001” will appear in the VFD.

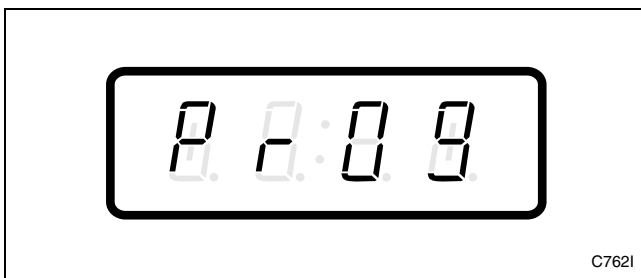

Figure 141

3. Press the DELICATES (+) or the COLD (-) keypad to scroll through the programmable options until “+037” appears in the VFD. Refer to *Figure 142*.

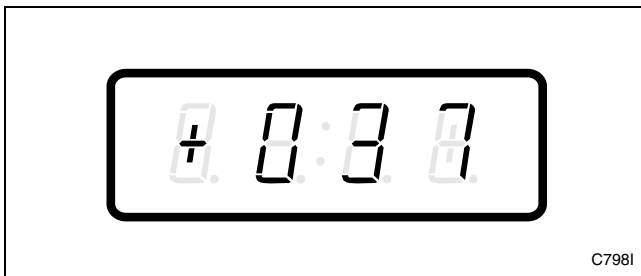

Figure 142

4. When “+037” appears in the VFD, press the START (enter) keypad. The current number of minutes set for the Permanent Press Wash Agitate Time will appear in the VFD.

5. Press the DELICATES (+) or the COLD (-) keypad to increase or decrease the current number of minutes displayed in the VFD to the desired number of minutes. Refer to *Figure 143*.

**NOTE: The Permanent Press Wash Agitate Time can be set from zero (0) to 15 minutes.**

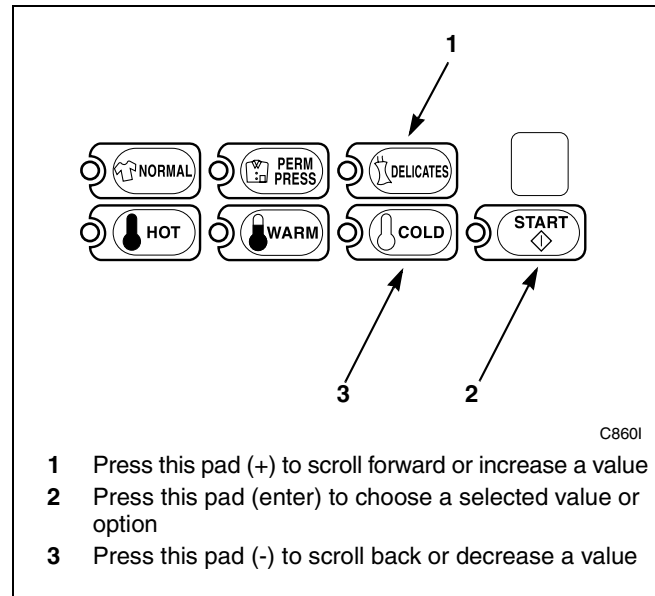

Figure 143

- 1 Press this pad (+) to scroll forward or increase a value
- 2 Press this pad (enter) to choose a selected value or option
- 3 Press this pad (-) to scroll back or decrease a value

6. Press the START (enter) keypad when the correct number of minutes appears in the VFD. The next option, “+038”, will appear in the VFD.

**NOTE: To program “+038” (Permanent Press Extra Rinse Agitate Time), refer to *option 38*. To program other options, refer to the appropriate section.**

#### How to Exit Programming Feature

1. Be sure the control shows a programmable option, not a value.
2. While pressing and holding the NORMAL keypad with one hand, press the PERM PRESS keypad with the other hand. The control will revert back to the ready mode. Refer to *Figure 2*.

### 38. Permanent Press Extra Rinse Agitate Time “+038”

This option allows the owner to set the amount of extra rinse agitate time for the Permanent Press cycle.

#### How to Program Permanent Press Extra Rinse Agitate Time

1. Control must be in Manual Mode. Refer to *Entering the Manual Mode*.
2. Press the DELICATES (+) or the COLD (-) keypad until “PrOg” appears in the VFD. Press the START (enter) keypad and “+001” will appear in the VFD.

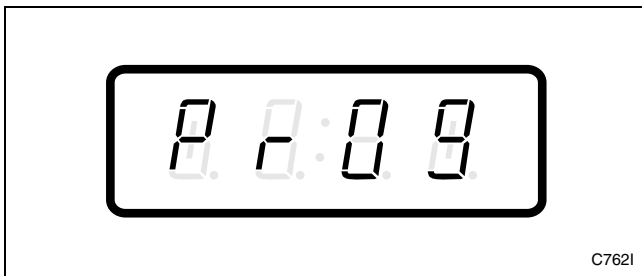

Figure 144

3. Press the DELICATES (+) or the COLD (-) keypad to scroll through the programmable options until “+038” appears in the VFD. Refer to *Figure 145*.

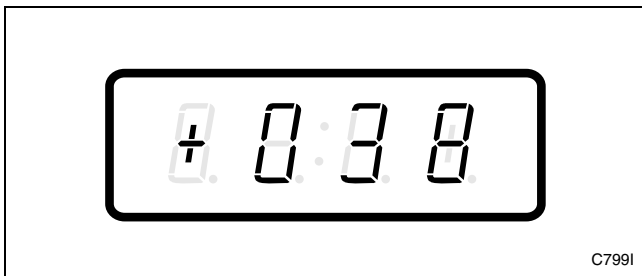

Figure 145

4. When “+038” appears in the VFD, press the START (enter) keypad. The current number of minutes set for the Permanent Press Extra Rinse Agitate Time will appear in the VFD.

5. Press the DELICATES (+) or the COLD (-) keypad to increase or decrease the current number of minutes displayed in the VFD to the desired number of minutes. Refer to *Figure 146*.

**NOTE: The Permanent Press Extra Rinse Agitate Time can be set from zero (0) to 15 minutes.**

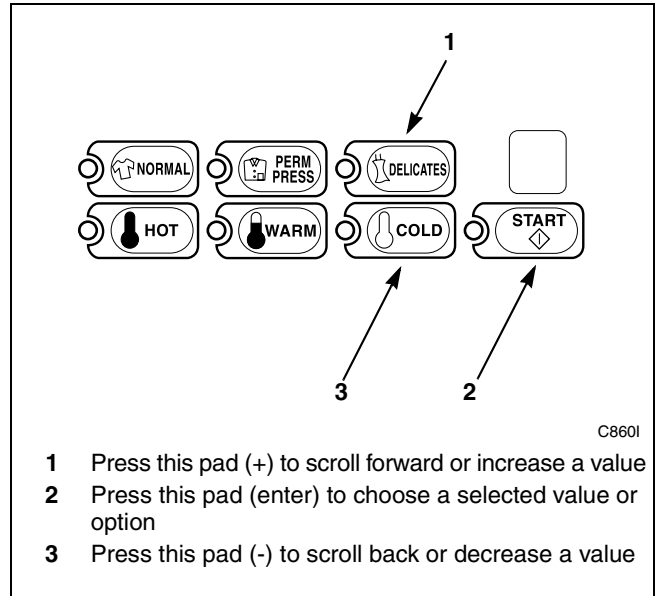

Figure 146

6. Press the START (enter) keypad when the correct number of minutes appears in the VFD. The next option, “+039”, will appear in the VFD.

**NOTE: To program “+039” (Permanent Press Rinse Agitate Time), refer to *option 39*. To program other options, refer to the appropriate section.**

#### How to Exit Programming Feature

1. Be sure the control shows a programmable option, not a value.
2. While pressing and holding the NORMAL keypad with one hand, press the PERM PRESS keypad with the other hand. The control will revert back to the ready mode. Refer to *Figure 2*.

### 39. Permanent Press Rinse Agitate Time “+039”

This option allows the owner to set the amount of rinse agitate time for the Permanent Press cycle.

#### How to Program Permanent Press Rinse Agitate Time

1. Control must be in Manual Mode. Refer to *Entering the Manual Mode*.
2. Press the DELICATES (+) or the COLD (-) keypad until “PrOg” appears in the VFD. Press the START (enter) keypad and “+001” will appear in the VFD.

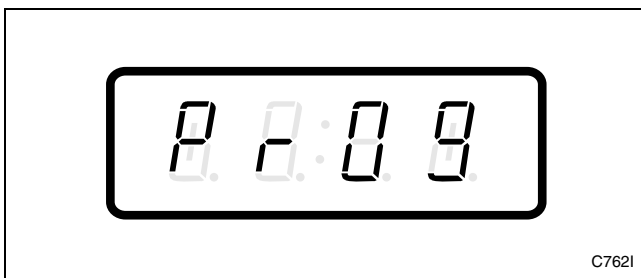

Figure 147

3. Press the DELICATES (+) or the COLD (-) keypad to scroll through the programmable options until “+039” appears in the VFD. Refer to *Figure 148*.

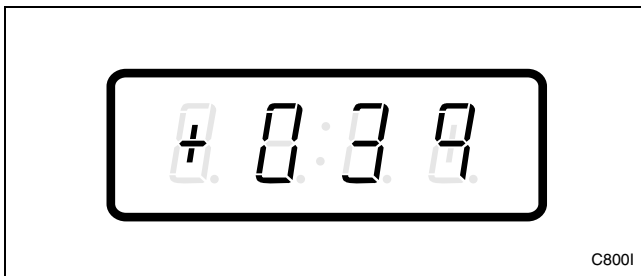
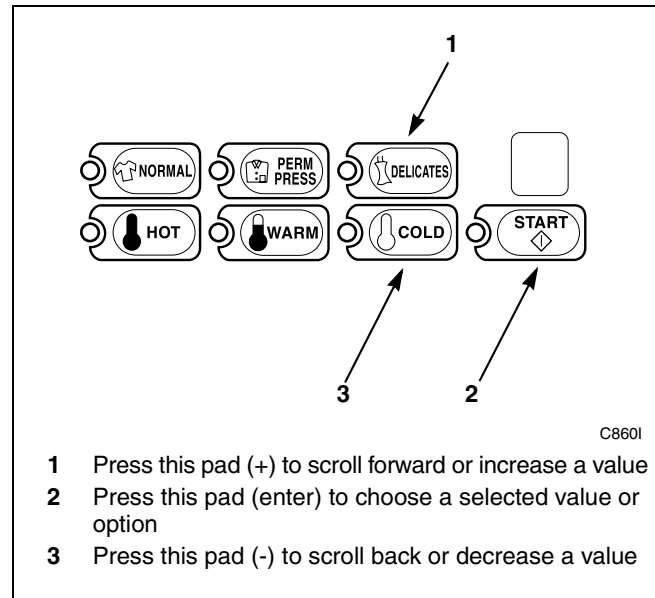

Figure 148

4. When “+039” appears in the VFD, press the START (enter) keypad. The current number of minutes set for the Permanent Press Rinse Agitate Time will appear in the VFD.

5. Press the DELICATES (+) or the COLD (-) keypad to increase or decrease the current number of minutes displayed in the VFD to the desired number of minutes. Refer to *Figure 149*.

**NOTE: The Permanent Press Rinse Agitate Time can be set from zero (0) to 15 minutes.**



- 1 Press this pad (+) to scroll forward or increase a value
- 2 Press this pad (enter) to choose a selected value or option
- 3 Press this pad (-) to scroll back or decrease a value

Figure 149

6. Press the START (enter) keypad when the correct number of minutes appears in the VFD. The next option, “+040”, will appear in the VFD.

**NOTE: To program “+040” (Permanent Press Final Spin Time), refer to *option 40*. To program other options, refer to the appropriate section.**

#### How to Exit Programming Feature

1. Be sure the control shows a programmable option, not a value.
2. While pressing and holding the NORMAL keypad with one hand, press the PERM PRESS keypad with the other hand. The control will revert back to the ready mode. Refer to *Figure 2*.

## 40. Permanent Press Final Spin Time “+040”

This option allows the owner to set the amount of final spin time for the Permanent Press cycle.

### How to Program Permanent Press Final Spin Time

1. Control must be in Manual Mode. Refer to *Entering the Manual Mode*.
2. Press the DELICATES (+) or the COLD (-) keypad until “PrOg” appears in the VFD. Press the START (enter) keypad and “+001” will appear in the VFD.

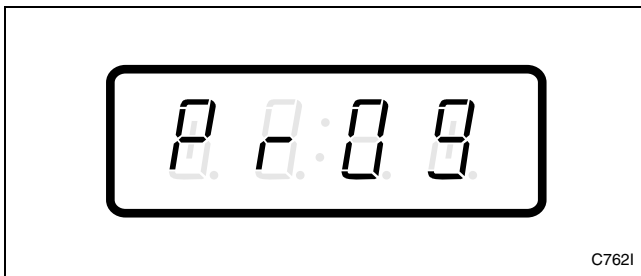

Figure 150

3. Press the DELICATES (+) or the COLD (-) keypad to scroll through the programmable options until “+040” appears in the VFD. Refer to *Figure 151*.

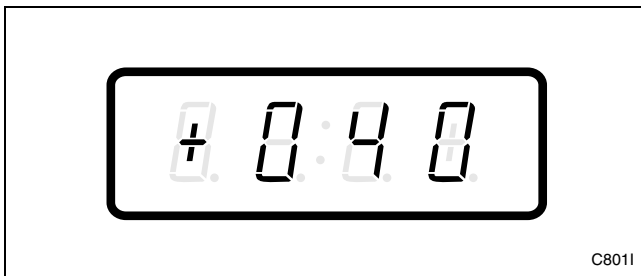

Figure 151

4. When “+040” appears in the VFD, press the START (enter) keypad. The current number of minutes set for the Permanent Press Final Spin Time will appear in the VFD.

5. Press the DELICATES (+) or the COLD (-) keypad to increase or decrease the current number of minutes displayed in the VFD to the desired number of minutes. Refer to *Figure 152*.

**NOTE: The Permanent Press Final Spin Time can be set from zero (0) to 15 minutes.**

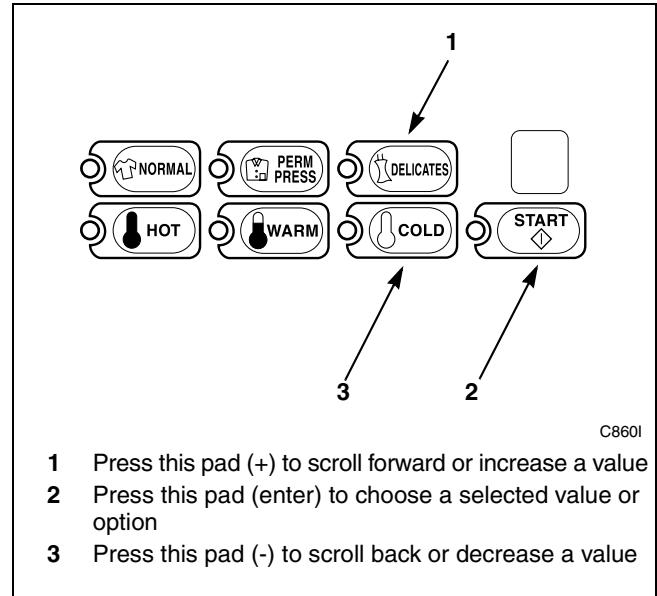

Figure 152

- 1 Press this pad (+) to scroll forward or increase a value
- 2 Press this pad (enter) to choose a selected value or option
- 3 Press this pad (-) to scroll back or decrease a value

6. Press the START (enter) keypad when the correct number of minutes appears in the VFD. The next option, “+041”, will appear in the VFD.

**NOTE: To program “+041” (Delicate Wash Agitate Time), refer to *option 41*. To program other options, refer to the appropriate section.**

### How to Exit Programming Feature

1. Be sure the control shows a programmable option, not a value.
2. While pressing and holding the NORMAL keypad with one hand, press the PERM PRESS keypad with the other hand. The control will revert back to the ready mode. Refer to *Figure 2*.

## 41. Delicate Wash Agitate Time “+041”

This option allows the owner to set the amount of wash agitate time for the Delicate cycle.

### How to Program Delicate Wash Agitate Time

1. Control must be in Manual Mode. Refer to *Entering the Manual Mode*.
2. Press the DELICATES (+) or the COLD (-) keypad until “PrOg” appears in the VFD. Press the START (enter) keypad and “+001” will appear in the VFD.

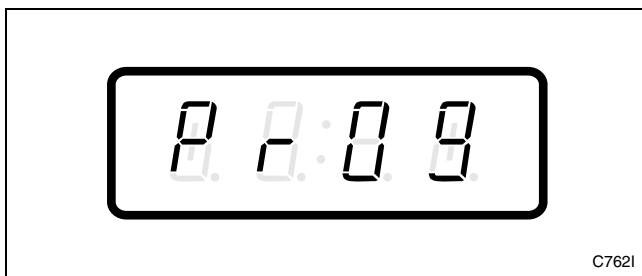

Figure 153

3. Press the DELICATES (+) or the COLD (-) keypad to scroll through the programmable options until “+041” appears in the VFD. Refer to *Figure 154*.

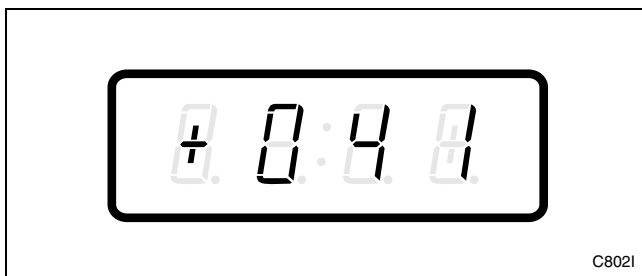

Figure 154

4. When “+041” appears in the VFD, press the START (enter) keypad. The current number of minutes set for the Delicate Wash Agitate Time will appear in the VFD.

5. Press the DELICATES (+) or the COLD (-) keypad to increase or decrease the current number of minutes displayed in the VFD to the desired number of minutes. Refer to *Figure 155*.

**NOTE: The Delicate Wash Agitate Time can be set from zero (0) to 15 minutes.**

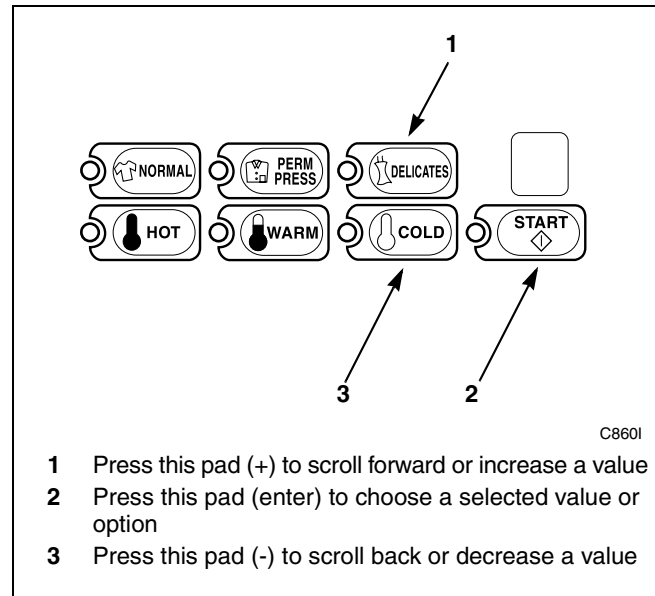

Figure 155

6. Press the START (enter) keypad when the correct number of minutes appears in the VFD. The next option, “+042”, will appear in the VFD.

**NOTE: To program “+042” (Delicate Extra Rinse Agitate Time), refer to *option 42*. To program other options, refer to the appropriate section.**

### How to Exit Programming Feature

1. Be sure the control shows a programmable option, not a value.
2. While pressing and holding the NORMAL keypad with one hand, press the PERM PRESS keypad with the other hand. The control will revert back to the ready mode. Refer to *Figure 2*.

## 42. Delicate Extra Rinse Agitate Time “+042”

This option allows the owner to set the amount of extra rinse agitate time for the Delicate cycle.

### How to Program Delicate Extra Rinse Agitate Time

1. Control must be in Manual Mode. Refer to *Entering the Manual Mode*.
2. Press the DELICATES (+) or the COLD (-) keypad until “PrOg” appears in the VFD. Press the START (enter) keypad and “+001” will appear in the VFD.

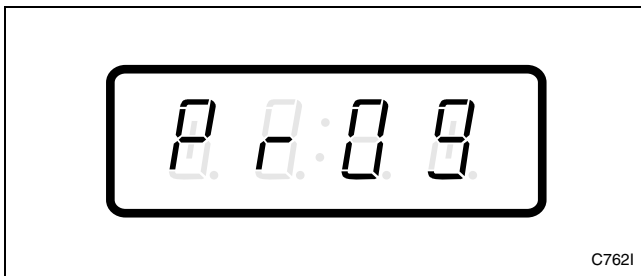

Figure 156

3. Press the DELICATES (+) or the COLD (-) keypad to scroll through the programmable options until “+042” appears in the VFD. Refer to *Figure 157*.

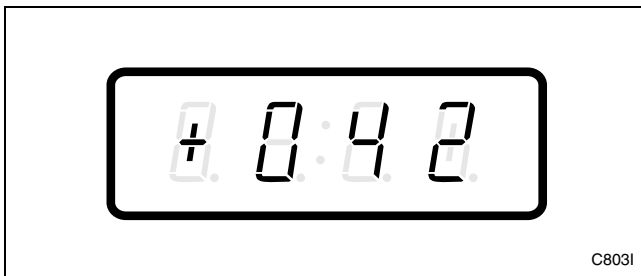

Figure 157

4. When “+042” appears in the VFD, press the START (enter) keypad. The current number of minutes set for the Delicate Extra Rinse Agitate Time will appear in the VFD.

5. Press the DELICATES (+) or the COLD (-) keypad to increase or decrease the current number of minutes displayed in the VFD to the desired number of minutes. Refer to *Figure 158*.

**NOTE: The Delicate Extra Rinse Agitate Time can be set from zero (0) to 15 minutes.**

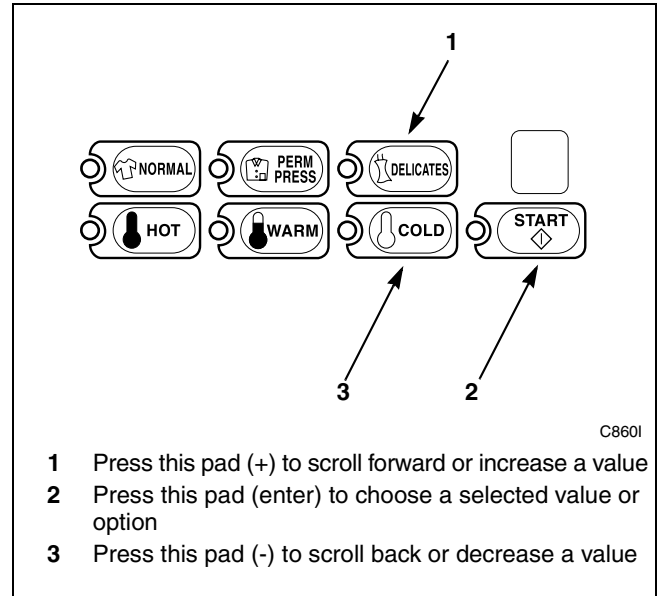

Figure 158

- 1 Press this pad (+) to scroll forward or increase a value
- 2 Press this pad (enter) to choose a selected value or option
- 3 Press this pad (-) to scroll back or decrease a value

6. Press the START (enter) keypad when the correct number of minutes appears in the VFD. The next option, “+043”, will appear in the VFD.

**NOTE: To program “+043” (Delicate Rinse Agitate Time), refer to *option 43*. To program other options, refer to the appropriate section.**

### How to Exit Programming Feature

1. Be sure the control shows a programmable option, not a value.
2. While pressing and holding the NORMAL keypad with one hand, press the PERM PRESS keypad with the other hand. The control will revert back to the ready mode. Refer to *Figure 2*.



### 43. Delicate Rinse Agitate Time “+043”

This option allows the owner to set the amount of rinse agitate time for the Delicate cycle.

#### How to Program Delicate Rinse Agitate Time

1. Control must be in Manual Mode. Refer to *Entering the Manual Mode*.
2. Press the DELICATES (+) or the COLD (-) keypad until “PrOg” appears in the VFD. Press the START (enter) keypad and “+001” will appear in the VFD.

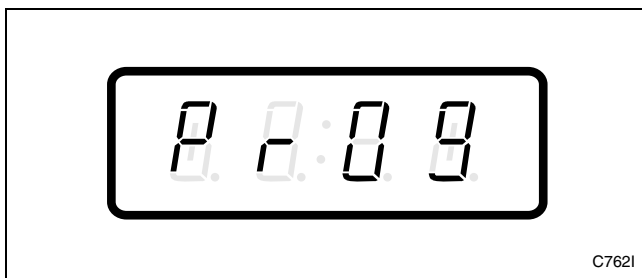

Figure 159

3. Press the DELICATES (+) or the COLD (-) keypad to scroll through the programmable options until “+043” appears in the VFD. Refer to *Figure 160*.

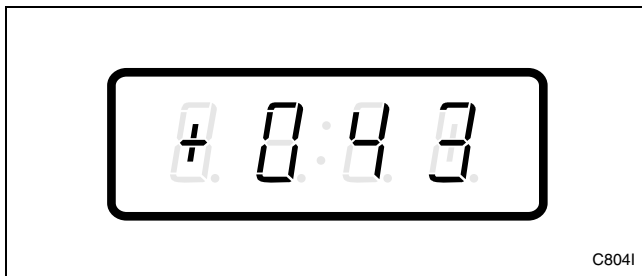
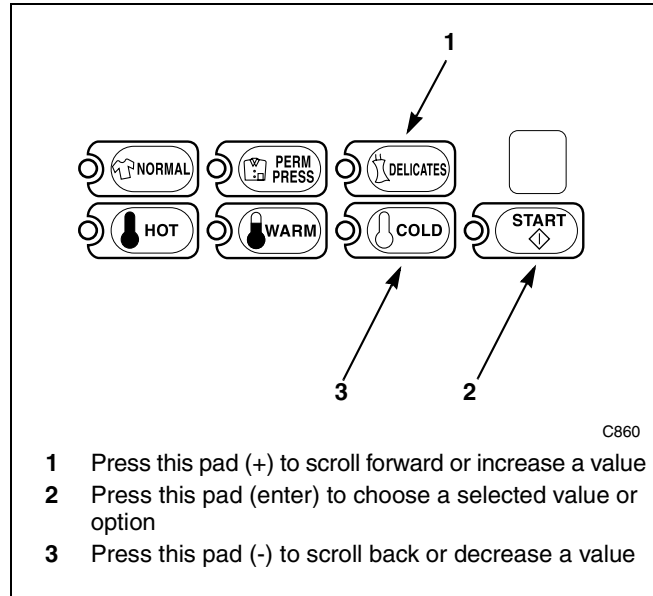

Figure 160

4. When “+043” appears in the VFD, press the START (enter) keypad. The current number of minutes set for the Delicate Rinse Agitate time will appear in the VFD.

5. Press the DELICATES (+) or the COLD (-) keypad to increase or decrease the current number of minutes displayed in the VFD to the desired number of minutes. Refer to *Figure 161*.

**NOTE: The Delicate Rinse Agitate Time can be set from zero (0) to 15 minutes.**



- 1 Press this pad (+) to scroll forward or increase a value
- 2 Press this pad (enter) to choose a selected value or option
- 3 Press this pad (-) to scroll back or decrease a value

Figure 161

6. Press the START (enter) keypad when the correct number of minutes appears in the VFD. The next option, “+044”, will appear in the VFD.

**NOTE: To program “+044” (Delicate Final Spin Time), refer to *option 44*. To program other options, refer to the appropriate section.**

#### How to Exit Programming Feature

1. Be sure the control shows a programmable option, not a value.
2. While pressing and holding the NORMAL keypad with one hand, press the PERM PRESS keypad with the other hand. The control will revert back to the ready mode. Refer to *Figure 2*.

## 44. Delicate Final Spin Time “+044”

This option allows the owner to set the amount of final spin time for the Delicate cycle.

### How to Program Delicate Final Spin Time

1. Control must be in Manual Mode. Refer to *Entering the Manual Mode*.
2. Press the DELICATES (+) or the COLD (-) keypad until “PrOg” appears in the VFD. Press the START (enter) keypad and “+001” will appear in the VFD.

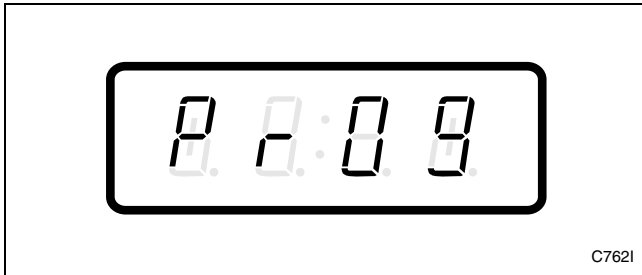

Figure 162

3. Press the DELICATES (+) or the COLD (-) keypad to scroll through the programmable options until “+044” appears in the VFD. Refer to *Figure 163*.

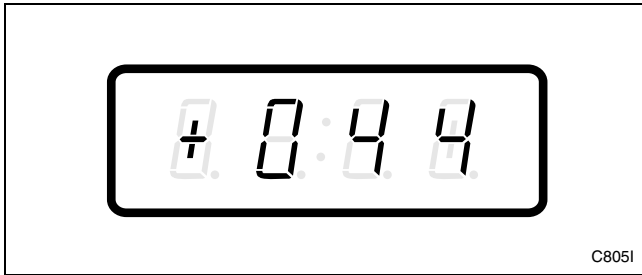
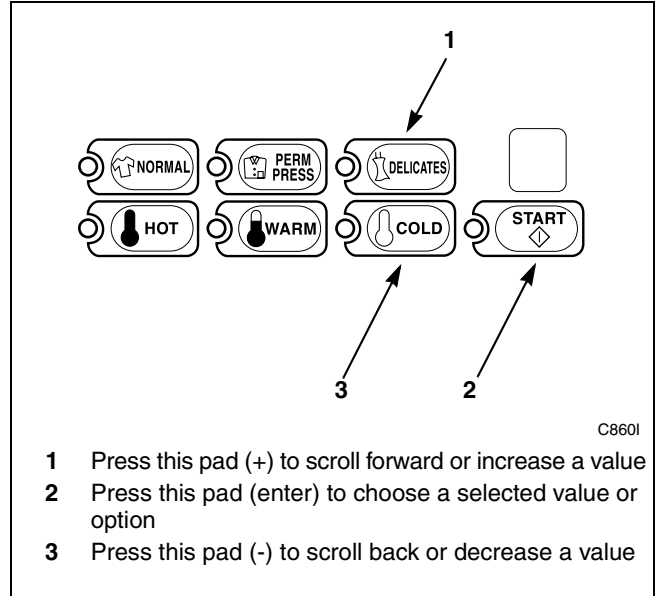

Figure 163

4. When “+044” appears in the VFD, press the START (enter) keypad. The current number of minutes set for the Delicate Final Spin Time will appear in the VFD.

5. Press the DELICATES (+) or the COLD (-) keypad to increase or decrease the current number of minutes displayed in the VFD to the desired number of minutes. Refer to *Figure 164*.

**NOTE: The Delicate Final Spin Time can be set from zero (0) to 15 minutes.**



- 1 Press this pad (+) to scroll forward or increase a value
- 2 Press this pad (enter) to choose a selected value or option
- 3 Press this pad (-) to scroll back or decrease a value

Figure 164

6. Press the START (enter) keypad when the correct number of minutes appears in the VFD. The next option, “+045”, will appear in the VFD.

**NOTE: To program “+045” (Warm Rinse Enable/Disable), refer to *option 45*. To program other options, refer to the appropriate section.**

### How to Exit Programming Feature

1. Be sure the control shows a programmable option, not a value.
2. While pressing and holding the NORMAL keypad with one hand, press the PERM PRESS keypad with the other hand. The control will revert back to the ready mode. Refer to *Figure 2*.

## 45. Warm Rinse Enable/Disable “+045”

This option allows the owner to program an optional warm fill temperature for the final rinse fill. If this option is enabled and HOT or WARM water is selected for the wash fill, warm water will be used for the final rinse fill.

### How to Program the Warm Rinse Enable/Disable

- Control must be in Manual Mode. Refer to *Entering the Manual Mode*.
- Press the DELICATES (+) or the COLD (-) keypad until “PrOg” appears in the VFD. Press the START (enter) keypad and “+001” will appear in the VFD.

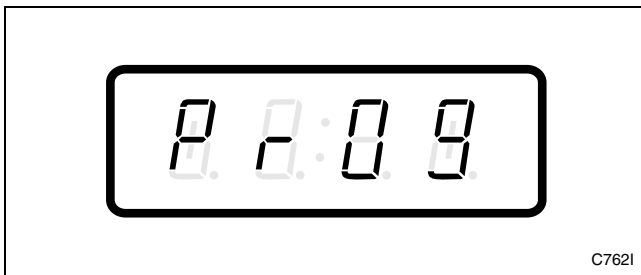

Figure 165

- Press the DELICATES (+) or the COLD (-) keypad to scroll through the programmable options until “+045” appears in the VFD. Refer to *Figure 166*.

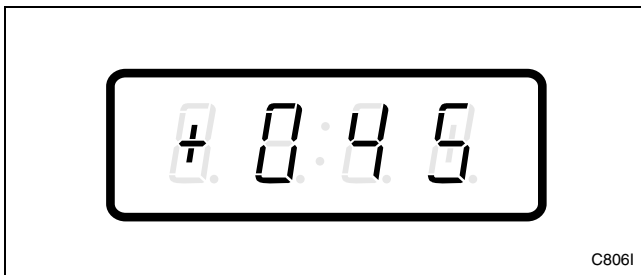
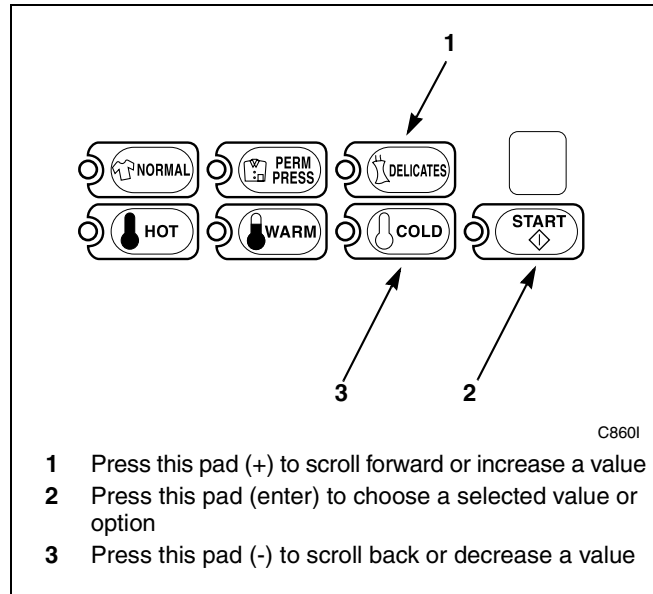

Figure 166

- When “+045” appears in the VFD, press the START (enter) keypad. A number will appear in the VFD. This number (found below) corresponds to the current Warm Rinse Enable/Disable Value.  
One (1) = Option Enabled  
Zero (0) = Option Disabled

- Press the DELICATES (+) or the COLD (-) keypad to increase or decrease the current number to the desired number. Refer to *Figure 167*.



- Press this pad (+) to scroll forward or increase a value
- Press this pad (enter) to choose a selected value or option
- Press this pad (-) to scroll back or decrease a value

Figure 167

- Press the START (enter) keypad when the correct number appears in the VFD. The next option, “+046”, will appear in the VFD.

**NOTE: To program “+046” (Control Configuration Data #1), refer to *option 46*. To program other options, refer to the appropriate section.**

### How to Exit Programming Feature

- Be sure the control shows a programmable option, not a value.
- While pressing and holding the NORMAL keypad with one hand, press the PERM PRESS keypad with the other hand. The control will revert back to the ready mode. Refer to *Figure 2*.

## 46. Control Configuration Data #1 “+046”

This option allows the owner to turn ON or turn OFF preprogrammed capabilities within NetMaster.

### How to Program the Control Configuration Data #1

1. Control must be in Manual Mode. Refer to *Entering the Manual Mode*.
2. Press the DELICATES (+) or the COLD (-) keypad until “PrOg” appears in the VFD. Press the START (enter) keypad and “+001” will appear in the VFD.

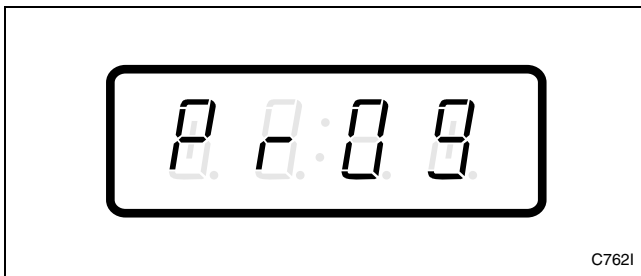

Figure 168

3. Press the DELICATES (+) or the COLD (-) keypad to scroll through the programmable options until “+046” appears in the VFD. Refer to *Figure 169*.

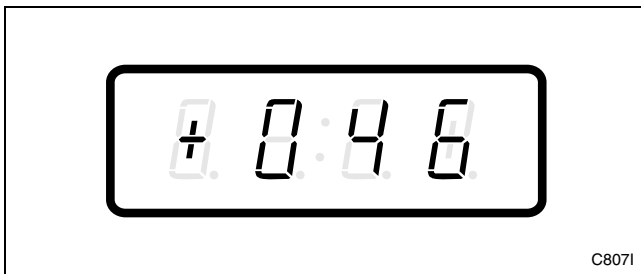
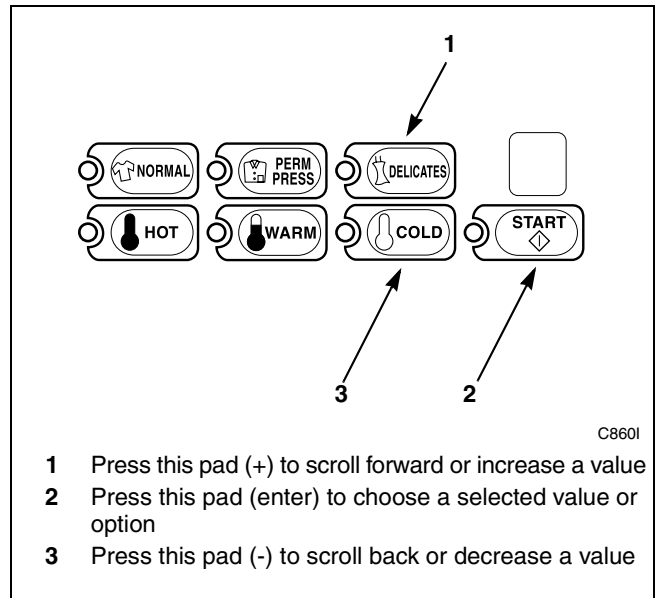

Figure 169

4. When “+046” appears in the VFD, press the START (enter) keypad. A number will appear in the VFD. This number corresponds to the current Control Configuration Data #1 Value.

5. Press the DELICATES (+) or the COLD (-) keypad to increase or decrease the current number to the desired number selected from *Table 5*. Refer to *Figure 170*.



- 1 Press this pad (+) to scroll forward or increase a value
- 2 Press this pad (enter) to choose a selected value or option
- 3 Press this pad (-) to scroll back or decrease a value

Figure 170

6. Press the START (enter) keypad when the correct number appears in the VFD. The next option, “+047”, will appear in the VFD.

**NOTE: To program “+047” (Control Configuration Data #3), refer to *option 47*. To program other options, refer to the appropriate section.**

### How to Exit Programming Feature

1. Be sure the control shows a programmable option, not a value.
2. While pressing and holding the NORMAL keypad with one hand, press the PERM PRESS keypad with the other hand. The control will revert back to the ready mode. Refer to *Figure 2*.

## Configuration #1 Programming

Use the table on the following page (*Table 5*) to turn on or turn off the preprogrammed daylight savings option, wash temperature display option, infra-red access option, decimal point option, EC Power Fail, and the automatic collect option in NetMaster.

To change any or all of these configuration options, review the following descriptions carefully and choose the appropriate configuration value from *Table 5*. Enter the appropriate value in step 5 on the previous page.

Daylight Savings	This option automatically sets the clock in NetMaster to account for the time change during Daylight Savings. OFF= Turns off the automatic daylight savings option programmed in NetMaster. ON = Turns on the automatic daylight savings option programmed in NetMaster.
Wash Temperature	This option determines if the temperature LEDs indicate the selected wash temperature during the entire cycle or indicates fill temperature during each rinse. OFF= Selected wash temperature remains on for entire cycle. ON = LEDs indicate actual water temperature during every fill step. LEDs will be off during steps when water is not filling in the wash drum.
Infra-red Access	This option determines if a Micro-Wand can access or program NetMaster. OFF= Turns off the infra-red access by the Micro-Wand. ON = Turns on the infra-red access by the Micro-Wand.
Decimal Point	This option determines if a decimal point is used when displaying the vend price (i.e. machines using token currency may choose to remove the decimal point). OFF= Turns off the decimal point from appearing in the VFD. ON = Turns on the decimal point to appear in the VFD.
Automatic Collect	This option automatically collects all audit data information whenever the Micro-Wand communicates with the control. OFF= Turns off the automatic collect with the Micro-Wand. ON = Turns on the automatic collect with the Micro-Wand.
EC Power Fail	This option determines if the European Community Power Fail feature is enabled. If enabled and a power failure lasts at least two seconds, the control will require the user to press the START pad to resume the cycle that was in operation at the time of the power failure. OFF= Turns off the European Community Power Fail feature. ON = Turns on the European Community Power Fail feature.

**Programming NetMaster**

<b>“+046”</b>						
<b>Config #1 Value</b>	<b>EC Power Fail</b>	<b>Auto Collect</b>	<b>Decimal Point</b>	<b>Infra-red Access</b>	<b>Wash Temp Indicate</b>	<b>Daylight Savings</b>
16	OFF	OFF	OFF	OFF	OFF	OFF
17	OFF	OFF	OFF	OFF	OFF	ON
18	OFF	OFF	OFF	OFF	ON	OFF
19	OFF	OFF	OFF	OFF	ON	ON
20	OFF	OFF	OFF	ON	OFF	OFF
21	OFF	OFF	OFF	ON	OFF	ON
22	OFF	OFF	OFF	ON	ON	OFF
23	OFF	OFF	OFF	ON	ON	ON
24	OFF	OFF	ON	OFF	OFF	OFF
25	OFF	OFF	ON	OFF	OFF	ON
26	OFF	OFF	ON	OFF	ON	OFF
27	OFF	OFF	ON	OFF	ON	ON
28	OFF	OFF	ON	ON	OFF	OFF
29	OFF	OFF	ON	ON	OFF	ON
30	OFF	OFF	ON	ON	ON	OFF
31	OFF	OFF	ON	ON	ON	ON
48	OFF	ON	OFF	OFF	OFF	OFF
49	OFF	ON	OFF	OFF	OFF	ON
50	OFF	ON	OFF	OFF	ON	OFF
51	OFF	ON	OFF	OFF	ON	ON
52	OFF	ON	OFF	ON	OFF	OFF
53	OFF	ON	OFF	ON	OFF	ON
54	OFF	ON	OFF	ON	ON	OFF
55	OFF	ON	OFF	ON	ON	ON
56	OFF	ON	ON	OFF	OFF	OFF
57	OFF	ON	ON	OFF	OFF	ON
58	OFF	ON	ON	OFF	ON	OFF
59	OFF	ON	ON	OFF	ON	ON
60	OFF	ON	ON	ON	OFF	OFF
61	OFF	ON	ON	ON	OFF	ON
62	OFF	ON	ON	ON	ON	OFF
63	OFF	ON	ON	ON	ON	ON
144	ON	OFF	OFF	OFF	OFF	OFF
145	ON	OFF	OFF	OFF	OFF	ON
146	ON	OFF	OFF	OFF	ON	OFF
147	ON	OFF	OFF	OFF	ON	ON

Table 5

<b>“+046” (continued)</b>						
<b>Config #1 Value</b>	<b>EC Power Fail</b>	<b>Auto Collect</b>	<b>Decimal Point</b>	<b>Infra-red Access</b>	<b>Wash Temp Indicate</b>	<b>Daylight Savings</b>
148	ON	OFF	OFF	ON	OFF	OFF
149	ON	OFF	OFF	ON	OFF	ON
150	ON	OFF	OFF	ON	ON	OFF
151	ON	OFF	OFF	ON	ON	ON
152	ON	OFF	ON	OFF	OFF	OFF
153	ON	OFF	ON	OFF	OFF	ON
154	ON	OFF	ON	OFF	ON	OFF
155	ON	OFF	ON	OFF	ON	ON
156	ON	OFF	ON	ON	OFF	OFF
157	ON	OFF	ON	ON	OFF	ON
158	ON	OFF	ON	ON	ON	OFF
159	ON	OFF	ON	ON	ON	ON
176	ON	ON	OFF	OFF	OFF	OFF
177	ON	ON	OFF	OFF	OFF	ON
178	ON	ON	OFF	OFF	ON	OFF
179	ON	ON	OFF	OFF	ON	ON
180	ON	ON	OFF	ON	OFF	OFF
181	ON	ON	OFF	ON	OFF	ON
182	ON	ON	OFF	ON	ON	OFF
183	ON	ON	OFF	ON	ON	ON
184	ON	ON	ON	OFF	OFF	OFF
185	ON	ON	ON	OFF	OFF	ON
186	ON	ON	ON	OFF	ON	OFF
187	ON	ON	ON	OFF	ON	ON
188	ON	ON	ON	ON	OFF	OFF
189	ON	ON	ON	ON	OFF	ON
190	ON	ON	ON	ON	ON	OFF
191	ON	ON	ON	ON	ON	ON

Table 5

## 47. Control Configuration Data #3 “+047”

This option allows the owner to turn ON or turn OFF preprogrammed capabilities within NetMaster.

### How to Program the Control Configuration Data #3

1. Control must be in Manual Mode. Refer to *Entering the Manual Mode*.
2. Press the DELICATES (+) or the COLD (-) keypad until “PrOg” appears in the VFD. Press the START (enter) keypad and “+001” will appear in the VFD.

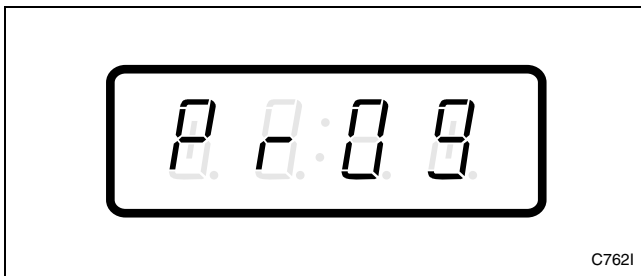

Figure 171

3. Press the DELICATES (+) or the COLD (-) keypad to scroll through the programmable options until “+047” appears in the VFD. Refer to *Figure 172*.

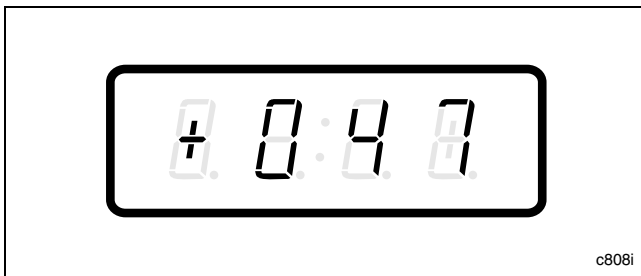

Figure 172

4. When “+047” appears in the VFD, press the START (enter) keypad. A number will appear in the VFD. This number corresponds to the current Control Configuration Data #3 Value.

5. Press the DELICATES (+) or the COLD (-) keypad to increase or decrease the current number to the desired number selected from *Table 6*. Refer to *Figure 173*.

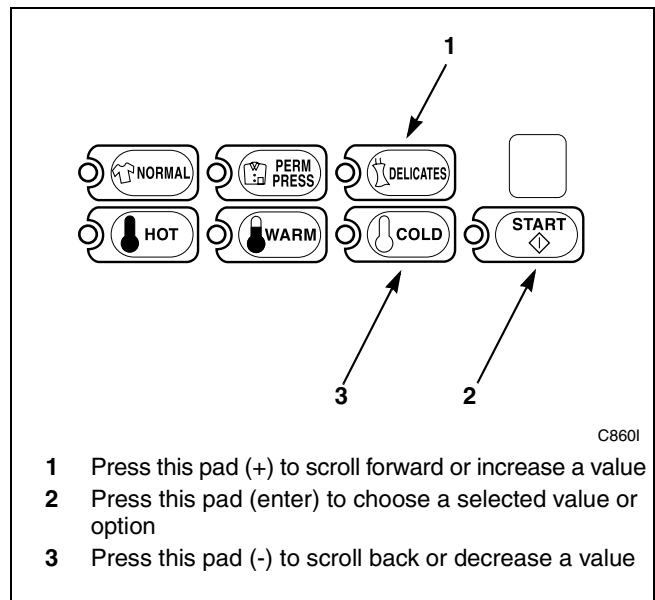

Figure 173

- 1 Press this pad (+) to scroll forward or increase a value
- 2 Press this pad (enter) to choose a selected value or option
- 3 Press this pad (-) to scroll back or decrease a value

6. Press the START (enter) keypad when the correct number appears in the VFD. The next option, “+048”, will appear in the VFD.

**NOTE: To program “+048” (Lucky Option), refer to option 48. To program other options, refer to the appropriate section.**

### How to Exit Programming Feature

1. Be sure the control shows a programmable option, not a value.
2. While pressing and holding the NORMAL keypad with one hand, press the PERM PRESS keypad with the other hand. The control will revert back to the ready mode. Refer to *Figure 2*.



### Configuration #3 Programming

Use the table below (*Table 6*) to turn on or turn off access for Manual Rapid Advance and Diagnostics, and to change the Available Output Mode.

**NOTE: Selecting “Ready Mode” for the available output will turn off the available output after the first pulse is received. Selecting “Until Start Mode” will keep the available output on until the vend price is satisfied. This feature is used for aftermarket card read or central pay systems.**

“+047”		
Config #3 Value	RADV/DIAG Access	Available
0	OFF	Ready Mode
1	OFF	Until Start Mode
2	ON	Ready Mode
3	ON	Until Start Mode

Table 6

### 48. Lucky Option “+048”

This option allows the owner to program the machine to provide a free vend cycle to customers after a certain number of machine cycles have occurred.

For coin models, “FrEE” will be displayed five minutes after the completion of the programmed number of cycles has occurred. The cycle can then be started by pressing the START (enter) pad.

For card models, when a card is inserted, the VFD will display “bAL” followed by the card balance. When the user presses the START pad, a zero vend will be deducted from the card. The VFD will display “WAIT”. The VFD will then display “FrEE” for five seconds and then the cycle time will be displayed. When the card is removed, the VFD will flash the remaining balance for three seconds and will then revert back to the cycle time.

#### How to Program Lucky Option

- Control must be in Manual Mode. Refer to *Entering the Manual Mode*.
- Press the DELICATES (+) or the COLD (-) keypad until “PrOg” appears in the VFD. Press the START (enter) keypad and “+001” will appear in the VFD.

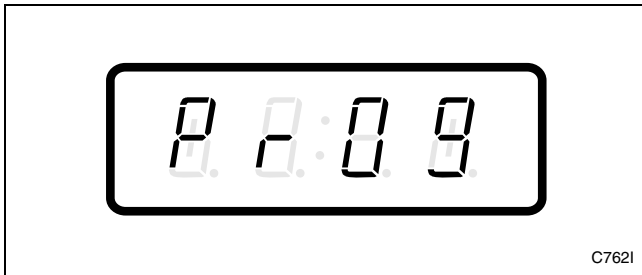

Figure 174

- Press the DELICATES (+) or the COLD (-) keypad to scroll through the programmable options until “+048” appears in the VFD. Refer to *Figure 175*.

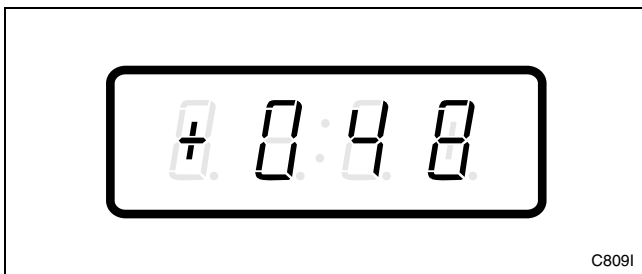

Figure 175

- When “+048” appears in the VFD, press the START (enter) keypad. A number will appear in

the VFD. This number corresponds to the current Lucky Option Programming Value.

- Locate the desired number in the first column of *Table 7* below.

“+048”		
Lucky Option Value	Lucky Cycle ON/OFF	Number of Cycles
1 – 127	OFF	1 – 127
129	ON	1
130	ON	2
131 – 255	ON	3 – 127

Table 7

- Press the DELICATES (+) or the COLD (-) keypad to increase or decrease the current number until correct. Refer to *Figure 176*.

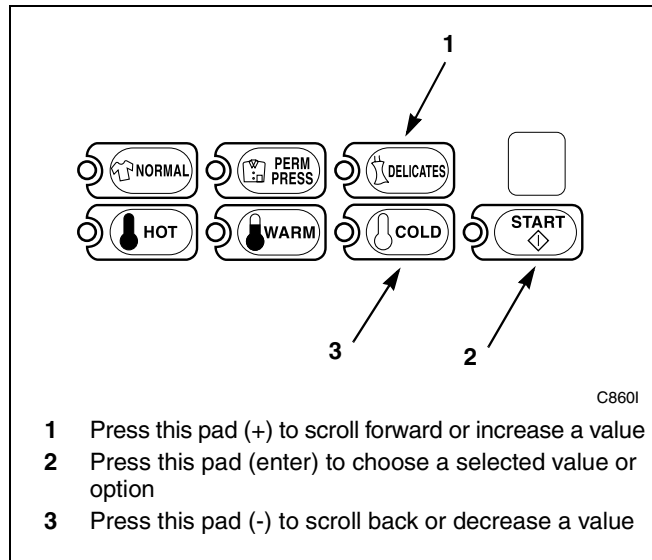

- Press this pad (+) to scroll forward or increase a value
- Press this pad (enter) to choose a selected value or option
- Press this pad (-) to scroll back or decrease a value

Figure 176

- Press the START (enter) keypad when the correct number appears in the VFD. The next option, “+049”, will appear in the VFD.

**NOTE: To program “+049” (Special Cycle Option), refer to *option 49*. To program other options, refer to the appropriate section.**

#### How to Exit Programming Feature

- Be sure the control shows a programmable option, not a value.
- While pressing and holding the NORMAL keypad with one hand, press the PERM PRESS keypad with the other hand. The control will revert back to the ready mode. Refer to *Figure 2*.

## 49. Special Cycle Option “+049”

This option allows the owner to program the machine to offer extra wash time, extra rinse time, warm rinse, or any combination of the above to the customers for an added vend price.

### How to Program Special Cycle Option

1. Control must be in Manual Mode. Refer to *Entering the Manual Mode*.
2. Press the DELICATES (+) or the COLD (-) keypad until “PrOg” appears in the VFD. Press the START (enter) keypad and “+001” will appear in the VFD.

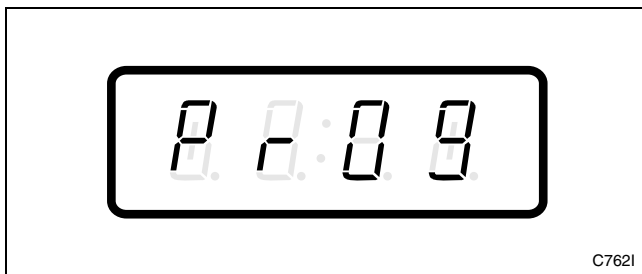

Figure 177

3. Press the DELICATES (+) or the COLD (-) keypad to scroll through the programmable options until “+049” appears in the VFD. Refer to *Figure 178*.

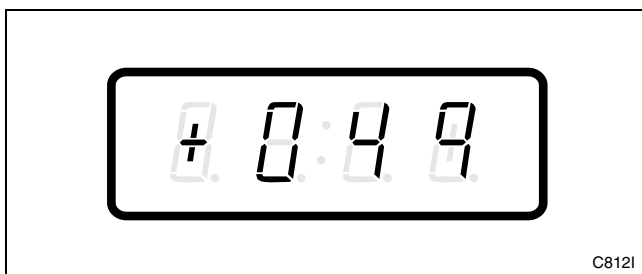
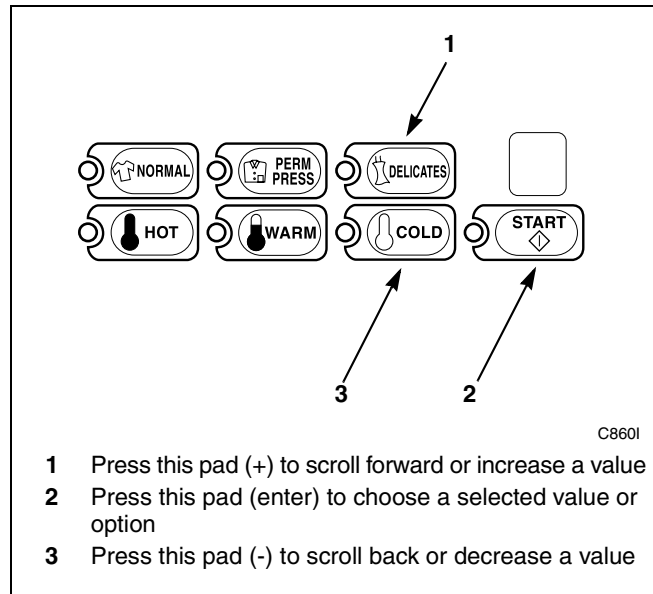

Figure 178

4. When “+049” appears in the VFD, press the START (enter) keypad. A number will appear in the VFD. This number corresponds to the current Special Cycle Option Programming Value.

5. Locate the desired number in the first column of *Table 8* on the following page.
6. Press the DELICATES (+) or the COLD (-) keypad to increase or decrease the current number until correct. Refer to *Figure 179*.



- 1 Press this pad (+) to scroll forward or increase a value
- 2 Press this pad (enter) to choose a selected value or option
- 3 Press this pad (-) to scroll back or decrease a value

Figure 179

7. Press the START (enter) keypad when the correct number appears in the VFD. The next option, “+050”, will appear in the VFD.

**NOTE: To program “+050” (Special Cycle Extra Wash Time), refer to *option 50*. To program other options, refer to the appropriate section.**

### How to Exit Programming Feature

1. Be sure the control shows a programmable option, not a value.
2. While pressing and holding the NORMAL keypad with one hand, press the PERM PRESS keypad with the other hand. The control will revert back to the ready mode. Refer to *Figure 2*.

## Programming NetMaster

### How to Read *Table 8*

To determine the correct number required to program Special Cycle Option, use the following table. The Special Cycle Option Value column contains the number required in step 6. The other columns correspond to individual options.

Each column of options contains a unique combination of the words “ON” and “OFF” that indicates if that column’s option is turned on or off when the Special Cycle Option Value is entered. Select the desired combination of options and enter the number found in the Special Cycle Option Value column.

<b>+049</b>		
<b>Special Cycle Option Value</b>	<b>Special Cycle ON/OFF</b>	<b>Warm Rinse ON/OFF</b>
0	OFF	OFF
128	ON	OFF
129	ON	ON

Table 8

## 50. Special Cycle Extra Wash Time “+050”

This option allows the owner to set the amount of additional wash time for the Special Cycle.

### How to Program Special Cycle Extra Wash Time

1. Control must be in Manual Mode. Refer to *Entering the Manual Mode*.
2. Press the DELICATES (+) or the COLD (-) keypad until “PrOg” appears in the VFD. Press the START (enter) keypad and “+001” will appear in the VFD.

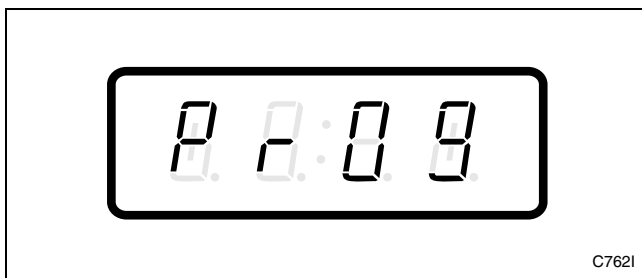

Figure 180

3. Press the DELICATES (+) or the COLD (-) keypad to scroll through the programmable options until “+050” appears in the VFD. Refer to *Figure 181*.

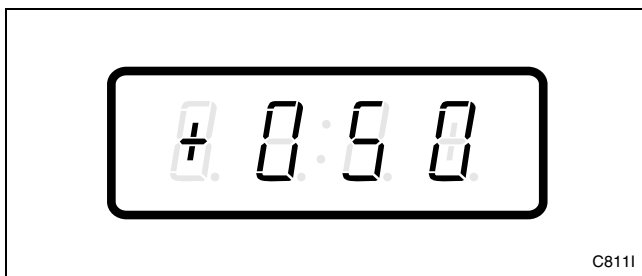

Figure 181

4. When “+050” appears in the VFD, press the START (enter) keypad. The current number of minutes set for the Special Cycle Extra Wash Time will appear in the VFD.

5. Press the DELICATES (+) or the COLD (-) keypad to increase or decrease the current number of minutes displayed in the VFD to the desired number of minutes. Refer to *Figure 182*.

**NOTE: The Special Cycle Extra Wash Time can be set from zero (0) to 15 minutes.**

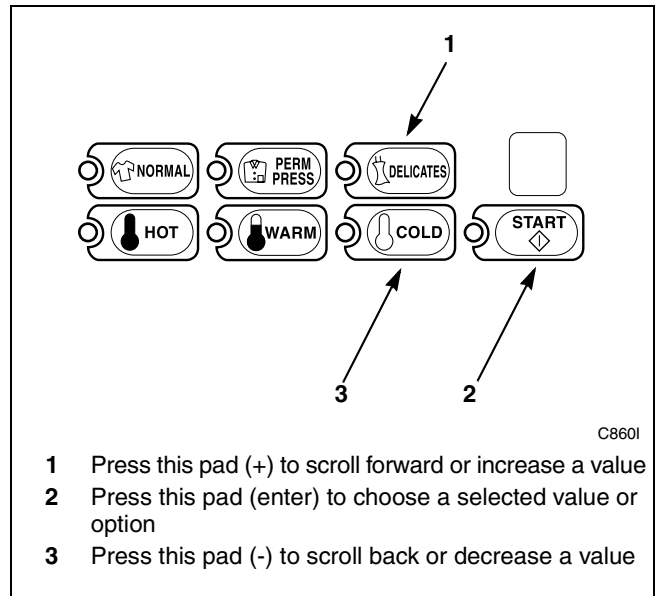

Figure 182

6. Press the START (enter) keypad when the correct number of minutes appears in the VFD. The next option, “+051”, will appear in the VFD.

**NOTE: The Special Cycle option needs to be turned on (refer to *option 49*) for the Special Cycle Extra Wash Time to take effect.**

**NOTE: To program “+051” (Special Cycle Extra Rinse Time), refer to *option 51*. To program other options, refer to the appropriate section.**

### How to Exit Programming Feature

1. Be sure the control shows a programmable option, not a value.
2. While pressing and holding the NORMAL keypad with one hand, press the PERM PRESS keypad with the other hand. The control will revert back to the ready mode. Refer to *Figure 2*.

## 51. Special Cycle Extra Extra-Rinse Time “+051”

This option allows the owner to set the amount of additional extra rinse time for the Special Cycle.

### How to Program Special Cycle Extra Extra-Rinse Time

1. Control must be in Manual Mode. Refer to *Entering the Manual Mode*.
2. Press the DELICATES (+) or the COLD (-) keypad until “PrOg” appears in the VFD. Press the START (enter) keypad and “+001” will appear in the VFD.

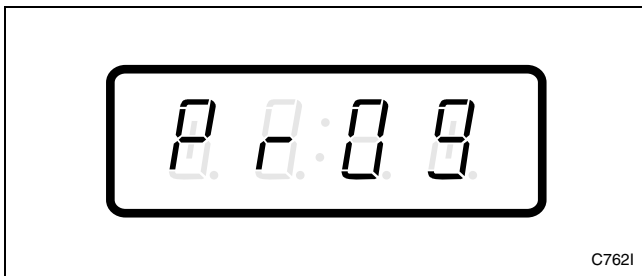

Figure 183

3. Press the DELICATES (+) or the COLD (-) keypad to scroll through the programmable options until “+051” appears in the VFD. Refer to *Figure 184*.

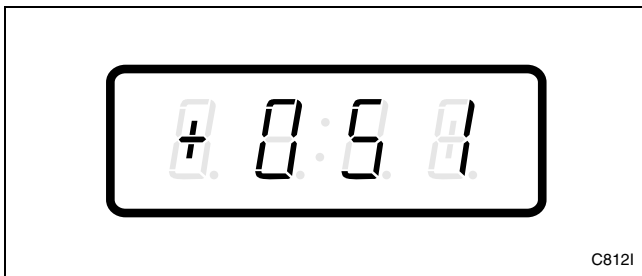

Figure 184

4. When “+051” appears in the VFD, press the START (enter) keypad. The current number of minutes set for the Special Cycle Extra Extra-Rinse Time will appear in the VFD.

5. Press the DELICATES (+) or the COLD (-) keypad to increase or decrease the current number of minutes displayed in the VFD to the desired number of minutes. Refer to *Figure 185*.

**NOTE: The Special Cycle Extra Extra-Rinse Time can be set from zero (0) to 15 minutes.**

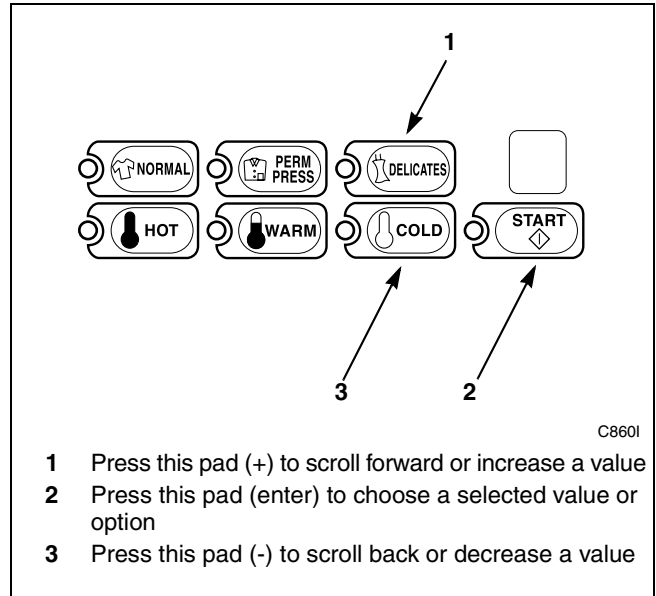

Figure 185

- 1 Press this pad (+) to scroll forward or increase a value
- 2 Press this pad (enter) to choose a selected value or option
- 3 Press this pad (-) to scroll back or decrease a value

6. Press the START (enter) keypad when the correct number of minutes appears in the VFD. The next option, “+052”, will appear in the VFD.

**NOTE: The Special Cycle option needs to be turned on (refer to *option 49*) for the Special Cycle Extra Extra-Rinse Time to take effect.**

**NOTE: To program “+052” (Smart Card Maximum Value), refer to *option 52*. To program other options, refer to the appropriate section.**

### How to Exit Programming Feature

1. Be sure the control shows a programmable option, not a value.
2. While pressing and holding the NORMAL keypad with one hand, press the PERM PRESS keypad with the other hand. The control will revert back to the ready mode. Refer to *Figure 2*.

## 52. Smart Card Maximum Value “+052”

This option allows the owner to set the maximum card balance that will be accepted. If a cash value card is inserted with a balance greater than this value, it will not be accepted.

### How to Program Smart Card Maximum Value

1. Control must be in Manual Mode. Refer to *Entering the Manual Mode*.
2. Press the DELICATES (+) or the COLD (-) keypad until “PrOg” appears in the VFD. Press the START (enter) keypad and “+001” will appear in the VFD.

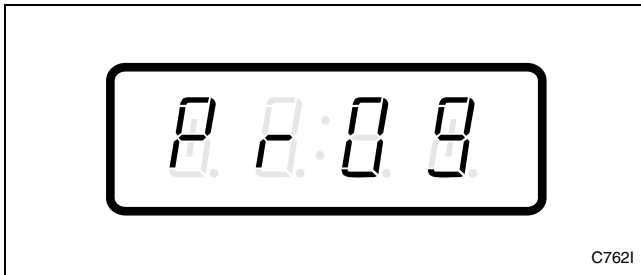

Figure 186

3. Press the DELICATES (+) or the COLD (-) keypad to scroll through the programmable options until “+052” appears in the VFD. Refer to *Figure 187*.

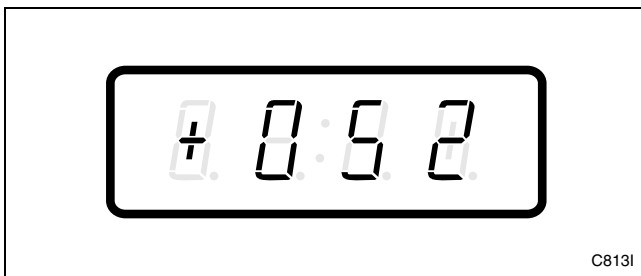

Figure 187

4. When “+052” appears in the VFD, press the START (enter) keypad. There are five digits in the Smart Card Maximum Value. The fifth digit will appear in the VFD and will flash one second on, one second off. Refer to *Figure 188*.

**NOTE: If the Smart Card Maximum Value is \$100.00 or more, the fifth digit is “1”. If the Smart Card Maximum Value is \$99.99 or less, the fifth digit is “0”.**

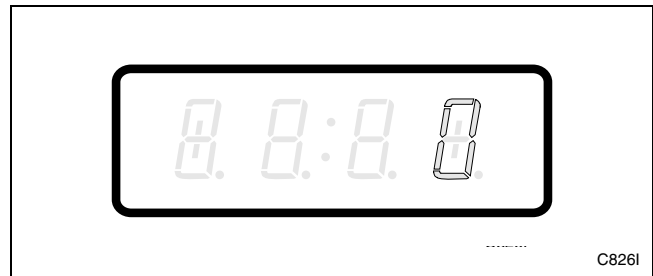
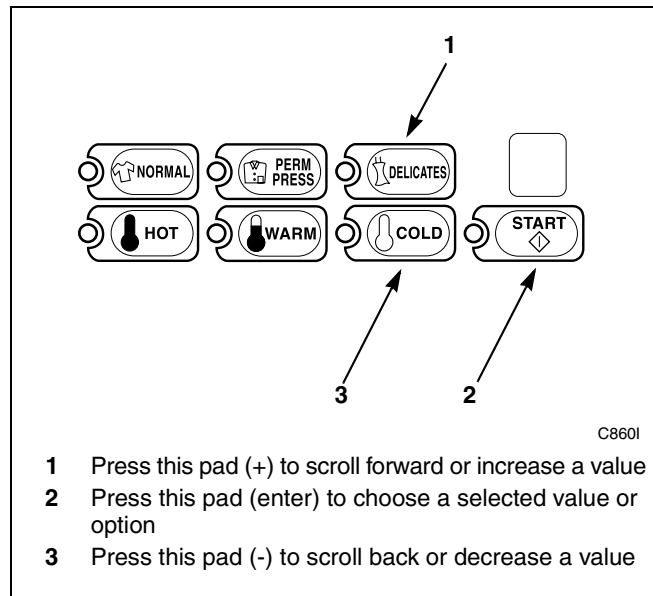

Figure 188

5. Press the DELICATES (+) or the COLD (-) keypad to increase or decrease the value of the fifth digit. Refer to *Figure 189*.



- 1 Press this pad (+) to scroll forward or increase a value
- 2 Press this pad (enter) to choose a selected value or option
- 3 Press this pad (-) to scroll back or decrease a value

Figure 189

## Programming NetMaster

6. Press the START (enter) keypad to enter the fifth digit and display remaining four digits. The active digit will flash one second on and one second off. Refer to *Figure 190*.

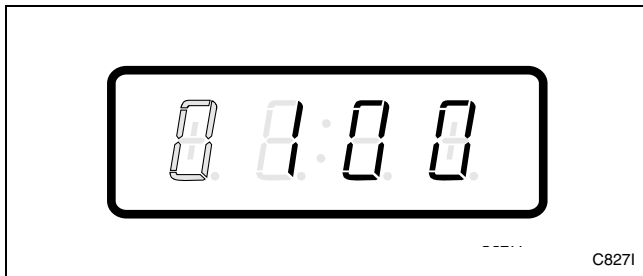

Figure 190

7. Press the DELICATES (+) or the COLD (-) keypad to increase or decrease the value of the active digit and the START (enter) keypad to enter the value of the digit and advance to the next digit.
8. Press the START (enter) keypad with the last active digit. The next option, “+053”, will appear in the VFD.

**NOTE: To program “+053” (Site Code #1), refer to *option 53*. To program other options, refer to the appropriate section.**

## How to Exit Programming Feature

1. Be sure the control shows a programmable option, not a value.
2. While pressing and holding the NORMAL keypad with one hand, press the PERM PRESS keypad with the other hand. The control will revert back to the ready mode. Refer to *Figure 2*.



### 53. Site Code #1 “+053”

This option allows the owner to program a site code to correspond with the Site Code #1 pricing. This allows different pricing for a specific site code.

#### How to Program Site Code #1

1. Control must be in Manual Mode. Refer to *Entering the Manual Mode*.
2. Press the DELICATES (+) or the COLD (-) keypad until “PrOg” appears in the VFD. Press the START (enter) keypad and “+001” will appear in the VFD.

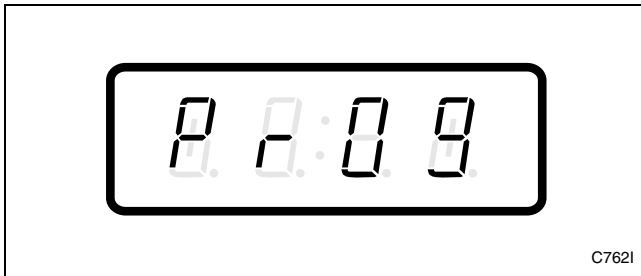

Figure 191

3. Press the DELICATES (+) or the COLD (-) keypad to scroll through the programmable options until “+053” appears in the VFD. Refer to *Figure 192*.

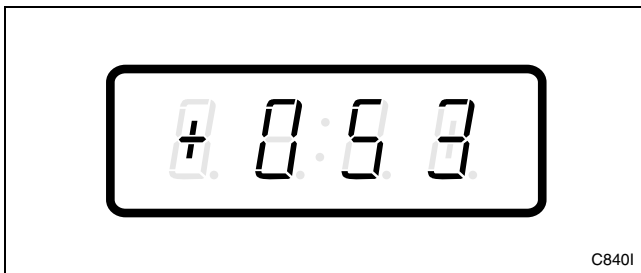

Figure 192

4. When “+053” appears in the VFD, press the START (enter) keypad. There are five digits in Site Code #1. The fifth digit will appear in the VFD and will flash one second on, one second off. Refer to *Figure 193*.

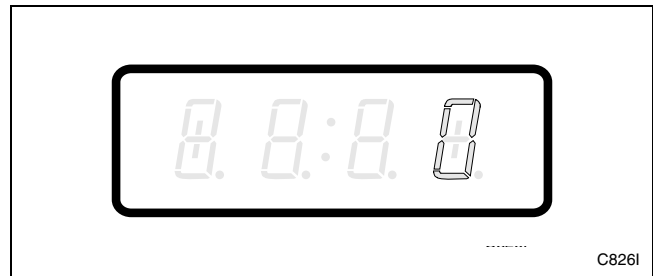
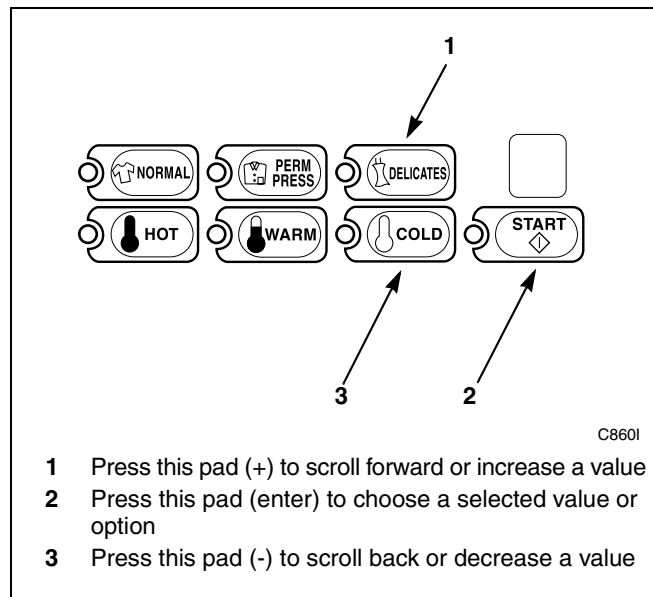

Figure 193

5. Press the DELICATES (+) or the COLD (-) keypad to increase or decrease the value of the fifth digit. Refer to *Figure 194*.



- 1 Press this pad (+) to scroll forward or increase a value
- 2 Press this pad (enter) to choose a selected value or option
- 3 Press this pad (-) to scroll back or decrease a value

Figure 194

## Programming NetMaster

6. Press the START (enter) keypad to enter the fifth digit and display remaining four digits. The active digit will flash one second on and one second off. Refer to *Figure 195*.

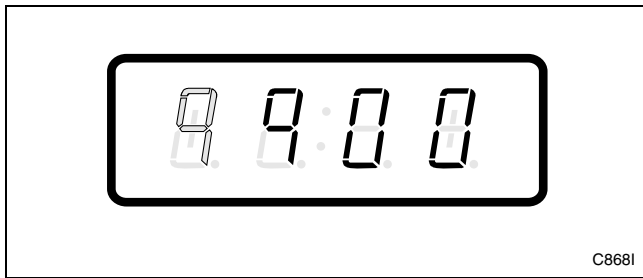

Figure 195

7. Press the DELICATES (+) or the COLD (-) keypad to increase or decrease the value of the active digit and the START (enter) keypad to enter the value of the digit and advance to the next digit.
8. Press the START (enter) keypad with the last active digit. The next option, “+054”, will appear in the VFD.

**NOTE: To program “+054” (Error Code Programming Parameter), refer to *option 54*. To program other options, refer to the appropriate section.**

## How to Exit Programming Feature

1. Be sure the control shows a programmable option, not a value.
2. While pressing and holding the NORMAL keypad with one hand, press the PERM PRESS keypad with the other hand. The control will revert back to the ready mode. Refer to *Figure 2*.

## 54. Error Code Programming Parameter “+054”

This option allows the owner to turn on or turn off certain errors in the control.

### How to Program Error Code Programming Parameter

1. Control must be in Manual Mode. Refer to *Entering the Manual Mode*.
2. Press the DELICATES (+) or the COLD (-) keypad until “PrOg” appears in the VFD. Press the START (enter) keypad and “+001” will appear in the VFD.

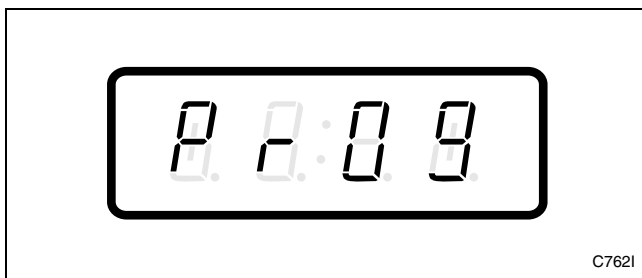

Figure 196

3. Press the DELICATES (+) or the COLD (-) keypad to scroll through the programmable options until “+054” appears in the VFD. Refer to *Figure 197*.

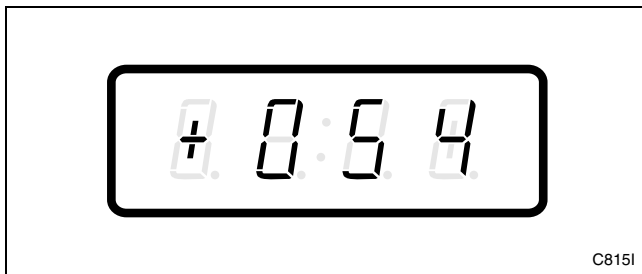

Figure 197

4. When “+054” appears in the VFD, press the START (enter) keypad. A number will appear in the VFD. This number corresponds to the current Error Code Programming Parameter Value.
5. Locate the desired number in the first column of *Table 9* on the following page.

6. Press the DELICATES (+) or the COLD (-) keypad to increase or decrease the current number until correct. Refer to *Figure 198*.

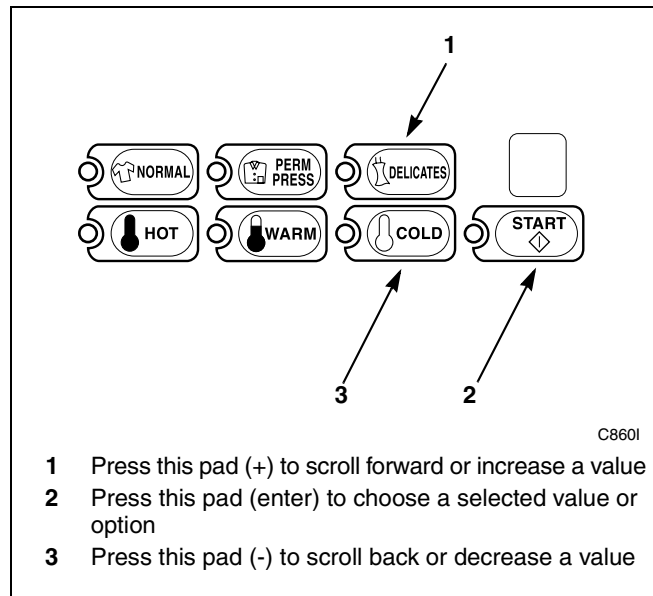

Figure 198

7. Press the START (enter) keypad when the correct number appears in the VFD. The next option, “+055”, will appear in the VFD.

**NOTE: To program “+055” (Start Pulse Mode), refer to *option 55*. To program other options, refer to the appropriate section.**

### How to Exit Programming Feature

1. Be sure the control shows a programmable option, not a value.
2. While pressing and holding the NORMAL keypad with one hand, press the PERM PRESS keypad with the other hand. The control will revert back to the ready mode. Refer to *Figure 2*.

## Programming NetMaster

### How to Read *Table 9*

To determine the correct number required to program Error Code Programming Parameter, use the following table. The Error Code Value column contains the number required in step 6. The other columns correspond to individual options.

Each column of options contains a unique combination of the words “ON” and “OFF” that indicates if that column’s option is turned on or off when the Error Code Value is entered. Select the desired combination of options and enter the number found in the Error Code Value column.

<b>“+054”</b>			
<b>Error Code Value</b>	<b>Drain Error</b>	<b>Fill Error</b>	<b>Coin Error</b>
0	OFF	OFF	OFF
1	OFF	OFF	<b>ON</b>
4	OFF	<b>ON</b>	OFF
5	OFF	<b>ON</b>	<b>ON</b>
8	<b>ON</b>	OFF	OFF
9	<b>ON</b>	OFF	<b>ON</b>
12	<b>ON</b>	<b>ON</b>	OFF
13	<b>ON</b>	<b>ON</b>	<b>ON</b>

Table 9

## 55. Start Pulse Mode “+055”

This option allows the owner to program the Start Pulse Input. The Start Pulse Mode can be used for after-market central pay or card systems. The central system sends the start pulse to the Start Pulse Input of the control to start the cycle. If set for single pulse, one start pulse from the central system will start the cycle. If set for multiple pulses, each pulse will deduct from the vend price the value set up in *option 23 (Start Pulse Value)* until the vend is satisfied.

### How to Program Start Pulse Mode

- Control must be in Manual Mode. Refer to *Entering the Manual Mode*.
- Press the DELICATES (+) or the COLD (-) keypad until “PrOg” appears in the VFD. Press the START (enter) keypad and “+001” will appear in the VFD.

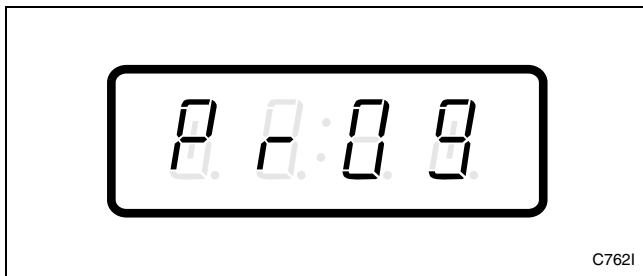

Figure 199

- Press the DELICATES (+) or the COLD (-) keypad to scroll through the programmable options until “+055” appears in the VFD. Refer to *Figure 200*.

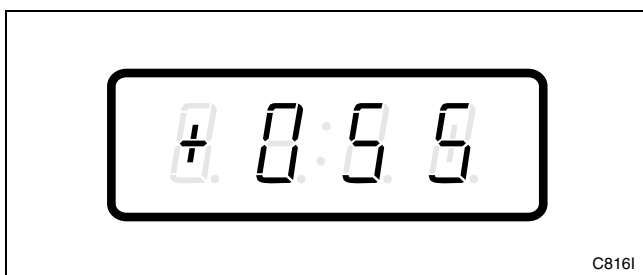

Figure 200

- When “+055” appears in the VFD, press the START (enter) keypad. A number will appear in the VFD. This number corresponds to the current Start Pulse Mode Programming Value.

- Locate the desired number in the first column of *Table 10* below.

“+055”		
Start Pulse Mode Value	Start Pulse ON/OFF	Single Pulse/ Multiple Pulses
0	OFF	Single Pulse
64	OFF	Multiple Pulses
128	ON	Single Pulse
192	ON	Multiple Pulses

Table 10

- Press the DELICATES (+) or the COLD (-) keypad to increase or decrease the current number until correct. Refer to *Figure 201*.

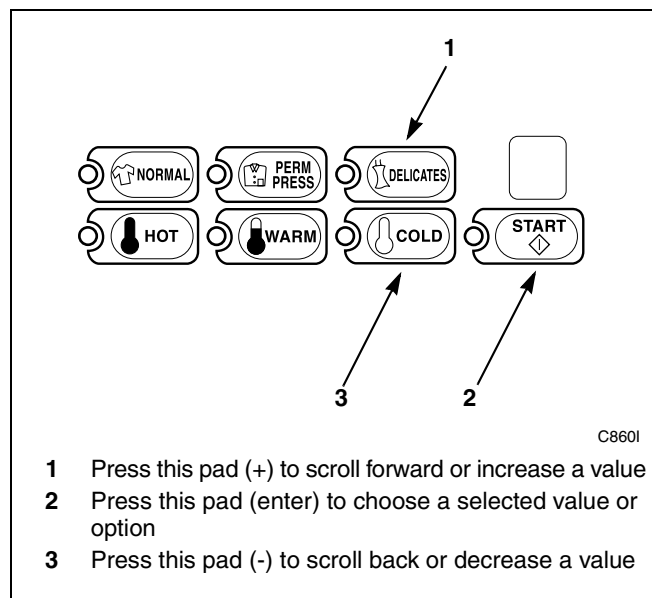

- Press this pad (+) to scroll forward or increase a value
- Press this pad (enter) to choose a selected value or option
- Press this pad (-) to scroll back or decrease a value

Figure 201

- Press the START (enter) keypad when the correct number appears in the VFD.

**NOTE: To program other options, refer to the appropriate section.**

### How to Exit Programming Feature

- Be sure the control shows a programmable option, not a value.
- While pressing and holding the NORMAL keypad with one hand, press the PERM PRESS keypad with the other hand. The control will revert back to the ready mode. Refer to *Figure 2*.



# Collecting Audit Information

This feature allows the owner to retrieve audit information stored in the washer by pressing a sequence of pads on the control. For an explanation of the audit options available, see the Audit Options List on this page.

## How to Enter Audit Feature

1. Control must be in Manual Mode to start. Refer to *Entering the Manual Mode*.
2. Press the DELICATES (+) or the COLD (-) keypad until “AUDT” appears. Refer to *Figure 202*.

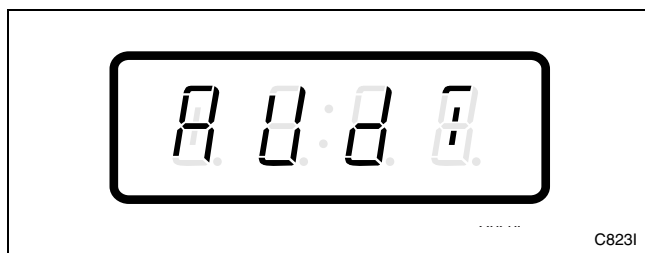

Figure 202

3. Press the START keypad. “CyCL” will appear.

If the procedure did not work, the control will return to the ready mode. Refer to *Figure 2*.

## How to Read Audit Data

1. Use the DELICATES (+) or the COLD (-) keypad to scroll through various options until the desired option is displayed in the VFD. Refer to the Audit Options List, *Table 11*, for an explanation of the audit options available. Refer to *Figure 203*.

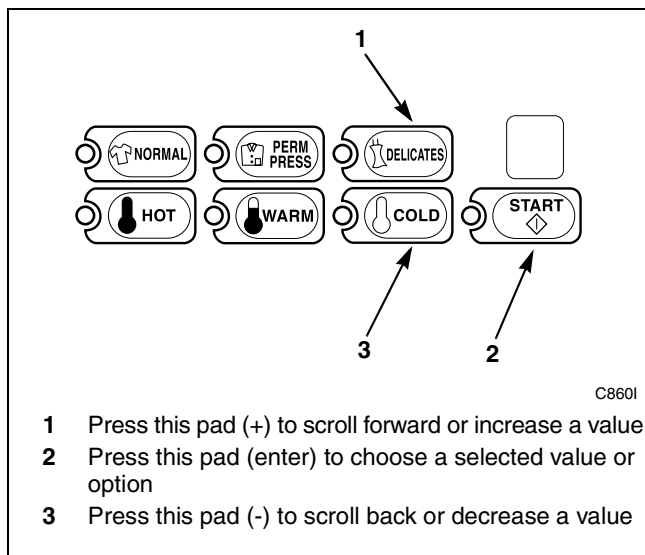

- 1 Press this pad (+) to scroll forward or increase a value
- 2 Press this pad (enter) to choose a selected value or option
- 3 Press this pad (-) to scroll back or decrease a value

Figure 203

Audit Options List		
#	VFD Display	Description
1	“CyCL”	Total # of machine cycles
2	“COI1”	Total # of coins #1
3	“COI2”	Total # of coins #2
4	“PLSE”	Total # of Start Pulses
5	“CArd”	Smart Card Reader Firm Ware Version #

Table 11

2. Once the desired option appears in the VFD, press the START (enter) keypad **once** to start the audit count. At this point, the display will show the first four-digit segment of the audit value. Press the START (enter) keypad again to view the last four digits of the number.

**NOTE: The VFD can display up to 4 digits at one time. All audit counts are separated into two 4-digit segments. Each time the START (enter) keypad is pressed in step 2, the VFD will show the next four-digit segment in the audit value.**

For Example: In the Total Number of Coins #1 option with “COI1” displayed in the VFD, the audit has counted 10,009 coins. Pressing the START (enter) keypad one time will show “\_ \_ \_ 1” to represent ten thousand. Pressing the START (enter) keypad a second time will display “0009” meaning nine. The total equals “00010009” or 10,009.

3. Press the START (enter) keypad again. The control will go to the next audit option in the Audit Options List.
4. To select other audit options, repeat steps 1 – 4.

## How to Exit Audit Feature

1. Be sure the control shows an audit option, not a value.
2. While pressing and holding the NORMAL keypad with one hand, press the PERM PRESS keypad with the other hand. The control will return to the ready mode. Refer to *Figure 2*.





# Manual Reset

This feature allows the owner to reset the washer control's programming data to the factory default settings by pressing a sequence of pads on the control. For an explanation of the Factory Default Settings, refer to *Default Washer Settings*.

## How to Enter Manual Reset

1. Control must be in Manual Mode to start. Refer to *Entering the Manual Mode*.
2. Press the DELICATES (+) or the COLD (-) keypad until "rSET" appears. Refer to *Figure 204*.

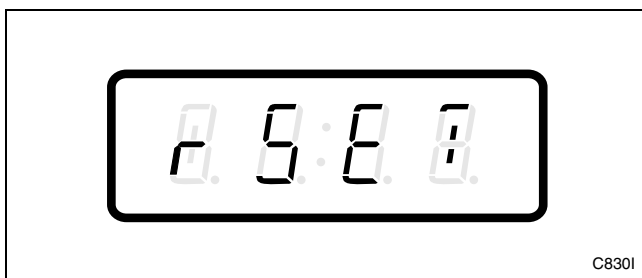

Figure 204

3. Press the START (enter) keypad. The control will display "WAIT" until the programming is complete. Once the program has been reset, the control will revert back to the ready mode.



# Testing Machine and Electronic Control Functions

This feature allows the owner to run diagnostic tests on various washer operations without servicing the washer. The following tests are available:

- Control Software Version Number
- Pressure Switch Opening Test
- Service Door Opening Test
- Coin Vault Opening Test
- Coin Drop #1 Input Test
- Coin Drop #2 Input Test
- Lid Switch Input Test
- Show Fill Time Test
- Show Drain Time Test
- Start Pulse Test
- Configuration #1 Display Test
- Configuration #2 Display Test
- Configuration #3 Display Test

## How to Enter Testing Feature

1. Control must be in Manual Mode. Refer to *Entering the Manual Mode*.
2. Press the DELICATES (+) or the COLD (-) keypad until “dIAG” appears.
3. Press the START (enter) keypad. Display will change to “+001” indicating the control software version number test.
4. Press the DELICATES (+) or the COLD (-) keypad to scroll through the diagnostic test options.

## How to Start Tests

To start a diagnostic test, refer to the quick reference chart below (*Table 12*). Press the START (enter) keypad when the desired test # is displayed. For detailed information on each test, read the appropriate description.

## How to Exit Testing Feature

While pressing and holding the NORMAL keypad with one hand, press the PERM PRESS keypad with the other hand. The display will return to the ready mode. Refer to *Figure 2*.

Diagnostic (Testing) Mode – Quick Reference Chart		
Test Number	Diagnostic Mode	VFD Display
1	Control Software Version # Test	“SXXX”
2	Service Door Opening Test	“S:XX”
3	Coin Vault Opening Test	“U:XX”
4	Coin Drop #1 Input Test	“C1:XX”
5	Coin Drop #2 Input Test	“C2:XX”
6	Lid Switch Input Test	“L:XX”
7	Pressure Switch Opening Test	“PXXX”
8	Show Fill Time Test	“FX:XX”
9	Show Drain Time Test	“dX:XX”
10	Start Pulse Test	“ST:XX”
11	Configuration #1 Display Test	“AXXX”
12	Configuration #2 Display Test	“bXXX”
13	Configuration #3 Display Test	“CXXX”

Table 12

## Diagnostic Test Descriptions

### Control Software Version Number Test

This option displays the control software version number. To start test, control must be in the Testing Mode. Refer to “*How to Start Tests*” at the beginning of this section.

To enter, press the START (enter) keypad. The VFD display will show “SXXX” where “XXX” is the software version number.

To exit the Software Version Number Test, press the NORMAL and PERM PRESS keypads. The control will return to the ready mode. Refer to *Figure 2*.

### Service Door Opening Test

This option tests the service door switch. To start test, control must be in the Testing Mode. Refer to “*How to Start Tests*” at the beginning of this section.

To enter, press the START (enter) keypad. The VFD display will show “S:XX”. The “XX” will show the number of service door openings.

The service door switch has to be closed for at least one second and opened for at least a half a second to make a valid count. This test will add counts to the service door opening counter for the audit and save the date/time for each opening of the test.

To exit the Service Door Opening Test, press the NORMAL and PERM PRESS keypads. The control will return to the ready mode. Refer to *Figure 2*.

### Coin Vault Opening Test

This option tests the coin vault switch. To start test, the control must be in the Testing Mode. Refer to “*How to Start Tests*” at the beginning of this section.

To enter, press the START (enter) keypad. The VFD display will show “U:XX”. The “XX” will show the number of coin vault openings.

The coin vault switch has to be closed for at least one second and opened for at least a half a second to make a valid count. This test will add counts to the coin vault opening counter for the audit and save the time/date for each opening of the test.

To exit the Coin Vault Opening Test, press the NORMAL and PERM PRESS keypads. The control will return to the ready mode. Refer to *Figure 2*.

### Coin Drop #1 Input Test

This option tests coin drop #1. To start test, control must be in the Testing Mode. Refer to “*How to Start Tests*” at the beginning of this section.

To enter, press the START (enter) keypad. The VFD display will show “C1:XX”. The “XX” will show the number of coins entered. This test will add counts to the total number of test coins #1 counter. Refer to *Collecting Audit Information*.

To exit the Coin Drop #1 Input Test, press the NORMAL and PERM PRESS keypads. The control will return to the ready mode. Refer to *Figure 2*.

### Coin Drop #2 Input Test

This option tests coin drop #2. To start test, control must be in the Testing Mode. Refer to “*How to Start Tests*” at the beginning of this section.

To enter, press the START (enter) keypad. The VFD display will show “C2:XX”. The “XX” will show the number of coins entered. This test will add counts to the total number of test coins #2 counter. Refer to *Collecting Audit Information*.

To exit the Coin Drop #2 Input Test, press the NORMAL and PERM PRESS keypads. The control will return to the ready mode. Refer to *Figure 2*.

### Lid Switch Input Test

This test will display whether the washer lid is open or closed.

To start test, control must be in the Testing Mode. Refer to “*How to Start Tests*” at the beginning of this section.

To enter, press the START (enter) keypad. If the lid is closed, the VFD will display “L:CL”. If the lid is open, the VFD will display “L:OP”.

To exit the test, press the NORMAL keypad with one hand, then press the PERM PRESS keypad with the other hand. The control will return to the ready mode. Refer to *Figure 2*.

### Pressure Switch Input Test

This test will display whether the pressure switch is open or closed.

To start test, control must be in the Testing Mode. Refer to “How to Start Tests” at the beginning of this section.

To enter, press the START (enter) keypad. The VFD display will show “P:OP” if the pressure switch is open and “P:CL” if the pressure switch is closed.

To exit the test, press the NORMAL keypad with one hand, and then press the PERM PRESS keypad with the other hand. The control will then return to the ready mode. Refer to *Figure 2*.

### Show Fill Time Test

This test will display the average fill time in minutes and seconds. This average will be calculated by taking the average of the last four (4) fill times.

To start test, control must be in the Testing Mode. Refer to “How to Start Tests” at the beginning of this section.

To enter, press the START (enter) keypad. The VFD will show “FX:XX”. The “X:XX” will be the average fill time in minutes and seconds for that machine.

To exit the Show Fill Time Test, press and hold the NORMAL keypad with one hand, then press the PERM PRESS keypad with the other hand. The control will return to the ready mode. Refer to *Figure 2*.

### Show Drain Time Test

This test will display the average drain time in minutes and seconds. The average drain time is calculated by taking the average of the last four (4) drain times.

To start the test, press the START (enter) keypad. The VFD will show “dX:XX”. The “X:XX” will be the average drain time in minutes and seconds for that machine.

To exit the Show Drain Time Test, press and hold the NORMAL keypad with one hand, then press the PERM PRESS keypad with the other hand. The control will return to the ready mode. Refer to *Figure 2*.

### Start Pulse Test

This option tests the Start Pulse. To start test, control must be in the Testing Mode. Refer to “How to Start Tests” at the beginning of this section.

To enter, press the START (enter) keypad. The VFD display will show “ST:XX”. The “XX” will show the number of pulses entered. This test will add counts to the total number of Start Pulses counter. Refer to *Collecting Audit Information*.

To exit the Start Pulse Test, press the NORMAL and PERM PRESS keypads. The control will return to the ready mode. Refer to *Figure 2*.

### Configuration Display Test

This option shows the machine configuration values. Test #11 shows configuration value #1, Test #12 shows configuration value #2, and Test #13 shows configuration value #3. To start test, control must be in the Testing Mode. Refer to “How to Start Tests” at the beginning of this section.

To enter, press the START (enter) keypad. For configuration value #1, the VFD will show “AXXX”. For configuration value #2, the VFD will show “bXXX”. For configuration value #3, the VFD will show “CXXX”. For all, “XXX” is the value of the number.

Refer to tables below for test information.

To exit a Configuration Display Test, press the NORMAL and PERM PRESS keypads. The control will return to the ready mode. Refer to *Figure 2*.

Machine Configuration #1 Table

Value	Coin #1	Coin #2
129	NO	NO
161	YES	NO
193	NO	YES
225	YES	YES

Table 13

Machine Configuration #2 Table

Value	Network Board	Smart Card Reader
0	NO	NO
32	NO	YES
64	YES	NO
96	YES	YES

Table 14

Machine Configuration #3 – unused.



# Error Codes

Following is a list of possible error codes for an electronic control. Errors beginning with “EI” refer to NetMaster Infra-red communication errors. Errors

beginning with “EC” refer to NetMaster card reader errors. All other errors refer to electronic control errors.

<b>Display</b>	<b>Description</b>	<b>Cause/ Corrective Action</b>
EI:01	Transmission Failure	Communication failure. Re-aim Micro-Wand and try again.
EI:02	Device Timeout	Communication failure. Re-aim Micro-Wand and try again.
EI:03	Invalid Command Code	Incorrect machine type. Before downloading, ensure data is for current machine type.
EI:04	Expecting Upload Request	Communication failure. Re-aim Micro-Wand and try again.
EI:05	Invalid or Out-of-Range Data	Incorrect machine type. Before downloading, ensure data is for current machine type.
EI:06	Invalid Data Code	Incorrect machine type. Before downloading, ensure data is for current machine type.
EI:07	Error Writing to RTC	Control failure. Replace control.
EI:08	Error Writing to EEPROM	Control failure. Replace control.
EI:09	CRC-16 Error	Communication failure. Re-aim Micro-Wand and try again.
EI:0A	Invalid Machine Type	Incorrect machine type. Before downloading, ensure data is for current machine type.
EI:0F	Invalid Wakeup or Infra-red Disabled	Communication failure or infra-red is disabled. Manually enable infra-red on control or re-aim Micro-Wand and try again.
EC:00	General Communication Error	Communication failure. Try card again.
EC:02	Timeout Error	Communication failure. Try card again.
EC:03	Invalid Command Code	Incorrect machine type. Before downloading, ensure data is for current machine type.
EC:05	Invalid or Out-of-Range Data	Incorrect machine type. Before downloading, ensure data is for current machine type.
EC:06	Invalid Data Code	Incorrect machine type. Before downloading, ensure data is for current machine type.
EC:09	Corrupted Data Error	Communication error. Try card again.
EC:0A	Invalid Machine Type	Incorrect machine type. Before downloading, ensure data is for current machine type.
EC:19	No Card Reader Communication	Communication failure. Power down, power up and try again. If error persists, replace control or card reader.

Table 15

## Error Codes

Display	Description	Cause/ Corrective Action
EC:20	Unreadable Card	Faulty card or dirty contact. Clean chip on card or card reader contacts. Try card again. If error persists, card may be faulty.
EC:21	Security ID Mismatch	Incorrect card. Use card with correct security code.
EC:22	Site Code Mismatch	Incorrect card. Use card with correct site code.
EC:23	Card Maximum Value Exceeded	Value on card over max. Use a card which does not exceed maximum value.
EC:24	Insufficient Memory on Card	Card memory is full. Download card contents to PC and clear card for re-use.
EC:25	Card Reader Malfunction	Faulty card reader. Replace card reader.
EC:26	Card Write Error	Try card again. If error persists, card may be faulty.
EC:27	Diagnostic Test Card Write Failure	Faulty card reader. Replace card reader.
EC:28	Diagnostic Test Card Read Failure	Faulty card reader. Replace card reader.
EC:29	Diagnostic Test Memory Test Failure	Faulty card reader. Replace card reader.
EC:2A	Diagnostic Test Card Interface Failure	Faulty card reader. Replace card reader.
EC:2b	Diagnostic Test Flash Checksum Failure	Faulty card reader. Replace card reader.
EC:2C	Biberon or Non-biberon Device Failure	Faulty card reader. Replace card reader.
EC:2d	Firmware Update Failed, S/W (Software) Intact	Firmware load failed. Replace card reader.
EC:2E	Firmware Update Failed, S/W Not Intact	Faulty firmware in reader. Replace card reader.
EC:2F	Firmware Updated, S/W Not Intact	Faulty firmware in reader. Replace card reader.
EC:30	Timeout Error	Replace card reader.
EC:31	Hotlisted Card Inserted Into Reader	Card hotlisted. Control will destroy card.
EC:50	Loyalty Purse Read Error	Try card again. If error persists, card may be faulty.
EC:56	Loyalty Purse Write Error	Try card again. If error persists, card may be faulty.
Right most DP (decimal point) Lit	Network Communication Error	Communication problem. Wait for 1.5 minutes for error to clear. If error doesn't clear, power-down and power-up the machine. If error persists, replace control or network board.
Alrm	Break-in Alarm Error	Service the door or coin vault switches.
OFF	Break-in Alarm Shutdown Error	Service the door or coin vault switches.
E:FL	Fill Error	Pressure switch fails to open in 30 minutes in any fill agitate cycle.
E:dr	Drain Error	Maximum drain time exceeded or water sensed at end of spin step.

Table 15



<b>Display</b>	<b>Description</b>	<b>Cause/ Corrective Action</b>
Err	Coin Error	Invalid coin pulse or inoperative coin sensor. Check coin drop area and remove obstructions. If error persists, tampering may have occurred. Evaluate security procedures.

Table 15



# Sales Floor Feature

The Sales Floor feature is used on a sales floor to allow the owner to turn on the entire VFD display and all LEDs.

## How to Enter Sales Floor Feature

1. Control must be in Manual Mode to start. Refer to *Entering the Manual Mode*.
2. Press the DELICATES (+) or the COLD (-) keypad until "SHOW" appears.
3. Press the START (enter) keypad.

The display will light up.

## How to Exit Sales Floor Feature

1. Be sure service door is open.
2. While pressing and holding the NORMAL keypad with one hand, press the PERM PRESS keypad with the other hand.

The display will return to the ready mode. Refer to *Figure 2*.



# Rapid Advance Feature

The Rapid Advance feature allows the owner to quickly advance through active cycles or advance into a cycle from the ready mode.

## How to Enter Rapid Advance from Ready Mode

1. If control is in Ready Mode, control must be put into Manual Mode. Refer to *Entering the Manual Mode*.
2. Press the DELICATES (+) or the COLD (-) keypad until “rAPd” appears in the display.
3. Press the START (enter) keypad. The VFD will display cycle time and the START (enter) keypad LED will flash.
4. Press the START (enter) keypad to start cycle.

## How to Enter Rapid Advance During an Active Cycle

1. Be certain service door is open.
2. While pressing and holding the NORMAL keypad with one hand, press the HOT keypad with the other hand. There will be no change on the VFD display.

Control may be in an active cycle or in the ready mode to use the Rapid Advance feature.

While in the Rapid Advance Mode, pressing the START (enter) keypad will advance the washer to the next cycle step. The cycle indicator lights will tell which cycle step the washer is in.

For Example: If the washer is in the wash fill/agitate cycle step, pressing the START (enter) keypad will advance the washer into the *WASH PAUSE* cycle step.

Continue pressing the START (enter) keypad until the cycle is completed.

## How to Exit Rapid Advance Feature

1. Advance through the cycles until reaching the ready mode. Refer to *Figure 2*.

**NOTE: The Rapid Advance/Diagnostic Access option must be turned on for Rapid Advance to work. Refer to option 47 in Programming NetMaster.**



# Clear Vend Feature

The Clear Vend feature allows the owner to clear a control which is in the middle of satisfying a vend price, and set it back to the ready mode.

## How to Clear Vend

1. Open the service door. Refer to *Opening the Service Door*.
2. While pressing and holding the HOT keypad with one hand, press the PERM PRESS keypad with the other hand. The control will reset to the ready mode. Refer to *Figure 2*.





# Power Fail Recovery

The Power Fail Recovery feature allows the cycle status to be saved in memory in the event of a power failure.

If a cycle is in progress when the power fails, the cycle status is saved in memory. When power recovers, the control will determine whether to automatically continue the cycle from the point it left off, requiring the user to press the START pad to continue the cycle, or end the cycle and put the control into the Ready Mode.

## Power Fail Reset Disabled

If the European Community (EC) Power Fail feature is disabled, the control will automatically resume the cycle from the point it left off. Whenever the EC Power Fail feature is enabled and the power failure lasted more than two (2) seconds, the control will go back to the Start Mode and will prompt the user to press the START pad to continue the cycle from the point it left off.

## Power Fail Reset Enabled

If the length of the power failure is less than the programmed Power Failure Reset time, the control will resume the cycle from the point it left off. The cycle will resume automatically unless the EC Power Fail feature is enabled and the failure lasted more than two (2) seconds which requires the user to press the START pad.

If the power failure lasted more than the programmed power failure reset time, the control will end the cycle and will return to the Ready Mode. If, however, the cylinder is filled with water when the power recovers, the control will not go directly to Ready Mode, but will spin out the water first. In this case the control will enter the Start Mode at the Rinse Spin #1 step of the DELICATE Cycle prompting the user to press the START pad. Once the START pad is pressed, the control will start the Rinse Spin #1 step, then the Final Spin step and then end the cycle.



# Communications Mode

## Infra-red Communications

The Infra-red Communications feature allows the washer control to communicate with the Micro-Wand IIIE. The washer control can be programmed and have its data read without using the keypad. It may also be used to start and stop various diagnostic tests.

### How to Begin Communications with Micro-Wand IIIE

The control will go blank and the VFD will display “-C-” until the communication is complete. The display will return to the previous mode. If an error occurs that terminates communication, the VFD will display “E1:XX” (“XX” represents the error code).

**NOTE: The Infra-red Communications option must be turned on. Refer to *option 46* in *Programming NetMaster*.**

## Card Reader Communications (Card Models Only)

The Card Reader Communications feature allows the washer control to communicate with the Card Reader. The washer control can be programmed and have its data read without using the keypad.

## Network Communications

The Network Communications feature allows the washer control to communicate with the Network. The washer control can be programmed and have its data read without using the keypad.



# Default Washer Settings

## Default Settings

Cycle	PERM PRESS
Wash Water Temperature	WARM
Rinse Water Temperature	COLD
Special Vends	OFF. All items zero.
Signals:	
Keypress	ON
End of Cycle	OFF
Coin Input/Card Insertion	ON
Remove Card	ON
Coin #1 Value	.25
Coin #2 Value	1.00
Power Fail Reset	OFF/5 minutes
Control Configuration:	
Daylight Savings	ON
Wash Temp Indicator	SELECT (OFF)
Infra-red Access	ON
Decimal Point	ON
Auto Collect	ON
EC Power Fail	OFF

## Default Cycle

The cycle listed is the default PERM PRESS cycle programmed in at the factory. This cycle can be made longer or shorter by reprogramming the agitate times. Refer to *Programming NetMaster* section to change these times. All other times are not programmable.

Cycle	Default
Wash Fill	2:00
Wash Agitate	10:00*
Wash Pause	0:10
Wash Pump	0:00
Wash Spin #1	1:30
Wash Spin/Spray	0:30
Wash Spin #2	1:30
Extra Rinse Fill	0:00
Extra Rinse Agitate	0:00*
Extra Rinse Pause	0:00
Extra Rinse Pump	0:00
Extra Rinse Spin #1	3:00
Rinse Fill	2:00
Rinse Agitate	4:00*
Rinse Pause	0:10
Rinse Pump	0:00
Rinse Spin #1	1:30
Final Spin	6:00*

\* = Programmable Times



## Free Manuals Download Website

<http://myh66.com>

<http://usermanuals.us>

<http://www.somanuals.com>

<http://www.4manuals.cc>

<http://www.manual-lib.com>

<http://www.404manual.com>

<http://www.luxmanual.com>

<http://aubethermostatmanual.com>

Golf course search by state

<http://golfingnear.com>

Email search by domain

<http://emailbydomain.com>

Auto manuals search

<http://auto.somanuals.com>

TV manuals search

<http://tv.somanuals.com>