

# AMERICAN AUDIO

## Q-2411 PRO Professional Preamp Mixer



### User Guide and Reference Manual

**AMERICAN AUDIO**  
4295 Charter Street  
Los Angeles Ca. 90058  
[www.AmericanAudio.us](http://www.AmericanAudio.us)

12/06

MAIN FEATURES.....	2
ELECTRICAL PRECAUTIONS.....	4
SAFETY PRECAUTIONS.....	5
INTRODUCTION.....	6
SET-UP PRECAUTIONS.....	6
UNPACKING.....	7
QUICK START.....	7
FUNCTIONS AND CONTROLS	
FRONT PANEL.....	8
REAR PANEL.....	11
CLEANING.....	16
CROSSFADER REPLACEMENT.....	16
TROUBLESHOOTING.....	17
WARRANTY.....	18
SPECIFICATIONS.....	19

**Q-2411 PRO****MAIN FEATURES**

- Feather Fader Plus for Q-Start Control
- 3 Phono, 5 Line, 3 Auxiliaries & 2 Mic Inputs
- 5 Band EQ for Master Output
- High quality Feather Fader™ for smooth, clean cross fades (replaceable)
- 2 Independent Microphones with Separate EQ with combo connection (1/4"/XLR) -
- Cue mixing
- Left & right turntable ground connectors conveniently located at each end of the rear panel
- On/Off switch for channel assign
- Gain control for each channel
- 115v/230v selectable
- Q-Start Compatible (for use with American Audio CD Players with Fader "Q" Start)
- 1 year limited warranty
- Master Level Indicator
- Balanced XLR Output
- High level headphone output
- Pre Fader Levels (PFL) for each channel

**WARNING: TO PREVENT FIRE OR ELECTRIC SHOCK HAZARD, DO NOT EXPOSE THIS UNIT TO RAIN, LIQUIDS, OR MOISTURE**

**CAUTION: TO PREVENT ELECTRIC SHOCK DO NOT USE THIS (POLARIZED) PLUG WITH AN EXTENSION CORD, RECEPTACLE, OR OTHER TYPE OF ELECTRICAL OUTLET UNLESS THE WIDE BLADES CAN BE CAREFULLY INSERTED INTO A MATCHING WIDE SLOT.**

**ATTENTION: POUR PREVENIR LES CHOCS ELECTRIQUES NE PAS UTILISER CETTE FICHE POLARISEE AVEC UN PROLONGATEUR, UNE PRISE DE COURANT OU UNE AUTRE SORTIE DE COURANT, SAUF SI LES LAMES PEUVENT ETRE INSEREES A FOND SANS EN LAISSER AUCUNE PARTIE A DECOUVERT.**



**NOTE:** This product satisfies FCC regulations when shielded cables and connectors are used to connect the unit to other equipment. To prevent electromagnetic interference with electrical appliances such as radios and televisions, use shielded cables and connectors for connections.

**LINE VOLTAGE SELECTION**

- The desired voltage may be set with the **VOLTAGE SELECTOR** switch on the rear panel (using a flat head screw driver).
- Do not force the **VOLTAGE SELECTOR** switch as this may cause damage
- If the **VOLTAGE SELECTOR** switch does not move smoothly, please contact a qualified service technician.

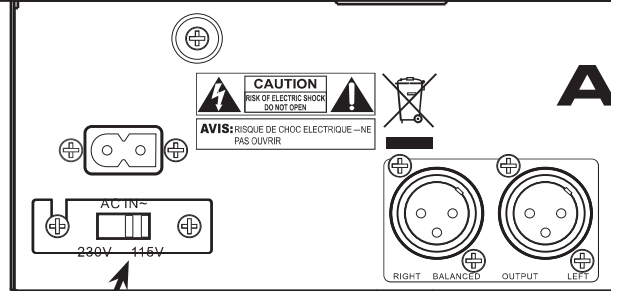

VOLTAGE SELECTOR SWITCH

The serial and model number for this unit is located on the rear panel. Please write down the numbers here and retain for future reference.

Model No. \_\_\_\_\_

Serial No. \_\_\_\_\_

Purchase Notes:

Date of Purchase \_\_\_\_\_

Dealer Name \_\_\_\_\_

Dealer Address \_\_\_\_\_

Dealer Phone \_\_\_\_\_

ELECTRICAL PRECAUTIONS



The lightning flash with arrowhead symbol, within an equilateral triangle, is intended to alert the user to the presence of uninsulated "dangerous voltage" within the product's enclosure that may be of sufficient magnitude to constitute a risk of electric shock to persons.



CAUTION: TO REDUCE THE RISK OF ELECTRIC SHOCK, DO NOT REMOVE THE COVER (OR BACK). THERE ARE NO USER SERVICEABLE PARTS INSIDE. REFER SERVICE TO YOUR AUTHORIZED AMERICAN AUDIO® SERVICE TECHNICIAN.



The exclamation point within an equilateral triangle is intended to alert the user to the presence of important operating and maintenance (servicing) instructions in the literature accompanying the appliance.

IMPORTANT SAFETY INSTRUCTIONS

**READ INSTRUCTIONS** — All the safety and operating instructions should be read before the product is operated.

**RETAIN INSTRUCTIONS** — The safety and operating instructions should be retained for future reference.

**HEED WARNINGS** — All warnings on the product and in the operating instructions should be adhered to.

**FOLLOW INSTRUCTIONS** — All operating and use instructions should be followed.

**CLEANING** — The product should be cleaned only with a polishing cloth or a soft dry cloth. Never clean with furniture wax, benzine, insecticides or other volatile liquids since they may corrode the cabinet.

**ATTACHMENTS** — Do not use attachments not recommended by the product manufacturer as they may cause hazards.

**WATER AND MOISTURE** — Do not use this product near water — for example, near a bathtub, wash bowl, kitchen sink, or laundry tub; in a wet basement; or near a swimming pool; and the like.

**ACCESSORIES** — Do not place this product on an unstable cart, stand, tripod, bracket, or table. The product may fall, causing serious injury to a child or adult, and serious damage to the product. Use only with a cart, stand, tripod, bracket, or table recommended by the manufacturer, or sold with the product. Any mounting of the product should follow the manufacturer's instructions, and should use a mounting accessory recommended by the manufacturer.

**CART** — A product and cart combination should be moved with care. Quick stops, excessive force, and uneven surfaces may cause the product and cart combination to overturn.



**VENTILATION** — Slots and openings in the cabinet are provided for ventilation and to ensure reliable operation of the product and to protect it from overheating, and these openings must not be blocked or covered. The openings should never be blocked by placing the product on a bed, sofa, rug, or other similar surface. This product should not be placed in a built-in installation such as a bookcase or rack unless proper ventilation is provided or the manufacturer's instructions have been adhered to.

**POWER SOURCES** — This product should be operated only from the type of power source indicated on the marking label. If you are not sure of the type of power supply to your home, consult your product dealer or local power company.

**LOCATION** — The appliance should be installed in a stable location.

**NONUSE PERIODS** — The power cord of the appliance should be unplugged from the outlet when left unused for a long period of time.

**GROUNDING OR POLARIZATION**

- If this product is equipped with a polarized alternating current line plug (a plug having one blade wider than the other), it will fit into the outlet only one way. This is a safety feature. If you are unable to insert the plug fully into the outlet, try reversing the plug. If the plug should still fail to fit, contact your electrician to replace your obsolete outlet. Do not defeat the safety purpose of the polarized plug.

- If this product is equipped with a three-wire grounding type plug, a plug having a third (grounding) pin, it will only fit into a grounding type power outlet. This is a safety feature. If you are unable to insert the plug into the outlet, contact your electrician to replace your obsolete outlet. Do not defeat the safety purpose of the grounding type plug.

**POWER-CORD PROTECTION** - Power-supply cords should be routed so that they are not likely to be walked on or pinched by items placed upon or against them, paying particular attention to cords at plugs, convenience receptacles, and the point where they exit from the product.

**OUTDOOR ANTENNA GROUNDING** — If an outside antenna or cable system is connected to the product, be sure the antenna or cable system is grounded so as to provide some protection against voltage surges and built-up static charges. Article 810 of the National Electrical Code, ANSI/NFPA 70, provides information with regard to proper grounding of the mast and supporting structure, grounding of the lead-in wire to an antenna discharge unit, size of grounding conductors, location of antenna-discharge unit, connection to grounding electrodes, and requirements for the grounding electrode. See Figure A.

**LIGHTNING** — For added protection for this product during a lightning storm, or when it is left unattended and unused for long periods of time, unplug it from the wall outlet and disconnect the antenna or cable system. This will prevent damage to the product due to lightning and power-line surges.

**POWER LINES** — An outside antenna system should not be located in the vicinity of overhead power lines or other electric light or power circuits, or where it can fall into such power lines or circuits. When installing an outside antenna system, extreme care should be taken to keep from touching such power lines or circuits as contact with them might be fatal.

**OVERLOADING** — Do not overload wall outlets, extension cords, or integral convenience receptacles as this can result in a risk of fire or electric shock.

**OBJECT AND LIQUID ENTRY** - Never push objects of any kind into this product through openings as they may touch dangerous voltage points or short-out parts that could result in a fire or electric shock. Never spill liquid of any kind on the product.

**SERVICING** — Do not attempt to service this product yourself as opening or removing covers may expose you to dangerous voltage or other hazards. Refer all servicing to qualified service personnel.

**DAMAGE REQUIRING SERVICE** - Unplug this product from the wall outlet and refer servicing to qualified service personnel under the following conditions:

- When the power-supply cord or plug is damaged.
- If liquid has been spilled, or objects have fallen into the product.
- If the product has been exposed to rain or water.
- If the product does not operate normally by following the operating instructions. Adjust only those controls that are covered by the operating instructions as an improper adjustment of other controls may result in damage and will often require extensive work by a qualified technician to restore the product to its normal operation.
- If the product has been dropped or damaged in any way.
- When the product exhibits a distinct change in performance — this indicates a need for service.

**REPLACEMENT PARTS** -- When replacement parts are required, be sure the service technician has used replacement parts specified by the manufacturer or have the same characteristics as the original part. Unauthorized substitutions may result in fire, electric shock, or other hazards.

**SAFETY CHECK** - Upon completion of any service or repairs to this product, ask the service technician to perform safety checks to determine that the product is in proper operating condition.

**WALL OR CEILING MOUNTING** — The product should not be mounted to a wall or ceiling.

**HEAT** — The product should be situated away from heat sources such as radiators, heat registers, stoves, or other products (including amplifiers) that produce heat.

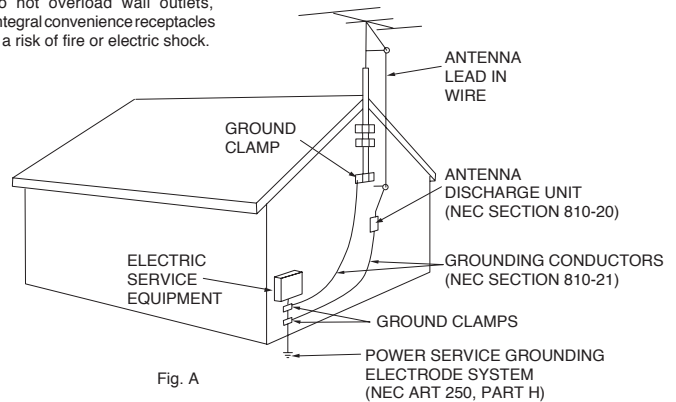

Fig. A

NEC — NATIONAL ELECTRICAL CODE

1. For adult use only - Keep out of the reach of children.
2. Water and Moisture - The player should not be used near water - for example, near a bath tub, kitchen sink, laundry tub, in a wet basement or near a swimming pool, etc. Do not spill water or other liquids in to or on to your mixer.
3. Ventilation - The Mixer should be situated so that its location or position does not interfere with its proper ventilation. For example, the Mixer should not be situated on a bed, sofa, rug, or similar surface that may block the ventilation openings; or, placed in a built-in installation, such as a bookcase or cabinet that may impede the flow of air through the ventilation openings.
4. Heat - The Mixer should be situated away from heat sources such as radiators, heat registers, stoves, or other appliances (including amplifiers) that produce heat.
5. Power Sources - The Mixer should be connected to a power supply (wall outlet) only of the type described in the operating instructions or as marked on the Mixer.
6. Servicing -The user should not attempt to service the Mixer beyond that described in the operating instructions. There are no user serviceable parts inside. All other servicing should be referred to qualified service personnel. The Player should be serviced by qualified service personnel when:
  - A. The power-supply cord or the plug has been damaged.
  - B. Objects have fallen, or liquid has been spilled into the Mixer.
  - C. The Mixer has been exposed to rain or water.
  - D. The Mixer does not appear to operate normally or exhibits a marked change in performance.
7. Never disassemble or modify your unit in any way, doing so will void your manufactures warranty.
8. Never plug this mixer in to a dimmer pack.
9. Do not let insecticides, benzene, or thinner come in contact with the surface of the unit.
10. This unit is intended for indoor use only, use of this product outdoors voids all warranties.
11. Always mount this unit in safe and stable matter.
12. Disconnect from main power before making any type of connection.
13. Cleaning - The mixer should be cleaned only as recommended by the manufacturer. Use a soft cloth to wipe down the outside of the unit. For stubborn stains moisten a soft cloth with glass cleaner or other mild detergent to wipe away any stains. Use a soft cloth to wipe any residual cleaner. Never use volatile cleaners such as benzene, solvent, or thinner to clean your unit, these cleaners will damage the units surface.
14. Handle the power supply cord carefully. Do not damage or deform; it may cause electric shock or malfunction when used. Hold plug attachment when removing from wall outlet. Do not pull on the cord.
15. To avoid electric shock, do not open the top cover when the unit is plugged in. If problems occur with the unit, call American Audio® customer support.
16. Do not place metal objects or spill any liquids inside or on the mixer. Electric shock or malfunction may occur.
17. Power Cord Protection - Power supply cords should be routed so that they are not likely to be walked on or pinched by items placed upon or against them, paying particular attention to cords at plugs, convenience receptacles, and the point where they exit from the mixer. Route your power cord out of the way of foot traffic.
18. Always have the front gain controls set to their lowest level during initial power-up to prevent speaker damage.



**Introductions:** Congratulations and thank you for purchasing the American Audio® Q-2411 PRO mixer. This mixer is a representation of American Audio's continuing commitment to produce the best and highest quality audio products possible at an affordable price. Please read and understand this manual completely before attempting to operate your new mixer. Please carefully read and understand the instructions in this manual thoroughly before attempting to operate this unit. These instructions contain important safety information regarding the use and maintenance of this unit. Take special care to follow all warning symbols and labels both on the unit and printed in this manual. Also, Please keep this manual with the unit, for future reference.

**Customer Support:**

American Audio® provides a toll free customer support line, to provide set up help and answer any question should you encounter problems during your initial set up or operation. You may also visit us on the web at [www.americanaudio.us](http://www.americanaudio.us) for any comments or suggestions. Service Hours are Monday through Friday 9:00 a.m. to 5:30 p.m. Pacific Standard Time.

Voice: (800) 322-6337  
Fax: (323) 582-2941  
E-mail: [support@americanaudio.com](mailto:support@americanaudio.com)

To purchase parts online visit <http://parts.americandj.com>

**Caution!** There are no user serviceable parts inside this mixer. Do not attempt any repairs yourself, without being instructed to do so by an authorized American Audio service technician. Doing so will void your manufactures warranty. In the unlikely event your mixer may require service, please contact American Audio® customer support.

Do not discard the packing carton in the trash. Please recycle when ever possible.

Please be sure to make any connections before plugging the mixer in to an electrical outlet. All fader and volume controls should be set to zero or minimum position, before the mixer is switched on. If the mixer has been exposed to drastic temperature fluctuation (e.g. after transportation), do not switch on the mixer immediately. The arising condensation of water might damage your device. Leave the device switched off until it has reached room temperature.

**Operating Determinations:**

- When installing this mixer, please make sure that the device is not exposed or will not be exposed to extreme heat, moisture or dust!
- Do not operate the mixer in extremely hot (more than 30°/100°F) or extremely cold (less than 5°C/40°F) surroundings.
- Keep the unit out of direct sunlight and away from heaters.
- Operate the mixer only after becoming familiar with its functions. Do not permit operation by persons not qualified for operating the mixer. Most damages are the result of unprofessional operation!
- Do not attempt to operate this mixer if the power cord has been frayed or damaged.
- Disconnect from main power before making any type of connection.
- Do not attempt to operate this mixer, if it becomes damaged in any way.
- Never operate this mixer when it's covers are removed.
- To reduce the risk of electrical shock or fire, do not expose this mixer to rain or moisture.
- This mixer is intended for indoor use only, use of this product outdoors voids all warranties.
- During long periods of non-use, disconnect the mixer's main power.

Every Q-2411 PRO has been thoroughly tested and has been shipped in perfect operating condition. Carefully check the shipping carton for damage that may have occurred during shipping. If the carton appears to be damaged, carefully inspect your mixer for any damage and be sure all equipment necessary to operate the mixer has arrived intact. In the event damage has been found or parts are missing, please contact our toll free customer support number for further instructions. Please do not return the mixer to your dealer without first contacting customer support.

**QUICK START:** American Audio® would like to thank you for your purchase of this great audio product. For those of you that don't have the time to read the entire user manual we have compiled these quick start instructions. We hope that you will at least read through these instructions to familiarize yourself with the basics of this mixer. The Q-2411 PRO is part of American Audio's continuing evolution in audio technology. This unit has been built and designed to meet the needs of a typical DJ. We have attempted to provide you with the most reliable product on the market by using only components constructed of the finest material.

**MASTER LEVEL** - Use this level to control your main volume output. Try never to send an output of more than +4dB to your system. Signal at levels higher than this will start to distort and may cause damage to your system and speakers. Remember that a distorted signal from your mixer will only be multiplied throughout your system.

**CHANNEL GAIN LEVEL** - The channel gain levels are not to be used as volume controls. Never use the channel trim to set the output volume. These controls are used to aid in distortion control. Use these control to preset your signal level before the crossfader. With your channel faders in the maximum position, use the channel trim level to set an average output level of about +4dB on your master level meter.

**HEADPHONES** - To avoid damaging your headphones always be sure the headphone volume level (12) is set to minimum before plugging them in. To avoid severe hearing damage, never put the headphone on without making sure the headphone level is turned down.

**MAIN MIC** - The main mic connector uses a combo plug that allows you to connect either a 1/4" unbalanced jack or by a standard 3-pin XLR balanced connector. The main mic also has an independent volume control. When feedback occurs when using the mic, try lowering the level this may reduce the feedback. Always leave the mic level to its minimum level when not in use. **Note: We recommend that you use a 500-600ohm microphone for the best sound quality.**

**PHONO/AUX LINE LEVEL SELECTOR SWITCH** - This switch is used to change the selected input from phono to line and vice versa. The switch selectors are on the rear panel.

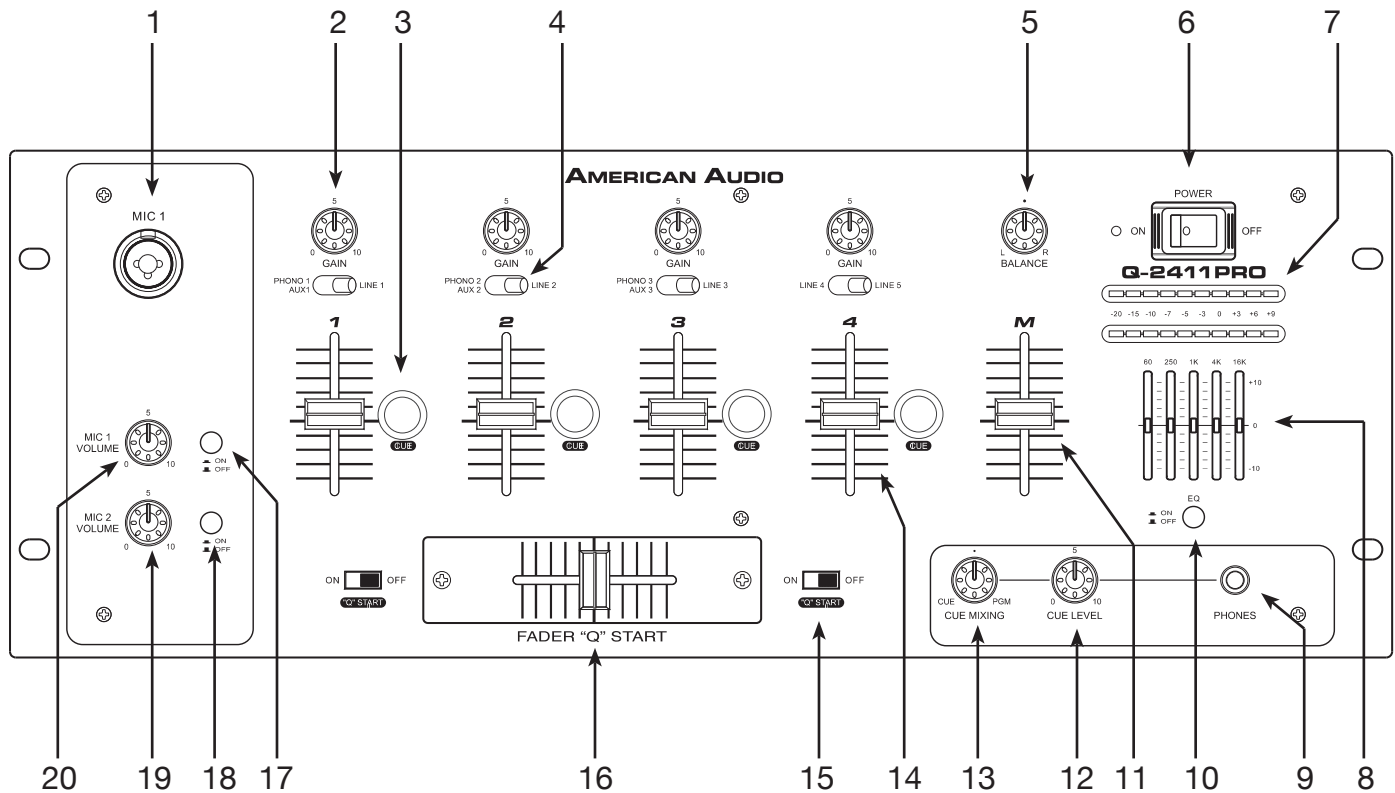

**1. MICROPHONE 1** - This combo jack will accept a standard 1/4 plug or XLR 3-pin balanced male plug. The volume output level for this microphone will be controlled by its own respective *CHANNEL KNOB* (20). **Note: We recommend that you use a 500-600ohm microphone for the best sound quality.**

**2. CHANNEL GAIN CONTROL** - This adjustment is used to adjust the audio source signal input gain for a channel. Never use the gain control to adjust a channels output volume. Setting the gain level properly will ensure a clean output signal. An improper gain level adjustment will send a distorted signal throughout the entire audio line which may damage speakers and amplifiers. To properly set a channels gain level control:

1. Be sure the *MASTER VOLUME CONTROL* (11) is set to level 8.
2. Set the *CHANNEL FADER* (14) to level 8.
3. Begin playback on an audio source connected to the channel you are adjusting.
4. Use the Gain Control to adjust an average output volume of +4 dB.
5. Repeat this step for all channels

**3. CUE BUTTON** - These buttons are used to activate a channels "CUE" mode. A red LED on the Cue button will glow when a channels cue mode is activated. The Cue function sends a channels incoming signal to the headphones. The cue level is adjusted by the *CUE LEVEL KNOB* (12). Be sure the *CUE MIXING KNOB* (13) is set to the "CUE" position to hear a selected channel source.

**4. SOURCE SELECTOR SWITCH** - These switches are used to select the input source assigned to



each channel. Each channel may only be assigned one input source at a time. This switch must be in the "phono" position for turntable operation.

**5. MASTER OUTPUT BALANCE CONTROL** - This knob is used to control the pan, adjust how much of the signal is sent to the left and right output level. For true stereo imaging, maintain the knob in the 12 o' clock position.

**6. POWER SWITCH** - This is the main power ON/OFF button. A red LED next to the power switch will glow when power is ON. Before you turn the power on be sure you have made all connections to the mixer. Also be sure you amplifiers are turned off. Remember mixer on first and turned off last.

**7. MASTER VOLUME LEVEL INDICATORS** - The dual MASTER LEVEL LED indicators are used to detail the master fader output level. The meters will detail the output level of both the left and right channels.

**8. 5-BAND GRAPHIC EQUALIZER** - Used to fine-tune the master output. The frequencies are as follows: 60Hz, 250Hz, 1KHz, 4KHz, and 16KHz. They can be adjusted by +/-10 dB.

**9. HEADPHONE JACK** - This jack is used to connect your headphones to the mixer allowing you to monitor the cue source. Use headphones only rated at 8 ohms to 32 ohms. Most DJ headphones are rated at 16 ohm, these are highly recommended. Always be sure the *CUE LEVEL VOLUME (12)* is set to minimum before you put the headphones on.

**10. EQUALIZER SWITCH** - This button is used to switch the equalizer on or off.

**11. MASTER VOLUME CONTROL** - This slider is used to control the master output level (main volume). To avoid distorted output try to maintain an average output signal level no greater than +4 dB. (see Channel Gain 2) To avoid speaker damage that may be caused by excessive volume, be sure this slider is always set to zero (completely down) before turning the unit on.

**12. CUE LEVEL VOLUME CONTROL** - This knob is used to adjust the headphone volume output level. Turn the knob in a clockwise direction to increase the headphone volume.

**13. CUE MIXING CONTROL** - This functions allows you to monitor the Cue level as well as the Program (main output) level in your headphones. A channels Cue Level may only be monitored if the channels *CUE (3)* function is selected. To select a channels cue function press the *CUE BUTTON (3)* that is directly associated with the specific channel you wish to monitor. You may use the mixing function to blend both the Cue level and the Program level together. You can vary the output level to either hear more or less of either of the two levels. Sliding the Cue Mixing fader to the CUE position (left) will allow you to hear more of the Cue level. Sliding the knob to the PGM position (right) will allow you to hear more of the Program level (main output). You may also use the Cue Mixing Control to hear either the Cue level or the Program level exclusively. If the fader is in the full CUE position you will only hear the cue level, if the fader is in the full PGM position you will only hear the main output. This function is especially useful when mixing without a monitor.

**14. CHANNEL VOLUME FADER** - These faders are used to control the output signal of any source assigned to its particular channel. However, master volume is controlled by the *MASTER VOLUME CONTROL (11)*.

**15. Q-START ON/OFF BUTTON** - This function works in conjunction with a compatible American DJ® or American Audio® "Q" Start CD player. When used with a compatible CD player, you can use the crossfader to start and stop a CD Player with the slide of the mixer's *CROSSFADER (16)*. The ON/OFF "Q" START BUTTTON activates the FADER "Q" START feature. When in the ON position (RED LED WILL BE LIT), the FADER "Q" START automatically returns the CD player to the preset CUE POINT.

For example; Assuming you have two compatible American Audio™ CD players or a compatible dual CD player connected to channels one and two. When the Fader "Q" Start option is turned on, sliding the crossfader to the far left position will trigger playback on CD player 1. When the crossfader is pushed to the far right position, playback on CD player 2 will begin, and CD player 1 will return to the cue position. Refer to your American Audio CD player user manual for setting CUE POINTS. Turn the ON/OFF BUTTON to the OFF position (RED LED IS NOT LIT) to disengage "Q" Start function and resume to a normal fader.

**16. FEATHER FADER PLUS CROSSFADER** - This fader is used to blend the output signals of channels one and two together. When the fader is in the full left position (channel 1), the output signal of channel one will be controlled by the master volume level. The same fundamentals will apply for channel two. Sliding the fader from one position to another will vary the output signals of channels one and two respectively. When the crossfader is set in the center position, the output signals of both the channels one and channels two will be even.

**17. MIC 1 ON/OFF BUTTON** - This button is used to turn Microphone 1 "On" or "Off".

**18. MIC 2 ON/OFF BUTTON** - This button is used to turn Microphone 2 "On" or "Off".

**19. MIC 2 VOLUME CONTROL** - This knob controls the output volume of *MICROPHONE 2 (22)*. However, master volume is controlled by the *MASTER VOLUME CONTROL (11)*.

**20. MIC 1 VOLUME CONTROL** - This knob controls the output volume of *MICROPHONE 1 (1)*. However, master volume is controlled by the *MASTER VOLUME CONTROL (11)*.

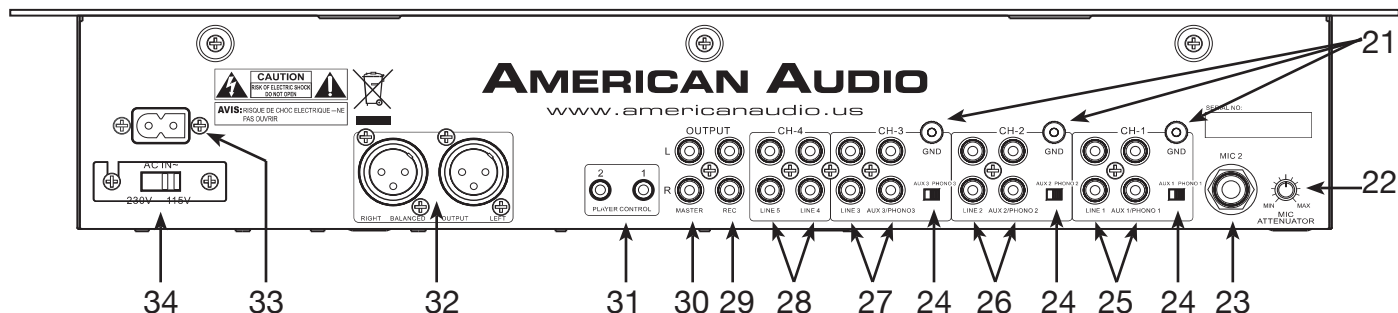

**21. GND (GROUND TERMINAL)** - Be sure to connect turntable ground leads to either or both of the two available ground terminals. This will reduce the humming and popping noises associated with magnetic phono cartridges.

**22. MIC ATTENUATOR** - This knob is used to adjust the MIC 1 and MIC 2 input level.

**23. MICROPHONE 2 CONNECTOR** - This jack is used to connect a microphone to the mixer. Connect your microphone via this 1/4 inch (6.3mm) jack. The volume output level for this microphone will be controlled by its own respective CHANNEL KNOB (19).

**24. CHANNEL LINE LEVEL SELECTOR SWITCHES** - These switches are used to change the voltage line levels of their respective Phono / Aux RCA input jacks. When connecting turntables with magnetic cartridges to these jacks be sure the corresponding switch is in the "PHONO" position, and when using line level input devices be sure this switch is in the "AUX" position. Always be sure main power is shut off before change the position of the Line Level Selector Switch.

**25. CHANNEL 1: PHONO 1/AUX 1 INPUT** - The type of input must directly reflect the selected mode of the LINE LEVEL SELECTOR SWITCH (24). Turntables equipped with MM pickup cartridge (All DJ turntable use MM pick-up cartridges) may be connected to these jacks as long as the LINE LEVEL SELECTOR SWITCH (24) is in the "PHONO 1" position. CD players, Tape Decks and other line level instruments may only be connected to these jacks as long as the LINE LEVEL SELECTOR SWITCH (24) is in the "AUX 1" position. Never connect line level instruments (CD players, tape decks, etc.) to these jacks when the LINE LEVEL SELECTOR SWITCH (24) is in the "PHONO 1" position, *THIS MAY SERIOUSLY DAMAGE YOUR MIXER!* The red colored RCA jack represents the right channel input and the white represents the left channel input. Input volume will be controlled by the channel one fader. The channel SOURCE SELECTOR SWITCH (4) must be in the "Phono 1/Aux 1" position, to monitor any source connected to these jacks.

**CHANNEL 1: LINE 1 INPUT JACKS - DO NOT CONNECT TURNTABLES TO THESE JACKS!** CD players, Tape Decks and other line level instruments may be connected to these jacks. The red colored RCA jack represents the right channel input and the white represents the left channel input. Input volume will be controlled by channel one fader. The channel SOURCE SELECTOR SWITCH (4) must be in the "Line 1" position, to monitor any source connected to these jacks.

**26. CHANNEL 2: PHONO 2/AUX 2 INPUT** - The type of input must directly reflect the selected mode of the LINE LEVEL SELECTOR SWITCH (24). Turntables equipped with MM pickup cartridge (All DJ turntable use MM pick-up cartridges) may be connected to these jacks as long as the LINE LEVEL SELECTOR SWITCH (24) is in the "PHONO 2" position. CD players, Tape Decks and other line level instruments may only be connected to these jacks as long as the LINE LEVEL SELECTOR SWITCH (24) is in the "AUX 2" position. Never connect line level instruments (CD players, tape

decks, etc.) to these jacks when the *LINE LEVEL SELECTOR SWITCH (24)* is in the "PHONO 2" position, *THIS MAY SERIOUSLY DAMAGE YOUR MIXER!* The red colored RCA jack represents the right channel input and the white represents the left channel input. Input volume will be controlled by the channel two fader. The channel *SOURCE SELECTOR SWITCH (4)* must be in the "Phono 2/Aux 2" position, to monitor any source connected to these jacks.

**CHANNEL 2: LINE 2 INPUT JACKS - DO NOT CONNECT TURNTABLES TO THESE JACKS!** CD players, Tape Decks and other line level instruments may be connected to these jacks. The red colored RCA jack represents the right channel input and the white represents the left channel input. Input volume will be controlled by channel two fader. The channel *SOURCE SELECTOR SWITCH (4)* must be in the "Line 2" position, to monitor any source connected to these jacks.

**27. CHANNEL 3: PHONO 3/AUX 3 INPUT** - The type of input must directly reflect the selected mode of the *LINE LEVEL SELECTOR SWITCH (24)*. Turntables equipped with MM pickup cartridge (All DJ turntable use MM pick-up cartridges) may be connected to these jacks as long as the *LINE LEVEL SELECTOR SWITCH (24)* is in the "PHONO 3" position. CD players, Tape Decks and other line level instruments may only be connected to these jacks as long as the *LINE LEVEL SELECTOR SWITCH (24)* is in the "AUX 3" position. Never connect line level instruments (CD players, tape decks, etc.) to these jacks when the *LINE LEVEL SELECTOR SWITCH (24)* is in the "PHONO 3" position, *THIS MAY SERIOUSLY DAMAGE YOUR MIXER!* The red colored RCA jack represents the right channel input and the white represents the left channel input. Input volume will be controlled by the channel three fader. The channel *SOURCE SELECTOR SWITCH (4)* must be in the "Phono 3/Aux 3" position, to monitor any source connected to these jacks.

**CHANNEL 3: LINE 3 INPUT JACKS - DO NOT CONNECT TURNTABLES TO THESE JACKS!** CD players, Tape Decks and other line level instruments may be connected to these jacks. The red colored RCA jack represents the right channel input and the white represents the left channel input. Input volume will be controlled by channel three fader. The channel *SOURCE SELECTOR SWITCH (4)* must be in the "Line 3" position, to monitor any source connected to these jacks.

**28. CHANNEL 4: LINE 4 INPUT JACKS - DO NOT CONNECT TURNTABLES TO THESE JACKS!** These Jacks are used for line level inputs. Connect CD players, Tape Decks and other line level instruments may be connected to these jacks. The red colored RCA jack represents the right channel input and the white represents the left channel input. Input volume will be controlled by channel four fader. The channel *SOURCE SELECTOR SWITCH (4)* must be in the "Line 4" position, to monitor any source connected to these jacks.

**CHANNEL 4: LINE 5 INPUT JACKS - DO NOT CONNECT TURNTABLES TO THESE JACKS!** These Jacks are used for line level inputs. Connect CD players, Tape Decks and other line level instruments may be connected to these jacks. The red colored RCA jack represents the right channel input and the white represents the left channel input. Input volume will be controlled by channel four fader. The channel *SOURCE SELECTOR SWITCH (4)* must be in the "Line 5" position, to monitor any source connected to these jacks..

**29. REC OUT** - This is a low current unbalanced output source designed for various tape and CD recorders. The Record Out (REC OUT) level is dictated by the *CHANNEL FADER LEVEL (14)*, it is not influenced by the *MASTER VOLUME CONTROL (11)*.

**30. RCA MASTER OUTPUTS** - The Master Output includes a pair *XLR BALANCED JACKS (32)* as well as a pair of RCA Unbalanced Jacks. The RCA jacks send a low current unbalanced output signal. These jacks should only be used for shorter cable runs to signal processors or looping to another mixer. For cable runs greater than 15 feet use the *XLR BALANCED JACKS (32)*.

**31. PLAYER CONTROL -**

**PLAYER 1 CONTROL** - This jack is used to control the “Q-Start” function between the mixer and a compatible American Audio® or American DJ® CD Player. Using the mini plug included with your CD player, connect from the CD player controller out jack to this jack. Player A “Q-Start” functionality will be controlled by the left side of the *CROSSFADER (16)*. For more information on “Q-Start” functionality refer to the user manual included with your CD player. Be sure to only use the mono tip mini plug included with your CD player to avoid damage to the mixer and/or the CD player.

**PLAYER 2 CONTROL** - This jack is used to control the “Q-Start” function between the mixer and a compatible American Audio® or American DJ® CD Player. Using the mini plug included with your CD player, connect from the CD player controller out jack to this jack. Player B “Q-Start” functionality will be controlled by the right side of the *CROSSFADER (16)*. For more information on “Q-Start” functionality refer to the user manual included with your CD player. Be sure to only use the mono tip mini plug included with your CD player to avoid damage to the mixer and/or the CD player.

**32. BALANCED XLR MASTER OUTPUTS JACKS** - The Master Output includes a pair of XLR Balanced jacks as well as a pair of *RCA UNBALANCED JACKS (30)*. The 3-pin XLR jacks send a high current balanced output signal. These jacks should be used when you will be driving an amp or other audio equipment with a balanced input, or whenever you will be running a signal line greater than 15 feet. Always, use these jacks whenever possible.

**33. AC CONNECTION** - This connector is used to supply main power to the unit via the included detachable power cord. The power connection uses an I.E.C. type connector, use only the supplied, polarized AC power cord. Use only a power cord that matches this type of connection. Be sure to only connect this unit to a power outlet that matches the printed power label on the unit. Never use a power cord when the ground prong has been removed or broken off. The ground prong is used to reduce the risk of electrical shock in case of an electrical short. This cord is designed to fit in one direction only. Do not attempt to force a cord if it does not fit, be sure the cord is being inserted properly.

**34. AC VOLTAGE SELECTOR** - This switch is used to change the operating voltage. Operating voltage can be toggled between 115v or 230v/50~60Hz. Be sure the selector is set to the proper voltage for your area before attempting to operate the unit. Always be sure main power is shut off before change the position of the Voltage Selector Switch.



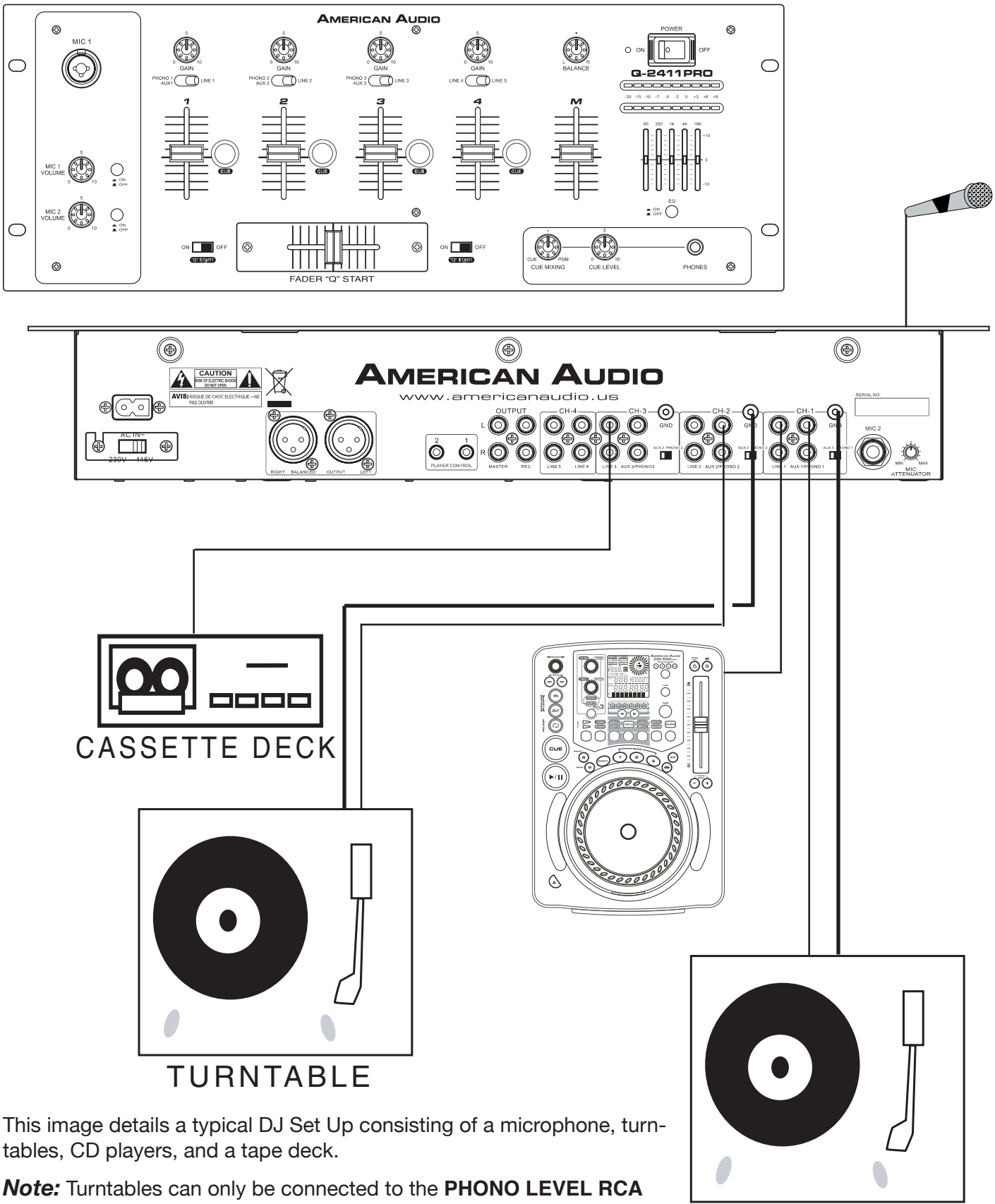

This image details a typical DJ Set Up consisting of a microphone, turntables, CD players, and a tape deck.

**Note:** Turntables can only be connected to the **PHONO LEVEL RCA JACKS**. Be sure the **LINE LEVEL SELECTOR SWITCHES** are in the "PHONO" position when using turntables.

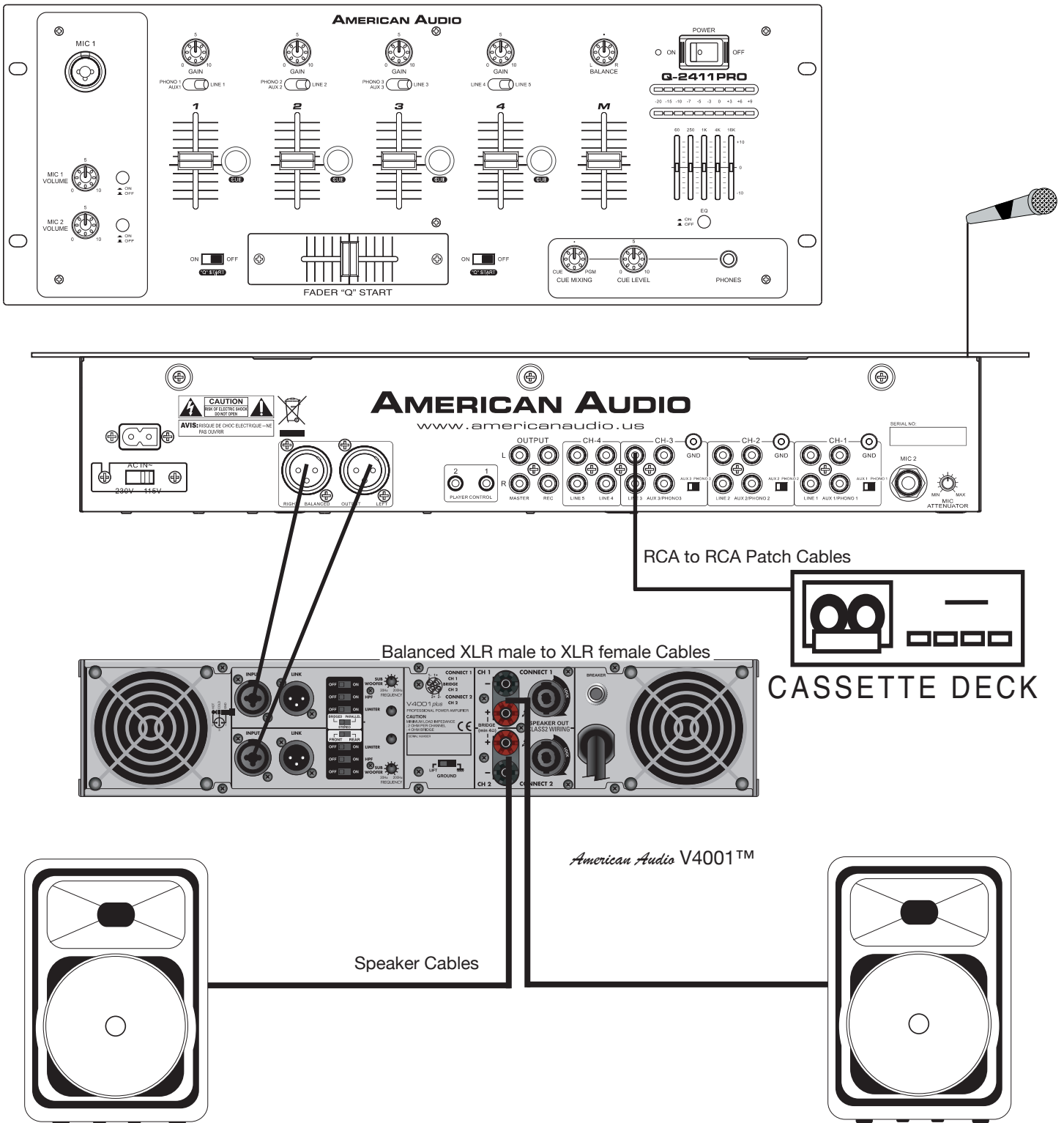

Typical Balanced Output Set-up

This image details a typical stereo output layout. Note the use of the Balanced XLR Jacks on both the mixer and the amplifier. Always use the balanced output jacks whenever possible. The balanced output jacks should always be used for cable runs in excess of 15 feet.

Using the balanced jacks will ensure a clean signal through out the entire audio system.

Due to fog residue, smoke, and dust, cleaning the mixer should be carried out periodically to residue build up.

1. Use normal glass cleaner and a soft cloth to wipe down the outside casing.
2. Use a cleaner specially designed for electronics to spray in and around the knobs and switch.  
This will reduce small particle built up that can effect the proper operation of the mixer.
3. Cleaning should be carried out every 30-60 days to prevent heavy built up.
4. Always be sure to dry all parts completely before plugging the mixer in.

Cleaning frequency depends on the environment in which the mixer operates (i.e. smoke, fog residue, dust, dew).

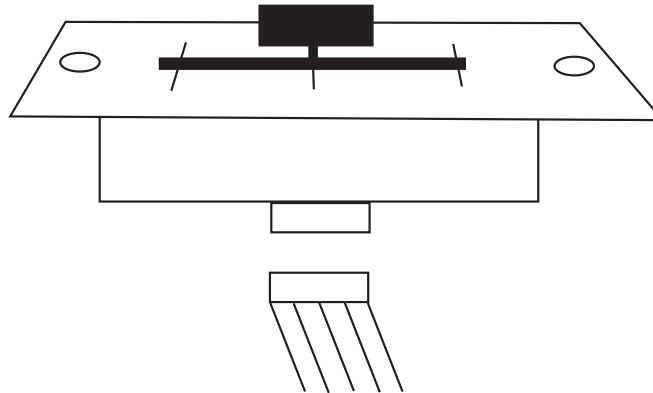

The crossfader is “Hot Swapable” which means it may be replaced at any time, even when power is applied. Only replace with American Audio Part Feather Fader Plus. Replacing with any other model fader may seriously damage your mixer.

#### Replacing the Crossfader:

1. Disconnect the mixers main power supply
2. Using a number two Phillips screw driver, unscrew the each of the stainless steel retain screws that hold the crossfader in place.
3. Gently remove the crossfader from its seated position. You may need to wiggle the crossfader slightly to remove it.
4. After removing the crossfader, disconnect the ribbon cable that attaches the crossfader to the PC board. Grasp the crossfader by its base and pull the ribbon cable by its connector not the actual cables. The connector is designed to only fit one way, so don't worry about the connectors orientation.
5. Connect the new crossfader to the ribbon cable and replace in reverse order.

**Trouble Shooting:** Listed below are common problems you may encounter, and solutions.

***There is no power to the unit:***

1. Be sure you have connected the power cord to a correct wall outlet.

***There is little or no sound:***

1. Check the input selector switch. Make sure it is set to the device that is currently playing.
2. Check to see if the connection cables are connected properly.

***The sound is distorted:***

1. Make sure that the Gain level control is not set to high.

***Crossfader is not working:***

1. Check and see if any channels have been assigned to the crossfader.

The Q-2411 PRO carries a one year limited warranty. We recommend you fill out the enclosed warranty card to validate your purchase. All returned service items whether under warranty or not, must be freight pre-paid and accompany a R.A. (return authorization) number. If the mixer is under warranty, you must provide a proof of purchase invoice. You may obtain a R.A. number by contacting our customer support team on our toll free number. Please contact American Audio® customer support at (800) 322-6337 for a R.A. number. All package not displaying a R.A. number on the outside of the package will be returned to the shipper.

### **1-YEAR LIMITED WARRANTY**

A. American Audio® hereby warrants, to the original purchaser, American Audio® products to be free of manufacturing defects in material and workmanship for a period of 1 Year (365 days) from the date of purchase. This warranty shall be valid only if the product is purchased within the United States of America, including possessions and territories. It is the owner's responsibility to establish the date and place of purchase by acceptable evidence, at the time service is sought.

B. For warranty service, send the product only to the American Audio® factory. All shipping charges must be pre-paid. If the requested repairs or service (including parts replacement) are within the terms of this warranty, American Audio® will pay return shipping charges only to a designated point within the United States. If the entire instrument is sent, it must be shipped in its original package. No accessories should be shipped with the product. If any accessories are shipped with the product, American Audio® shall have no liability whatsoever for loss of or damage to any such accessories, nor for the safe return thereof.

C. This warranty is void if the serial number has been altered or removed; if the product is modified in any manner which American Audio® concludes, after inspection, affects the reliability of the product; if the product has been repaired or serviced by anyone other than the American Audio® factory unless prior written authorization was issued to purchaser by American Audio®; if the product is damaged because not properly maintained as set forth in the instruction manual.

D. This is not a service contract, and this warranty does not include maintenance, cleaning or periodic check-up. During the period specified above, American Audio® will replace defective parts at its expense, and will absorb all expenses for warranty service and repair labor by reason of defects in material or workmanship. The sole responsibility of American Audio® under this warranty shall be limited to the repair of the product, or replacement thereof, including parts, at the sole discretion of American Audio®. All products covered by this warranty were manufactured after January 1, 1990, and bear identifying marks to that effect.

E. American Audio® reserves the right to make changes in design and/or improvements upon its products without any obligation to include these changes in any products theretofore manufactured.

F. No warranty, whether expressed or implied, is given or made with respect to any accessory supplied with products described above. Except to the extent prohibited by applicable law, all implied warranties made by American Audio® in connection with this product, including warranties of merchantability or fitness, are limited in duration to the warranty period set forth above. And no warranties, whether expressed or implied, including warranties of merchantability or fitness, shall apply to this product after said period has expired. The consumer's and or Dealer's sole remedy shall be such repair or replacement as is expressly provided above; and under no circumstances shall American Audio® be liable for any loss or damage, direct or consequential, arising out of the use of, or inability to use, this product.

G. This warranty is the only written warranty applicable to American Audio® Products and supersedes all prior warranties and written descriptions of warranty terms and conditions heretofore published.



Model: Q-2411 4 Channel Mixer

**POWER SUPPLY:** AC 115v~60Hz/230v~50Hz, User Selectable  
 Single Voltage:  
 AC 100V, 50/60Hz (Japan)  
 AC 110V, 60Hz (Colombia)  
 AC 120V, 60Hz (U.S.A. and Canada)  
 AC 127V, 60Hz (Mexico)  
 AC 220V, 50Hz (Chile and Argentina)  
 AC 220V, 60Hz (Philippines and Korea)  
 AC 230V, 50Hz (Europe, U.K., New Zealand, South Africa, and Singapore)  
 AC 240V, 50Hz (Australia)

**DIMENSIONS:** 482.6mm (W) x 177mm (D) x 97mm (H)  
 19" (W) x 6.96" (D) x 3.8" (H)

**WEIGHT:** 6.6 Lbs. / 3.0Kgs.

**CROSSFADER:** Feather Fader Plus - VCA detecting fader start control -  
 Low grounding impedance crossfader

**POWER CONSUMPTION:** 12W typical, 20W w/ full headphone output

**HEADPHONE IMPEDANCE:** 16 Ohms

**OPERATING TEMPERATURE:** 5 to 35 deg. C; Humidity: 25 to 85% RH  
 (non-condensing); Storage Temperature: -20 to 60 deg. C

**Input Sensitivity (Level/Impedance):** Note: 0dBV output, load = 47K OHM

**LINE, AUX:** 10K/47K OHM / -14dBV (200mV) +/-2dB

**PHONO:** 47K OHM / -54dBV (2mV) +/-2dB

**MICROPHONE 1:** 2.2K OHM / -54dBV (2mV) +/-2dB

**MICROPHONE 2:** 2.2K OHM / -60dBV (1mV) +/-2dB

**Output Sensitivity (Level/Impedance):** Note: 0dBV=1Vrms

**MASTER:** 300 OHM

**MASTER OUT (XLR):** 600 OHM / 2.21dBm (1V) +/-2dB

**REC OUT (RCA):** 2.2K OHM / -10dBV (316mV) +/-2dB

**PHONES:** (LOAD=32 OHMS) 33 OHM, CUE IN / 0dBV (1V) +/-2dB

**Maximum Output:** (LOAD = 47K, THD = 1%)

**MASTER/ZONE:** MORE THAN 18 dBV (8.0V)

**PHONES:** (LOAD=32 ohms) MORE THAN 4 dBV (1.6V)

**CHANNEL BALANCE:** WITHIN 3dB

**Frequency Response:**

**LINE/AUX:** 20 - 20KHz +1 /-2dB

**PHONO:** 20 - 20KHz +2 /-3dB (RIAA)

**MICROPHONE:** 20 - 20KHz +2 /-3dB

**Noise:** (maximum output) IEC-A weighted

**LINE/AUX:** LESS THAN -90dBV

**PHONO:** LESS THAN -66dBV

**MIC 1:** LESS THAN -66dBV

**MIC 2:** LESS THAN -60dBV

**THD - Total Harmonic Distortion:** (MASTER = 0dBV OUTPUT, w/ 20KHz LPF, EQ Flat):

**LINE:** LESS THAN 0.02% 20 - 20KHz

**CROSS TALK:** (MASTER = 0dBV OUTPUT)

**LINE:** MORE THAN 65dB AT 1KHz BETWEEN L AND R

MORE THAN 70dB AT 1KHz BETWEEN CHANNELS

**EQ:**

**MASTER:** +10 +/-2dB AT 60, 250, 1K, 4K. and 16KHz

-10 +/-2dB AT 60, 250, 1K, 4K, and 16KHz

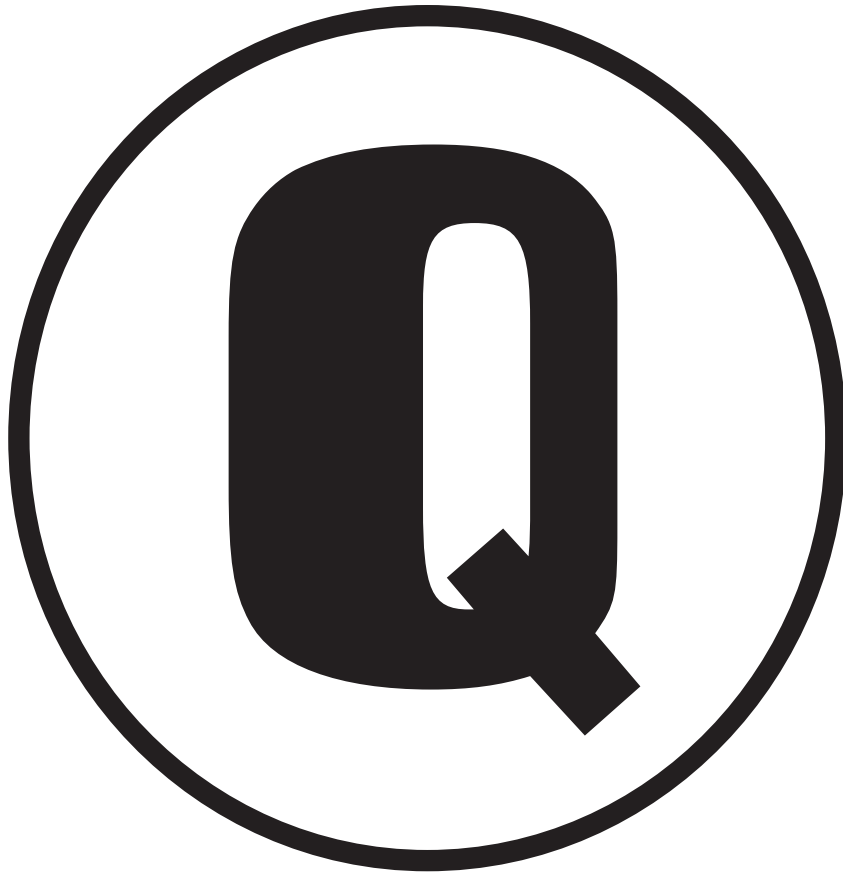

©American Audio® World Headquarters:  
4295 Charter Street Los Angeles, CA 90058 USA  
Tel: 323-582-3322 Fax: 323-582-2941  
Web: [www.americanaudio.us](http://www.americanaudio.us) E-mail: [info@americandj.com](mailto:info@americandj.com)

## Free Manuals Download Website

<http://myh66.com>

<http://usermanuals.us>

<http://www.somanuals.com>

<http://www.4manuals.cc>

<http://www.manual-lib.com>

<http://www.404manual.com>

<http://www.luxmanual.com>

<http://aubethermostatmanual.com>

Golf course search by state

<http://golfingnear.com>

Email search by domain

<http://emailbydomain.com>

Auto manuals search

<http://auto.somanuals.com>

TV manuals search

<http://tv.somanuals.com>