



**BFC**

**28**

**30**

**50**

**60**

# Installation User and Service Manual

**A.O. SMITH**  
**WATER PRODUCTS  
COMPANY**

A DIVISION OF A. O. SMITH CORPORATION



**CYCLONE**

XTRA HIGH EFFICIENCY



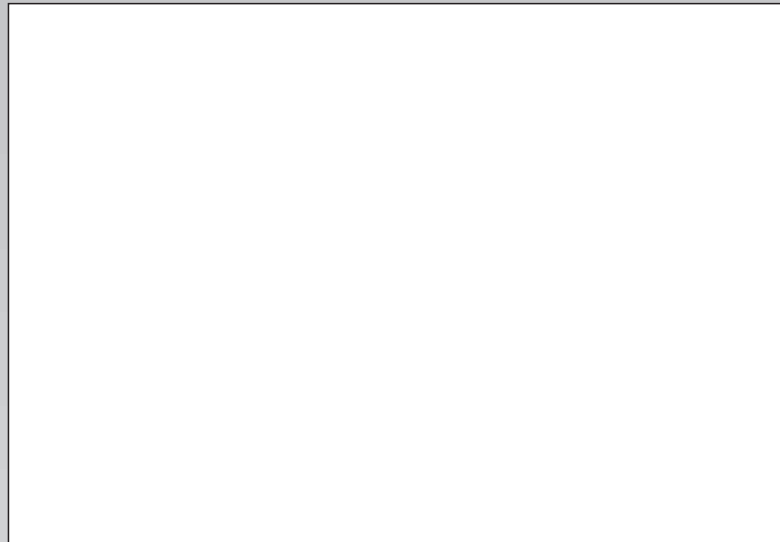

**your installer**



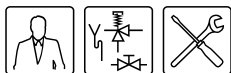

## Read this manual carefully

---

### **Warning**

Read this manual carefully before starting up the water heater. Failure to read this manual and to follow the instructions in this manual may lead to accidents, personal injury, and damage to the appliance.

---

### **Copyright © 2008 A.O. Smith water Products Company**

All rights reserved.

Nothing from this publication may be copied, reproduced and/or published by means of printing, photocopying or by whatsoever means, without the prior written approval of A.O. Smith water Products Company.

A.O. Smith water Products Company reserves the right to modify specifications stated in this manual.

## Trademarks

Any brand names mentioned in this manual are registered trademarks of their respective owners.

## Liability

A.O. Smith water Products Company accepts no liability for claims from third parties arising from improper use other than that stated in this manual and in accordance with the General Conditions registered at the Eindhoven Chamber of Commerce.

Refer further to the General Conditions. These are available on request, free of charge.

Although considerable care has been taken to ensure a correct and suitably comprehensive description of all relevant components, the manual may nonetheless contain errors and inaccuracies.

Should you detect any errors or inaccuracies in the manual, we would be grateful if you would inform us. This helps us to further improve our documentation.

## More information

If you have any comments or queries concerning any aspect related to the appliance, then please do not hesitate to contact:

A.O. Smith water Products Company

PO Box 70

5500 AB Veldhoven

Netherlands

Telephone: (free) 0870 - AOSMITH  
0870 - 267 64 84

General: +31 40 294 25 00

Fax: +31 40 294 25 39

E-mail : [info@aosmith.nl](mailto:info@aosmith.nl)

Website: [www.aosmithinternational.com](http://www.aosmithinternational.com)

In the event of problems with connecting to the gas, electricity or water supply, please contact your installation's supplier/installation engineer .

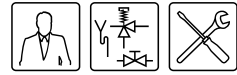

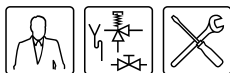

# Table of contents

<b>1</b>	<b>Introduction</b>	<b>9</b>
1.1	About the appliance	9
1.2	What to do if you smell gas-	9
1.3	Regulations	9
1.4	Target groups	10
1.5	Maintenance-	10
1.6	Forms of notation	11
1.7	Overview of this document	12
<b>2</b>	<b>Working principle of the appliance-</b>	<b>13</b>
2.1	Introduction	13
2.2	General working principle of the appliance	13
2.3	The appliance's heating cycle	14
2.4	Protection for the appliance	14
2.5	Safety of the installation	16
<b>3</b>	<b>Installation</b>	<b>17</b>
3.1	Introduction	17
3.2	Packaging	17
3.3	Environmental conditions-	17
3.4	Technical specifications	20
3.5	Installation diagram	23
3.6	Water connections, Unvented	24
3.7	Water connections, Vented-	25
3.8	Gas connection	26
3.9	Air supply and flue	26
3.10	Electrical connection	32
3.11	Checking the supply pressure and burner pressure	36
<b>4</b>	<b>Conversion to a different gas category</b>	<b>39</b>
<b>5</b>	<b>Filling-</b>	<b>43</b>
5.1	Filling the appliance	44
<b>6</b>	<b>Draining</b>	<b>45</b>
6.1	Draining unvented installations	46
6.2	Draining vented installations	46
<b>7</b>	<b>The control panel-</b>	<b>49</b>
7.1	Introduction	49
7.2	Controls	49
7.3	Meaning of icons-	49
7.4	Electronic controller ON/OFF switch	49
7.5	Navigation buttons	49
7.6	PC connection	50
<b>8</b>	<b>Status of the appliance-</b>	<b>51</b>
8.1	Introduction	51
8.2	Operating modes	51
8.3	Error conditions	52
8.4	Service condition-	53

## Table of contents

<b>9</b>	<b>Starting and running</b>	<b>55</b>
9.1	Introduction	55
9.2	Starting and running	55
9.3	The appliance's heating cycle	55
<b>10</b>	<b>Shutting down</b>	<b>57</b>
10.1	Introduction	57
10.2	Shut the appliance down for a brief period ("OFF mode")	57
10.3	Electrically isolating the appliance	57
10.4	Shutting the appliance down for a long period	57
<b>11</b>	<b>Main menu</b>	<b>59</b>
11.1	Introduction	59
11.2	Notational convention for menu-related instructions	59
11.3	Switching on the "ON mode"	59
11.4	Setting the water temperature	59
11.5	Week program	60
11.6	Starting and stopping the week program	60
11.7	Changing the appliance's standard week program	60
11.8	Adding times to a week program	62
11.9	Deleting times from a week program	63
11.10	Extra period	63
11.11	Programming an extra period	64
11.12	Settings	65
<b>12</b>	<b>Service program</b>	<b>67</b>
12.1	Introduction	67
12.2	Setting the hysteresis	67
12.3	Displaying the error history	67
12.4	Displaying the appliance history	68
12.5	Display the selected appliance	68
12.6	Switching the pump on or off	68
12.7	Setting the service interval	68
12.8	Setting the display contrast	68
12.9	Setting the display backlight time	68
12.10	Setting the display scroll speed	68
<b>13</b>	<b>Troubleshooting</b>	<b>69</b>
13.1	Introduction	69
13.2	Troubleshooting table for general errors	70
13.3	Troubleshooting table for displayed errors	72
<b>14</b>	<b>Maintenance frequency</b>	<b>83</b>
14.1	Introduction	83
14.2	Determining service interval	83
<b>15</b>	<b>Performing maintenance</b>	<b>85</b>
15.1	Introduction	85
15.2	Preparation for maintenance	85
15.3	Water-side maintenance	87
15.4	Gas-side maintenance	88
15.5	Finalizing maintenance	88
<b>16</b>	<b>Warranty (certificate)</b>	<b>89</b>
16.1	General warranty	89

16.2	Tank warranty - - - - -	89
16.3	Conditions for Installation and use - - - - -	89
16.4	Exclusions - - - - -	90
16.5	Scope of the warranty - - - - -	90
16.6	Claims - - - - -	90
16.7	Obligations of A.O. Smith - - - - -	90
<b>17</b>	<b>Appendices - - - - -</b>	<b>91</b>
17.1	Introduction - - - - -	91
17.2	Electrical diagram - - - - -	92
17.3	Week program card - - - - -	95

## Table of contents



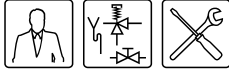

# 1 Introduction

## 1.1 About the appliance

This manual describes how to install, service and use the BFC appliance. The BFC appliance is a condensing water heater with a fan in the air intake. The BFC can be installed as either an open or room-sealed appliance. A concentric chimney connector is fitted standard to the appliance. Alternatively, the appliance can be connected using a parallel system.

The alternative installation types are B23, C13, C33, C43, C53 and C63.

The information in this manual applies to the: BFC 28, BFC 30, BFC 50 and BFC 60.



The appliance has been manufactured and equipped in accordance with the European standard for gas-fired storage water heaters for the production of domestic hot water (EN 89). The appliances are therefore compliant with the European Directive for Gas Appliances, and are entitled to bear the CE mark.

---

### **Warning**

Read this manual carefully before starting up the water heater. Failure to read the manual and to follow the printed instructions may lead to personal injury and damage to the appliance.

---

## 1.2 What to do if you smell gas

---

### **Warning**

If there is a **gas smell**:

No naked flames! No smoking!

Avoid causing sparks! Do not use any electrical equipment or switch, i.e. no telephones, plugs or bells!

Open windows and doors!

Shut off the mains gas supply valve!

Warn occupants and leave the building!

After leaving the building, alert the gas distribution company or your installation engineer.

---

## 1.3 Regulations

As the (end) user, installation engineer or service and maintenance engineer, you must ensure that the entire installation complies, as a minimum, with the official local:

- building regulations;
- energy supplier's directives for existing gas installations;
- directives and technical guidelines for natural gas installations;
- safety requirements for low-voltage installations;
- regulations governing the supply of drinking water;
- regulations governing ventilation in buildings;
- regulations governing the supply of air for combustion;
- regulations governing the discharge of products of combustion;
- requirements for installations that consume gas;
- regulations governing indoor waste water disposal;

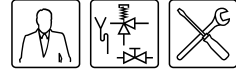

- regulations imposed by fire brigade, power companies and municipality. Furthermore, the installation must comply with the manufacturer's instructions.

---

**Note**

Later amendments and/or additions to all regulations, requirements and guidelines published on or prior to the moment of installing, will apply to the installation.

---

## 1.4 Target groups

The three target groups for this manual are:

- (end) users;
- installation engineers;
- service and maintenance engineers.

Symbols on each page indicate the target groups for whom the information is intended. See the table.

### Target group symbols

Symbol	Target group
	(End) user
	Installation engineer
	Service and maintenance engineer

## 1.5 Maintenance

A service should be carried out at least once a year, both on the water side and on the gas side. Maintenance frequency depends, among other things, on the water quality, the average burning time per day and the set water temperature.

---

**Note**

To determine the correct maintenance frequency, it is recommended to arrange for the service and maintenance engineer to check the appliance on both the water and gas side within three months following installation. Based on this check, the best maintenance frequency can be determined.

**Note**

Regular maintenance extends the service life of the appliance.

**Note**

Both the end user and the service and maintenance engineer are responsible for regular maintenance. They will need to establish clear agreements on this.

**Note**

If the appliance is not regularly maintained, the warranty will become void.

---

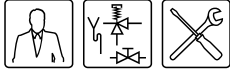

## 1.6 Forms of notation

The following notation is used in this manual:

---

 **Note**  
Important information.

---

 **Attention**  
Ignoring this information can lead to the appliance being damaged.

---

 **Warning**  
Failure to carefully read this information may lead to personal injury and serious damage to the appliance.







































---



## 1.7 Overview of this document

The table provides an overview of the contents of this document.

### Contents of this document

Chapter	Target groups	Description
Working principle of the appliance	  	This chapter describes how the appliance functions.
Installation	 	This chapter describes the installation activity to be completed before you actually start up the appliance.
Filling	  	This chapter describes how to fill the appliance.
Draining	  	This chapter describes how to drain the appliance.
The control panel	  	This chapter describes the general control of the appliance using the display.
Status of the appliance	  	This chapter describes the status (mode or condition) that the appliance may have, and possible actions to take.
Starting and running	  	This chapter describes how to start the appliance running. The general heating cycle of the appliance is also described.
Shutting down	  	This chapter describes how to shut the appliance down for a brief or long period of time.
Main menu	  	This chapter describes the main menu of the display. This is the actual menu for the user, however the installation engineer and service and maintenance engineers will also need to use this menu.
Service program	 	This chapter describes the service menu. It is mainly intended for the installation engineer and service and maintenance engineers. End users may also refer to this chapter for additional information about the appliance.
Troubleshooting	  	This chapter is mainly intended for the installation engineer and the service and maintenance engineer. It describes appliance errors. These errors are indicated on the display. A troubleshooting table of possible causes and solutions is provided. End users may also refer to this chapter for additional information about the appliance.
Maintenance frequency	 	This chapter describes how to determine the optimum frequency at which to carry out maintenance. Both the end user and the service and maintenance engineer are responsible for regular maintenance. They need to reach clear agreement on this.  <b>Note</b>  If the appliance is not regularly maintained, the warranty will become void.
Performing maintenance		This chapter sets out the maintenance tasks to be carried out during a service.
Warranty (certificate)	  	This chapter states the warranty terms and conditions.

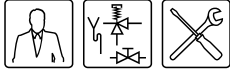

# 2 Working principle of the appliance

## 2.1 Introduction

Topics covered in this chapter:

- [General working principle of the appliance](#);
- [The appliance's heating cycle](#);
- [Protection for the appliance](#);
- [Safety of the installation](#).

## 2.2 General working principle of the appliance

The figure shows a cut-away view of the appliance.

*Cut-away view of the appliance*

### Legend

Only applicable numbers are mentioned.

1. cover
2. hot water outlet
3. electrical connector block
4. electronic controller
5. pressure switch
6. control panel
7. temperature sensor  $T_1$
8. combustion chamber
9. anode
10. tank
11. heat exchanger
12. inspection and cleaning opening
13. temperature sensor  $T_2$
14. cold water inlet
15. drain valve
16. gas control
17. burner
18. fan
19. air supply hose
20. hot surface igniter
21. flame probe
22. chimney pipe
23. siphon
24. insulation layer

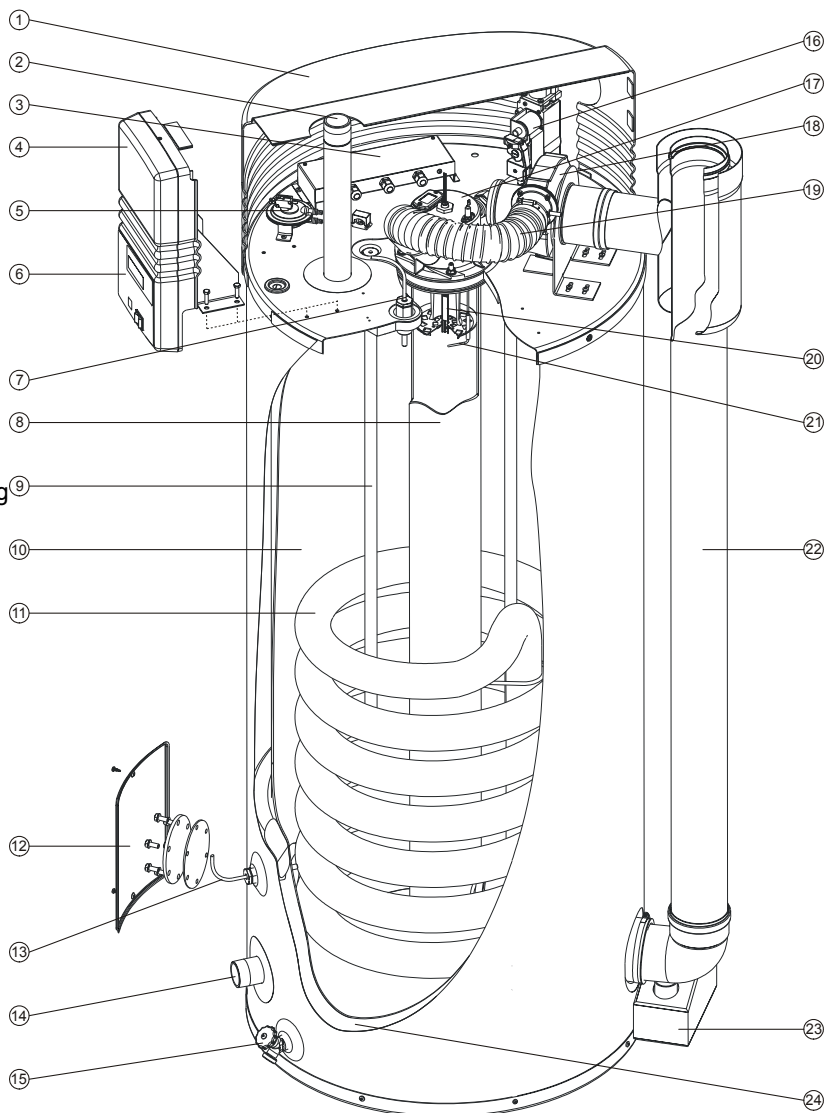

IMD-0070 R1

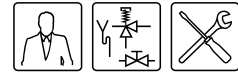

In this appliance the cold water enters the bottom of the tank via the cold water inlet (14). Once heated by the combustion chamber (8) and heat exchanger (11), the hot tapwater leaves the tank through the hot water outlet (2). Once the appliance is completely filled with water, it remains constantly under water supply pressure. As hot water is drawn from the appliance, it is immediately replenished with cold water.

The air required for combustion is forced into the burner (17) by the fan (18).

The gas is fed to the burner via the gas valve (16). Thanks to the modulated supply of gas and air, the optimum gas/air mixture is always achieved. The special construction of the burner causes the mixture to form a vortex (the cyclone effect), before it becomes ignited. This vorticity improves the ignition on the hot surface igniter (20), as well as ensuring optimum combustion efficiency. Through the special design of the heat exchanger (11), the flue gases are first led downwards via the combustion chamber, then upwards again via the heat exchanger, then once more downwards beside the water in the tank. In this process, the flue gases gradually become cooler. Because the cooled flue gases flow alongside the cold water lower down in the tank, they start to condense. This condensation causes latent heat energy to be released, which is transferred to the cooler water, thereby increasing the energy performance of the unit. The condensate yielded by this process is discharged via the siphon (23).

The insulation layer (24) prevents heat from escaping. The inside of the tank is enamelled to protect against corrosion. The anodes (9) provide extra protection against corrosion.

For use during maintenance, the appliance has an inspection and cleaning opening (12).

### 2.3 The appliance's heating cycle

The water temperature is measured by temperature sensors T1 (7) in the top of the tank (10) and T2 (13) at the bottom of the tank. These temperatures are sent to the electronic controller. Based on these two observations, the electronic controller calculates a net water temperature:  $T_{net}$ . The value of  $T_{net}$  lies between the temperatures at the top and bottom of the tank. As soon as  $T_{net}$  falls below the set water temperature ( $T_{set}$ ), the electronic controller registers a "heat demand". The gas control (16) is opened, and the gas is mixed with air. This mixture is ignited by the hot surface igniter (20) and the water becomes heated. As soon as  $T_{net}$  rises above  $T_{set}$  the heat demand ends, and the electronic controller stops the heating cycle.

The electronic controller assumes a certain margin both when registering and ending heat demand. We refer to this margin as the hysteresis ([12.2 "Setting the hysteresis"](#)).

### 2.4 Protection for the appliance

#### 2.4.1 Introduction

The electronic controller monitors the water temperature and ensures safe combustion. This is achieved by:

- the [Water temperature protection](#);
- the [Gas valve](#);
- the [Fan](#);
- the [Pressure switch](#);
- the [Flame probe](#).

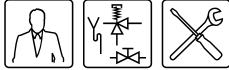

### 2.4.2 Water temperature protection

The electronic controller uses temperatures sensors T1 (7) and T2 (13) to monitor three temperatures that are important for safety. The table explains the functioning of the temperature sensors.

#### Temperature protection

Protection	Description
Against frost (T1 < 5°C or T2 < 5°C)	The frost protection cuts in. The water is heated to 20°C.
For maximum water temperature (T1 > 85°C or T2 > 85°C)	The high-limit safeguard serves to prevent overheating and/or excessive formation of scale in the appliance. If the high-limit safeguard is activated, the heating is stopped. This causes the water in the tank to cool down. Once the water has cooled sufficiently (T1 < 78°C), the electronic controller resets the appliance.
For extra safety (T1 > 93°C or T2 > 93°C)	A lockout error of the water heater controller takes place. The controller must be manually reset before the appliance can resume operation (8.3 "Error conditions"). The reset may only be performed if T <sub>1</sub> < 78°C.

### 2.4.3 Gas valve

The electronic controller opens the gas valve so that gas can be supplied to the burner. As a safety measure, the gas valve has a double shut-off. The double shut-off guarantees complete isolation of the appliance from the gas supply.

To help ensure smooth ignition, the gas valve opens gradually ("softlite").

### 2.4.4 Fan

The fan (18) provides an optimum air supply when there is a heat demand. As a safety feature, the fan ensures that any gases present in the combustion chamber are removed, both before and after combustion. We refer to this as pre- and post-purge.

The fan speed is continuously monitored by the electronic controller (4). The electronic controller takes control if the speed of rotation varies too much from the set value.

### 2.4.5 Pressure switch

The pressure switch ensures the discharge of flue gases and the supply of incoming air during the pre-purge and normal running of the appliance. The default state of the pressure switch is open. When sufficient pressure difference is reached, the pressure switch closes. However, in the event of a fault, the pressure switch is tripped open, and the heating cycle is interrupted. The table shows the trip point per appliance.

#### Note

The trip point of the pressure switch is not adjustable.

#### Pressure switch trip points

Appliance	Closing pressure differential	Opening pressure differential
BFC 28	≥ 635 Pa	≤ 605 Pa
BFC 30	≥ 855 Pa	≤ 825 Pa
BFC 50	≥ 885 Pa	≤ 855 Pa
BFC 60	≥ 1085 Pa	≤ 1055 Pa

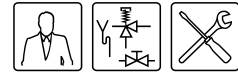

#### 2.4.6 Flame probe

To ensure that no gas can flow when there is no combustion, the water heater is fitted with a flame probe (21). The electronic controller uses this probe to detect the presence of a flame, by means of ionisation detection. The electronic controller closes the gas control the instant it detects that there is a gas flow but no flame.

### 2.5 Safety of the installation

In addition to the appliance's standard built-in safety monitoring, the appliance must also be protected by an expansion vessel, expansion valve, pressure reducing valve, non-return valve and a T&P valve.

The use of an expansion vessel, expansion valve and/or pressure reducing valve depends on the type of installation: unvented or vented.

#### 2.5.1 Unvented installation

With an unvented installation, an expansion valve and expansion vessel prevent the buildup of excessive pressure in the tank. This prevents damage being caused to the enamelled coating (in the appliance) or to the tank. A non-return valve prevents excessive pressure buildup in the water supply system. This valve also prevents water from flowing backwards from the tank into the cold water supply system. The pressure reducing valve protects the installation against an excessively high water supply pressure (> 8 bar). These components are fitted to the cold water pipe ([3.7 "Water connections, Vented"](#)).

#### 2.5.2 Vented installation

With a vented installation, excess pressure is taken up by the open cold water head tank. The height of the head tank determines the working pressure in the water heater, which may not exceed 8 bar. The installation must also be fitted with a vent pipe from the hot water pipe, that opens into the cold water tank.

Ideally, the vent pipe should discharge into a separate tundish/drain or otherwise to the open cold water head tank. The water heater should also be fitted on the hot water side with a stop valve ([3.6.2 "Hot water side"](#)).

#### 2.5.3 T&P valve

A T&P valve is only mandatory in an unvented installation. However, A.O. Smith also recommends the use of a T&P valve in vented installations.

A T&P (Temperature and Pressure Relief) valve monitors the pressure in the tank and the water temperature at the top of the tank. If the pressure in the tank becomes excessive (> 10 bar) or the water temperature is too high (> 97°C), the valve will open. The hot water can now flow out of the tank. Because the appliance is under water supply pressure, cold water will automatically flow into the tank. The valve remains open until the unsafe situation has been rectified. The appliance is fitted standard with a connecting point for a T&P valve ([3.6.2 "Hot water side"](#)).



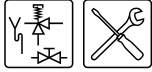

# 3 Installation

---

## Warning

Installation work should be carried out by an approved installation engineer in compliance with the general and local regulations imposed by the gas, water and power supply companies and the fire service.

The appliance may only be installed in a room that complies with the requirements stated in national and local ventilation regulations ([1.3 "Regulations"](#)).

---

### 3.1 Introduction

This chapter describes the installation activities to be carried out before you actually start using the appliance ([9 "Starting and running"](#)), namely:

- [Packaging](#);
- [Environmental conditions](#);
- [Technical specifications](#);
- [Water connections, Unvented](#);
- [Water connections, Vented](#);
- [Gas connection](#);
- [Air supply and flue](#);
- [Electrical connection](#);
- [Checking the supply pressure and burner pressure](#);

In the event of conversion to a different gas category, see conversion ([4 "Conversion to a different gas category"](#)).

### 3.2 Packaging

To avoid damaging the appliance, remove the packaging carefully.

We recommend unpacking the appliance at or near its intended location.

---

## Attention

The appliance may only be manoeuvred in an upright position. Take care that the appliance is not damaged after unpacking.

---

### 3.3 Environmental conditions

The appliance is suitable for either open or room-sealed combustion. If installed as a room-sealed appliance, then the availability of the necessary external air supply will depend on the place of installation. In this event, there are no additional ventilation requirements.

If the appliance is to be installed as an open system, then it will be subject to the guidelines and ventilation regulations that are in force locally.

The alternative installation types are B23, C13, C33, C43, C53 and C63.

---

## Attention

The appliance may not be used in rooms where chemical substances are stored or used, due to the risk of explosion and/or corrosion of the appliance. Some propellants, bleaching agents, degreasing agents etc. disperse vapours which are explosive and/or which cause accelerated corrosion. If the appliance is used in a room in which such substances are present, the warranty will be void.

---

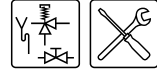

### 3.3.1 Air humidity and ambient temperature

The boiler room must be frost-free, or be protected against frost. The table shows the environmental conditions that must be adhered to for correct functioning of the electronics present in the appliance to be guaranteed.

*Air humidity and ambient temperature specifications*

Air humidity and ambient temperature	
Air humidity	max. 93% RV at +25°C
Ambient temperature	Functional: $0 \leq T \leq 60^\circ\text{C}$

### 3.3.2 Appliance maximum floor load

In connection with the appliance's weight, take account of the maximum floor loading, refer to the table.

*Weight specifications related to maximum floor load*

Weight of the appliance filled with water	
BFC 28	394 kg
BFC 30, BFC 50, BFC 60	582 kg

### 3.3.3 Water composition

The appliance is intended for heating drinking water. The drinking water must comply with the regulations governing drinking water for human consumption. The table gives an overview of the specifications.

*Water specifications*

Water composition	
Hardness (alkaline earth ions)	> 1.00 mmol/l: <ul style="list-style-type: none"> <li>• German hardness &gt; 5.6° dH</li> <li>• French hardness &gt; 10.0° fH</li> <li>• English hardness &gt; 7.0° eH</li> </ul>
Conductivity	> 125 $\mu\text{S/cm}$
Acidity (pH value)	$7.0 < \text{pH value} < 9.5$

#### Note

If the water specifications deviate from those stated in the table, then the tank protection cannot be guaranteed (16 "Warranty (certificate)").

### 3.3.4 Working clearances

For access to the appliance, it is recommended that the following clearances are observed (see figure):

- AA: around the appliance's control column and cleaning openings: 100 cm.
- BB: all sides of the appliance: 50 cm.
- Above the appliance (room to replace the anodes):
  - 100 cm if using fixed anodes, or
  - 50 cm if using flexible anodes.

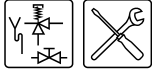

If the available clearance is less than 100 cm, flexible magnesium anodes may be ordered.

---

**Note**

When installing the appliance, be aware that any leakage from the tank and/or connections can cause damage to the immediate environment or floors below the level of the boiler room. If this is the case, the appliance should be installed above a wastewater drain or in a suitable metal leak tray.

The leak tray must have an appropriate wastewater drain and must be at least 5cm deep with a length and width at least 5cm greater than the diameter of the appliance.

---

*Working clearances*

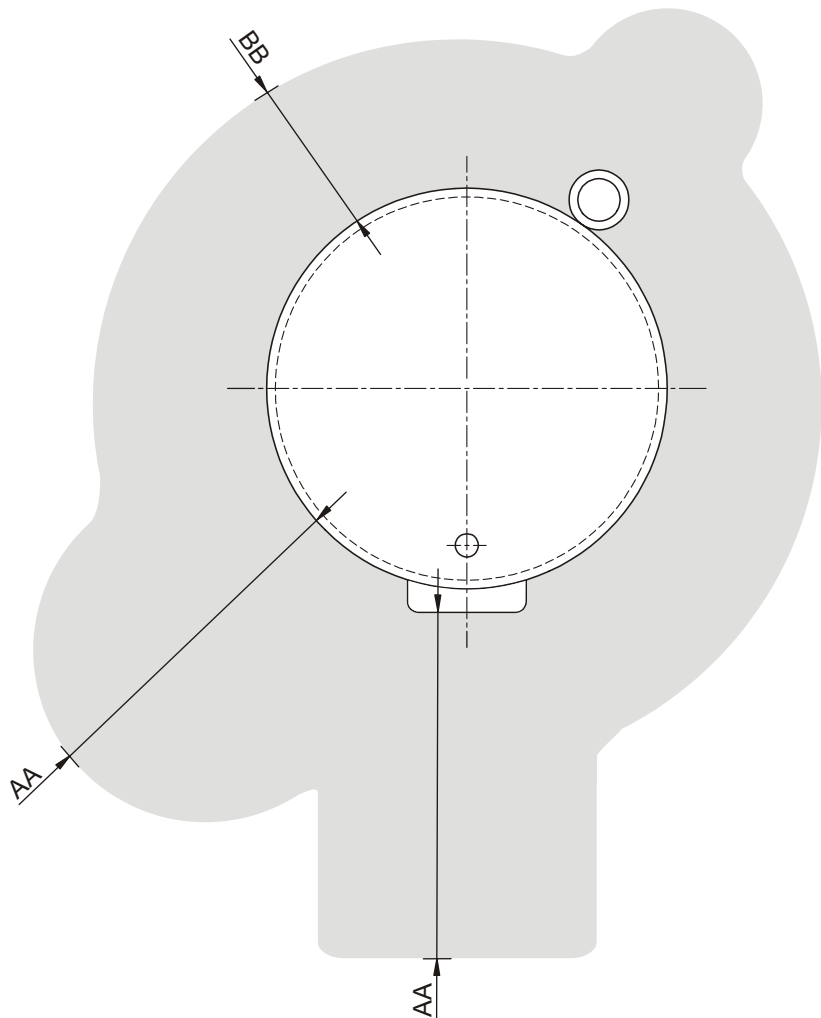

IMD-0228 R1



### 3.4 Technical specifications

The appliance is supplied without accessories. Check the dimensions (3.4.1 "Dimensions of the appliance"), gas data (3.4.3 "Gas data") and other specifications (3.4.2 "General and electrical specifications") of any accessories you plan to use.

#### 3.4.1 Dimensions of the appliance

*Plan and elevation of the appliance*

**Legend**

See the table.

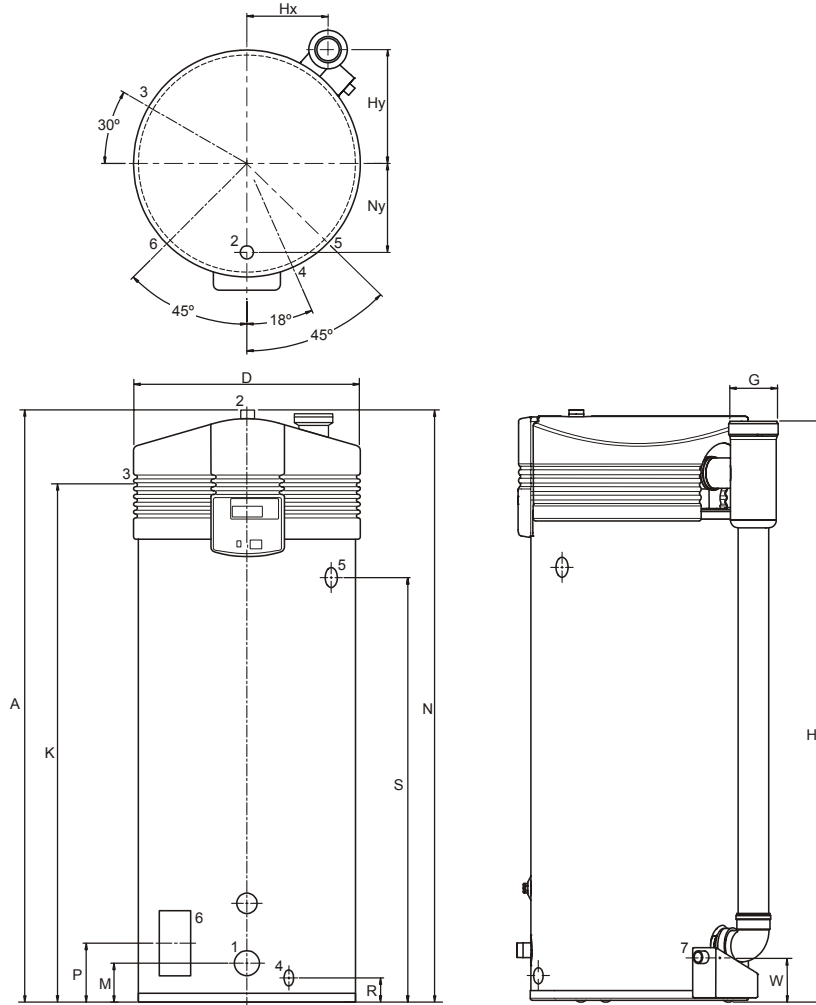

IMD-0073 R5



Dimensions (all sizes in mm, unless otherwise stated)

Dimension	Description	BFC 28	BFC 30	BFC 50	BFC 60
A	Total height	1390	1910	1910	1910
D	Diameter of the appliance	705	705	705	705
G	Flue gas outlet diameter	80/125	100/150	100/150	100/150
H	Height of flue/air supply	1365	1905	1905	1905
Hx	x position of flue	265	265	265	265
Hy	y-position of flue	375	375	375	375
K	Height of gas connection	1270	1800	1800	1800
M	Height of cold water supply	170	160	160	160
N	Height of hot water outlet	1405	1940	1940	1940
Ny	y-position of hot water outlet	205	205	205	205
P	Height of cleaning opening	170	175	175	175
R	Height of drain valve connection	85	75	75	75
S	Height of T&P valve connection	900	1410	1410	1410
W	Height of condensation drain	125	145	145	145
1	Cold water supply connection (ext.)	R1 <sup>1</sup> / <sub>2</sub>	R1 <sup>1</sup> / <sub>2</sub>	R1 <sup>1</sup> / <sub>2</sub>	R1 <sup>1</sup> / <sub>2</sub>
2	Hot water outlet (ext.)	R1 <sup>1</sup> / <sub>2</sub>	R1 <sup>1</sup> / <sub>2</sub>	R1 <sup>1</sup> / <sub>2</sub>	R1 <sup>1</sup> / <sub>2</sub>
3	Gas valve connection (int.)	Rp <sup>3</sup> / <sub>4</sub>	Rp <sup>3</sup> / <sub>4</sub>	Rp <sup>3</sup> / <sub>4</sub>	Rp <sup>3</sup> / <sub>4</sub>
4	Drain valve connection (int.)	<sup>3</sup> / <sub>4</sub> "	<sup>3</sup> / <sub>4</sub> "	<sup>3</sup> / <sub>4</sub> "	<sup>3</sup> / <sub>4</sub> "
5	T&P valve connection (int.)	1-11.5 NPT	1-11.5 NPT	1-11.5 NPT	1-11.5 NPT
6	Inspection/cleaning opening	95x70	95x70	95x70	95x70
7	Condensation drainage connection (int.)	Ø40	Rp1	Rp1	Rp1

### 3.4.2 General and electrical specifications

General and electrical specifications

DESCRIPTION	Unit	BFC 28	BFC 30	BFC 50	BFC 60
Volume	litres	217	368	368	368
Empty weight	kg	177	214	214	214
Maximum operating pressure	bar	8	8	8	8
Number of anodes	-	4	4	4	4
Fan rotation speed at ignition	rpm	4500	4500	4500	4500
Operational speed of fan	rpm	5000	5400	6000	6660
Diameter of air restrictor	mm	23.0	23.0	28.0	29.0
Heating time ΔT = 45°C	minutes	22	35	24	19
Electrical power consumption	W	275	275	275	275
Supply voltage (-15% +10% VAC)	volts	230	230	230	230
Mains frequency	Hz (± 1Hz)	50	50	50	50
IP class	-	30	30	30	30

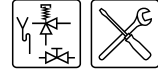

## 3.4.3 Gas data

## Gas data

Description $\text{H}_{2\text{H}3+}$	Unit	BFC 28	BFC 30	BFC 50	BFC 60
<b>Gas category 2H: G20 - 20 mbar</b>					
Injector orifice diameter	mm	4.90	5.10	7.00	7.10
(1) = Blank plate (2) = Burner pressure regulator	1 or 2	2	2	2	2
Nominal load (gross calorific value)	kW	32.1	34.5	52.6	63.2
Nominal output	kW	30.5	32.7	48.8	59.6
Supply pressure	mbar	20	20	20	20
Burner pressure	mbar	8.5	8.5	8.5	11.5
Gas consumption (*)	m <sup>3</sup> /h	3.1	3.3	5.0	6.0
<b>General 3+</b>					
Injector orifice diameter	mm	2.50	2.60	3.40	3.80
(1) = Blank plate (2) = Burner pressure regulator	1 or 2	1	1	1	1
<b>Gas category: G30-30 mbar (butane)</b>					
Nominal load (gross calorific value)	kW	30.7	32.8	50.6	59.4
Nominal output	kW	29.8	31.8	48.1	57.4
Supply pressure	mbar	30	30	30	30
Burner pressure (†)	mbar	-	-	-	-
Gas consumption (*)	kg/h	2.2	2.4	3.7	4.3
<b>Gas category: G31-37 mbar (propane)</b>					
Nominal load (gross calorific value)	kW	29.0	30.9	50.3	59.1
Nominal output	kW	28.1	29.8	47.7	56.9
Supply pressure	mbar	37	37	37	37
Burner pressure (†)	mbar	-	-	-	-
Gas consumption (*)	kg/h	2.1	2.2	3.6	4.2
(*) Based on 1013.25 mbar and 15 °C.					
(†) If using a blank plate instead of a burner pressure regulator, it is assumed that the burner pressure is equal to the supply pressure. In practice, however, the burner pressure will be lower.					

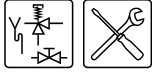

### 3.5 Installation diagram

#### Installation diagram

##### Legend

Only applicable numbers are mentioned.

1. pressure reducing valve (mandatory)
  3. T&P valve (mandatory)
  4. stop valve (recommended in pipe C and mandatory in pipe A)
  5. non-return valve (mandatory)
  6. circulation pump (optional)
  9. drain valve
  10. manual gas valve (mandatory)
  11. service stop valve
  12. temperature gauge (optional)
  13. condensation drainage
  14. hot water draw-off points
  15. expansion valve (mandatory)
  16. expansion vessel (mandatory)
  17. 3-way aeration valve (recommended)
  18. water tank
  19. float valve
- A. cold water supply  
 B. hot water supply  
 C. circulation pipe  
 D. gas supply  
 E. overflow pipe  
 H. overflow pipe

UNVENTED

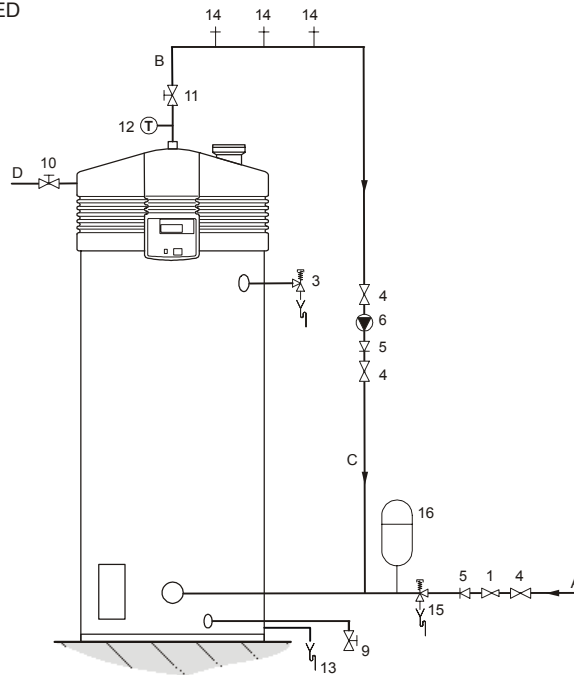

VENTED

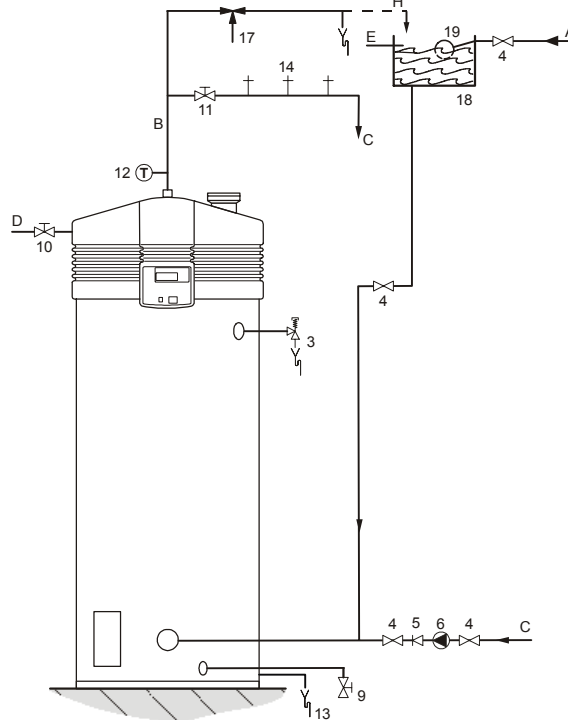

IMD-0464 R0

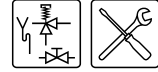

### 3.6 Water connections, Unvented



#### Warning

The installation should be carried out by an authorised installation engineer, in compliance with general and local regulations ([1.3 "Regulations"](#)).

#### 3.6.1 Cold water side

See (A) in the installation diagram ([3.5 "Installation diagram"](#)).

1. Fit an approved stop valve (4) on the cold water side as required by applicable regulations ([1.3 "Regulations"](#)).
2. The maximum working pressure of the appliance is 8 bar. Because the pressure in the water pipe at times can exceed 8 bar, you must fit an approved pressure-reducing valve (1).
3. Fit a non-return valve (5) and an expansion vessel (16).
4. Fit an expansion valve (15) and connect the overflow side to an open wastewater pipe.

#### 3.6.2 Hot water side

See (B) in the installation diagram ([3.5 "Installation diagram"](#)).



#### Note

Insulating long hot water pipes will prevent unnecessary energy loss.

1. Optional: fit a temperature gauge (12) so you can check the temperature of the tap water.
2. Fit the T&P valve (3).
3. Fit a stop valve (11) in the hot water outlet pipe for servicing.

#### 3.6.3 Circulation pipe

See (C) in the installation diagram ([3.5 "Installation diagram"](#)).

If an immediate flow of hot water is required at draw-off points, a circulation pump can be installed. This improves comfort and reduces water wastage.

1. Fit a circulation pump (6) of the correct capacity for the length and resistance of the circulation system.
2. Fit a non-return valve (5) behind the circulation pump to guarantee the direction of circulation.
3. Fit two stop valves for service purposes (4).
4. Connect the circulation pipe to the cold water supply pipe.

#### 3.6.4 Condensation drainage

1. Fit a sloping wastewater pipe to the siphon (13) for condensation drainage and connect this to the wastewater discharge in the boiler room.



#### Attention

All fittings behind the siphon must be condensation-resistant.



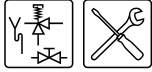

### 3.7 Water connections, Vented

---

#### **Warning**

The installation should be carried out by an authorised installation engineer, in compliance with general and local regulations ([1.3 "Regulations"](#)).

---

#### 3.7.1 Cold water side

See (A) in the installation diagram ([3.5 "Installation diagram"](#)).

1. Fit an approved stop valve (4) on the cold water side between the cold water head tank (18) and the appliance, as required by regulations ([1.3 "Regulations"](#)).

#### 3.7.2 Hot water side

See (B) in the installation diagram ([3.5 "Installation diagram"](#)).

---

#### **Note**

Insulating long hot water pipes prevents unnecessary energy loss.

---

1. Fit the T&P valve (3).
2. Optional: fit a temperature gauge (12) so you can check the temperature of the tap water.
3. Fit a stop valve (4) in the hot water outlet pipe, for use when servicing.
4. If a circulation pipe is required, continue further by installing the circulation pipe ([3.6.3 "Circulation pipe"](#)).

#### 3.7.3 Circulation pipe

See (C) in the installation diagram ([3.5 "Installation diagram"](#)).

If an immediate flow of hot water is required at draw-off points, a circulation pump can be installed. This improves comfort and reduces water wastage.

1. Fit a circulation pump (6) of the correct capacity for the length and resistance of the circulation system.
2. Fit a non-return valve (5) behind the circulation pump to guarantee the direction of circulation.
3. Fit two stop valves for service purposes (4).
4. Connect the circulation pipe to the cold water supply pipe.

#### 3.7.4 Condensation drainage

1. Fit a sloping wastewater pipe to the siphon (13) for condensation drainage and connect this to the wastewater discharge in the boiler room.

---

#### **Attention**

All fittings behind the siphon must be condensation-resistant.

---

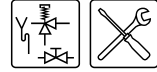

### 3.8 Gas connection

**Warning**

The installation should be carried out by an authorised installation engineer, in compliance with general and local regulations ([1.3 "Regulations"](#)).

**Attention**

Make sure that the diameter and length of the gas supply pipe are large enough to supply sufficient capacity to the appliance.

See (D) in the installation diagram ([3.5 "Installation diagram"](#)).

1. Fit a manual gas valve (10) in the gas supply pipe.
2. Blow the gas pipe clean before use.
3. Close the manual gas valve.
4. Fit the gas supply pipe to the gas control.

**Warning**

After fitting, check for leaks.

### 3.9 Air supply and flue

#### 3.9.1 Introduction

This section covers the following subjects:

- [Requirements for flue gas discharge materials](#)
- [Concentric connections](#)
- [Parallel connections](#)

#### 3.9.2 Requirements for flue gas discharge materials

**Warning**

The installation should be carried out by an authorised installation engineer, in compliance with general and local regulations ([1.3 "Regulations"](#)).

Depending on the approved installation types, there are several alternatives for connecting the air supply and flue gas discharge.

The appliances are approved for installation types B23, C13, C33, C43, C53 and C63.

The figure and table give information about these appliance types. For an explanation of the possibilities, please contact the manufacturer.

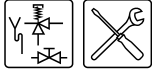

Types of appliances

C43

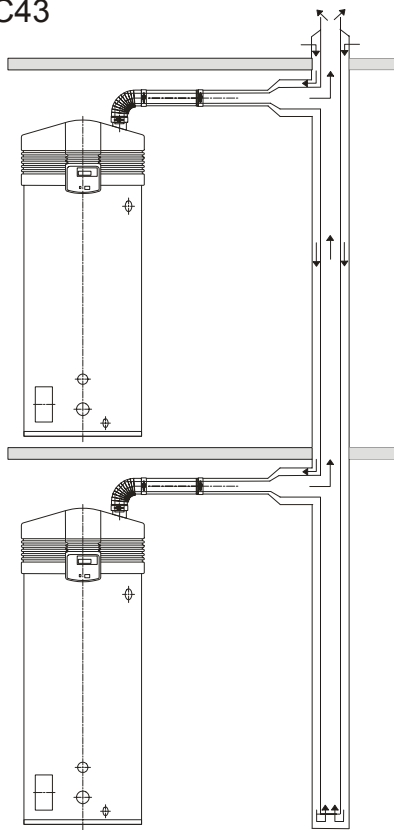

B23

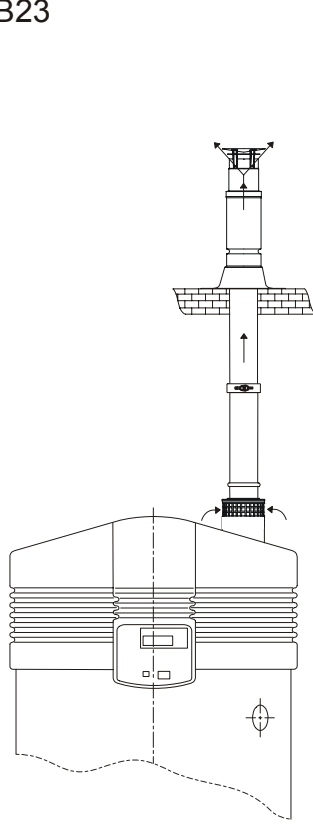

C33

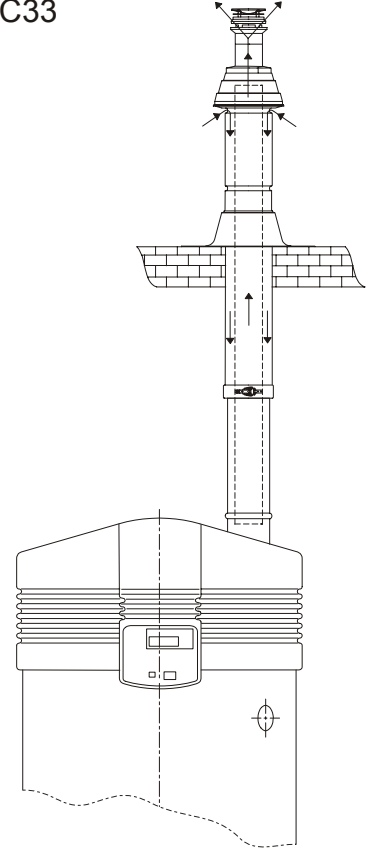

C13

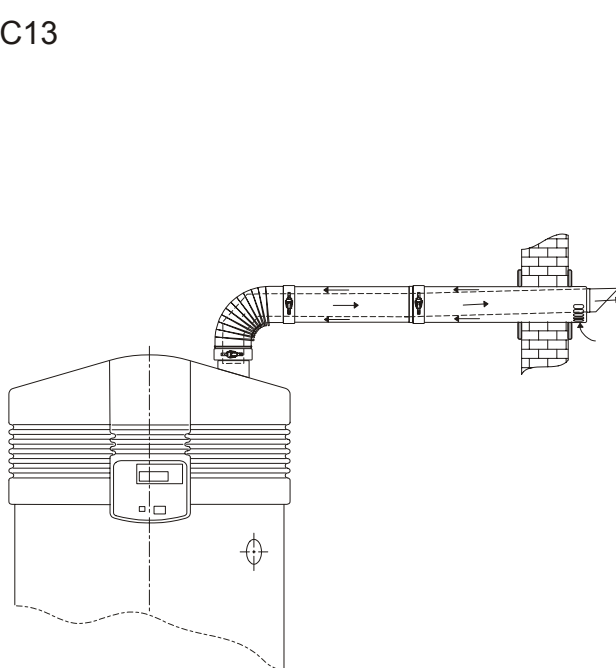

C53

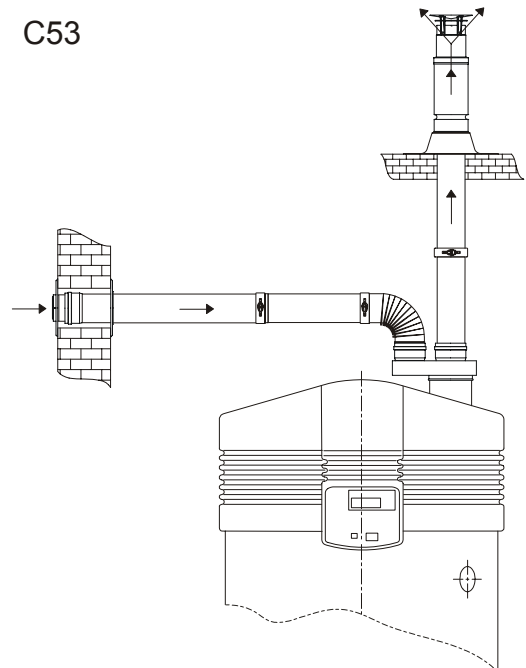

IMD-0468 R0

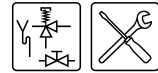

*Explanation of type of appliance*

Type of appliance	Description
B23	Air for combustion is drawn from the boiler room.
C13	Concentric and / or parallel wall flue terminal
C33	Concentric and / or parallel roof flue terminal
C43	Appliances on common air supply and flue gas discharge (concentric and / or parallel) in multi-storey building.
C53	Air supply and flue terminal types mixed.
C63	Appliances supplied without flue components and / or terminal. These appliances must be installed in compliance with local regulations.



**Note**

Make sure that the chimney discharges into an area where this is permitted for this category of appliance.

### 3.9.3 Concentric connections

The table shows the requirements for concentric systems.



**Warning**

Install flue gas discharge pipe runs with a run-off of 5 mm per metre.

*Flue gas discharge requirements for concentric systems (C13, C33)*

Appliance	Diameter	Maximum length	Maximum number of 90° bends
BFC 28	80/125 mm	40 m	7
BFC 30	100/150 mm	40 m	7
BFC 50	100/150 mm	40 m	7
BFC 60	100/150 mm	15 m	4



**Attention**

Both conditions stated in the table must be fulfilled.

Even if there are less bends than the stated maximum, the maximum pipe length may **not** be exceeded.

Even if the total pipe length is less than the stated maximum, the maximum number of bends may **not** be exceeded.

The following example illustrates how to use the table.

#### Practical example of concentric flue gas discharge

**Example**

The figure shows a BFC 30 installation. The appliance must be fitted with 25 m of concentric pipe (C13/C33) and four 90 degree bends. We need to check whether this configuration complies with the requirements stated in the table.

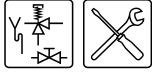

### Appliance with concentric flue gas discharge material



IMD-0284 R1

According to the table, the maximum length allowed is 40 metres, and there may be up to seven 90 degree bends. Both requirements are fulfilled.

### Specifications

#### Attention

For type C13 and C33 installations, A.O. Smith prescribes the use of a roof or wall-mounted terminal, exclusively of a type approved for the appliance. Use of an incorrect roof or wall-mounted flue terminal can cause the installation to malfunction.

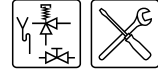

## Concentric wall flue terminal specifications C13

Specification		Description	
Wall flue terminal set: • 1X Wall flue terminal (incl. wall flange & clamping ring) • 1X Pipe 500mm • 1X Bend 90°	Art. No.	BFC 28	0302 515 <sup>1</sup>
		BFC 30-50-60	0302 504 <sup>1</sup>
	Construction	Concentric	
	Manufacturer	Muelink & Grol	
	Model	M2000 MDV SEC	
Pipe material	Construction	Concentric	
	Flue	Thick-walled aluminium with lip ring seal	
	Air supply	Thin-walled galvanised sheet steel	
Pipe diameters	Flue	BFC 28	Ø 80 mm
		BFC 30-50-60	Ø 100 mm
	Air supply	BFC 28	Ø 125 mm
		BFC 30-50-60	Ø 150 mm
(1) No other wall flue terminal is permitted. Use this item number to order the wall conduit set from <i>supplier</i> , manufacturer or wholesaler.			

## Concentric roof flue terminal specifications C33

Specification		Description	
Roof flue terminal set: • 1X Wall flue terminal (incl. clamping ring) • 1X Pipe 1000mm • 1 X Mounting flange	Art. No.	BFC 28	0305 042 <sup>1</sup>
		BFC 30-50-60	0304 423 <sup>1</sup>
	Construction	Concentric	
	Manufacturer	Muelink & Grol	
	Model	M2000 DDV HR-C	
Pipe material	Construction	Concentric	
	Flue	Thick-walled aluminium with lip ring seal	
	Air supply	Thin-walled galvanised sheet steel	
Pipe diameters	Flue	BFC 28	Ø 80 mm
		BFC 30-50-60	Ø 100 mm
	Air supply	BFC 28	Ø 125mm
		BFC 30-50-60	Ø 150 mm
(1) No other wall flue terminal is permitted. Use this item number to order the wall conduit set from <i>supplier</i> , manufacturer or wholesaler.			

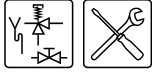

### 3.9.4 Parallel connections

The table states the maximum pipe lengths for parallel systems. The maximum pipe length depends on the chosen diameter.

#### Warning

Install flue component pipe runs with a run-off of 5 mm per metre.

#### *Flue gas outlet requirements for parallel systems*

Appliance	Diameter <sup>1</sup>	Maximum total length	L <sub>equivalent</sub> 90° bend	L <sub>equivalent</sub> 45° bend
BFC 28	80mm	25m	3.9m	1.1m
BFC 30	100mm	80m	4.6m	1.2m
BFC 50	100mm	45m	4.6m	1.2m
BFC 60	100mm	25m	4.6m	1.2m
BFC 28	100mm	100m	4.6m	1.2m
BFC 30	130mm	100m	2.4m	1.4m
BFC 50	130mm	100m	2.4m	1.4m
BFC 60	130mm	100m	2.4m	1.4m

1) Parallel systems with diameter of 130mm or 150mm. If the maximum total length for a diameter of 130mm is insufficient, 150mm diameter must be used. Any diameter enlargement must be carried out on both air supply and flue gas outlet.

You must use the longest pipe when calculating the pipe length. For example, if the chimney pipe is 35 metres and the air supply pipe is 32 metres, use 35 metres as the length for the calculation. Next, add the L<sub>equivalent</sub> for every 90° and 45° bend to this 35 metres, in *both* the air supply and flue gas outlet. The following practical example illustrates how to use the table.

#### Practical example of parallel flue gas outlet

##### **Example**

The diagram shows a BFC 30. This has to be fitted with a 25m parallel pipe 100mm in diameter, plus eight 90-degree bends. The configuration must be checked for compliance with the requirements stated in the table.

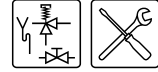

Appliance with parallel flue gas discharge material

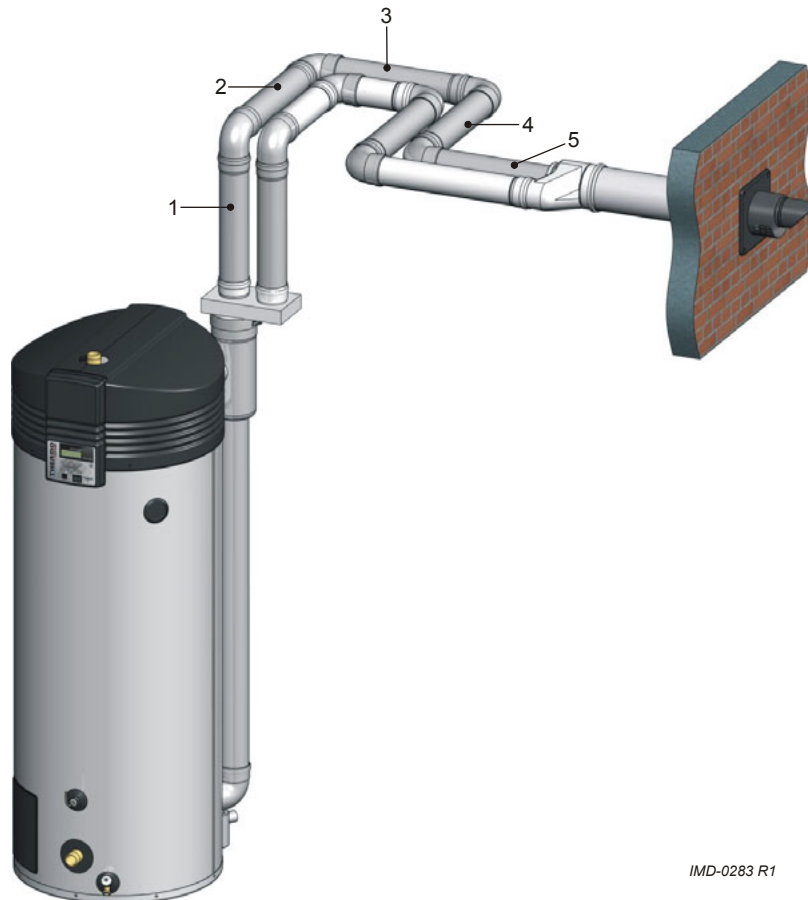

IMD-0283 R1

The longest pipe must be used to check the maximum length. In this case, the chimney pipe is the longest. This is 25 metres. This 25 metres is the sum of pipe sections 1, 2, 3, 4 and 5. The length of the transition piece can be ignored. The total number of bends used *in the flue gas outlet and air supply* is 8. The bend in the transition piece can be ignored. According to the table, 4.6 metres must be added for each bend. This brings the total pipe length to:

$$(4.6 \times 8) + 25 = 36.8 + 25 = 61.8\text{m.}$$

This is less than the maximum length of 80 metres stated in the table. The installation therefore fulfils the requirements.

### 3.10 Electrical connection

#### Warning

The installation should be carried out by an authorised installation engineer, in compliance with general and local regulations ([1.3 "Regulations"](#)).

#### 3.10.1 Introduction

Topics covered in this paragraph, in sequence:

- [Preparation](#);
- [Connecting the mains voltage](#);



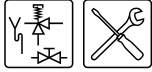

Optionally, it is possible to connect an isolating transformer, a continuous pump, a program-controlled pump, an extra ON mode switch and an extra alarm signal to the appliance. For these options, see:

- [Isolating transformer](#);
- [Connecting continuous pump](#);
- [Connecting a program-controlled pump](#);
- [Connecting an extra ON mode switch \("Tank ON"\)](#);

**Note**

The optional components are not included in the rating for electrical power consumption stated in the table (3.4.2 "General and electrical specifications").

### 3.10.2 Preparation

**Attention**

The appliance is phase-sensitive. It is **absolutely essential** to connect the mains phase (L) to the phase of the appliance, and the mains neutral (N) to the neutral of the appliance.

**Attention**

There may be **no potential difference** between neutral (N) and earth ( $\perp$ ). If this is the case, then an isolating transformer must be applied in the supply circuit (3.10.4 "Isolating transformer").

For more information or to order this isolating transformer, please contact A.O. Smith water Products Company.

The figure shows a view of the electrical connector block, and the table shows the appropriate connections.

Connector block

*Legend*

- A. screws
- B. protective cap
- C. connector block

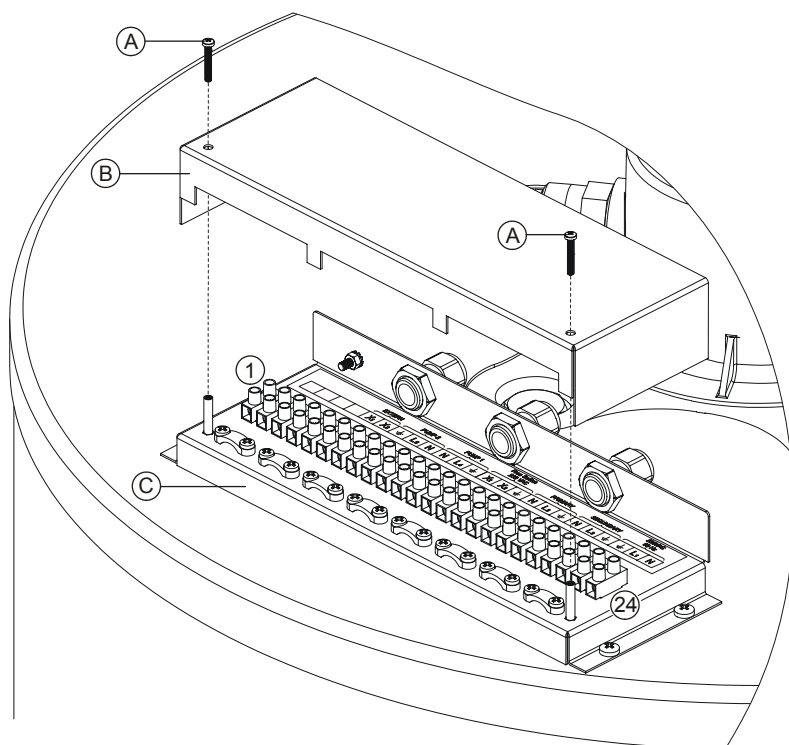

IMD-0077 R2



In preparation, you must first remove the two plastic covers and the protective cap of the electrical section.

1. Undo the screws of the plastic covers.
2. Carefully remove the covers from the appliance.  
The electrical section is now visible.
3. Loosen the 2 screws (A) of the electrical section, and remove the protective cap (B) from the electrical section.  
The connector block (C) is now visible.



### Note

Consult the table for the connections and consult the electrical diagram for the electrical component connections.

#### Electrical connector block

Unused	Tank ON		Continuous pump			Program-controlled pump			Alarm Off			Isolating transformer						Mains voltage		
												primary			secondary					
	X1	X2	⊥	L	N	N	L	⊥	X1	X2	⊥	N	L	⊥	N	L	⊥	N	L	⊥
1-4	5	6	7	8	9	10	11	12	13	14	15	16	17	18	19	20	21	22	23	24

### 3.10.3 Connecting the mains voltage

The appliance is supplied without a power cable and isolator.



### Note

In order to receive electrical power, the appliance has to be connected to the mains power by means of a permanent electrical connection. A double-pole isolator with a contact gap of at least 3 mm must be fitted between this permanent connection and the appliance. The power cable must have cores of at least 3 x 1.0 mm<sup>2</sup>.



### Warning

Leave the appliance isolated until you are ready to start it up.

1. Connect phase (L), neutral (N) and earth ( $\perp$ ) of the power cable to terminals 22 through 24 of the connection block as indicated in the table (3.10.2 "Preparation").
2. Fit the power cable in the strain relief.
3. Connect the power cable to the isolator.
4. If you have no more connections to make:
  - Fit the cap on the electrical terminal block.
  - Fit the plastic covers onto the appliance.

### 3.10.4 Isolating transformer

An isolating transformer should be used if there is a case of 'floating neutral'.

1. Refer to fitting instructions provided with the isolating transformer. (Contact the supplier for details of the correct isolating transformer.)
2. Connect phase (L), neutral (N) and earth ( $\perp$ ) to terminals 16 through 21 of the terminal block as stated in the table (3.10.2 "Preparation").
3. Fit the cables in the strain relief.

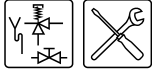

4. If you have no more connections to make:
  - Fit the cap on the electrical terminal block.
  - Fit the plastic covers onto the appliance.
5. Connect the power cable to the isolator.

### 3.10.5 Connecting continuous pump

1. Connect phase (L), neutral (N) and earth ( $\oplus$ ) to terminals 7, 8 and 9 as stated in the table (3.10.2 "Preparation").
2. Fit the cable in the strain relief.
3. If you have no more connections to make:
  - Fit the cap on the electrical terminal block.
  - Fit the plastic covers onto the appliance.

### 3.10.6 Connecting a program-controlled pump

1. Connect phase (L), neutral (N) and earth ( $\oplus$ ) to terminals 10, 11 and 12 as stated in the table (3.10.2 "Preparation").
2. Fit the cable in the strain relief.
3. If you have no more connections to make:
  - Fit the cap on the electrical terminal block.
  - Fit the plastic covers onto the appliance.

### 3.10.7 Connecting an extra ON mode switch ("Tank ON")

Tank ON is a facility for connecting an external ON/OFF switch. In the OFF position, the programmed operating state is active. In the ON position, the programmed operating mode is overruled, and the "ON mode" is active.

1. Connect cables ( $X_1$  and  $X_2$ ) to terminals 5 and 6 as indicated in the table (3.10.2 "Preparation").
2. Fit the cable in the strain relief.
3. If you have no more connections to make:
  - Fit the cap on the electrical terminal block.
  - Fit the plastic covers onto the appliance.

### 3.10.8 Connecting an extra error signal ('Alarm OUT' )

Alarm OUT is a potential free terminal that is switched when an error is detected. This can be used to signal errors, for example with a lamp. A 230 V circuit can be directly powered. Other voltages require a relay prescribed by the manufacturer.

1. Connect the phase cables ( $X_1$  and  $X_2$ ) to terminals 13 and 14 according to the table (3.10.2 "Preparation"). If required, connect earth ( $\oplus$ ) to terminal 15.
2. Fit the cable in the strain relief.
3. If you have no more connections to make:
  - Fit the cap on the electrical terminal block.
  - Fit the plastic covers onto the appliance.

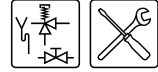

### 3.11 Checking the supply pressure and burner pressure

**Note**  
Before starting the appliance and/or checking the supply pressure and burner pressure, you must fill (5 "Filling") the appliance.

**Attention**  
Before starting up for the first time or after conversion, you must always check the supply pressure and burner pressure.

**Note**  
The easiest way to check the gas pressures is by using two pressure gauges. This procedure assumes that these two gauges are available.

#### Gas control

#### Legend

Only applicable numbers are mentioned.

1. supply pressure test nipple
2. burner pressure test nipple
3. burner pressure regulator
4. burner pressure control cap
5. burner pressure control adjusting screw

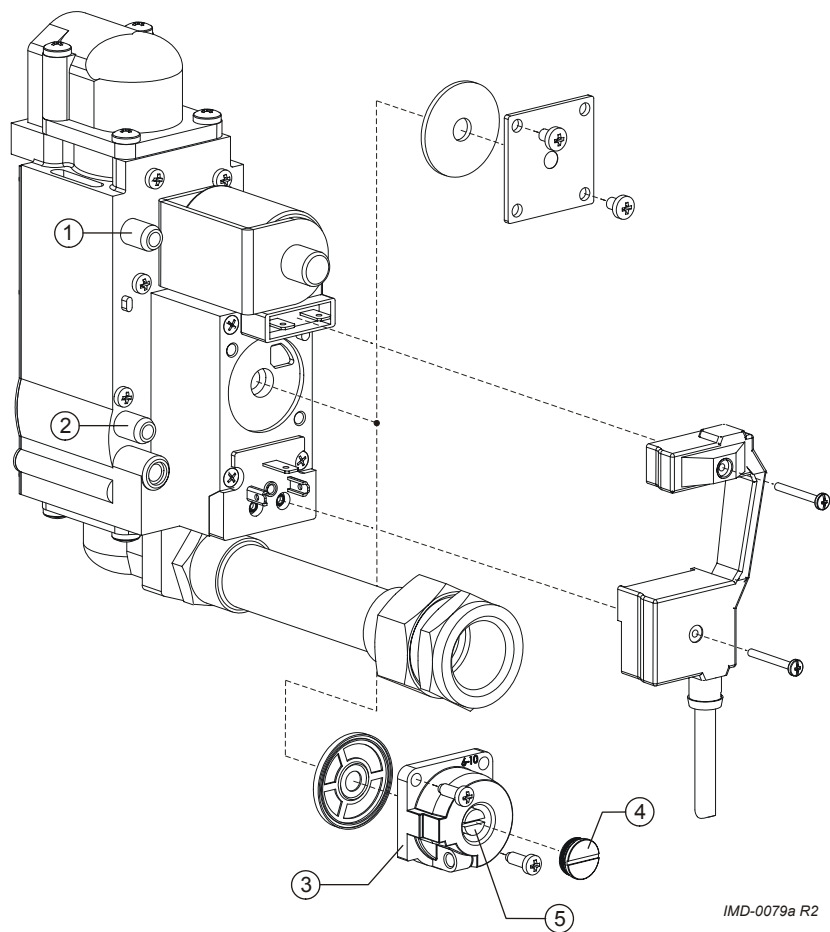

#### 3.11.1 Preparation

To check the supply pressure and burner pressure, proceed as follows:

1. Isolate (10.3 "Electrically isolating the appliance") the water heater from the power supply.
2. Undo the screws of the plastic covers.
3. Carefully remove the covers from the top of the appliance. The electrical section is now visible.

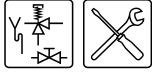

### 3.11.2 Procedure to check pressures

1. There are two test nipples on the gas control:
  - a supply pressure nipple (1)
  - a burner pressure nipple (2)Sealing screws are located inside the test nipples. Loosen both sealing screws by a few turns. Do not completely loosen them; they can be difficult to re-tighten.
2. Connect a pressure gauge to the burner pressure nipple (2).
3. Open the gas supply and vent the gas supply line with the supply pressure nipple (1).
4. Connect a pressure gauge to the supply pressure nipple (1) when gas starts to flow from this nipple.
5. Switch on the power to the appliance using the isolator on the appliance.
6. Switch the electronic controller **ON** by setting the 0/I switch to **position I**.



IMD-0423 R0

The display will now show **INTERNAL CHECK** for about 10 seconds and go to the main menu.

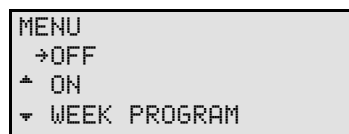
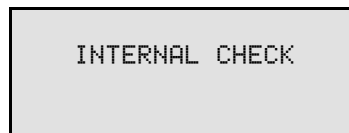

7. Activate the "ON mode" by going through the following steps:
  - Press the blue arrow once (▼) to position the cursor in front of **ON** and press **ENTER**. The display shown here will appear.

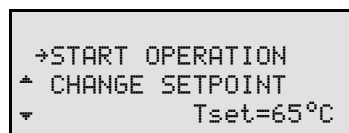

- Confirm the **ENTER** by pressing **START OPERATION**. The appliance is now in the "ON mode" and will ignite.
8. Once the display shows the text **RUNNING** you must wait about 1 minute before reading the dynamic pressures (the fan needs this time to run up to full rotational speed).

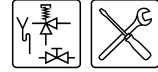

9. Use the pressure gauge to read the supply pressure at 1nipple (1) (3.4.3 "Gas data").

**Note**

Consult the mains gas supply company if the supply pressure is not correct.

10. Use the pressure gauge to read the burner pressure at nipple (2) (3.4.3 "Gas data").



If the burner pressure is not correct and the appliance is fitted with a blank plate, you will not be able to adjust the pressure. Finalise (3.11.4 "Finalising"), and in this case, consult your installation engineer or supplier.

If the appliance is indeed fitted with a burner pressure regulator, the pressure can be adjusted as described in the procedure (3.11.3 "Adjusting the pressure").

**3.11.3 Adjusting the pressure**

1. Remove the cap (4) from the burner pressure regulator (3).
2. Correct the burner pressure by turning the adjusting screw (5), depending on the correction required:
  - Adjustment screw anticlockwise: burner pressure decreases.
  - Adjustment screw clockwise: burner pressure increases.
3. Cover the opening of the adjusting screw and check the burner pressure against the value given in the gas table (3.4.3 "Gas data").
4. If the pressure is not set correctly, repeat the preceding steps until the correct pressure is attained.
5. Fit the cap (4) back on the burner pressure regulator.
6. Activate the "OFF mode" of the electronic controller:



7. If the MENU is not displayed:
  - press .
  - Use  and  to place the cursor beside OFF.
  - Confirm with ENTER.
8. Wait until the fan has stopped, and switch the electronic controller off.

**Attention**

Failure to wait until the fan stops can cause damage to the appliance.

9. Finish off (3.11.4 "Finalising").

**3.11.4 Finalising**

1. Shut off the gas supply.
2. Disconnect the two pressure gauges and retighten the sealing screws in the test nipples.
3. Replace the cover.

**Note**

Before starting-up the appliance, take time to fill in the warranty card supplied with the appliance. This enables us to guarantee the quality of our systems, and to further enhance our warranty procedure.

Please return this card as soon as possible. Your customer will then receive a warranty certificate with our warranty conditions.

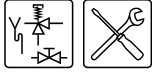

# 4 Conversion to a different gas category

## Attention

The conversion may only be carried out by an authorised installation engineer.

If the appliance must operate on a family of gases (LP gas or natural gas) or other gas category than that for which the appliance has been set at the factory, the appliance will have to be adapted using a special conversion kit.

## Attention

You must check the supply pressure and burner pressure once the conversion is complete.

### Orifice assembly

#### Legend

1. connector
2. gas coupling
3. air supply hose
4. pressure switch hose
5. gas/air distribution plate
6. stamped figures

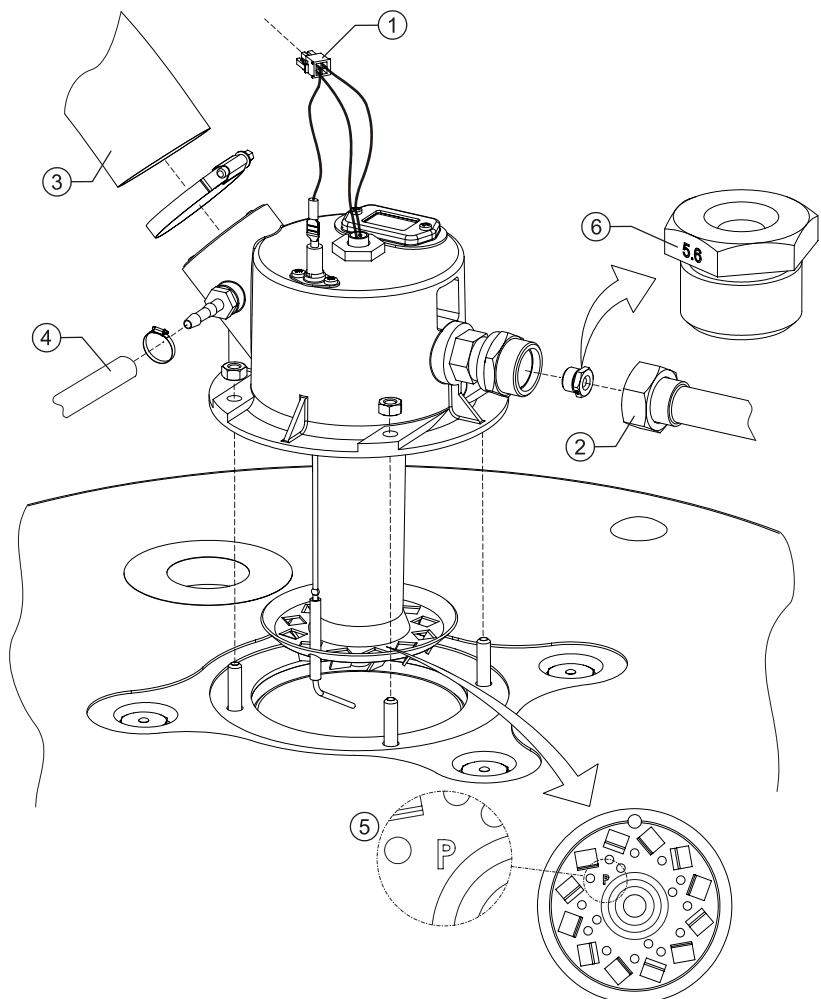

IMD-0078 R3

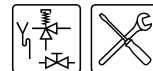

1. Isolate the water heater from the power supply (10.3 "Electrically isolating the appliance").
2. Shut off the gas supply.
3. Undo the screws of the plastic covers.
4. Carefully remove the covers from the top of the appliance.
5. Detach the connector (1) that connects the leads of the hot surface igniter and the flame probe to the controller.
6. Detach the three-part gas coupling (2) adjacent to the burner.
  - Detach the air supply hose (3).
  - Detach the pressure switch hose (4).
7. Remove the burner as complete assembly.
8. Place and fit the burner with parts from the conversion kit.

#### Note

The burner for LP gases can be recognised by the letter 'P' which is stamped into the metal of the gas/air distribution plate (5).

9. Select and fit the correct orifice from the conversion kit, based on the gas table (3.4.3 "Gas data"). The injector diameter is stamped into each injector (6).

#### Conversion of gas control

##### Legend

- 7. burner pressure regulator
- 8. blank plate
- 9. gas control connector

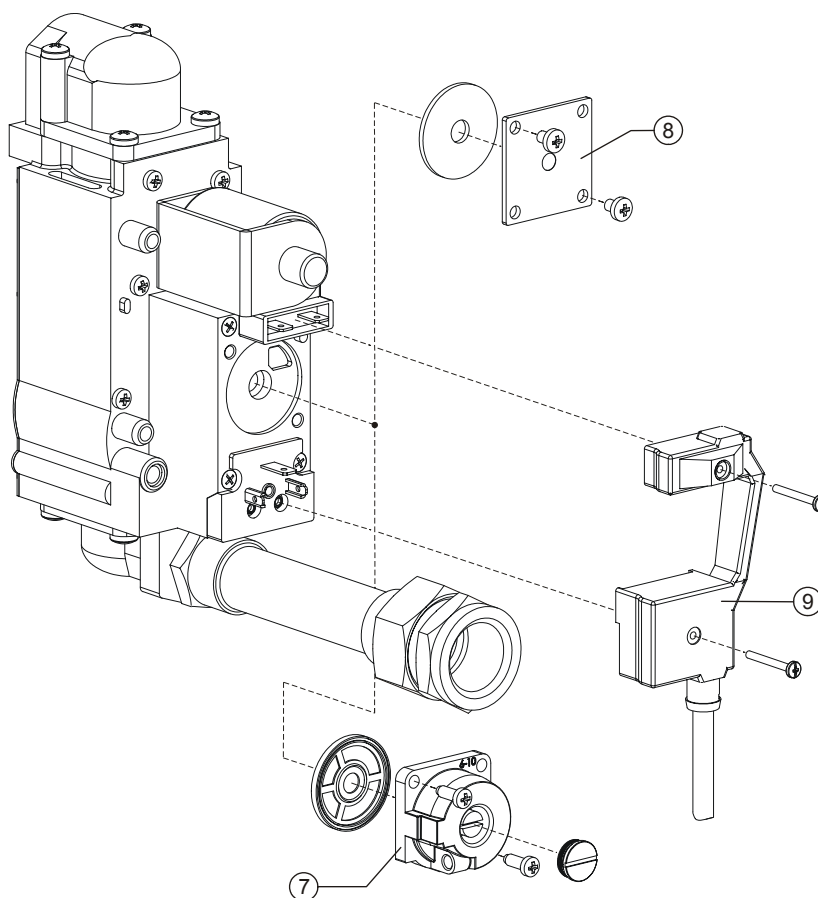

IMD-0079b R2



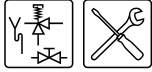

10. Check whether there is a burner pressure regulator (7) attached to the top of the gas control, or simply a blank plate (8).

---

**Note**

In the event of the supply pressure for a gas category being the same as the burner pressure (3.4.3 "Gas data"), the gas control must be fitted with a blanking plate with a cork gasket. A burner pressure that deviates with respect to the supply pressure requires a burner pressure regulator with rubber gasket to be used. Each conversion kit contains all the necessary components.

---

11. If the blank plate or burner pressure regulator need to be replaced:
  - Unscrew the connector (9) from the gas control.
  - If necessary, remove the blank plate or burner pressure regulator (7).
  - If necessary, fit the blank plate or burner pressure regulator supplied with the conversion kit.
  - Fit the gas control's connector (9).
12. Fit the connector (1) of the hot surface igniter and flame probe to the controller.
13. Fit the 3-part gas coupling (2).
14. Check the burner pressure and supply pressure (3.11 "Checking the supply pressure and burner pressure").
15. Replace the cover.
16. Remove the sticker showing the new gas category from the conversion kit, and attach it below the appliance's rating plate. This clearly indicates that the appliance may no longer be run on the gas for which it was originally supplied.

# 4

## Conversion to a different gas category

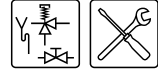

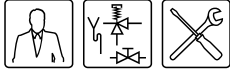

# 5 Filling

## Installation diagram

### Legend

Only applicable numbers are mentioned.

1. pressure reducing valve (mandatory)
  3. T&P valve (mandatory)
  4. stop valve (recommended in pipe C and mandatory in pipe A)
  5. non-return valve (mandatory)
  6. circulation pump (optional)
  9. drain valve
  10. manual gas valve (mandatory)
  11. service stop valve
  12. temperature gauge (optional)
  13. condensation drainage
  14. hot water draw-off points
  15. expansion valve (mandatory)
  16. expansion vessel (mandatory)
  17. 3-way aeration valve (recommended)
  18. water tank
  19. float valve
- A. cold water supply  
 B. hot water supply  
 C. circulation pipe  
 D. gas supply  
 E. overflow pipe  
 H. overflow pipe

UNVENTED

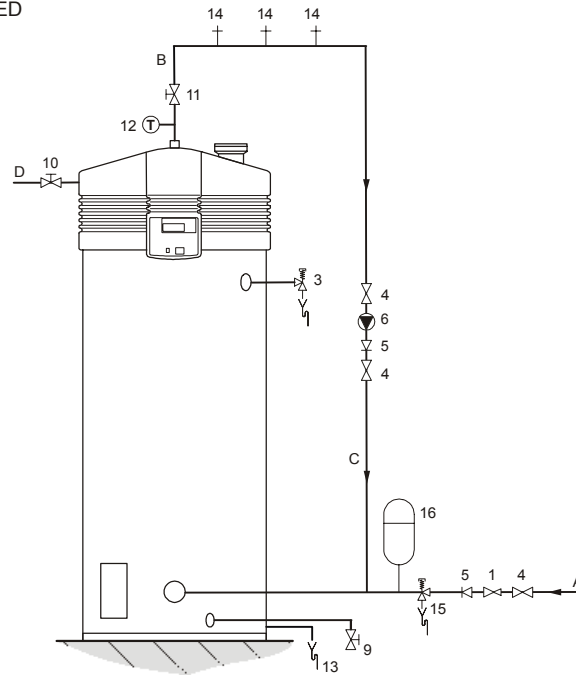

VENTED

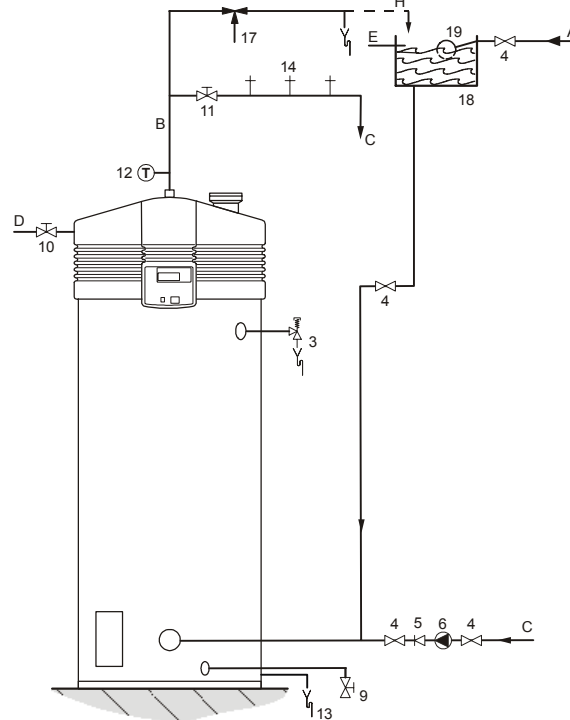

IMD-0464 R0

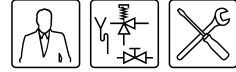

## 5.1 Filling the appliance

### 5.1.1 Filling unvented installations

To fill the appliance, proceed as follows:

1. Open the stop valve (11) in the hot water pipe and, if present, the stop valves (4) for the circulation pump (6).
2. Close the drain valve (9).
3. Open the nearest hot water draw-off point (14).
4. Open the stop valve (4) on the cold water side (A) so that cold water flows into the appliance.
5. Completely fill the appliance. When a full water jet flows from the nearest draw-off point, the appliance is full.
6. Bleed the entire installation of air, for example by opening all draw-off points.
7. The appliance is now under water supply pressure. There should be no water coming out of the expansion valve (15), nor the T&P valve (3). If this does happen, the cause might be:
  - The water supply pressure is greater than the specified 8 bar. Rectify this by fitting a pressure reducing valve (1).
  - The expansion valve in the protected cold supply setup is defective or incorrectly fitted.

### 5.1.2 Filling vented installations

To fill the appliance, proceed as follows:

1. Open the stop valve (11) in the hot water pipe and, if present, the stop valves (4) for the circulation pump (6).
2. Close the drain valve (9).
3. Open the nearest hot water draw-off point (14).
4. Open the stop valve (4) on the cold water side (A) so that cold water flows into the appliance.
5. Completely fill the appliance. When a full water jet flows from the nearest draw-off point, the appliance is full.
6. Bleed the entire installation of air, for example by opening all draw-off points.
7. The appliance is now under water supply pressure. There should be no water coming out of the T&P valve (3). If this does happen, the T&P valve might be defective or incorrectly fitted.

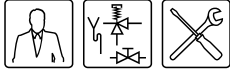

# 6 Draining

## Installation diagram

### Legend

Only applicable numbers are mentioned.

1. pressure reducing valve (mandatory)
  3. T&P valve (mandatory)
  4. stop valve (recommended in pipe C and mandatory in pipe A)
  5. non-return valve (mandatory)
  6. circulation pump (optional)
  9. drain valve
  10. manual gas valve (mandatory)
  11. service stop valve
  12. temperature gauge (optional)
  13. condensation drainage
  14. hot water draw-off points
  15. expansion valve (mandatory)
  16. expansion vessel (mandatory)
  17. 3-way aeration valve (recommended)
  18. water tank
  19. float valve
- A. cold water supply  
 B. hot water supply  
 C. circulation pipe  
 D. gas supply  
 E. overflow pipe  
 H. overflow pipe

UNVENTED

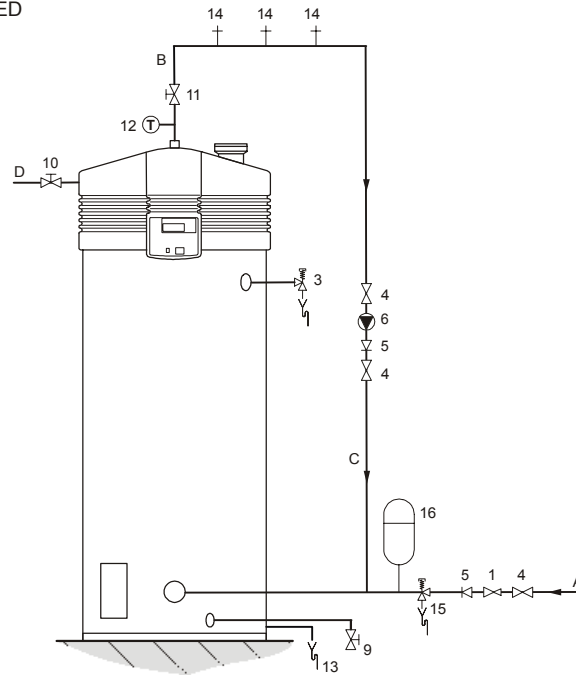

VENTED

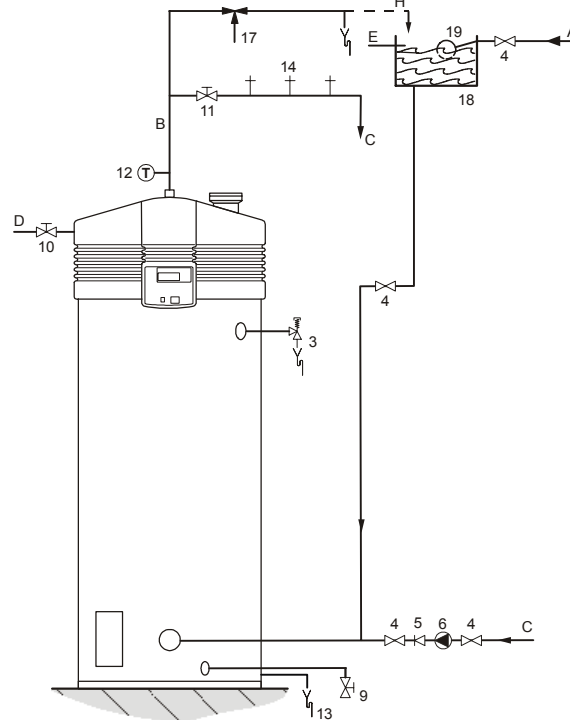

IMD-0464 R0

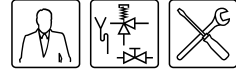

### 6.1 Draining unvented installations

1. Activate the MENU with .

```

MENU
→OFF
↑ ON
↓ WEEK PROGRAM
  
```

2. Position the cursor in front of OFF.
3. Confirm OFF with ENTER.
4. Wait until the fan has stopped. The symbol  is then dimmed.



#### Attention

Failure to wait until the fan stops purging can cause damage to the appliance.

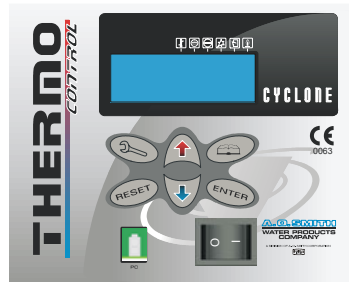

5. Switch the appliance OFF (position 0) using the ON/OFF switch on the control panel.



IMD-0423 R0

6. Isolate the water heater from the power supply by putting the isolator between the appliance and the mains power supply to position 0.
7. Shut off the gas supply (10).
8. Close the stop valve (11) in the hot water pipe.
9. Close the supply valve (4) in the cold water supply (A).
10. Open the drain valve (9).
11. Bleed the appliance (or installation) so that it drains completely.

### 6.2 Draining vented installations

1. Activate the MENU with .
2. Position the cursor in front of OFF.
3. Confirm OFF with ENTER.
4. Wait until the fan has stopped. The symbol  is then dimmed.



#### Attention

Failure to wait until the fan stops purging can cause damage to the appliance.

5. Switch the appliance OFF (position 0) using the ON/OFF switch on the control panel.

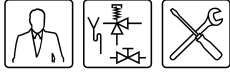

IMD-0423 R0

6. Isolate the water heater from the power supply by putting the isolator between the appliance and the mains power supply to position 0.
7. Shut off the gas supply (10).
8. Close the stop valve (11) in the hot water pipe.
9. Close the stop valve (4) between the water tank and the cold water inlet (A).
10. Open the drain valve (9).
11. Bleed the appliance (or installation) so that it drains completely.

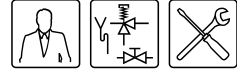



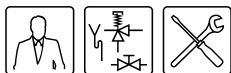

# 7 The control panel

## 7.1 Introduction

Topics covered in this chapter:

- [Controls](#);
- [Meaning of icons](#);
- [Electronic controller ON/OFF switch](#);
- [Navigation buttons](#);
- [PC connection](#).

## 7.2 Controls

The figure shows the electronic controller.





IMD-0423 R0

The control panel is completely menu-driven, and comprises:

- a 4-line display with 20 characters per line;
- 6 pushbuttons for operating the appliance (below the display);
- 6 graphical symbols (above the display);
- a connector for a service PC;
- an ON/OFF switch.

The pushbuttons are divided into three groups:

- Navigation buttons:
  - Buttons for UP ↑, and DOWN ↓;
  - Enter: ENTER;
  - Reset button: RESET
- the main menu (11 "Main menu"): ;
- the service program (12 "Service program"): . This chapter is specifically intended for the service and maintenance engineer and installation engineer.



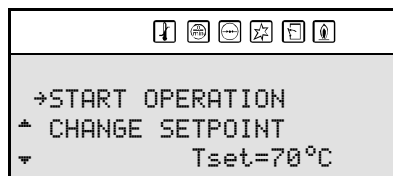



In this manual, the display of the electronic controller is shown as in the figure, both with and without icons.



## 7.3 Meaning of icons

The table explains the meanings of the icons.

*Icons and their meaning*

	Name	Meaning
	Heat demand	Heat demand detected
	Purge	Pre- and post-purge using fan
	Pressure switch	Pressure switch is closed
	Glowing	(Pre)glow
	Gas control	Gas control open/ignition
	Flame detection	Appliance operational

## 7.4 Electronic controller ON/OFF switch

The ON/OFF switch of the electronic controller is used to switch the appliance ON and OFF. Note that in the OFF position the appliance remains electrically live, in order for the continuous pump to stay running.

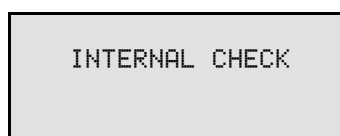

After switching on, the text INTERNAL CHECK appears on the display for about 10 seconds. The main menu (11 "Main menu") then appears. If no selection is made in the main menu, the appliance automatically switches to the OFF mode (8.2 "Operating modes").

### Note

To electrically isolate the appliance, you must use the isolator between the appliance and the mains power supply.

## 7.5 Navigation buttons

The use of these buttons is explained with the help of the figure that shows the main menu (11 "Main menu").

The navigation buttons are:

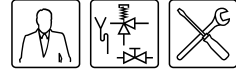

- Buttons for UP ↑, and DOWN ↓;
- Enter: **ENTER**;
- Reset button: **RESET**.

The ↑ arrows and ↓ indicate that you can scroll up and/or down. Use the buttons ↑ and ↓ to scroll.

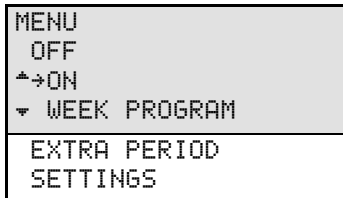

The cursor → points to the option to be activated. In the display as shown in the figure, you can scroll through the main menu.

The main menu comprises: OFF, ON, WEEK PROGRAM, EXTRA PERIOD and SETTINGS. You have to scroll down further to see the options EXTRA PERIOD and SETTINGS.

The selected option is confirmed using **ENTER**.

Pressing the **RESET** button takes you back one page in a menu and discards all options selected in the current menu.



#### Note

The **RESET** button is also used to reset the appliance following an error.

## 7.6 PC connection

The PC connection is solely intended to enable technicians from A.O. Smith to display the status and history of the appliance. These details can be important for troubleshooting and/or responding to complaints.

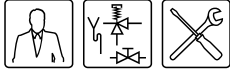

# 8 Status of the appliance

## 8.1 Introduction

Topics covered in this chapter:

- [Operating modes](#);
- [Error conditions](#);
- [Service condition](#).

## 8.2 Operating modes

When running, the appliance has four basic operating modes, namely:

- OFF
- ON
- EXTRA
- PROG

### 8.2.1 OFF

In this mode, the frost protection is activated. The figure shows the display with the following information:

- line one: the text OFF;
- line two: the time, the day and alternately (9.3 "The appliance's heating cycle")  $T_1$  and  $T_{net}$ ;
- lines three and four: the text FROST PROTECTION ACTIVATED.

```
OFF
13:45 Thursday 6°C
FROST PROTECTION
ACTIVATED
```

### 8.2.2 ON

In this mode, the appliance continually responds to the hot water demand. The figure shows the display with the following information:

- line one: the text ON;
- line two: the time, the day and alternately (9.3 "The appliance's heating cycle")  $T_1$  and  $T_{net}$ ;
- line three: the programmed water temperature  $T_{set}$ ;

- line four: blank when the appliance is idle, or depending on the heating cycle (9.3 "The appliance's heating cycle"), displays a text such as HEAT DEMAND.

```
ON
13:45 Thursday 67°C
Tset 75°C
```

### 8.2.3 EXTRA

In this mode, one extra period is programmed and activated. In this mode, the OFF or PROG mode is temporarily overruled to fulfil a single period of demand. Once the period has passed, the appliance automatically returns to the previous operating mode. The figure shows the display with the following information:

- line one: the text EXTRA;
- line two: the time, the day and alternately (9.3 "The appliance's heating cycle")  $T_1$  and  $T_{net}$ ;
- line three: the switch-on time, and the related water temperature setting;
- line four: the text PERIOD ACTIVATED.

```
EXTRA
12:30 Thursday 76°C
TH 12:45 Tset 75°C
PERIOD ACTIVATED
```

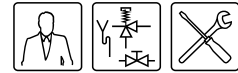

### 8.2.4 PROG

In this mode a preset week program is active, and the appliance responds continually to demand within the time periods set in the week program. There are two distinct situations possible in this mode:

```
PROG
10:00 Monday 76°C
MO 11:15 Tset 75°C
```

#### 1. The current time falls within a set time period of the week program.

The figure shows the display with the following information:

- line one: the text PROG;
- line two: the time, the day and  $T_1$  and  $T_{net}$  alternately (9.3 "The appliance's heating cycle");
- line three: the next scheduled switch-off time and the water temperature  $T_{set}$  of the active period;
- line four: is empty, or depending on the heating cycle (9.3 "The appliance's heating cycle"), a text such as HEAT DEMAND.

```
PROG
12:00 Monday 76°C
MO 11:15
PERIOD ACTIVATED
```

#### 2. The current time falls outside a set time period of the week program.

The figure shows the display with the following information:

- line one: the text PROG;
- line two: the time, the day and  $T_1$  and  $T_{net}$  alternately (9.3 "The appliance's heating cycle");
- line three: the next scheduled switch-on time;
- line four: displays the text PERIOD ACTIVATED.

In all modes, the temperature may at any moment drop below the desired temperature. The appliance then enters a heating cycle. This heating cycle is identical (9.3 "The appliance's heating cycle") for all basic operating modes.



#### Note

Setting and if necessary programming of the basic operating modes are described in the main menu (11 "Main menu") chapter.

### 8.3 Error conditions

The figure shows an example of an error condition. If the appliance enters this condition, the display will show the following information:

- line one: error code comprising a letter and two digits, followed by the error description;
- lines two to four: alternately, a brief explanation of the error, and a brief action to resolve the error.

```
S04: SENSOR ERROR

CHECK
SENSOR OR DUMMY
```



#### Attention

The displayed action to resolve the error may only be performed by a service and maintenance engineer.

There are various types of errors:

- LOCK OUT ERRORS  
When the cause has been removed, these errors require a reset with the button RESET before the appliance can resume operation.
- BLOCKING ERRORS  
These errors disappear automatically once the cause of the error has been removed, after which the appliance resumes operation by itself.

The display does not show what type of error has been detected. A comprehensive overview of the errors is provided elsewhere in the manual (13 "Troubleshooting").

If, as end-user, you find the appliance in an error condition, you may attempt to restart the appliance by pressing the RESET button

However, if the error returns or occurs several times in a short time you must contact your service and maintenance engineer.

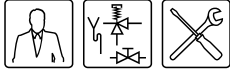

#### 8.4 Service condition

The figure shows the message

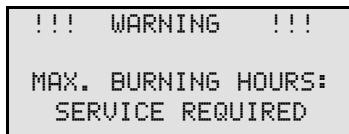

**SERVICE REQUIRED.** Should this message appear, then the appliance is in need of a service and maintenance inspection. In that case, contact your service and maintenance engineer.

---

#### Note

The message **SERVICE REQUIRED** is based on the number of expired burning hours and the preset service interval. Should the service interval have been incorrectly selected, contact the service and maintenance engineer for instructions on how to adjust this. Information on the maintenance frequency is provided elsewhere in the manual ([14 "Maintenance frequency"](#)).

---

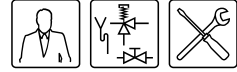



# 9 Starting and running

## 9.1 Introduction

Topics covered in this chapter, in sequence:

- [Starting and running.](#)
- [The appliance's heating cycle.](#)

## 9.2 Starting and running

Start the appliance as follows:

1. Fill the appliance ([5 "Filling"](#)).
2. Open ([3.5 "Installation diagram"](#)) the manual gas valve.
3. Switch on the power to the appliance using the isolator between the appliance and the power supply.
4. Switch the electronic controller **ON** by setting the ON/OFF switch to **position I**.

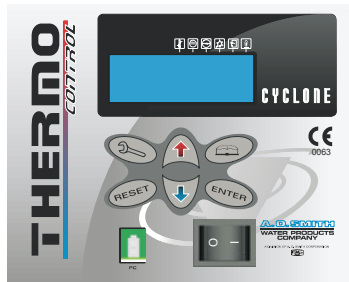

IMD-0423 R0

The display will now show **INTERNAL CHECK** for about 10 seconds and go to the main menu.

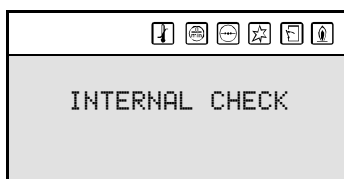

5. Press the blue arrow once (↵) to position the cursor in front of **ON** and press **ENTER**. The display shown in the figure will appear.

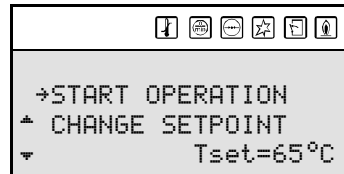

6. Confirm the **START OPERATION** by pressing **ENTER**.

The appliance is now in "ON mode". If there is a heat demand, the appliance will run through the heating cycle ([9.3 "The appliance's heating cycle"](#)).

If the heating cycle is not run, there is no heat demand; if this is the case, Tset will probably need to be set ([11.4 "Setting the water temperature"](#)).

## 9.3 The appliance's heating cycle

The appliance's heating cycle is activated as soon as the measured water temperature ( $T_{net}$ ) falls below the threshold value ( $T_{set}$ ). This threshold value depends on the currently selected appliance operating mode. For example, if the appliance is in "OFF mode" (frost protection), then this value is 5°C. If the appliance is in "ON mode", then this threshold value is selectable, for example, 65°C.

The heating cycle runs in turn through the following states:

1. HEAT DEMAND;
2. PRE-PURGE;
3. PRESSURE SWITCH;
4. PRE-GLOW;
5. IGNITION;
6. RUNNING;
7. POST-PURGE.

The complete cycle is explained in the following example, which assumes the appliance is in the basic mode **ON**.

### Note

The same heating cycle applies to the other operating modes.

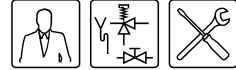

Once the appliance starts, it will run through the following steps:

1. The water temperature drops below the set temperature of (for example) 65°C. The electronic controller detects a demand and starts the heating cycle.
  - The icon is activated.
  - The message HEAT DEMAND appears.

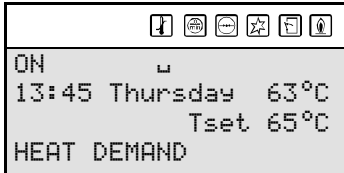

2. Once demand is registered, the fan is started to exhaust any gases that may be present. This phase is called pre-purge and lasts about 15 seconds.
  - The icon is activated.
  - The message PRE PURGE appears.

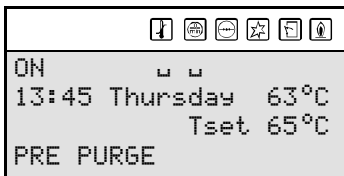

3. During the pre-purge, the pressure switch closes.
  - The icon is activated.
  - The message PRESSURE SWITCH appears.

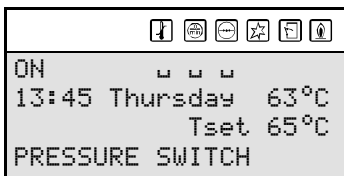

4. After some time, the pre-purge ceases and the electronic controller reduces the fan speed to the ignition speed. This is followed by the (pre-)glow of the hot surface igniter.
  - The icons and are dimmed.
  - The icon is activated.

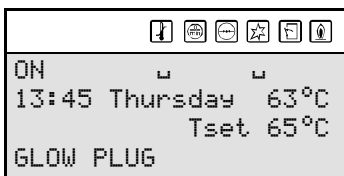

5. After a number of seconds pre-glow, the gas control is opened and ignition takes place.
  - The icon is activated.
  - The message IGNITION appears.

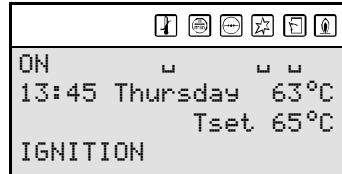

6. After ignition, the flame is detected and the appliance will be running. This means that actual heating has started. The fan speed then increases to the normal working speed, and the pressure switch closes:
  - The icon is dimmed.
  - The icons and are activated.
  - The message RUNNING appears.

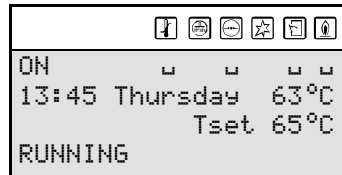

7. When the water is up to temperature, the heat demand drops off and the post-purge starts. This lasts about 25 seconds.
  - The icons , and are dimmed.
  - The icon is activated.
  - The message POST PURGE appears.

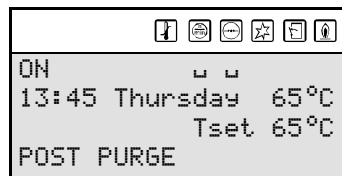

8. Following the post-purge, the fan stops and the pressure switch opens:
  - The icons and are dimmed.
  - The message POST PURGE vanishes.

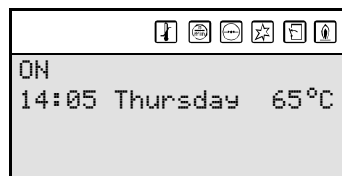

With any subsequent heat demand, the heating cycle will resume from step 1.



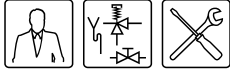

# 10 Shutting down

## 10.1 Introduction

This chapter describes:

- Shut the appliance down for a brief period ("OFF mode");
- Electrically isolating the appliance;
- Shutting the appliance down for a long period.

## 10.2 Shut the appliance down for a brief period ("OFF mode")

To shut the appliance down for a brief period, you must activate the frost protection.

You can use the frost protection to prevent water freezing in the appliance.

Activate the frost protection as follows:

1. Press the button to select the main menu.
2. Use and to position the cursor in front of OFF. Confirm with ENTER.

```
OFF
13:45 Thursday 6°C
FROST PROTECTION
ACTIVATED
```

The frost protection cuts in if the water temperature drops below 5°C. The text FROST will then appear on line one of the display. The appliance heats the water to 20°C (T<sub>set</sub>) and drops back to the OFF mode.

**Note**  
These values of 5°C and 20°C cannot be adjusted.

## 10.3 Electrically isolating the appliance

The appliance should only be isolated from mains power in the correct way. The correct procedure is as follows:

1. Activate the MENU with .
2. Position the cursor in front of OFF.
3. Confirm OFF with ENTER.

```
MENU
→OFF
▲ ON
▼ WEEK PROGRAM
```

**Attention**  
Failure to wait until the fan stops purging can cause damage to the appliance.

4. Wait until the fan has stopped. The symbol is then dimmed.
5. Switch the appliance **OFF (position 0)** using the ON/OFF switch on the control panel.



IMD-0423 R0

6. Isolate the appliance from the power supply by setting the isolator between the appliance and the mains power supply to position 0.

## 10.4 Shutting the appliance down for a long period

Drain the appliance if you are shutting it down for a long period. Proceed as follows:

1. Isolate the appliance from the power supply (10.3 "Electrically isolating the appliance").
2. Shut off the gas supply.
3. Close the stop valve in the hot water pipe.
4. Close the supply valve of the protected cold supply set-up.
5. Open the drain valve
6. Bleed the appliance (or installation) so that it drains completely.

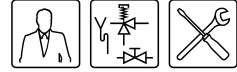



# 11 Main menu

## 11.1 Introduction

The MENU is reached by pressing the  button on the electronic controller.

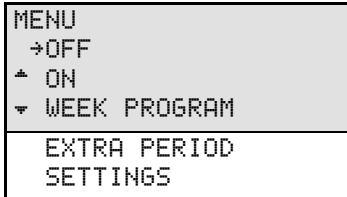

The main menu comprises:

- OFF  
Select this option if you wish to turn off (10 "Shutting down") the appliance for a brief period, but do not wish to drain it. In this mode, the frost protection is active. This prevents water from freezing in the appliance.
- ON  
In this mode, the appliance continually responds to the hot water demand. (11.3 "Switching on the "ON mode"")
- WEEK PROGRAM  
Select this option to allow the appliance to respond to demand only during pre-programmed periods (11.5 "Week program"). Outside those periods, only frost protection is active.
- EXTRA PERIOD  
Select this option to overrule the OFF mode or PROG mode (i.e. Week program) so that a single temporary period (11.10 "Extra period") of heat demand will be fulfilled.
- SETTINGS  
Select this option to set (11.12 "Settings") the language and the time. You can also use this option to display the regulation interval (temperature), and the ignition and working speeds of the fan.

### Note

If you fail to make any selection with the main menu open, then after 30 seconds, the appliance will automatically return to the mode it was previously in.

## 11.2 Notational convention for menu-related instructions







The MENU () of the electronic controller is divided into submenus. For example, SETTINGS is one of the functions reached from the main menu. The SETTINGS menu is divided into submenus in turn.

For example, LANGUAGE is a submenu of SETTINGS. So, for example, to select the LANGUAGE menu, this manual uses the following notational convention:

-  : SETTINGS | LANGUAGE

Confirm with ENTER.

This means:

1.  : Activate the main menu with .
2. SETTINGS: Use the  and/or  buttons to go to SETTINGS and confirm with ENTER.
3. LANGUAGE: Use the  and/or  buttons to go to LANGUAGE
4. Confirm with ENTER. After entering ENTER, you will have activated the LANGUAGE submenu.

## 11.3 Switching on the "ON mode"

You can switch the appliance to the ON mode from any operational mode, as follows:

1.  : ON | START OPERATION

Confirm with ENTER.

### Note

First consult the chapter about switching on (9 "Starting and running") too.

## 11.4 Setting the water temperature

### 11.4.1 Setting the water temperature via the SET POINT MENU

The water temperature can be set to any value between 40°C and 80°C.



Set the water temperature via:

1.  : ON | CHANGE SETPOINT

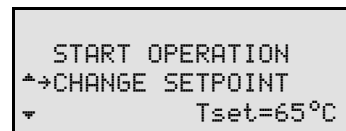
Confirm with ENTER.



2. Use:

-  to increase the value;
-  to decrease the value.

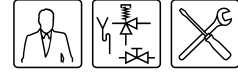

- Confirm with **ENTER**. After confirming, the appliance enters "ON mode".

```
SETPOINT
  → 65°C
```

#### Note

If the preset temperature is higher than the current water temperature, then the appliance might **not** immediately start the heating cycle. To prevent excessively frequent switching on and off, there is a heating margin. The standard setting for this margin is 4°C. The appliance starts heating when the water temperature is 4°C colder than the SETPOINT. We refer to this margin as the hysteresis. The service and maintenance engineer can adjust (12.2 "Setting the hysteresis") this setting.

### 11.4.2 Setting water temperature during ON mode

The water temperature can also be directly adjusted when the appliance is in the "ON mode". Simply use:

- **↑** to increase the value;
- **↓** to decrease the value.
- Confirm with **ENTER**.

```
ON
13:45 Thursday 65°C
      Tset→65°C
```

### 11.5 Week program

Using the week program, you can set the water temperature for the days and times you want.

If the appliance is running under a week program, this is indicated on the display by the **PROG** text on the first line (see the figure). The second line shows the time of day, the day of the week and the temperature. The third line shows the next switching time of the week program and the programmed temperature. The fourth line shows the **PROGRAM ACTIVATED** text.

```
PROG
07:55 Monday 64°C
MO 08:00 Tset 75°C
PROGRAM ACTIVATED
```

The appliance's default week program switches the appliance on every day at 00:00 and off at 23:59. The default water temperature setting is 65°C.

If you want, you can change every setting in the appliance's standard week program.

If the water temperature becomes too low while the week program is running, the appliance will run through the heating cycle (9.3 "The appliance's heating cycle") and return to the week program.

The following are discussed:

- [Starting and stopping the week program](#)
- [Changing the appliance's standard week program](#)
- [Adding times to a week program](#)
- [Deleting times from a week program](#)

### 11.6 Starting and stopping the week program

The week program can be started up from any other operating mode, as follows:

1. **☰**: WEEK PROGRAM | START OPERATION  
Confirm with **ENTER**.

A week program can be shut down simply by activating a different operating mode, for example the "ON mode".

### 11.7 Changing the appliance's standard week program

#### Note

First fill-in the desired week program on the supplied week program card.

A week program is made up of a number of programmable periods in which you can have the appliance switch on and off. A period consists of:

- switch-on time: day of the week, hours and minutes;
- switch-off time: hours and minutes;
- the water temperature setting;
- on/off setting for a program-controlled pump.

#### Note

The switch-off time must always be followed by a switch-off time on the same day of the week. A maximum of **three** periods may be programmed per day. You can program a maximum of **21** periods.

Call up the menu for the week program as follows:

- **☰**: WEEK PROGRAM | PROGRAM OVERVIEW.  
Confirm with **ENTER**.

```
WEEK PROGRAM
START OPERATION
↵PROGRAM OVERVIEW
▼
```

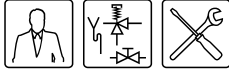

The display shows the menu for the week program, see the figure below. With the default setting, the program switches on and off every day at 00:00 and 23:59 hours respectively, the water temperature is 65°C and the pump is switched on (P).

DAY	TIME	Tset	
ON →SU	00:00	65°C	P
OFF SU	23:59		
ON MO	00:00	65°C	P
OFF MO	23:59		
ON TU	00:00	65°C	P
OFF TU	23:59		
ON WE	00:00	65°C	P
OFF WE	23:59		
ON TH	00:00	65°C	P
OFF TH	23:59		
ON FR	00:00	65°C	P
OFF FR	23:59		
ON SA	00:00	65°C	P
OFF SA	23:59		
INSERT			
DELETE			
START OPERATION			

### Example

As an example, we will set the switch-on time for Sunday to 08:15 hours, and the matching switch-off time to 12:45 hours. The water temperature will be set to 75 °C and the pump will run continuously. The following settings are entered one by one via the menu: the switch-on time, the switch-off time, the desired water temperature, and the mode of the program-controlled pump.

#### 11.7.1 Week program: setting the switch-on time

1. Bring the cursor to SU  
Confirm with ENTER.

ON →SU	00:00		
OFF SU	23:59		
Tset	65°C		
PUMP ON		SAVE	

The day indicated by → flashes.

2. Use ↑ and ↓ to set the desired day. In the example this is SU (Sunday).

Confirm with ENTER.

ON SU→00:00			
OFF SU	00:59		
Tset	65°C		
PUMP ON		SAVE	

The cursor moves to the hour digits, which flash.

3. Use ↑ and ↓ to set the hours. In the example, this is 08.

Confirm with ENTER.

The cursor moves to the minute digits, which flash.

ON SU	08→00		
OFF SU	08:00		
Tset	65°C		
PUMP ON		SAVE	

#### Note

Because the switch-off time can never be earlier than the switch-on time, the switch-off time setting is automatically adjusted with the switch-on time.

4. Use ↑ and ↓ to set the minutes. In the example, this is 15.

Confirm with ENTER.

The cursor moves to the switch-off hour digits, which flash.

ON SU	08:15		
OFF SU→08:15			
Tset	65°C		
PUMP ON		SAVE	

#### 11.7.2 Week program: setting the switch-off time

1. Use ↑ and ↓ to set the hours. In the example, this is 12.

Confirm with ENTER.

The cursor moves to the minute digits, which flash.

ON SU	08:15		
OFF SU	12→15		
Tset	65°C		
PUMP ON		SAVE	

2. Use ↑ and ↓ to set the minutes. In the example, this is 45.

Confirm with ENTER.

The cursor moves to the desired water temperature.

ON SU	08:15		
OFF SU	12:45		
Tset→65°C			
PUMP ON		SAVE	

#### 11.7.3 Week program: setting the water temperature

1. Use ↑ and ↓ to set the water temperature. In the example this is 75°C.

Confirm with ENTER.

The cursor moves to PUMP ON

ON SU	08:15		
OFF SU	12:45		
Tset	75°C		
PUMP→ON		SAVE	

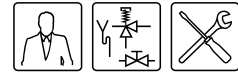

### 11.7.4 Week program: setting the program-controlled pump

- If required, a pump can be controlled during the period. Use **↑** and **↓** to set PUMP ON. The pump ensures a regular circulation of hot water in the hot water pipes. You can skip this step if you there is no pump in your hot water circuit.

Confirm with **ENTER**.

The cursor moves to **SAVE**.

```
ON  SU 08:15
OFF SU 12:45
Tset 75°C
PUMP→ON      SAVE
```

- Confirm with **ENTER**.

The display shown in the figure will appear.

```
DAY TIME Tset
ON →SU 08:15 75°C P
OFF SU 12:45
ON  MO 00:00 65°C P
OFF MO 23:59
ON  TU 00:00 65°C P
OFF TU 23:59
```

- If you wish, you can use **↓** to scroll to another day, and change more switch-on times (11.7.1 "Week program: setting the switch-on time") and switch-off times (11.7.2 "Week program: setting the switch-off time").
- After changing all desired switch-on and switch off times, you can start running the week program:

Scroll with **↓** to **START OPERATION**.

Confirm with **ENTER**.

### 11.8 Adding times to a week program

Call up the menu to **INSERT** switch-on and switch-off times into a week program as follows:

- ⇨**: WEEK PROGRAM | PROGRAM OVERVIEW.

Confirm with **ENTER**.

```
WEEK PROGRAM
START OPERATION
⇨PROGRAM OVERVIEW
▼
```

The display shows the menu for the week program. The cursor points to the active period.

```
DAY TIME Tset
ON →SU 08:15 75°C P
OFF SU 12:45
ON  MO 00:00 65°C P
.....
OFF SA 23:59
INSERT
DELETE
START OPERATION
```

- Scroll **↓** to **INSERT**.

Confirm with **ENTER**.

The sub-menu for adding a period will appear.

```
ON →SU 08:15
OFF SU 12:45
Tset 75°C
PUMP ON      SAVE
```

#### Example

As an example, we will program an extra period in which the switch-on time is set to 18:00 hours, and the corresponding switch-off time to 22:00 hours. The water temperature will be set to 75 °C and the pump will run continuously.

```
DAY TIME Tset
ON →SU 18:00 75°C P
OFF SU 22:00
ON  MO 00:00 65°C P
OFF MO 23:59
.....
OFF SA 23:59
INSERT
DELETE
START OPERATION
```

- Proceed as follows:

- Set the switch-on time (11.7.1 "Week program: setting the switch-on time").
- Set the switch-off time (11.7.2 "Week program: setting the switch-off time").
- Set the water temperature (11.7.3 "Week program: setting the water temperature").
- Set the program-controlled pump (11.7.4 "Week program: setting the program-controlled pump").

- To activate the week program with the new period added, scroll down with **↓** to **START OPERATION** and confirm with **ENTER**.



### 11.9 Deleting times from a week program

All switch-on/off times are shown sequentially in the display. Assume that the switch-on/off times for the appliance are programmed as in the figure.

```

DAY TIME Tset
ON →SU 08:15 75°C P
OFF SU 12:45
ON SU 18:00 75°C P
OFF SU 22:00
.....
OFF SA 23:59
INSERT
DELETE
START OPERATION
  
```

To delete a period, proceed as follows:

1. WEEK PROGRAM | PROGRAM OVERVIEW.  
Confirm with **ENTER**.

```

MENU
OFF
↕→ON
↕ WEEK PROGRAM
  
```

2. Scroll with **↓** to PROGRAM OVERVIEW.  
Confirm with **ENTER**.

```

WEEK PROGRAM
START OPERATION
↕→PROGRAM OVERVIEW
↕
  
```

The display shows the menu for the week program.

3. Scroll with **↓** to DELETE.  
Confirm with **ENTER**.

To warn you that you are now working in the delete sub-menu, the cursor is replaced with an exclamation mark (!) and the period settings flash.

```

DAY TIME Tset
ON !SU 08:15 75°C P
OFF SU 12:45
ON SU 18:00 75°C P
OFF SU 22:00
.....
OFF SA 23:59
INSERT
DELETE
START OPERATION
  
```

4. Scroll with **↓** to the day to be deleted. For example, SU (Sunday) in the second period. See the figure.

Confirm with **ENTER**.

```

DAY TIME Tset
ON !SU 18:00 75°C P
OFF SU 22:00
ON MO 00:00 65°C P
OFF MO 23:59
.....
OFF SA 23:59
INSERT
DELETE
START OPERATION
  
```

5. The lines showing switch-on/off times are replaced by the text **DELETE BLOCK?**. See the figure.

Confirm with **ENTER**.  
(or use **RESET** to cancel)

```

DAY TIME Tset
ON ! DELETE
OFF BLOCK?
ON MO 00:00 65°C P
  
```

The switching period has been deleted. You will return now to the week program menu. The cursor points to the first programmed period.

```

DAY TIME Tset
ON →SU 08:15 75°C P
OFF SU 12:45
ON MO 00:00 65°C P
OFF MO 23:59
.....
OFF SA 23:59
INSERT
DELETE
START OPERATION
  
```

6. Scroll with **↓** to START OPERATION.  
Confirm with **ENTER**.  
The week program is active.

### 11.10 Extra period

Use an extra period when you either want to have the appliance switch on and off for a certain period, either without modifying the active week program, or without taking the appliance out of the OFF mode (frost protection active).

If the appliance is running under an "extra period", then this is indicated in the display with the text **EXTRA**.

```

EXTRA
10:00 Monday 76°C
MO 11:15 Tset 75°C
PERIOD ACTIVATED
  
```

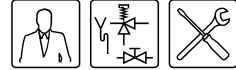

If the water temperature becomes too low during the extra period (11.11 "Programming an extra period"), the appliance will run through the heating cycle (9.3 "The appliance's heating cycle") and fall back into the extra period.

The same settings can be made for an extra period as for a week program (11.7 "Changing the appliance's standard week program") period.

### 11.11 Programming an extra period

1. Call up the menu for entering an extra period via:
2. EXTRA PERIOD  
Confirm with ENTER.

```
MENU
ON
^ WEEK PROGRAM
v->EXTRA PERIOD
```

The display show the settings for the extra period.

#### Setting the switch-on time

1. Use and to set the day. In the example this is SU.  
Confirm with ENTER.  
The cursor moves to the hour digits, which flash.

```
ON  SU->00:00
OFF  SU 00:59
Tset 65°C
PUMP ON      START
```

2. Use and to set the switch-on hour to the desired value. In the example, this is 08.  
Confirm with ENTER.  
The cursor moves to the minute digits, which flash.

```
ON  SU 08->00
OFF  SU 08:00
Tset 65°C
PUMP ON      START
```

#### Note

Because the switch-off time can never be earlier than the switch-on time, the switch-off time setting is automatically adjusted with the switch-on time.

3. Use and to set the minutes. In the example, this is 15.  
Confirm with ENTER.  
The cursor moves to the hour digits of the switch-off period.

```
ON  SU 08:15
OFF  SU->08:15
Tset 65°C
PUMP ON      START
```

#### Setting the switch-off time

1. Use and to set the hours. In the example, this is 12.  
Confirm with ENTER.  
The cursor moves to the minute digits, which flash.

```
ON  SU 08:15
OFF  SU 12->15
Tset 65°C
PUMP ON      START
```

2. Use and to set the minutes. In the example, this is 45.  
Confirm with ENTER.  
The cursor moves to the water temperature. See the figure

```
ON  SU 08:15
OFF  SU 12:45
Tset->65°C
PUMP ON      START
```

#### Setting the water temperature

1. Use and to set the water temperature. In the example this is 75°C.  
Confirm with ENTER.  
The cursor moves to PUMP ON

```
ON  SU 08:15
OFF  SU 12:45
Tset 75°C
PUMP->ON START
```

#### Setting the program-controlled pump

1. If required, a pump can be controlled during the period. Use and to set PUMP ON. The pump ensures a regular circulation of hot water in the hot water pipes. You can skip this step if you there is no pump in your hot water circuit.  
Confirm with ENTER.  
The cursor moves to START.

```
ON  SU 08:15
OFF  SU 12:45
Tset 75°C
PUMP ON ->START
```

2. Confirm with ENTER.  
The extra period has been programmed.

#### Note

Once the extra period has completed running, the controller returns to the mode ON, OFF or WEEK PROGRAM. The following week, the extra period will **NOT** be automatically switched on.



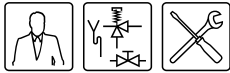

## 11.12 Settings

Using the **SETTINGS** option, you can adjust certain settings and read certain appliance data:

- **Adjustable settings**
  - Language of the menu.
  - Current day of week and time.
- **Displayable appliance specifications**, this category is only relevant to the installation engineer and/or service and maintenance engineer
  - Control range (water temperature).
  - Ignition speed of fan.
  - Working speed of fan.

### 11.12.1 Setting menu language

To set menu language:

```
MENU
WEEK PROGRAM
^ EXTRA PERIOD
v->SETTINGS
```

1. Call up the menu for selecting the language as follows:
2. : **SETTINGS**.  
Confirm with **ENTER**.  
The display shows the menu for settings.

```
SETTINGS
->LANGUAGE
^ DAY/TIME
v SPECIFICATIONS
```

3. The cursor is positioned beside **LANGUAGE**.  
Confirm with **ENTER**.  
The display shows the language selection menu.

```
LANGUAGE
ENGLISH
^ NEDERLANDS
v->DEUTSCH

FRANCAIS
ITALIANO
CZECH
ESPANOL
```

4. Scroll with **↓** to the desired language.  
Confirm with **ENTER**.

The language is set.

### 11.12.2 Setting day and time

To enter the time and day:

```
MENU
WEEK PROGRAM
^ EXTRA PERIOD
v->SETTINGS
```

1. Call up the menu for entering the day and time as follows:
2. : **SETTINGS**.  
Confirm with **ENTER**.  
The display shows the menu for settings.
3. Scroll with **↑** and **↓** to **DAY/TIME**.  
Confirm with **ENTER**.

```
SETTINGS
LANGUAGE
^>DAY/TIME
v SPECIFICATIONS
```

The display shows the sub-menu for adjusting the day.

```
DAY
->Sunday
^ Monday
v Tuesday

Wednesday
Thursday
Friday
Saturday
```

4. The cursor is positioned beside **Sunday**.  
Scroll with **↑** and **↓** to the desired day.  
Confirm with **ENTER**.  
The day has been set. The display shows the sub-menu for adjusting the time.

```
TIME
->00:00
```

5. The cursor moves to the hour digits, which flash.  
Scroll with **↑** and **↓** to the current hour, for example 15.  
Confirm with **ENTER**.

```
TIME
15->00
```

6. The cursor moves to the minute digits, which flash.  
Scroll with **↑** and **↓** to the next minute, for example 45.

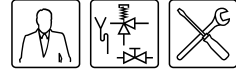

Confirm the minute setting with ENTER



The time has been set.

**Note**  
The appliance takes no account of daylight saving.

### 11.12.3 Displaying appliance specifications

**Note**  
This category is solely intended for the installation engineer and/or service and maintenance engineer.

The table shows the correct settings.

	BFC 28	BFC 30
Ignition fan speed (rpm)	4500	4500
Working speed of fan (rpm)	5000	5400
Regulation interval (°C)	40 - 80	40 - 80

	BFC 50	BFC 60
Ignition fan speed (rpm)	4500	4500
Working speed of fan (rpm)	6000	6660
Regulation interval (°C)	40 - 80	40 - 80

Call up the menu to display the appliance specifications as follows:

1. : SETTINGS.

Confirm with ENTER.

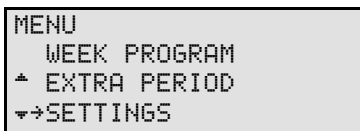

2. Scroll with ↓ to SPECIFICATIONS

Confirm with ENTER.



The display shows the sub-menu for displaying appliance specifications.

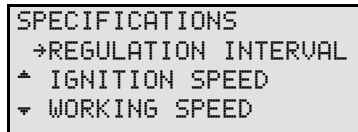

3. Scroll with ↓ to the section to be displayed, for example REGULATION INTERVAL.

The relevant display appears.

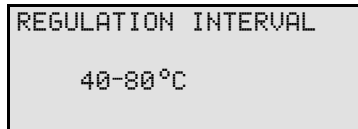

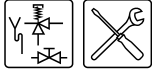

# 12 Service program

## 12.1 Introduction

The service program is used by the installation engineer or service and maintenance engineer for:

- [Setting the hysteresis](#);
- [Displaying the error history](#);
- [Displaying the appliance history](#);
- [Display the selected appliance](#);
- [Switching the pump on or off](#);
- [Setting the service interval](#);
- [Setting the display contrast](#);
- [Setting the display backlight time](#);
- [Setting the display scroll speed](#).

```
SERVICE MENU
→HYSTERESE
← HISTORY OF ERRORS
▽ APPLIANCE HISTORY

SELECT APPLIANCE
PUMP RELAY
SERVICE INTERVAL
CONTRAST DISPLAY
TIME BACKLIGHT
SCROLLSPEED
```

These sub-menus are briefly described in the following paragraphs. If you are not familiar in general with how to use the displays and menus, first read the relevant section ([7 "The control panel"](#)).

### Note

The notation convention for the service menu is identical to that of the main menu ([11.2 "Notational convention for menu-related instructions"](#)). The difference is, you use to bring up the service program, instead of which brings up the main menu.

## 12.2 Setting the hysteresis

If the preset temperature (SETPOINT) is higher than the current water temperature, then the appliance might **not** immediately start the heating cycle ([9.3 "The appliance's heating cycle"](#)). To prevent excessively frequent switching on and off, there is a heating margin. We refer to this margin as the

hysteresis. The standard setting for this margin is 2°C. The heating cycle starts if the water temperature drops to 2°C below the SETPOINT and ends when the water reaches 2°C above the SETPOINT.

```
HYSTERESE UP →3°C
```

Set the hysteresis via:

- : HYSTERESE UP

The figure shows an example

Set the hysteresis via:

- : HYSTERESE DOWN

## 12.3 Displaying the error history

Display the error history as follows:

- : HISTORY OF ERRORS

The controller will display an overview of "Blocking errors" and "Lock out errors". In both cases, the electronic controller reserves 15 lines for the last 15 error messages. If there are fewer than 15 error messages, an ellipsis (...) is displayed. The display first shows the "Blocking errors". When ENTER is pressed, the "Lock out errors" are then displayed.

The figure shows an example of "Blocking errors". In this case, the text HISTORY OF ERRORS is followed by (B).

```
HISTORY OF ERRORS(B)
S04 SENSOR ERROR
F06 IONIZATION
▽ C02 50 HZ ERROR
```

The figure shows an example of "Lock out errors". In this case, the text HISTORY OF ERRORS is followed by (L).

```
HISTORY OF ERRORS(L)
F02 FAN
F07 FLAME ERROR
▽ ...
```

### Note

For an overview of all errors and the possible causes, please refer to the relevant chapter ([13 "Troubleshooting"](#)).



### 12.4 Displaying the appliance history

The appliance history submenu is used to display the burning hours, the number of ignitions, the number of flame errors and the number of ignition errors.

Call up the menu for displaying the appliance history as follows:

- : APPLIANCE HISTORY  
The figure shows an example.

```

APPLIANCE HISTORY
BURNINGHOURS 000410
^IGNITIONS    001000
vFLAME ERRORS 000021
IGNIT ERROR  000013
  
```

### 12.5 Display the selected appliance

Call up the menu for displaying the appliance selection as follows:

- : SELECT APPLIANCE  
The appliance number can be found on the rating plate.  
The appliance selection has been correctly preset in the factory.

```

SELECT APPLIANCE
+5934
^ 8576
v 3379
6527
....
  
```

### 12.6 Switching the pump on or off

If a program-controlled pump is installed (3.10.6 "Connecting a program-controlled pump"), it can be switched ON or OFF as follows:

- : PUMP RELAY  
The standard setting for the pump relay is OFF.

```

PUMP RELAY
+ON
OFF
  
```

If the mode WEEK PROGRAM or EXTRA PERIOD is active, then the setting for mode WEEK PROGRAM or EXTRA PERIOD has priority over the ON/OFF selection for the pump relay in the service menu.

#### Example

*One of the week program periods is currently active. During this period, the pump relay setting is OFF. If the pump relay is set ON in the service menu, the pump will nonetheless remain OFF. The pump will only switch ON once the week program period has ended.*

### 12.7 Setting the service interval

To aid servicing, the electronic controller includes a service interval which is used to set the frequency of maintenance interval (14.2 "Determining service interval") by the service and maintenance engineer, based on the number of burning hours.

The service interval is based on the number of burning hours. This can be set to 500, 1000 and 1500 hours. The standard setting for number of hours is **500**. Once the preset number of hours is reached, a message (8.4 "Service condition") to this effect will appear. Adjust the service interval via:

- : SERVICE INTERVAL

```

SERVICE INTERVAL
+ 500
^ 1000 BURNING HOURS
v 1500
  
```

### 12.8 Setting the display contrast

Adjust the display contrast via:

- : CONTRAST DISPLAY  
The standard setting is 100%. The range is from 0 through 100%.  
The figure shows the related display.

```

CONTRAST DISPLAY
+ 95 %
  
```

### 12.9 Setting the display backlight time

Set the backlight time (the time that the display backlight remains lit after the last button is pressed) as follows:

- : TIME BACKLIGHT  
The standard value is 255 s. The range is 0 to 255 seconds.  
The figure shows the related display.

```

TIME BACKLIGHT
+ 255 sec
  
```

### 12.10 Setting the display scroll speed

Adjust the control speed via:

- : SCROLLSPEED  
The default is 10. The range is from 0 through 100. Setting the value too high or low will make scrolling difficult.

```

SCROLLSPEED
+ 10
  
```

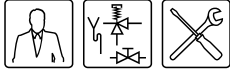

# 13 Troubleshooting

## 13.1 Introduction

A distinction is made between:

- **General errors**

General errors are not reported on the display. General errors are:

- Gas smell
- Display does not light up
- Insufficient or no hot water.
- Water leakage
- Explosive ignition.

The manual includes a table with general errors ([13.2 "Troubleshooting table for general errors"](#)).

- **Displayed errors**

Errors are reported on the display, as follows:

- Line one: an error code and a brief description. The code consists of a letter and two digits.
- Lines two, three and four: a long description, alternating with a recommended action. See the figures. The first shows a possible error, the second shows the appropriate checking action.

```
S02: SENSOR ERROR
      TOP TANK
      SENSOR 1
      NOT CONNECTED
```

```
S02: SENSOR ERROR

      CHECK TOP TANK
      SENSOR
```

There are various types of errors, all falling into one of two groups:

- **LOCK OUT ERRORS**

When the cause has been removed, these errors require a reset with the **RESET** button, before the appliance can resume operation.

- **BLOCKING ERRORS**

These errors disappear automatically once the cause of the error has been removed, after which the appliance resumes operation by itself.

The manual includes a table of error messages that can appear on the ([13.3 "Troubleshooting table for displayed errors"](#)).

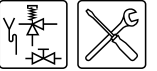

**13.2 Troubleshooting table for general errors**

**Warning**  
Maintenance may only be performed by a qualified service and maintenance engineer.

*General errors*

Symptom	Cause	Solution	Remark
<b>Gas smell</b>	Gas leak	<b>Warning</b> Close the main gas valve immediately.	<b>Warning</b> Contact your installation engineer or local gas company immediately.
		<b>Warning</b> Do not operate any switches.	
		<b>Warning</b> No naked flames.	
		<b>Warning</b> Ventilate the boiler room.	
<b>Display is off</b>	Appliance is turned off	Start the appliance up ( <a href="#">9 "Starting and running"</a> )	
	No supply voltage present	<ol style="list-style-type: none"> <li>1. Check if the isolator is ON.</li> <li>2. Check that there is power to the isolator.</li> <li>3. Check whether the ON/OFF switch of the electronic controller is ON (position I).</li> <li>4. Check whether there is power to the electrical connector block.</li> <li>5. The measured voltage must be 230 VAC (-15%, +10%).</li> </ol>	See the BFC electrical diagram ( <a href="#">17 "Appendices"</a> ) If the error persists, consult your installation engineer.
	Defective fuse(s)	Replace fuse(s)	To replace the fuses, you must contact your installation engineer.

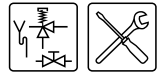

Symptom	Cause	Solution	Remark
<b>Water leakage</b>	Leakage from a water connection (threaded)	Tighten the threaded connection	If the leak persists, consult your installation engineer
	Condensate leakage	Check that the condensation water discharge is working properly. Rectify if necessary	
	Leakage from another nearby water appliance or pipe segment	Trace the leak	
	Leakage from the appliance's tank	Consult the supplier and/or manufacturer	
<b>Explosive ignition</b>	Incorrect supply pressure and/or burner pressure	Set the correct supply pressure and/or burner pressure. (3.11 "Checking the supply pressure and burner pressure")	If ignition is not improved, consult your installation engineer.
	Contaminated burner	Clean the burner(s) (15.4.2 "Clean the burner(s)")	
	Contaminated orifice	Clean the orifice(s) (15.4.3 "Clean the orifice(s)")	
<b>Hot water supply insufficient or absent</b>	Appliance is turned off	Start the appliance up (9 "Starting and running")	
	No supply voltage present	<ol style="list-style-type: none"> <li>1. Check if the isolator is ON.</li> <li>2. Check that there is power to the isolator.</li> <li>3. Check whether the ON/OFF switch of the electronic controller is ON (position I).</li> <li>4. Check whether there is power to the electrical connector block.</li> <li>5. The measured voltage must be 230 VAC (-15%, +10%).</li> </ol>	See the BFC electrical diagram (17 "Appendices") If the error persists, consult your installation engineer.
	Hot water supply is used up	Reduce hot water consumption and give the appliance time to heat up.	If there continues to be insufficient hot water, or none at all, consult your installation engineer.
	The controller is in OFF mode.	Switch the controller to the ON mode (11.3 "Switching on the "ON mode"")	
	Temperature ( $T_{set}$ ) is set too low.	Adjust (11.4 "Setting the water temperature") temperature ( $T_{set}$ ) to a higher value.	



### 13.3 Troubleshooting table for displayed errors

#### Displayed errors

Code + Description	Cause	Solution	Remark
<b>S01 (blocking error)</b> Open circuit from temperature sensor T2 at bottom of the tank	Sensor is not (correctly) connected	Connect the sensor lead to JP3	See the BFC electrical diagram (17 "Appendices")
	Damaged cable or defective sensor	Replace the sensor	To replace the necessary parts, you must contact your installation engineer
<b>S02 (blocking error)</b> Open circuit in sensor 1 of temperature sensor T <sub>1</sub> at the top of the tank <sup>(1)</sup> .	Sensor is not (correctly) connected	Connect the sensor lead to JP5	See the BFC electrical diagram (17 "Appendices")
	Damaged cable or defective sensor	Replace sensor T <sub>1</sub>	To replace the necessary parts, you must contact your installation engineer
<b>S03 (blocking error)</b> Open circuit in sensor 2 of temperature sensor T1 at the top of the tank (1).	Sensor is not (correctly) connected	Connect the sensor lead to JP5	See the BFC electrical diagram (17 "Appendices")
	Damaged cable or defective sensor	Replace sensor T <sub>1</sub>	To replace the necessary parts, you must contact your installation engineer
<b>S04 (blocking error)</b> Open circuit from dummy 1	Dummy is not (correctly) connected	Connect the dummy sensor (dummy sensor 1 and 2) leads to JP4.	See the BFC electrical diagram (17 "Appendices")
	Defective dummy	Replace the dummy sensor	To replace the necessary parts, you must contact your installation engineer
<b>S05 (blocking error)</b> Open circuit from dummy 2	Dummy is not (correctly) connected	Connect the dummy sensor (dummy sensor 1 and 2) leads to JP4.	See the BFC electrical diagram (17 "Appendices")
	Defective dummy	Replace the dummy sensor	To replace the necessary parts, you must contact your installation engineer
<b>S11 (blocking error)</b> Short circuit in the temp. sensor T2 at the bottom of the tank	Short circuit in sensor circuit	Replace sensor T <sub>2</sub>	To replace the necessary parts, you must contact your installation engineer



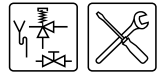

Code + Description	Cause	Solution	Remark
<b>S12 (blocking error)</b> Short circuit in sensor 1 of temperature sensor T <sub>1</sub> at the top of the tank <sup>(1)</sup>	Short circuit in sensor circuit	Replace sensor T <sub>1</sub>	To replace the necessary parts, you must contact your installation engineer
<b>S13 (blocking error)</b> Short circuit in sensor 2 of temperature sensor T1 at the top of the tank <sup>(1)</sup>	Short circuit in sensor circuit	Replace sensor T <sub>1</sub>	To replace the necessary parts, you must contact your installation engineer
<b>S14 (blocking error)</b> Short circuit from dummy 1	Short circuit in sensor circuit	Replace the dummy sensor <sup>(2)</sup>	To replace the necessary parts, you must contact your installation engineer
<b>S15 (blocking error)</b> Short circuit from dummy 2	Short circuit in sensor circuit	Replace the dummy sensor <sup>(2)</sup>	To replace the necessary parts, you must contact your installation engineer
<b>F01 (blocking error)</b> Defect in power supply circuit	Live and neutral connected wrong way round	Connect live and neutral correctly (3.10 "Electrical connection"); the appliance is phase-sensitive	See the BFC electrical diagram (17 "Appendices")
	Condensation on the flame probe	<ol style="list-style-type: none"> <li>1. Disconnect the lead at the flame probe</li> <li>2. Ignite the appliance three times, with an interrupted ionisation circuit</li> <li>3. Reconnect the ionisation lead to the flame probe</li> <li>4. Ignite the appliance again</li> <li>5. The repeated ignition attempts will have caused the condensation to evaporate</li> </ol>	If errors persist, contact your installation engineer
	Floating neutral	Install an isolating transformer (3.10.4 "Isolating transformer")	Contact your installation engineer to have an isolating transformer installed

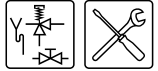

Code + Description	Cause	Solution	Remark
<b>F02 (lock out error)</b>  Fan fails to run at correct speed.	Defective motor and/or rotor.	<ol style="list-style-type: none"> <li>1. Check the motor and rotor</li> <li>2. Replace the fan if the motor or rotor is defective.</li> <li>3. Reset appliance controller</li> </ol>	See the BFC electrical diagram ( <a href="#">17 "Appendices"</a> )  To have the wiring replaced and a new fan fitted, you must contact your installation engineer
	Damaged wiring	<ol style="list-style-type: none"> <li>1. Check the wiring between the fan and the controller.</li> <li>2. If any wires are damaged, the wiring harness must be replaced.</li> <li>3. Reset appliance controller</li> </ol>	
	Dirty or blocked fan	<ol style="list-style-type: none"> <li>1. Check if the fan is dirty</li> <li>2. Check that the rotor can rotate freely</li> <li>3. Reset appliance controller</li> </ol>	
	Because of a drop in the supply voltage, the fan is not running at the correct speed.	<ol style="list-style-type: none"> <li>1. Check the supply voltage, this must be 230 VAC (-15%, +10%).</li> <li>2. Reset appliance controller</li> </ol>	
<b>The F02 entries below are applicable solely to appliances that have a 3-phase fan with frequency controller.</b>			
Fun supplying insufficient pressure	The live (phase) wires, between freq. controller and fan are connected wrong way around	<ol style="list-style-type: none"> <li>1. Check the wiring between the fan and the frequency controller</li> <li>2. Rectify the assembly if it is incorrect</li> <li>3. Reset appliance controller</li> </ol>	See the BFC electrical diagram ( <a href="#">17 "Appendices"</a> )  To replace the necessary parts, you must contact your installation engineer
	Fan speed too low	<ol style="list-style-type: none"> <li>1. Check the fan speed</li> <li>2. If the fan speed is too low, check the settings</li> <li>3. If the settings are correct, then replace the fan.</li> <li>4. Modify the settings if incorrect</li> <li>5. Reset appliance controller</li> </ol>	

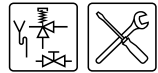

Code + Description	Cause	Solution	Remark
Air pressure switch fails to close during pre-purge.	Air pressure switch leads	<ol style="list-style-type: none"> <li>1. Check the wiring between the air pressure switch and the controller. Rectify any defect: <ul style="list-style-type: none"> <li>- if any wires are damaged, replace the wiring harness</li> <li>- properly connect loose or detached hoses</li> </ul> </li> <li>2. Reset appliance controller</li> </ol>	
	Loose air pressure switch hoses	<ol style="list-style-type: none"> <li>1. Check hoses between air pressure switch and burner/fan. Rectify any defect: <ul style="list-style-type: none"> <li>- if any wires are damaged, replace the wiring harness</li> <li>- properly connect loose or detached hoses</li> </ul> </li> <li>2. Reset appliance controller</li> </ol>	
	Heat exchanger and/or chimney flue is blocked	<ol style="list-style-type: none"> <li>3. Measure the pressure differential across the air pressure switch</li> <li>4. Check the values (2.4.5 "Pressure switch")</li> <li>5. Check heat exchanger, condensation drainage and/or chimney flue for blockages</li> <li>6. Clear any blockage that may be present.</li> <li>7. Reset appliance controller</li> </ol>	
	Defective controller	<ol style="list-style-type: none"> <li>1. Check that the controller is receiving power</li> <li>2. Check that the controller is correctly connected</li> <li>3. If there is no electrical power, check the power supply to the terminal block, or replace the controller.</li> <li>4. Rectify any incorrect connections.</li> <li>5. Reset appliance controller</li> </ol>	

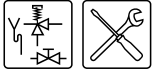

Code + Description	Cause	Solution	Remark
<b>F03 (lock out error)</b>  The pressure switch fails to work correctly	Damaged wiring/Open circuit	<ol style="list-style-type: none"> <li>1. Check the wiring between the pressure switch and the controller</li> <li>2. If necessary, replace the wiring</li> </ol>	If the error cannot be resolved or is persistent, contact your installation engineer To replace the necessary parts, you must contact your installation engineer
	Pressure switch not closing	<ol style="list-style-type: none"> <li>1. Check the running speed of the fan (<a href="#">12.5 "Display the selected appliance"</a>)</li> <li>2. Check that the hoses on the pressure switch and the air supply hose between fan and burner are correctly fitted. Refit them if necessary</li> <li>3. Check for cracks in the hoses on the pressure switch and in the air supply hose between fan and burner. If necessary, replace the hoses.</li> <li>4. Check that the flue gas outlet is compliant (<a href="#">3.9 "Air supply and flue"</a>).</li> <li>5. Check for blockage in the flue gas discharge. Remove any blockage that may be present</li> <li>6. Check for blockage in the condensation water discharge. Remove any blockage that may be present.</li> <li>7. Measure the pressure differential across the pressure switch. See the table in Preparation for maintenance (<a href="#">15.2 "Preparation for maintenance"</a>). If there is insufficient pressure differential, clean the heat exchanger. If the pressure differential is acceptable, check that the pressure switch is closing, using a multimeter.</li> </ol>	

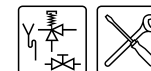

Code + Description	Cause	Solution	Remark
<b>F04 (lock out error)</b>  Three unsuccessful ignition attempts.	No gas	<ol style="list-style-type: none"> <li>1. Open the main gas valve and/or the manual gas valve supplying the water heater</li> <li>2. Check the supply pressure to the gas control</li> <li>3. If necessary, repair the gas supply</li> </ol>	To repair the gas supply, contact your installation engineer
	Air in the gas pipes	Bleed the air out of the gas pipe	See <a href="#">Checking the supply pressure and burner pressure</a> for how to bleed air from the gas line, and measure the supply pressure and burner pressure. To replace the necessary parts, you must contact your installation engineer
	No burner pressure	<ol style="list-style-type: none"> <li>1. Check the burner pressure to the gas control</li> <li>2. Check that the gas valve(s) open and shut correctly</li> <li>3. If necessary, replace the gas control.</li> </ol>	
	Defect in the hot surface igniter circuit	<ol style="list-style-type: none"> <li>1. Check that the hot surface igniter is correctly connected (JP2).</li> <li>2. Check the wiring of the hot surface igniter.</li> <li>3. Measure the resistance across the hot surface igniter. This must lie between 2 and 5 ohms.</li> <li>4. Check that the hot surface igniter lights up during ignition.</li> <li>5. If necessary, replace the hot surface igniter.</li> </ol>	If the error persists, contact your installation engineer. To replace the necessary parts, you must contact your installation engineer
	Defect in the ionisation circuit	<ol style="list-style-type: none"> <li>1. Check that the flame probe is correctly connected (JP2)</li> <li>2. Check the wiring of the flame probe</li> <li>3. Measure the ionisation current. This must be at least 1.5 microamps.</li> <li>4. Replace the wiring if necessary.</li> </ol>	
Supply voltage too low	Check the supply voltage, this must be 230 VAC (-15%, +10%).		
<b>F05 (lock out error)</b>  Too many flame errors have been signalled.	Incorrect roof or wall conduit. Recirculating flue gases.	<ol style="list-style-type: none"> <li>1. Check that the correct roof or wall flue conduit (<a href="#">3.9 "Air supply and flue"</a>) has been fitted.</li> <li>2. If necessary, install the correct roof or wall conduit.</li> <li>3. Check that the roof or wall conduit discharges into a permitted area.</li> </ol>	If the error cannot be resolved or is persistent, contact your installation engineer

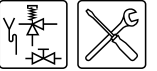

Code + Description	Cause	Solution	Remark
<b>F06 (lock out error)</b> Short circuit between flame probe and earth	Damaged cable in contact with metal surface.	Check the wiring of the flame probe. If necessary, replace the wiring.	If the error persists, contact your installation engineer. To replace the necessary parts, you must contact your installation engineer
	Ceramic part of the flame probe is broken/cracked.	1. Check that the ceramic part of the flame probe is still intact in the vicinity of the burner's air distribution plate. 2. If not, the flame probe must be replaced.	
<b>F07 (lock out error)</b> A flame has been detected after the gas valve was closed.	Defective gas valves	1. Check whether there is still burner pressure present after the gas valves have closed. 2. Check whether a flame is still present after the gas valves have closed. 3. If this is the case, the gas control must be replaced.	If the error cannot be resolved or is persistent, contact your installation engineer To replace the necessary parts, you must contact your installation engineer
<b>F08 (lock out error)</b> Error message from safety relay	Flame detection before the gas valve opened.	1. Reset the electronic controller. 2. If the error reappears, replace the electronic controller.	If the error cannot be resolved or is persistent, contact your installation engineer To replace the necessary parts, you must contact your installation engineer
<b>F09 (lock out error)</b> Water temperature safety.	The temperature at the top of the tank exceeds 93 °C.	1. Check that the circulation pump (if present) is working 2. Check the position of the temperature sensor T <sub>1</sub> . 3. Reset appliance controller	If the error cannot be resolved or is persistent, contact your installation engineer

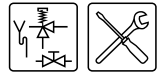

Code + Description	Cause	Solution	Remark
<p><b>F10 (lock out error)</b></p> <p>Restriction on the number of ignition attempts based on pressure switch state changes.</p>	<p>Pressure switch not closing</p>	<ol style="list-style-type: none"> <li>1. Check the running speed of the fan (<a href="#">12.5 "Display the selected appliance"</a>)</li> <li>2. Check that the hoses on the pressure switch and the air supply hose between fan and burner are correctly fitted. Refit them if necessary</li> <li>3. Check for cracks in the hoses on the pressure switch and in the air supply hose between fan and burner. If necessary, replace the hoses.</li> <li>4. Check that the flue gas outlet is compliant (<a href="#">3.9 "Air supply and flue"</a>).</li> <li>5. Check for blockage in the flue gas discharge. Remove any blockage that may be present</li> <li>6. Check for blockage in the condensation water discharge. Remove any blockage that may be present.</li> <li>7. Measure the pressure differential across the pressure switch. See the table in Preparation for maintenance (<a href="#">15.2 "Preparation for maintenance"</a>). If there is insufficient pressure differential, clean the heat exchanger. If the pressure differential is acceptable, check that the pressure switch is closing, using a multimeter.</li> </ol>	<p>If the error cannot be resolved or is persistent, contact your installation engineer</p> <p>To replace the necessary parts, you must contact your installation engineer</p>
<p><b>F11 (blocking error)</b></p> <p>Flame detection with closed gas valve.</p>	<p>Defective gas valves</p>	<p>See F07.</p>	

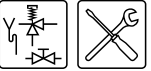

Code + Description	Cause	Solution	Remark
<b>C02 (lock out error)</b>  Error message from the appliance controller.	Incorrect reference voltage from the AD converter.	<ol style="list-style-type: none"> <li>1. Reset electronic controller.</li> <li>2. Check that the frequency of the power supply is compliant (3.4.2 "General and electrical specifications"). If this is not the case, contact your installation engineer</li> <li>3. If the frequency is correct but the error persists, replace the electronic controller.</li> </ol>	To replace the necessary parts, you must contact your installation engineer
Internal error message from the appliance controller.	<ul style="list-style-type: none"> <li>• EEPROM read error</li> <li>• 50 Hz error</li> <li>• Internal communication error</li> </ul>		
Internal error message from the appliance controller.	<ul style="list-style-type: none"> <li>• Gas valve relay error</li> <li>• Safety relay error</li> <li>• Ignition relay error</li> <li>• RAM error</li> <li>• EEPROM error</li> <li>• EEPROM contents do not match the software version</li> <li>• Processor software error</li> </ul>		
<b>C03 (blocking error)</b>  Reset error	Too many resets in too short a period.	Wait for the error to disappear (maximum 1 hour). If the error does not disappear, replace the appliance controller.	To replace the necessary parts, you must contact your installation engineer
<b>C04 (blocking error)</b>  Appliance selection error	Incorrect appliance selection / Incorrect selection resistor	<ol style="list-style-type: none"> <li>1. Check whether the correct appliance is selected (12.5 "Display the selected appliance").</li> <li>2. If the correct appliance is selected, fit the correct selection resistor.</li> <li>3. If incorrect appliance selected, select the correct one.</li> </ol>	If the error cannot be resolved or is persistent, contact your installation engineer  To replace the necessary parts, you must contact your installation engineer



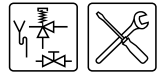

Code + Description	Cause	Solution	Remark
<b>E01 (blocking error)</b> The temperature protection at the top of the tank has been activated.	The temperature of the water at the top of the tank is $> 85\text{ }^{\circ}\text{C}$ .	None. This is a temporary message that may appear from time to time, but will disappear automatically.	
<b>E03 (lock-out error)</b> Error in temperature sensor $T_1$ at the top of the tank.	The two temperature sensors in the tank detect a differential of $\geq 10\text{ }^{\circ}\text{C}$ over a period of at least 60 seconds.	<ol style="list-style-type: none"> <li>1. Check sensor position and wiring.</li> <li>2. If necessary, reset the electronic controller. Replace the sensor if the error persists.</li> </ol>	To replace the necessary parts, you must contact your installation engineer
<b>E04 (lock-out error)</b> Error in dummy sensor <sup>(2)</sup> .	The two dummy sensors in the tank detect a differential of $\geq 10\text{ }^{\circ}\text{C}$ over a period of at least 60 seconds.	<ol style="list-style-type: none"> <li>1. Check leads from dummy 1 and dummy 2.</li> <li>2. If necessary, reset the electronic controller. Replace the dummy sensor if the error persists.</li> </ol>	To replace the necessary parts, you must contact your installation engineer
1) Temperature sensor $T_1$ is a '2 in 1' sensor, $T_1$ contains 2 NTCs for the high-limit thermostat and safety thermostat protection. (2) The dummy sensor / flue gas sensor comprises dummy sensor / flue gas sensor 1 and dummy sensor / flue gas sensor 2.			

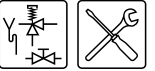

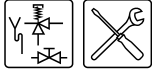

# 14 Maintenance frequency

## 14.1 Introduction

A service should be carried out at least once a year, both on the water side and on the gas side. Maintenance frequency depends, among other things, on the water quality, the average burning time per day and the set water temperature.

---

### Note

Regular maintenance extends the service life of the appliance.

To determine the correct maintenance frequency, it is recommended to arrange for the service and maintenance engineer to check the appliance on both the water and gas side, three months after installation. Based on this check, the best maintenance frequency can be determined.

---

## 14.2 Determining service interval

To aid servicing, the electronic controller has a service interval with which the service and maintenance engineer can determine the frequency of maintenance, based on the number of burning hours.

The service interval can be set to: 500, 1000 or 1500 burning hours. The standard setting is 500 burning hours.

---

### Example

*In the first three months, the appliance has burnt 300 hours. During maintenance, it is evident that one service per year will be sufficient. Therefore, after one year, some 1200 burning hours will have elapsed. The first value below 1200 hours that can be selected is 1000 burning hours.*

*In this case, the service and maintenance engineer sets the interval to 1000.*

*In the first three months, the appliance has burned for 300 hours. During maintenance, it is evident (perhaps due to the water quality) that service will be required at least once every 6 months.*

*Therefore, after six months, some 600 burning hours will have elapsed. The first value below 600 hours that can be selected is 500 burning hours.*

*In this case, the service and maintenance engineer sets the interval to 500.*

---

```
!!! WARNING !!!  
  
MAX. BURNINGHOURS:  
SERVICE REQUIRED
```

Once the set number of burning hours has elapsed, the message SERVICE REQUIRED will appear on the display. When this message appears, the service and maintenance engineer must be contacted.

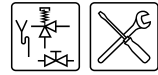



# 15 Performing maintenance

## 15.1 Introduction

### Attention

Maintenance may only be performed by a qualified service and maintenance engineer.

At each service, the appliance undergoes maintenance on both the water side and the gas side. The maintenance must be carried out in the following order.



1. [Preparation for maintenance](#)
2. [Water-side maintenance](#)
3. [Gas-side maintenance](#)
4. [Finalizing maintenance](#)

### Note

To order spare parts, it is important to write down the appliance type and model, and the full serial number of the appliance. These details can be found on the rating plate. Only by ordering with this information can you be sure to receive the correct spare parts.

## 15.2 Preparation for maintenance

To test whether all components are still working properly, complete the following steps:

1. Activate the MENU with .
2. Use:  and  to place the cursor beside OFF.
3. Confirm OFF with ENTER.

```
MENU
→OFF
▲ ON
▼ WEEK PROGRAM
```

4. Wait until the fan has stopped. The  icon is then dimmed.

### Attention

**Failure to wait until the fan stops purging can cause damage to the appliance.**

5. Switch the appliance **OFF (position 0)** using the ON/OFF switch on the control panel.



IMD-0423 R0

6. Switch the electronic controller **ON** by setting the ON/OFF switch to **position I**.

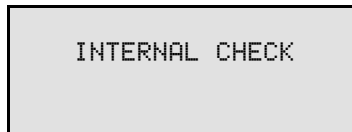

The display will now show **INTERNAL CHECK** for about 10 seconds, and will then go to the main menu.

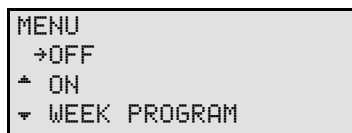

7. Activate "ON mode" by going through the following steps:
- Press once on the blue arrow (↓) to position the cursor beside **ON**, then press **ENTER**.
  - Confirm the selection **START OPERATION** with **ENTER**.
8. If there is no heat demand, increase  $T_{set}$  (11.4 "Setting the water temperature"). Note the original setting. Draw some hot water off to create heat demand.
9. Check whether the heating cycle runs correctly (9.3 "The appliance's heating cycle").
10. If you have adjusted  $T_{set}$ , return it to the desired value (11.4 "Setting the water temperature").
11. Remove the plastic cover on the top of the appliance.
12. Check the supply and burner pressure (3.11 "Checking the supply pressure and burner pressure"), and adjust them if necessary.
13. Check that all components of the chimney flue system are properly attached.
14. Check the pressure differential across the orifice plate of the pressure switch (see the table). If the pressure difference is too low, the heat exchanger must be cleaned (15.4.4 "Cleaning the heat exchanger").

*Pressure switch pressure differential*

Appliance	Observed pressure differential across the pressure switch (Pa)
BFC 28	$\geq 635$
BFC 30	$\geq 885$
BFC 50	$\geq 885$
BFC 60	$\geq 1085$



15. Test the operation of the overflow valve of the protected cold supply setup. The water should spurt out.
16. Test the overflow operation of the T&P valve. The water should spurt out.
17. Check the drain pipes from the discharge points of all valves and remove any lime buildup that may be present.
18. Drain the appliance (see [Draining](#)).

### 15.3 Water-side maintenance

#### 15.3.1 Introduction

The following steps must be carried out on the water side:

1. [Checking the anodes](#).
2. [Descaling and cleaning the tank](#).
3. [Cleaning condensation water discharge](#).

#### 15.3.2 Checking the anodes

Timely replacement of the anodes extends the service life of the appliance. The appliance's anodes must be replaced as soon as they are 60% or more consumed (take this into consideration when determining the maintenance frequency).

1. Loosen the anodes using suitable tools.
2. Check the anodes, and if necessary, replace them.

#### 15.3.3 Descaling and cleaning the tank

Scale and lime buildup prevent effective conduction of the heat to the water. Periodic cleaning and descaling prevents buildup of these deposits. This increases the service life of the appliance, and also improves the heating process.

Take the rate of scale formation into account when deciding on maintenance frequency. Scale formation depends on the local water composition, the water consumption and the water temperature setting. A water temperature setting of maximum 60°C is recommended for prevention of excessive scale buildup.

To guarantee a good, watertight seal around the cleaning opening, replace the gasket, washers, bolts and, if necessary, the lid with new parts before reassembly (see the figure). A special set is obtainable from the supplier/manufacturer.

To simplify descaling and cleaning of the tank, the appliance is equipped with two cleaning openings.

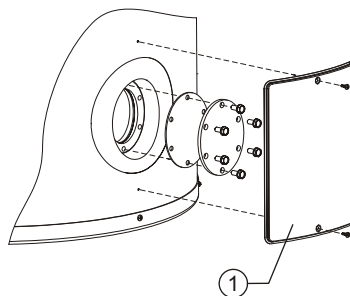

IMD-0080 R1

1. Remove the cover plate (1) on the outer jacket (see the figure).
2. Undo the bolts.
3. Remove the cover and the gasket.



4. Inspect the tank and remove the loose scale deposits and contamination.
5. If the scale cannot be removed by hand, then the appliance will need to be descaled using a descaling agent. Contact the supplier for advice on the preferred descaling agent.
6. Close the cleaning opening. To avoid damage to the tank, tighten the bolts that fasten the lid with a torque no greater than 50 Nm. Use suitable tools for this.

#### 15.3.4 Cleaning condensation water discharge

Regular cleaning of the condensation drain and siphon is essential for prevention of blockages.

### 15.4 Gas-side maintenance

#### 15.4.1 Introduction

The following steps must be carried out on the gas side:

1. [Clean the burner\(s\)](#).
2. [Clean the orifice\(s\)](#).
3. [Cleaning the heat exchanger](#).
4. [Finalizing maintenance](#).

#### 15.4.2 Clean the burner(s)

1. Detach the burner(s)
2. Remove all contamination present on the burner(s).
3. Fit the burner(s)

#### 15.4.3 Clean the orifice(s)

1. Detach the orifice(s)
2. Remove all contamination present in the orifice(s).
3. Fit the orifice(s)

#### 15.4.4 Cleaning the heat exchanger

1. Detach the burner.
2. Clean the combustion chamber of the heat exchanger using a vacuum cleaner and a soft brush.
3. Detach the flue gas discharge.
4. Clean the end of the heat exchanger using tap water.
5. Fit the burner.
6. Fit the flue gas discharge.

---

#### Note

Check the pressure differential again after cleaning. If the pressure difference is too low following cleaning, please contact the supplier of the appliance.

---

### 15.5 Finalizing maintenance

To finalize the maintenance carry out the following steps:

1. Fill the appliance ([5 "Filling"](#)).
2. Start the appliance ([9 "Starting and running"](#)).
3. Erase the message **SERVICE REQUIRED**. Do this by pressing once on **RESET** then once on **ENTER**.



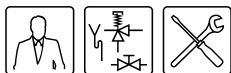

# 16 Warranty (certificate)

To register your warranty, you should complete and return the enclosed warranty card after which a warranty certificate will be sent to you. This certificate gives the owner of a appliance supplied by A.O. Smith water Products Company B.V. of Veldhoven, The Netherlands (hereinafter "A.O. Smith") the right to the warranty set out below, defining the commitments of A.O. Smith to the owner.

## 16.1 General warranty

If within one year of the original installation date of a water heater supplied by A.O. Smith, following verification, and at the sole discretion of A.O. Smith, a section or part (with exclusion of the tank) proves to be defective or fails to function correctly due to manufacturing and/or material defects, then A.O. Smith shall repair or replace this section or part.

## 16.2 Tank warranty

If within 3 years of the original installation date of a water heater supplied by A.O. Smith, following inspection, and at the sole discretion of A.O. Smith, the glass-lined steel tank proves to be leaking due to rust or corrosion occurring on the water side, then A.O. Smith shall offer to replace the defective water heater with an entirely new water heater of equivalent size and quality. The warranty period given on the replacement water heater shall be equal to the remaining warranty period of the original water heater that was supplied. Notwithstanding that stated earlier in this article, in the event that unfiltered or softened water is used, or allowed to stand in the water heater, the warranty shall be reduced to one year from the original installation date.

## 16.3 Conditions for Installation and use

The warranty set out in article 1 and 2 will apply solely under the following conditions:

- a. The water heater is installed under strict adherence to A.O. Smith installation instructions for the specific model, and the relevant government and local authority installation and building codes, rules and regulations in force at the time of installation.
- b. The water heater remains installed at the original site of installation.
- c. The appliance is exclusively used with drinking water, which at all times can freely circulate (a separately installed heat exchanger is mandatory for heating salt water or corrosive water).
- d. The tank is safeguarded against harmful scaling and lime buildup by means of periodic maintenance.
- e. The water temperatures in the heater do not exceed the maximum setting of the thermostats, which form a part of the water heater.
- f. The water pressure and/or heat load do not exceed the maximum values stated on the water heater rating plate.
- g. The water heater is installed in a non-corrosive atmosphere or environment.
- h. The water heater is connected to a protected cold supply arrangement, which is: approved by the relevant authority; with sufficient capacity for this purpose; supplying a pressure no greater than the working pressure stated on the water heater; and where applicable by a likewise approved temperature and pressure relief valve, fitted in accordance with installation instructions of A.O. Smith applying to the specific model of water heater, and further in compliance with the government and local authority installation and building codes, rules and regulations.

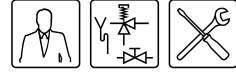

- i. The appliance is at all times fitted with cathodic protection. If sacrificial anodes are used for this, these must be replaced and renewed when, and as soon as, they are 60% or more consumed. When electric anodes are used, it is important to ensure that they continue to work properly.

#### 16.4 Exclusions

The warranty set out in articles 1 and 2 will not apply in the event of:

- a. damage to the water heater caused by an external factor;
- b. misuse, neglect (including frost damage), modification, incorrect and/or unauthorised use of the water heater and any attempt to repair leaks;
- c. contaminants or other substances having been allowed to enter the tank;
- d. the conductivity of the water being less than 125  $\mu\text{S}/\text{cm}$  and/or the hardness (alkaline-earth ions) of the water being less than 1.00 mmol/litre ([3.3.3 "Water composition"](#));
- e. unfiltered, recirculated water flowing through or being stored in the water heater;
- f. any attempts at repair to a defective water heater other than by an approved service engineer.

#### 16.5 Scope of the warranty

The obligations of A.O. Smith pursuant to the specified warranty do not extend beyond free delivery from the Veldhoven warehouse of the replacement sections, parts or water heater respectively. Shipping, labour, installation and any other costs associated with the replacement will not be accepted by A.O. Smith.

#### 16.6 Claims

A claim on grounds of the specified warranty must be submitted to the dealer from whom the water heater was purchased, or to another authorised dealer for A.O. Smith water Products Company products. Inspection of the water heater as referred to in articles 1 and 2 shall take place in one of the laboratories of A.O. Smith water Products Company.

#### 16.7 Obligations of A.O. Smith

A.O. Smith grants no other warranty or guarantee over its water heaters nor the (sections or parts of) water heaters supplied for replacement, other than the warranty expressly set out in this Certificate.

Under the terms of the supplied warranty, A.O. Smith is not liable for damage to persons or property caused by (sections or parts, or the glass-lined steel tank of) a (replacement) water heater that it has supplied.

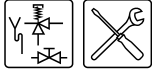

# 17 Appendices

## 17.1 Introduction

This appendix contains:

- [Electrical diagram](#)
- [Week program card](#)

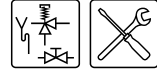

### 17.2 Electrical diagram *Electrical diagram*

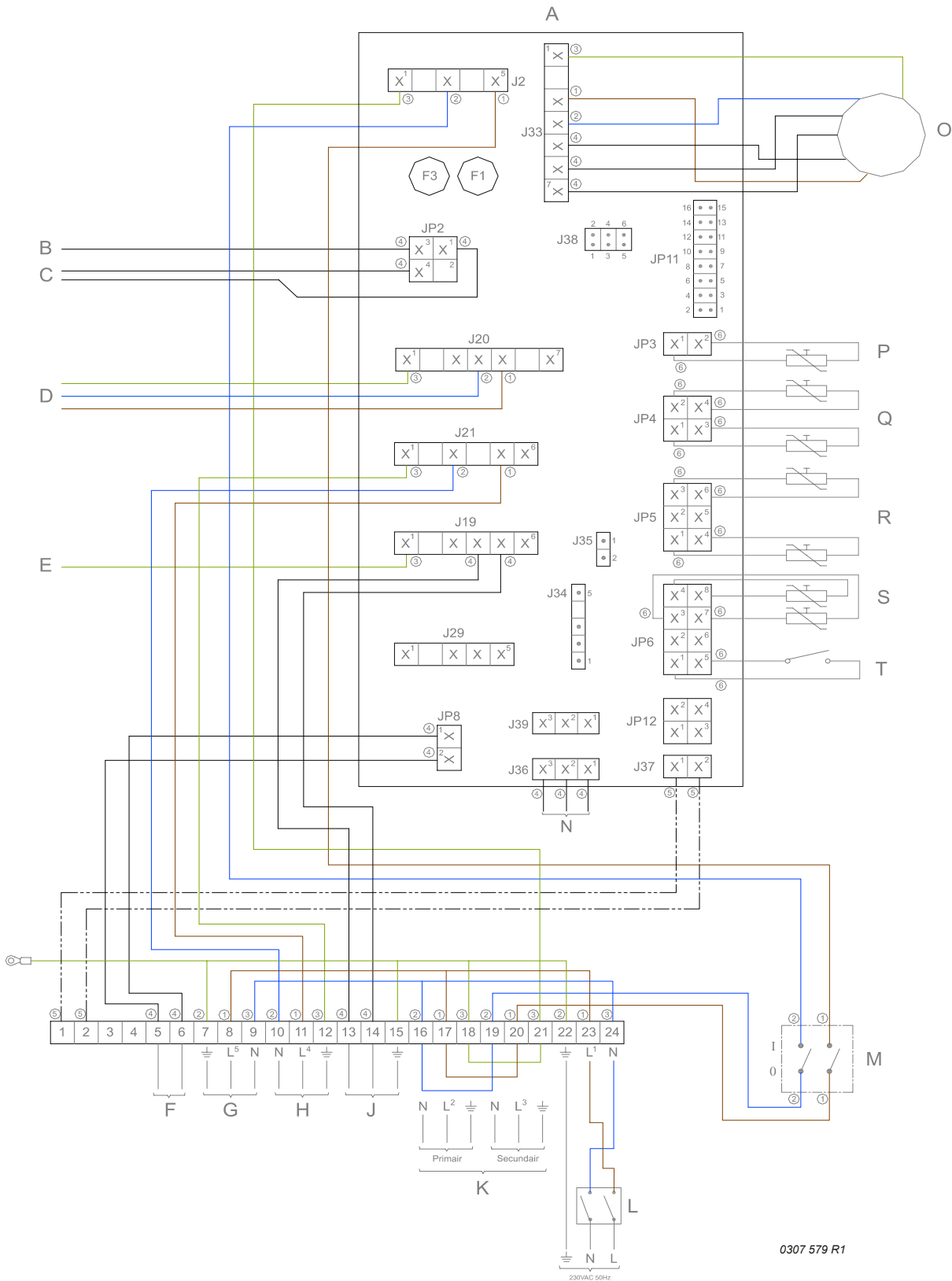

1 = brown, 2 = blue, 3 = green, 4 = black, 5 = white, 6 = grey / beige

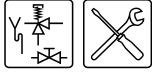

#### TERMINAL BLOCK CONNECTIONS:

⏚	Earth
N	Neutral
L <sup>1</sup>	Phase input of controller
L <sup>2</sup>	Phase input of isolating transformer (primary side)
L <sup>3</sup>	Phase output of isolating transformer (secondary side)
L <sup>4</sup>	Phase input of program-controlled pump
L <sup>5</sup>	Phase input of continuous pump

#### COMPONENTS:

A	Controller
B	Flame probe
C	Hot surface igniter
D	Gas control
E	Burner earth connection
F	Extra ON mode switch
G	Continuous pump
H	Program-controlled pump
J	Extra error signal connection
K	Isolating transformer
L	Double-pole isolator
M	Controller 0/I switch
N	Display
O	Fan
P	Temperature sensor (T2 - bottom of tank)
Q	Dummy
R	Temperature sensor (T1 - top of tank)
S	Selection resistor
T	Pressure switch

#### CONTROLLER CONNECTIONS:

J2	Power connection for controller
J19	Extra error signal connection
J20	Gas control connection
J21	Program-controlled pump connection
J24	Fan connection
J36	Controller display connection
JP2	Flame probe and hot surface igniter connection
JP3	Temperature sensor T2 connection
JP4	Dummy connection
JP5	Temperature sensor T1 connection
JP6	Selection resistor and pressure switch connection
JP8	Extra ON mode switch connection
F1	Fuse
F3	Fuse

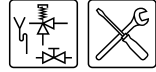

### 17.3 Week program card

You can cut the week program card out and keep it near the appliance.

Period		DAY	TIME	Tset	Pump
1.	ON			....°C	ON / OFF
	OFF				
2.	ON			....°C	ON / OFF
	OFF				
3.	ON			....°C	ON / OFF
	OFF				
4.	ON			....°C	ON / OFF
	OFF				
5.	ON			....°C	ON / OFF
	OFF				
6.	ON			....°C	ON / OFF
	OFF				
7.	ON			....°C	ON / OFF
	OFF				
8.	ON			....°C	ON / OFF
	OFF				
9.	ON			....°C	ON / OFF
	OFF				
10.	ON			....°C	ON / OFF
	OFF				
11.	ON			....°C	ON / OFF
	OFF				

Period		DAY	TIME	Tset	Pump
12.	ON			....°C	ON / OFF
	OFF				
13.	ON			....°C	ON / OFF
	OFF				
14.	ON			....°C	ON / OFF
	OFF				
15.	ON			....°C	ON / OFF
	OFF				
16.	ON			....°C	ON / OFF
	OFF				
17.	ON			....°C	ON / OFF
	OFF				
18.	ON			....°C	ON / OFF
	OFF				
19.	ON			....°C	ON / OFF
	OFF				
20.	ON			....°C	ON / OFF
	OFF				
21.	ON			....°C	ON / OFF
	OFF				

#### Example

Period		DAY	TIME	Tset	Pump
1.	ON	MO	14:30	70°C	ON / OFF
	OFF	MO	16:15		





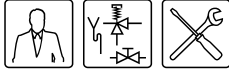

# Index

## A

- ambient temperature 18
- appliance
  - displaying history 68
  - displaying selection 68
  - displaying specifications 66
  - general working principle 13
  - heating cycle 14
  - protection 14
  - types 9, 17

## B

- burner pressure 36

## C

- claims 90
- connect 24, 25
  - air supply 26
  - Alarm OUT 35
  - circulation piping 24, 25
  - cold water side 24, 25
  - condensation drainage 24, 25
  - continuous pump 35
  - electrical 32
  - flue gas discharge 26
  - gas 26
  - hot water side 24
  - isolating transformer 34
  - program-controlled pump 35
  - Tank ON 35
- Connect Alarm OUT 35
- connecting air supply 26
- connecting circulation pipe 24, 25
- connecting cold water side 24, 25
- connecting condensation drainage 24, 25
- connecting continuous pump 35
- connecting flue gas discharge 26
- connecting hot water side 24
- connecting isolating transformer 34
- connecting Tank ON 35
- connecting the program-controlled pump 35
- controls 59
- conversion to a different gas category 39

## D

- dimensions 21
- display 49
- displaying error history 67
- document contents 12
- draining 45

## E

- electrical connection 32
- electrical connector block 33
- electrical diagram 92
- environmental conditions 17

- error 52
- extra period 51
  - operating mode 51
  - settings 64

## F

- fan 15
- filling 43
- flame probe 16
- floor loading 18
- forms of notation 11
- frost protection 51

## G

- gas category, conversion to different 39
- gas connection 26
- gas control 15
- general specifications 3
- general working principle 13

## H

- heat demand 55
- heating cycle 14, 55
- humidity 18
- hysteresis setting 67

## I

- icons
  - (pre)glow 49
  - explanation 49
  - flame detection 49
  - gas control 49
  - heat demand 49
- ignition 55
- installation engineer 10
- isolator 34

## L

- language setting 65
- liability 3

## M

- mains power 34
- maintenance
  - burner 88
  - condensation water discharge 88
  - finalising 88
  - gas-side 88
  - heat exchanger 88
  - orifice 88
  - perform 85
  - preparation 85
  - scale 87
  - to descale 87
  - water-side 87

## mode

- ERROR 52
- EXTRA 51
- HEAT DEMAND 55
- IGNITION 55
- OFF 51
- ON 51
- POST-PURGE 55
- PRE-GLOW 55
- PRE-PURGE 55
- PRESSURE SWITCH 55
- PROG 52
- RUNNING 55
- SERVICE REQUIRED 53

**N**

- navigation buttons 49

**O**

- off 51
- on 51
- ON mode 59
- on/off switch 49
- operating modes
  - EXTRA 51
  - general 51
  - OFF 51
  - ON 51
  - PROG 52

**P**

- packaging 17
- PC connection 50
- post-purge 55
- power cable 34
- pre-glow 55
- pre-purge 55
- pressure switch 15, 55
- prog 52
- protection 14
- pump 68
- push buttons 49

**R**

- running 55

**S**

- scale 87

## scrolling 49

- service check 10, 83
- service engineer 10
- service required 53
- setting backlight time 68
- setting date 65
- setting display contrast 68
- setting display scroll speed 68
- setting service interval 68
- softlite 15
- specifications 20
- starting up 55
- supply pressure 36
- symbol
  - installation engineer 10
  - service engineer 10
  - user 10

**T**

- target groups 10
- temperature sensor
  - T1 14
  - T2 14
- ThermoControl 49
  - controls 49
  - ON/OFF switch 49
- Tnet 14
- to descale 87
- to shut down
  - electrically isolating 57
  - longer period 57
  - short period 57
- trademarks 3

**U**

- user 10

**W**

- warranty 89
  - exclusions 90
  - general 89
  - installation and conditions of use 89
  - scope 90
- water
  - composition 18
  - setting the temperature 59
- week program 51

## Free Manuals Download Website

<http://myh66.com>

<http://usermanuals.us>

<http://www.somanuals.com>

<http://www.4manuals.cc>

<http://www.manual-lib.com>

<http://www.404manual.com>

<http://www.luxmanual.com>

<http://aubethermostatmanual.com>

Golf course search by state

<http://golfingnear.com>

Email search by domain

<http://emailbydomain.com>

Auto manuals search

<http://auto.somanuals.com>

TV manuals search

<http://tv.somanuals.com>