

A.O. SMITH

Installation

—

Maintenance

—

Service

—

Troubleshooting



**CENTURY®
POOL & SPA MOTOR
MANUAL**

INTRODUCTION

Welcome to A.O. Smith's line of Century[®] Motors. This pocket manual is designed for one purpose — to make it simple for you to install, maintain and troubleshoot Century pool and spa motors. Contrary to what you may be thinking just now, your last name doesn't have to be Edison in order to properly service the motors shown in the following pages. All you need are a few basic tools and some helpful hints; the kind that appear throughout this booklet.

We've included all the information we think you'll need to repair the most common pump motor problems encountered out in the field. This easy to read manual contains great illustrations and diagrams for quick reference. Assisting your customers is your job. Helping you do that with minimum delay is our job; that's why we've prepared this informative manual.



Replacements for every brand. Every now and then you probably come across a motor that's beyond repair. When you do, remember that A.O. Smith manufactures replacement pool and spa motors for practically every brand you'll ever encounter in the field. So save yourself some time and effort and just ask for Century first — at any A.O. Smith distributor or dealer. Century motors are as rugged as any you'll find, but keep in mind that all motors need service and maintenance at one time or another.

Safety first. Remember, before you begin to work on any electrical appliance be sure to **TURN OFF THE POWER**. The only time you'll need the power on is when you check motor voltage and amperage. If you overlook this important guideline, someday you could unexpectedly get a real charge out of your work! Always play it safe — double-check to be certain that the power is off before you start to work on a pool or spa motor.

If you have any suggestions or would like more information about a particular subject, please write or call:

A.O. Smith
531 North Fourth Street
Tipp City, OH 45371
800-543-9450

TABLE OF CONTENTS

| | |
|------------------------------------|----|
| Century Pump Motors | 5 |
| Design Features | 7 |
| Nameplate Information | 9 |
| Installation | |
| Heat..... | 13 |
| Moisture..... | 14 |
| Power Source..... | 14 |
| Altitude..... | 14 |
| Mounting..... | 14 |
| Electrical Connections | 15 |
| Grounding..... | 15 |
| Wire Size..... | 15 |
| Wire Selection Guide | 16 |
| Tools | 17 |
| Maintenance | |
| Moisture..... | 17 |
| Cooling..... | 18 |
| Seasonal..... | 18 |
| Cleaning..... | 18 |
| Lubrication..... | 18 |



Motor Troubleshooting

| | |
|---|-------|
| Motor Fails To Start (makes no sound) | 19 |
| Motor Fails To Start (hums, tries to start, blows fuse or trips breaker) | 20 |
| Motor Starts But Shuts Down (overload problem) | 21 |
| Noisy Motor | 21 |
| Motor Hot, Smoking Or Cycling | 22 |
| Information Needed For Motor Replacement | 23 |
| Troubleshooting A Capacitor | 23 |
| Best Way To Use A Volt-Ammeter | 24 |
| How To Replace Bearings | 24 |
| Service | 27 |
| Wiring Diagrams' Table of Contents | 28 |
| Wiring Diagrams | 29-54 |
| Date of Manufacture Table | 55 |

CENTURY® CENTURION &

Centurion®, C-flange Switchless “1081” Motor

- Standard Efficiency
- E-Plus, High Efficiency
- ½ – 5 Hp
- No Switch, No Governor
- Single phase or three phase
- Suitable for operation at 50 Hz, 1.0 service factor
- Aluminum or cast iron NEMA “C” mounting brackets
- True NEMA 56-frame
- Keyed or threaded shaft
- UL standard “1081” approvable
- Full-rated and Up-rated
- 50° C Ambient
- Available as a Century two-speed motor



Centurion® SE, C-flange Switchless “1081” Motor

- ½ – 5 Hp
- Standard Efficiency
- Single phase
- Aluminum NEMA “C” mounting brackets
- 50° C Ambient
- True NEMA 56-frame
- Keyed or threaded shaft
- UL Standard “1081” approvable
- Full-rated and Up-rated
- 303 stainless steel shaft



E-PLUS® MOTORS

Centurion®, Square Flange Switchless “1081” Motor

- Standard Efficiency
- E-Plus, High Efficiency
- ½ – 5 Hp
- No Switch, No Governor
- 303 stainless steel threaded shaft
- Suitable for operation at 50 Hz, 1.0 service factor
- Single or three phase
- True NEMA 56-frame
- UL standard “1081” approvable
- Full-rated and Up-rated
- 50° C Ambient
- Available as a Century two-speed motor



Neptune® C & Square Flange

- Standard Efficiency
- High Efficiency
- ½ – 3 Hp
- Advanced Switch Technology
- 48 frame shell diameter
- 303 stainless steel threaded shaft
- UL standard “1081” approvable
- Full-rated and Up-rated
- 50° C Ambient



FLEX-48™ POOL AND SPA MOTORS

Flex-48™ Single-Speed Motors, Thru-Bolt Mount

Suitable for jetted tubs and above-ground pools and spas.

- ½ - 3 Hp
- 56-frame conversion base
- 3-½" shaft height
- ⅜" threaded shaft
- Auto-reset overload protection
- 1.0 service factor



Flex-48™ Two-Speed Low Amp Start & Run Motors

For Spas and above-ground pools, thru-bolt mount.

- ¾ - 3 Hp
- 56-frame conversion base
- 3-½" shaft height
- ⅜" threaded shaft
- Auto-reset overload protection
- 1.0 service factor



CENTURION® DESIGN FEATURES

Century pool and spa pump motors are tailored for demanding pool loads and environments. Check these outstanding features:

1. Full-rated 56-Frame diameter gives greater thermal capacity, better durability with industrial quality construction.

CENTURION® DESIGN FEATURES

2. All Threaded shafts are 303 stainless steel for superior corrosion resistance. Keyed shaft of carbon steel is iron phosphate treated to prevent rust. Stainless steel shafts provided on cast iron C-flange, keyed shaft product.
3. Double-sealed high thrust bearings protect against dirt and moisture. Factory lubricated, never need regreasing.
4. Special aluminum alloy brackets or cast iron NEMA "C" brackets resist corrosion from pool chemicals.
5. Drive-end bearing locked to limit shaft endplay.
6. Continuous rated run capacitor provides high running efficiency and better starting performance in low voltage situations.
7. Easy connect terminal board is designed with screw post line terminals. All you need is a screwdriver for fast and easy installation wiring.
8. Moisture resistant, Class B insulated windings for extra protection against moisture, high ambient temperatures, salt spray, chemicals, diatomaceous earth, sand, dirt, insects, etc.
9. Motors designed to meet UL Standard #1081, protects internal components from rain, dirt and chemicals.
10. Class B automatic reset overload protector suitable for high ambient temperatures. Prevents nuisance tripping in hot areas.

NAMEPLATE INFORMATION

When you need information about the motor you're servicing, you'll always be able to find it printed on the motor nameplate. On A.O. Smith motors the nameplate is usually found on the side of the motor, below the capacitor. Shown below is a sample pool motor identification nameplate. As you read the nameplate, refer to the guide so that you understand the meaning of each item that the manufacturer provides about its motor. Remember also that your dealer or distributor can give you valuable information that can help you to make the correct selection of a replacement motor.

A.O. SMITH Century Centurion
Pool and Spa Duty

CAT 8638 PART 8 -165118-04 HP 3/4 TYPE CX
 VOLTS 208-230/115 AMPS SF 5.4-5.0/10.0 HZ 60
 RPM 3450 AMB. 50 °C SF 1.50 TIME CONT CODE L ENCL DP
 FR L56J FORM KJM ^{INSUL} CLASS B PH 1 SERIAL BN7-2B
 1081 POOL PUMP DUTY MOUNT HORIZ WITH VENT HOLES DOWN **MADE IN USA**

THERMALLY PROTECTED KA

LOW VOLTAGE HIGH VOLTAGE

BROWN — B WHITE — B

WHITE — L1 L1 LINE

WHITE — L2 L2 LINE

 A A

NON-REVERSIBLE

USE COPPER CONDUCTORS ONLY 174080-01

E44549 LR4642



MAGNETEK, ST. LOUIS, MO.

WARNING DANGEROUS VOLTAGE CAN CAUSE SEVERE OR FATAL INJURY • TERMINAL COVER MUST BE IN PLACE FOR SAFE OPERATION
 MUST BE INSTALLED AND GROUNDED BY QUALIFIED PERSONNEL PER NATIONAL ELECTRICAL CODE AND LOCAL CODE
 DISCONNECT POWER BEFORE SERVICING UNIT • KEEP FINGER COVER AWAY FROM OPENING AND MOVING PARTS
 DO NOT OPERATE IN EXPLOSIVE ATMOSPHERE

A.O.SMITH

1081/1795 Pump Duty

Century Pool/Jetted Tub Motor

CAT PART B - **177894** - 20 FR W48Y TYPE SP
 HP 1.0 RPM 3450 HZ 60 PH 1 SF 1.00
 VOLTS 115 AMPS 12.0
 THERMALLY PROTECTED MA FORM PHM SERIAL BL10-11
 INSUL CLASS B ENCL DP CODE H

'PATENT PENDING'

MAGNETEK, ST. LOUIS, MO. 63103

MADE IN USA

178900H

ACCEPTABLE
FOR FIELD
WIRINGUSE COPPER
CONDUCTORS
ONLY.

178584 01

W/O AIR SWITCH

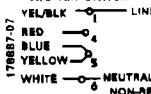

W/AIR SWITCH

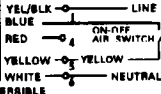

E44549



WARNING HAZARDOUS VOLTAGE CAN CAUSE SEVERE OR FATAL INJURY - MUST BE INSTALLED AND GROUNDED BY QUALIFIED PERSONNEL PER NATIONAL ELECTRICAL CODE AND LOCAL CODES - TERMINAL COVER MUST BE IN PLACE FOR SAFE OPERATION - DISCONNECT POWER BEFORE SERVICING UNIT - KEEP FINGERS AND FOREIGN OBJECTS AWAY FROM OPENINGS AND MOVING PARTS

- CAT NO (Catalog Number):** This number indicates that the motor is a stock rating, readily available from standard inventory as a replacement pool motor.
- PART:** This identifies the motor's specific design by part number.
- FR (Frame):** The frame identifies the mounting and shaft configuration. It doesn't indicate the diameter of the shell. A.O. Smith's line of Centurion and Centurion SE motors have a "56 frame" shell and are 6.5 inches in diameter. Neptune and Flex-48 products are designed in a 48 frame shell and are 5.6 inches in diameter. Common terms you'll see on the nameplate are "56J," "56C" and "56Y." The 56J is always a C-flange, threaded-shaft motor; the 56C is always a C-flange, keyed-shaft motor. Motor-frame mountings with the "Y" identification

NAMEPLATE INFORMATION

identify motors not specified by NEMA mounting and shaft standards.

- 4. TYPE:** The electrical design of the motor is shown by its type. A.O. Smith uses “CX” to identify its switchless design. Other codes include “CS” for capacitor-start, “S P” for split-phase and “CP” for capacitor start / capacitor run. Be sure to check with the dealer or distributor, because motor type codes may vary among manufacturers.
- 5. HP (Horsepower):** Conventional unit of measurement for power. One horsepower equals 746 watts.
- 6. RPM (Revolutions Per Minute):** RPM states the rotational speed of the shaft at rated load.
- 7. HZ (Hertz):** Measurement of frequency, equaling cycles per second of alternating current.
- 8. PH (Phase):** Denotes a single- or three-phase motor.
- 9. SF (Service Factor):** Service factor is the measure of the reserve margin built into a motor. Motors rated over 1.0 SF allow the motor to operate at a higher margin than designated by the horsepower rating. Maximum horsepower capability equals horsepower multiplied by the SF.
(continuous operation).
- 10. VOLTS:** Voltage is the required electrical potential applied to the motor, the force that produces current in an electrical conductor.
- 11. AMPS:** Electrical current flowing through the conductors. On pool motors, the amperage is maximum or service factor amps that result at

maximum horsepower (Hp x SF).

- 12. TIME:** Time indicates the duty cycle of the motor. Pool and spa motors are generally rated for continuous duty.
- 13. AMB (Ambient Temperature):** The maximum ambient (surrounding) temperature in which the motor is designed to operate. This temperature is shown in Celsius rather than Fahrenheit.
- 14. INSUL CLASS (Insulation Classification):** The temperature rating of insulation used in the construction of the motor. Most pool and spa motors use a Class "B" insulation.
- 15. ENCL (Enclosure):** Common enclosures used include DP (drip-proof) and TEFC (totally enclosed fan cooled). Most pool and spa motors feature a drip-proof design, with "1081" features.
- 16. CODE:** The NEMA code letter specifies locked rotor kVA per Hp (volts multiplied by locked rotor amps, divided by 1000 times rated HP).
- 17. SERIAL:** The serial indicates the date of manufacture, which often appears as year/month combinations. Serial code information for each pool and spa motor can be found in guides and bulletins provided by the manufacturer (See p.55).
- 18. VOLTAGE DIAGRAM:** This diagram provides information on the correct electrical connections to ensure proper operation of the motor.
- 19. WARNING:** The warning at the bottom of the label re-emphasizes that voltage can be hazardous. Always TURN THE POWER OFF before working on a pool or spa motor.

INSTALLATION

HEAT

The number one enemy of a motor is heat. Overheating always results whenever there is a lack of clean, continually-circulating air for a motor. Heat can damage a motor's windings, insulation, bearing lubricant and run capacitor. In short, heat can quickly decrease the service life of a motor. Remember, proper ventilation is always a crucial consideration when installing a motor.

If at all possible, install a motor in a location that is free of dirt, dust or airborne debris, such as leaves. Indoors is best, but not in areas with high humidity, such as a laundry room or shower area. If the motor is installed outdoors, try to choose a shady spot that's protected from leaves and grass clippings. If you cover the motor to protect it from possible debris or water, be sure to leave enough space between the cover and the motor for adequate ventilation.

A.O. Smith single phase pool and spa motors feature a thermal overload protector that will shut down the motor if it overheats. As the windings begin to cool down, the overload protector will automatically re-start the motor. Blocked ventilation or an overload condition can cause the motor to shutdown on a repeated basis. If a problem cannot be located or if tripping continues after a noted problem is corrected, contact the original equipment contractor for a recommendation on matching motor horsepower to the pump.

TIP: *In situations where the ambient temperature is exceptionally hot, utilizing an E-Plus (High Efficiency) motor in place of a standard efficient motor can prevent the overload protector from nuisance tripping.*

MOISTURE

Century and Neptune motors have superior resistance to moisture, but you should avoid placing the motor where it can be splashed. Avoid installing the motor in low spots where it could collect water and be flooded. In fact, it's probably a good idea to elevate the motor at least two inches off the ground.

POWER SOURCE

Before you turn the motor on, check to see that the line voltage, phase and frequency match the specifications shown on the motor nameplate. Current capacity must be adequate enough to maintain rated voltage at the motor terminals under all conditions. If it's too high, contact the local utility. If it's too low check for overloaded circuits, loose connections or wire of the wrong gauge (see wire selection guide).

ALTITUDE

Generally, motors will run hotter with increasing altitudes. For installations more than 3,300 feet above sea level, it's advisable to use a motor with the next larger horsepower rating than the one recommended for that application at sea level or use a A.O. Smith E-Plus (High Efficiency) motor of the same rating when available.

MOUNTING

Fastening the pump and motor assembly securely to a foundation or base will prevent vibration, loosening, and future misalignment. Make sure that the motor and pump assembly rotate freely before starting the motor.

ELECTRICAL CONNECTIONS

The task of wiring your motor is fairly simple. The wiring

diagrams shown on the following pages are color-coded for easy reading. The appropriate part number is listed in each illustration, just in case you need to order the complete wiring diagram or connection label sticker for your motor. Make sure the connections are tight to prevent failure or overheating. If you do find loose connections, check for excessive vibration.

GROUNDING

Without proper grounding of a motor, serious elec-

tric shock is possible. A grounding conductor should always be connected under the green grounding screw, which is located within the terminal compartment of the motor. National and local electrical codes are important, and should be adhered to when working on a motor.

WIRE SIZE

Incorrect voltage at the motor terminals can cause

the motor to overheat. It's a good idea to check the electrical supply wires to confirm that they are sufficient to handle the motor load. For example, if you're using a 1-1/2 Hp motor at 115 volts over a distance of 150 feet, use #8 wire. If the motor can be installed to operate on 230 volts, #12 wire should be sufficient for a 150 foot distance.

WIRE SELECTION GUIDE

THE SIZES SHOWN IN THE FOLLOWING WIRE SELECTION CHARTS ARE RECOMMENDATIONS ONLY. ALWAYS FOLLOW LOCAL AND NATIONAL ELECTRIC CODES.

| | | 115V Power Line | | | |
|----------|--|---|------|------|------|
| | | Maximum Distance from Fuse Box to Motor | | | |
| Motor Hp | | 50' | 100' | 150' | 200' |
| 1/3 | | 14 | 14 | 12 | 12 |
| 1/2 | | 14 | 12 | 10 | 10 |
| 3/4 | | 12 | 12 | 10 | 8 |
| 1 | | 12 | 10 | 8 | 8 |
| 1-1/2 | | 10 | 10 | 8 | 6 |
| 2 | | 10 | 8 | 6 | 6 |
| 3 | | — | — | — | — |

| | | 230V Power Line | | | |
|----------|--|---|------|------|------|
| | | Maximum Distance from Fuse Box to Motor | | | |
| Motor Hp | | 50' | 100' | 150' | 200' |
| 1/3 | | 14 | 14 | 14 | 14 |
| 1/2 | | 14 | 14 | 14 | 14 |
| 3/4 | | 14 | 14 | 14 | 14 |
| 1 | | 14 | 14 | 14 | 12 |
| 1-1/2 | | 14 | 14 | 12 | 12 |
| 2 | | 14 | 14 | 12 | 10 |
| 3 | | 12 | 12 | 10 | 10 |

Guides for copper conductors only.

TOOLS

With a few simple tools, you'll be ready for just about any kind of basic motor service. To make your job easier when installing or servicing a pool or spa motor, make sure that you have these tools in your toolbox before you begin working...

- Standard screwdriver
- Wide blade screwdriver
- 1/2" open end wrench
- Rubber mallet
- Clamp-on ammeter/voltmeter
- Ammeter
- 5/16" nut driver
- Needle-nose pliers
- Tape for marking

MAINTENANCE

A.O. Smith pool and spa pump motors are built tough, to run day after day without being serviced. When service is necessary, serviceable parts usually can be accessed quite easily. For example, capacitors are externally mounted, and single-phase motors have screw-type connectors for quick reconnection in the field.

MOISTURE

Water leaks from pump seals or pipe joints should be repaired to prevent failure of bearings and insulation. DO NOT splash or spray the motor. Mount the motor away from low spots and damp areas, and take measures to protect it from windblown rain.

MAINTENANCE

COOLING

An operating motor is usually too hot to touch by hand.

It should be located away from direct sunlight and other heat sources, such as laundry appliances and water heaters. Provide for ample air circulation around the motor. Clean the air inlets as required, making sure that the POWER IS OFF first.

SEASONAL

Whenever the motor must be shut down for extended periods, be sure all surfaces, vents and interiors are dry to prevent rust. If the motor is kept outdoors, cover it to prevent debris such as blowing leaves, dirt and snow from clogging the inlets. DO NOT SEAL THE MOTOR IN PLASTIC OR OTHER AIR-TIGHT WRAPPINGS, because condensation may form on the inside, damaging bearings and insulation.

CLEANING

In general, the inside of the motor should not need cleaning if proper safeguards are made against contamination by dirt, lint or sand. If you want to clean the outside, simply use a damp cloth. Don't spray the motor with a water hose. If it's accidentally flooded, have it inspected at a A.O. Smith authorized service center.

LUBRICATION

The ball bearings in A.O. Smith motors are double sealed, permanently lubricated. If it appears the bearings have failed, simply replace them.

MOTOR TROUBLESHOOTING

WARNING

Before you even touch the motor, **MAKE SURE THE POWER IS OFF.** Always turn the power off at the electrical service entrance fuse or breaker box, to prevent possible electric shock. To prevent electrical shock when touching the motor, be sure windings and capacitor are securely grounded to the ground terminal which should be used in conformity with local codes. Don't work on electrical operations if water or moist conditions cannot be avoided. If the motor is not operating properly, refer to the following guide.

MOTOR FAILS TO START (makes no sound)

1. Check the obvious first — are the power switch and timer on?
2. Be sure fuses are of proper size and type, then check for a blown fuse or tripped circuit breaker.
3. Be sure the motor is connected correctly (as shown on motor nameplate), but first — **TURN OFF THE POWER.** Check the terminal screw to see if it was tightened onto wire insulation instead of the wire itself. Verify that the ground wire is firmly connected to the green ground screw.
4. Check the voltage at terminal board after first **TURNING THE POWER BACK ON.** Be sure you turn the **POWER BACK OFF** after completing this step.
NOTE: Voltage at motor terminals should be $\pm 10\%$ of voltage on nameplate. If the voltage is high (more than $\pm 10\%$ above nameplate number), consult the local power company. If the voltage is low ($\pm 10\%$ below rated voltage), check the size of the power line from fuse box to motor. If the

- 
- voltage is within the proper range, check for continuity through the protector.
5. Check for overloading from other appliances on the same circuit as the motor.
 6. Inspect the motor windings for continuity.
 7. If voltage is proper at terminals and the motor is cold, remove the motor and take it to a A.O. Smith Authorized Service Center.

MOTOR FAILS TO START (hums, tries to start, blows fuse or trips breaker)

1. Check the motor connections after **TURNING OFF THE POWER**.
2. Check the voltage (see #5 above) as the motor tries to start. If voltage is too low, look for undersized wiring, an overloaded circuit or a burned start winding.
3. If the voltage is proper at terminals and motor is hot, **TURN OFF THE POWER** and allow the motor to cool to ambient temperature then reapply power. If the motor starts then shuts down, you have an overload. Check the amp draw at the motor terminal and compare it to amps shown on the motor nameplate. If the amp draw is greater than the nameplate current, check for impeller rub in the pump or a tight seal. If this fails to correct the problem, remove the motor from pump and take to a A.O. Smith Authorized Service Center.
4. Check the capacitor but first — **TURN OFF THE POWER**. After removing the capacitor from the motor, discharge it by laying an insulated screwdriver across its terminals. Check the

MOTOR TROUBLESHOOTING

capacitor using an ohmmeter (see “Troubleshooting A Capacitor” page 23).

5. Rotate the motor shaft. If you hear a grinding sound, disassemble the motor and check: the conditions of bearings, a rotor rubbing the stator, corrosion, a cracked frame, clogged fan or obstruction(s). Repair or replace any faulty part(s).
6. If the motor has a switch, disassemble the motor and check the contacts for dirt. Use brown Kraft paper to gently clean. If the motor still doesn't work, replace the switch.
7. If the switch contacts are open, check the governor for free movement on the shaft. (Incidentally, with a Centurion motor you won't have this problem, because it doesn't have a switch to malfunction.)

MOTOR STARTS BUT SHUTS DOWN (Thermal Overload Protection)

1. Check the voltage at motor terminal (see #5 under “Motor Fails To Start”). If the voltage is too high, call power company.
2. Check amperage. If high, find out if the pump impeller was recently replaced (it could be sized incorrectly). Remember, motor Hp x SF = the maximum Hp capability of motor. This number must be equal to or greater than the pump rating.

NOISY MOTOR

Air noise is normal, but an excessively high sound level or rough operation can mean trouble. If necessary, separate the motor and pump to find out where the fault lies. If it's in the motor, check the following items:

1. Mounting, motor coupling and brackets. Tighten loose nuts, bolts or set screws.
2. If a noticeable drag is present, check the bearings and bearing load spring.
3. Make sure motor fan moves freely and rotor isn't rubbing stator. Look for loose or binding parts inside the motor or pump.
4. Check for malfunctioning motor start switch and governor.

If the problem appears to be with the pump, look for a loose motor coupling, loose or damaged pump impeller, clogged pump filter or strainer, or cavitation (loss of prime or air leaks on the pump's suction side).

MOTOR HOT, SMOKING OR CYCLING

1. Check the motor's ventilation by looking for clogged air vents or openings. Clean out all leaves, dirt and other pool and spa gunk.
2. Compare connections and wiring to diagrams. Test the motor voltage to verify that it's within $\pm 10\%$ of nameplate listing.
3. If the voltage checks out but amps are higher than the maximum on the nameplate, inspect motor and pump for mechanical obstructions, but not before **TURNING OFF THE POWER**.
4. Ensure that the motor's horsepower (Hp), times the service factor (SF), is equal to or greater than the pump rating ($\text{Hp} \times \text{SF}$ to Pump Rating). A full-load current greater than the nameplate listing can mean excessive pump load.
5. Look at motor windings for damage or signs of shorting. Measure winding resistance.

MOTOR TROUBLESHOOTING

6. Check the start switch for broken contact welds or a broken spring.
7. Check the capacitor with an ohmmeter. A bulged capacitor indicates failure on most motors. But with a Centurion, the only way to verify a failed capacitor is with the ohmmeter.

INFORMATION NEEDED FOR MOTOR REPLACEMENT

To get the right replacement motor, you'll need important information. Fortunately, they all can be found on the motor nameplate. Here's what you'll need to know:

1. Mounting configuration - C-Bracket, Square Flange, or Through-bolt Mount (See page 5-7).
2. Horsepower
3. Service factor
4. Voltage
5. Pump part number, manufacturer brand name

TROUBLESHOOTING A CAPACITOR

To check a capacitor with an ohmmeter, first **TURN OFF THE POWER**. If possible, remove the capacitor from the motor.

Use an insulated screwdriver to discharge the capacitor by shorting it across its terminals.

Then set the ohmmeter to its highest setting and attach the ohmmeter's clips to the capacitor's terminals.

Check for the following indications:

1. Needle drops to zero range and slowly rises — capacitor is probably OK.
2. Needle drops to zero and stays there — capacitor most likely is shorted.
3. Needle remains at a high value — capacitor may have an open circuit.

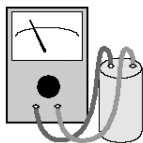

BEST WAY TO USE A VOLT-AMMETER

For Voltage Check

1. Attach leads to the volt-ammeter and select the proper voltage scale
2. Test voltage at the motor line terminals and verify that it's within limits while the motor is operating.
3. Voltage should be within $\pm 10\%$ of the design voltage specified on the motor nameplate.

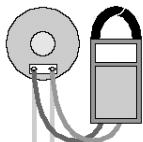

For Amperage Check

1. Remove the leads from the volt-ammeter if attached. Select lowest reading amperage scale according to motor nameplate rating.
2. Clamp instrument around one incoming lead at the motor terminal board.
3. Observe the amperage as motor runs. With proper voltage, the reading should not exceed the **MAXIMUM LOAD** or SF amps rating of the motor.

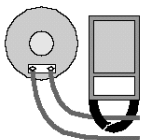

HOW TO REPLACE BEARINGS

Replacing the bearings in a motor isn't a difficult task, provided you follow set procedures. These instructions explain the correct method of motor bearing removal and replacement. If a bearing is noisy or doesn't run smoothly, it should be replaced. If a bearing has been removed for any reason, it should be replaced with a new one. As a rule, if it's necessary to replace one bearing, replace the other as well.

Use only A.O. Smith bearings with the proper part number for the motor that you're working on. A.O. Smith bearings are lubricated and require no further attention during their life. Do not substitute or reuse old

MOTOR TROUBLESHOOTING

bearings because this could damage the motor and cause a return service call.

1. TURN THE POWER OFF

2. Remove the cover from the motor and disconnect the electrical supply leads from the terminal board. Then remove the electrical cable or conduit from the end frame.

3. Remove the motor from the pump unit.

4. Mark the brackets and frame of the motor, to assure correct alignment of these parts when reassembling them.

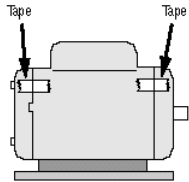

5. Remove the rotor and shaft from the frame of the motor, following these steps as necessary:

- a) Take out the thru-bolts that secure the brackets to the frame.
- b) Remove the bracket opposite the shaft by placing a screwdriver blade in the notches of this bracket and tapping the handle of the screwdriver.
- c) Remove the locking collar screws and washers if their use prevents removal of the rotor assembly from the shaft end bracket.
- d) Carefully pull the shaft/rotor assembly out of the shell or stator toward the shaft extension end.
- e) Be careful not to lose the washer and bearing load spring that is positioned in the bottom of the bearing bore of the bracket opposite the shaft extension. Be sure to replace this spring during reassembly.

- 
- 6.** Remove the bearing(s) from the motor shaft, following these steps as necessary:
 - a)** Remove shaft collars used to secure bearings. Don't reuse a bearing that is removed from the shaft.
 - 7.** Install the new shaft bearing(s). It is important to press only on the bearing inner race. The bearing will be damaged if the outer race surface is pressed.
 - a)** Fan end. Place the short end of the shaft on a wood block. Place the bearing (and other parts used) over the long end of the shaft. Tap the bearing into place, using the proper size tube and a mallet. Attach any other parts (as used) to the long shaft end.
 - b)** Opposite end. Place the long end of the shaft on the wood block. Place the bearing over the short end of the shaft. Tap the bearing into place, using the proper size tube and a mallet.
 - 8.** Reassemble the motor in reverse of the disassembly procedure.
 - a)** Observe all reassembly precautions.
 - b)** Check wiring diagrams to assure proper wiring if the leads have been removed from the terminals.
 - c)** **TURN ON THE POWER.** Check the motor for proper electrical and mechanical operation when it has been reinstalled.

SERVICE

If your pool or spa motor should need attention while still under warranty, we require that you have it serviced at a Authorized A.O. Smith Service Center to qualify for warranty coverage. When ordering parts, refer to the part number and serial number on the motor nameplate.

For your convenience, a separate Century Stock Pool and Spa Motor Parts List is available. Ask for Bulletin #3996.



WIRING DIAGRAMS TABLE OF CONTENTS

| | |
|--|------------|
| Centurion® Switchless (Easy Connect) | 29, 30 |
| Centurion® Switchless (Mfg. prior 11/91) | 31, 32, 45 |
| 1081, Wishbone (Old Style) | 33, 34, 35 |
| 1081, Single Arm Switch (Old Style) | 36, 37 |
| E-Plus®, Switchless (Old Style), 230 volt | 38 |
| 2-Speed, Wishbone (Old Style) | 39, 40, 41 |
| Micro-Switch (Formerly Gould-Guard) | 42 |
| Switchless (Formerly Gould-Guard) | 43, 44 |
| Centurion® Solid State | 46, 47 |
| E-Plus® Switchless (Mfg. prior 11/91) | 48, 49 |
| Lasar® 48 Frame (Two Speed) | 50, 51, 52 |
| Flex 48 (Single Speed) | 53, 54 |
| Neptune | 55, 58 |

CENTURION®/SE/II

For motors manufactured in/after Nov., 1991 (Serial #BJ11)
Dual Voltage Type CX-1/2 to 1 1/2 Hp
230/115 Volt Switchless

LOW VOLTAGE

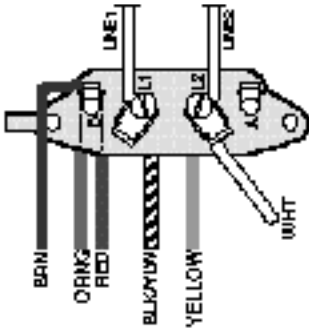

HIGH VOLTAGE

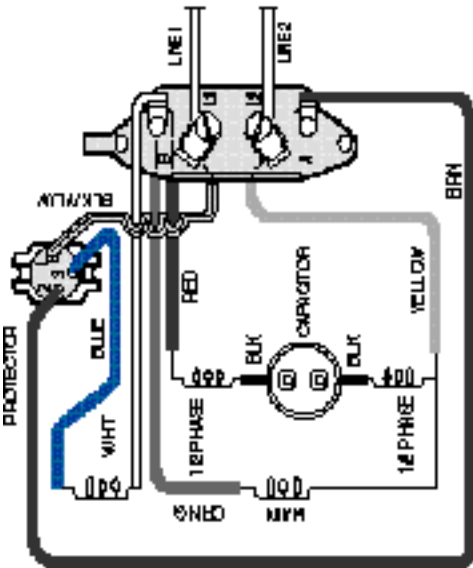

Wiring Diagram #16635902. Connection Label #17536715.

CENTURION®/SE/II

For motors manufactured in/after Nov., 1991 (Serial #BJ11)
Single Voltage
230 Volt

Type CX-1½-5Hp
Switchless

EXTERNAL CONNECTIONS

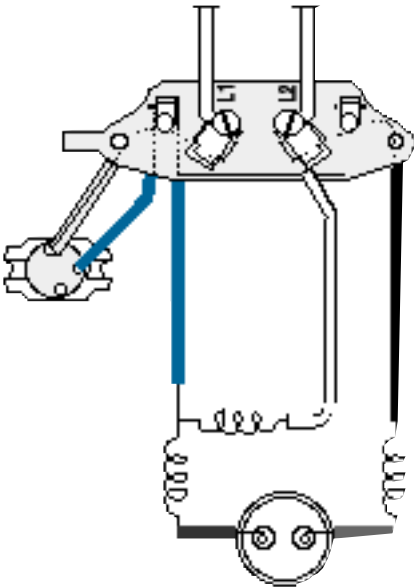

Wiring Diagram #16636001. Connection Label #17050619.

CENTURION®

For motors manufactured prior to Nov. 1991. (Serial #BJ11)

Dual Voltage
115/230 Volt

Type CX- $\frac{1}{2}$ to $1\frac{1}{2}$ Hp
Switchless

EXTERNAL CONNECTIONS

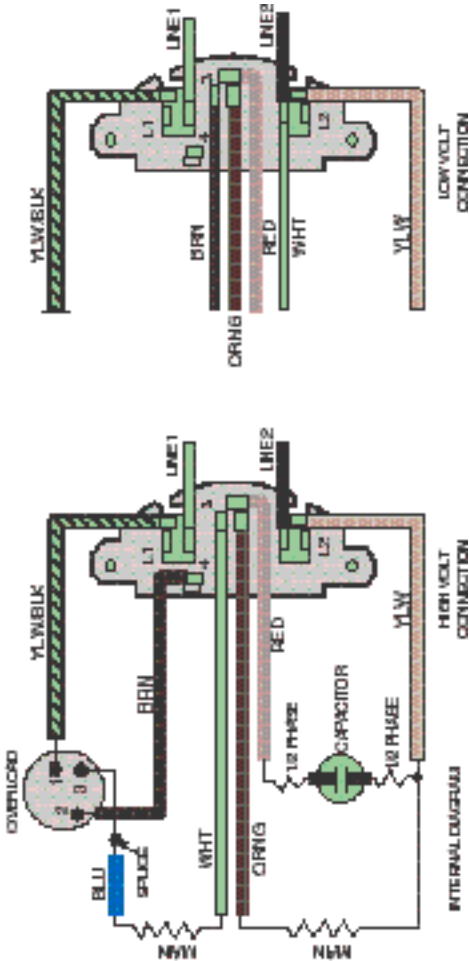

Wiring Diagram #166359. Connection Label #166362.

115/230 Volt

Type CS- $\frac{1}{2}$ to $1\frac{1}{2}$ Hp
Wishbone (Old Style)

EXTERNAL CONNECTIONS

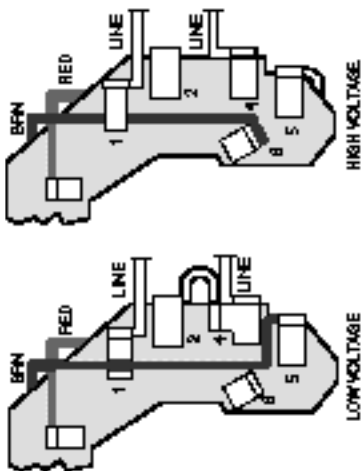

INTERNAL WIRING

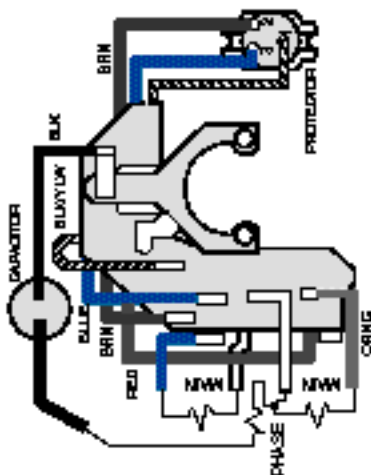

Wiring Diagram #115242. Connection Label #115325.

115/230 Volt

Type CP-2 Hp
Wishbone (Old Style)

EXTERNAL CONNECTIONS

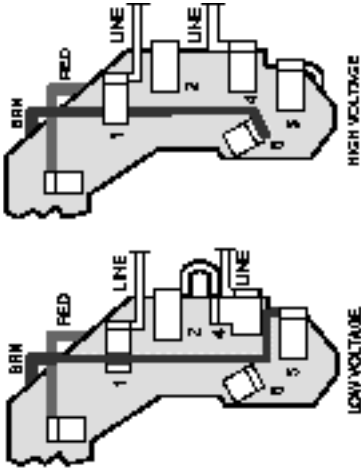

INTERNAL WIRING

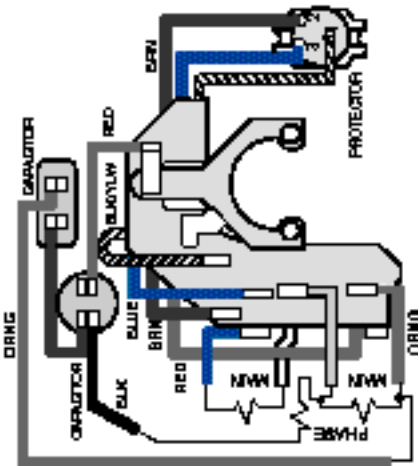

Wiring Diagram #139691. Connection Label #115325.

230 Volt

Type CP-3 Hp
Wishbone (Old Style)

EXTERNAL CONNECTIONS

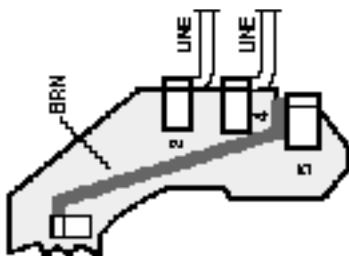

INTERNAL WIRING

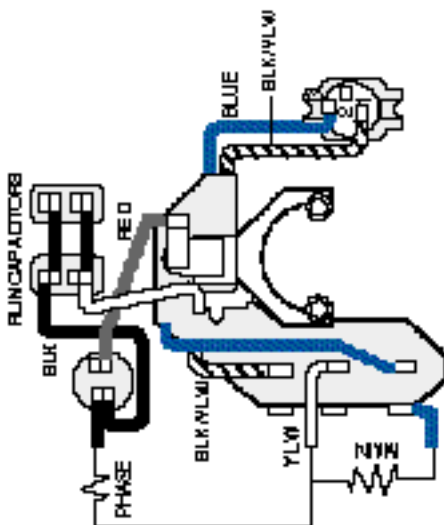

Wiring Diagram #153477. Connection Label #115317.

115/230 Volt

Type CS- $\frac{1}{2}$ to 1 $\frac{1}{2}$ Hp
Single Arm Switch (Old Style)

HIGH VOLTAGE

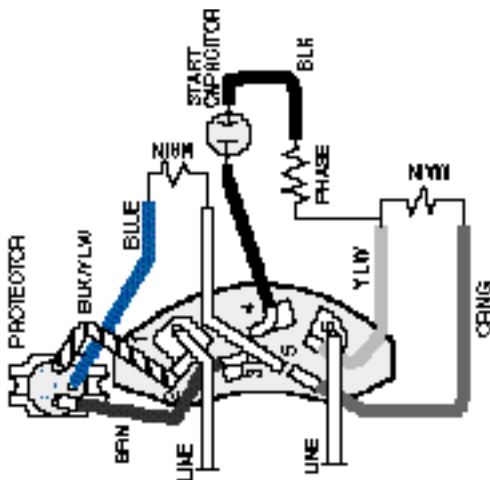

LOW VOLTAGE

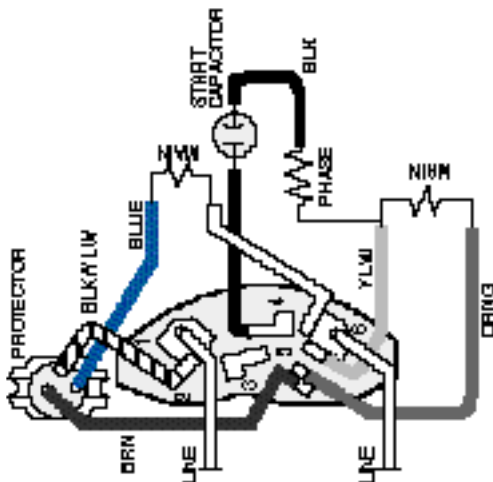

Wiring Diagram #157682. Connection Label #161035.

115/230 Volt

Type CP-2 Hp
Single Arm Switch (Old Style)

HIGH VOLTAGE

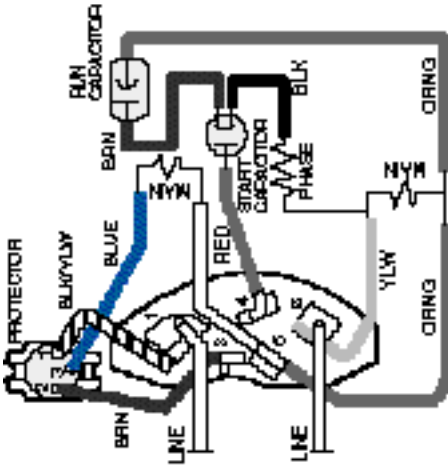

LOW VOLTAGE

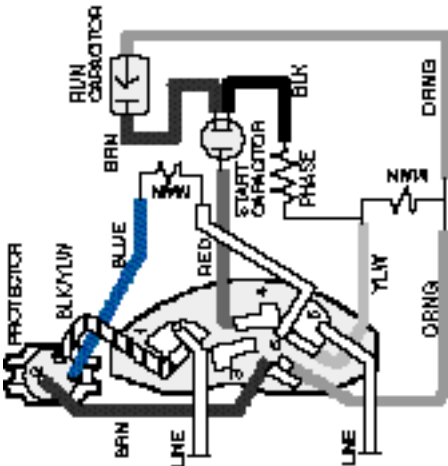

Wiring Diagram #157688. Connection Label #161034.

E-PLUS®

230 Volt

Type CX-2 and 3 Hp
Switchless (Old Style)

EXTERNAL CONNECTIONS

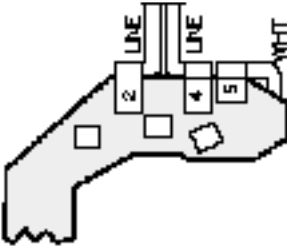

INTERNAL WIRING

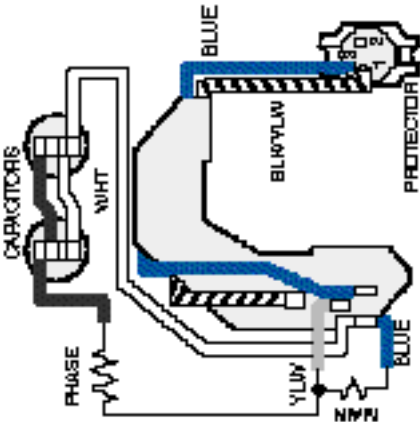

Wiring Diagram #156228.

2-SPEED

115 Volt

Type CSM-1/2 to 3/4 Hp
Wishbone (Old Style)

EXTERNAL CONNECTIONS

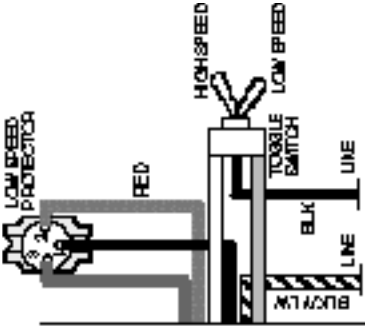

INTERNAL WIRING

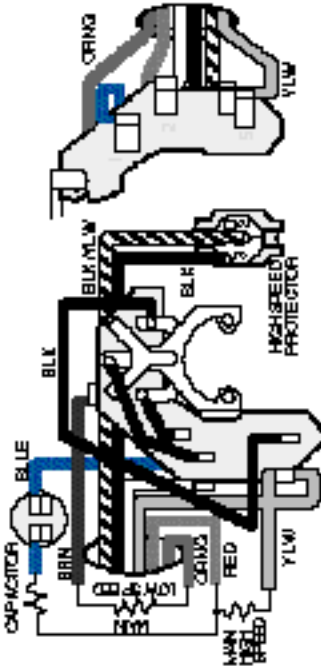

Wiring Diagram #157053. Connection Label #157187.

2-SPEED

230 Volt

Type CPM-2 Hp
Wishbone (Old Style)

EXTERNAL CONNECTIONS

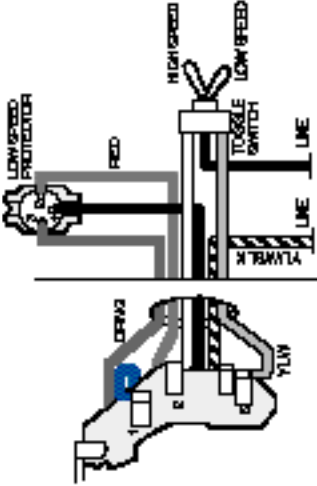

INTERNAL WIRING

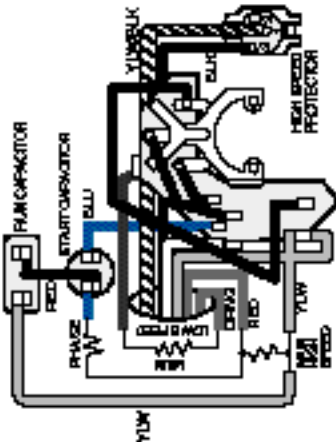

Wiring Diagram #157057. Connection Label #157187.

MICRO-SWITCH MOTOR

(Formerly identified as
Gould-Guard)
115/230 Volt

Type CS- $\frac{1}{2}$ to 1 Hp
(Old Style)

HIGH VOLTAGE

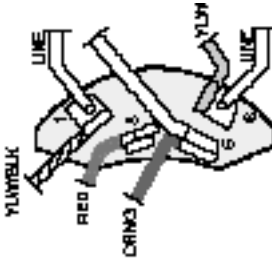

LOW VOLTAGE

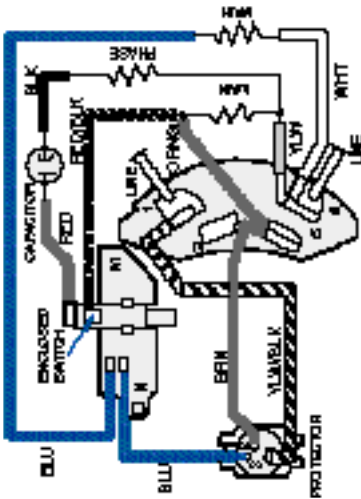

Wiring Diagram #157891. Connection Label #157892.

SWITCHLESS MOTOR

(Formerly identified as
Gould-Guard)
230 Volt

Type CX-1½ HP
Switchless (Old Style)

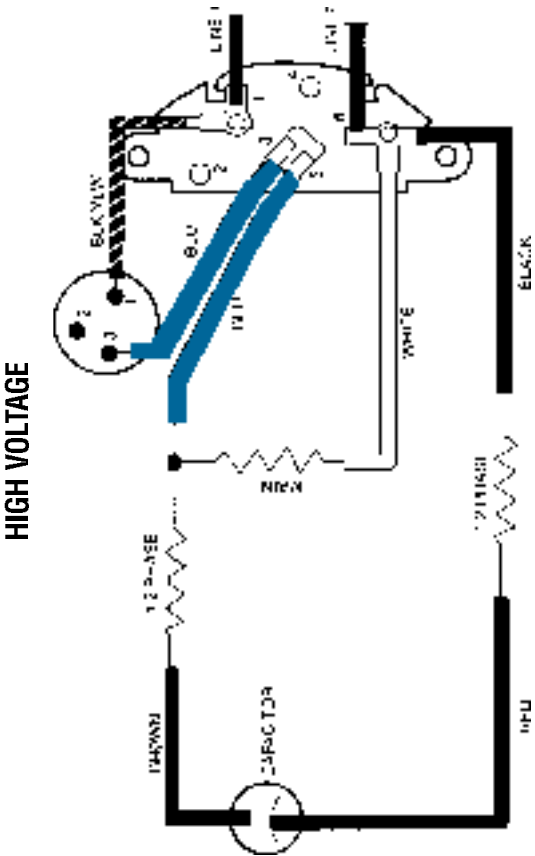

Wiring Diagram #157663. Connection Label #157664.

SWITCHLESS MOTOR

(Formerly identified as
Gould-Guard)
230 Volt

Type CX-2 and 3 HP
Switchless (Old Style)

HIGH VOLTAGE

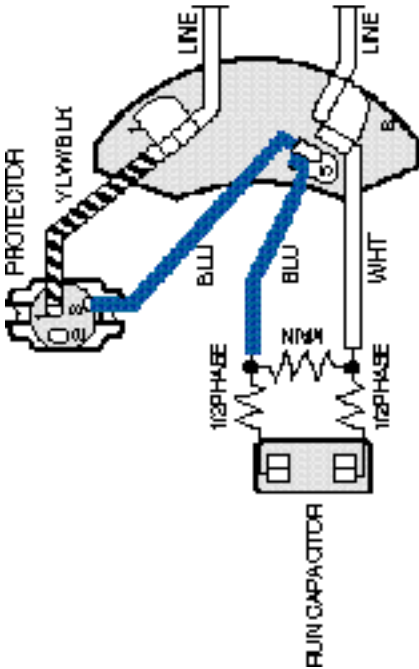

Wiring Diagram #157669. Connection Label #157664.

CENTURION®

Two-Speed
Single Voltage
115 Volt

Type CXPM- $\frac{1}{2}$ / .06 to $\frac{3}{4}$ / .10 Hp
Solid-State Switch

EXTERNAL CONNECTIONS

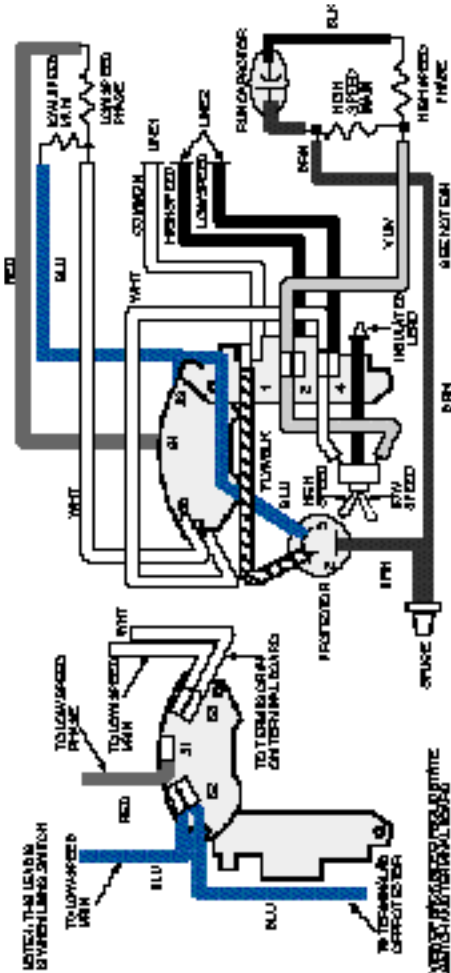

Wiring Diagram #167174. Connection Label #167200.

CENTURION®

Two-Speed
Single Voltage
230 Volt

Type CXPM-1/12 to 2/25 Hp
Solid-State Switch

EXTERNAL CONNECTIONS

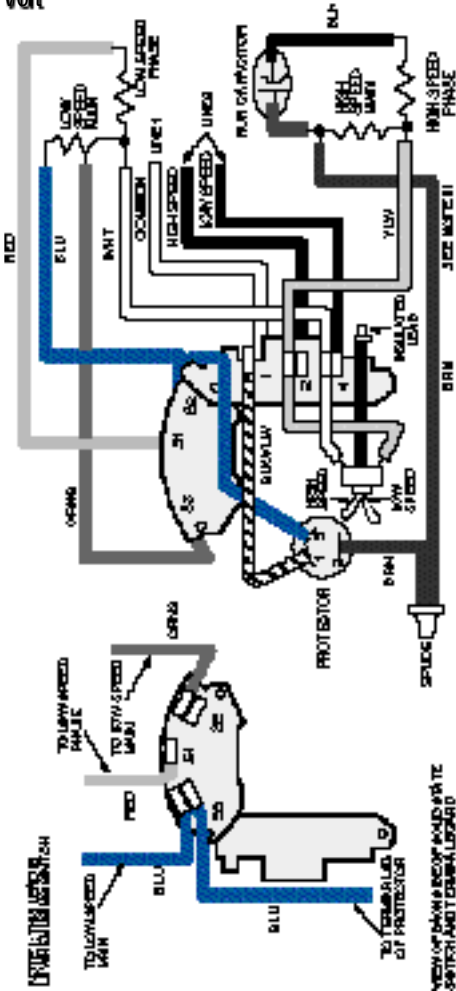

Wiring Diagram #167201. Connection Label #167200.

E-PLUS® SWITCHLESS

Dual Voltage
115/230 Volt

Type CX- $\frac{3}{4}$ to 1 $\frac{1}{2}$ Hp
Switchless

EXTERNAL CONNECTIONS

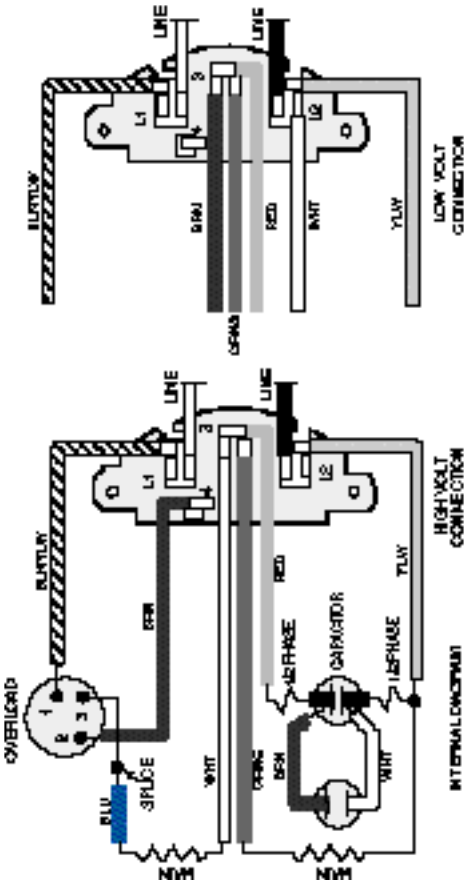

Wiring Diagram #167985. Connection Label #166362.

E-PLUS® SWITCHLESS

Single Voltage
230 Volt

Type CX-2 and 3 Hp
Switchless

EXTERNAL CONNECTIONS

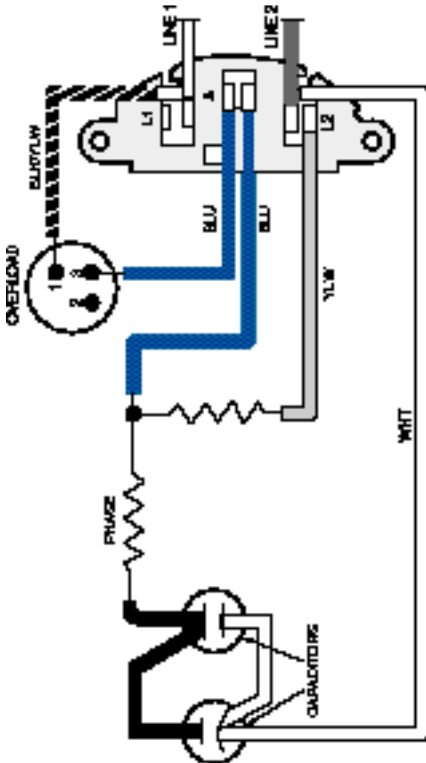

Wiring Diagram #167976. Connection Label #166363.

FLEX 48® FRAME

Two Speed Single Voltage
115 Volt

Type SPM-3/4/.10 HP

EXTERNAL CONNECTIONS

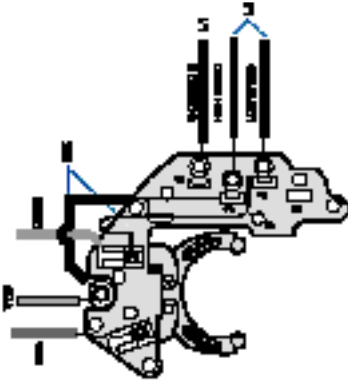

INTERNAL WIRING

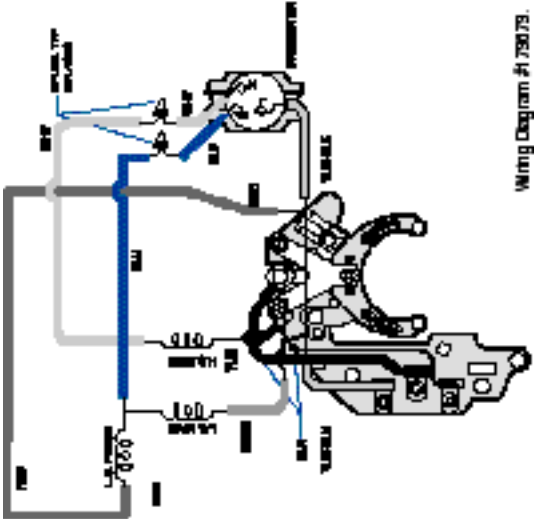

Wiring Diagram #1 750 79.

FLEX 48® FRAME

Two-Speed
Single Voltage
115 or 230 Volt

Type CXSM 1½ / .18 HP
Type CXSM 2.0 / .25 HP
through 4.5 / .50 Spl HP

EXTERNAL CONNECTIONS

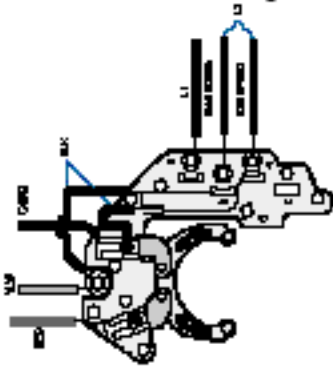

INTERNAL WIRING

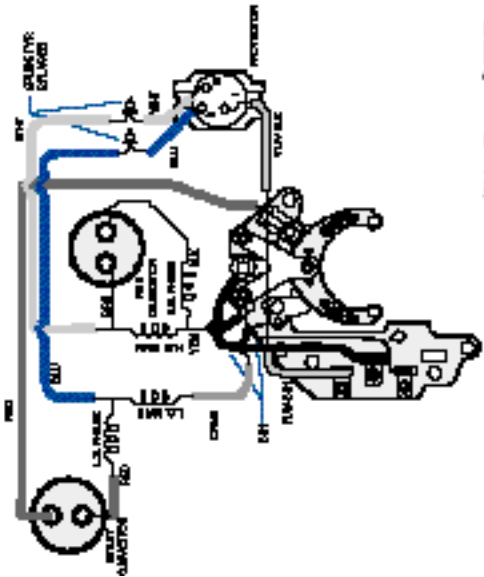

Wiring Diagram #1 798 09.

FLEX 48® FRAME

Two-Speed
Single Voltage
115 or 230 Volt

Type CSM 1.0/.12 Hp 115 Volt
Type CSM 1.0/.16 Hp 115 Volt
Type CSM 1.5/.18 Hp 230 Volt
Type CSM 2.0/.25 Hp 230 Volt

EXTERNAL CONNECTIONS

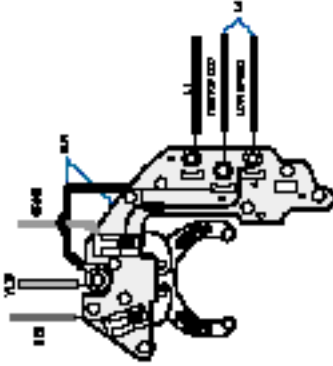

INTERNAL WIRING

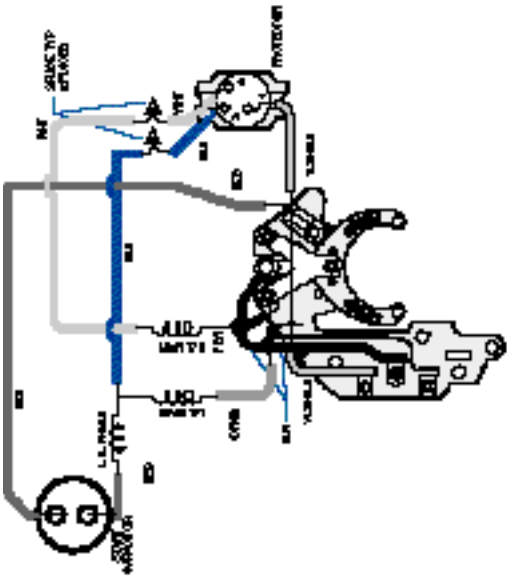

Wiring Diagram #179277.

FLEX 48®

Single Voltage
115 Volt

Type SP-1/2 to 1 1/2 Hp

WITH AIR SWITCH

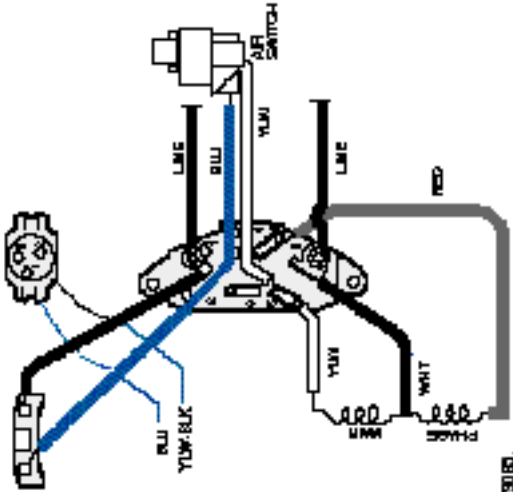

WITHOUT AIR SWITCH

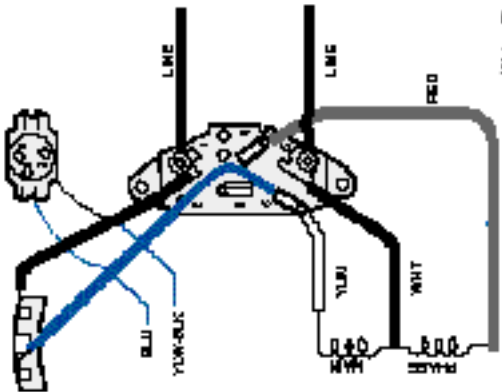

Wiring Diagram #1750180

FLEX 48®

Dual Voltage
230/115 Volt

Type CS-1½ to 4 Spl Hp

HIGH VOLTAGE

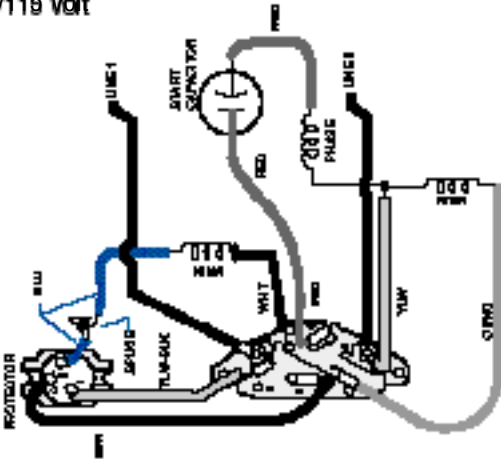

LOW VOLTAGE

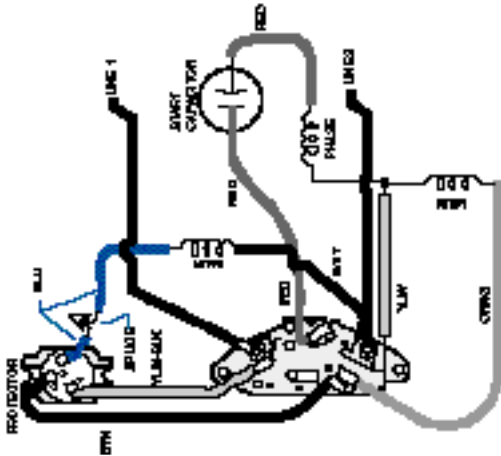

Wiring Diagram #179086.

HOW TO IDENTIFY THE DATE OF MANUFACTURE

For Century Pool, Spa or Jetted Tub Motors

To identify the month and year your Century pool, spa or jetted tub motor was manufactured you need to know the serial code.

The serial code on the nameplate is made up of three parts: serial letter (year), serial number (month), and manufacturing sequence number. Example:

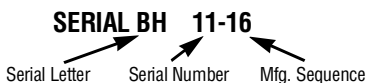

This motor was manufactured in November 1990.

Serial Letter Designation

| Serial Letter | Year | Serial Letter | Year | Serial Letter | Year |
|---------------|------|---------------|------|---------------|------|
| K | 1970 | W | 1979 | BF | 1988 |
| L | 1971 | X | 1980 | BG | 1989 |
| M | 1972 | Y | 1981 | BH | 1990 |
| N | 1973 | Z | 1982 | BJ | 1991 |
| P | 1974 | BA | 1983 | BK | 1992 |
| R | 1975 | BB | 1984 | BL | 1993 |
| S | 1976 | BC | 1985 | BM | 1994 |
| T | 1977 | BD | 1986 | BN | 1995 |
| U | 1978 | BE | 1987 | BP | 1996 |

Serial No. Designation

| Serial Letter | Year | Serial Letter | Year |
|---------------|------|---------------|------|
| 1 | JAN | 7 | JULY |
| 2 | FEB | 8 | AUG |
| 3 | MAR | 9 | SEPT |
| 4 | APR | 10 | OCT |
| 5 | MAY | 11 | NOV |
| 6 | JUNE | 12 | DEC |

NEPTUNE® 2 Compartment Motors

Single Voltage
Type CP

230 Volt
1½ 2&3 Hp

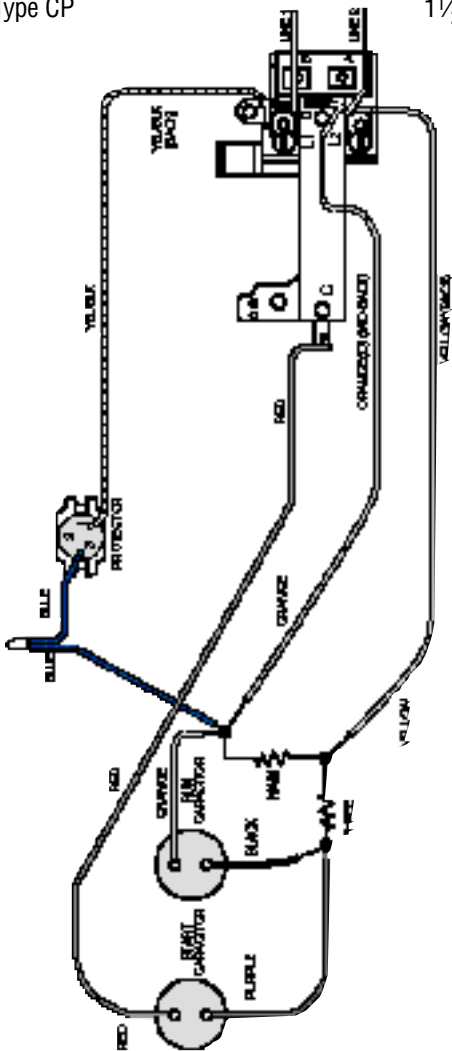

NEPTUNE® 2 Compartment Motors

Dual Voltage
230/115 Volt

Type CP
1/2-1 1/2 Hp

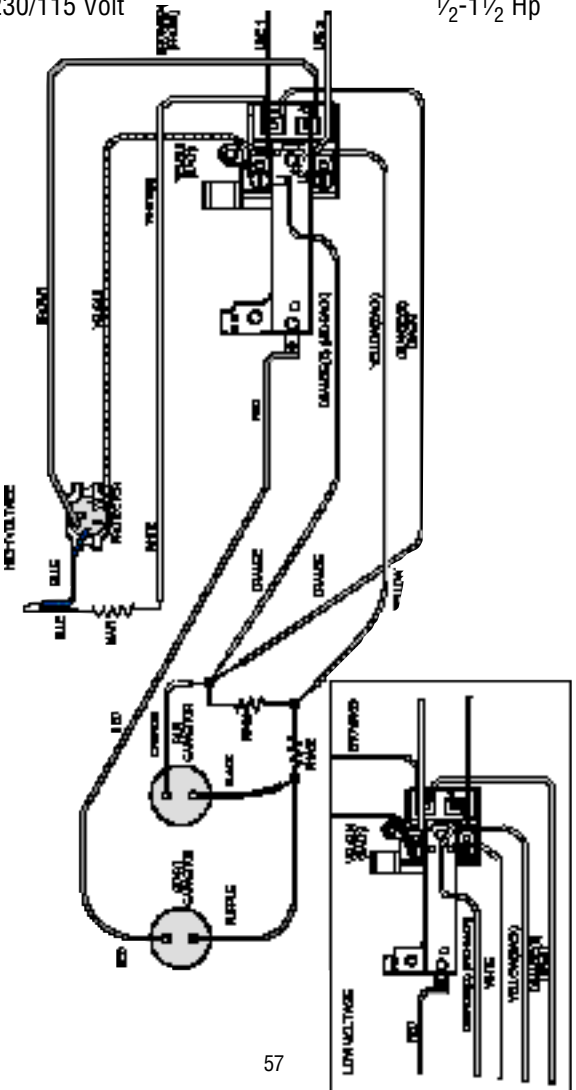

NEPTUNE® 2 Compartment Motors

Dual Voltage
230/115 Volt

Type CS
1/3-1 1/2 Hp

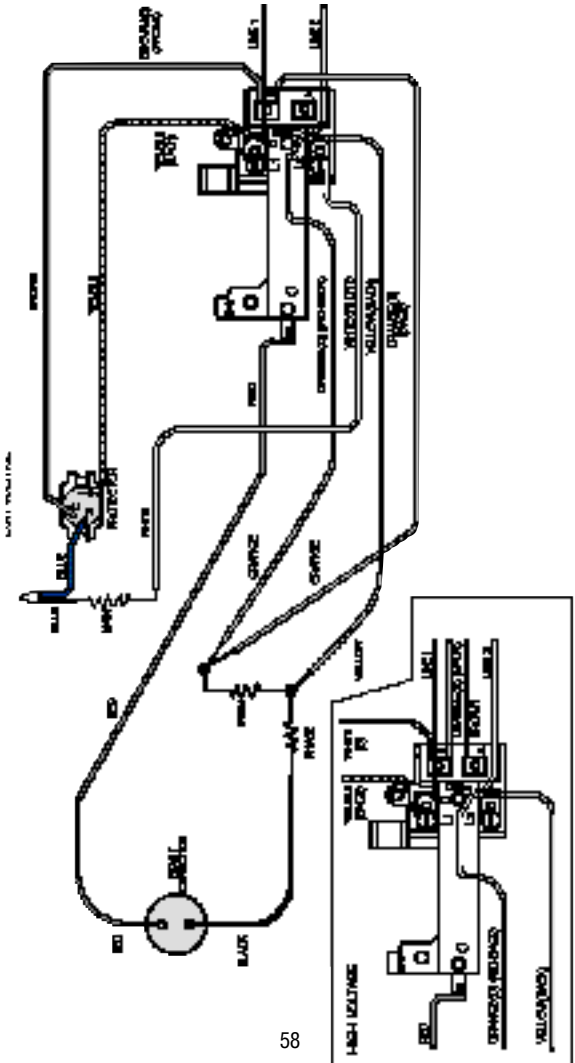

A.O. SMITH
ELECTRICAL PRODUCTS
COMPANY

A.O. Smith
531 North Fourth Street
Tipp City, OH 45371
937-667-6800
Fax (937) 667-5873

Bulletin 2944

©A. O. Smith 2000 Litho. in USA #2944 11/00

Free Manuals Download Website

<http://myh66.com>

<http://usermanuals.us>

<http://www.somanuals.com>

<http://www.4manuals.cc>

<http://www.manual-lib.com>

<http://www.404manual.com>

<http://www.luxmanual.com>

<http://aubethermostatmanual.com>

Golf course search by state

<http://golfingnear.com>

Email search by domain

<http://emailbydomain.com>

Auto manuals search

<http://auto.somanuals.com>

TV manuals search

<http://tv.somanuals.com>