



DVD HOME THEATER SYSTEM

HT-175

OWNER'S MANUAL

Register your product at www.apexdigitalinc.com

come *play* with us
www.apexdigitalinc.com



SAFETY INFORMATION

TO REDUCE THE RISK OF FIRE AND ELECTRIC SHOCK, DO NOT EXPOSE THIS UNIT TO RAIN OR MOISTURE.



CAUTION : To reduce the risk of fire and electric shock, do not remove the cover (or back) of the unit. Refer servicing only to qualified service personnel.



The lightning flash with arrowhead symbol, within an equilateral triangle, is intended to alert the user to the presence of uninsulated "dangerous voltage" within product's enclosure that may be of sufficient magnitude to constitute a risk of electric shock.



The exclamation point within an equilateral triangle is intended to alert the user to the presence of important operation and servicing instructions in the literature accompanying the appliance.

WARNING: TO REDUCE THE RISK OF FIRE OR ELECTRIC SHOCK, DO NOT EXPOSE THIS APPLIANCE TO RAIN OR MOISTURE.

CAUTION: TO PREVENT ELECTRIC SHOCK, MATCH WIDE BLADE OF PLUG TO WIDE SLOT, FULLY INSERT.

IMPORTANT SAFETY INSTRUCTIONS

In addition to the careful attention devoted to quality standards in the manufacture of your video product, safety is a major factor in the design of every instrument. However, safety is your responsibility, too. This sheet lists important information that will help to assure your enjoyment and proper use of the video product and accessory equipment. Please read them carefully before operation and using your video product.

IMPORTANT SAFETY INSTRUCTIONS

1. Read these instructions.
2. Keep these instructions.
3. Heed all warnings.
4. Follow all instructions.
5. Do not use this apparatus near water.
6. Clean only with a dry cloth.
7. Do not block any ventilation openings. Install in accordance with the manufacturer's instructions.
8. Do not install near any heat sources such as radiators, heat registers, stoves, or other apparatus (including amplifiers) that produce heat.
9. Do not defeat the safety purpose of the polarized plug. A polarized plug has two blades with one wider than the other. The wide blade is provided for your safety. If the provided plug does not fit into your outlet, consult an electrician for replacement of the obsolete outlet.
10. Protect the power cord from being walked on or pinched particularly at plugs, convenience receptacles, and the point where they exit from the apparatus.
11. Only use attachments/ accessories specified by the manufacturer.
12. Use only with the cart, stand, tripod, bracket, or table specified by the manufacturer, or sold with the apparatus. When a cart is used, use caution when moving the cart/ apparatus combination To avoid injury from tip-over.
13. Unplug this apparatus during lightning storms or when unused for long period of time.
14. Refer all servicing to qualified service personnel. Servicing is required when the apparatus has been damaged in any way, such as when the power-supply cord or plug is damaged, liquid has been spilled, objects have fallen into the apparatus, the apparatus has been exposed to rain or moisture, or when the unit does not operate normally, or has been dropped.
15. The apparatus shall not be exposed to dripping or splashing and no objects filled with liquids, such as vases, shall be placed on the apparatus.
16. Power cord protection- To avoid any malfunctions of the unit and to protect against electric shock, fire or personal injury, please observe the following:
 - a) Hold the plug firmly when connecting or disconnecting the AC power cord to this unit.
 - b) Do not connect or disconnect the AC power cord with wet hands.
 - c) Keep the AC power cord away from heating appliances.
 - d) Never put any heavy object on the AC power cord.
 - e) Do not attempt to repair or reconstruct the AC power cord in any way.
17. Remove dust, dirt, etc. on the plug at regular intervals.
18. If the unit has been dropped or otherwise damaged, turn off the power and disconnect the AC power cord.
19. If smoke, odors or noises are emitted from the unit, turn off the power and disconnect the AC power cord.
20. Placement: Avoid placing the unit in areas of direct sunlight, heating radiators, closed automobiles, high temperature (over 35C(95F), high humidity (over 90%), excessive dust, vibration, impact or where the surface is tilted, as the internal parts may be seriously damaged.
21. Non-use periods- When the unit is not used, turn the power off.
22. When the unit is unused for a long period of time, the unit should be unplugged from the household AC outlet.
23. No fingers or other objects inside-Touching internal parts of this unit is dangerous and may cause serious damage to the unit. Do not attempt to disassemble the unit.
24. Do not put any foreign object on the disc tray.
25. Keep away from water and magnets.
26. Keep the unit away from flower vases, tubs, sinks, etc. If liquids are spilled into the unit, serious damage could occur.
27. Keep magnetic objects, such as speakers, distant from the player.
28. Stacking: Place the unit in a horizontal position and do not place anything heavy on it.
29. Do not place the unit on amplifiers or other equipment which may become hot.
30. Condensation/Moisture may form on the lens in the following cases:a) immediately after a heater has been turned on b) in a steamy or very humid room c)the unit is moved from a cold environment to a warm one.
31. If moisture forms inside this unit, it may not operate properly. In this case, turn off the power and wait about one hour for the moisture to evaporate.
32. Noise interference while a broadcast is being received. Depending on the reception condition of TV, interference may appear on the TV screen while you are watching a TV broadcast, if the units is switched on. This is not a malfunction of the unit or the TV. To watch a TV broadcast, turn off this unit.
33. Use of controls or adjustment or performance of procedures other than those specified here in may result in hazardous radiation exposure.
34. Polarization- This video product is equipped with a polarized alternating -current line plug. This plug will fit into the power outlet, try reversing the plug. If the plug still fails to fit, contact your electrician to replace your obsolete outlet. To prevent electric shock, do not use this polarized plug with an extension cord, receptacle, or other outlet unless the blades can be fully inserted without blade exposure. If you need an extension cord, use a polarized cord.



SAFETY INFORMATION -CONTINUED

Notes on handling

- When shipping the player, the original shipping carton and packing materials may come in handy. For maximum protection, repack the unit as it was originally packed by the factory.
- Do not use volatile liquids, such as insect spray, near the player. Do not leave rubber or plastic products in contact with the unit for a long time. They will leave marks on the finish.
- The top and rear panels of the unit/ powered subwoofer may become warm after a long period of use. This is not a malfunction.
- When the unit is not in use, be sure to remove the disc and turn off the power.

Notes on location

- Place the player on a level surface. Do not use on a shaky or unstable surface such as a wobbling table or inclined stand. If this occurs, the loaded disc may come off its spindle and cause damage to the player.
- When you place this player near a TV or radio, the playback picture may become poor and the sound may be distorted. In this case, place the player away from the TV or radio.

Notes on cleaning

Use a soft, dry cloth for cleaning.

- For stubborn dirt, soak the cloth in a weak detergent solution, wring well and wipe. Use a dry cloth to wipe it dry. Do not use any type of solvent, such as thinner and gasoline, as they may damage the surface of the player.
- If you use a cloth saturated with a cleaning agent, follow that product's instructions and test a small, unobtrusive place on the player before cleaning further to ensure no harm will come to the unit's finish.

To obtain a clear picture

The player is a precision device. If the optical pick-up lens and disc drive parts are dirty or worn down, the picture quality becomes poor. To maintain a clear picture, we recommend regular inspection and maintenance (cleaning or parts replacement) every 1,000 hours of use depending on the operating environment. For details, contact your nearest dealer.

Notes on moisture condensation

Moisture condensation damages the player. Please read the following carefully.

Moisture condensation occurs, for example, when you pour a cold drink into a glass on a warm day. Drops of water form on the outside of the glass. In the same way, moisture may condense on the optical pick-up lens inside this unit, one of the most crucial internal parts of the player.

Moisture condensation occurs during the following cases.

- When you bring the player directly from a cold place to a warm place.
- When you use the player in a room where you just turned on the heater, or a place where the cold wind from the air conditioner directly hits the unit.
- In summer, when you use the player in a hot and humid place just after you move the unit from an air-conditioned room.
- When you use the player in a humid place.

Do not use the player when moisture condensation may occur.

If you use the player in such a situation, it may damage discs and internal parts. Remove the disc, connect the power cord of the player to the wall outlet, turn on the player, and leave it for two or three hours, the player will have warmed up and evaporated any moisture. Keep the player connected to the wall outlet and moisture condensation will seldom occur.

UNPACKING

First check and identify the contents of your HT-175 package, as listed below:

- DVD Home Theater unit
- Remote control (1)
- Size AAA batteries (2)
- Audio cable (1 pair)
- Video cable (1)
- Owner's manual (1)
- AM loop antenna (1)
- All in one control cable (1)
- FM wire antenna (1)
- Speakers (5), Powered Subwoofer (1)
- Speaker cables (5 pair)

If any item should be damaged or missing, please inform your dealer without delay.

Keep the packaging materials, you may need them to transport your player in the future.

WHERE TO PLACE YOUR UNIT

- Place the unit on a firm, flat surface.
- When you place the unit near other electronics, the playback picture may become poor and/or distorted. In this situation, move the unit further away from them.
- Keep away from direct sunlight & domestic heating equipment.
- If placed in a cabinet, please allow at least 2.5 cm (1 inch) of free space all around the player for proper ventilation.

TO OBTAIN A CLEAR PICTURE

This unit is a precision device. If the optical pick-up lens and disc drive parts become dirty or worn down, the picture quality may become poor. To obtain a clear picture, we recommend regular inspection and maintenance (cleaning or parts replacement) every 1,000 hours of use depending on the operating environment. For details, contact your nearest dealer.

NOTICE:

The OSD and the illustration in this manual may be somewhat different from the unit.
Please take the unit as the standard.

FCC INFORMATION / DISCLAIMERS

Note: This equipment has been tested and found to comply with the limits for a Class B digital device, pursuant to Part 15 of the FCC Rules. These limits are designed to provide reasonable protection against harmful interference in a residential installation. This equipment generates, uses, and can radiate radio frequency energy and, if not installed and used in accordance with the instructions, may cause harmful interference to radio communications. However, there is no guarantee that interference will not occur in a particular installation. If this equipment does cause harmful interference to radio or television reception, which can be determined by turning the equipment off and on, the user is encouraged to try to correct the interference by one or more of the following measures:

- Reorient or relocate the receiving antenna.
- Increase the separation between the equipment and receiver.
- Connect the equipment into an outlet on a circuit different from that to which the receiver is connected.
- Consult the dealer or an experienced radio/TV technician for help.

FCC Warning

The user is cautioned that changes or modifications not expressly approved by the manufacturer could void the user's authority to operate the equipment.

NOTE: In order for an installation of the product to maintain compliance with the limits for a Class B device, shielded cables must be used.

The HT-175 supports "clear" or "unprotected" WMA content only. It does not support secure music downloads from services that require Digital Rights Management (DRM) capabilities.

This product incorporates copyright protection technology that is protected by method claims of certain U.S. patents and other intellectual property rights owned by Macrovision Corporation and other rights owners. Use of this copyright protection technology must be authorized by Macrovision Corporation, and is intended for home and other limited viewing uses only unless otherwise authorized by Macrovision Corporation. Reverse engineering or disassembly is prohibited.

There may be circumstances where a multimedia file that is played back on your unit may not work properly. THIS IS NOT A MALFUNCTION OF THE HT-175 this is a common occurrence with media files due to the differences in how the original file was encoded.

Note: Apex Digital inc, shall not be responsible for damage that may occur to a disc from being operated in the player.

Due to unforeseen software compatibility issues, certain forms of disc media may not playback properly. This includes compressed media formats, i.e. MP3, JPEG files.

CAUTION:

VISIBLE LASER RADIATION WHEN OPEN AND INTERLOCK FAILED OR DEFEATED. DO NOT STARE INTO BEAM.

CAUTION: THIS PRODUCT UTILIZES A LASER. USE OF CONTROLS OR ADJUSTMENTS OR PERFORMANCE OF PROCEDURES OTHER THAN THOSE SPECIFIED HEREIN MAY RESULT IN HAZARDOUS RADIATION EXPOSURE.

This unit contains a semiconductor laser system and is classified as a "CLASS 1 LASER PRODUCT." So, to use this model properly, read this Instruction Manual carefully. In case of any trouble, please contact the store where you purchased the unit. To prevent being exposed to the laser beam, do not try to open the enclosure.

Manufactured under license from Dolby Laboratories. "Dolby" and the double-D symbol are trademarks of Dolby Laboratories. Confidential unpublished works. © 1992-1997 Dolby Laboratories.
All rights reserved.

TABLE OF CONTENTS

Safety Information.....	1
FCC Information / Disclaimers.....	3
Table of Contents.....	4
Introduction.....	5
What's in the box?.....	5
Remote Control Battery Installation.....	6
Front Panel Overview.....	7
Visual Function Display (VFD).....	7
Top Panel Overview (Controls).....	7
Rear Panel Overview.....	8
Powered Subwoofer Overview.....	8
Remote Control Overview.....	9
Subwoofer/Speaker Setup.....	10
Subwoofer/Satellite Speaker Wiring Diagram.....	11
Placement of HT-175 Speakers in your room.....	12
Connecting to your TV.....	13
AM/FM Antenna Connections.....	14
Getting Started.....	15
How to play a disc.....	15
Listening to AM/FM Radio.....	16
Adjusting Level, Volume, Bass/Treble.....	17
Setting the System Clock.....	17

Function Buttons

Skip Forward/Backward.....	18
search Forward/Backward.....	18
Slow.....	18
Dimmer.....	18
GoTo a desired selection.....	19
Numeric Key Pad/Direct Program Access.....	20
Multi-Angle.....	20
Progressive Scan.....	20
Zoom.....	21
Display.....	21
Mute.....	21
Subtitle.....	22
Audio.....	22
Sleep Timer.....	22
AFF (Active Full Screen Function).....	23

MP3/WMA Playback.....	24
------------------------------	-----------

KODAK/JPEG Photo Playback.....	25
---------------------------------------	-----------

Setup Menu Options.....	26
--------------------------------	-----------

Language Setup Page:

-OSD Menu.....	26
-Subtitle Menu.....	26
-Audio Menu.....	27
-DVD Menu.....	27

Setup Menu Options

Video Setup Page:

-TV Shape.....	27
-Video Output.....	28

Audio Setup Page:

-Digital Out.....	28
-Test Tone.....	28
-DRC (Dynamic Range Compression).....	29
-Center Delay.....	29
-Rear Delay.....	29

Rating

Password/Rating/Load Factory.....	30
-----------------------------------	----

Troubleshooting.....	31
-----------------------------	-----------

Specifications.....	32
----------------------------	-----------



Warranty.....	33
----------------------	-----------

INTRODUCTION

Thank you for purchasing your new Apex Digital HT-175 Mini Home Theater System. Your system is designed for you to enjoy most forms of disc media (DVD, CD, MP3 and WMA) and while playing DVDs, you'll enjoy "at -the-movies" picture and cinema quality sound in 5.1 digital surround. AM/FM stereo playback is available in 2.1 channel mode (2 front speakers and 1 subwoofer).

It has several enhanced features, including Component and S-Video outputs, Parental Control, and Kodak Picture CD compatibility to view your digital photo files in a slide show presentation.

The Progressive Scan feature will provide a "film like" quality when connected between the component (Y,Pb,Pr) connectors and your ED/HDTV set.

Disc Types	DVD	CD
Capacity	Single-layer / Single side 4.7GB = 2 hr Single-layer / Double sided 8.5GB = 4 hr Dual-layer / Single side 9.4GB = 4.5 hr Dual-Layer / Double sided 17GB = 8 hr	650MB = 74min
Disc Size	12 cm/8 cm	12 cm/8 cm
Subtitles	32	
Soundtracks	8	
Format Logo		

Note: Apex Digital inc, shall not be responsible for damage that may occur to a disc from being operated in the player.

Due to unforeseen software compatibility issues, certain forms of disc media may not playback properly. This includes compressed media formats, i.e. MP3, JPEG files.

DVD features symbols:

Each DVD disc contains various features depending on production of the disc. Below are some of the symbols representing the features:

Regional Code / Video output system



DVD Discs are manufactured under a worldwide agreed upon "DVD Regional Code System". This player is designed for playback of Region 1 discs only, for use in Canada and USA.

Dolby Digital Surround



DTS Digital Surround



Number of Audio Tracks



Number of Subtitles
Screen Format



Child Lock



Angle Indicator



The player has built in copyright protection technology that prevents copying from a DVD disc to any media.

If a video recorder is connected to the player, the video output image will be distorted during recording.

What's in the Box?

- DVD Home Theater unit
- Remote control (1)
- Size AAA batteries (2)
- All in One Control Cable (1)
- Audio cable (1 pair)
- Video cable (1)
- Owner's manual (1)
- AM loop antenna (1)
- FM wire antenna (1)
- Speakers (5), Powered Subwoofer (1)
- Speaker cables (5 pair)

If any item should be damaged or missing, please inform your dealer without delay. Keep the packaging materials, you may need them to transport your player in the future.

Care of the Disc

A video disc contains high density compressed data that requires proper Handling.

Hold the disc's outer edge and/or the center spindle hole.

Do not touch the disc surface if at all possible.

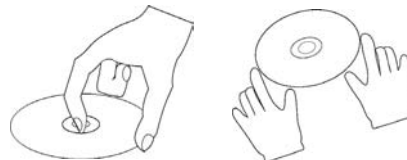

Do not bend or press on the disc. Do NOT expose the disc to direct sunlight or heating sources.



Store discs in a cabinet vertically, in a dry location.

Prevent exposure to:

- Direct sunlight
- Heat or exhaust from a heating device.
- Extreme humidity.

Clean the disc surface with a soft, dry cleaning cloth. Wipe the disc surface gently, from center toward the outer edge.

Do not apply thinner, alcohol chemical solvent, or sprays when cleaning. Such cleaning fluids will permanently damage the disc surface.

Do not attach paper or tape to the disc.

A video disc contains high density compressed data that requires proper Handling.

REMOTE CONTROL BATTERY INSTALLATION

Remove the battery compartment cover.

Load two AAA batteries into the battery compartment.

Make sure that the batteries have been inserted properly, matching to the symbols +, - marked in the battery compartment. Close the battery compartment cover.

When replacing batteries, replace both batteries. Do not mix new and used batteries together, otherwise, battery life will be much shorter than normal.

Remove the batteries if the unit will not be used for a prolonged period of time.

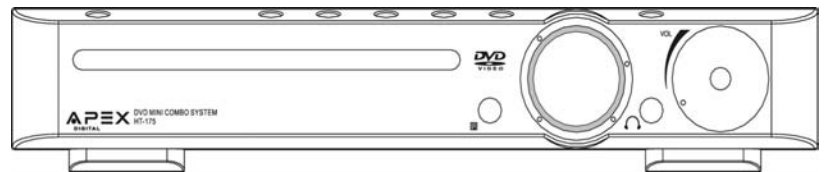

The remote control transmits a directional infrared beam. Be sure to aim the remote control directly at the infrared sensor of the unit during operation.

If the sensor has been covered or there is a large object between the remote control and the sensor, the sensor will not respond.

The sensor may not be able to receive the remote signal when it is exposed to direct sunlight or a strong artificial light (fluorescent or strobe light). In this case, change the direction of the light or reposition the unit to avoid direct lighting.

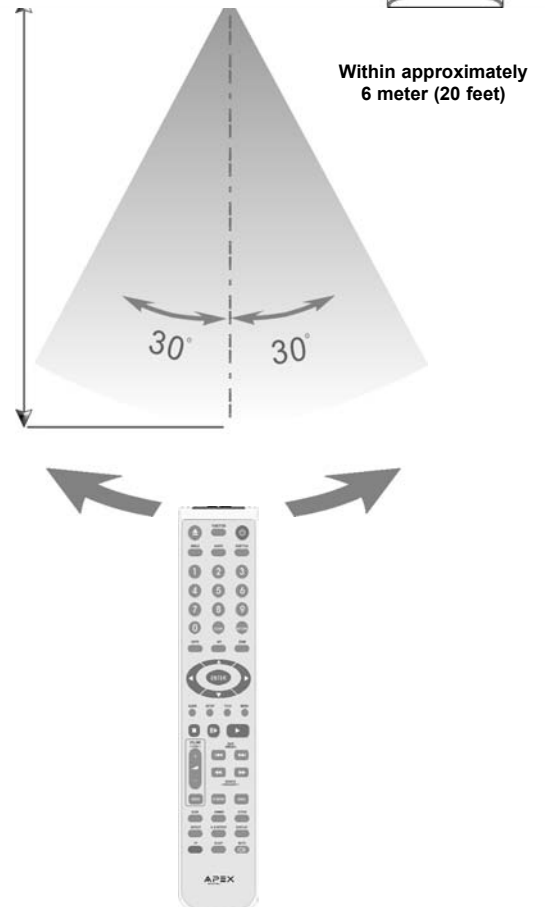

FRONT PANEL OVERVIEW (DISPLAY)

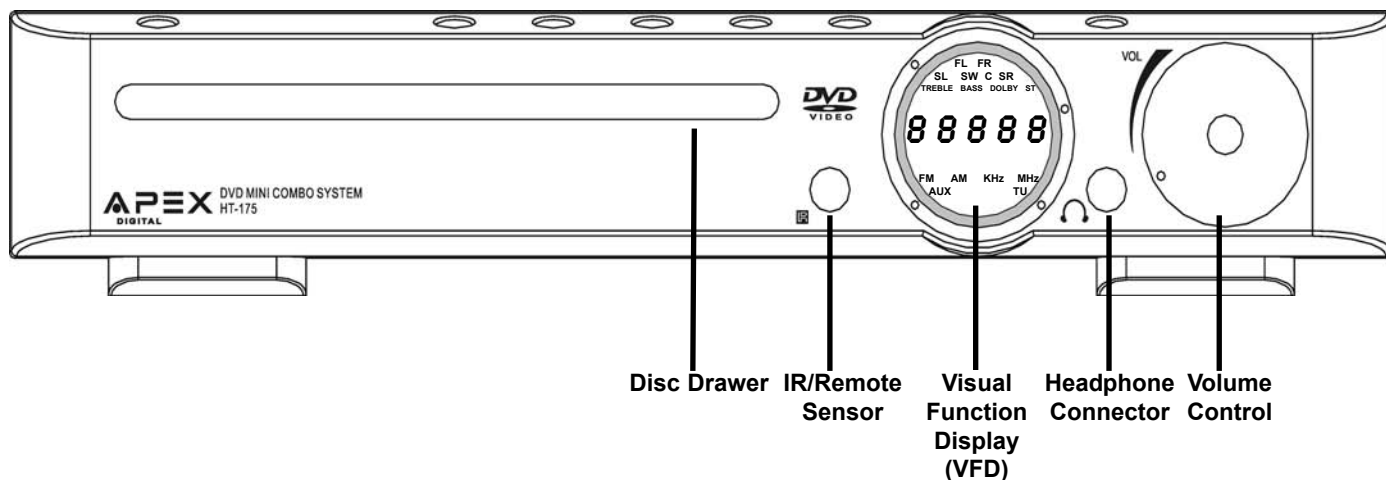

VISUAL FUNCTION DISPLAY (VFD)

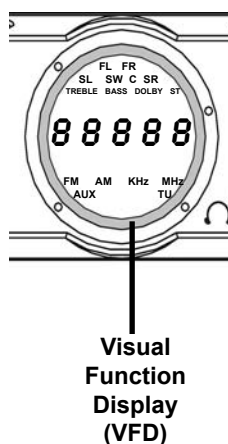

TOP PANEL OVERVIEW (CONTROLS)

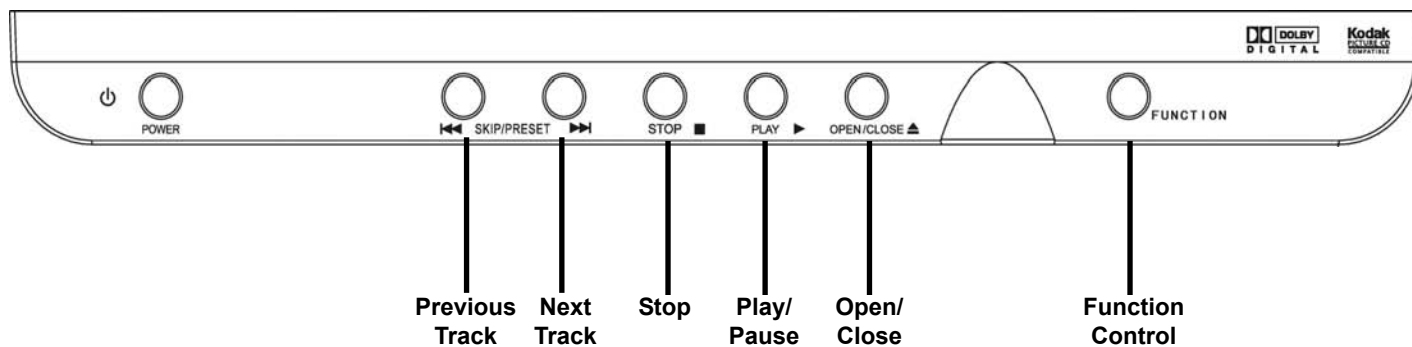

REAR PANEL OVERVIEW

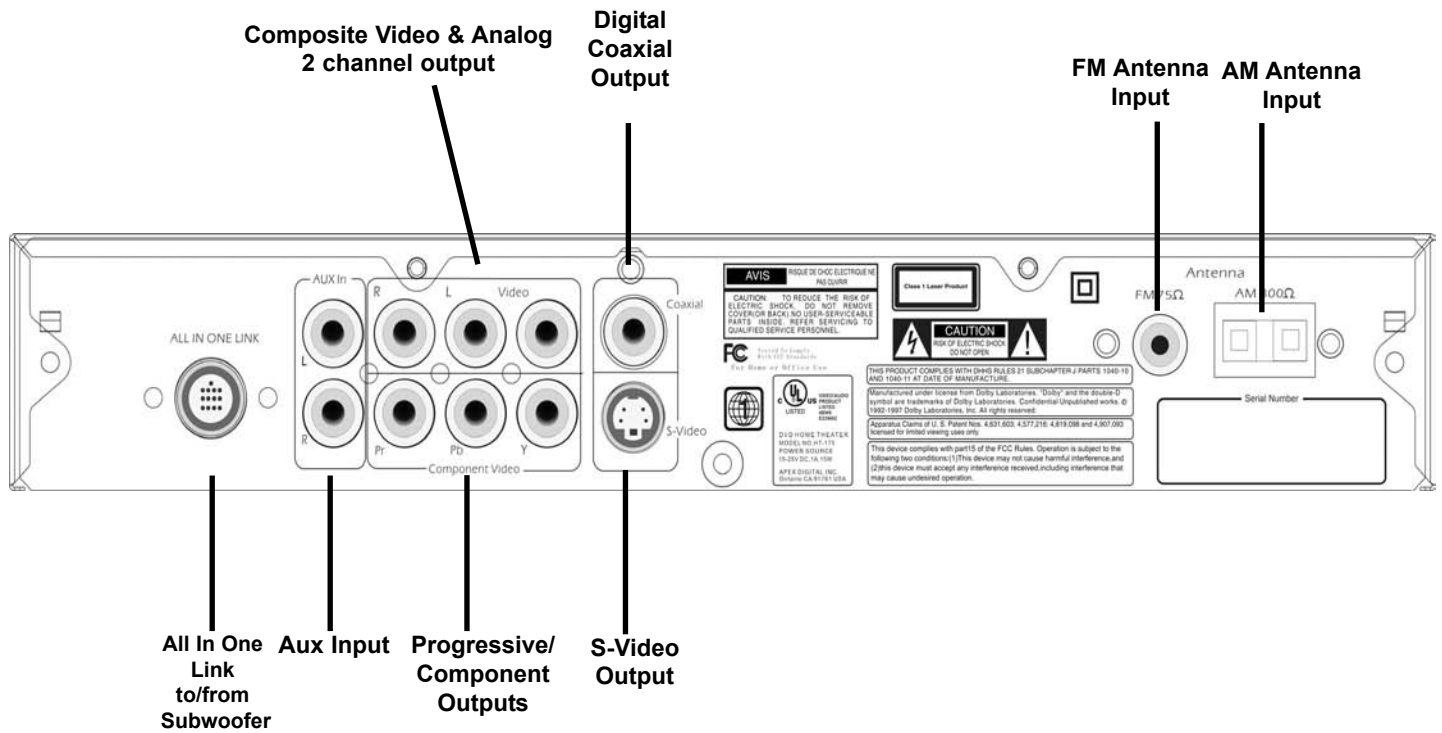

POWERED SUBWOOFER OVERVIEW

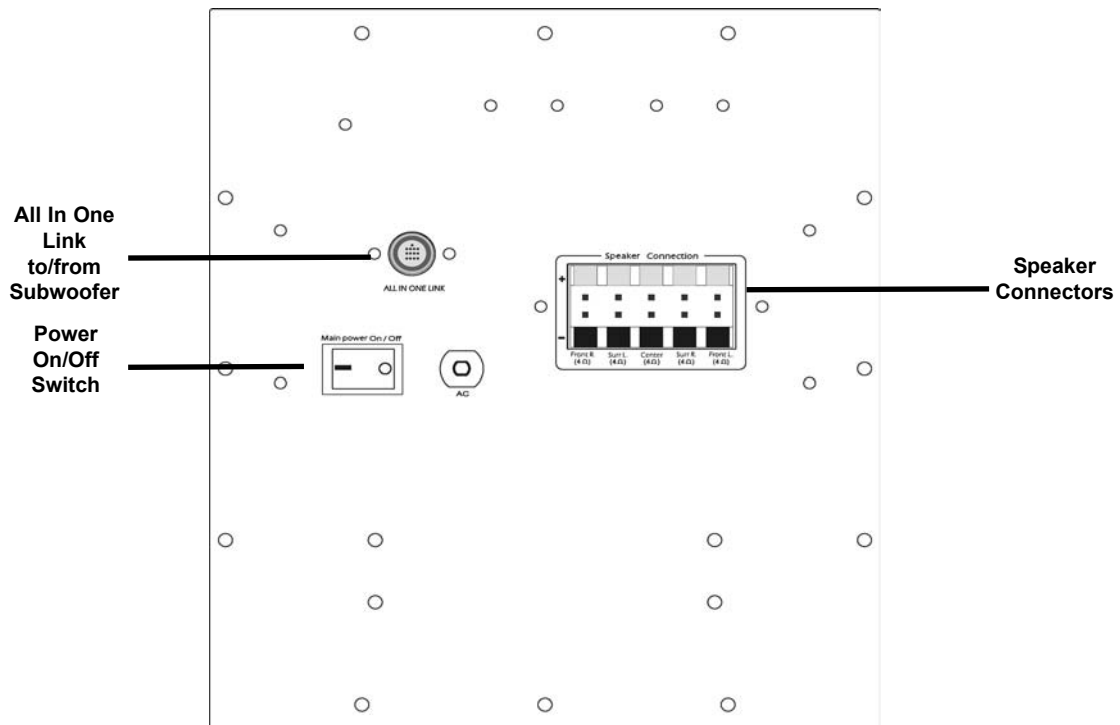

REMOTE CONTROL OVERVIEW

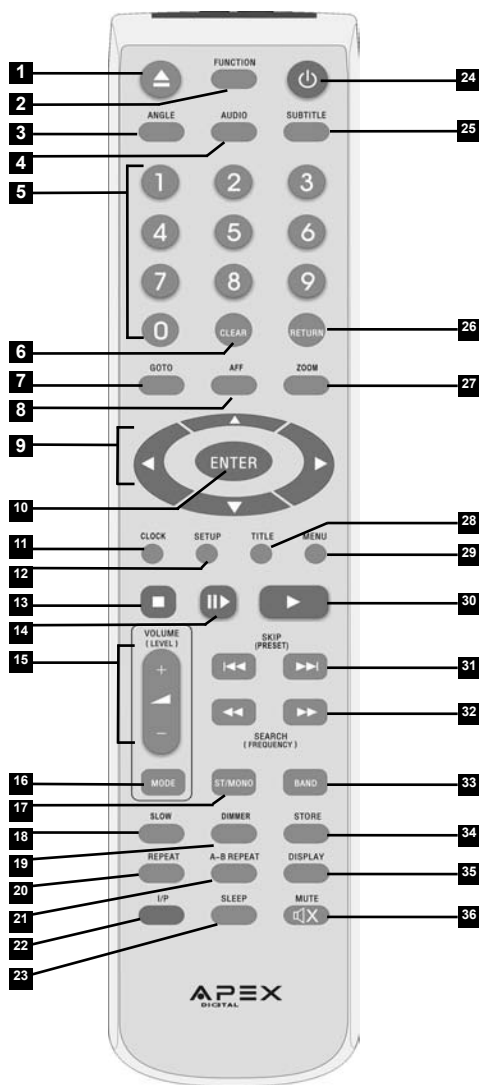

- 1 Open/Close
- 2 Function
- 3 Angle
- 4 Audio
- 5 Numeric Keys
- 6 Clear
- 7 Goto
- 8 AFF
- 9 Cursor Keys: Up / Down / Left / Right
- 10 Enter
- 11 Timer
- 12 Setup
- 13 Stop
- 14 Pause/Step
- 15 Volume Control +/-
- 16 Mode
- 17 Stereo/Mono
- 18 Slow
- 19 Dimmer
- 20 Repeat
- 21 A-B Repeat
- 22 I/P
- 23 Sleep
- 24 Power On/Off
- 25 Subtitle
- 26 Return
- 27 Zoom
- 28 Title
- 29 Menu
- 30 Play
- 31 Skip (Next Track/Previous Track)
- 32 Search (Fast Forward/Reverse)
- 33 Band
- 34 Store
- 35 Display
- 36 Mute

Important:

Certain features may not operate if the disc does not support the feature or requires a special setting.

Check the feature content printed on the disc's packaging.

Notes:

The remote control transmits a directional infrared beam. Be sure to aim the remote control directly at the infrared sensor during operation. When the sensor is covered or there is a large object between the remote control and the sensor will not receive a signal. The sensor may not be able to receive signals properly when it is exposed to direct sunlight or strong artificial light (such as a fluorescent or strobe light). In this case, change the direction of the light or reposition the unit to avoid direct lighting.

SUBWOOFER/SPEAKER SETUP

NOTE: Before making or changing any rear panel connections, make sure that all the components are switched off and unplugged from the power supply.

First Connect (see *diagram below*) the supplied "All in One Link" Cable to the HT-175 main unit and the Subwoofer, this cable transfers the pre-amp signals for all channels from the main unit to the powered subwoofer.

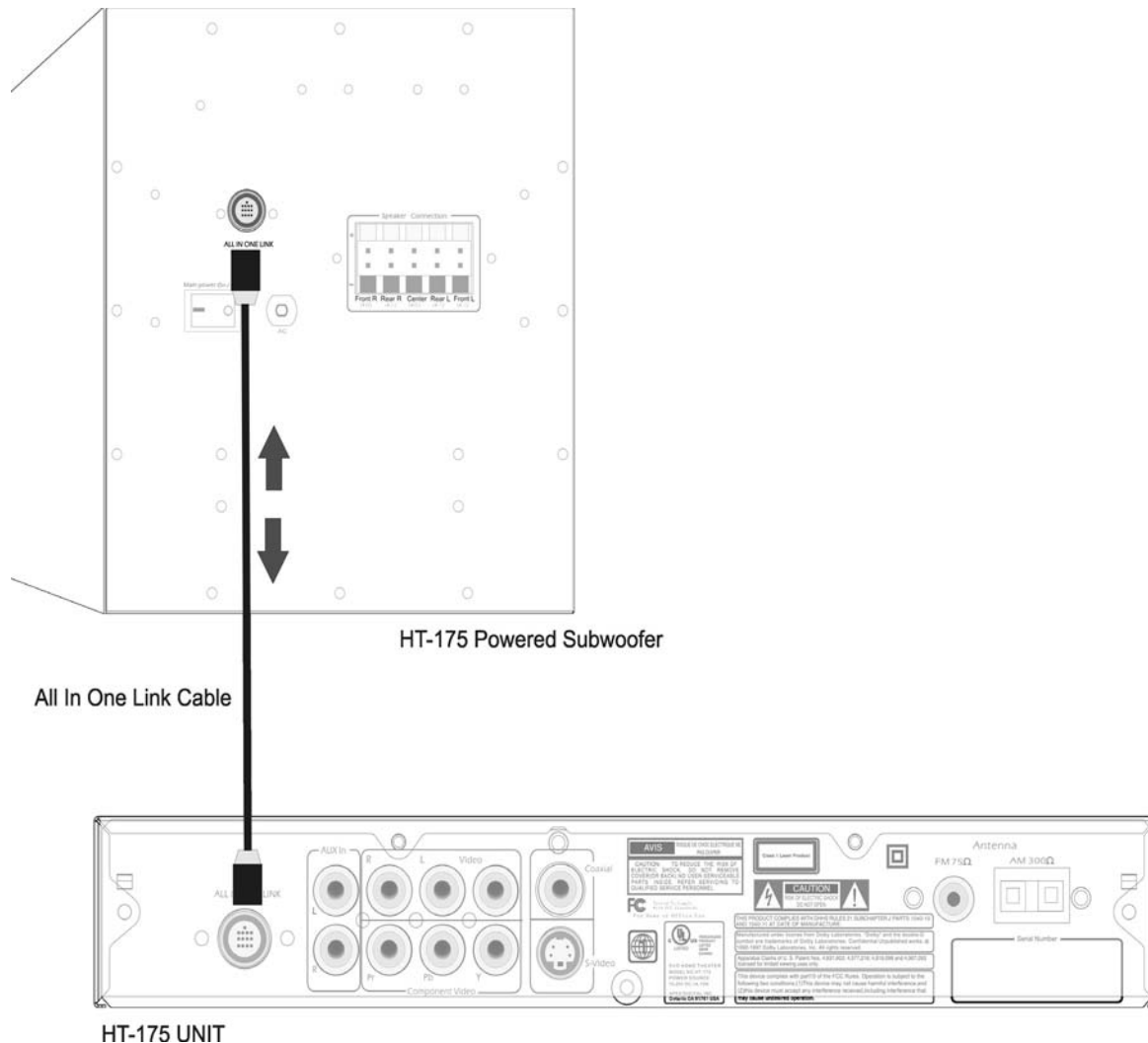

IMPORTANT: Do not connect any of the supplied speakers to any other amplifier. This may result in malfunction or fire. This system has been designed for best performance when connected to the supplied speakers. We do not, therefore, recommend that you connect and use other speakers with this system, doing so will void your warranty. The front and center speakers supplied with this system are magnetically shielded. However, placing them extremely close to a television may result in color distortion on the screen. If this happens, move the speakers a little further away and switch off the television for a couple of minutes. The rear speakers and subwoofer are not magnetically shielded, so they should not be placed near a TV or monitor.

SUBWOOFER/SPEAKER SETUP - CONTINUED

HT-175 SUBWOOFER/SATELLITE SPEAKER WIRING DIAGRAM

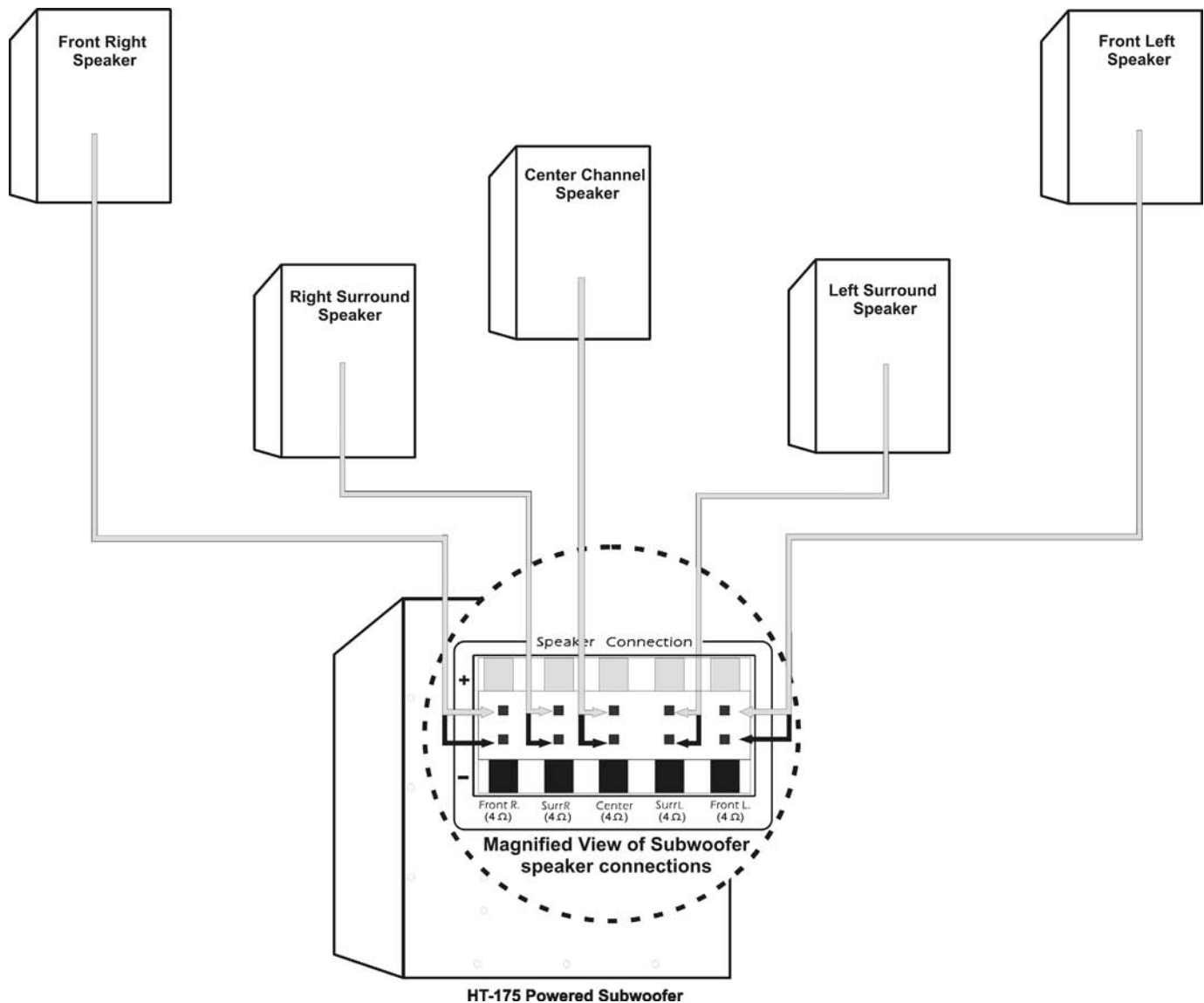

NOTE:

- Never short-circuit positive (+) and negative (-) speaker wires.
- Be sure to connect only positive (red) wires to positive (+) terminals and negative (black) wires to negative (-) terminals. Incorrect connection can damage the speakers.

SUBWOOFER/SPEAKER SETUP - CONTINUED

PLACEMENT OF HT-175 SPEAKERS IN YOUR ROOM

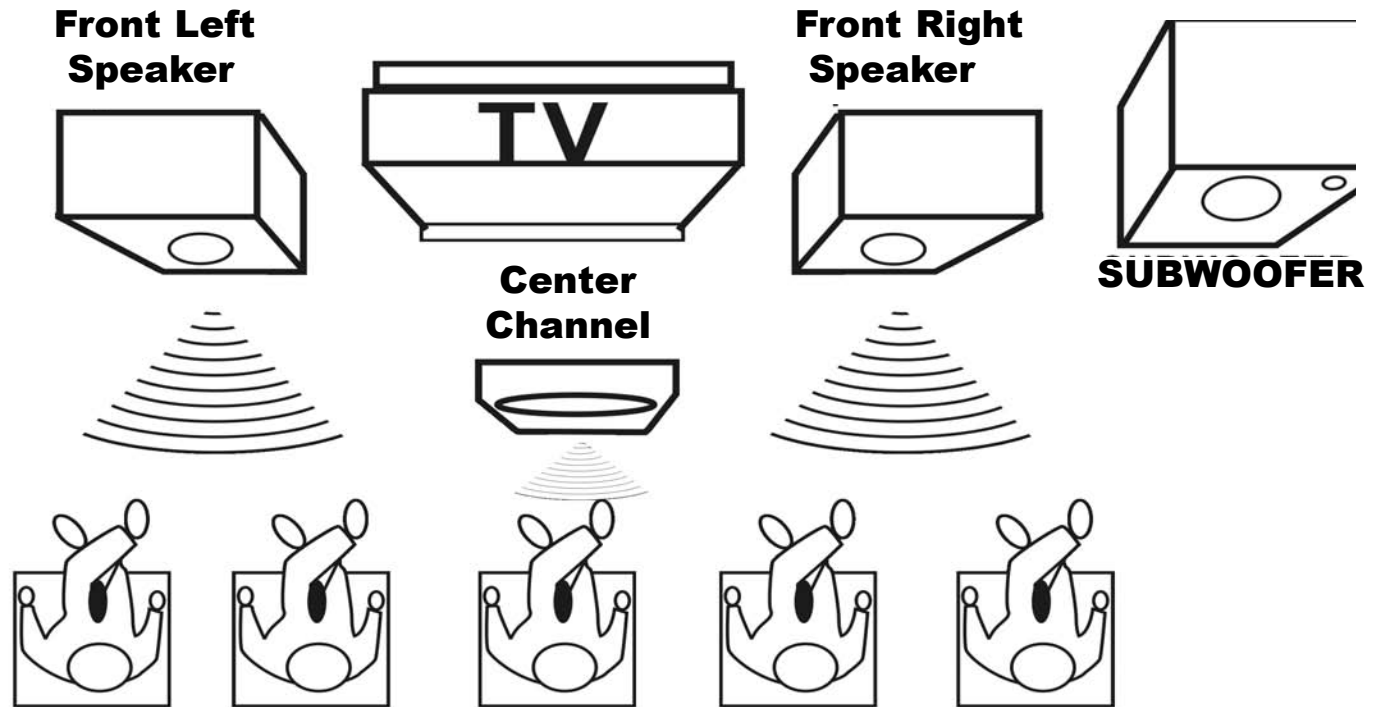

Surround Connection Example



Notes:

Place the front, center, and surround speakers at approximately the same distance from the seating position.

The angles in the diagram are approximate.

Center speaker: You can also put this speaker directly under the television. Vibration caused by the center speaker can disrupt the picture if it is placed directly on the television. Put the center speaker on a rack or shelf.

CONNECTING TO YOUR TV

GOOD

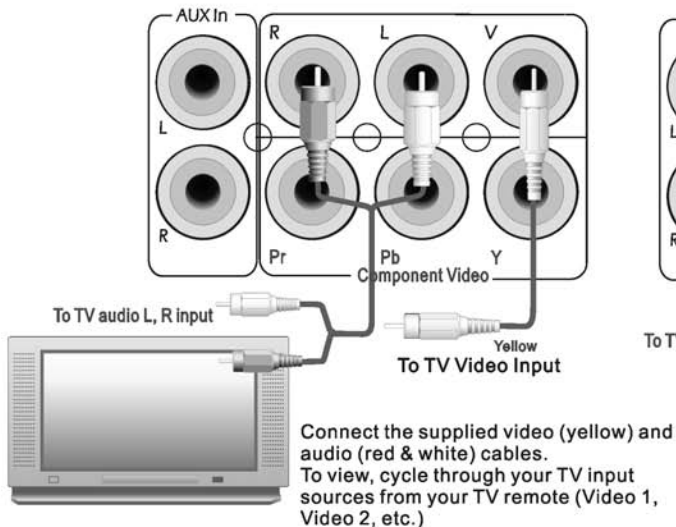

BETTER

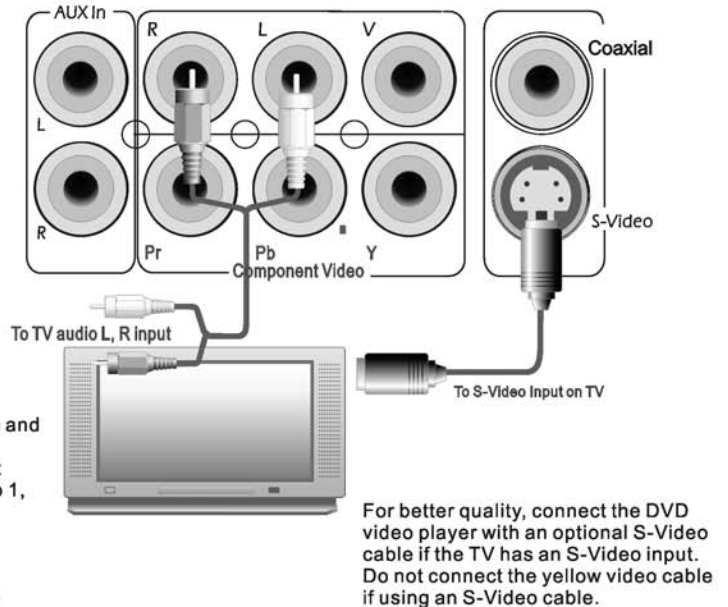

BEST

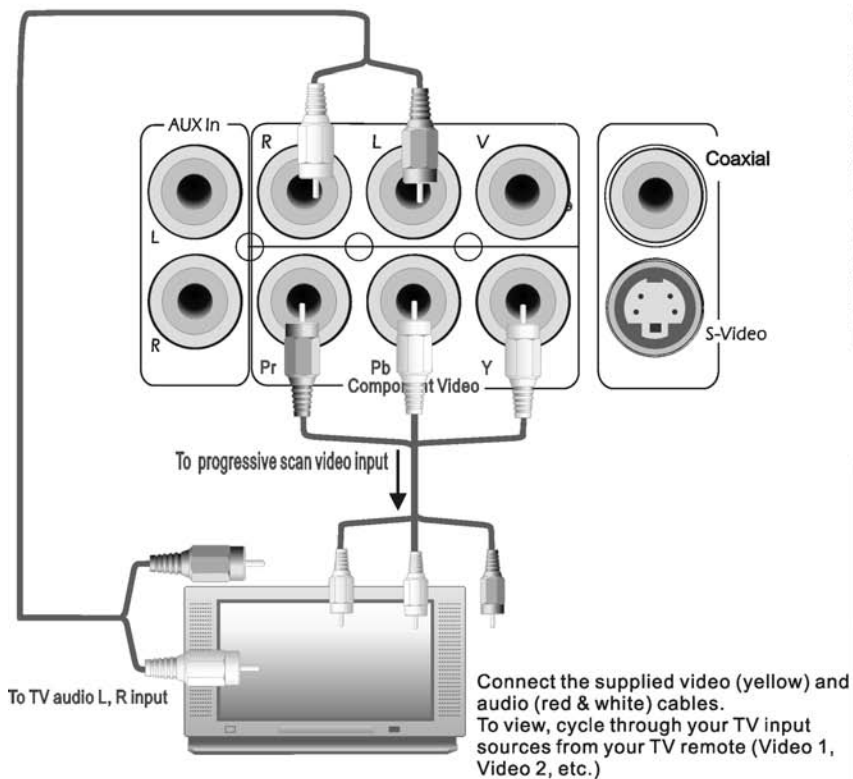

Do not connect the Component (Y Pb Pr) and S-Video connectors simultaneously.

COMPONENT VIDEO OUTPUT (Progressive Scan Output)

Component output terminals when connected to selected TVs and monitors will produce a higher quality picture playback. Depending on the selected TVs and monitors, the wording of the component input terminals may vary. If there are any fluctuations with the color play back, adjust the TV or monitor to achieve the Best video playback.

IMPORTANT:

Note: Use the Interlaced setting when using a standard TV. If you view a black and white distorted picture on your TV, press I/P. (Your installation may be interlaced and it may have been put into Progressive Scan mode by mistake).

Note: Your Apex DVD Player is equipped with Progressive Scan Output (Y Pb Pr/Component Video outputs) otherwise known as 480P (p=progressive) The 480P image offers the best quality picture and eliminates virtually all motion artifacts. This feature is designed for newer EDTV(Enhanced Definition TV) or HDTV sets only.

To Switch back and forth between Interlace and Progressive Video mode. Press I/P on your remote control to cycle between the two modes. Please refer to page 20 in this manual to learn more about this function.

AM/FM ANTENNA CONNECTION(S)

For the best reception, please install the provided am/fm antenna. Simple instructions and suggestions are provided to allow you to maximize your enjoyment of am/fm radio broadcasts.

AM ANTENNA:

Stand the antenna up on its base. Place the antenna where the reception is best. Keep any loose antenna cord away from other wires and cords.

FM ANTENNA:

Use adhesive tape to fix the other end of the antenna where reception is best. For FM, affix the antenna to a wall as high as possible for optimum reception.

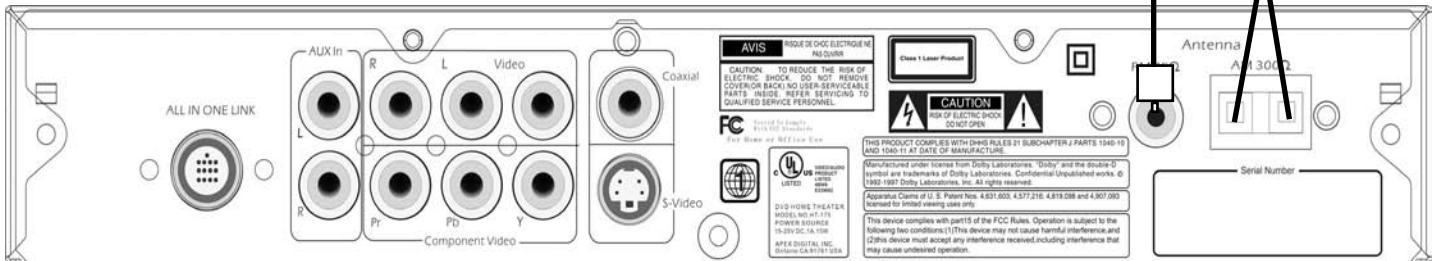
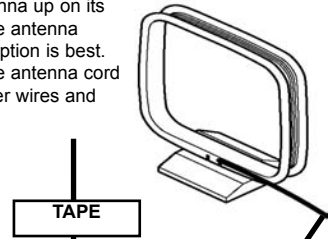

GETTING STARTED

- Unpack the unit and speakers- and save the box and packing for the duration of the warranty period in the event you may need to ship the unit to us.
- Read through this owner's manual before installation.
- Place the included speakers and subwoofer in your room (see page 11 of this manual for placement options).
- Load batteries into the remote control unit and verify batteries are installed correctly.
- Connect the player to your TV making sure the connections are secured.
- Connect the power plug to the AC power outlet.

NOTE:

Certain features contained in this DVD player are related to the DVD disc's software.

Check the features printed on the disc's packaging or follow the instructions of the Disc's on screen menu.

How to Play a Disc

Turn on the player.

Push the main power button to turn on the unit. Turn on the TV set, repeat press **FUNCTION** key on front panel or on remote control or press **OPEN** key on remote control to go into the DVD mode.

Select the appropriate video input on your TV (i.e. Video 1, 2, etc).

Load a disc in the disc tray.

Press **EJECT** button on the remote control (or front panel) to open the disc tray. Load a disc and press **EJECT** to close the disc tray.

(Note: Place the disc's label side up, blank side down)

When a DVD Disc Menu appears on screen use the cursor controls to select **PLAY**, press **ENTER** or **PLAY** and enjoy.



Press **CURSOR** buttons to select the desired feature in the menu, Then press the **ENTER** button to confirm a selection.

NOTE:

Normally when a MP3 disc is loaded, the unit will take a longer time to download the initial data.

A **DVD** disc that does not match the region code cannot be played by this player.

To return to the disc's Main Menu, press the **MENU** button on the remote.

Do not load a disc upside down. This DVD player will play Region 1 DVDs only.

GETTING STARTED (LISTENING TO AM/FM RADIO)

To listen in AM/FM mode, repeatedly press the **FUNCTION** key on the front of the unit or the remote control or press **BAND** key on the remote control to access the TUNER (TU) mode. The VFD (Visual Function Display) will display the tuner mode (TU) and you will view the Frequency Band and preset status. In FM mode, you may switch between stereo and mono reception by pressing the **ST/MONO** button on your remote control.

This unit features 30 radio station presets that are shared for both AM & FM.



HT-175 REMOTE CONTROL

AM/FM BAND SELECTION

To switch between the AM/FM band, press the **BAND** key on the remote control to toggle between AM and/or FM. Please note that the unit's VFD (Visual Function Display) will indicate the proper band and selected frequency (see example below).

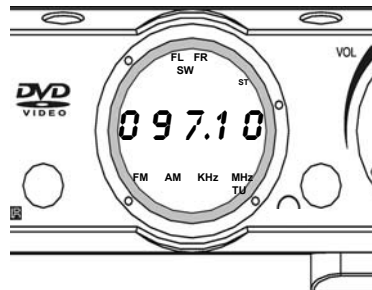

MANUAL TUNING:

To select a radio station manually, use the **SEARCH** (◀▶) keys on the remote control to select the desired station.

GOTO DIRECT TUNING:

To directly select the desired frequency, use numeric keypad to enter the desired frequency, (example: **97.1**) press 971 and press **ENTER** to confirm, this will directly access the frequency.

CHANNEL PRESET PROGRAMMING:

To program a desired station into the unit's memory simply tune to the desired frequency (using the above input numeric's method or using the (◀▶) buttons). Press the **STORE** key on the remote control. After doing this, enter the desired channel number (**0029**), then press **ENTER** to confirm. Once this is complete, your station will be programmed into the unit's memory.

MANUAL CHANNEL PRESET SELECTION:

To select a radio station preset manually, use the **SKIP/CHANNEL** (◀▶▶) keys to select the desired preset.

GOTO DIRECT CHANNEL PRESET TUNING:

To directly select the desired channel preset, press **GOTO** on the remote and input the desired channel number (example: **01**) on the remote's then press **ENTER** key to confirm your desired preset.

GETTING STARTED (ADJUSTING LEVEL VOLUME, BASS/TREBLE)

MODE



The **MODE** function is for adjusting the levels for the following:

Bass, Treble, FL (Front Left Speaker), FR (Front Right Speaker), SL (Surround Left) SR (Surround Right), C (Center), SW (Subwoofer)

These Levels can be adjusted + or - 10 (00 is the middle level)

When adjusting, use the volume +/- control to adjust the settings, press **MODE** to exit.

Below is an example of the VFD (Visual Function Display) setting of the FL (Front Left Speaker) at +07 level.

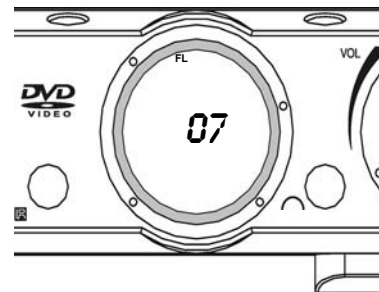

SETTING THE SYSTEM CLOCK



The **CLOCK** function allows you to adjust the time.

To adjust, simply press **CLOCK** on the remote control and **CL** will appear on the front VFD display. Then the digit will twinkle and enter the current time using the numeric keypad and press **ENTER** to confirm.

FUNCTION BUTTONS

Skip Forward/Backward

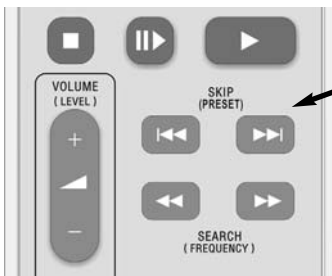

Press **▶▶** to skip forward (chapters/tracks).

Press **◀◀** to skip backward (chapters/tracks).

Player will not advance or reverse during "WARNING" section of any disc.

Search Forward/Backward

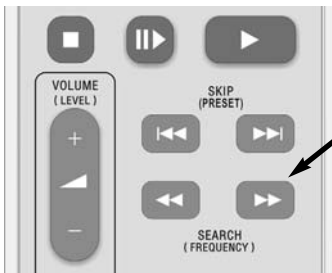

Press **▶▶** to search forward.

Repeat pressing the button to change search speed.

Press **◀◀** to search backward.

Repeat pressing the button to change search speed.

Player will not advance or reverse during "WARNING" section of any disc.

Press **PLAY** button to resume normal playback.

Slow

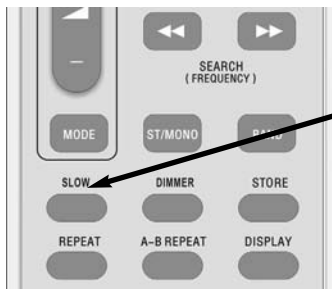

Press **SLOW** to play slow forward.
Repeat pressing the button to change slow forward speed. (Speeds are: 1/2, 1/4, 1/6, 1/7)

Press **PLAY** button to resume normal playback.

NOTE: The unit is muted during slow mode.

Dimmer

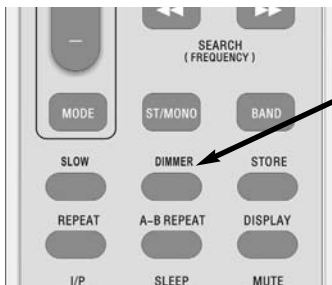

Press **DIMMER** on your remote to dim the lighting on the VFD (Visual Function Display) front panel.

FUNCTION BUTTONS - CONTINUED

GOTO a desired selection

This function does NOT apply to MP3 or WMA.



Press the **GOTO** button to play at a desired Title, Chapter or Time.

DVD Disc

Press the **GOTO** button to select GOTO mode.

Press the **DOWN** cursor button to highlight the desired function.

TITLE --- Input title number

CHAPTER --- Input chapter number

TIME --:--:-- Input time hh:mm:ss
(Hour : Minute : Second)

Press **ENTER** button.

CD Disc

Press the **GOTO** button to Track Search mode.

Press the **GOTO** button again to Disc Search mode.

TIME --:--:-- Input time hh:mm:ss
(Hour : Minute : Second)

TRACK --- Input track number XXX
(Track Number)

Press **ENTER** button.

NOTE:

Certain DVD discs may not allow GOTO functionality.

GOTO does NOT function during Program playback.

FUNCTION BUTTONS - CONTINUED

Numeric Key Pad / Direct Program access

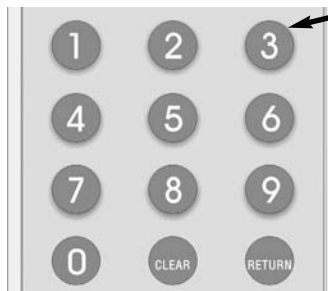

Press the numeric key pad to input data for disc or Setup menu.

Input the desired Chapter or Track number using the numeric key pad. Press **ENTER** button to confirm your direct access Chapter or key selection.

Track - when playing a CD or MP3 disc.

Numeric input - Function / Menu.

Chapter - when playing a DVD disc or for Direct Program access.

NOTE

Certain DVD discs may not allow direct access functionality.

Multi-Angle

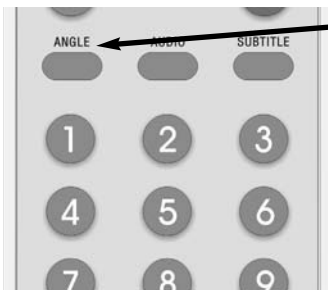

Certain DVD discs may contain scenes which have been shot simultaneously from a number of different angles. For these discs, the same scenes can be viewed from each of these different angles using the **ANGLE** button. (The recorded angles vary depending on the disc is encoded.)

If a DVD disc contains Multi-Angle feature, viewing angles may be selected:

During playback, press the **ANGLE** button repeatedly to select the desired viewing angle. Status will be displayed on screen.

A DVD disc may contain up to 9 selectable viewing angles.

Progressive Scan



The player is equipped with two types of video outputs:

- 1) Interlace video output (V, S-Video), and
- 2) Progressive Scan video output (Y Pb Pr)

For use with ED/HDTV to produce a "film-like" quality DVD presentation.

To switch between the two modes:

Press the Progressive Scan **I/P** button on the remote control.

Note: If you experience a picture that is distorted or in black and white, press the **I/P** button.

IMPORTANT

Note: Use the Interlaced setting when using a standard TV. If you view a black and white distorted picture on your TV, press I/P. (Your installation may be interlaced and it may have been put into Progressive Scan mode by mistake).

FUNCTION BUTTONS - CONTINUED

Zoom



In DVD mode (while playing a DVD)

Press the **ZOOM** button to enlarge the viewable picture.

Press the **ZOOM** button repeatedly to change the zoom scale: from 1-3 in varying degrees of magnification level.

Press the **CURSOR** buttons to adjust the zooming position. Press **ZOOM** to resume normal playback.

NOTE: The picture quality is degraded as the picture is zoomed.

DISPLAY



Press the **DISPLAY** button to view on screen status information about the current Disc being played:

ONSCREEN EXAMPLE:

Elapsed Remaining time(s):

DVD	00:00:00	00:00:00
Title 1/2	Chapter 4/12 Angle	
Audio	1/1	2 Ch ENG
Subtitle	Off	

MUTE



Press the **MUTE** button to instantly shut off the audio volume to all channels momentarily.

Press **MUTE** again to resume the previous level of volume.

FUNCTION BUTTONS - CONTINUED

SUBTITLE



Press the **SUBTITLE** key on the remote control to view subtitles that may be encoded on the DVD.

Note: not all DVD's have subtitles so refer to the DVD's packaging for details.

AUDIO

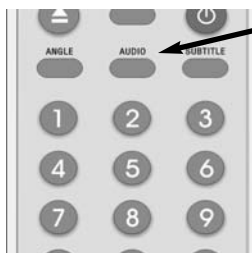

Press the **AUDIO** key on the remote control to change the various audio settings and encoded sound formats during DVD Playback.

SLEEP TIMER



Press the **SLEEP** key on the remote control to activate the unit's sleep timer. Continuously press the **SLEEP** key to select the desired sleep timer range 00-120 minutes. See below for an example of the VFD's display readout when selecting a sleep timer interval.

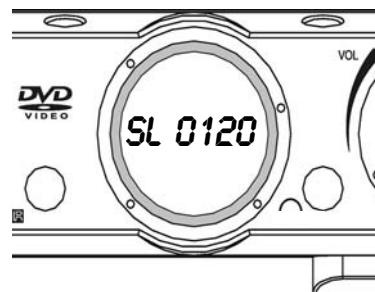

Sleep Timer interval screen on VFD

FUNCTION BUTTONS - CONTINUED

AFF (Active Full Screen Function)



AFF(Active Full Screen Function) allows you to fill the TV screen viewing area when playing a widescreen formatted DVD.

Press **AFF** button to eliminate(1.85:1 aspect ratio) black bars or to reduce the black bars on the top and bottom of the screen (2.35:1 aspect ratio).

Before AFF



After AFF



MP3/WMA Playback

MP3 Playback

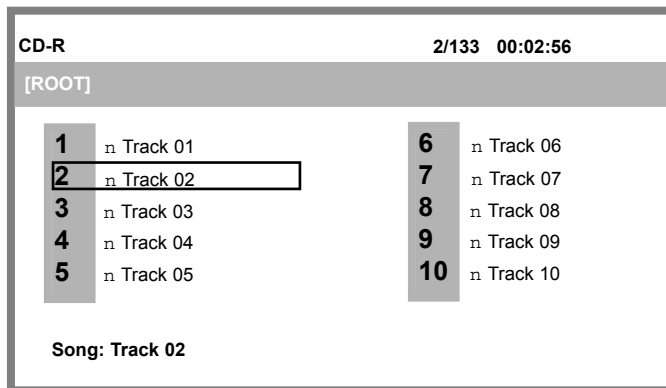

Example of MP3 On Screen Display

Select a Track

Press **CURSOR** button to highlight the desired track and switch between folder and pages.

Press **ENTER/PLAY** button to play the selected track.

Playing track file information:

Information on the track playing will be displayed at the top of the screen (i.e: artist, song, name, date, etc.) Note: Press **DISPLAY** on your remote to view the elapsed and remaining time of the track.

MP3 file format (limitations):

Sampling rate should be 44.1 kHz and bit rate is recommended within the range from 128 Kbps to 320 Kbps, in order to achieve the best performance.

WMA Playback

WMA refers to a new format of music files from Microsoft Windows Media Audio available from WMA web sites. The compression used allows you to record from your computer up to 22 hours of music on CD-ROM and play back through your DVD Player. APEX Digital was the first company to offer this feature in a home DVD player.

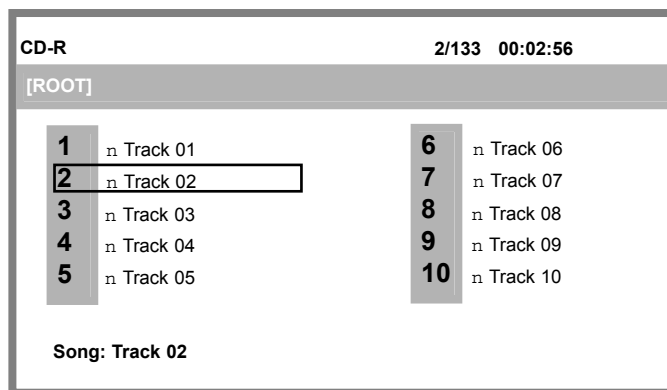

Example of WMA On Screen Display

KODAK/JPEG PHOTO PLAYBACK

Example of Kodak/Jpeg On Screen Display

A Kodak Picture CD is the size and shape of a regular CD. You can order a KODAK Picture CD simply by checking the box on the photo finishing envelope when you drop off a roll of film (35mm or Advanced Photo System (APS) color print film) at the time of processing in Kodak Express store displaying "Kodak Picture CD" sign. When your order is returned, you'll receive your prints, negatives, and your full roll of pictures safely stored on your KODAK Picture CD. Each KODAK Picture CD brings you the tools to enhance, share and manage your pictures on your computer.

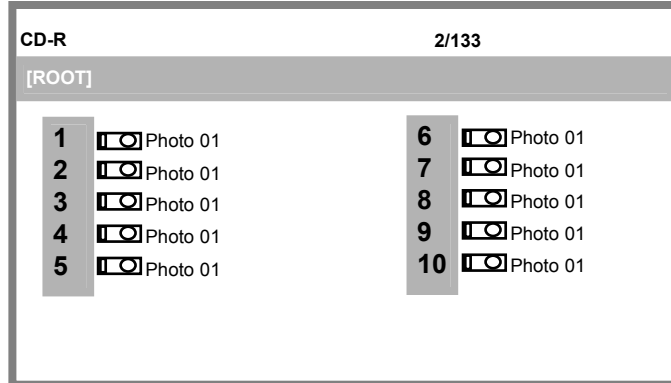

Playing back your Kodak Picture CD

This feature enables the decoding of JPEG files from a Kodak Picture CD disk.

About Kodak Picture CD

Now, you can playback Kodak Picture CDs on the DVD player and view your pictures on your TV in a slide show presentation.

When a Kodak Picture CD has been loaded in the player, an automatic slide show will be launched. Each picture in the Kodak Picture CD will be displayed consecutively in a slide-show fashion and will be scaled to fit the entire TV screen.

Press **PAUSE** button to display an image indefinitely.

Press **PLAY** button to resume the slide show.

Press the **STOP** button on your remote to display the index screen. Use the cursor (up,down,left,right) keys to navigate through your files. Press the **ENTER** key to display the selection.

Press **SKIP** (⏮⏭) buttons to view the next or previous picture.

Image rotation

Press **ANGLE** button to rotate a picture. These operations are allowed only when a picture is being displayed normally and will be cancelled automatically when a new picture is displayed. (You can select between 90,180 and 270 degrees of rotation) Simply press **ANGLE** again to resume normal viewing.

Zoom

Press **ZOOM** button to execute the zoom function and select your preference.

In zoom mode, Press the remote's cursor keys to move the picture. With zoom mode off, the next picture will be scaled to fit the TV screen automatically.

Press **PLAY** button to cancel the zoom and resume the slide show.

JPEG file format (limitations)

JPEG file of CMYK color mode is not supported. The range of pixels should not exceed 3840 pixels x 3840 pixels in order to achieve the best performance.

SETUP MENU OPTIONS

Various features of the player can be adjusted in the SETUP menu:

Press **SETUP** button

SETUP menu appears.

Note: These options can be accessed while the disc is playing in the unit:
(Language, Video, Audio, Rating).

Highlight the desired icon Press the **ENTER** button to activate the setting sub menu. Use the remote's **▲ ▼ ◀ ▶** keys to select the menu options, press **ENTER** to activate and confirm the desired option choices.

Language Setup Page

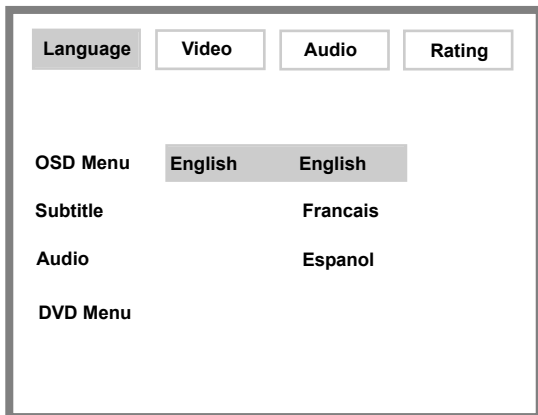

OSD MENU

Use your remote's **▲ ▼ ◀ ▶** keys to select the language on the OSD menu (default is English).

Once your selection is made, press **ENTER** on the remote to make/save your selection

Language Setup Page

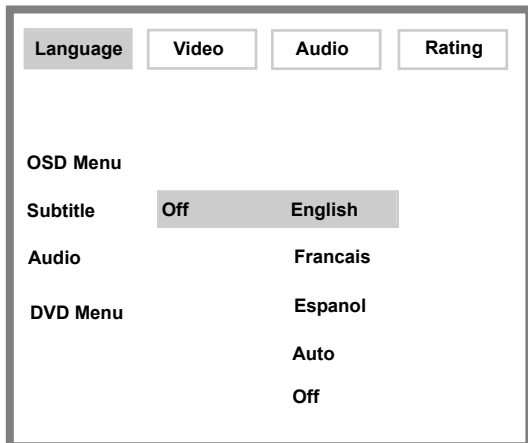

SUBTITLE MENU

Use your remote's **▲ ▼ ◀ ▶** keys to select the language on the SUBTITLE menu (default is English). This feature, when enabled, will allow the DVD subtitles to automatically play with the feature. Selecting OFF will disable this feature.

Once your selection is made, press **ENTER** on the remote to make/save your selection.

SETUP MENU OPTIONS-CONTINUED

Language Setup Page

Language	Video	Audio	Rating
OSD Menu			
Subtitle			
Audio	English	English	
DVD Menu		Francais	
		Espanol	

AUDIO MENU

Use your remote's **▲ ▼ ◀ ▶** keys to select the language options on the AUDIO menu (default is English). This feature, when enabled, will allow the DVD to automatically select the selected language.

Once your selection is made, press **ENTER** on the remote to make/save your selection.

Language Setup Page

Language	Video	Audio	Rating
OSD Menu			
Subtitle			
Audio			
DVD Menu	English	English	
		Francais	
		Espanol	

DVD MENU

Use your remote's **▲ ▼ ◀ ▶** keys to select the language options on the DVD menu (default is English). This feature, when enabled, will allow the DVD to automatically select the selected language.

Once your selection is made, press **ENTER** on the remote to make/save your selection.

Video Setup Page

Language	Video	Audio	Rating
TV Shape	4:3 LB	4:3 PS	
Video Output	Component	4:3 LB	
		16:9	

TV Shape

Use your remote's **▲ ▼ ◀ ▶** keys to select the TV Shape. Select between 4:3 LB (Letterbox), 4:3 PS (Pan & Scan/Fullscreen), 16:9 (ED/HDTV)

Once your selection is made, press **ENTER** on the remote to make/save your selection.

SETUP MENU OPTIONS-CONTINUED

Video Setup Page

Language	Video	Audio	Rating
TV Shape	4:3 LB		
Video Output	Component	S-Video	Component

Video Output

Use your remote's ▲ ▼ ◀ ▶ keys to select between Component(Pr Pb Y) and S-Video outputs (Default is S-Video).

Once your selection is made, press **ENTER** on the remote to make/save your selection.

Audio Setup Page

Language	Video	Audio	Rating
Digital Out	Raw	PCM	
Test Tone	Off	Raw	
DRC	On		
Cent Delay	0ms		
Rear Delay	0ms		

Digital Out

Use your remote's ▲ ▼ ◀ ▶ keys to select between Raw/PCM Select **Spdif/Raw** for equipment that has a Dolby Digital/DTS processor built in. The player will "stream" these and other digital audio formats via this mode.

Selecting **Spdif/PCM** optimizes the output for playing CD Audio or MP3/WMA tracks.

Once your selection is made, press **ENTER** on the remote to make/save your selection.

Audio Setup Page

Language	Video	Audio	Rating
Digital Out	Raw	Off	
Test Tone	Off	Left	
DRC	On	Center	
Cent Delay	0ms	Right	
Rear Delay	0ms	Left Rear	
		Right Rear	

Test Tone

Use your remote's ▲ ▼ ◀ ▶ keys to adjust output levels for all channels individually.

To disable the test, select Off on the menu and press **ENTER** on the remote to make/save your selection.

SETUP MENU OPTIONS-CONTINUED

Audio Setup Page

Language	Video	Audio	Rating
Digital Out	Raw		
Test Tone	Off		
DRC	On	Off	
Cent Delay	0ms	On	
Rear Delay	0ms		

DRC (Dynamic Range Compression)

Use your remote's ▲ ▼ ◀ ▶ keys to activate DRC.

When playing a DVD with a Dolby Digital encoded soundtrack, this mode compresses the dynamic range of the soundtrack. Example: If you're watching an action movie at night, and you've set the DRC setting to "On", the volume is slightly compressed. If the mode is set to "Off" the full dynamic range of the soundtrack will be reproduced.

Audio Setup Page

Language	Video	Audio	Rating
Digital Out	Raw	5ms 4ms	
Test Tone	Off	3ms 2ms	
DRC	On	1ms	
Cent Delay	0ms	0ms	
Rear Delay	0ms		

Center Delay

Use your remote's ▲ ▼ ◀ ▶ keys to activate the adjustment of Center Delay. This setting is to be used for Dolby Digital.

Adjustment settings:

Center Delay: 0ms to 5ms

Audio Setup Page

Language	Video	Audio	Rating
Digital Out	Raw	15ms 12ms	
Test Tone	Off	9ms 6ms	
DRC	On	3ms	
Cent Delay	0ms		
Rear Delay	0ms	0ms	

Rear Delay

Use your remote's ▲ ▼ ◀ ▶ keys to activate the adjustment of Rear Delay. This setting is to be used for Dolby Digital.

Adjustment settings:

Rear Delay: 0ms to 15ms

SETUP MENU OPTIONS-CONTINUED

Rating

Language	Video	Audio	Rating
Password	----		
Rating	8. Adult		
Load Factory	Reset		

Password

Use your remote's ▲ ▼ ◀ ▶ keys to access these settings.

This function controls allows parents to set the player to allow only the selected rating and below the rating to play on the unit. (Note: only certain DVD software encoded in this manner will work with this function.)

Default password is: 3308

Default Rating is: Adult

Here are the various ratings to select from:
(These can be changed from the Rating screen)

1. Kid Safe
2. G
3. PG
4. PG_13
5. PG_R
6. R
7. NC_17
8. Adult

To Change the Password:

Highlight "Password" selection, input the 4 digits password. Press **ENTER** button. The rating lock release. Input the 4 digits new password, the password will be changed and the rating lock will lock up after pressed **ENTER** button.

TROUBLESHOOTING

Before requesting service, check the chart below for a possible cause of the problem you are experiencing. Some simple troubleshooting or a minor adjustment on your part may eliminate the problem and restore proper operation.

We encourage you to visit our website at www.apexdigitalinc.com and review the Customer Support and FAQ's page for updates to this list. You may register to activate your warranty at our website.

SYMPTOM (COMMON)	REMEDY
The player does not start playback when PLAY is pressed.	<ul style="list-style-type: none"> · Condensation has formed: wait about 1 to 2 hours to allow the player to dry out. · This player cannot play discs other than DVDs and audio CDs. · Check if the disc is defective by trying another disc. · Check the region (local) code. · Disc may have been placed in the tray upside down.
The player starts playback but stops immediately.	<ul style="list-style-type: none"> · The disc may be dirty and may require cleaning. · Ensure that the disc is installed with the label side up.
No picture.	<ul style="list-style-type: none"> · Ensure that the equipment is connected properly. · Ensure that the input setting for the TV is "Video". · Check if external equipment is on. · Select the same channel and source on the TV as on the player. · Check if the TV is on.
No sound.	<ul style="list-style-type: none"> · Ensure that the equipment is connected properly and firmly into jacks. · Check the Audio Output Setting menu to make sure that Analog Output is selected. · Check the Volume Adjustment.
Distorted sound.	<ul style="list-style-type: none"> · Ensure that the input settings for the TV and stereo system are proper. · No sound is heard during still picture (pause).
No audio at Digital Output.	<ul style="list-style-type: none"> · Check the digital connections. · Check if the audio format of the selected audio language matches your receiver capabilities.
Distorted picture.	<ul style="list-style-type: none"> · Check the disc for fingerprints and clean it with a soft cloth, wiping it from center to edge. · Sometimes a small amount of picture distortion may appear. This is not a malfunction
Picture is distorted during rapid advance or rapid reverse.	<ul style="list-style-type: none"> · This is normal occurrence.
No rapid advance (or rapid reverse) playback.	<ul style="list-style-type: none"> · Some discs may have sections which prohibit rapid advance (or rapid reverse).
No 4:3 (16:9) picture.	<ul style="list-style-type: none"> · Choose the correct setup "TV DISPLAY" item which matches the TV set used.
Picture is distorted during rapid advance or rapid reverse.	<ul style="list-style-type: none"> · The picture will be somewhat distorted at times: this is normal.
No operations perform with the remote control.	<ul style="list-style-type: none"> · Check the batteries are installed with the correct polarity (+ and -). · The batteries are depleted: replace them with new ones. · Point the remote control unit at the remote control signal sensor and operate. · Operate the remote control unit at a distance but no more than 6 meters from the remote control signal sensor. · Remove the obstacles between the remote control unit and remote control signal
No key operation (by the DVD player remote control) is effective.	<ul style="list-style-type: none"> · Turn the unit off and then back to on. Alternatively, turn off the unit, disconnect the AC power and/or the cord and then re-connect it. (The player may not be operating properly due to lightning, static electricity or some other external factor.)
PLAY does not start playback even when title is selected.	<ul style="list-style-type: none"> · This may be a result of the parental lock function that has been set. Confirm the "PARENTAL" setup.
Audio soundtrack and/or subtitle language is not the one selected at the initial settings.	<ul style="list-style-type: none"> · If the audio soundtrack and/or subtitle language does not exist on the disc, the language selected at the initial settings will not be seen/heard.
No subtitles.	<ul style="list-style-type: none"> · Subtitles appear only with discs that contain them. · Subtitles are hidden from the TV screen. Press SUBTITLE to display the subtitles.
Alternative audio soundtrack (or subtitle) languages cannot be selected.	<ul style="list-style-type: none"> · An alternative language can not be selected may result of no more than one language is available.
Angle cannot change.	<ul style="list-style-type: none"> · This function depends on software availability. Even if a disc has a number of angles encoded on it, these angles may be recorded for specific scenes only.
I forgot my password for parental control.	<ul style="list-style-type: none"> · Enter overriding password: 3308

SPECIFICATIONS

HT-175

Power supply	120V~ 60Hz
Power consumption	100W
Mass	6.0 kg
External dimensions	28 x 32 x 4.5 (Inches / W/H/D)
TV Signal system	NTSC/PAL
Laser	Semiconductor laser, wavelength 650 nm

SUPPLIED ACCESSORIES

Video cable (yellow)	1
Audio cable (red and white)	1
Remote control (HRM-170)	1
Batteries (AAA)	2
All in one control cable	1
Owner's manual	1
AM loop antenna	1
FM wire antenna	1
Speakers	5
Subwoofer	1
Speaker cords (pairs)	5

FM TUNER SECTION

System	PLL quartz-locked digital synthesizer system
Tuning range	87.5-107.9 MHz (100 kHz step)
Antenna	FM wire antenna
Antenna terminals	75 ohms, unbalanced
Intermediate frequency	10.7 MHz

AM TUNER SECTION

System	PLL quartz-locked digital synthesizer system
Tuning range	530-1620 kHz (10 kHz interval)
Antenna	Loop antenna

VIDEO SECTION

Outputs	Video: 1.0 V (p-p), 75 ohms
	S-Video: Y: 1.0 V (p-p), 75 ohms
	C: PAL 0.3 V (p-p), 75 ohms
	NTSC 0.286 V (p-p), 75 ohms
	Component Video: (Y) 1.0 V (p-p), 75 ohms
	(Pb) 0.7 V (p-p), 75 ohms
	(Pr) 0.7 V (p-p), 75 ohms

SPEAKERS

Rated impedance	8 ohms
Dimensions (approx.)	9 x 10 x 12 (Inches / W/H/D)

SUBWOOFER

Rated impedance	4 ohms
Dimensions (approx.)	22 x 32 x 25 (Inches / W/H/D)

WARRANTY

Home Theater Systems 90 DAYS LABOR/ONE YEAR REPLACEMENT OF PARTS

WHO IS COVERED?

Proof of purchase is required to receive warranty service such as the original sales receipt showing original date of purchase from an authorized APEX Digital, Inc. dealer in N. America. Keep your original box and packaging in case your unit needs to be shipped to us. You will need to prepay shipping and APEX will pay the cost of shipping the unit back to you. You are required to email or call Customer Support for proper instructions to ship unit for repair. A return authorization number is required prior to acceptance by Apex. Register your product online at www.apexdigitalinc.com.

WHAT IS COVERED

Warranty repair from the original date of purchase: One (1) year replacement of parts; 90 day limited labor warranty coverage. ***If you don't have proof of purchase, your unit will be considered out-of-warranty & will be charged at a flat labor rate.***

WHAT IS EXCLUDED?

Your warranty does not cover:

- Labor charges for installation or setup of the product, adjustment of customer controls on the product, and installation or repair of antenna systems outside of the product.
- Product repair and/or part replacement because of misuse, accident, unauthorized repair or other cause not within the control of Apex Digital, Inc.
- A product that requires modification or adaptation to enable it to operate in any country other than the country for which it was designed, manufactured, approved and/or authorized, or repair of products damaged by these modifications.
- Incidental or consequential damages resulting from the product. (Some states do not allow the incidental or consequential damages, so the above exclusion may not apply to you. This includes, but is not limited to, prerecorded material, whether copyrighted or not.)
- Shipment and service to a NON-AUTHORIZED repair facility.

BEFORE REQUESTING SERVICE:

In the event after following all of the operating instructions including the **Troubleshooting Guide** and reviewing updated FAQ's on the Customer Support & FAQ page of our website, www.apexdigitalinc.com, should you find that service is still necessary, email or call Customer Support for an Return Authorization number.

ORDERING ACCESSORIES:

You may purchase accessories for all Apex Digital products by visiting www.apexdigitalinc.com under Accessory Store or email/call for the pricing and availability of your request.

WHERE IS SERVICE AVAILABLE?

If you previously registered your product(s) online at www.apexdigitalinc.com go to MY ACCOUNT and email your request. Otherwise, go to PRODUCT REGISTRATION, enter your information and submit to set up your account. Then email your request. You may also call us at (866) 427-3946 Monday-Sunday 7am-6pm (California).

This warranty gives you specific legal rights. You may have other rights which vary from state/province to state/province.

Free Manuals Download Website

<http://myh66.com>

<http://usermanuals.us>

<http://www.somanuals.com>

<http://www.4manuals.cc>

<http://www.manual-lib.com>

<http://www.404manual.com>

<http://www.luxmanual.com>

<http://aubethermostatmanual.com>

Golf course search by state

<http://golfingnear.com>

Email search by domain

<http://emailbydomain.com>

Auto manuals search

<http://auto.somanuals.com>

TV manuals search

<http://tv.somanuals.com>