

# Asanté FriendlyNET FS4008P 8-port Dual-speed Fast Ethernet Switch User's Guide

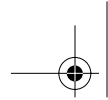
## Product Introduction

Congratulations on your purchase of the Asanté FriendlyNET FS4008P. These switches were designed to give you the ultimate in performance, flexibility, ease-of-use, and reliability.

Your Asanté FriendlyNET FS4008P can increase performance on your network by bringing full Ethernet bandwidth to individual workgroups, or straight to the desktop, instead of requiring all stations to share the bandwidth of a single network. The switch's 100Mbps Fast Ethernet capability can eliminate bottlenecks in connections to servers, or can link 10Mbps workgroups to a 100Mbps Fast Ethernet network backbone.

For straight-through 10Base-T/100Base-TX connection to servers and workstations, the switch supports full-duplex connection, effectively doubling the total throughput on individual links. The switch's store-and-forward switching architecture forwards packets to their destination with a minimum of delay.

The switches can be placed on a tabletop or wall-mounted, and provide the ideal solution for your small, medium, or large Ethernet/Fast Ethernet network. It is designed to comply fully with the IEEE 802.3 Ethernet and 802.3u Fast Ethernet standards.



## Asanté FriendlyNET FS4008P Installation Guide



### Package Contents

Your switch package should contain the following:

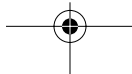
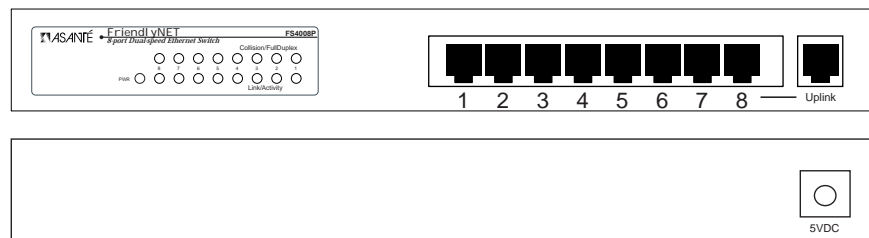
- The user manual
- One 10/100Mbps switch
- One AC power cable
- Four self-adhesive standoffs

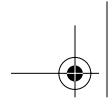
*If any of these items are missing, contact your dealer immediately*

### Installation

The Asanté FriendlyNET FS4008P switch is easy to install and requires no special training. You should, however, read the following instructions carefully before proceeding to install your switch. The diagram below shows the layout of the front and rear panels.

#### Front & Rear Panel of the Asanté FriendlyNET FS4008P





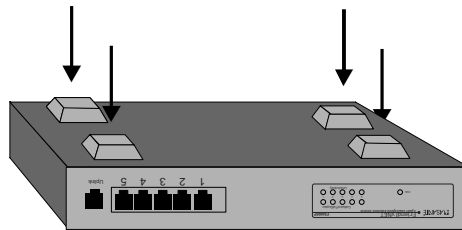
## Asanté FriendlyNET FS4008P Installation Guide

The Asanté FriendlyNET FS4008P is designed for easy “plug and play” installation. Before you connect your switch to other devices, there are several issues you should keep in mind:

- △ When connecting the switch to a workstation using unshielded twisted pair cable, you must make sure that the cable length is not greater than 100 meters. 10Base-T twisted pair Ethernet cabling should be category 3 or better, and 100Base-TX twisted pair Fast Ethernet cabling should use tested category 5 cabling.
- △ Network cable segments can be connected to, or disconnected from the switch while the power is on. Plugging in or removing network cables while your switch is operating will not interrupt the operation of the switch.
- △ When placing your switch, you need to avoid dusty locations and electromagnetically noisy areas.

### Desktop Placement

You can place the switch on a table. In this case, use the four self-adhesive feet, which are provided with the Asanté FriendlyNET FS4008P for cushioning purposes. Stick them on the four corners of the bottom surface of the switch, as shown in diagram below to cushion it against vibration.





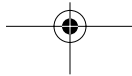
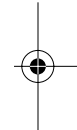
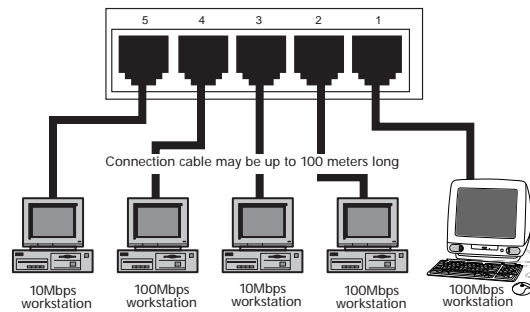
## Asanté FriendlyNET FS4008P Installation Guide



### Connecting to Servers and Workstations

**Use the following procedure to connect a 10Base-T or 100Base-TX Ethernet server or workstation to the switch.**

1. Make sure that the length of the straight-through cable between the switch and the station does not exceed 100 meters, including all patch cables and cross-connect wires.
2. Connect one end of the cable to the RJ-45 connector on the switch, and the other end to the station.



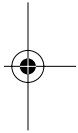
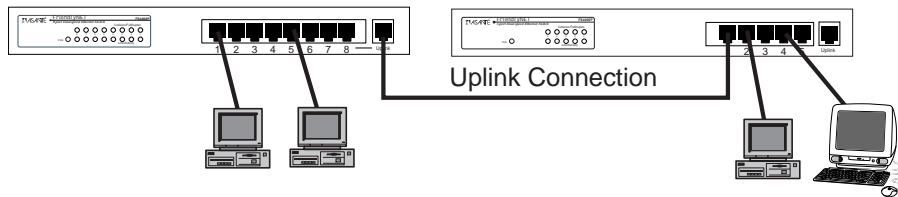


## Asanté FriendlyNET FS4008P Installation Guide

### Interconnecting to switches

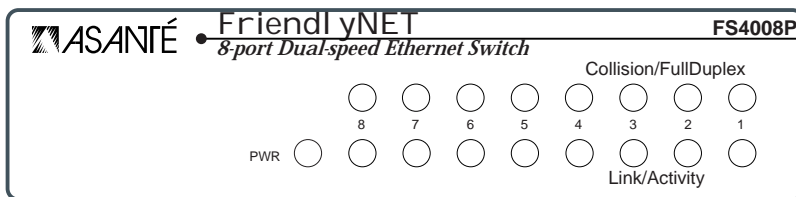
To connect a switch or hub, note the following:

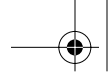
1. Use a straight-through cable to connect uplink port or use a crossover cable to connect to any port except uplink port. (Do not connect both uplink ports together, and do not use a crossover cable to connect with the uplink port).



### LED Indicators

#### Front Panel LED Indicators



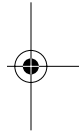
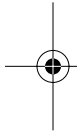


Asanté FriendlyNET FS4008P Installation Guide



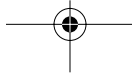
**Table 1: Power LED**

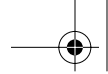
Color	Status
Green	The switch is powered on and ready for use
OFF	The switch is powered off or the LED has failure. Please check the following issues: <ul style="list-style-type: none"><li>• Make sure the power adapter is properly inserted into the power connection on the switch.</li><li>• Determine whether or not the power adapter is functional by plugging another device into the receptacle</li></ul>



**Table 2: 100M Link/Activity**

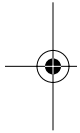
Color	Status
Green	The port is connected to a link partner and the result of auto-negotiation is 100Mbps with full duplex
Flashing green	The port is operating in full duplex and there is a data being received.



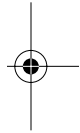


**Table 2: 100M Link/Activity**

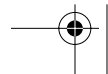
Amber	The port is connected to a link partner and the result of the auto-negotiation is 100Mbps with half-duplex
Flashing amber	The port is operating in half duplex and there is data being received.
OFF	No 100Mbps IDLE symbol signal is being received.

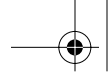


**Table 3: 10M Link/Activity**



Color	Status
Green	The port is connected to a link partner and the result of auto-negotiation is 10Mbps with full duplex
Flashing green	The port is operating in Full duplex and there is a data being received.
Amber	The port is connected to a link partner and the result of the auto negotiation is 10Mbps with half-duplex



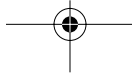
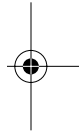


Asanté FriendlyNET FS4008P Installation Guide

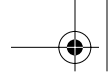


**Table 3: 10M Link/Activity**

Flashing amber	The port is operating in half duplex and there is data being received.
OFF	No 10Mbps link pulse signal is being received.







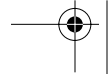
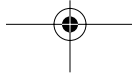
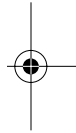
## Contacting Technical Support

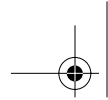
To contact Asanté Technical Support:

Telephone	(800) 622-7464
Fax	(801) 566-3787
E-mail	support@asante.com
World Wide Web Site	<a href="http://www.asante.com">http://www.asante.com</a>

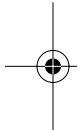
### Technical Support Hours

6:00 a.m. to 5:00 p.m. Pacific Standard Time USA, Monday - Friday.





Asanté FriendlyNET FS4008P Installation Guide



ASANTÉ TECHNOLOGIES, INC., 821 FOX LANE, SAN JOSE, CA 95131

PHONE: 800.622.7464 • FAX: 801.566.3787 • e-mail address: sales@asante.com •  
World Wide Web site: <http://www.asante.com>

©1999 Asanté Technologies Inc. Asanté is a trademark of Asanté Technologies, Inc.  
All brand names and products are trademarks or registered trademarks of their respective holders.

March 1999 Rev A.



Page 10



## Free Manuals Download Website

<http://myh66.com>

<http://usermanuals.us>

<http://www.somanuals.com>

<http://www.4manuals.cc>

<http://www.manual-lib.com>

<http://www.404manual.com>

<http://www.luxmanual.com>

<http://aubethermostatmanual.com>

Golf course search by state

<http://golfingnear.com>

Email search by domain

<http://emailbydomain.com>

Auto manuals search

<http://auto.somanuals.com>

TV manuals search

<http://tv.somanuals.com>