



M2N32 WS Professional

Motherboard

E2560

First Edition V1

May 2006

Copyright © 2006 ASUSTeK COMPUTER INC. All Rights Reserved.

No part of this manual, including the products and software described in it, may be reproduced, transmitted, transcribed, stored in a retrieval system, or translated into any language in any form or by any means, except documentation kept by the purchaser for backup purposes, without the express written permission of ASUSTeK COMPUTER INC. ("ASUS").

Product warranty or service will not be extended if: (1) the product is repaired, modified or altered, unless such repair, modification or alteration is authorized in writing by ASUS; or (2) the serial number of the product is defaced or missing.

ASUS PROVIDES THIS MANUAL "AS IS" WITHOUT WARRANTY OF ANY KIND, EITHER EXPRESS OR IMPLIED, INCLUDING BUT NOT LIMITED TO THE IMPLIED WARRANTIES OR CONDITIONS OF MERCHANTABILITY OR FITNESS FOR A PARTICULAR PURPOSE. IN NO EVENT SHALL ASUS, ITS DIRECTORS, OFFICERS, EMPLOYEES OR AGENTS BE LIABLE FOR ANY INDIRECT, SPECIAL, INCIDENTAL, OR CONSEQUENTIAL DAMAGES (INCLUDING DAMAGES FOR LOSS OF PROFITS, LOSS OF BUSINESS, LOSS OF USE OR DATA, INTERRUPTION OF BUSINESS AND THE LIKE), EVEN IF ASUS HAS BEEN ADVISED OF THE POSSIBILITY OF SUCH DAMAGES ARISING FROM ANY DEFECT OR ERROR IN THIS MANUAL OR PRODUCT.

SPECIFICATIONS AND INFORMATION CONTAINED IN THIS MANUAL ARE FURNISHED FOR INFORMATIONAL USE ONLY, AND ARE SUBJECT TO CHANGE AT ANY TIME WITHOUT NOTICE, AND SHOULD NOT BE CONSTRUED AS A COMMITMENT BY ASUS. ASUS ASSUMES NO RESPONSIBILITY OR LIABILITY FOR ANY ERRORS OR INACCURACIES THAT MAY APPEAR IN THIS MANUAL, INCLUDING THE PRODUCTS AND SOFTWARE DESCRIBED IN IT.

Products and corporate names appearing in this manual may or may not be registered trademarks or copyrights of their respective companies, and are used only for identification or explanation and to the owners' benefit, without intent to infringe.

Contents

Notices.....	vii
Safety information	viii
About this guide	ix
M2N32 WS Professional specifications summary.....	xi

Chapter 1: Product introduction

1.1 Welcome!.....	1-1
1.2 Package contents.....	1-1
1.3 Special features.....	1-2
1.3.1 Product highlights	1-2
1.3.2 ASUS Special features	1-5

Chapter 2: Hardware information

2.1 Before you proceed	2-1
2.2 Motherboard overview.....	2-2
2.2.1 Placement direction	2-2
2.2.2 Screw holes	2-2
2.2.3 ASUS Stack Cool 2.....	2-3
2.2.5 Motherboard layout.....	2-4
2.2.4 Layout contents.....	2-5
2.3 Central Processing Unit (CPU)	2-7
2.3.1 Installing the CPU	2-7
2.3.2 Installing the heatsink and fan	2-9
2.4 System memory	2-12
2.4.1 Overview	2-12
2.4.2 Memory configurations.....	2-13
2.4.3 Installing a DIMM	2-15
2.4.4 Removing a DIMM	2-15
2.5 Expansion slots.....	2-16
2.5.1 Installing an expansion card	2-16
2.5.2 Configuring an expansion card	2-16
2.5.3 Interrupt assignments	2-17
2.5.4 PCI slot	2-18
2.5.5 PCI-X slots	2-18
2.5.6 PCI Express x1 slots.....	2-18
2.5.7 Two PCI Express x16 slots	2-18

Contents

2.6	Jumper	2-25
2.7	Connectors	2-27
2.7.1	Rear panel connectors	2-27
2.7.2	Internal connectors	2-29
Chapter 3: Powering up		
3.1	Starting up for the first time	3-1
3.2	Powering off the computer	3-2
3.2.1	Using the OS shut down function.....	3-2
3.2.2	Using the dual function power switch.....	3-2
Chapter 4: BIOS setup		
4.1	Managing and updating your BIOS	4-1
4.1.1	ASUS Update utility	4-1
4.1.2	Creating a bootable floppy disk.....	4-4
4.1.3	ASUS EZ Flash 2 utility.....	4-5
4.1.4	Updating the BIOS	4-6
4.1.5	Saving the current BIOS file.....	4-8
4.1.6	ASUS CrashFree BIOS 3 utility	4-9
4.2	BIOS setup program	4-10
4.2.1	BIOS menu screen.....	4-11
4.2.2	Menu bar	4-11
4.2.3	Legend bar	4-12
4.2.4	Menu items	4-12
4.2.5	Sub-menu items.....	4-12
4.2.6	Configuration fields	4-12
4.2.7	Pop-up window	4-13
4.2.8	General help	4-13
4.3	Main menu	4-14
4.3.1	System Time	4-14
4.3.2	System Date	4-14
4.3.3	Language	4-14
4.3.4	Legacy Diskette A	4-14
4.3.5	Primary IDE Master/Slave.....	4-15
4.3.6	First, Second, Third, Fourth, Fifth, and Sixth SATA Master	4-17

Contents

4.3.7	HDD SMART Monitoring.....	4-18
4.3.8	Installed Memory.....	4-18
4.3.9	Usable Memory.....	4-18
4.4	Advanced menu	4-19
4.4.1	JumperFree Configuration.....	4-19
4.4.2	AI NET2.....	4-22
4.4.3	PEG Link Mode.....	4-23
4.4.4	CPU Configuration.....	4-23
4.4.5	Chipset.....	4-27
4.4.6	PCI PnP.....	4-29
4.4.7	Onboard Device Configuration.....	4-30
4.5	Power menu.....	4-34
4.5.1	ACPI Suspend Type.....	4-34
4.5.2	ACPI APIC Support.....	4-34
4.5.3	APM Configuration.....	4-35
4.5.4	Hardware Monitor.....	4-37
4.6	Boot menu	4-38
4.6.1	Boot Device Priority.....	4-38
4.6.2	Removable Drives.....	4-39
4.6.3	Hard Disk Drives.....	4-39
4.6.4	CDROM Drives.....	4-39
4.6.5	Boot Settings Configuration.....	4-40
4.6.6	Security.....	4-41
4.7	Tools menu	4-43
4.7.1	ASUS Music Alarm.....	4-43
4.7.2	ASUS O.C. Profile.....	4-45
4.7.3	ASUS EZ Flash 2.....	4-47
4.8	Exit menu.....	4-48

Contents

Chapter 5: Software support

5.1	Installing an operating system	5-1
5.2	Support CD information	5-1
5.2.1	Running the support CD	5-1
5.2.2	Drivers menu.....	5-2
5.2.3	Utilities menu	5-3
5.2.4	Make Disk menu	5-5
5.2.5	Manuals menu	5-6
5.2.6	ASUS Contact information	5-7
5.2.7	Other information	5-7

Notices

Federal Communications Commission Statement

This device complies with Part 15 of the FCC Rules. Operation is subject to the following two conditions:

- This device may not cause harmful interference, and
- This device must accept any interference received including interference that may cause undesired operation.

This equipment has been tested and found to comply with the limits for a Class B digital device, pursuant to Part 15 of the FCC Rules. These limits are designed to provide reasonable protection against harmful interference in a residential installation. This equipment generates, uses and can radiate radio frequency energy and, if not installed and used in accordance with manufacturer's instructions, may cause harmful interference to radio communications. However, there is no guarantee that interference will not occur in a particular installation. If this equipment does cause harmful interference to radio or television reception, which can be determined by turning the equipment off and on, the user is encouraged to try to correct the interference by one or more of the following measures:

- Reorient or relocate the receiving antenna.
- Increase the separation between the equipment and receiver.
- Connect the equipment to an outlet on a circuit different from that to which the receiver is connected.
- Consult the dealer or an experienced radio/TV technician for help.



The use of shielded cables for connection of the monitor to the graphics card is required to assure compliance with FCC regulations. Changes or modifications to this unit not expressly approved by the party responsible for compliance could void the user's authority to operate this equipment.

Canadian Department of Communications Statement

This digital apparatus does not exceed the Class B limits for radio noise emissions from digital apparatus set out in the Radio Interference Regulations of the Canadian Department of Communications.

This class B digital apparatus complies with Canadian ICES-003.

Safety information

Electrical safety

- To prevent electrical shock hazard, disconnect the power cable from the electrical outlet before relocating the system.
- When adding or removing devices to or from the system, ensure that the power cables for the devices are unplugged before the signal cables are connected. If possible, disconnect all power cables from the existing system before you add a device.
- Before connecting or removing signal cables from the motherboard, ensure that all power cables are unplugged.
- Seek professional assistance before using an adapter or extension cord. These devices could interrupt the grounding circuit.
- Make sure that your power supply is set to the correct voltage in your area. If you are not sure about the voltage of the electrical outlet you are using, contact your local power company.
- If the power supply is broken, do not try to fix it by yourself. Contact a qualified service technician or your retailer.

Operation safety

- Before installing the motherboard and adding devices on it, carefully read all the manuals that came with the package.
- Before using the product, make sure all cables are correctly connected and the power cables are not damaged. If you detect any damage, contact your dealer immediately.
- To avoid short circuits, keep paper clips, screws, and staples away from connectors, slots, sockets and circuitry.
- Avoid dust, humidity, and temperature extremes. Do not place the product in any area where it may become wet.
- Place the product on a stable surface.
- If you encounter technical problems with the product, contact a qualified service technician or your retailer.

About this guide

This user guide contains the information you need when installing and configuring the motherboard.

How this guide is organized

This guide contains the following parts:

- **Chapter 1: Product introduction**
This chapter describes the features of the motherboard and the new technology it supports.
- **Chapter 2: Hardware information**
This chapter lists the hardware setup procedures that you have to perform when installing system components. It includes description of the switches, jumpers, and connectors on the motherboard.
- **Chapter 3: Powering up**
This chapter describes the power up sequence and ways of shutting down the system.
- **Chapter 4: BIOS setup**
This chapter tells how to change system settings through the BIOS Setup menu. Detailed descriptions of the BIOS parameters are also provided.
- **Chapter 5: Software support**
This chapter describes the contents of the support CD that comes with the motherboard package.

Where to find more information

Refer to the following sources for additional information and for product and software updates.

1. **ASUS websites**
The ASUS website provides updated information on ASUS hardware and software products. Refer to the ASUS contact information.
2. **Optional documentation**
Your product package may include optional documentation, such as warranty flyers, that may have been added by your dealer. These documents are not part of the standard package.

Conventions used in this guide

To make sure that you perform certain tasks properly, take note of the following symbols used throughout this manual.



DANGER/WARNING: Information to prevent injury to yourself when trying to complete a task.



CAUTION: Information to prevent damage to the components when trying to complete a task.



IMPORTANT: Instructions that you **MUST** follow to complete a task.



NOTE: Tips and additional information to help you complete a task.

Typography

Bold text

Indicates a menu or an item to select.

Italics

Used to emphasize a word or a phrase.

<Key>

Keys enclosed in the less-than and greater-than sign means that you must press the enclosed key.

Example: <Enter> means that you must press the Enter or Return key.

<Key1+Key2+Key3>

If you must press two or more keys simultaneously, the key names are linked with a plus sign (+).

Example: <Ctrl+Alt+D>

Command

Means that you must type the command exactly as shown, then supply the required item or value enclosed in brackets.

Example: At the DOS prompt, type the command line:

awdf`lash` M2N32-WS.ROM

M2N32 WS Professional specifications summary

CPU	Socket AM2 for AMD Athlon™64 FX/Athlon™ 64 X2/ Athlon™ 64/Sempron™ processor Supports AMD Cool 'n' Quiet™ Technology AMD64 architecture enables simultaneous 32-bit and 64-bit computing
Chipset	NVIDIA® nForce® 590 SLI™ MCP(NVIDIA® LinkBoost™ Technology, NVIDIA® Tritium Technology certified) North bridge: NVIDIA® C51XE South bridge: NVIDIA® MCP55PXE PCI-X bridge: NEC uPD720404
System bus	2000 / 1600 MT/s
Memory	Dual-channel memory architecture <ul style="list-style-type: none"> - 4 x 240-pin DIMM sockets support unbuffered ECC/non-ECC DDR2 800/667/533 MHz memory modules - Supports up to 8 GB system memory
Expansion slots	2 x PCI Express™ x16 slots with NVIDIA® SLI™ support at full x16, x16 speed 2 x PCI-E x1 slots 2 x PCI-X slots 1 x PCI 2.2 slot
Scalable Link Interface (SLI™)	Supports two identical NVIDIA® SLI™-ready graphics cards, both at x16 mode
Storage	NVIDIA® nForce® 590 SLI™ MCP supports: <ul style="list-style-type: none"> - 1 x IDE connector for up to two Ultra DMA 133/100 devices - 6 x Serial ATA 3.0 Gb/s connectors support six Serial ATA devices - RAID 0, RAID1, RAID 0+1, RAID 5, and JBOD configurations spanning across Serial ATA drives via the onboard NVIDIA® MediaShield™ RAID controller Marvel® 88SE614x Serial ATA controller supports: <ul style="list-style-type: none"> - 3 x Internal Serial ATA 3.0 Gb/s - 1 x External Serial ATA 3.0 Gb/s on the rear panel - 1 x IDE connector for up to two Ultra DMA 100 devices
LAN	2 x Marvel® 88E1116 PHY Firewall function Supports Teaming functions

(continued on the next page)

M2N32 WS Professional specifications summary

High Definition Audio	SoundMAX® ADI AD1988B 8-channel CODEC Supports Jack-Sensing, Enumeration, Multi-Streaming, and Jack-Retasking Technology Optical and Coaxial S/PDIF Out interfaces
IEEE 1394	T1 1394 controller supports: - 2 x IEEE 1394a connectors (at mid-board)
USB	Supports up to 10 USB 2.0/1.1 ports
ASUS special features Performance	Intelligent overclocking tools: <ul style="list-style-type: none"> - AI NOS™ (Non-delay Overclocking System) - AI Overclocking (intelligent CPU frequency tuner) - AI Clock Skew - ASUS PEG Link (automatic performance tuning for single/dual graphics cards) ASUS BIOS Profile: overclocking configuration-sharing tool - ASUS C.P.R. (CPU Parameter Recall) - ASUS AI Booster - Adjustable FSB/DDR2 ratio. Fixed PCI/PCIe frequencies. - Hyper Path 3 Precision Tweaker: <ul style="list-style-type: none"> - vDIMM: 25-step DRAM voltage control - vCore: Adjustable CPU voltage at 0.0125 V increment - Stepless Frequency Selection(SFS) allows FSB tuning from 200 MHz up to 400 MHz at 1 MHz increment - PCI Express x16 frequency allows PCI Express x16 frequency tuning from 100 MHz to 200 MHz at 1 MHz increment
ASUS special features Thermal	ASUS 8-Phase Power Design Stack Cool 2 Q-Fan 2 ASUS Heat-pipe Thermal solution
ASUS special features Life	Multi-language BIOS SATA on the Go AI Nap AI Gear My Logo™ 3
ASUS special features Others	CrashFree BIOS 3 EZ Flash 2 ASUS AI NET 2 Q-Connector ASUS AI Quiet

(continued on the next page)

M2N32 WS Professional specifications summary

Rear panel	<ul style="list-style-type: none"> 1 x PS/2 keyboard port (purple) 1 x PS/2 mouse port (green) 1 x Parallel port 1 x External Serial ATA 3.0 Gb/s 1 x Optical S/PDIF Out port 1 x Coaxial S/PDIF Out port 2 x LAN (RJ-45) ports 4 x USB 2.0/1.1 ports 8-channel audio ports
Internal connectors	<ul style="list-style-type: none"> 3 x USB 2.0 connectors support six additional USB 2.0 ports 1 x Floppy disk drive connector 2 x IDE connectors for two devices 9 x Serial ATA connectors 1 x CPU / 4 x Chassis / 1 x Power fan connectors 2 x IEEE 1394a connectors 1 x Parallel connector 1 x TPM connector Chassis intrusion connector Front panel audio connector CD audio in connector 24-pin ATX power connector 8-pin ATX 2.0/1.1 power connector System panel connector
BIOS features	8 Mb AWARD BIOS, PnP, DMI 2.0, WfM2.0, SM BIOS 2.3
Manageability	WOL by PME, WOR by PME, PXE, AI NET 2, Chassis Intrusion
Power requirements	ATX power supply (with 24-pin and 4-pin 12 V plugs) ATX 12 V 2.0 compliant
Support CD contents	<ul style="list-style-type: none"> Device drivers BIOS flash utility under DOS ASUS AI Booster ASUS PC Probe II ASUS Update NVIDIA® RAID
Form factor	ATX form factor: 12 in x 9.6 in (30.5 cm x 24.5 cm)

*Specifications are subject to change without notice.

This chapter describes the motherboard features and the new technologies it supports.

1 Product introduction

Chapter summary

1

1.1	Welcome!	1-1
1.2	Package contents.....	1-1
1.3	Special features.....	1-2

1.1 Welcome!

Thank you for buying an **ASUS® M2N32 WS Professional motherboard!**

The motherboard delivers a host of new features and latest technologies, making it another standout in the long line of ASUS quality motherboards!

Before you start installing the motherboard, and hardware devices on it, check the items in your package with the list below.

1.2 Package contents

Check your motherboard package for the following items.

Motherboard	ASUS M2N32 WS Professional
I/O modules	1 x 2-port IEEE 1394a module 1 x 2-port USB 2.0 module
Cables	9 x Serial ATA cables 5 x Serial ATA power cables for up to nine devices 1 x Ultra DMA 133/100/66 cable 1 x Floppy disk drive cable
Accessories	I/O shield ASUS SLI™ Bridge ASUS Q-Connector Kit (USB, 1394, System panel)
Application CD	ASUS motherboard support CD InterVideo® Media Launcher
Documentation	User guide



If any of the above items is damaged or missing, contact your retailer.

1.3 Special features

1.3.1 Product highlights

Latest processor technology



The motherboard comes with a 940-pin AM2 socket that supports AMD Athlon™ 64 X2/Athlon™ 64/Athlon™ FX/Sempron™ processor. With an integrated low-latency high-bandwidth memory controller and a highly scalable HyperTransport™ technology-based system bus, the motherboard provides a powerful platform for your diverse computing needs, increased office productivity, and enhanced digital media experience. See page 2-7 for details.

NVIDIA® Scalable Link Interface (SLI™)



The NVIDIA® Scalable Link Interface (SLI™) technology allows two graphics processing units (GPUs) in a single system. This technology takes advantage of the PCI Express™ bus architecture and features intelligent hardware and software solutions that allows multiple GPUs to work together and achieve exceptional graphics performance.

64-bit CPU support



The motherboard supports 64-bit computing, which is the next generation technology to replace the current 32-bit architecture. The 64-bit architecture delivers advanced system performance, faster memory access, and increased productivity. This motherboard provides excellent compatibility and flexibility by support either 64-bit or 32-bit architecture. See page 2-7 for details.

DDR2 memory support



The motherboard supports DDR2 memory that features data transfer rates of 800/667/533 MHz to meet the higher bandwidth requirements of the latest 3D graphics, multimedia, and Internet applications. The dual-channel DDR2 architecture doubles the bandwidth of your system memory to boost system performance, eliminating bottlenecks with peak bandwidths of up to 10.7 GB/s. See pages 2-12 to 2-13 for details.

PCI-X® interface



The motherboard supports PCI-X, the new and improved version of the previous PCI standard. PCI-X offers faster data transfers and enhanced system reliability with ECC automatic single-bit error recovery and double-bit error detection. PCI-X, which is backward-compatible with PCI-based hardware and software, enables users to keep pace with upcoming advances in high-bandwidth, business-critical applications such as Fiber Channel, RAID, InfiniBrand™ Architecture, and iSCSI. See pages 2-18 and 2-26 for details.

PCI Express™ interface

The motherboard fully supports PCI Express, the latest I/O interconnect technology that speeds up the PCI bus. PCI Express features point-to-point serial interconnections between devices and allows higher clockspeeds by carrying data in packets. This high speed interface is software compatible with existing PCI specifications. See page 2-18 for details.

Serial ATA I/II technology and SATA-On-The-Go

The motherboard fully supports the Serial ATA II 3.0 Gb/s technology through the Serial ATA interfaces and the NVIDIA® nForce® 590 SLI™ chipset. The Serial ATA 3 Gb/s specification provides twice the bandwidth of the current Serial ATA products with a host of new features, including Power Management (PM) Implementation Algorithm. Serial ATA allows for thinner, more flexible cables with lower pin count and reduced voltage required. Leveraging these Serial ATA 3.0 Gb/s features is the SATA-On-The-Go. Supported by the Marvell® 88SE614x Serial ATA controller, four Serial ATA 3.0 Gb/s connectors (three at mid-board and one on the rear panel) provide smart setup, and hot-plug function. See pages 2-28, 2-31, and 2-32 for details.

IEEE 1394a support

The IEEE 1394a interface provides high-speed and flexible PC connectivity to a wide range of peripherals and devices compliant to the IEEE 1394a standard. The IEEE 1394a interface allows up to 400 Mbps transfer rates through simple, low-cost, high-bandwidth asynchronous (real-time) data interfacing between computers, peripherals, and consumer electronic devices such as camcorders, VCRs, printers, TVs, and digital cameras. See page 2-33 for details.

S/PDIF digital sound ready

The motherboard supports the S/PDIF technology through the S/PDIF interfaces on the rear panel. The S/PDIF technology turns your computer into a high-end entertainment system with digital connectivity to powerful audio and speaker systems. See page 2-27 for details.

USB 2.0 technology

The motherboard implements the Universal Serial Bus (USB) 2.0 specification, dramatically increasing the connection speed from the 12 Mbps bandwidth on USB 1.1 to a fast 480 Mbps on USB 2.0. USB 2.0 is backward compatible with USB 1.1. See pages 2-28 and 2-33 for details.



Dual Gigabit LAN solution

The motherboard comes with dual Gigabit LAN controllers to provide the total solution for your networking needs. These network controllers use the PCI Express segment to provide faster data bandwidth for your wired or wireless Internet, LAN, and file sharing requirements. See page 2-27 for details.



AMD Cool 'n' Quiet Technology

The motherboard supports the AMD Cool 'n' Quiet Technology, which monitors system operation and automatically adjusts CPU voltage and frequency for a cool and quiet operating environment. See page 4-26 for details.

1.3.2 ASUS Special features

AI Gear

AI Gear allows users to choose from four modes to adjust CPU, FSB speed and Vcore voltage, minimizing noise and power consumption. Users can choose the mode that best suits their needs. See page 4-20 for details

AI Nap

With AI Nap, the system can continue running at minimum power and noise when the user is temporarily away. To wake the system and return to the OS environment, simply click the mouse or press a key.

Advanced Thermal Design

ASUS Stack Cool 2

ASUS Stack Cool 2 is a fan-less and zero-noise cooling solution that lowers the temperature of critical heat generating components. The motherboard uses a special design on the printed circuit board (PCB) to dissipate heat that critical components generate. See page 2-3 for details.

8-Phase Power Design

The ASUS 8-Phase Power Design prolongs CPU lifespan and keeps the system stable by preventing high power stress to the CPU and power supply module. The design ensures high efficiency operation to generate less heat compared with conventional power solutions, thus achieving cool system environment and making this motherboard ideal for overclocking.

Fanless Design and Heat-pipe

The ASUS fanless design allows multi-directional heat flow from major thermal sources in the motherboard to lower overall system temperature, resulting in quieter operation and longer system life. ASUS has devoted special efforts to address the thermal issues across the motherboard, and most notably in the following areas: CPU, power, VGA, Northbridge and Southbridge. The heat pipe, heatsink, and strategic board layout were tailor made to dissipate heat in the most efficient manner.

ASUS CrashFree BIOS 3



The ASUS CrashFree BIOS 3 allows users to restore corrupted BIOS data from a USB flash disk containing the BIOS file. This utility saves users the cost and hassle of buying a replacement BIOS chip. See page 4-9 for details.

ASUS EZ Flash 2



EZ Flash 2 is a user-friendly BIOS update utility. Simply press the predefined hotkey to launch the utility and update the BIOS without entering the OS. Update your BIOS easily without preparing a bootable diskette or using an OS-based flash utility. See pages 4-5 and 4-47 for details.

ASUS MyLogo 3



ASUS My Logo 3 is the new feature present in the motherboard that allows you to personalize and add style to your system with customizable and animated boot logos.

PEG Link Mode for two graphics cards



This feature enhances your PCI Express graphics card performance. It allows the motherboard to automatically adjust the PCI Express graphics link mode to the correct frequency based on the system configuration. Four additional settings are available for overclocking the PEG Link Mode. See page 4-23 for details.

Precision Tweaker



This feature allows you to fine tune the CPU/memory voltage and gradually increase the memory Front Side Bus (FSB) and PCI Express frequency at 1MHz increment to achieve maximum system performance.

ASUS Multi-language BIOS



The multi-language BIOS allows you to select the language of your choice from the available options. The localized BIOS menus allow easier and faster configuration. See page 4-14 for details.

C.P.R. (CPU Parameter Recall)



The C.P.R. feature of the motherboard BIOS allows automatic re-setting to the BIOS default settings in case the system hangs due to overclocking. When the system hangs due to overclocking, C.P.R. eliminates the need to open the system chassis and clear the RTC data. Simply shut down and reboot the system, and the BIOS automatically restores the CPU default setting for each parameter.

Q-Connector



The ASUS Q-Connector allows you to connect or disconnect chassis front panel cables in one easy step with one complete module. This unique adapter eliminates the trouble of plugging in one cable at a time, making connection quick and accurate.

ASUS O.C. Profile



The motherboard features the ASUS BIOS Profile that allows users to conveniently store or load multiple BIOS settings. The BIOS settings can be stored in the CMOS or a separate file, giving users freedom to share and distribute their favorite settings.

AI NOS™ (Non-Delay Overclocking System)



ASUS Non-delay Overclocking System™ (NOS) is a technology that auto-detects the CPU loading and dynamically overclocks the CPU speed only when needed. See page 4-20 for details.

This chapter lists the hardware setup procedures that you have to perform when installing system components. It includes description of the jumpers and connectors on the motherboard.

Hardware information



2.1	Before you proceed	2-1
2.2	Motherboard overview.....	2-2
2.3	Central Processing Unit (CPU)	2-7
2.4	System memory	2-12
2.5	Expansion slots.....	2-16
2.6	Jumper	2-25
2.7	Connectors	2-27

2.1 Before you proceed

Take note of the following precautions before you install motherboard components or change any motherboard settings.



- Unplug the power cord from the wall socket before touching any component.
- Use a grounded wrist strap or touch a safely grounded object or to a metal object, such as the power supply case, before handling components to avoid damaging them due to static electricity.
- Hold components by the edges to avoid touching the ICs on them.
- Whenever you uninstall any component, place it on a grounded antistatic pad or in the bag that came with the component.
- Before you install or remove any component, ensure that the ATX power supply is switched off or the power cord is detached from the power supply. Failure to do so may cause severe damage to the motherboard, peripherals, and/or components.

Onboard LED

The motherboard comes with a standby power LED. The green LED lights up to indicate that the system is ON, in sleep mode, or in soft-off mode. This is a reminder that you should shut down the system and unplug the power cable before removing or plugging in any motherboard component. The illustration below shows the location of the onboard LED.

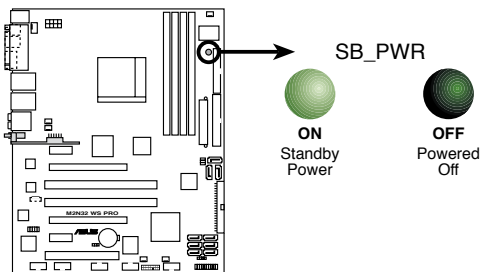

M2N32 WS PRO Onboard LED

2.2 Motherboard overview

Before you install the motherboard, study the configuration of your chassis to ensure that the motherboard fits into it.



Make sure to unplug the power cord before installing or removing the motherboard. Failure to do so can cause you physical injury and damage motherboard components.

2.2.1 Placement direction

When installing the motherboard, make sure that you place it into the chassis in the correct orientation. The edge with external ports goes to the rear part of the chassis as indicated in the image below.

2.2.2 Screw holes

Place nine (9) screws into the holes indicated by circles to secure the motherboard to the chassis.



Do not overtighten the screws! Doing so can damage the motherboard.

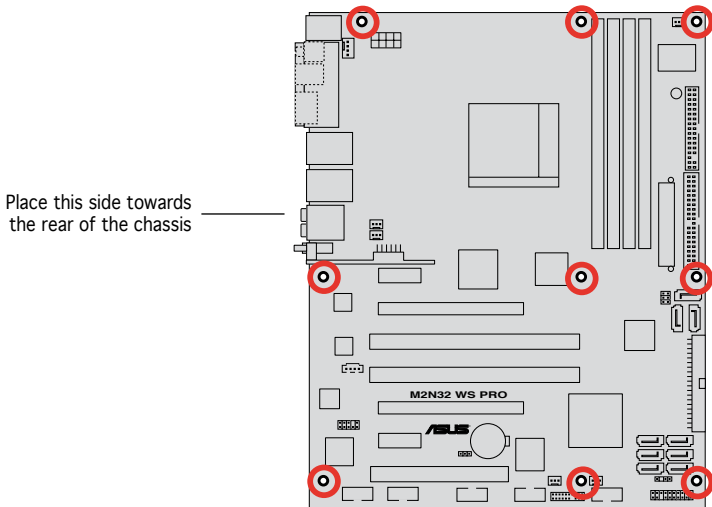

2.2.3 ASUS Stack Cool 2

The motherboard comes with the ASUS Stack Cool 2 cooling solution that lowers the temperature of critical heat generating components by 20°C. The motherboard uses a special design on the printed circuit board (PCB) to dissipate heat that critical components generate.



2.2.5 Motherboard layout

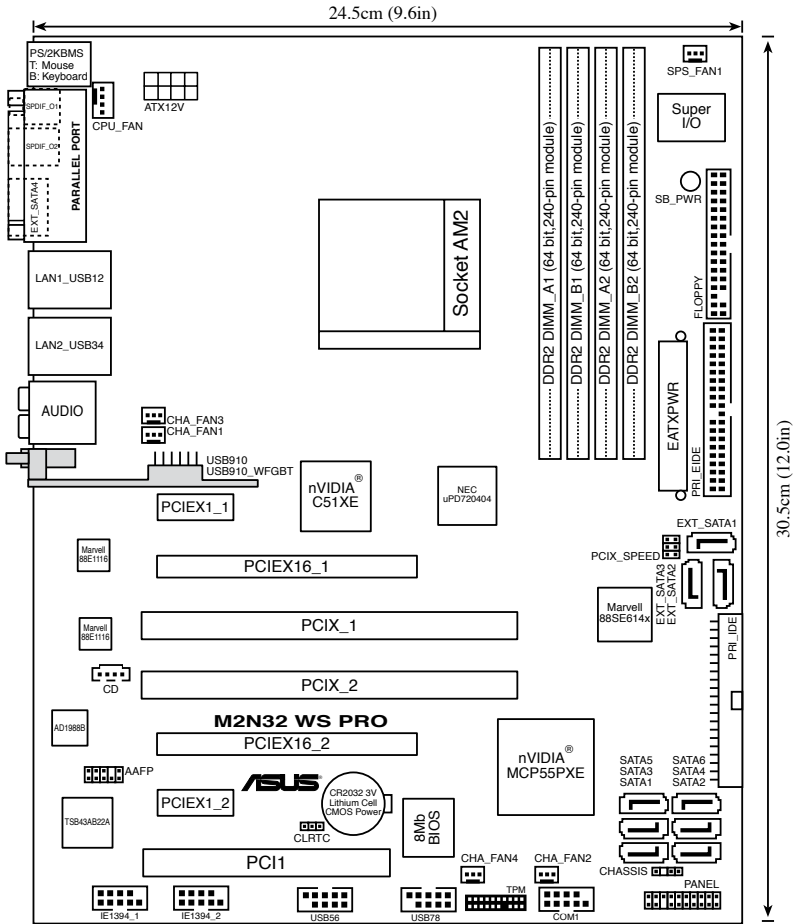

2.2.4 Layout contents

Slots		Page
1.	DDR2 DIMM slots	2-12
2.	PCI slots	2-18
3.	PCI Express x16 slots	2-18
4.	PCI Express x1 slot	2-18
5.	PCI-X slots	2-18

Jumper		Page
1.	Clear RTC RAM (3-pin CLRTC)	2-25
2.	PCI-X Speed setting (6-pin PCIX_SPEED)	2-26

Rear panel connectors		Page
1.	PS/2 mouse port (green)	2-27
2.	Parallel port	2-27
3.	LAN 1 (RJ-45) port	2-27
4.	LAN 2 (RJ-45) port	2-27
5.	Rear Speaker Out port (black)	2-27
6.	Center/Subwoofer port (orange)	2-27
7.	Line In port (light blue)	2-27
8.	Line Out port (lime)	2-27
9.	Microphone port (pink)	2-28
10.	Side Speaker Out port (gray)	2-28
11.	USB 2.0 ports 1 and 2	2-28
12.	USB 2.0 ports 3 and 4	2-28
13.	External SATA port	2-28
14.	Optical S/PDIF Out port	2-28
15.	Coaxial S/PDIF Out port	2-28
16.	PS/2 keyboard port (purple)	2-28

Internal connectors		Page
1.	Floppy disk drive connector (34-1 pin FLOPPY)	2-29
2.	NVIDIA® IDE connector (40-1 pin PRI_IDE)	2-29
3.	Marvell® IDE connector (40-1 pin PRI_EIDE)	2-30
4.	NVIDIA® nForceNVIDIA® 590 SLI Southbridge Serial ATA connectors (7-pin SATA1 [red], SATA2 [red], SATA3 [red], SATA4 [red], SATA5 [red], SATA6 [red])	2-31
5.	Marvell® 88SE614x Serial ATA connector (7-pin EXT_SATA1, EXT_SATA2, EXT_SATA3)	2-32
6.	USB connectors (10-1 pin USB56, USB78, USB910)	2-33
7.	IEEE 1394a port connectors (10-1 pin IE1394_1, 10-1 pin IE1394_2)	2-33
8.	CPU, chassis, power, and Power Fan connectors (4-pin CPU_FAN, 3-pin CHA_FAN1, 3-pin CHA_FAN2, 3-pin CHA_FAN3, 3-pin CHA_FAN4, 3-pin SPS_FAN1)	2-34
9.	Chassis intrusion connector (4-1 pin CHASSIS)	2-35
10.	ATX power connectors (24-pin EATXPWR, 8-pin ATX12V)	2-35
11.	Front panel audio connector (10-1 pin AAFP)	2-36
12.	Internal audio connector (4-pin CD [black])	2-37
13.	Serial port connector (10-1 pin COM1)	2-37
14.	TPM connector (20-1 pin TPM)	2-38
15.	System panel connector (20-pin PANEL) <ul style="list-style-type: none"> • System power LED (2-pin PLED) • Hard disk drive activity LED (2-pin IDE_LED) • System warning speaker (4-pin SPEAKER) • ATX power button/soft-off button (2-pin PWR) • Reset button (2-pin RESET) 	2-39

2.3 Central Processing Unit (CPU)

The motherboard comes with a 940-pin AM2 socket designed for the AMD Athlon™ 64 X2/Athlon™ 64 FX/Athlon™ 64/Sempron™ processor.



The AM2 socket has a different pinout from the 939-pin socket designed for the AMD Opteron™ processor. Make sure you use a CPU is designed for the AM2 socket. The CPU fits in only one correct orientation. DO NOT force the CPU into the socket to prevent bending the connectors on the socket and damaging the CPU!

2.3.1 Installing the CPU

To install a CPU:

1. Locate the CPU socket on the motherboard.

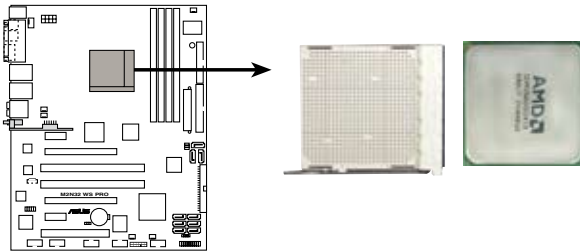

M2N32 WS PRO CPU Socket AM2

2. Unlock the socket by pressing the lever sideways, then lift it up to a 90° angle.

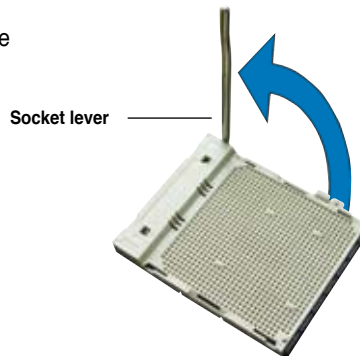

Make sure that the socket lever is lifted up to a 90° angle; otherwise, the CPU will not fit in completely.

3. Position the CPU above the socket such that the CPU corner with the gold triangle matches the socket corner with a small triangle.
4. Carefully insert the CPU into the socket until it fits in place.

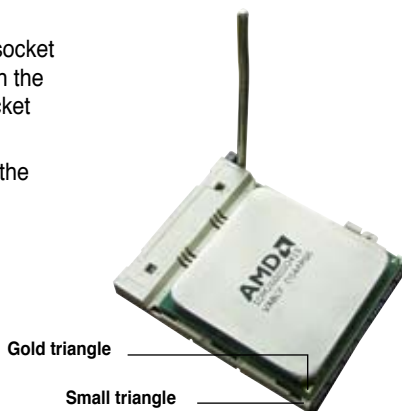

5. When the CPU is in place, push down the socket lever to secure the CPU. The lever clicks on the side tab to indicate that it is locked.
6. Install a CPU heatsink and fan following the instructions that came with the heatsink package.



2.3.2 Installing the heatsink and fan

The AMD Athlon™ 64FX/Athlon™ 64/Athlon™ 64 X2/Sempron™ processor requires a specially designed heatsink and fan assembly to ensure optimum thermal condition and performance.



Make sure that you use only AMD-certified heatsink and fan assembly.

To install the CPU heatsink and fan:

1. Place the heatsink on top of the installed CPU, making sure that the heatsink fits properly on the retention module base.



- The retention module base is already installed on the motherboard upon purchase.
 - You do not have to remove the retention module base when installing the CPU or installing other motherboard components.
 - If you purchased a separate CPU heatsink and fan assembly, make sure that a Thermal Interface Material is properly applied to the CPU heatsink or CPU before you install the heatsink and fan assembly.
-

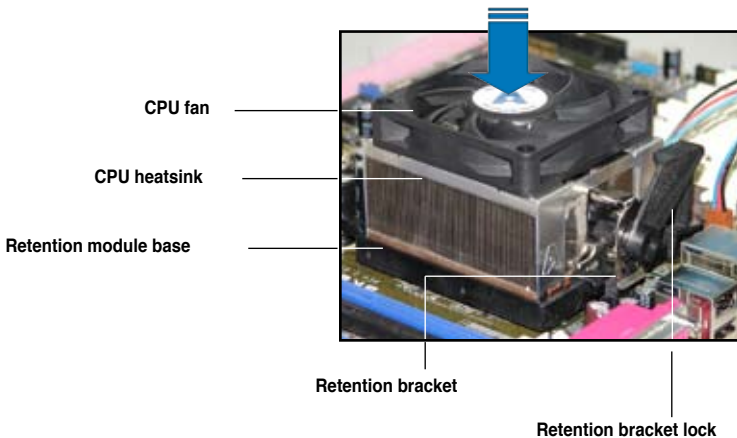

Your boxed CPU heatsink and fan assembly should come with installation instructions for the CPU, heatsink, and the retention mechanism. If the instructions in this section do not match the CPU documentation, follow the latter.

2. Attach one end of the retention bracket to the retention module base.

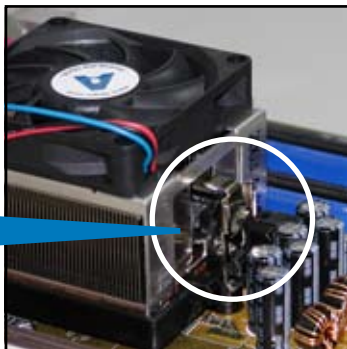
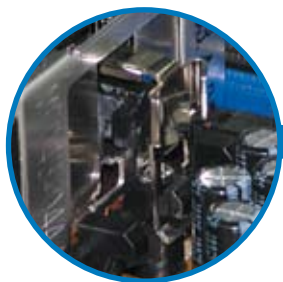

3. Align the other end of the retention bracket (near the retention bracket lock) to the retention module base. A clicking sound denotes that the retention bracket is in place.



Make sure that the fan and heatsink assembly perfectly fits the retention mechanism module base, otherwise you cannot snap the retention bracket in place.



4. Push down the retention bracket lock on the retention mechanism to secure the heatsink and fan to the module base.

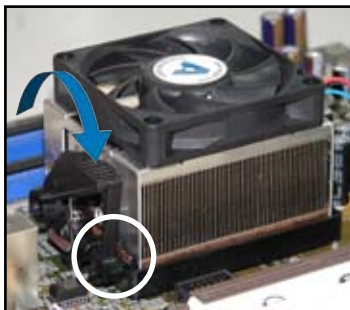

- When the fan and heatsink assembly is in place, connect the CPU fan cable to the connector on the motherboard labeled CPU_FAN.

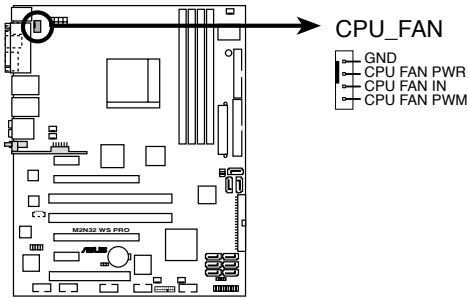

M2N32 WS PRO CPU fan connector



Do not forget to connect the CPU fan connector! Hardware monitoring errors can occur if you fail to plug this connector.

2.4 System memory

2.4.1 Overview

The motherboard comes with four Double Data Rate 2 (DDR2) Dual Inline Memory Modules (DIMM) sockets.

A DDR2 module has the same physical dimensions as a DDR DIMM but has a 240-pin footprint compared to the 184-pin DDR DIMM. DDR2 DIMMs are notched differently to prevent installation on a DDR DIMM socket.

The figure illustrates the location of the DDR2 DIMM sockets:

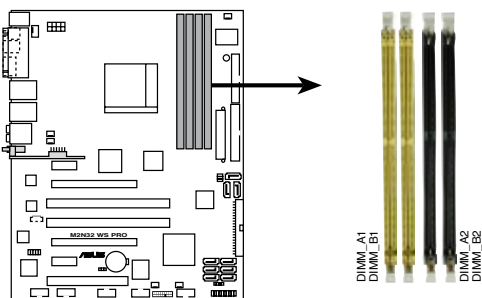

M2N32 WS PRO 240-pin DDR2 DIMM sockets

Channel	Sockets
Channel 1	DIMM_A1 and DIMM_B1
Channel 2	DIMM_A2 and DIMM_B2

2.4.2 Memory configurations

You may install 256 MB, 512 MB, and 1 GB unbuffered ECC/non-ECC DDR2 DIMMs into the DIMM sockets.



- For dual-channel configuration, the total size of memory module(s) installed per channel must be the same (DIMM_A1 + DIMM_B1 = DIMM_A2 + DIMM_B2).
- Always install DIMMs with the same CAS latency. For optimum compatibility, we recommend that you obtain memory modules from the same vendor. Visit the ASUS website (www.asus.com) for the latest Qualified Vendors List.
- When using only one DDR2 DIMM module, install it into slot DIMM_A1 only.
- For single-channel memory configuration, start installing the DDR2 DIMMs from slot DIMM_A1 or DIMM_B1.
- For dual-channel memory configuration, install the DIMMs in slots DIMM_B1 and DIMM_A1 (yellow slots); install another pair of DIMMs in slots DIMM_B2 and DIMM_A2 (black slots).



Important notice on installing Windows® XP 32-bit version

If you install Windows® XP 32-bit version Operating System (OS), the limitation of this OS version is that it may reserve a certain amount of memory space for system devices. We recommend that you install less than 3 GB system memory if you would like to work under Windows® XP 32-bit version OS. The excess memory installation will not cause any usage problem, but it will not give users the benefit of manipulating this excess memory space.

Visit the ASUS FAQ site for further explanation:

<http://support.asus.com/faq/faq.aspx?SLanguage=en-us>

Under **General Search**, make the selections as shown, then click **Search**.

Click the article titled "**4GB memory installed but less memory size detected.**"



You also may check the URLs below for third party comments on this issue:

http://dlsvr01.asus.com/pub/ASUS/mb/4GB_Rev1.pdf

<http://www.intel.com/support/motherboards/server/sb/cs-016594.htm>

Qualified Vendors Lists (QVL)

DDR2-800

SIZE	Type	Vendor	Module	Chip Vendor	Chip Component
256Mbytes	Unbuffer	Samsung	M37813253FZ3-CE7	Samsung	K4T560830F-ZCE7
512Mbytes	Unbuffer	Hynix	HYMP564U64AP8-S6	Hynix	HY5PS12821AFP-S6

DDR2-667

SIZE	Type	Vendor	Module	Chip Vendor	Chip Component
256Mbytes	Unbuffer	Hynix	HYMP532U64AP6-Y5 AA	Hynix	HY5PS121621AFP-Y5
	Unbuffer	Micron	MT8HTF3264AY-667B5		45B4209CZM
	Unbuffer	Samsung	M37813253FZ0-CE6	Samsung	K4T560830F-ZCE6 AM4B5716MJS7E-
512Mbytes		Apacer	78_81G9F9M2	Apacer	0609D
		Adata	M2OE15G3H3160B1COZ	Elpida	E5108AE-GE-E
	Unbuffer	Hynix	HYMP564U64AP8-Y4	Hynix	HY5PS12821AFP-Y4
	Unbuffer	Hynix	HYMP564U64AP8-Y5	Hynix	HY5PS12821AFP-Y5
	Unbuffer	Kingmax	KLCC28F-A8EB5		E5108AE-6E-F
	Unbuffer	Micron	MT16HTF6464AY-667B3	Micron	45B41D9CZM
	Unbuffer	Micron	MT16HTF6464AY-667B4	Micron	4VB41D9CZM
	Unbuffer	Samsung	M37813253FZ0-CE6	Samsung	K4T560830F-ZCE6
	Unbuffer	Samsung	M37816453FZ0-CE6	Samsung	K4T560830F-ZCE6
	Unbuffer	Samsung	M37816553CZ0-CE6	SEC	K4T51083QC
1024Mbytes	Unbuffer	Corsair	V5512MB667D2	Corsair	MJ10053032M8ECE
	ECC	Hynix	HYMP512U72AP8-Y4	Hynix	HY5PS12821AFP-Y4
	ECC	Hynix	HYMP512U72AP8-Y5	Hynix	HY5PS12821AFP-Y5
	Unbuffer	Micron	MT16HTF12864AY-667A3	Micron	42A32D9DOT
	Unbuffer	Micron	MT16HTF12864AY-66EA3	Micron	5EAI1Z9FNMJ
	Unbuffer	Samsung	M37812953CZ0-CE6	Samsung	K4T51083QC

DDR2-533

SIZE	Type	Vendor	Module	Chip Vendor	Chip Component
256Mbytes	Unbuffer	Micron	MT8HTF3264AG-53EB3	Micron	MT4CB11Z9BQT
	Unbuffer	Samsung	M37813253FG0-CD5	Samsung	K4T560830F-GCD5
					HY5PS121621 FP-C4
	Unbuffer	KINGSTON	KVR533D2N4/256GID	Hynix	528A HY5PS121621 FP-C4
	Unbuffer	KINGSTON	KVR533D2N4/256	Hynix	526A
512Mbytes	Unbuffer	Adata	M2OHY2F4G2150A1B0Z	Hynix	HY5PS12821
	Unbuffer	Transcend	TS32MLQ64V5M	ELPIDA	E5116AF-5C-E 32M16CED
	Unbuffer	Corsair	VS256MB533D2	Corsair	EL1100549
	Unbuffer	Adata	M2OHT2G3H3110A1B0Z	Hynix	HY5PS12821
	Unbuffer	Corsair	CM2X-512-4300	Corsair	
	Unbuffer	PQI	MEAB-328LA0102-05D1	PQI	PQB2648Y38
	Unbuffer	Corsair	V5512MB533D2	Corsair	MJ100533 32M8CEC
	Unbuffer	GEL	GX25124300X		
	Unbuffer	Elpida	EBE51E8ABFA-5C-E	Elpida	□
	Unbuffer	Elpida	EBE51UD8ABFA-5C-E	Elpida	E5108AB-5C-E
	Unbuffer	Hynix	HYMP564U648-C4 AA	Hynix	HY5PS12821F-C4
	Unbuffer	Hynix	HYMP564U728-C4	Hynix	HY5PS12821F-C4
	Unbuffer	Kingston	KVR533D2N4/512GID	SEC	K4T51083QC
	Unbuffer	Micron	MT16HTF6464AG-53EB2	Micron	MT4DB11Z9BQT
	Unbuffer	Samsung	M37816553BG0-CD5	Samsung	K4T51083QB-GCD5
	Unbuffer	Samsung	M39116453FG0-CD5	Samsung	K4T51083QB-GCD5
	Unbuffer	Samsung	M39116553BG0-CD5	Samsung	K4T560830F-GCD5
Unbuffer	PQI	MEAB322HA1601	PQI	PQB2328S38	
1024Mbytes	Unbuffer	Transcend	TS64MLQ64V5J	Samsung	K4T51083QB-GCD5
	ECC	Hynix	HYMP512U648-C4	Hynix	HY5PS12821F-C4
	Unbuffer	Transcend	TS128MLQ64V5J	SEC	K4T51083QC
2048Mbytes	Unbuffer	Micron	MT16HTF12864AY-53EA1	Micron	4MAI1 D9CZ
	Unbuffer	Kinston	KVR533D2N4/2G	Elpida	E1108AA-5C-E

2.4.3 Installing a DIMM



Unplug the power supply before adding or removing DIMMs or other system components. Failure to do so can cause severe damage to both the motherboard and the components.

To install a DIMM:

1. Unlock a DIMM socket by pressing the retaining clips outward.
2. Align a DIMM on the socket such that the notch on the DIMM matches the break on the socket.
3. Firmly insert the DIMM into the socket until the retaining clips snap back in place and the DIMM is properly seated.

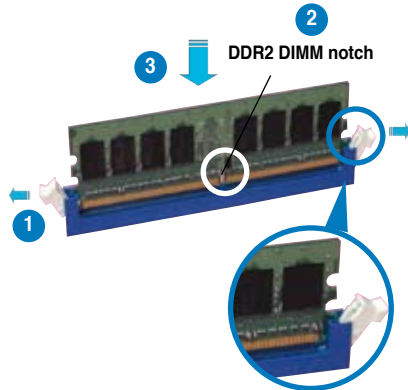

Unlocked retaining clip



- A DDR2 DIMM is keyed with a notch so that it fits in only one direction. Do not force a DIMM into a socket to avoid damaging the DIMM.
- The DDR2 DIMM sockets do not support DDR DIMMs. DO not install DDR DIMMs to the DDR2 DIMM sockets.

2.4.4 Removing a DIMM

To remove a DIMM:

1. Simultaneously press the retaining clips outward to unlock the DIMM.



Support the DIMM lightly with your fingers when pressing the retaining clips. The DIMM might get damaged when it flips out with extra force.

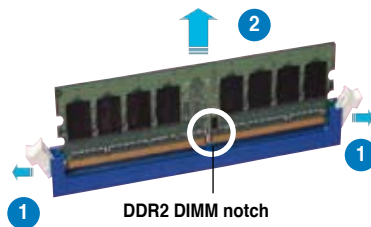

2. Remove the DIMM from the socket.

2.5 Expansion slots

In the future, you may need to install expansion cards. The following sub-sections describe the slots and the expansion cards that they support.



Make sure to unplug the power cord before adding or removing expansion cards. Failure to do so may cause you physical injury and damage motherboard components.

2.5.1 Installing an expansion card

To install an expansion card:

1. Before installing the expansion card, read the documentation that came with it and make the necessary hardware settings for the card.
2. Remove the system unit cover (if your motherboard is already installed in a chassis).
3. Remove the bracket opposite the slot that you intend to use. Keep the screw for later use.
4. Align the card connector with the slot and press firmly until the card is completely seated on the slot.
5. Secure the card to the chassis with the screw you removed earlier.
6. Replace the system cover.

2.5.2 Configuring an expansion card

After installing the expansion card, configure the it by adjusting the software settings.

1. Turn on the system and change the necessary BIOS settings, if any. See Chapter 4 for information on BIOS setup.
2. Assign an IRQ to the card. Refer to the tables on the next page.
3. Install the software drivers for the expansion card.



When using PCI cards on shared slots, ensure that the drivers support "Share IRQ" or that the cards do not need IRQ assignments; otherwise, conflicts will arise between the two PCI groups, making the system unstable and the card inoperable.

2.5.3 Interrupt assignments

Standard interrupt assignments

IRQ	Priority	Standard function
0	1	System Timer
1	2	Keyboard Controller
2	–	Redirect to IRQ#9
4	12	Communications Port (COM1)*
5	13	IRQ Holder for PCI Steering*
6	14	Floppy Disk Controller
7	15	Printer Port (LPT1)*
8	3	System CMOS/Real Time Clock
9	4	IRQ Holder for PCI Steering*
10	5	IRQ Holder for PCI Steering*
11	6	IRQ Holder for PCI Steering*
12	7	PS/2 Compatible Mouse Port*
13	8	Numeric Data Processor
14	9	Primary IDE Channel
15	10	Secondary IDE Channel

* These IRQs are usually available for ISA or PCI devices.

2.5.4 PCI slot

The PCI slot supports cards such as a LAN card, SCSI card, USB card, and other cards that comply with PCI specifications. Refer to the figure below for the location of the slot.

2.5.5 Two PCI-X slots

The PCI-X slots support cards such as a LAN card, SCSI card, USB card, and other cards that comply with PCI-X 1.0 specifications. Refer to the figure below for the location of the slots.

2.5.6 Two PCI Express x1 slots

This motherboard supports PCI Express x1 network cards, SCSI cards and other cards that comply with the PCI Express specifications. Refer to the figure below for the location of the slot.

2.5.7 Two PCI Express x16 slots

This motherboard supports two SLI-ready PCI Express x16 graphic cards that comply with the PCI Express specifications. Refer to the figure below for the location of the slot.

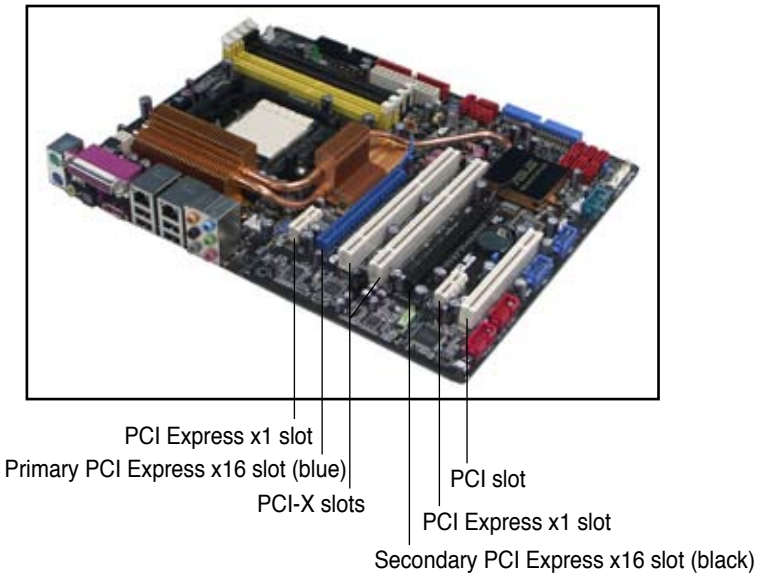



-
- Connect a rear chassis fan to the chassis (CHA_FAN1 or CHA_FAN2) connector when using two graphics cards for better thermal environment. See page 2-33 for details.
 - In single card mode, you may use either the blue or black slot for PCI Express x16 cards.
 - In NVIDIA® SLI™ mode, the PCI Express x16 slots work at the full bandwidth of PCI Express x16 for a combined bandwidth of x32.
 - We recommend that you provide sufficient power when running NVIDIA® SLI™ mode. See page 2-31 for details.



-
- In Single Card mode, you may use either the blue or black slot for PCI Express x16 graphics cards.
 - In SLI mode, the PCI Express x16 slots work at the full bandwidth of PCI Express x16 on each slot for a combined bandwidth of x32.
 - Due to NVIDIA nForce4 SLI x16 chipset limitation, if you install a Dual-GPU graphics card on the blue x16 slot, it runs at x8 speed for one of the two GPUs.
 - Due to NVIDIA nForce4 SLI x16 chipset limitations, this motherboard does not support two dual-GPU graphics cards (total 4 GPUs) running in SLI mode.
-

Qualified graphics cards

Model	Connect Interface	OS Environment	Status	Chipset
Type: PCI				
ATI GC-R92SEPCI-C3 Rev.1.1 (BIOS: V8.011.006)	PCI1	WinXP Pro	Pass	ATI Radeon 9200SE
Gecube R7000PCI-A3 Rev. 1.1 (BIOS: V008.004)	PCI1	Win2000 Pro (CHT)	Pass	ATI Radeon 7000
Gecube R9250PCI-D3 Rev. 1.0 (BIOS: V008.011)	PCI1	Win2003 R2 Standard (CHS)	Pass	ATI Radeon 9250
Matrox G200 MMS Rev. A (BIOS: V3.3 b34)	PCI1	Win2000 Pro (CHT)	Pass	Matrox G200
Matrox PH-P256 Rev. A (BIOS: V1.1.017)	PCI1	Win2003 R2 Standard (ENG)	Pass	Matrox Parhelia-256
Powercolor Radeon 7000 Rev.V1.0 (BIOS: V008.004.008)	PCI1		Pass	ATI Radeon 7000
Model				
Type: PCIEX16				
ASUS EAX300 Rev: V1.00 (BIOS: V5b60.8.15.117.0)	PCIEX16_2	WinXP Pro	Pass	ATI Radeon X300
ASUS EAX300SE Rev: V1.00 (BIOS: V5b60.8.15.117.0)	PCIEX16_1	WinXP Pro.	Pass	ATI Radeon X300SE
ASUS EAX300SE-HM128 Rev: V1.00 (BIOS: V008.015.128.000)	PCIEX16_1	Win2000 Pro	Pass	ATI Radeon X300SE (Hyper Memory)
ASUS EAX300SE-X Rev: V1.00 (BIOS: V008.015.117.000)	PCIEX16_1	Win2003 R2 Standard (CHS)	Pass	ATI Radeon X300SE
ASUS EAX550 128M (BIOS: V5B60.8.15.139. AS05)	PCIEX16_2	WinXP Home (JPN)	Pass	ATI Radeon X550
ASUS EAX550GE 256M (BIOS: V5B60.8.15.139.AS01)	PCIEX16_2	Win2000 Pro	Pass	ATI Radeon X550
ASUS EAX600XT Rev. V1.02 (BIOS: V113-AA20306-100 AS)	PCIEX16_1	WinXP-64 Pro.	Pass	ATI Radeon X600XT
ASUS EAX700 (BIOS: V5E4D.9.7.1.3. AS01)	PCIEX16_2	WinXP Home (JPN)	Pass	ATI Radeon X700
ASUS EAX700-X 128M Rev. V1.00a (BIOS: V009.008.001.004)	PCIEX16_1	WinXP Pro.(CHT)	Pass	ATI Radeon X700LE
ASUS EAX700LE 128M (BIOS: V5E4D.9.8.1.4. AS13)	PCIEX16_2	WinXP-64 Pro.	Pass	ATI Radeon X700LE
Albatron PC6200 (BIOS: V5.43.02.27)	PCIEX16_2	WinXP-64 Pro	Pass	nVidia GeForce 6200
ASUS EAX700PRO Rev. V1.00 (BIOS: V113-AA.30602-100)	PCIEX16_2	Win2003 R2 Enterprise (CHT)	Pass	ATI Radeon X700PRO
ASUS EN6800GT Rev. V1.02 (BIOS: V5.40.02.26.AS05)	PCIEX16_1	Win2003 R2 Standard		nVidia GeForce 6800GT
ASUS EN6800 Rev. V1.00 (BIOS: V5.41.02.17.AS01)	PCIEX16_1 PCIEX16_2	WinXP Pro.	Pass	nVidia GeForce 6800
ASUS EAX800XL Rev. V1.00 (BIOS: V554D.9.7.1.AS02)	PCIEX16_2	WinXP Pro.	Pass	ATI Radeon X800XL

(continued on the next page)

Qualified graphics cards

Model	Connect Interface	OS Environment	Status	Chipset
ASUS EAX1300 (BIOS: V113.AA77100.102)	PCIEX16_1	Win2003-64 R2 Standard	Pass	ATI Radeon X1300
ASUS EAX1800XT 512MB (BIOS: V7100.9.12.4.2.AS01)	PCIEX16_1	WinXP Pro.	Pass	ATI Radeon X1800XT
ASUS EAX1600XT Silent 256MB V.1.00 (BIOS: 71C0.9.12.4.2)	PCIEX16_2	Win2000 Pro	Pass	ATI Radeon X1600XT
ASUS EAX1900CrossFire (BIOS: 7249.9.12.5.2AS05)	PCIEX16_1	WinXP Pro.	Pass	ATI Radeon X1900CF
ASUS EN5750/128 Rev. 1.01 (BIOS: V04.32.20.38.00)	PCIEX16_1	WinXP-64 Pro.	Pass	nVidia GeForce PCX5750
ASUS EN5900 Rev. 1.01 (BIOS: V04.35.20.45)	PCIEX16_1	WinXP Pro.	Pass	nVidia GeForce PCX5900
ASUS EN6200GE Rev V1.00A (BIOS: V5.43.02.27.AS07)	PCIEX16_2	Win2003-64 R2 Standard	Pass	nVidia GeForce 6200
ASUS EN6500 128M Rev V1.02 (BIOS: V5.44.02.45.0)	PCIEX16_1	Win2000 Pro	Pass	nVidia GeForce 6500
ASUS EN6800LE Rev. V1.00 (BIOS: V5.41.02.34.AS01)	PCIEX16_2	Win2003 R2 Enterprise (ENG)	Pass	nVidia GeForce 6800LE
ASUS EN7600GT Silent/256M (Bios: V5.73.22.15.01)	PCIEX16_2	Win2003-64 R2 Standard	Pass	nVIDIA GeForce 7600GT
ASUS EN7900GTX 512MX16 (Bios: V5.71.22.12.01)	PCIEX16_1 (SLI) PCIEX16_2 (SLI)	WinXP Pro.	Pass	nVIDIA GeForce 7900GTX
ATI Radeon X850 CrossFire (BIOS: V009.010.001.015)	PCIEX16_1	Win2003 R2 Enterprise (ENG)	Pass	ATI Radeon X850
Elsa Falcox X85 XT 256B3 DTV Rev: PN: 109 A47401-10 (BIOS: 009.007.001.004)	PCIEX16_1	Win2003-64 R2 Standard	Pass	ATI Radeon X850 XT
ASUS EAX850XT 256MB Rev. PN: 109-A47401-10 (BIOS: V009.007.001.004)	PCIEX16_2	WinXP Pro.		ATI Radeon X850XT
Leadtek WinFast PX7300GS 128MX16 Rev. (BIOS:5.72.22.34.68)	PCIEX16_1	WinXP Pro.	Pass	nVidia GeForce 7300GS
Leadtek WinFast PX7800GTX TDH 256MB Rev. (BIOS: V5.70.02.11.68)	PCIEX16_1	Win2003 R2 Enterprise	Pass	nVidia GeForce 7800GTX
Leadtek Quadro FX1400 128M (BIOS:V5.41.02.43.03)	PCIEX16_1	Win2000 Pro	Pass	nVidia Quadro FX1400
Matrox Parhelia APVe 128M Rev. A (BIOS: V1.3-11)	PCIEX16_2	WinXP Pro.	Pass	Matrox Parhelia LX
ASUS EN7800GTX 256MB (BIOS: V5.70.02.11.01)	PCIEX16_1	Win2000 Pro		nVidia GeForce 7800GTX
Leadtek WinFast PX6800GT TD256M Rev. C1 (BIOS: V5.40.02.32)	PCIEX16_1 PCIEX16_2	WinXP Pro. (CHT)	Pass	nVidia GeForce 6800GT
Elsa Gladiac PCX 935 Rev. W01-46W53 (BIOS: V4.35.20.45.E0)	PCIEX16_2	Win2003-64 R2 Enterprise	Pass	nVidia GeForce PCX5900

(continued on the next page)

Qualified graphics cards

Model	Connect Interface	OS Environment	Status	Chipset
Elsa Gladiac 660GT 128MB3 Rev: 2B (BIOS: V5.43.02.46.E1)	PCIEX16_1 PCIEX16_2	WinXP Pro.(CHT)	Pass	nVidia GeForce 6600GT
Elsa Gladiac 780GTX 256B3 (BIOS: V5.70.02.11.E1)	PCIEX16_1 PCIEX16_2	WinXP Pro.(CHT)	Pass	nVidia GeForce 7800GTX
Gecube RADEON X550 256M (BIOS:V008.015.028.000)	PCIEX16_1	WinXP Pro.	Pass	ATI Radeon X550
Gecube RADEON X1300PRO (BIOS: V133.A671B1.102)	PCIEX16_1	Win2003 R2 Standard (CHS)	Pass	ATI Radeon X1300RPO
Gigabyte GV-3D1-XL (BIOS: V5.43.02.46)	PCIEX16_1	WinXP Pro	Pass	nVidia GeForce 6600 (Dual GPU)
Gigabyte GV-NX66T128D (BIOS: V5.43.02.16)	PCIEX16_1	Win2003 R2 Enterprise (CHT)	Pass	nVidia GeForce 6600GT
Gigabyte GV-NX68T256D-B Rev: B (BIOS: V5.40.02.36.09)	PCIEX16_1	Win2000 Pro (CHT)	Pass	nVidia GeForce 6800
GIGABYTE-GV- NX79T256DBRH-256MX16 (BIOS5.71.22.12.02)	PCIEX16_1	WinXP-64 Pro.	Pass	nVIDIA GeForce 7900 GT
Gigabyte GV-RX70P128D Rev: 1.1 (BIOS: V009.004.001.032)	PCIEX16_1	Win2003-64 R2 Standard	Pass	ATI Radeon X700PRO
MSI NX7300GS-TD256E Rev.V200 (BIOS: V5.72.22.34.00)	PCIEX16_1	Win2003 R2 Enterprise	Pass	nVidia GeForce 7300GS
MSI RX600XT-TD128 Rev.V2.00 (BIOS: V8.015)	PCIEX16_2	WinXP Pro.	Pass	ATI Radeon X600XT
MSI RX700PRO-TD128E Rev.V2.00 (BIOS: V009.004.001.032)	PCIEX16_1	WinXP-64 Pro.	Pass	ATI Radeon X700PRO
PowerColor Radeon X1800XT (BIOS: V133.A52001.102)	PCIEX16_2	Win2003 R2 Enterprise	Pass	ATI Radeon X1800XT
Gigabyte GV-NX62TC256D8 (BIOS: V5.44.02.32)	PCIEX16_1	Win2003 R2 Standard	Pass	nVidia GeForce 6200TC
Leadtek WinFast PX6200 TD Rev. A1 (BIOS: V5.43.02.36.68)	PCIEX16_1	WinXP Home (JPN)		nVidia GeForce 6200
Xial S18Pro-DV256 (BIOS: V88.c0.00.12)	PCIEX16_1	Win2003-64 R2 Standard	Pass	S3 GammaChrome S18 Pro
MSI NX6600GT-TD128E Rev.V200 (BIOS: V5.43.02.16)	PCIEX16_1	WinXP Pro.	Pass	nVidia GeForce 6600GT

(continued on the next page)

Qualified graphics cards (Work station level)

Model Type: PCIEX16	Connect Interface	OS Environment	Status	Chipset
ASUS EN6600 128M Rev V1.00A (BIOS: V5.43.02.61)	PCIEX16_1	WinXP Pro. (CHT)	Pass	nVidia GeForce 6600
GIGABYTE GV-RX19X512VBRH (Bios:113A52021-104)	PCIEX16_2	WinXP-64 Pro.	Pass	ATI Radeon X1900XTX
Leadtek WinFast PX6200TC 64M Rev. A (BIOS: V5.44.02.18)	PCIEX16_1 PCIEX16_2	Win2000 Pro Win2003-64 R2 Enterprise	Pass	nVidia GeForce 6200 (with Turbo cache)
Leadtek WinFast PX6600GT TDH Rev. A (BIOS: V5.43.02.16)	PCIEX16_1	Win2000 Pro	Pass	nVidia GeForce 6600GT
Elsa Gladiac 660LE 256MB Rev: 3C (BIOS: V5.43.02.69.E2)	PCIEX16_2	WinXP Pro. (CHT)	Pass	nVidia GeForce 6600LE
ASUS EN6200TC128/T/16M Rev V1.01 (BIOS: V5.44.02.11)	PCIEX16_2	Win2003 R2 Standard (CHS)	Pass	nVidia GeForce 6200 (with Turbo cache)
ASUS EN6600 256M Rev. V1.00A (BIOS: V5.43.02.16.AS11)	PCIEX16_1	WinXP Pro. (CHT)	Pass	nVidia GeForce 6600
ASUS EN7800GT 256MB Rev: V1.00 (BIOS: V5.70.02.13.AS01)	PCIEX16_2	Win2003-64 R2 Standard	Pass	nVidia GeForce 7800GT
ATI FireMV2200 (BIOS: V113.A25915.100)	PCIEX16_1	Win2003-64 R2 Standard	Pass	ATI FireMV 2200
3Dlabs Wildcat Realizm 500 256M Rev. 08 (BIOS: V3.37)	PCIEX16_1	Win2003 R2 Standard (CHS)	Pass	3Dlabs Wildcat Realizm P25

Qualified RAID cards

SATA RAID controllers

Model Type: PCI	Connect Interface	OS Environment	Status	Chipset
Promise FastTrak S150 SX4-M (BIOS: V2.0.00.21)	PCI1	WinXP Pro.	Pass	Promise PDC20621
Promise FastTrak TX2200 (BIOS: V2.00.0.23)	PCI1	Win2003 R2 Standard (CHS)	Pass	Promise PDC20571
Promise FastTrak TX4200 (BIOS: V2.00.0.23)	PCI1	WinXP Pro.	Pass	Promise PDC40519

SCSI Disk controllers

Model Type: PCI	Connect Interface	OS Environment	Status	Chipset
Adaptec ASC-39320D Rev.B (BIOS: V4.00.0)	PCI1	WinXP Pro.	Pass	AIC-7902W
Model Type: PCI-X	Connect Interface	OS Environment	Status	Chipset
ASUS PXL-S30 Rev.1.04 (BIOS:V5.07.03)	PCIX_2	Win2003 R2 Standard	Pass	LSI LS153C1030

(continued on the next page)

SCSI RAID controllers

Model Type: PCI-X	Connect Interface	OS Environment	Status	Chipset
Intel SRCU42L (BIOS: V2.34.05-Ro43)	PCIX_2	WinXP Pro.	Pass	GC80303
Model Type: PCI	Connect Interface	OS Environment	Status	Chipset
Mylex AcceleRAID 170 Rev.A (BIOS: V6.01-30)	PCI1	Win2003 R2 Standard	Pass	GC80960RM100
Model Type: PCIEX8	Connect Interface	OS Environment	Status	Chipset
Intel SRCU42E Ultra320 (BIOS: H420)	PCIEX16_2	WinXP Pro.	Pass	Intel 80332

1000 BaseTx Ethernet Adapters

Model Type: PCI-X	Connect Interface	OS Environment	Status	Chipset
3Com 3C996B-T	PCIX_2	Win2000 Pro.	Pass	Broadcom BCM5701KHB
ASUS PXI-G45	PCIX_2	Win2000 Pro.	Pass	Intel RC82545EM

2.6 Jumper

Clear RTC RAM (CLRTC)

This jumper allows you to clear the Real Time Clock (RTC) RAM in CMOS. You can clear the CMOS memory of date, time, and system setup parameters by erasing the CMOS RTC RAM data. The onboard button cell battery powers the RAM data in CMOS, which include system setup information such as system passwords.

To erase the RTC RAM:

1. Turn OFF the computer and unplug the power cord.
2. Remove the onboard battery.
3. Move the jumper cap from pins 1-2 (default) to pins 2-3. Keep the cap on pins 2-3 for about 5~10 seconds, then move the cap back to pins 1-2.
4. Reinstall the battery.
5. Plug the power cord and turn ON the computer.
6. Hold down the key during the boot process and enter BIOS setup to re-enter data.



Except when clearing the RTC RAM, never remove the cap on CLRTC jumper default position. Removing the cap will cause system boot failure!

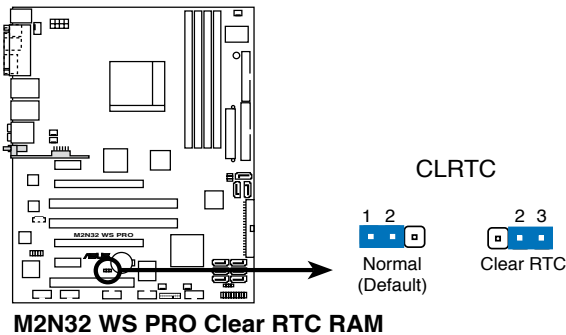

- Make sure to re-enter your previous BIOS settings after you clear the CMOS.
 - You do not need to clear the RTC when the system hangs due to overclocking. For system failure due to overclocking, use the C.P.R. (CPU Parameter Recall) feature. Shut down and reboot the system so the BIOS can automatically reset parameter settings to default values.
-

2. PCI-X Speed setting (6-pin PCIX_SPEED)

This jumper allows you to set the PCI-X slots' maximum frequency capability.

Default setting [Auto]: a single PCI-X card installed on a PCI-X slot can provide 133 MHz capability, and two PCI-X cards installed on both PCI-X slots can provide 100 MHz capability for reliability.

3~4: the slots will have 133 MHz capability whether you install one or two cards.

5~6: the slots will have 100 MHz capability whether you install one or two cards.

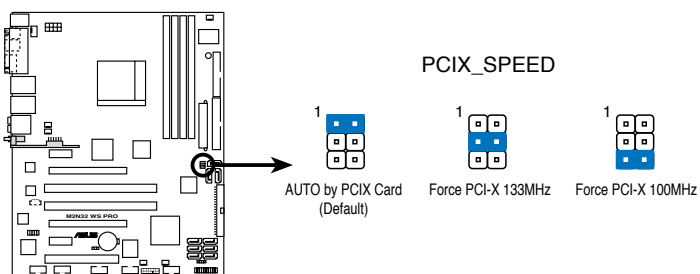

M2N32 WS PRO PCIX Speed setting

2.7 Connectors

2.7.1 Rear panel connectors

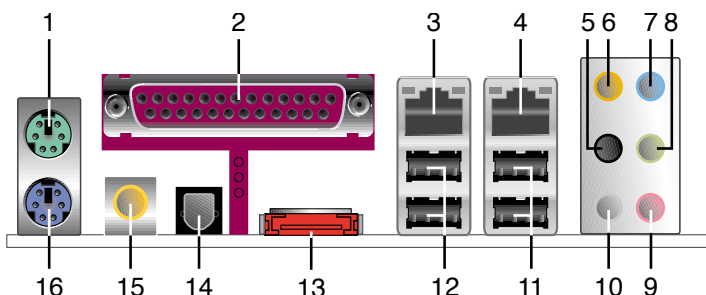

1. **PS/2 mouse port (green).** This port is for a PS/2 mouse.
2. **Parallel port.** This 25-pin port connects a parallel printer, a scanner, or other devices.
3. **LAN 1 (RJ-45) port.** Supported by Marvell® 88E1116 Gigabit LAN controller, this port allows Gigabit connection to a Local Area Network (LAN) through a network hub. Refer to the table below for the LAN port LED indications.
4. **LAN 2 (RJ-45) port.** Supported by the Marvell® 88E1116 Gigabit LAN controller, this port allows Gigabit connection to a Local Area Network (LAN) through a network hub. Refer to the table below for the LAN port LED indications.

LAN port LED indications

Activity/Link Speed LED			
Status	Description	Status	Description
OFF	No link	OFF	10 Mbps connection
ORANGE	Linked	ORANGE	100 Mbps connection
BLINKING	Data activity	GREEN	1 Gbps connection

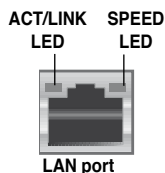

5. **Rear Speaker Out port (black).** This port connects the rear speakers in a 4-channel, 6-channel, or 8-channel audio configuration.
6. **Center/Subwoofer port (orange).** This port connects the center/subwoofer speakers.
7. **Line In port (light blue).** This port connects the tape, CD, DVD player, or other audio sources.
8. **Line Out port (lime).** This port connects a headphone or a speaker. In 4-channel, 6-channel, and 8-channel configuration, the function of this port becomes Front Speaker Out.

9. **Microphone port (pink).** This port connects a microphone.
10. **Side Speaker Out port (gray).** This port connects the side speakers in an 8-channel audio configuration.



Refer to the audio configuration table below for the function of the audio ports in 2, 4, 6, or 8-channel configuration.

Audio 2, 4, 6, or 8-channel configuration

Port	Headset 2-channel	4-channel	6-channel	8-channel
Light Blue	Line In	Line In	Line In	Line In
Lime	Line Out	Front Speaker Out	Front Speaker Out	Front Speaker Out
Pink	Mic In	Mic In	Mic In	Mic In
Gray	–	–	–	Side Speaker Out
Black	–	Rear Speaker Out	Rear Speaker Out	Rear Speaker Out
Orange	–	–	Center/Subwoofer	Center/Subwoofer

11. **USB 2.0 ports 1 and 2.** These two 4-pin Universal Serial Bus (USB) ports are available for connecting USB 2.0 devices.
12. **USB 2.0 ports 3 and 4.** These two 4-pin Universal Serial Bus (USB) ports are available for connecting USB 2.0 devices.
13. **External SATA port.** This port connects to an external SATA box or a Serial ATA port multiplier.



The external SATA port supports external Serial ATA 3.0 Gb/s devices. Longer cables support higher power requirements to deliver signal up to two meters away, and enables improved hot-swap function.

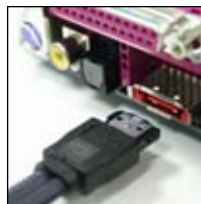

14. **Optical S/PDIF Out port.** This port connects an external audio output device via an optical S/PDIF cable.
15. **Coaxial S/PDIF Out port.** This port connects an external audio output device via a coaxial S/PDIF cable.
16. **PS/2 keyboard port (purple).** This port is for a PS/2 keyboard.

2.7.2 Internal connectors

1. Floppy disk drive connector (34-1 pin FLOPPY)

This connector is for the provided floppy disk drive (FDD) signal cable. Insert one end of the cable to this connector, then connect the other end to the signal connector at the back of the floppy disk drive.



Pin 5 on the connector is removed to prevent incorrect cable connection when using a FDD cable with a covered Pin 5.

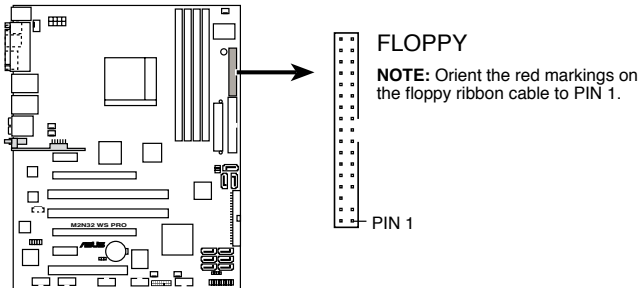

M2N32 WS PRO Floppy disk drive connector

2. NVIDIA® IDE connector (40-1 pin PRI_IDE)

The onboard IDE connector is for the Ultra DMA (133/100/66) signal cable. There are three connectors on each Ultra DMA 133/100/66 signal cable: blue, black, and gray. Connect the blue connector to the motherboard's IDE connector, then select one of the following modes to configure your device.

	Drive jumper setting	Mode of device(s)	Cable connector
Single device	Cable-Select or Master	-	Black
Two devices	Cable-Select	Master	Black
		Slave	Gray
	Master	Master	Black or gray
	Slave	Slave	



- Pin 20 on the IDE connector is removed to match the covered hole on the Ultra DMA cable connector. This prevents incorrect insertion when you connect the IDE cable.
- Use the 80-conductor IDE cable for Ultra DMA 100/66 IDE devices.



If any device jumper is set as "Cable-Select," make sure all other device jumpers have the same setting.

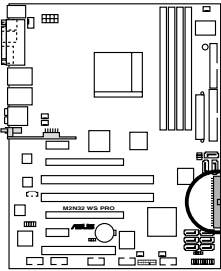

M2N32 WS PRO IDE connector



PRI_IDE

NOTE: Orient the red markings (usually zigzag) on the IDE ribbon cable to PIN 1.

3. Marvell® IDE connector (40-1 pin PRI_EIDE)

This connector is for the Ultra DMA 133/100/66 signal cable. The Marvell IDE connector supports up to 2 IDE hard disk drives for easier data storage.

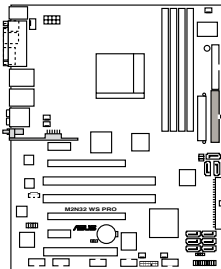

M2N32 WS PRO IDE connectors



PRI_EIDE

NOTE: Orient the red markings (usually zigzag) on the IDE ribbon cable to PIN 1.

PIN 1

4. **NVIDIA® nForce® 590 SLI Southbridge Serial ATA connectors (7-pin SATA1 [red], SATA2 [red], SATA3 [red], SATA4 [red], SATA5 [red], SATA6 [red])**

These connectors are for the Serial ATA signal cables for Serial ATA 3.0 Gb/s hard disk and optical disk drives. The Serial ATA 3.0 Gb/s is backward compatible with Serial ATA 1.5 Gb/s specification.

If you installed Serial ATA hard disk drives, you can create a RAID 0, RAID 1, RAID 0+1, RAID 5, or JBOD configuration through the onboard NVIDIA® MediaShield™ controller.



The RAID function of these connectors is set to [Disabled] by default. If you intend to create a Serial ATA RAID set using these connectors, enable the **RAID Enabled** item in the SATA Configuration sub-menu in the BIOS. See section "4.4.7 Onboard Device Configuration" for details.

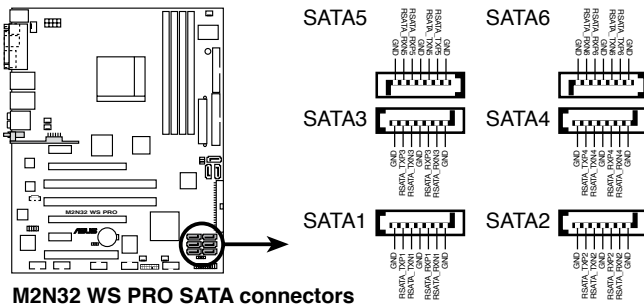

M2N32 WS PRO SATA connectors

**5. Marvell® 88SE614x Serial ATA connectors
(7-pin EXT_SATA1, EXT_SATA2, EXT_SATA3)**

These connectors are for Serial ATA signal cables. These connectors support Serial ATA hard disk drives.

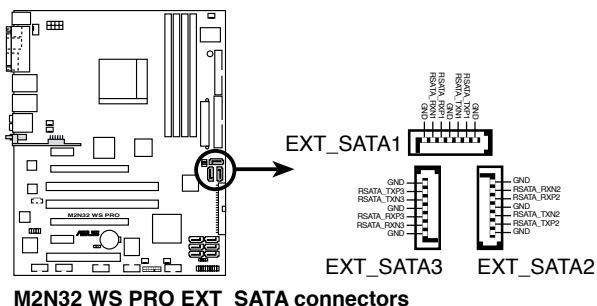

6. USB connectors (10-1 pin USB56, USB78, USB910)

These connectors are for USB 2.0 ports. Connect the USB/GAME module cable to any of these connectors, then install the module to a slot opening at the back of the system chassis. These USB connectors comply with USB 2.0 specification that supports up to 480 Mbps connection speed.

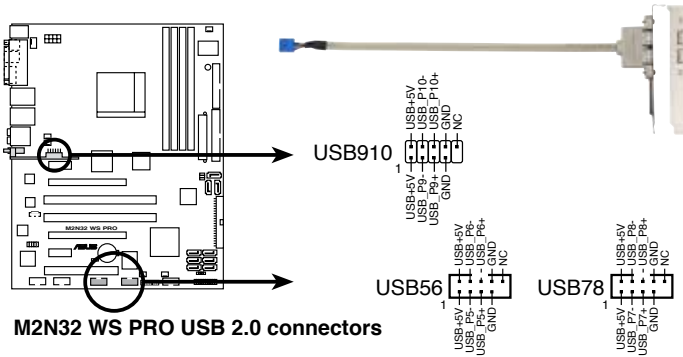

M2N32 WS PRO USB 2.0 connectors



Never connect a 1394 cable to the USB connectors. Doing so will damage the motherboard!

7. IEEE 1394a port connectors (10-1 pin IE1394_1; 10-1 pin IE1394_2)

These connectors are for IEEE 1394a ports. Connect the IEEE 1394a module cables to any of these connectors, then install the module to a slot opening at the back of the system chassis.

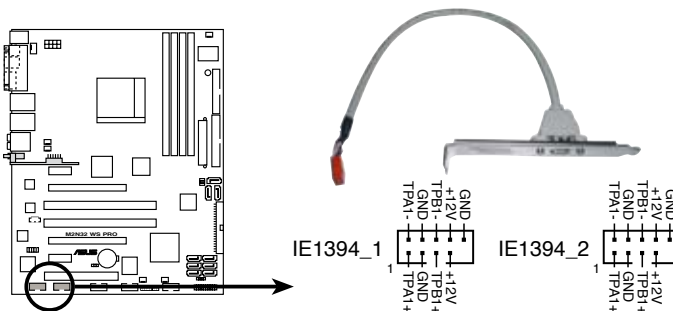

M2N32 WS PRO IEEE 1394a connector



Never connect a USB cable to the IEEE 1394a connector. Doing so will damage the motherboard!

8. CPU, Chassis, and Power Fan connectors
(4-pin CPU_FAN, 3-pin CHA_FAN1, 3-pin CHA_FAN2, 3-pin CHA_FAN3, 3-pin CHA_FAN4, 3-pin SPS_FAN1)

The fan connectors support cooling fans of 350 mA ~ 2000 mA (24 W max.) or a total of 1 A ~ 3.48 A (41.76 W max.) at +12V. Connect the fan cables to the fan connectors on the motherboard, making sure that the black wire of each cable matches the ground pin of the connector.



Do not forget to connect the fan cables to the fan connectors. Insufficient air flow inside the system may damage the motherboard components. These are not jumpers! Do not place jumper caps on the fan connectors!

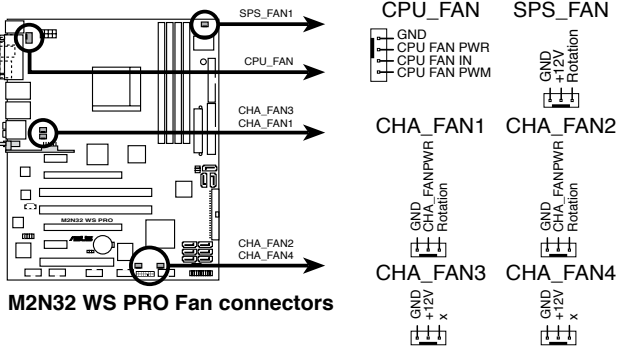

9. Chassis intrusion connector (4-1 pin CHASSIS)

This connector is for a chassis-mounted intrusion detection sensor or switch. Connect one end of the chassis intrusion sensor or switch cable to this connector. The chassis intrusion sensor or switch sends a high-level signal to this connector when a chassis component is removed or replaced. The signal is then generated as a chassis intrusion event.

By default, the pins labeled “Chassis Signal” and “Ground” are shorted with a jumper cap. Remove the jumper caps only when you intend to use the chassis intrusion detection feature.

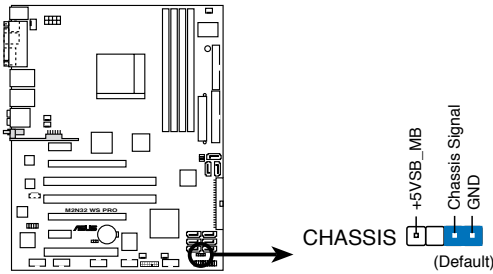

M2N32 WS PRO Chassis intrusion connector

10. ATX power connectors (24-pin EATXPWR, 8-pin EATX12V)

These connectors are for ATX power supply plugs. The power supply plugs are designed to fit these connectors in only one orientation. Find the proper orientation and push down firmly until the connectors completely fit.

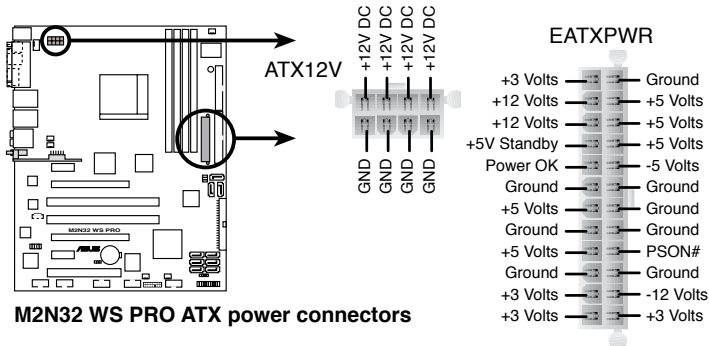

M2N32 WS PRO ATX power connectors



- For a fully configured system, we recommend that you use a power supply unit (PSU) that complies with ATX 12 V Specification 2.0 (or later version) and provides a minimum power of 600 W.
- Do not forget to connect the 4-pin ATX +12 V power plug; otherwise, the system will not boot.
- Use of a PSU with a higher power output is recommended when configuring a system with more power-consuming devices. The system may become unstable or may not boot up if the power is inadequate.

11. Front panel audio connector (10-1 pin AAFP)

This connector is for a chassis-mounted front panel audio I/O module that supports either HD Audio or legacy AC'97 audio standard. Connect one end of the front panel audio I/O module cable to this connector.

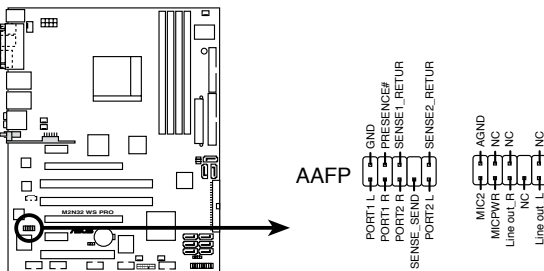

M2N32 WS PRO Analog front panel connector



- We recommend that you connect a high-definition front panel audio module to this connector to avail of the motherboard's high-definition audio capability.
- By default, this connector is set to AC97. If you want to connect a legacy AC97 front panel audio module to this connector, set the **Front Panel Support Type** item in the BIOS to [HD Audio]. See section "4.4.7 Onboard Device Configuration" for details.

12. Internal audio connector (4-pin CD [Black])

These connectors allow you to receive stereo audio input from sound sources such as a CD-ROM, TV tuner, or MPEG card.

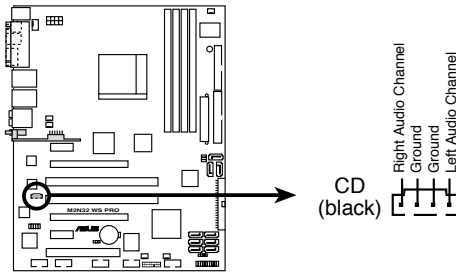

M2N32 WS PRO Internal audio connector

13 Serial port connector (10-1 pin COM1)

This connector is for a serial (COM) port. Connect the serial port module cable to this connector, then install the module to a slot opening at the back of the system chassis.

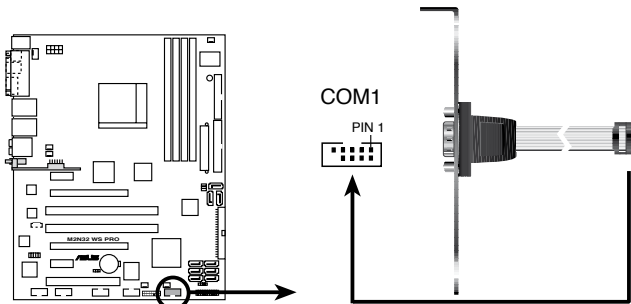

M2N32 WS PRO COM port connector

14. TPM connector (20-1 pin TPM)

This connector supports a Trusted Platform Module (TPM) system, which can securely store keys, digital certificates, passwords, and data. A TPM system also helps enhance network security, protects digital identities, and ensures platform integrity.

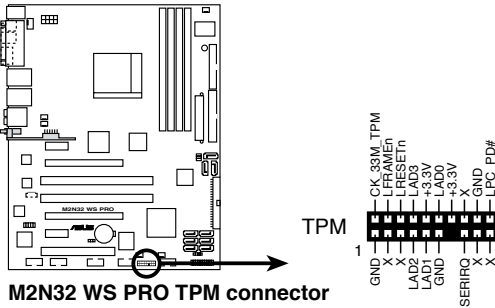

M2N32 WS PRO TPM connector



The TPM module is purchased separately.

15. System panel connector (20-pin PANEL)

This connector supports several chassis-mounted functions.

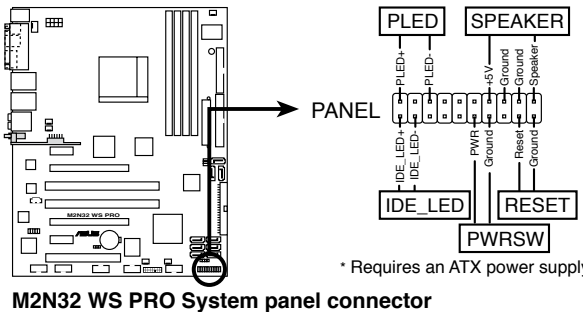

M2N32 WS PRO System panel connector

- **System power LED (2-pin PLED)**

This 3-pin connector is for the system power LED. Connect the chassis power LED cable to this connector. The system power LED lights up when you turn on the system power, and blinks when the system is in sleep mode.

- **Hard disk drive activity LED (2-pin IDE_LED)**

This 2-pin connector is for the HDD Activity LED. Connect the HDD Activity LED cable to this connector. The IDE LED lights up or flashes when data is read from or written to the HDD.

- **System warning speaker (4-pin SPEAKER)**

This 4-pin connector is for the chassis-mounted system warning speaker. The speaker allows you to hear system beeps and warnings.

- **ATX power button/soft-off button (2-pin PWR)**

This connector is for the system power button. Pressing the power button turns the system on or puts the system in sleep or soft-off mode depending on the BIOS settings. Pressing the power switch for more than four seconds while the system is ON turns the system OFF.

- **Reset button (2-pin RESET)**

This 2-pin connector is for the chassis-mounted reset button for system reboot without turning off the system power.

This chapter describes the power up sequence and ways of shutting down the system.

Powering up **3**

Chapter summary

3

3.1	Starting up for the first time.....	3-1
3.2	Powering off the computer.....	3-2

3.1 Starting up for the first time

1. After making all the connections, replace the system case cover.
2. Be sure that all switches are off.
3. Connect the power cord to the power connector at the back of the system chassis.
4. Connect the power cord to a power outlet that is equipped with a surge protector.
5. Turn on the devices in the following order:
 - a. Monitor
 - b. External SCSI devices (starting with the last device on the chain)
 - c. System power
6. After applying power, the system power LED on the system front panel case lights up. For systems with ATX power supplies, the system LED lights up when you press the ATX power button. If your monitor complies with “green” standards or if it has a “power standby” feature, the monitor LED may light up or switch between orange and green after the system LED turns on.

The system then runs the power-on self tests or POST. While the tests are running, the BIOS beeps or additional messages appear on the screen. If you do not see anything within 30 seconds from the time you turned on the power, the system may have failed a power-on test. Check the jumper settings and connections or call your retailer for assistance.
7. At power on, hold down the <Delete> key to enter the BIOS Setup. Follow the instructions in Chapter 4.

3.2 Powering off the computer

3.2.1 Using the OS shut down function

If you are using Windows® 2000:

1. Click the Start button then click Shut Down...
2. Make sure that the Shut Down option button is selected, then click the OK button to shut down the computer.
3. The power supply should turn off after Windows® shuts down.

If you are using Windows® XP:

1. Click the Start button then select Turn Off Computer.
2. Click the Turn Off button to shut down the computer.
3. The power supply should turn off after Windows® shuts down.

3.2.2 Using the dual function power switch

While the system is ON, pressing the power switch for less than four seconds puts the system to sleep mode or to soft-off mode, depending on the BIOS setting. Pressing the power switch for more than four seconds lets the system enter the soft-off mode regardless of the BIOS setting. Refer to section “4.5 Power Menu” in Chapter 4 for details.

This chapter tells how to change the system settings through the BIOS Setup menus. Detailed descriptions of the BIOS parameters are also provided.

BIOS setup 4

4.1	Managing and updating your BIOS	4-1
4.2	BIOS setup program	4-10
4.3	Main menu	4-14
4.4	Advanced menu	4-19
4.5	Power menu.....	4-34
4.6	Boot menu	4-38
4.7	Tools menu	4-43
4.8	Exit menu.....	4-48

4.1 Managing and updating your BIOS

The following utilities allow you to manage and update the motherboard Basic Input/Output System (BIOS) setup.

1. **ASUS Update** (Updates the BIOS in Windows® environment.)
2. **ASUS EZ Flash 2** (Updates the BIOS in DOS using a floppy disk or the motherboard support CD.)
3. **Award BIOS Flash Utility** (Updates the BIOS in DOS mode using a bootable floppy disk.)
4. **ASUS CrashFree BIOS 3** (Updates the BIOS using a bootable floppy disk or the motherboard support CD when the BIOS file fails or gets corrupted.)

Refer to the corresponding sections for details on these utilities.



Save a copy of the original motherboard BIOS file to a bootable floppy disk in case you need to restore the BIOS in the future. Copy the original motherboard BIOS using the ASUS Update or Award BIOS Flash utilities.

4.1.1 ASUS Update utility

The ASUS Update is a utility that allows you to manage, save, and update the motherboard BIOS in Windows® environment. The ASUS Update utility allows you to:

- Save the current BIOS file
- Download the latest BIOS file from the Internet
- Update the BIOS from an updated BIOS file
- Update the BIOS directly from the Internet, and
- View the BIOS version information.

This utility is available in the support CD that comes with the motherboard package.



ASUS Update requires an Internet connection either through a network or an Internet Service Provider (ISP).

Installing ASUS Update

To install ASUS Update:

1. Place the support CD in the optical drive. The Drivers menu appears.
2. Click the Utilities tab, then click Install ASUS Update VX.XX.XX. See page 5-3 for the Utilities screen menu.
3. The ASUS Update utility is copied to your system.



Quit all Windows® applications before you update the BIOS using this utility.

Updating the BIOS through the Internet

To update the BIOS through the Internet:

1. Launch the ASUS Update utility from the Windows® desktop by clicking **Start > Programs > ASUS > ASUSUpdate > ASUSUpdate**. The ASUS Update main window appears.

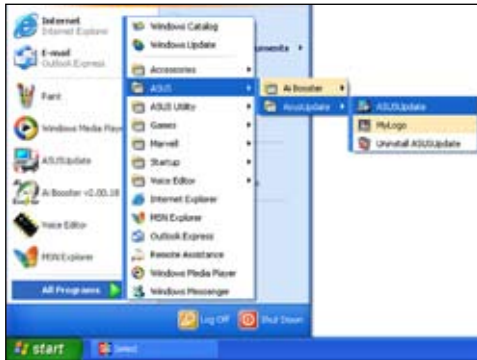

2. Select Update BIOS from the Internet option from the drop-down menu, then click Next.



3. Select the ASUS FTP site nearest you to avoid network traffic, or click Auto Select. Click Next.

- From the FTP site, select the BIOS version that you wish to download. Click Next.
- Follow the screen instructions to complete the update process.



The ASUS Update utility is capable of updating itself through the Internet. Always update the utility to avail all its features.



Updating the BIOS through a BIOS file

To update the BIOS through a BIOS file:

- Launch the ASUS Update utility from the Windows® desktop by clicking Start > Programs > ASUS > ASUSUpdate > ASUSUpdate. The ASUS Update main window appears.
- Select Update BIOS from a file option from the drop-down menu, then click Next.



- Locate the BIOS file from the Open window, then click Open.
- Follow the screen instructions to complete the update process.

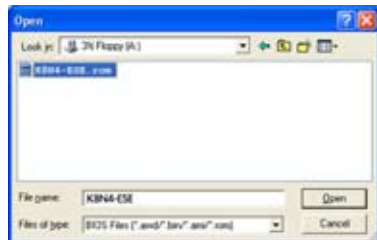

4.1.2 Creating a bootable floppy disk

1. Do either one of the following to create a bootable floppy disk.

DOS environment

- a. Insert a 1.44MB floppy disk into the drive.
- b. At the DOS prompt, type `format A: /s` then press <Enter>.

Windows® XP environment

- a. Insert a 1.44 MB floppy disk to the floppy disk drive.
- b. Click **Start** from the Windows® desktop, then select **My Computer**.
- c. Select the 3 1/2 Floppy Drive icon.
- d. Click File from the menu, then select **Format. A Format 3 1/2 Floppy Disk** window appears.
- e. Select **Create an MS-DOS startup disk** from the format options field, then click **Start**.

Windows® 2000 environment

To create a set of boot disks for Windows® 2000:

- a. Insert a formatted, high density 1.44 MB floppy disk into the drive.
- b. Insert the Windows® 2000 CD to the optical drive.
- c. Click **Start**, then select **Run**.
- d. From the Open field, type
`D:\bootdisk\makeboot a:`
assuming that D: is your optical drive.
- e. Press <Enter>, then follow screen instructions to continue.

2. Copy the original or the latest motherboard BIOS file to the bootable floppy disk.

4.1.3 ASUS EZ Flash 2 utility

The ASUS EZ Flash 2 feature allows you to update the BIOS without having to go through the long process of booting from a floppy disk and using a DOS-based utility. The EZ Flash utility is built-in the BIOS chip so it is accessible by pressing <Alt> + <F2> during the Power-On Self Tests (POST).

To update the BIOS using EZ Flash 2:

1. Visit the ASUS website (www.asus.com) to download the latest BIOS file for the motherboard.
2. Save the BIOS file to a floppy disk, then restart the system.
3. You can launch the EZ Flash 2 by two methods.

(1) Insert the floppy disk/USB flash disk that contains the BIOS file to the floppy disk drive or the USB port.

Press <Alt> + <F2> during POST to display the following.

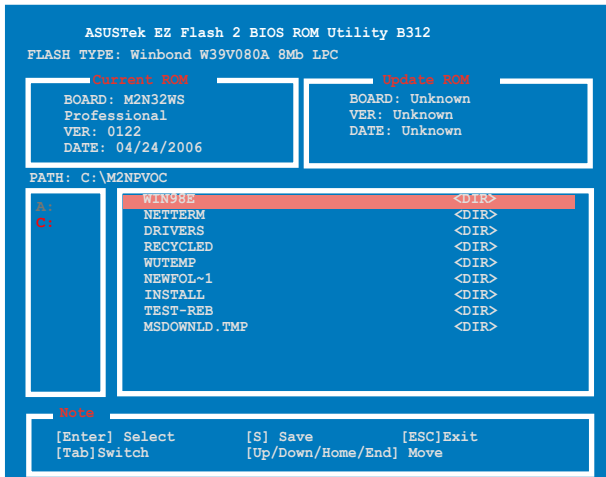

- (2) Enter BIOS setup program. Go to the Tools menu to select EZ Flash 2 and press <Enter> to enable it.

You can switch between drives by pressing <Tab> before the correct file is found. Then press <Enter>.

4. When the correct BIOS file is found, EZ Flash 2 performs the BIOS update process and automatically reboots the system when down.



- This function can support devices such as USB flash disk, hard disk, or floppy disk with FAT32/16/12 format only.
- Do not shut down or reset the system while updating the BIOS to prevent system boot failure!

4.1.4 Updating the BIOS

The Basic Input/Output System (BIOS) can be updated using the AwardBIOS Flash Utility. Follow these instructions to update the BIOS using this utility.

1. Download the latest BIOS file from the ASUS web site. Rename the file to M2N32-WS.BIN and save it to a floppy disk, CD ROM or a USB flash disk in FAT 16/12 format.



Save only the updated BIOS file in the floppy disk to avoid loading the wrong BIOS file.

2. Copy the AwardBIOS Flash Utility (awdfash.exe) from the Software folder of the support CD to the floppy disk, CD ROM or a USB flash disk with the latest BIOS file.
3. Boot the system in DOS mode using the bootable floppy disk, CD ROM or a USB flash disk you created earlier.
4. Under the DOS mode, use <X:> (X stands for the name of the disk assignment) to switch to the folder of floppy disk, CD ROM or USB flash disk you saved the BIOS file and Award BIOS Flash Utility.
5. At the prompt, type awdfash then press <Enter>. The Award BIOS Flash Utility screen appears.

```
AwardBIOS Flash Utility for ASUS V1.14
(C) Phoenix Technologies Ltd. All Rights Reserved

For C51XEMCP55PXE-M2N32-WS-00    DATE:04/13/2006
Flash Type - Unknown Flash

File Name to Program: 

Message: Please input File Name!
```

6. Type the BIOS file name in the File Name to Program field, then press <Enter>.

```
AwardBIOS Flash Utility for ASUS V1.14
(C) Phoenix Technologies Ltd. All Rights Reserved

For C51XEMCP55PXE-M2N32-WS-00    DATE:04/13/2006
Flash Type - Unknown Flash

File Name to Program: 0104.bin

Message: Do You Want To Save Bios (Y/N)
```

- Press <N> when the utility prompts you to save the current BIOS file. The following screen appears.
- The utility verifies the BIOS file in the floppy disk, CD ROM or a USB flash disk and starts flashing the BIOS file.

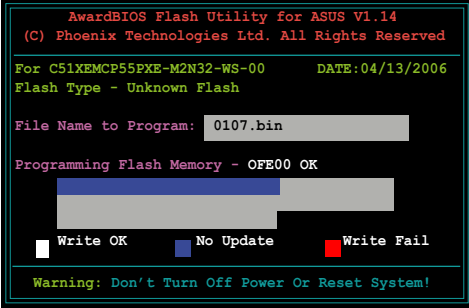

```
AwardBIOS Flash Utility for ASUS V1.14
(C) Phoenix Technologies Ltd. All Rights Reserved

For C51XEMCP55PXE-M2N32-WS-00    DATE:04/13/2006
Flash Type - Unknown Flash

File Name to Program: 0107.bin

Programming Flash Memory - OFE00 OK

Write OK      No Update      Write Fail

Warning: Don't Turn Off Power Or Reset System!
```



Do not turn off or reset the system during the flashing process!

- The utility displays a Flashing Complete message indicating that you have successfully flashed the BIOS file. Remove the floppy disk then press <F1> to restart the system.

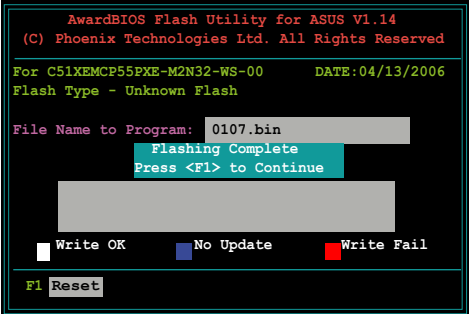

```
AwardBIOS Flash Utility for ASUS V1.14
(C) Phoenix Technologies Ltd. All Rights Reserved

For C51XEMCP55PXE-M2N32-WS-00    DATE:04/13/2006
Flash Type - Unknown Flash

File Name to Program: 0107.bin

Flashing Complete
Press <F1> to Continue

Write OK      No Update      Write Fail

F1 Reset
```

4.1.5 Saving the current BIOS file

You can use the AwardBIOS Flash Utility to save the current BIOS file. You can load the current BIOS file when the BIOS file gets corrupted during the flashing process.



Make sure that the floppy disk, CD ROM or a USB flash disk has enough disk space to save the file.

To save the current BIOS file using the AwardBIOS Flash Utility:

1. Follow steps 1 to 6 of the previous section.
2. Press <Y> when the utility prompts you to save the current BIOS file. The following screen appears.

```
AwardBIOS Flash Utility for ASUS V1.14
(C) Phoenix Technologies Ltd. All Rights Reserved

For C51XEMCP55PXE-M2N32-WS-00    DATE:04/13/2006
Flash Type - Unknown Flash

File Name to Program: 0107.bin
Save current BIOS as:

Message:
```

3. Type a filename for the current BIOS file in the Save current BIOS as field, then press <Enter>.

```
AwardBIOS Flash Utility for ASUS V1.14
(C) Phoenix Technologies Ltd. All Rights Reserved

For C51XEMCP55PXE-M2N32-WS-00    DATE:04/13/2006
Flash Type - Unknown Flash

File Name to Program:
Checksum: D800H
Save current BIOS as:

Message: Please Wait!
```

4. The utility saves the current BIOS file to the floppy disk, then returns to the BIOS flashing process.

```
AwardBIOS Flash Utility for ASUS V1.14
(C) Phoenix Technologies Ltd. All Rights Reserved

For C51XEMCP55PXE-M2N32-WS-00    DATE:04/13/2006
Flash Type - Unknown Flash

File Name to Program: 0107.bin
Now Backup System BIOS to
File!

Message: Please Wait!
```

4.1.6 ASUS CrashFree BIOS 3 utility

The ASUS CrashFree BIOS 3 is an auto recovery tool that allows you to restore the BIOS file when it fails or gets corrupted during the updating process. You can update a corrupted BIOS file using the motherboard support CD or the floppy disk that contains the updated BIOS file.



Prepare the motherboard support CD or the floppy disk containing the updated motherboard BIOS before using this utility.

Recovering the BIOS from the support CD

To recover the BIOS from the support CD:

1. Turn on the system.
2. Insert the motherboard support CD to the optical drive.
3. The utility displays the following message and automatically checks the CD for the BIOS file.

```
Award BootBlock BIOS v1.0
Copyright (c) 2000, Award Software, Inc.

BIOS ROM checksum error
Detecting IDE ATAPI device...
```

When found, the utility reads the BIOS file and starts flashing the corrupted BIOS file.

```
Award BootBlock BIOS v1.0
Copyright (c) 2000, Award Software, Inc.

BIOS ROM checksum error
Detecting IDE ATAPI device...
Found CDROM, try to Boot from it... Pass
```

4. Restart the system after the utility completes the updating process.

Recovering the BIOS from the USB flash disk

To recover the BIOS from the USB flash disk:

1. Insert the USB flash disk that contains BIOS file to the USB port.
2. Turn on the system.
3. The utility will automatically checks the devices for the BIOS file. When found, the utility reads the BIOS file and starts flashing the corrupted BIOS file.
4. Restart the system after the utility completes the updating process.



- Only the USB flash disk with FAT 32/16/12 format and single partition can support ASUS CrashFree BIOS 3. The device size should be smaller than 8GB.
 - DO NOT shut down or reset the system while updating the BIOS! Doing so can cause system boot failure!
-

4.2 BIOS setup program

This motherboard supports a programmable Low-Pin Count (LPC) chip that you can update using the provided utility described in section “4.1 Managing and updating your BIOS.”

Use the BIOS Setup program when you are installing a motherboard, reconfiguring your system, or prompted to “Run Setup.” This section explains how to configure your system using this utility.

Even if you are not prompted to use the Setup program, you can change the configuration of your computer in the future. For example, you can enable the security password feature or change the power management settings. This requires you to reconfigure your system using the BIOS Setup program so that the computer can recognize these changes and record them in the CMOS RAM of the LPC chip.

The LPC chip on the motherboard stores the Setup utility. When you start up the computer, the system provides you with the opportunity to run this program. Press during the Power-On Self-Test (POST) to enter the Setup utility; otherwise, POST continues with its test routines.

If you wish to enter Setup after POST, restart the system by pressing <Ctrl+Alt+Delete>, or by pressing the reset button on the system chassis. You can also restart by turning the system off and then back on. Do this last option only if the first two failed.

The Setup program is designed to make it as easy to use as possible. Being a menu-driven program, it lets you scroll through the various sub-menus and make your selections from the available options using the navigation keys.



-
- The default BIOS settings for this motherboard apply for most conditions to ensure optimum performance. If the system becomes unstable after changing any BIOS settings, load the default settings to ensure system compatibility and stability. Select the **Load Default Settings** item under the Exit Menu. See section “4.8 Exit Menu.”
 - The BIOS setup screens shown in this section are for reference purposes only, and may not exactly match what you see on your screen.
 - Visit the ASUS website (www.asus.com) to download the latest BIOS file for this motherboard.
-

4.2.1 BIOS menu screen

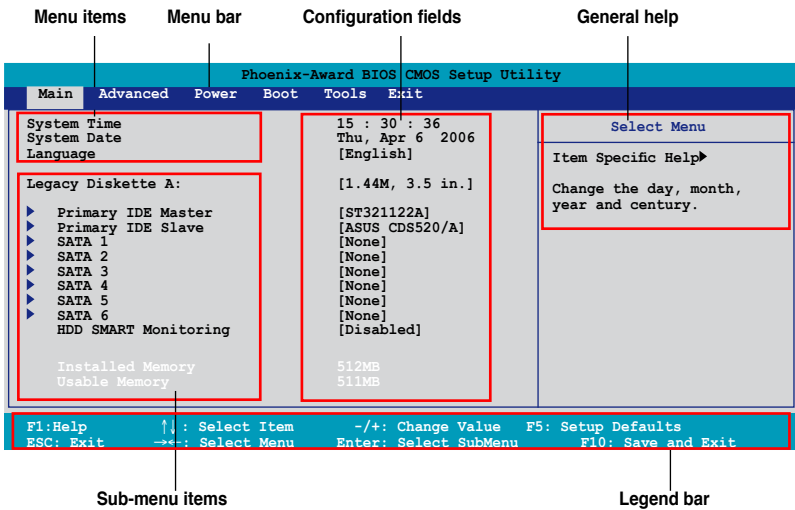

4.2.2 Menu bar

The menu bar on top of the screen has the following main items:

Main	For changing the basic system configuration
Advanced	For changing the advanced system settings
Power	For changing the advanced power management (APM) configuration
Boot	For changing the system boot configuration
Tools	For changing the system tools configuration
Exit	For selecting the exit options and loading default settings

To select an item on the menu bar, press the right or left arrow key on the keyboard until the desired item is highlighted.



- The BIOS setup screens shown in this chapter are for reference purposes only, and may not exactly match what you see on your screen.
- Visit the ASUS website (www.asus.com) to download the latest BIOS information.

4.2.3 Legend bar

At the bottom of the Setup screen is a legend bar. The keys in the legend bar allow you to navigate through the various setup menus. The following table lists the keys found in the legend bar with their corresponding functions.

Navigation Key	Function
<F1>	Displays the General Help screen
<F5>	Loads setup default values
<Esc>	Exits the BIOS setup or returns to the main menu from a sub-menu
Left or Right arrow	Selects the menu item to the left or right
Up or Down arrow	Moves the highlight up or down between fields
Page Down or - (minus)	Scrolls backward through the values for the highlighted field
Page Up or + (plus)	Scrolls forward through the values for the highlighted field
<Enter>	Brings up a selection menu for the highlighted field
<F10>	Saves changes and exit

4.2.4 Menu items

The highlighted item on the menu bar displays the specific items for that menu. For example, selecting **Main** shows the Main menu items.

The other items (Advanced, Power, Boot, and Exit) on the menu bar have their respective menu items.

4.2.5 Sub-menu items

A solid triangle before each item on any menu screen means that the item has a sub-menu. To display the sub-menu, select the item and press <Enter>.

4.2.6 Configuration fields

These fields show the values for the menu items. If an item is user-configurable, you can change the value of the field opposite the item. You cannot select an item that is not user-configurable.

A configurable field is enclosed in brackets, and is highlighted when selected. To change the value of a field, select it then press <Enter> to display a list of options. Refer to "4.2.7 Pop-up window."

4.2.7 Pop-up window

Select a menu item then press <Enter> to display a pop-up window with the configuration options for that item.

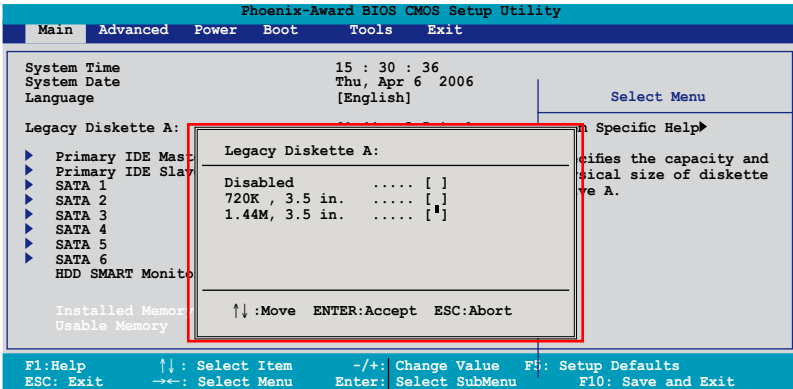

Pop-up menu

4.2.8 General help

At the top right corner of the menu screen is a brief description of the selected item.

4.3 Main menu

When you enter the BIOS Setup program, the Main menu screen appears, giving you an overview of the basic system information.



Refer to section “4.2.1 BIOS menu screen” for information on the menu screen items and how to navigate through them.

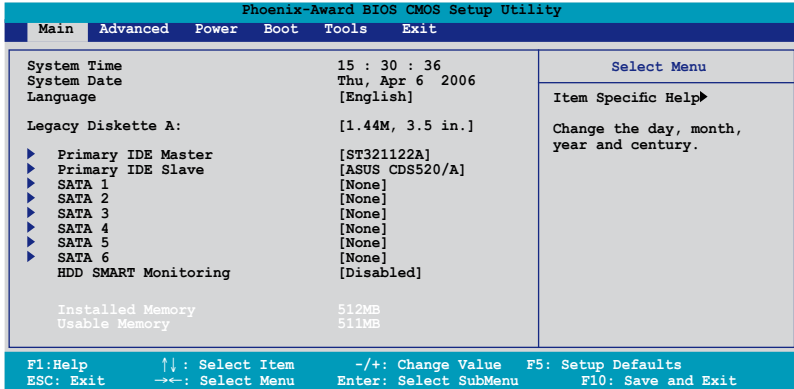

4.3.1 System Time [xx:xx:xx]

Allows you to set the system time.

4.3.2 System Date [Day xx/xx/xxxx]

Allows you to set the system date.

4.3.3 Language [English]

Allows you to choose the BIOS language version from the options. Configuration options: [English] [French] [Deutsch] [Chines (Trad.)] [Chinese (Simp.)] [Japanese]

4.3.4 Legacy Diskette A [1.44M, 3.5 in.]

Sets the type of floppy drive installed.

Configuration options: [None] [720K , 3.5 in.] [1.44M, 3.5 in.]

4.3.5 Primary IDE Master/Slave

While entering Setup, the BIOS automatically detects the presence of IDE devices. There is a separate sub-menu for each IDE device. Select a device item then press <Enter> to display the IDE device information.

Phoenix-Award BIOS CMOS Setup Utility			
Main			
Primary IDE Master		Select Menu	
PIO Mode	[Auto]	Item Specific Help▶▶ Set a PIO mode for IDE device. Mode0 through 4 for successive increase in performance.	
UDMA Mode	[Auto]		
Primary IDE Master Access Mode	[Auto]		
Capacity	82 GB		
Cylinder	39420		
Head	16		
Sector	255		
Transfer Mode	UDMA 5		
F1: Help ↑↓ : Select Item -/+ : Change Value F5: Setup Defaults			
ESC: Exit →← : Select Menu Enter: Select SubMenu F10: Save and Exit			

The BIOS automatically detects the values opposite the dimmed items (Capacity, Cylinder, Head, Sector and Transfer Mode). These values are not user-configurable. These items show N/A if no IDE device is installed in the system.

PIO Mode [Auto]

Sets the PIO mode for the IDE device.

Configuration options: [Auto] [Mode 0] [Mode 1] [Mode 2] [Mode 3] [Mode 4]

UDMA Mode [Auto]

Disables or sets the UDMA mode. Configuration options: [Disabled] [Auto]

Primary IDE Master/Slave [Auto]

Select [Auto] to automatically detect an IDE hard disk drive. If automatic detection is successful, the BIOS automatically fills in the correct values for the remaining fields on this sub-menu. If the hard disk was already formatted on a previous system, the setup BIOS may detect incorrect parameters. Select [Manual] to manually enter the IDE hard disk drive parameters. If no drive is installed select [None]. Configuration options: [None] [Auto] [Manual]

Access Mode [Auto]

The default [Auto] allows automatic detection of an IDE hard disk drive. Select [CHS] for this item if you set the IDE Primary Master/Slave to [Manual]. Configuration options: [CHS] [LBA] [Large] [Auto]



Before attempting to configure a hard disk drive, make sure you have the correct configuration information supplied by the drive manufacturer. Incorrect settings may cause the system to fail to recognize the installed hard disk.

Capacity

Displays the auto-detected hard disk capacity. This item is not configurable.

Cylinder

Shows the number of the hard disk cylinders. This item is not configurable.

Head

Shows the number of the hard disk read/write heads. This item is not configurable.

Sector

Shows the number of sectors per track. This item is not configurable.

Transfer Mode

Shows the Transfer mode. This item is not configurable.



After entering the IDE hard disk drive information into BIOS, use a disk utility, such as FDISK, to partition and format new IDE hard disk drives. This is necessary so that you can write or read data from the hard disk. Make sure to set the partition of the Primary IDE hard disk drives to active.

4.3.6 SATA 1-6

While entering Setup, the BIOS automatically detects the presence of Serial ATA devices. There is a separate sub-menu for each SATA device. Select a device item then press <Enter> to display the SATA device information.

Phoenix-Award BIOS CMOS Setup Utility		
Main		
SATA 1		Select Menu
Extended IDE Drive	[Auto]	Item Specific Help▶▶ Selects the type of fixed disk connected to the system.
Access Mode	[Auto]	
Capacity	0 MB	
Cylinder	0	
Head	0	
Landing Zone	0	
Sector	0	

F1: Help ↑↓ : Select Item -/+ : Change Value F5: Setup Defaults
ESC: Exit →← : Select Menu Enter: Select SubMenu F10: Save and Exit

The BIOS automatically detects the values opposite the dimmed items (Capacity, Cylinder, Head, Landing Zone and Sector). These values are not user-configurable. These items show 0 if no SATA device is installed in the system.

Extended Drive [Auto]

Selects the type of fixed disk connected to the system.

Configuration options: [None] [Auto]

Access Mode [Auto]

Sets the sector addressing mode. Configuration options: [Large] [Auto]



Before attempting to configure a hard disk drive, make sure you have the correct configuration information supplied by the drive manufacturer. Incorrect settings may cause the system to fail to recognize the installed hard disk.

Capacity

Displays the auto-detected hard disk capacity. This item is not configurable.

Cylinder

Shows the number of the hard disk cylinders. This item is not configurable.

Head

Shows the number of the hard disk read/write heads. This item is not configurable.

Landing Zone

Shows the number of landing zone per track. This item is not configurable.

Sector

Shows the number of sectors per track. This item is not configurable.



After entering the IDE hard disk drive information into BIOS, use a disk utility, such as FDISK, to partition and format new IDE hard disk drives. This is necessary so that you can write or read data from the hard disk. Make sure to set the partition of the Primary IDE hard disk drives to active.

4.3.7 HDD SMART Monitoring [Disabled]

Allows you to enable or disable the HDD Self-Monitoring Analysis and Reporting Technology (SMART) feature. Configuration options: [Disabled] [Enabled]

4.3.8 Installed Memory [xxx MB]

Shows the size of installed memory.

4.3.9 Usable Memory [XXX MB]

Shows the size of usable memory.

4.4 Advanced menu

The Advanced menu items allow you to change the settings for the CPU and other system devices.



Take caution when changing the settings of the Advanced menu items. Incorrect field values can cause the system to malfunction.

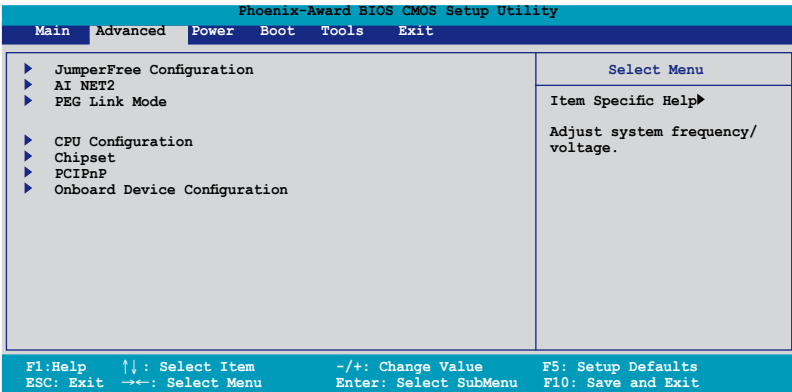

4.4.1 JumperFree Configuration

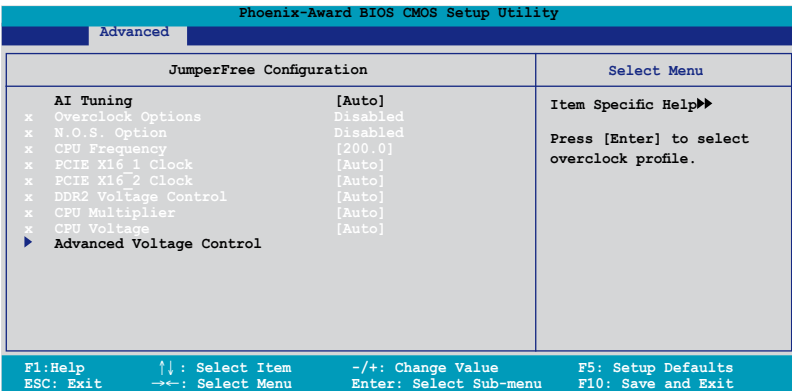

AI Tuning [Auto]

Allows selection of CPU overclocking options to achieve desired CPU internal frequency. Select either one of the preset overclocking configuration options:

Manual Allows you to individually set overclocking parameters.

Auto Loads the optimal settings for the system.

Standard	Loads the standard settings for the system.
AI Overclock	Loads overclocking profiles with optimal parameters for stability when overclocking.
AI N.O.S.	The ASUS Non-delay Overclocking System feature intelligently determines the system load and automatically boosts the performance for the most demanding tasks.



The following item becomes user-configurable when you set **AI Tuning** to [AI Overclocking].

Overclock Options [Disabled]

Allows you to set the overclocking options.

Configuration options: [Disabled] [Overclock 3%] [Overclock 5%] [Overclock 8%] [Overclock 10%]



The following item becomes user-configurable when you set **AI Tuning** to [AI N.O.S.].

N.O.S. Option [Disabled]

Allows you to set the Non-delay Overclocking System mode.

Configuration options: [Disabled] [Overclock 3%] [Overclock 5%] [Overclock 8%] [Overclock 10%]



The following items become user-configurable when you set **AI Tuning** to [Manual].

CPU Frequency [XXX] (value is auto-detected)

Indicates the frequency sent by the clock generator to the system bus and PCI bus. The bus frequency (external frequency) multiplied by the bus multiple equals the CPU speed. The BIOS auto-detects the value of this item. The values range from 200.0 to 400.0.



Setting a very high CPU frequency may cause the system to become unstable. If this happens, revert to the default setting.

PCIEX16_1 Clock [Auto]

Allows you to set the clock of the PCI Express_1.

Configuration options: [Auto] [100MHz] ~ [200MHz]

PCIEX16_2 Clock [Auto]

Allows you to set the clock of the PCI Express_2.

Configuration options: [Auto] [100MHz] ~ [200MHz]

DDR2 Voltage Control [Auto]

Allows you to set the operating DDR2 voltage.

Configuration options: [Auto] [1.800V] [1.825V] [1.850V] ~ [2.500V]

CPU Multiplier [Auto]

Allows you to set the operating CPU multiplier. The configuration options may vary depending on the type of CPU installed. Configuration options: [Auto] [5x] [6x] ~ [13x]

CPU Voltage [Auto]

Allows you to set the operating CPU voltage.

Configuration options: [Auto] [1.400v] [1.375v] ...[0.800v]

Advanced Voltage Control

Phoenix-Award BIOS CMOS Setup Utility		
Advanced		
Advanced Voltage Control		Select Menu
P_+1.2V Voltage	[Auto]	Item Specific Help▶▶▶
P_VTTDDR_SW Voltage	[0.5*+1.8V]	Set NB Core/PCI-E Voltage.
P_+1.5V Voltage	[Auto]	
Vcore Offset Voltage	[+ 50mV]	
P_+1.2V HT Voltage	[+1.250V]	
P_+1.3V HT MCP Voltage	[Auto]	
P_+1.5VSB Voltage	[+1.500V]	

F1: Help ↑↓ : Select Item -/+ : Change Value F5: Setup Defaults
ESC: Exit →← : Select Menu Enter: Select Sub-menu F10: Save and Exit

P_+1.2V Voltage [Auto]

Allows you to set the P_+1.2V voltage.

Configuration options: [Auto] [+1.20V] [+1.25V] [+1.30V] [+1.35V] [+1.40V]

P_VTTDDR_SW Voltage [0.5*+1.8V]

Allows you to set the P_VTTDDR_SW voltage.

Configuration options: [Auto] [0.5*+1.8V] [0.6*+1.8V]

P_+1.5V Voltage [Auto]

Allows you to set the P_+1.5V voltage.

Configuration options: [Auto] [+1.500V] [+1.525V] [+1.550V] [+1.575V]... [+1.700V]

Vcore Offset Voltage [+ 50mV]

Allows you to set the Vcore offset voltage.

Configuration options: [- 50mV] [+100mV] [+150mV] [+200mV]

P_+1.2V HT Voltage [+1.250V]

Allows you to set the P_+1.2V HT voltage.

Configuration options: [+1.250V] [+1.275V] [+1.300V]...[+1.425V]

P_+1.3V HT MCP Voltage [Auto]

Allows you to set the P_+1.3V HT MCP voltage.

Configuration options: [Auto] [+1.300V] [+1.325V] [+1.350V]...[+1.500V]

P_+1.5VSB Voltage [+1.500V]

Allows you to set the P_+1.5VSB voltage.

Configuration options: [+1.500V] [+1.600V] [+1.700V]

4.4.2 AI NET2

Phoenix-Award BIOS CMOS Setup Utility				
Advanced				
AI NET2			Select Menu	
POST Check LAN Cable	[Disabled]		Item Specific Help▶▶	
POST Check LAN2 Cable	[Disabled]			
Pair	Status	Length	Enable or Disable LAN cable check during POST.	
LAN1 (1-2)	Open	N/A		
LAN1 (3-4)	Open	N/A		
LAN1 (5-6)	Open	N/A		
LAN1 (7-8)	Open	N/A		
LAN2 (1-2)	Open	N/A		
LAN2 (3-4)	Open	N/A		
LAN2 (5-6)	Open	N/A		
LAN2 (7-8)	Open	N/A		
F1: Help ↑↓ : Select Item -/+ : Change Value F5: Setup Defaults ESC: Exit ←→ : Select Menu Enter: Select Sub-menu F10: Save and Exit				

POST Check LAN Cable [Disabled] POST Check LAN2 Cable [Disabled]

Enables or disables checking of the LAN/LAN2 cable during the Power-On Self-Test (POST). Configuration options: [Disabled] [Enabled]

4.4.3 PEG Link Mode

Phoenix-Award BIOS CMOS Setup Utility	
Advanced	
PEG Link Mode	Select Menu
PEG Link Mode [Auto]	Item Specific Help▶▶ Enhance performance on PCIe serial graphic card.

PEG Link Mode [Auto]

Allows you to enhance the performance of your PCI Express graphics card.
Configuration options: [Auto] [Disabled] [Normal] [Fast] [Faster]



Setting to [Fast] or [Faster] may cause your system to be unstable. If this happens, revert to the default setting [Auto].

4.4.4 CPU Configuration

Phoenix-Award BIOS CMOS Setup Utility	
Advanced	
CPU Configuration	Select Menu
CPU Type AMD Athlon(tm) 64 FX-62 Dual Core Processor	Item Specific Help▶▶ DRAM timing and control.
CPU Speed 2940 MHz	
Cache RAM 1024K x2	
▶ DRAM Configuration	
AMD Cool 'n' Quiet Function [Disabled]	

DRAM Configuration

The items in the sub-menu show the DRAM-related information auto-detected by the BIOS.

Phoenix-Award BIOS CMOS Setup Utility	
Advanced	
DRAM Configuration	Select Menu
Memory Clock Frequency [Auto]	Item Specific Help▶▶▶
Tcl [Auto]	Setting platform Memclock or limit value.
Trcd [Auto]	
Trp [Auto]	
Tras [Auto]	
1T/2T Memory Timing [Auto]	
▶ Advanced Memory Settings	
▶ DRAM Timing Control	
▶ Output Driver Control	
F1: Help ↑↓ : Select Item -/+ : Change Value F5: Setup Defaults	
ESC: Exit →← : Select Menu Enter: Select SubMenu F10: Save and Exit	

Memory Clock Frequency [Auto]

Sets the memory clock frequency.

Configuration options: [Auto] [DDR2 400] [DDR2 533] [DDR2 667] [RSVD] [DDR2 800]

Tcl [Auto]

Configuration options: [Auto][3] [4] [5] [6]

Trcd [Auto]

Configuration options: [Auto] [3] [4] [5] [6]

Trp [Auto]

Configuration options: [Auto] [3] [4] [5] [6]

Tras [Auto]

Configuration options: [Auto] [5] [6] [7] ~ [18]

1T/2T Memory Timing [Auto]

Sets the memory timing. Configuration options: [Auto] [1T] [2T]

Advance Memory Settings

CPU On-die Termination

Configuration options: [Auto] [300ohm] [150ohm] [75ohm]

Trc

Configuration options: [Auto] [11] [12] [13]...[25] [26]

Twr

Configuration options: [Auto] [3] [4] [5] [6]

Trrd

Configuration options: [Auto] [2] [3] [4] [5]

Trwt

Configuration options: [Auto] [2] [3] [4] [5] [6] [7] [8] [9]

Twtr

Configuration options: [Auto] [1] [2] [3]

Trtp

Configuration options: [Auto] [2/4] [3/5]

Twrdd

Configuration options: [Auto] [0] [1] [2] [3]

Twrwr

Configuration options: [Auto] [1] [2] [3]

Trdrd

Configuration options: [Auto] [2] [3] [4] [5]

Tref

Configuration options: [Auto] [Undef] [7.8 us] [3.9 us]

Trfc

Configuration options: [Auto] [0] [1] [2] [3] [4]

DRAM Termination

Configuration options: [Auto] [Disabled] [75 ohms] [150 ohms] [50 ohms]

Max Async Latency

Configuration options: [Auto] [0 ns] [1 ns] [2 ns] [3 ns]...[14 ns] [15 ns]

R/W Queue Bypass

Configuration options: [Auto] [2x] [4x] [8x] [16x]

Dynamic Idle Cycle

CounterConfiguration options: [Auto] [Disabled] [Enabled]

Idle Cycle Limit

Configuration options: [Auto] [0 cycles] [4 cycles] [8 cycles] [16 cycles] [32 cycles] [64 cycles] [128 cycles] [256 cycles]

DCQ Bypass Maximum

Configuration options: [Auto] [0x] [1x] [2x] [3x]...[14x] [15x]

DRAM Burst Length

Configuration options: [Auto] [64-byte] [32-byte]

RdPadRcvFIFO Delay

Configuration options: [Auto] [1.5] [2] [2.5] [3] [3.5]

Disable Jitter

Configuration options: [Auto] [OFF] [ON]

DRAM Bank Interleaving

Configuration options: [Disabled] [Enabled]

DRAM Timing Control

CKE Fine Delay

Configuration options: [Auto] [No delay] [1/64 MEMCLK delay] [2/64 MEMCLK delay] [3/64 MEMCLK delay] [4/64 MEMCLK delay] [5/64 MEMCLK delay]...[30/64 MEMCLK delay] [31/64 MEMCLK delay]

CKE Setup Time

Configuration options: [Auto] [1/2 MEMCLK] [1 MEMCLK]

CS/ODT Fine Delay

Configuration options: [Auto] [No delay] [1/64 MEMCLK delay] [2/64 MEMCLK delay] [3/64 MEMCLK delay] [4/64 MEMCLK delay] [5/64 MEMCLK delay]...[30/64 MEMCLK delay] [31/64 MEMCLK delay]

CS/ODT Setup Time

Configuration options: [Auto] [1/2 MEMCLK] [1 MEMCLK]

Address/Command Fine Delay

Configuration options: [Auto] [No delay] [1/64 MEMCLK delay] [2/64 MEMCLK delay] [3/64 MEMCLK delay] [4/64 MEMCLK delay] [5/64 MEMCLK delay]...[30/64 MEMCLK delay] [31/64 MEMCLK delay]

Address/Command Setup Time

Configuration options: [Auto] [1/2 MEMCLK] [1 MEMCLK]

Read DQS Timing Control

Configuration options: [Auto] [No delay] [1/96 MEMCLK delay] [2/96 MEMCLK delay] [3/96 MEMCLK delay] [4/96 MEMCLK delay] ...[47/96]

Write Data Timing Control

Configuration options: [Auto] [No delay] [1/96 MEMCLK delay] [2/96 MEMCLK delay] [3/96 MEMCLK delay] [4/96 MEMCLK delay] ...[47/96]

DQS Receiver Enable Timing

Configuration options: [Auto] [0 ps] [50 ps] [100 ps] [150 ps] [200 ps] [250 ps] [300 ps] [350 ps] [400 ps]...[8550 ps] [8600 ps] [8650 ps] [8700 ps]

Output Driver Control

CKE Drive Strength

Configuration options: [Auto] [1.00x] [1.25x] [1.50x] [2.00x]

CS/ODT Drive Strength

Configuration options: [Auto] [1.00x] [1.25x] [1.50x] [2.00x]

Add/CMD Drive Strength

Configuration options: [Auto] [1.00x] [1.25x] [1.50x] [2.00x]

MEMCLK Drive Strength

Configuration options: [Auto] [0.75x] [1.00x] [1.25x] [1.50x]

Data Drive Strength

Configuration options: [Auto] [0.75x] [1.00x] [1.25x] [1.50x]

DQS Drive Strength

Configuration options: [Auto] [0.75x] [1.00x] [1.25x] [1.50x]

DRAM Drivers Weak Mode

Configuration options: [Auto] [Normal] [Weak]

AMD Cool 'n' Quiet Function [Disabled]

Enables or disables the AMD Cool 'n' Quiet technology.

Configuration options: [Auto] [Disabled]

4.4.5 Chipset

Phoenix-Award BIOS CMOS Setup Utility		
Advanced		
Chipset		Select Menu
NB<->SB HT Frequency	[Auto]	Item Specific Help▶▶▶
CPU<->NB HT Speed	[Auto]	
NB<->SB HT Speed	[5xNB to SB HT Frequency]	
SB<->NB HT Speed	[5xSB to NB HT Frequency]	
CPU<->NB HT Width	[↓16 ↑16]	
NB<->SB HT Width	[↓16 ↑16]	
CPU Spread Spectrum	[Center]	
PCI-E Spread Spectrum	[Disabled]	
SATA Spread Spectrum	[Disabled]	
HT Spread Spectrum	[Disabled]	
SLI Broadcast Aperture	[Auto]	

F1: Help ↑↓ : Select Item -/+ : Change Value F5: Setup Defaults
 ESC: Exit →← : Select Menu Enter: Select Sub-menu F10: Save and Exit

NB<->SB HT Frequency [Auto]

Allows you to set the Northbridge to Southbridge HT Frequency.

Configuration options: [Auto] [200.0] [201.0] [202.0]...[400.0]

CPU<->NB HT Speed [Auto]

Allows you to set the CPU to Northbridge HT Speed.

Configuration options: [Auto] [1xCPU Frequency] [2xCPU Frequency] [3xCPU Frequency] [5xCPU Frequency] [5xCPU Frequency]

NB<->SB HT Speed [5xNB to SB HT Frequency]

Allows you to set the Northbridge to Southbridge HT Speed.

Configuration options: [1xNB to SB HT Frequency] [2xNB to SB HT Frequency] [3xNB to SB HT Frequency] [4xNB to SB HT Frequency] [5xNB to SB HT Frequency]

SB<->NB HT Speed [5xSB to NB HT Frequency]

Allows you to set the Southbridge to Northbridge HT Speed.

Configuration options: [1xNB to SB HT Frequency] [2xNB to SB HT Frequency] [3xNB to SB HT Frequency] [4xNB to SB HT Frequency] [5xNB to SB HT Frequency]

CPU<->NB HT Width [↓16 ↑16]

Allows you to set the CPU to Northbridge HT width.

Configuration options: [↓8 ↑8] [↓16 ↑16]

NB<->SB HT Width [↓16 ↑16]

Allows you to set the Northbridge to Southbridge HT width.

Configuration options: [↓8 ↑8] [↓16 ↑16]

CPU Spread Spectrum [Center]

Enables or disables Spread Spectrum for CPU.

Configuration options: [Disabled] [Center] [Down]

PCI Express Spread Spectrum [Disabled]

Enables or disables Spread Spectrum for PCI Express.

Configuration options: [Disabled] [Enabled]

SATA Spread Spectrum [Disabled]

Enables or disables Spread Spectrum for SATA.

Configuration options: [Disabled] [Enabled]

HT Spread Spectrum [Disabled]

Disables or sets the spread Spectrum for Hyper Transport.

Configuration options: [Disabled] [Center] [Down]

SLI Broadcast Aperture [Auto]

Disables or sets Broadcast Aperture for SLI.

Configuration options: [Auto] [Disabled]

4.4.6 PCIPnP

Phoenix-Award BIOS CMOS Setup Utility		
Advanced		
PCIPnP		Select Menu
Plug & Play O/S	[No]	Item Specific Help▶▶▶
Resources Controlled By x IRQ Resources	[Auto]	Select Yes if you are using a Plug and Play capable operating system. Select No if you need the BIOS to configure non-boot devices.

Plug & Play O/S [No]

When set to [No], the BIOS configures all the devices in the system. When set to [Yes] and if you install a Plug and Play operating system, the operating system configures the Plug and Play devices not required for boot. Configuration options: [No] [Yes]

Resources Controlled By [Auto]

When set to [Auto], the BIOS automatically configures all the boot and Plug and Play compatible devices. Set to [Manual] if you want to assign the IRQ DMA and memory base address fields. Configuration options: [Auto] [Manual]



The item **IRQ Resources** becomes user-configurable when you set **Resources Controlled By** to [Manual].

IRQ Resources

Phoenix-Award BIOS CMOS Setup Utility		
Advanced		
IRQ Resources		Select Menu
IRQ-5 assigned to	[PCI Device]	Item Specific Help▶▶▶
IRQ-7 assigned to	[PCI Device]	Legacy ISA for devices compliant with the original PC AT bus specification, PCI/ISA PnP for devices compliant with the Plug and Play standard whether designed for PCI or ISA bus architecture.
IRQ-9 assigned to	[PCI Device]	
IRQ-10 assigned to	[PCI Device]	
IRQ-11 assigned to	[PCI Device]	
IRQ-14 assigned to	[PCI Device]	
IRQ-15 assigned to	[PCI Device]	

IRQ-xx assigned to

When set to [PCI Device], the specific IRQ is free for use of PCI/PnP devices. When set to [Reserved], the IRQ is reserved for legacy ISA devices. Configuration options: [PCI Device] [Reserved]

4.4.7 Onboard Device Configuration

Phoenix-Award BIOS CMOS Setup Utility		
Advanced		
Onboard Device Configuration	Select Menu	
<ul style="list-style-type: none"> ▶ IDE Function Setup ▶ Serial-ATA Configuration ▶ USB Configuration Onboard 1394 Controller [Enabled] Onboard 1st nVidia LAN [Enabled] Onboard 2nd nVidia LAN [Enabled] Onboard LAN Boot ROM [Disabled] Primary Display Adapter [PCIEX16_1] HD Audio [Auto] Front Panel Support Type [AC97] Marvell SATAII Controller [Enabled] marvell SATAII Option Rom [Disabled] Serial Port1 Address [3F8/IRQ4] Parallel Port Address [378/IRQ7] Parallel Port Mode [Bi-Directional] ECP Mode Use DMA 3 	Item Specific Help▶▶ Press [Enter] to set	
F1: Help ↑↓: Select Item -/+ : Change Value F5: Setup Defaults ESC: Exit ←→: Select Menu Enter: Select SubMenu F10: Save and Exit		

IDE Function Setup

This sub-menu contains IDE function-related items. Select an item then press <Enter> to edit.

Phoenix-Award BIOS CMOS Setup Utility		
Advanced		
IDE Function Setup	Select Menu	
OnChip IDE Channel0 [Enabled] IDE DMA transfer access [Enabled] IDE Prefetch Mode [Enabled]	Item Specific Help▶▶▶	

OnChip IDE Channel0 [Enabled]

Allows you to enable or disable the onchip IDE channel 0 controller .
 Configuration options: [Disabled] [Enabled]

IDE DMA transfer access [Enabled]

Allows you to enable or disable the IDE DMA transfer access.
 Configuration options: [Disabled] [Enabled]

IDE Prefetch Mode [Enabled]

Allows you to enable or disable the IDE PIO read prefetch mode.
 Configuration options: [Disabled] [Enabled]

Serial-ATA Configuration

This sub-menu allows you to change Serial ATA settings. Select an item then press <Enter> to edit.

Phoenix-Award BIOS CMOS Setup Utility			
Advanced			
Serial-ATA Configuration			Select Menu
Serial-ATA Controller		[Enabled]	Item Specific Help▶▶▶
RAID Enabled		[Disabled]	
x SATA 1	RAID	Disabled	
x SATA 2	RAID	Disabled	
x SATA 3	RAID	Disabled	
x SATA 4	RAID	Disabled	
x SATA 5	RAID	Disabled	
x SATA 6	RAID	Disabled	

Serial-ATA Controller [Enabled]

Configuration options: [Disabled] [Enabled]

RAID Enabled [Disabled]

Enables or disables the onboard RAID controller. When set to [Enabled], the succeeding items become user-configurable. Configuration options: [Disabled] [Enabled]

SATA 1 ~SATA 6 RAID [Disabled]

Enables or disables the RAID function of the first, second, third or fourth SATA master drive. Configuration options: [Disabled] [Enabled]

USB Configuration

The items in this menu allows you to change the USB-related features. Select an item then press <Enter> to display the configuration options.

Phoenix-Award BIOS CMOS Setup Utility			
Advanced			
USB Configuration			Select Menu
USB Controller		[Enabled]	Item Specific Help▶▶▶
USB2.0 Controller		[Enabled]	
USB Legacy support		[Enabled]	
			Enable or Disable the USB Controller.

USB Controller [Enabled]

Allows you to enable or disable the onchip USB controller. Configuration options: [Disabled] [Enabled]

USB 2.0 Controller [Enabled]

Allows you to enable or disable the USB 2.0 controller. Configuration options: [Disabled] [Enabled]

USB Legacy Support [Enabled]

Allows you to enable or disable support for USB devices on legacy operating systems (OS). Configuration options: [Disabled] [Enabled]

Onboard 1394 Controller [Enabled]

Allows you to disable or enable the onboard 1394 device support.

Configuration options: [Disabled] [Enabled]

Onboard 1st/2nd Nvidia LAN [Enabled]

Enables or disables the onboard NVIDIA® LAN controller.

Configuration options: [Disabled] [Enabled]

OnBoard nVidia LAN Boot ROM [Disabled]

Allows you to enable or disable the onboard LAN boot ROM.

Configuration options: [Enabled] [Disabled]

Primary Display Adapter [PCIEX16_1]

Allows you to select the graphics controller to use as the primary boot device.

Configuration options: [PCI Slot] [PCIEX16_2] [PCIEX16_1]

HD Audio [Auto]

Allows you to disable or set the High-Definition audio function.

Configuration options: [Auto] [Disabled]

Front Panel Support Type [AC97]

Allows you to select the front panel support type.

Configuration options: [AC97] [HD Audio]

Marvell SATAII Controller [Enabled]

Allows you to disable or set the function of the extended SATA II controller.

Configuration options: [Disabled] [Enabled]

Marvell SATAII Option Rom [Disabled]

Allows to enable or disable the extended SATA II option Rom.

Configuration options: [Disabled] [Enabled]

Serial Port1 Address [3F8/IRQ4]

Allows you to select the Serial Port1 base address.

Configuration options: [Disabled] [3F8/IRQ4] [2F8/IRQ3] [3E8/IRQ4] [2E8/IRQ3]
[Auto]

Parallel Port Address [378/IRQ7]

Allows you to select the Parallel Port address.

Configuration options: [Disabled] [378/IRQ7] [278/IRQ5] [3BC/IRQ7]

Parallel Port Mode [Bi-Directional]

Allows you to select the Parallel Port mode.

Configuration options: [Normal] [EPP] [ECP] [Bi-Directional]



The "ECP Mode Use DMA" item becomes user-configurable when the " Parallel Port Mode" item is set to [ECP] or [Bi-Directional]

ECP Mode Use DMA [3]

Allows selection of ECP Mode. Configuration options: [1] [3]

4.5 Power menu

The Power menu items allow you to change the settings for the Advanced Configuration and Power Interface (ACPI) and the Advanced Power Management (APM). Select an item then press <Enter> to display the configuration options.

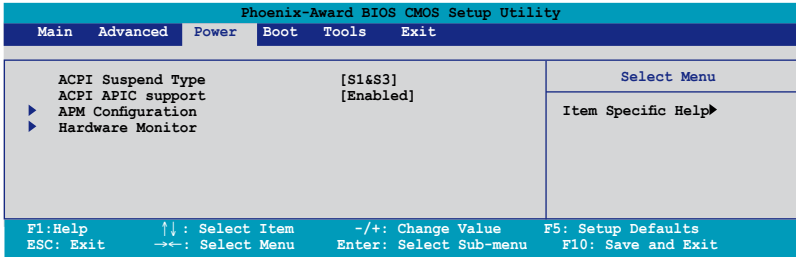

4.5.1 ACPI Suspend Type [S1&S3]

Allows you to select the Advanced Configuration and Power Interface (ACPI) state to be used for system suspend. Configuration options: [S1 (POS)] [S3(STR)] [S1&S3]

4.5.2 ACPI APIC Support [Enabled]

Allows you to enable or disable the Advanced Configuration and Power Interface (ACPI) support in the Application-Specific Integrated Circuit (ASIC). When set to Enabled, the ACPI APIC table pointer is included in the RSDT pointer list. Configuration options: [Disabled] [Enabled]

4.5.3 APM Configuration

Phoenix-Award BIOS CMOS Setup Utility		
Power		
APM Configuration		Select Menu
Restore on AC Power Loss	[Power-Off]	Item Specific Help▶▶ Press [Enter] to select whether or not to restart the system after AC power loss.
PWR Button < 4 secs	[Instant-Off]	
Power On By PCI/PCIE Devices	[Disabled]	
Power On By External Modems	[Disabled]	
Power On by RTC Alarm	[Disabled]	
* Date (of Month) Alarm	0	
* Time (hh:mm:ss) Alarm	0 : 0 : 0	
Power Up By PS/2 Mouse	[Disabled]	
Power Up By PS/2 Keyboard	[Disabled]	
F1: Help ↑↓ : Select Item -/+ : Change Value F5: Setup Defaults		
ESC: Exit →← : Select Menu Enter: Select SubMenu F10: Save and Exit		

Restore on AC Power Loss [Power-Off]

Allows you to enable or disable the Restore on AC Power Loss function.
Configuration options: [Power-Off] [Power-On]

PWR Button < 4 secs [Instant-Off]

Allows you to set the event after the power button is pressed for more than 4 seconds. Configuration options: [Suspend] [Instant-Off]

Power On By PCI/PCIE Devices [Disabled]

Allows you to enable or disable the PME to wake up from S5 by PCI/PCIE devices & NV Onboard LAN. Configuration options: [Disabled] [Enabled]

Power On By External Modems [Disabled]

This allows either settings of [Enabled] or [Disabled] for powering up the computer when the external modem receives a call while the computer is in Soft-off mode.
Configuration options: [Disabled] [Enabled]



The computer cannot receive or transmit data until the computer and applications are fully running. Thus, connection cannot be made on the first try. Turning an external modem off and then back on while the computer is off causes an initialization string that turns the system power on.

Power On By RTC Alarm [Disabled]

Allows you to enable or disable RTC to generate a wake event. When this item is set to Enabled, the items Date of Month Alarm and Time (hh:mm:ss) Alarm items become user-configurable with set values.

Configuration options: [Disabled] [Enabled]

Date of Month Alarm [Disabled]

To set the date of alarm, highlight this item and press <Enter> to display the Date of Month Alarm pop-up menu. Key-in a value within the specified range then press <Enter>. Configuration options: [Min=0] [Max=31]

Time (hh:mm:ss) Alarm [Disabled]

To set the time of alarm:

1. Highlight this item and press <Enter> to display a pop-up menu for the hour field.
2. Key-in a value (Min=0, Max=23), then press <Enter>.
3. Press <TAB> to move to the minutes field then press <Enter>.
4. Key-in a minute value (Min=0, Max=59), then press <Enter>.
5. Press <TAB> to move to the seconds field then press <Enter>.
6. Key-in a value (Min=0, Max=59), then press <Enter>.

Power Up By PS/2 Mouse [Disabled]

When set to [Enabled], this parameter allows you to use the PS/2 mouse to turn on the system. This feature requires an ATX power supply that provides at least 1A on the +5VSB lead. Configuration options: [Disabled] [Enabled]

Power Up By PS/2 Keyboard [Disabled]

Allows you to disable the Power On by PS/2 keyboard function or set specific keys on the PS/2 keyboard to turn on the system. This feature requires an ATX power supply that provides at least 1A on the +5VSB lead. Configuration options: [Disabled] [Space Bar] [Ctrl-ESC] [Power Key]

4.5.4 Hardware Monitor

The items in this sub-menu displays the hardware monitor values automatically detected by the BIOS. It also allows you to change CPU Q-Fan feature-related parameters. Select an item then press <Enter> to display the configuration options.

Phoenix-Award BIOS CMOS Setup Utility			
Power			
Hardware Monitor		Select Menu	
Q-Fan Controller	[Disabled]	Item Specific Help▶▶	
Vcore Voltage	1.47V	Press [Enter] to enable or disable.	
3.3V Voltage	3.15V		
5V Voltage	5.05V		
12V Voltage	11.58V		
CPU Temperature	48°C		
M/B Temperature	41°C		
CPU FAN Speed	3068 RPM		
CHA_FAN1 Speed	0 RPM		
CHA_FAN2 Speed	0 RPM		
SPS_FAN Speed	0 RPM		
CPU Fan Speed warning	[800 RPM]		
F1: Help	↑↓: Select Item	-/+ : Change Value	F5: Setup Defaults
ESC: Exit	→←: Select Menu	Enter: Select SubMenu	F10: Save and Exit

Q-Fan Controller [Disabled]

Allows you to enable or disable the Q-Fan controller.
Configuration options: [Disabled] [Enabled]

Vcore Voltage, 3.3V Voltage, 5V Voltage, 12V Voltage

The onboard hardware monitor automatically detects the voltage output through the onboard voltage regulators.

CPU Temperature, M/B Temperature

The onboard hardware monitor automatically detects and displays the motherboard and CPU temperatures. These items are not user-configurable.

CPU Fan Speed CHA_FAN1/2 Speed SPS_FAN Speed

The onboard hardware monitor automatically detects and displays the CPU and Chassis fan speeds in rotations per minute (RPM). If any of the fans is not connected to the motherboard, the field shows 0. These items are not user-configurable.

CPU Fan Speed warning [800 RPM]

Allows you to disable or set the CPU fan warning speed.
Configuration options: [Disabled] [800 RPM] [1200 RPM] [1600 RPM]

4.6 Boot menu

The Boot menu items allow you to change the system boot options. Select an item then press <Enter> to display the sub-menu.

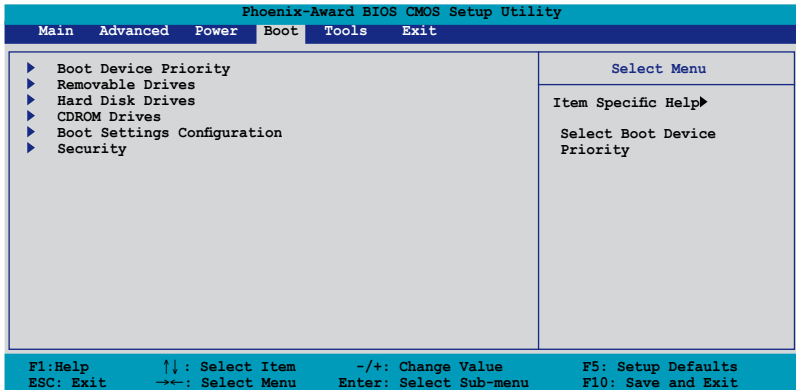

4.6.1 Boot Device Priority

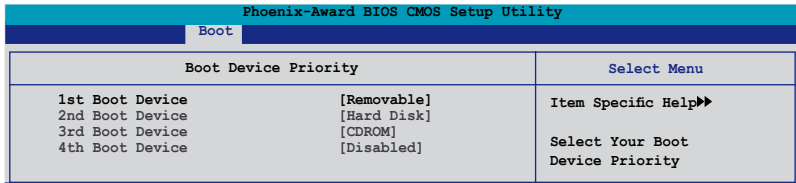

1st ~ 4th Boot Device [Removable]

These items specify the boot device priority sequence from the available devices. The number of device items that appears on the screen depends on the number of devices installed in the system. Configuration options: [Removable] [Hard Disk] [CDROM] [Disabled]

4.6.2 Removable Drives

Phoenix-Award BIOS CMOS Setup Utility	
Boot	
Removable Drives	Select Menu
1. Floppy Disks	Item Specific Help▶▶

1. Floppy Disks

Allows you to assign a removable drive attached to the system.

4.6.3 Hard Disk Drives

Phoenix-Award BIOS CMOS Setup Utility	
Boot	
Hard Disk Drives	Select Menu
1. 1st Master: XXXXXXXXX	Item Specific Help▶▶

1. SATA 1: XXXXXXXXX

Allows you to assign hard disk drives attached to the system.

4.6.4 CDROM Drives

Phoenix-Award BIOS CMOS Setup Utility	
Boot	
CDROM Drives	Select Menu
1. 1st Slave: XXXXXXXXX	Item Specific Help▶▶

1. 1st Slave: XXXXXXXXX

Allows you to assign optical drives attached to the system.

4.6.5 Boot Settings Configuration

Phoenix-Award BIOS CMOS Setup Utility		
Boot		
Boot Settings Configuration	Select Menu	
Case Open Warning	[Enabled]	Item Specific Help▶▶ Press [Enter] to enable or disable.
Quick Boot	[Enabled]	
Boot Up Floppy Seek	[Disabled]	
Bootup Num-Lock	[On]	
Typematic Rate Setting	[Disabled]	
x Typematic Rate (Chars/Sec)	6	
x Typematic Delay (Msec)	250	
OS Select For DRAM > 64MB	[Non-OS2]	
Full Screen LOGO	[Enabled]	
Halt On	[All Errors]	

F1: Help ↑↓: Select Item -/+ : Change Value F5: Setup Defaults
ESC: Exit ←→: Select Menu Enter: Select Sub-menu F10: Save and Exit

Case Open Warning [Enabled]

Enables or disables the chassis open status feature. Setting to Enabled, clears the chassis open status. Refer to section “2.7.2 Internal connectors” for setting details. Configuration options: [Disabled] [Enabled]

Quick Boot [Enabled]

Allows you to enable or disable the system quick boot feature. When Enabled, the system skips certain tests while booting. Configuration options: [Disabled] [Enabled]

Boot Up Floppy Seek [Disabled]

Enables or disables the chassis open status feature. Setting to Enabled, clears the chassis open status. Configuration options: [Disabled] [Enabled]

Bootup Num-Lock [On]

Allows you to select the power-on state for the NumLock. Configuration options: [Off] [On]

Typematic Rate Setting [Disabled]

Allows you to set the keystroke rate. Enable this item to configure the Typematic Rate (Chars/Sec) and the Typematic Delay (Msec). Configuration options: [Disabled] [Enabled]



The items **Typematic Rate (Chars/Sec)** and **Typematic Delay (Msec)** become user-configurable only when the item **Typematic Rate Setting** is enabled.

Typematic Rate (Chars/Sec) [6]

Allows you to select the rate at which a character repeats when you hold a key. Configuration options: [6] [8] [10] [12] [15] [20] [24] [30]

Typematic Delay (Msec) [250]

Allows you to set the delay before keystrokes begin to repeat. Configuration options: [250] [500] [750] [1000]

OS Select for DRAM > 64MB [Non-OS2]

Set this item to OS2 only when you are running on an OS/2 operating system with an installed RAM of greater than 64 KB. Configuration options: [Non-OS2] [OS2]

Full Screen LOGO [Enabled]

Allows you to enable or disable the full screen logo display feature. Configuration options: [Disabled] [Enabled]



Make sure that the above item is set to [Enabled] if you want to use the ASUS MyLogo3™ feature.

Halt On [All Errors]

Allows you to error report type.

Configuration options: [All Errors] [No Errors] [All, But Keyboard] [All, But Diskette] [All, But Disk/Key]

4.6.6 Security

Phoenix-Award BIOS CMOS Setup Utility		
Boot		
Security		Select Menu
Supervisor Password	Clear	Item Specific Help▶▶
User Password	Clear	
Password Check	[Setup]	
TPM Function	[Disabled]	

Supervisor Password

User Password

These fields allow you to set passwords:

To set a password:

1. Select an item then press <Enter>.
2. Type in a password using a combination of a maximum of eight (8) alphanumeric characters, then press <Enter>.

3. When prompted, confirm the password by typing the exact characters again, then press <Enter>. The password field setting is changed to Set.

To clear the password:

1. Select the password field and press <Enter> twice. The following message appears:



2. Press any key to continue. The password field setting is changed to Clear.

A note about passwords

The Supervisor password is required to enter the BIOS Setup program preventing unauthorized access. The User password is required to boot the system preventing unauthorized use.

Forgot your password?

If you forget your password, you can clear it by erasing the CMOS Real Time Clock (RTC) RAM. The RAM data containing the password information is powered by the onboard button cell battery. If you need to erase the CMOS RAM, refer to section “2.6 Jumper” for instructions.

Password Check

This field requires you to enter the password before entering the BIOS setup or the system. Select [Setup] to require the password before entering the BIOS Setup. Select [System] to require the password before entering the system. Configuration options: [Setup] [System]

TPM Function [Disabled]

Allows you to enable or disable the TPM security chip.

Configuration options: [Disabled] [Enabled]



The succeeding item appears when you enable the **TPM Function** item.

Clear TPM Security Chip [Enter]

Allows you to clear the user information saved in the TPM security chip. When you press <Enter>, a warning message appears, asking if you are sure that you want to clear the user information in the security chip. Use the left/right arrow key to select between [Yes] or [No], then press <Enter> to confirm your choice.

4.7 Tools menu

The Tools menu items allow you to configure options for special functions. Select an item then press <Enter> to display the sub-menu.

Phoenix-Award BIOS CMOS Setup Utility					
Main	Advanced	Power	Boot	Tools	Exit
▶ ASUS Music Alarm				Select Menu	
▶ ASUS O.C. Profile				Item Specific Help▶	
ASUS EZ Flash 2					
F1:Help			↑↓: Select Item	-/+ : Change Value	F5: Setup Defaults
ESC: Exit			→←: Select Menu	Enter: Select Sub-menu	F10: Save and Exit

4.7.1 ASUS Music Alarm

Phoenix-Award BIOS CMOS Setup Utility		
Tools		
ASUS Music Alarm		Select Menu
ASUS Music Alarm [Disabled]		Item Specific Help▶▶
x Alarm Date: Sunday	Enabled	Press [Enter] to select.
x Monday	Enabled	
x Tuesday	Enabled	
x Wednesday	Enabled	
x Thursday	Enabled	
x Friday	Enabled	
x Saturday	Enabled	
x Alarm Time (hh:mm)	0 : 0	
x Audio CD Drive	Primary IDE Master	
x Detect CD	Enter	
x Starting Track	N/A	
x Repeat Track	Disabled	
x Length	10 Mins	
x Volume	16	
F1:Help		
ESC: Exit		
↑↓: Select Item		
→←: Select Menu		
-/+ : Change Value		
Enter: Select SubMenu		
F5: Setup Defaults		
F10: Save and Exit		

ASUS Music Alarm [Disabled]

Allows you to enable or disable the ASUS Music Alarm function.

Configuration options: [Disabled] [Enabled]



The succeeding items become user-configurable when you enable the ASUS Music Alarm.

Alarm Date: Sunday/Monday/Tuesday/Wednesday/Thursday/Friday/ Saturday [Enabled]

Allows you to enable or disable the alarm for a particular day.
Configuration options: [Disabled] [Enabled]

Alarm Time (hh:mm) 0 : 0

Allows you to set the alarm time. Press <Tab> to select the field, then use <+> or <-> to change the value. Configuration options: [0~23] [0~55]

Audio CD Drive [Primary IDE Master]

Allows you to select the connection configuration of the optical storage device from which the alarm music will play from. Configuration options: [Primary IDE Master] [Primary IDE Slave]

Detect CD

Press <Enter> to search the CD track number.

Starting Track

Allows you to choose the starting track from the CD from which you would like the alarm music to play.

Repeat Track [Disabled]

Allows you to enable or disable the repeat track function.
Configuration options: [Disabled] [Single] [All]

Length [10 Mins]

Allows you to set the length of the music alarm.
Configuration options: [10 Mins] [20 Mins] [30 Mins] [1 Hour]

Volume [16]

Allows you to set the volume level of the music alarm.
Configuration options: [01] ~ [32]

4.7.2 ASUS O.C. Profile

This item allows you to store or load multiple BIOS settings.

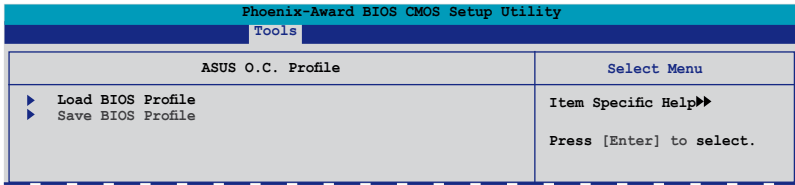

Load BIOS Profile

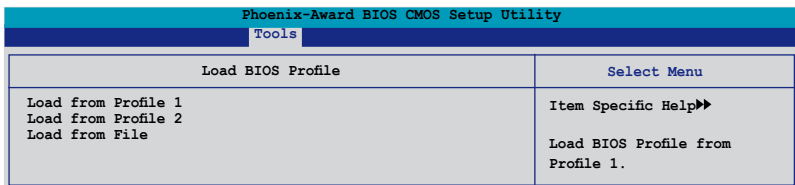

Load from Profile 1/2

Allows you to load the previous BIOS settings saved in the BIOS Flash. Press <Enter> to load the file.

Load from File

Allows you to load the previous BIOS files saved in the hard disk/floppy disk/USB flash disk with the FAT32/16/12 format. Follow the instructions below to load the BIOS file.

1. Insert the storage devices that contain the "xxx.CMO" file.
2. Turn on the system.
3. Enter BIOS setup program. Go to the "Tools" menu to select "Load from File". Press <Enter> then the setup screen will appear.
4. Press <Tab> to switch between drives before the correct "xxx.CMO" file is found. Then press <Enter> to load the file.
5. A pop-up message will inform you when the loading process finishes.



- Suggest only to update the BIOS file coming from the same memory/CPU configuration and BIOS version.
- Only the "xxx.CMO" file can be loaded.

Save BIOS Profile

Phoenix-Award BIOS CMOS Setup Utility	
Tools	
Save BIOS Profile	Select Menu
Save to Profile 1 Save to Profile 2 Save to File	Item Specific Help▶▶ Save current BIOS Profile to Profile 1.

Save to Profile 1/2

Allows you to save the current BIOS file to the BIOS Flash. Press <Enter> to save the file.

Save to File

Allows you to save the current BIOS file to the hard disk/floppy disk/USB flash disk with the FAT32/16/12 format. Follow the instructions below to save the BIOS file.

1. Insert the storage devices with enough space.
2. Turn on the system.
3. Enter BIOS setup program. Go to the “Tools” menu to select “Save to File”. Press <Enter> then the setup screen will appear.
4. Press <Tab> to switch between drives. Press hot-key <S> to save the file.
5. Key in the file name. Then press <Enter>.
6. A pop-up message will inform you when the loading process finishes.

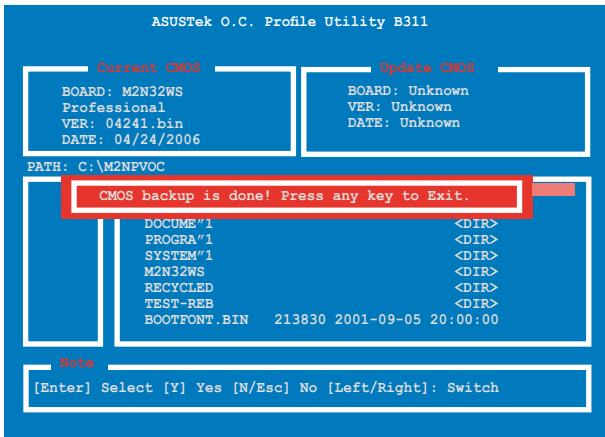

The BIOS file will be saved as “xxx.CMO”.

4.7.3 ASUS EZ Flash 2

Allows you to run ASUS EZ Flash 2. When you press <Enter>, a confirmation message appears. Use the left/right arrow key to select between [Yes] or [No], then press <Enter> to confirm your choice. Please see page 4-5, section 4.1.3 for details.

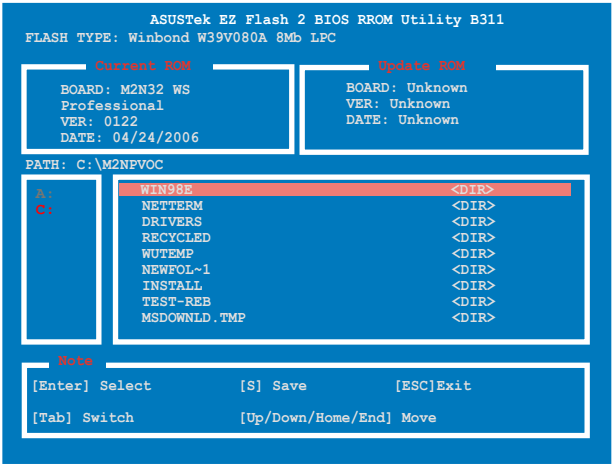

4.8 Exit menu

The Exit menu items allow you to load the optimal or failsafe default values for the BIOS items, and save or discard your changes to the BIOS items.

Phoenix-Award BIOS CMOS Setup Utility					
Main	Advanced	Power	Boot	Tools	Exit
Exit & Save Changes Exit & Discard Changes Load Setup Default Discard Changes					Select Menu Item Specific Help▶ This option save data to CMOS and exiting the setup menu.
F1: Help	↑↓ : Select Item	-/+ : Change Value	F5: Setup Defaults		
ESC: Exit	→← : Select Menu	Enter : Select SubMenu	F10: Save and Exit		



Pressing <Esc> does not immediately exit this menu. Select one of the options from this menu or <F10> from the legend bar to exit.

Exit & Save Changes

Once you are finished making your selections, choose this option from the Exit menu to ensure the values you selected are saved to the CMOS RAM. An onboard backup battery sustains the CMOS RAM so it stays on even when the PC is turned off. When you select this option, a confirmation window appears. Select YES to save changes and exit.



If you attempt to exit the Setup program without saving your changes, the program prompts you with a message asking if you want to save your changes before exiting. Press <Enter> to save the changes while exiting.

Exit & Discard Changes

Select this option only if you do not want to save the changes that you made to the Setup program. If you made changes to fields other than System Date, System Time, and Password, the BIOS asks for a confirmation before exiting.

Load Setup Defaults

This option allows you to load the default values for each of the parameters on the Setup menus. When you select this option or if you press <F5>, a confirmation window appears. Select YES to load default values. Select Exit & Save Changes or make other changes before saving the values to the non-volatile RAM.

Discard Changes

This option allows you to discard the selections you made and restore the previously saved values. After selecting this option, a confirmation appears. Select YES to discard any changes and load the previously saved values.

This chapter describes the contents of the support CD that comes with the motherboard package.

5 Software support

Chapter summary

5

5.1	Installing an operating system	-1
5.2	Support CD information	-1

5.1 Installing an operating system

This motherboard supports Windows® 2000/2003 Server/XP/64-bit XP operating systems (OS). Always install the latest OS version and corresponding updates to maximize the features of your hardware.



- Motherboard settings and hardware options vary. Use the setup procedures presented in this chapter for reference only. Refer to your OS documentation for detailed information.
- Make sure that you install Windows® 2000 Service Pack 4 or the Windows® XP Service Pack 2 or later versions before installing the drivers for better compatibility and system stability.

5.2 Support CD information

The support CD that came with the motherboard package contains the drivers, software applications, and utilities that you can install to avail all motherboard features.



The contents of the support CD are subject to change at any time without notice. Visit the ASUS website(www.asus.com) for updates.

5.2.1 Running the support CD

Place the support CD to the optical drive. The CD automatically displays the Drivers menu if Autorun is enabled in your computer.



Click an icon to display support CD/motherboard information

Click an item to install



If Autorun is NOT enabled in your computer, browse the contents of the support CD to locate the file ASSETUP.EXE from the BIN folder. Double-click the ASSETUP.EXE to run the CD.

5.2.2 Drivers menu

The drivers menu shows the available device drivers if the system detects installed devices. Install the necessary drivers to activate the devices.



ASUS InstAll - Installation Wizard for Drivers

Launches the ASUS InstallAll driver installation wizard.

Nvidia Chipset Driver Program

Installs the NVIDIA® Chipset drivers for the NVIDIA® nForce™ 4 SLI chipset.

AMD Cool 'n' Quiet Driver

Installs the AMD Cool 'n' Quiet™ technology driver.

SoundMAX ADI1988 Audio Driver

Installs the SoundMAX® ADI1988 audio driver and application.

Marvell 614x Windows XP/2003 RAID Driver

Installs the Marvell® 614x Windows XP/2003 RAID driver.

Marvell GUI Program

USB 2.0 Driver

Installs the Universal Serial Bus 2.0 (USB 2.0) driver.

5.2.3 Utilities menu

The Utilities menu shows the applications and other software that the motherboard supports.



ASUS InstAll - Installation Wizard for Utilities

Launches the ASUS InstallAll utilities installation wizard.

ASUS Cool 'n' Quiet Utility

Installs the AMD Cool 'n' Quiet™ software.

ASUS PC Probe II

This smart utility monitors the fan speed, CPU temperature, and system voltages, and alerts you of any detected problems. This utility helps you keep your computer in healthy operating condition.

ASUS Update

The ASUS Update utility allows you to update the motherboard BIOS in Windows® environment. This utility requires an Internet connection either through a network or an Internet Service Provider (ISP).

Adobe Acrobat Reader V7.0

Installs the Adobe® Acrobat® Reader that allows you to open, view, and print documents in Portable Document Format (PDF).

Microsoft DirectX 9.0c

Installs the Microsoft® DirectX 9.0c driver. The Microsoft DirectX® 9.0c is a multimedia technology that enhances computer graphics and sound. DirectX® improves the multimedia features of your computer so you can enjoy watching TV and movies, capturing videos, or playing games in your computer. Visit the Microsoft website (www.microsoft.com) for updates.

ASUS AI Booster

The ASUS AI Booster application allows you to overclock the CPU speed in Windows® environment.

ASUS AI Nap

ASUS AI Gear

Anti-virus Utility

The anti-virus application scans, identifies, and removes computer viruses. View the online help for detailed information.

ASUS Screen Saver

Bring life to your computer screen by installing the ASUS screen saver.

5.2.4 Make Disk menu

The Make Disk menu contains items to create the NVIDIA® nForce™ 4 or Silicon Image SATA/PATA RAID driver disk.



Make nVidia 32bit/64bit SATA RAID Driver

Allows you to create an NVIDIA® Serial ATA RAID driver disk for a 32-bit/64-bit system.

Marvell 614x RAID Driver Disk

Allows you to create a Marvell 614x RAID driver disk.

5.2.5 Manuals menu

The Manuals menu contains a list of supplementary user manuals. Click an item to open the folder of the user manual.



Most user manual files are in Portable Document Format (PDF). Install the Adobe® Acrobat® Reader from the Utilities menu before opening a user manual file.



5.2.6 ASUS Contact information

Click the Contact tab to display the ASUS contact information. You can also find this information on the inside front cover of this user guide.



5.2.7 Other information

The icons on the top right corner of the screen give additional information on the motherboard and the contents of the support CD. Click an icon to display the specified information.

Motherboard Info

Displays the general specifications of the motherboard.



Browse this CD

Displays the support CD contents in graphical format.

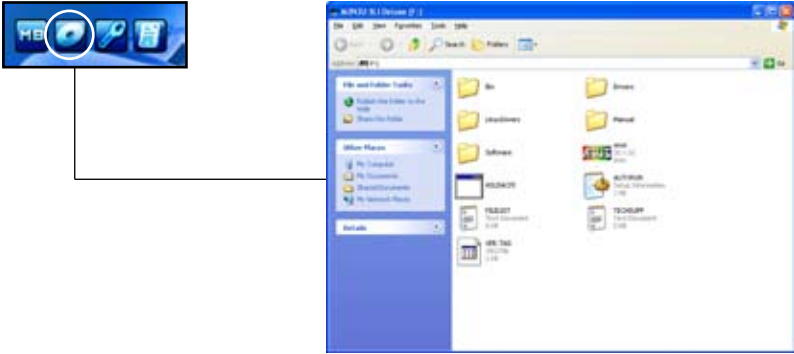

Technical support Form

Displays the ASUS Technical Support Request Form that you have to fill out when requesting technical support.

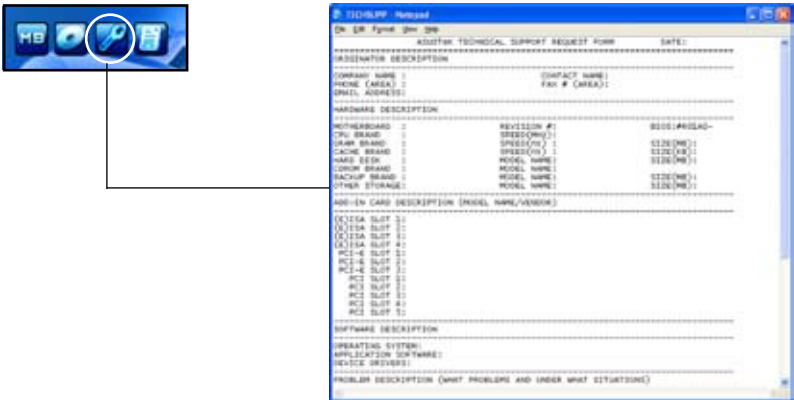

Free Manuals Download Website

<http://myh66.com>

<http://usermanuals.us>

<http://www.somanuals.com>

<http://www.4manuals.cc>

<http://www.manual-lib.com>

<http://www.404manual.com>

<http://www.luxmanual.com>

<http://aubethermostatmanual.com>

Golf course search by state

<http://golfingnear.com>

Email search by domain

<http://emailbydomain.com>

Auto manuals search

<http://auto.somanuals.com>

TV manuals search

<http://tv.somanuals.com>