

Z87M-PLUS

ASUS[®]

Motherboard

E7920
First Edition
April 2013

Copyright® 2013 ASUSTeK COMPUTER INC. All Rights Reserved.

No part of this manual, including the products and software described in it, may be reproduced, transmitted, transcribed, stored in a retrieval system, or translated into any language in any form or by any means, except documentation kept by the purchaser for backup purposes, without the express written permission of ASUSTeK COMPUTER INC. ("ASUS").

Product warranty or service will not be extended if: (1) the product is repaired, modified or altered, unless such repair, modification of alteration is authorized in writing by ASUS; or (2) the serial number of the product is defaced or missing.

ASUS PROVIDES THIS MANUAL "AS IS" WITHOUT WARRANTY OF ANY KIND, EITHER EXPRESS OR IMPLIED, INCLUDING BUT NOT LIMITED TO THE IMPLIED WARRANTIES OR CONDITIONS OF MERCHANTABILITY OR FITNESS FOR A PARTICULAR PURPOSE. IN NO EVENT SHALL ASUS, ITS DIRECTORS, OFFICERS, EMPLOYEES OR AGENTS BE LIABLE FOR ANY INDIRECT, SPECIAL, INCIDENTAL, OR CONSEQUENTIAL DAMAGES (INCLUDING DAMAGES FOR LOSS OF PROFITS, LOSS OF BUSINESS, LOSS OF USE OR DATA, INTERRUPTION OF BUSINESS AND THE LIKE), EVEN IF ASUS HAS BEEN ADVISED OF THE POSSIBILITY OF SUCH DAMAGES ARISING FROM ANY DEFECT OR ERROR IN THIS MANUAL OR PRODUCT.

SPECIFICATIONS AND INFORMATION CONTAINED IN THIS MANUAL ARE FURNISHED FOR INFORMATIONAL USE ONLY, AND ARE SUBJECT TO CHANGE AT ANY TIME WITHOUT NOTICE, AND SHOULD NOT BE CONSTRUED AS A COMMITMENT BY ASUS. ASUS ASSUMES NO RESPONSIBILITY OR LIABILITY FOR ANY ERRORS OR INACCURACIES THAT MAY APPEAR IN THIS MANUAL, INCLUDING THE PRODUCTS AND SOFTWARE DESCRIBED IN IT.

Products and corporate names appearing in this manual may or may not be registered trademarks or copyrights of their respective companies, and are used only for identification or explanation and to the owners' benefit, without intent to infringe.

Offer to Provide Source Code of Certain Software

This product contains copyrighted software that is licensed under the General Public License ("GPL"), under the Lesser General Public License Version ("LGPL") and/or other Free Open Source Software Licenses. Such software in this product is distributed without any warranty to the extent permitted by the applicable law. Copies of these licenses are included in this product.

Where the applicable license entitles you to the source code of such software and/or other additional data, you may obtain it for a period of three years after our last shipment of the product, either

(1) for free by downloading it from <http://support.asus.com/download>

or

(2) for the cost of reproduction and shipment, which is dependent on the preferred carrier and the location where you want to have it shipped to, by sending a request to:

ASUSTeK Computer Inc.
Legal Compliance Dept.
15 Li Te Rd.,
Beitou, Taipei 112
Taiwan

In your request please provide the name, model number and version, as stated in the About Box of the product for which you wish to obtain the corresponding source code and your contact details so that we can coordinate the terms and cost of shipment with you.

The source code will be distributed WITHOUT ANY WARRANTY and licensed under the same license as the corresponding binary/object code.

This offer is valid to anyone in receipt of this information.

ASUSTeK is eager to duly provide complete source code as required under various Free Open Source Software licenses. If however you encounter any problems in obtaining the full corresponding source code we would be much obliged if you give us a notification to the email address gpl@asus.com, stating the product and describing the problem (please DO NOT send large attachments such as source code archives, etc. to this email address).

Contents

| | |
|---|-------------|
| Safety information..... | vi |
| About this guide..... | vii |
| Z87M-PLUS specifications summary | ix |
| Package contents..... | xiii |
| Installation tools and components..... | xiv |
| Chapter 1: Product Introduction | |
| 1.1 Special features..... | 1-1 |
| 1.1.1 Product highlights..... | 1-1 |
| 1.1.2 DIGI+ VRM Digital Power Design | 1-2 |
| 1.1.3 ASUS Exclusive Features | 1-2 |
| 1.1.4 ASUS Quiet Thermal Solution..... | 1-3 |
| 1.1.5 ASUS EZ DIY..... | 1-4 |
| 1.1.6 Other special features | 1-4 |
| 1.2 Motherboard overview..... | 1-5 |
| 1.2.1 Before you proceed..... | 1-5 |
| 1.2.2 Motherboard layout | 1-6 |
| 1.2.3 Central Processing Unit (CPU) | 1-8 |
| 1.2.4 System memory | 1-9 |
| 1.2.5 Expansion slots..... | 1-16 |
| 1.2.6 Jumpers | 1-18 |
| 1.2.7 Onboard buttons and switches..... | 1-19 |
| 1.2.8 Onboard LEDs | 1-21 |
| 1.2.9 Internal connectors..... | 1-22 |
| Chapter 2: Basic installation | |
| 2.1 Building your PC system..... | 2-1 |
| 2.1.1 Motherboard installation..... | 2-1 |
| 2.1.2 CPU installation..... | 2-3 |
| 2.1.3 CPU heatsink and fan assembly installation | 2-4 |
| 2.1.4 DIMM installation..... | 2-6 |
| 2.1.5 ATX Power connection..... | 2-7 |
| 2.1.6 SATA device connection..... | 2-8 |
| 2.1.7 Front I/O Connector | 2-9 |
| 2.1.8 Expansion Card installation..... | 2-10 |
| 2.2 Motherboard rear and audio connections | 2-11 |
| 2.2.1 Rear I/O connection | 2-11 |
| 2.2.2 BIOS update utility | 2-13 |
| 2.2.3 Audio I/O connections | 2-14 |
| 2.3 Starting up for the first time..... | 2-16 |
| 2.4 Turning off the computer..... | 2-16 |

Chapter 3: BIOS setup

| | | |
|-------------|---|-------------|
| 3.1 | Knowing BIOS | 3-1 |
| 3.2 | BIOS setup program | 3-2 |
| | 3.2.1 EZ Mode | 3-3 |
| | 3.2.2 Advanced Mode | 3-4 |
| 3.3 | My Favorites | 3-6 |
| 3.4 | Main menu | 3-7 |
| 3.5 | Ai Tweaker menu | 3-9 |
| 3.6 | Advanced menu | 3-22 |
| | 3.6.1 CPU Configuration | 3-23 |
| | 3.6.2 PCH Configuration | 3-26 |
| | 3.6.3 SATA Configuration | 3-27 |
| | 3.6.4 System Agent Configuration | 3-29 |
| | 3.6.5 USB Configuration | 3-31 |
| | 3.6.6 Platform Misc Configuration | 3-32 |
| | 3.6.7 Onboard Devices Configuration | 3-33 |
| | 3.6.8 APM | 3-35 |
| | 3.6.9 Network Stack | 3-36 |
| 3.7 | Monitor menu | 3-37 |
| 3.8 | Boot menu | 3-40 |
| 3.9 | Tools menu | 3-46 |
| | 3.9.1 ASUS EZ Flash 2 Utility | 3-46 |
| | 3.9.2 ASUS O.C. Profile | 3-46 |
| | 3.9.3 ASUS SPD Information | 3-47 |
| 3.10 | Exit menu | 3-48 |
| 3.11 | Updating BIOS | 3-49 |
| | 3.11.1 ASUS Update | 3-49 |
| | 3.11.2 ASUS EZ Flash 2 | 3-53 |
| | 3.11.3 ASUS CrashFree BIOS 3 | 3-54 |
| | 3.11.4 ASUS BIOS Updater | 3-55 |

Chapter 4: Software support

| | | |
|------------|---|------------|
| 4.1 | Installing an operating system | 4-1 |
| 4.2 | Support DVD information | 4-1 |
| | 4.2.1 Running the support DVD | 4-1 |
| | 4.2.2 Obtaining the software manuals | 4-2 |
| 4.3 | Software information | 4-3 |
| | 4.3.1 AI Suite 3 | 4-3 |
| | 4.3.2 USB 3.0 Boost | 4-5 |
| | 4.3.3 USB BIOS Flashback Wizard | 4-6 |

| | | |
|-------|---------------------------|------|
| 4.3.4 | Network iControl..... | 4-8 |
| 4.3.5 | USB Charger+..... | 4-10 |
| 4.3.6 | System Information..... | 4-11 |
| 4.3.7 | ASUS Update..... | 4-12 |
| 4.3.8 | Audio configurations..... | 4-13 |
| 4.3.9 | ASUS Boot Setting..... | 4-14 |

Chapter 5: RAID support

| | | |
|------------|--|------------|
| 5.1 | RAID configurations | 5-1 |
| 5.1.1 | RAID definitions | 5-1 |
| 5.1.2 | Installing Serial ATA hard disks | 5-2 |
| 5.1.3 | Setting the RAID item in BIOS | 5-2 |
| 5.1.4 | Intel® Rapid Storage Technology Option ROM utility | 5-3 |
| 5.2 | Creating a RAID driver disk..... | 5-7 |
| 5.2.1 | Creating a RAID driver disk without entering the OS..... | 5-7 |
| 5.2.2 | Creating a RAID driver disk in Windows®..... | 5-8 |
| 5.2.3 | Installing the RAID driver during Windows® OS installation | 5-8 |

Chapter 6: Intel® technologies

| | | |
|------------|---|-------------|
| 6.1 | Intel® Smart Response Technology | 6-3 |
| 6.2 | Intel® Rapid Start Technology | 6-5 |
| 6.3 | Intel® Smart Connect Technology | 6-12 |

Chapter 7: Multiple GPU support

| | | |
|------------|---|------------|
| 7.1 | Requirements | 7-1 |
| 7.2 | Before you begin..... | 7-1 |
| 7.3 | Installing AMD® CrossFireX™ graphics cards | 7-2 |
| 7.4 | Installing the device drivers..... | 7-3 |
| 7.5 | Enabling the AMD® CrossFireX™ technology | 7-3 |

Appendices

| | |
|--------------------------------------|------------|
| Notices | A-1 |
| ASUS contact information..... | A-3 |

Safety information

Electrical safety

- To prevent electrical shock hazard, disconnect the power cable from the electrical outlet before relocating the system.
- When adding or removing devices to or from the system, ensure that the power cables for the devices are unplugged before the signal cables are connected. If possible, disconnect all power cables from the existing system before you add a device.
- Before connecting or removing signal cables from the motherboard, ensure that all power cables are unplugged.
- Seek professional assistance before using an adapter or extension cord. These devices could interrupt the grounding circuit.
- Ensure that your power supply is set to the correct voltage in your area. If you are not sure about the voltage of the electrical outlet you are using, contact your local power company.
- If the power supply is broken, do not try to fix it by yourself. Contact a qualified service technician or your retailer.

Operation safety

- Before installing the motherboard and adding devices on it, carefully read all the manuals that came with the package.
- Before using the product, ensure all cables are correctly connected and the power cables are not damaged. If you detect any damage, contact your dealer immediately.
- To avoid short circuits, keep paper clips, screws, and staples away from connectors, slots, sockets and circuitry.
- Avoid dust, humidity, and temperature extremes. Do not place the product in any area where it may become wet.
- Place the product on a stable surface.
- If you encounter technical problems with the product, contact a qualified service technician or your retailer.

About this guide

This user guide contains the information you need when installing and configuring the motherboard.

How this guide is organized

This guide contains the following parts:

- **Chapter 1: Product introduction**
This chapter describes the features of the motherboard and the new technology it supports. It includes description of the switches, jumpers, and connectors on the motherboard.
- **Chapter 2: Basic installation**
This chapter lists the hardware setup procedures that you have to perform when installing system components.
- **Chapter 3: BIOS setup**
This chapter tells how to change system settings through the BIOS Setup menus. Detailed descriptions of the BIOS parameters are also provided.
- **Chapter 4: Software support**
This chapter describes the contents of the support DVD that comes with the motherboard package and the software.
- **Chapter 5: RAID support**
This chapter describes the RAID configurations.
- **Chapter 6: Intel® technologies**
This chapter tells how to install the Intel® 2013 desktop responsiveness technologies.
- **Chapter 7: Multiple GPU support**
This chapter describes how to install and configure multiple ATI® CrossFireX™ graphics cards.

Where to find more information

Refer to the following sources for additional information and for product and software updates.

1. **ASUS websites**
The ASUS website provides updated information on ASUS hardware and software products. Refer to the ASUS contact information.
2. **Optional documentation**
Your product package may include optional documentation, such as warranty flyers, that may have been added by your dealer. These documents are not part of the standard package.

Conventions used in this guide

To ensure that you perform certain tasks properly, take note of the following symbols used throughout this manual.



DANGER/WARNING: Information to prevent injury to yourself when trying to complete a task.



CAUTION: Information to prevent damage to the components when trying to complete a task.



IMPORTANT: Instructions that you **MUST** follow to complete a task.



NOTE: Tips and additional information to help you complete a task.

Typography

Bold text

Indicates a menu or an item to select.

Italics

Used to emphasize a word or a phrase.

<Key>

Keys enclosed in the less-than and greater-than sign means that you must press the enclosed key.

Example: <Enter> means that you must press the Enter or Return key.

<Key1> + <Key2> + <Key3>

If you must press two or more keys simultaneously, the key names are linked with a plus sign (+).

Z87M-PLUS specifications summary

| | |
|--------------------------|---|
| CPU | <p>LGA1150 socket for Intel® 4th Generation Core™ i7 / Core™ i5 / Core™ i3, Pentium®, and Celeron® processors</p> <p>Supports 22nm CPU</p> <p>Supports Intel® Turbo Boost Technology 2.0*</p> <p>* The Intel® Turbo Boost Technology 2.0 support depends on the CPU types.</p> <p>** Refer to www.asus.com for Intel® CPU support list.</p> |
| Chipset | Intel® Z87 Express Chipset |
| Memory | <p>4 x DIMM, max. 32GB, DDR3 2800 (O.C.) / 2666 (O.C.) / 2600 (O.C.) / 2400 (O.C.) / 2200 (O.C.) / 2133 (O.C.) / 2000 (O.C.) / 1866 (O.C.) / 1600 / 1333 MHz, non-ECC, un-buffered memory*</p> <p>Dual-channel memory architecture</p> <p>Supports Intel® Extreme Memory Profile (XMP)</p> <p>* Hyper DIMM support is subject to the physical characteristics of individual CPUs. Please refer to Memory QVL (Qualified Vendors List) for details.</p> <p>** Refer to www.asus.com or this user manual for the Memory QVL (Qualified Vendors List).</p> |
| Expansion slots | <p>1 x PCI Express 3.0/2.0 x16 slot [yellow] (at x16 mode)</p> <p>1 x PCI Express 2.0 x16 slot [dark brown] (run at x4 mode, compatible with PCIe x1 and x4 devices)</p> <p>2 x PCI Express 2.0 x1 slots</p> <p>* The PCIe x16_2 slot shares bandwidth with PCIe x1_2 slot. The default setting is x2 mode. Go to the BIOS setup to change the settings.</p> |
| VGA | <p>Integrated Graphics Processor - Intel® HD Graphics support</p> <p>Multi-VGA output support: HDMI/DVI-D/RGB port</p> <p>Supports HDMI with max. resolution of 4096 x 2160 @24Hz and 2560 x 1600 @60Hz</p> <p>Supports DVI-D with max. resolution of 1920 x 1200 @60Hz</p> <p>Supports RGB with max. resolution of 1920 x 1200 @60Hz</p> <p>Supports Intel® InTru™ 3D, Intel® Quick Sync Video, Intel® Clear Video HD Technology, and Intel® Insider™</p> <p>Supports up to three displays simultaneously</p> <p>Maximum shared memory 1024MB</p> |
| Multi-GPU support | Supports AMD® Quad-GPU CrossFireX™ Technology |
| Storage | <p>Intel® Z87 Express Chipset</p> <ul style="list-style-type: none"> - 6 x SATA 6.0 Gb/s ports (yellow) with RAID 0, 1, 5, 10 and Intel® Rapid Start Technology 12 support - Supports Intel® Dynamic Storage Accelerator, Intel® Smart Response Technology, Intel® Rapid Start Technology, and Intel® Smart Connect Technology* <p>* These functions will work depending on the CPU installed.</p> |
| LAN | Realtek® 8111GR Gigabit LAN controller |
| Audio | <p>Realtek® ALC887 8-channel high definition audio CODEC</p> <ul style="list-style-type: none"> - Supports jack-detection, multi-streaming, and front panel jack-retasking - Optical S/PDIF out ports at back I/O |

(continued on the next page)

Z87M-PLUS specifications summary

| | |
|-----------------------------|---|
| USB | Intel® Z87 Express Chipset - supports ASUS USB 3.0 Boost <ul style="list-style-type: none">- 2 x USB 3.0/2.0 ports at mid-board for front panel support- 4 x USB 3.0/2.0 ports at rear panel (blue) Intel® Z87 Express Chipset <ul style="list-style-type: none">- 8 x USB 2.0/1.1 ports (6 ports at mid-board, 2 ports at rear panel) |
| ASUS unique features | ASUS Digital Power Design <ul style="list-style-type: none">- Digital Power Control: Digital Power Design for the CPU and iGPU- ASUS 4 Phase Power Design- ASUS CPU power utility ASUS Fuse protection - ASUS ESD Guards - Enhanced ESD protection ASUS 100% All High-quality Conductive Polymer Capacitors <ul style="list-style-type: none">- 2.5x Longer Lifespan, excellent durability (5k hrs) ASUS Extra Durable Stainless Steel Back I/O - 3x longer lifespan ASUS Exclusive Features <ul style="list-style-type: none">- ASUS EPU- ASUS TurboV- ASUS Network iControl featuring instant network bandwidth domination for top network program in use- USB 3.0 Boost featuring speedy USB 3.0 transmission- ASUS Disk Unlocker featuring 3TB+ HDD support- AI Charger- ASUS GPU Boost- MemOK!- AI Suite 3- Anti Surge ASUS Quiet Thermal Solution <ul style="list-style-type: none">- ASUS Fanless Design: Stylish Heatsink and MOS Heatsink solution- ASUS Fan Xpert 2 featuring Fan Auto Tuning function for optimized speed control, providing an exclusive tailored fan speed setting for each fan ASUS EZ DIY <ul style="list-style-type: none">- ASUS USB BIOS Flashback with USB BIOS Flashback Wizard for EZ BIOS download scheduling- ASUS UEFI BIOS EZ Mode featuring friendly graphics user interface- ASUS O.C. Tuner- ASUS CrashFree BIOS 3- ASUS EZ Flash 2 ASUS Q-Design <ul style="list-style-type: none">- ASUS Q-Slot- ASUS Q-Shield- ASUS Q-DIMM |

(continued on the next page)

Z87M-PLUS specifications summary

| | |
|--|--|
| ASUS exclusive overclocking features | Precision Tweaker 2 <ul style="list-style-type: none"> - vCore: Adjustable CPU voltage at 0.001V increment - vCCIN: Adjustable CPU Input voltage at 0.01V increment - iGPU: Adjustable CPU Graphics voltage at 0.001V increment - vCCSA: Adjustable CPU System Agent voltage at 0.001V increment - vCCIO: Adjustable Analog and Digital I/O voltage at 0.001V increment - vDRAM Bus: 191-step Memory voltage control - vPCH: 191-step Chipset voltage control SFS (Stepless Frequency Selection) <ul style="list-style-type: none"> - BCLK/PEG frequency tuning from 80MHz up to 300MHz at 0.1MHz increment Overclocking Protection <ul style="list-style-type: none"> - ASUS C.P.R.(CPU Parameter Recall) |
| Back Panel I/O Ports | 1 x PS/2 mouse / keyboard combo port 1 x HDMI port 1 x DVI-D port 1 x RGB port 1 x Optical S/PDIF Out port 1 x LAN (RJ-45) port 4 x USB 3.0/2.0 ports (blue, 1 supports USB BIOS Flashback) 2 x USB 2.0/1.1 ports 6 x audio jacks support 8-channel |
| Internal I/O connectors / jumpers / buttons | 1 x 19-pin USB 3.0/2.0 connector supports additional 2 USB ports 3 x USB 2.0/1.1 connectors support additional 6 USB ports 6 x SATA 6.0 Gb/s connectors 1 x 4-pin CPU Fan connector 2 x 4-pin Chassis Fan connectors 1 x Front panel audio connector (AAFP) 1 x S/PDIF out header 1 x 24-pin EATX Power connector 1 x 8-pin EATX 12V Power connector 1 x MemOK! button 1 x GPU Boost switch 1 x Clear CMOS jumper 1 x TPM header 1 x COM port |
| BIOS features | 64 Mb Flash ROM, UEFI AMI BIOS, PnP, DMI 2.0, WfM 2.0, SM BIOS 2.7, ACPI 4.0a, Multi-language BIOS, ASUS EZ Flash 2, ASUS CrashFree BIOS 3, My Favorites, Quick Note, Last Modified Log, F12 PrintScreen function, F3 Shortcut functions, and ASUS DRAM SPD (Serial Presence Detect) memory information |
| Manageability | WfM 2.0, DMI 2.0, WOL by PME, PXE |

(continued on the next page)

Z87M-PLUS specifications summary



| | |
|-----------------------------|---|
| Support DVD contents | Drivers ASUS Utilities ASUS Update Anti-virus software (OEM version) |
| Form factor | uATX form factor: 9.6 in. x 8.4 in. (24.4 cm x 21.3 cm) |



Specifications are subject to change without notice.

Package contents

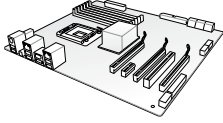

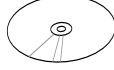
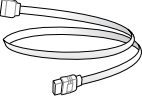
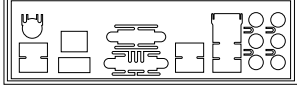
Check your motherboard package for the following items

| | | |
|---|---|---|
|  |  |  |
| ASUS Z87M-PLUS motherboard | User manual | Support DVD |
|  |  | |
| 2 x Serial ATA 6.0 Gb/s cables | 1 x ASUS Q-Shield | |

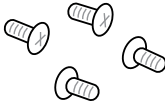

- If any of the above items is damaged or missing, contact your retailer.
- The illustrations above are for reference only. Actual product specifications may vary with different models.

Installation tools and components

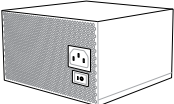
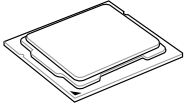
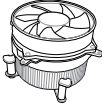
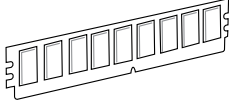
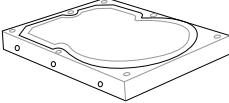
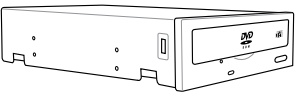
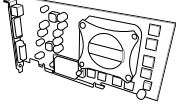
| | |
|---|---|
|  |  |
| 1 bag of screws | Phillips (cross) screwdriver |
|  |  |
| PC chassis | Power supply unit |
|  |  |
| Intel® LGA1150 CPU | Intel® LGA1150 compatible CPU Fan |
|  |  |
| DIMM | SATA hard disk drive |
|  |  |
| SATA optical disc drive (optional) | Graphics card (optional) |



The tools and components in the table above are not included in the motherboard package.

Product introduction

1

1.1 Special features

1.1.1 Product highlights

LGA1150 socket for Intel® 4th Generation Core™ i7 / Core™ i5 / Core™ i3, Pentium®, and Celeron® Processors

This motherboard supports Intel® 4th generation Core™ i7 / Core™ i5 / Core™ i3, Pentium®, and Celeron® processors in the LGA1150 package. It provides great graphics and system performance with its GPU, dual-channel DDR3 memory slots and PCI Express 2.0/3.0 expansion slots.

Intel® Z87 Express Chipset

Intel® Z87 Express Chipset is a single-chipset that supports the 1150 socket Intel® 4th generation Core™ i7 / Core™ i5 / Core™ i3, Pentium® and Celeron® processors. It utilizes the serial point-to-point links, which increases bandwidth and enhances the system's performance. It natively supports up to six USB 3.0 ports for up to ten times faster transfer rate than USB 2.0 and enables the iGPU function for Intel® integrated graphics performance.

PCI Express® 3.0

PCI Express® 3.0 (PCIe 3.0) is the PCI Express bus standard that provides twice the performance and speed of PCIe 2.0. It provides an optimal graphics performance, unprecedented data speed and seamless transition with its complete backward compatibility to PCIe 1.0/2.0 devices.

Dual-Channel DDR3 2800 (O.C.) / 2666 (O.C.) / 2600 (O.C.) / 2400 (O.C.) / 2200 (O.C.) / 2133 (O.C.) / 2000 (O.C.) / 1866 (O.C.) / 1600 / 1333 MHz Support

The motherboard supports the dual-channel DDR3 memory that features data transfer rates of DDR3 2800 (O.C.) / 2666 (O.C.) / 2600 (O.C.) / 2400 (O.C.) / 2200 (O.C.) / 2133 (OC.) / 2000 (O.C.) / 1866 (O.C.) / 1600 / 1333 MHz to boost the system's performance, and to meet the higher bandwidth requirements of 3D graphics, multimedia and Internet applications.

Native SATA 6.0 Gb/s support

With Intel® Z87 Express Chipset natively support for the next-generation Serial ATA (SATA) storage interface, this motherboard delivers up to 6.0 Gb/s data transfer rates. It also provides enhanced scalability, faster data retrieval, double the bandwidth of current bus systems.

Quad-GPU CrossFireX™ Support

This motherboard features the most powerful Intel® Z87 platform that optimizes PCIe allocation in multi-GPU CrossFireX™ solution, giving you a brand-new gaming enjoyment.

S/PDIF out connector at the back I/O

This motherboard provides convenient connectivity to external home theater audio systems via the optical S/PDIF (SONY-PHILIPS Digital Interface) out connector at the back I/O. The S/PDIF transfers digital audio without converting it to analog format and keeps the best signal quality.

100% All High-quality Conductive Polymer Capacitors

This motherboard uses all high-quality conductive polymer capacitors for durability, improved lifespan, and enhanced thermal capacity.

Intel® Smart Response Technology

Intel® Smart Response Technology, an important part of Green ASUS eco-friendly computing, reduces load and wait time, eliminates unnecessary hard drive spin thus lowering power usage, and uses an installed SSD (requires 18.6 GB available space) as a cache for frequently accessed data or applications. It combines SSD performance and hard drive capacity, operating up to six times faster than a hard-drive-only system to boost the system's overall performance.

* 4th generation Intel® Core™ processors support Intel® Smart Response Technology.

** An operating system must be installed on the HDD to launch Intel® Smart Response Technology.

*** The SSD is reserved for caching function.

Intel® Smart Connect Technology

Your computer can receive fresh updates for selected applications, even when the system is in sleep mode. This means less time waiting for applications to update and sync with the cloud, leading to a more efficient computing experience.

Intel® Rapid Start Technology

Intel® Rapid Start Technology allows your system to receive updates for your web applications in real-time even when your system is in sleep mode, saving wait time and power usage.

1.1.2 DIGI+ VRM Digital Power Design

DIGI+ VRM

All-new digital CPU power controls work perfectly together to match digital power signal (SVID) requests from the CPU, with ultra-fast sensing and response efficiently delivering precision power. Accurate delivery reduces waste, and provides more stable CPU Vcore voltages. Users can adjust CPU PWM voltages and frequencies for various overclocking scenarios, with accurate input through UEFI BIOS tuning or the exclusive ASUS interface. This proprietary design increases overclocking headroom to push performance to its full potential.

EPU

Tap into the world's first real-time PC power saving chip through a simple onboard switch or AI Suite II utility. Get total system-wide energy optimization by automatically detecting current PC loadings and intelligently moderating power consumption. This also reduces fan noise and extends component longevity.

1.1.3 ASUS Exclusive Features

GPU Boost

GPU Boost accelerates the integrated GPU for extreme graphics performance, facilitates flexible frequency adjustments and easily delivers stable system-level upgrades for every use.

USB 3.0 Boost

ASUS USB 3.0 Boost, which supports USB 3.0 standard UASP (USB Attached SCSI Protocol), significantly increases a USB device's transfer speed up to 170% faster than the already impressive USB 3.0 transfer speed. It automatically accelerates data speeds for compatible USB 3.0 peripherals without the need for any user interaction.

Network iControl

Network iControl is an intuitive one-step network control center that makes it easier for you to manage your bandwidth and allows you to set, monitor and schedule the bandwidth priorities for your network programs.

AI Suite 3

With its user-friendly interface, ASUS AI Suite 3 consolidates all the exclusive ASUS features into one simple-to-use software package. It allows you to supervise overclocking, energy management, fan speed control, voltage and sensor readings. This all-in-one software offers diverse and ease to use functions, with no need to switch back and forth between different utilities.

MemOK!

MemOK!, the remarkable memory rescue tool, allows you to simply press a button to patch memory issues, ensure memory boot compatibility, determine fail-safe settings, and dramatically improve the system's bootup.

ASUS Anti-Surge

This special design protects expensive devices and the motherboard from damage caused by power surges from switching power supply unit (PSU).

1.1.4 ASUS Quiet Thermal Solution

ASUS Fanless Design: stylish heatsink solution

The stylish heatsink features a 0-dB thermal solution that offers you a noiseless PC environment. The heatsink design also lowers the temperature of the chipset and power phase area through high efficient heat-exchange. Combined with usability and aesthetics, the ASUS stylish heatsink will give you an extremely silent and cooling experience with its elegant appearance.

ASUS Fan Xpert 2

ASUS Fan Xpert 2 provides customizable settings for a cooler and quieter computing environment. With its Fan Auto Tuning feature, ASUS Fan Xpert 2 automatically detects and tweaks all fan speeds, and provides you with optimized fan settings based on the fans' specifications and positions.

1.1.5 ASUS EZ DIY

ASUS UEFI BIOS

ASUS UEFI BIOS, a UEFI compliant architecture, offers the first mouse-controlled intuitive graphical BIOS interface that goes beyond the traditional keyboard-only BIOS controls, providing you with more flexibility, convenience, and easy to navigate UEFI BIOS than the traditional BIOS versions. It offers you with dual selectable modes and native support for hard drives larger than 2.2 TB.

ASUS UEFI BIOS includes the following new features:

- New My Favorite function allows you to quickly access the frequently used items
- New Quick Note function allows you to take notes in the BIOS environment
- New log reminder allows you to view all your modified settings
- F12 BIOS snapshot hotkey
- F3 Shortcut for most accessed information
- ASUS DRAM SPD (Serial Presence Detect) information detecting faulty DIMMs, and helping with difficult POST situations.

USB BIOS Flashback

USB BIOS Flashback offers a hassle-free updating solution for your ultimate convenience. Install a USB storage device containing the BIOS file, press the reset button on your chassis for about three seconds, and the UEFI BIOS is automatically updated even without entering the existing BIOS or operating system. It also allows you to regularly check for UEFI BIOS updates, and download the latest BIOS automatically.

ASUS Q-shield

ASUS Q-Shield's special design makes it convenient and easy to install on your motherboard. With better electric conductivity, it ideally protects your motherboard against static electricity and shields it against EMI (Electronic Magnetic Interference).

ASUS Q-connector

ASUS Q-Connector is a unique adapter that allows you to easily connect or disconnect the chassis front panel cables to one module, eliminating the hassle of plugging one cable at a time and making the connection quick and accurate.

1.1.6 Other special features

HDMI Support

High Definition Multimedia Surface (HDMI) is a set of digital video standards that delivers multichannel audio and uncompressed digital video up to 4K/2K resolution visuals through a single cable. Supporting HDCP copy protection such as HD DVD and blu-ray discs, HDMI provides you with the highest quality home theater experience.

ErP Ready

The motherboard is European Union's Energy-related Products (ErP) ready, and ErP requires products to meet certain energy efficiency requirements in regards to energy consumptions. This is in line with ASUS vision of creating environment-friendly and energy-efficient products through product design and innovation to reduce carbon footprint of the product and thus mitigate environmental impacts.

1.2 Motherboard overview

1.2.1 Before you proceed

Take note of the following precautions before you install motherboard components or change any motherboard settings.



-
- Unplug the power cord from the wall socket before touching any component.
 - Before handling components, use a grounded wrist strap or touch a safely grounded object or a metal object, such as the power supply case, to avoid damaging them due to static electricity.
 - Hold components by the edges to avoid touching the ICs on them.
 - Whenever you uninstall any component, place it on a grounded antistatic pad or in the bag that came with the component.
 - Before you install or remove any component, ensure that the ATX power supply is switched off or the power cord is detached from the power supply. Failure to do so may cause severe damage to the motherboard, peripherals, or components.
-

1.2.2 Motherboard layout

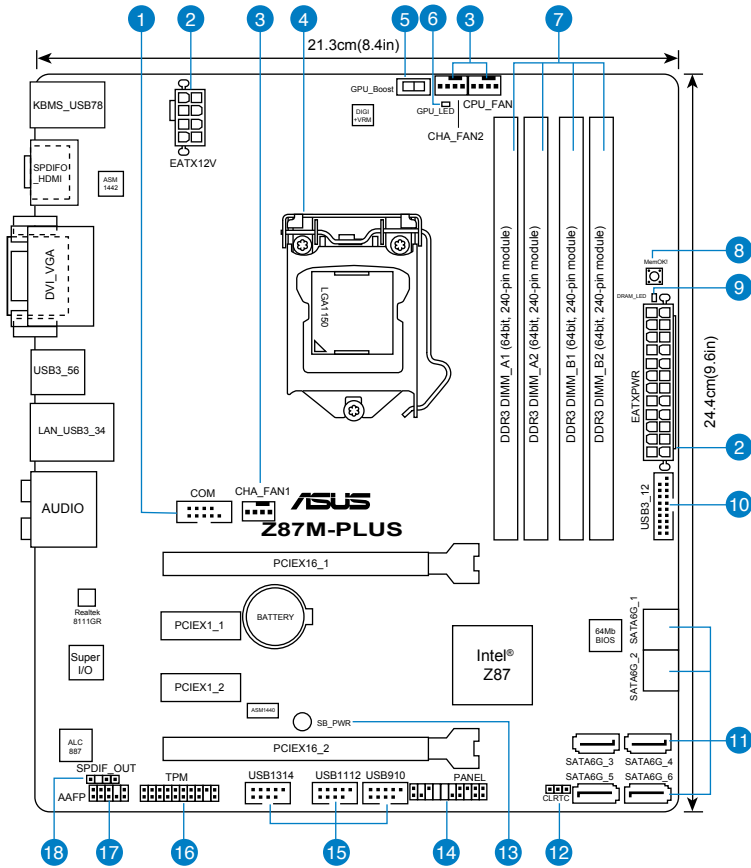

Refer to 1.2.9 Internal connectors and 2.2.1 Rear I/O connection for more information about rear panel connectors and internal connectors.

Layout contents

| Connectors/Jumpers/Slots | Page |
|---|------|
| 1. Serial port connector (10-1 pin COM) | |
| 2. ATX power connectors (24-pin EATXPWR, 8-pin EATX12V) | |
| 3. CPU and chassis fan connectors (4-pin CPU_FAN, 4-pin CHA_FAN1-2) | |
| 4. LGA1150 CPU socket | |
| 5. GPU Boost switch | |
| 6. GPU Boost LED (GPU_LED) | |
| 7. DDR3 DIMM slots | |
| 8. MemOK! button | |
| 9. DRAM LED (DRAM_LED) | |
| 10. USB 3.0 connector (20-1 pin USB3_12) | |
| 11. Intel® Z87 Serial ATA 6.0 Gb/s connectors (7-pin SATA6G_1-6) | |
| 12. Clear RTC RAM (3-pin CLRRTC) | |
| 13. Standby power LED (SB_PWR) | |
| 14. System panel connector (20-8 pin PANEL) | |
| 15. USB 2.0 connectors (10-1 pin USB910, USB1112, USB1314) | |
| 16. TPM header (20-1 pin TPM) | |
| 17. Front panel audio connector (10-1 pin AAFP) | |
| 18. Digital audio connector (4-1 pin SPDIF_OUT) | |

1.2.3 Central Processing Unit (CPU)

The motherboard comes with a surface mount LGA1150 socket designed for Intel® 4th Generation Core™ i7 / Core™ i5 / Core™ i3, Pentium™, and Celeron™ processors.

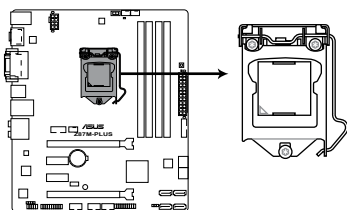

Z87M-PLUS CPU socket LGA1150



-
- Ensure that all power cables are unplugged before installing the CPU.
 - Ensure that you install the correct CPU designed for LGA1150 only. DO NOT install a CPU designed for LGA1155 and LGA1156 sockets on the LGA1150 socket.
 - Upon purchase of the motherboard, ensure that the PnP cap is on the socket and the socket contacts are not bent. Contact your retailer immediately if the PnP cap is missing, or if you see any damage to the PnP cap/socket contacts/motherboard components. ASUS will shoulder the cost of repair only if the damage is shipment/transit-related.
 - Keep the cap after installing the motherboard. ASUS will process Return Merchandise Authorization (RMA) requests only if the motherboard comes with the cap on the LGA1150 socket.
 - The product warranty does not cover damage to the socket contacts resulting from incorrect CPU installation/removal, or misplacement/loss/incorrect removal of the PnP cap.
-

1.2.4 System memory

The motherboard comes with four Double Data Rate 3 (DDR3) Dual Inline Memory Modules (DIMM) slots.



A DDR3 module is notched differently from a DDR or DDR2 module. DO NOT install a DDR or DDR2 memory module to the DDR3 slot.

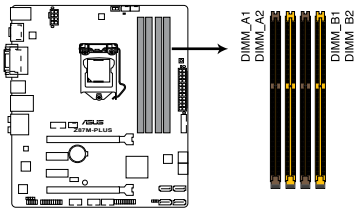

Z87M-PLUS 240-pin DDR3 DIMM sockets

Recommended memory configurations

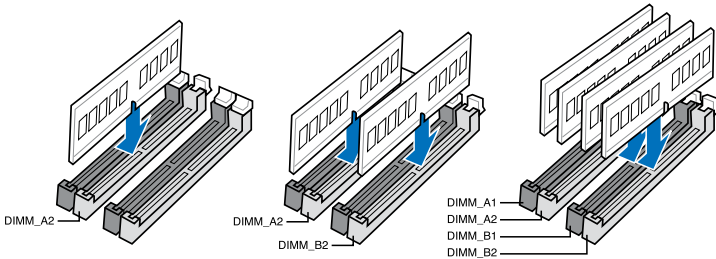

Memory configurations

You may install 1GB, 2GB, 4GB, and 8GB unbuffered and non-ECC DDR3 DIMMs into the DIMM sockets.



-
- You may install varying memory sizes in Channel A and Channel B. The system maps the total size of the lower-sized channel for the dual-channel configuration. Any excess memory from the higher-sized channel is then mapped for single-channel operation.
 - According to Intel CPU spec, DIMM voltage below 1.65V is recommended to protect the CPU.
 - Always install DIMMs with the same CAS latency. For optimum compatibility, we recommend that you obtain memory modules from the same vendor.
 - Due to the memory address limitation on 32-bit Windows® OS, when you install 4GB or more memory on the motherboard, the actual usable memory for the OS can be about 3GB or less. For effective use of memory, we recommend that you do any of the following:
 - a) Use a maximum of 3GB system memory if you are using a 32-bit Windows® OS.
 - b) Install a 64-bit Windows® OS when you want to install 4GB or more on the motherboard.
 - c) For more details, refer to the Microsoft® support site at <http://support.microsoft.com/kb/929605/en-us>.
 - This motherboard does not support DIMMs made up of 512Mb (64MB) chips or less (Memory chip capacity counts in Megabit, 8 Megabit/Mb = 1 Megabyte/MB).
-



-
- The default memory operation frequency is dependent on its Serial Presence Detect (SPD), which is the standard way of accessing information from a memory module. Under the default state, some memory modules for overclocking may operate at a lower frequency than the vendor-marked value. To operate at the vendor-marked or at a higher frequency, refer to section **3.5 Ai Tweaker menu** for manual memory frequency adjustment.
 - For system stability, use a more efficient memory cooling system to support a full memory load (4 DIMMs) or overclocking condition.
 - Memory modules with memory frequency higher than 2133MHz and their corresponding timing or the loaded XMP profile is not the JEDEC memory standard. The stability and compatibility of the memory modules depend on the CPU's capabilities and other installed devices.
 - Always install the DIMMs with the same CAS Latency. For an optimum compatibility, we recommend that you install memory modules of the same version or data code (D/C) from the same vendor. Check with the vendor to get the correct memory modules.
-

Z87M-PLUS Motherboard Qualified Vendors Lists (QVL)

DDR3 2800(O.C.) MHz capability

DDR3 2600(O.C.) MHz capability

DDR3 2400(O.C.) MHz capability

DDR3 2200(O.C.) MHz capability

DDR3 2133(O.C.) MHz capability

(continued on the next page)

DDR3 2000(O.C.) MHz capability

DDR3 1866(O.C.) MHz capability

DDR3 1800(O.C.) MHz capability

(continued on the next page)

DDR3 1600 MHz capability

DDR3 1333 MHz capability

(continued on the next page)

DDR3 1333 MHz capability



Side(s): SS - Single-sided DS - Double-sided

DIMM support:

- (1) Supports one (1) module inserted into any slot as Single-channel memory configuration. We suggest that you install the module into A2 slot.
 - (2) Supports two (2) modules inserted into either the yellow slots or the black slots as one pair of Dual-channel memory configuration. We suggest that you install the modules into slots A2 and B2 for better compatibility.
 - (4) Supports four (4) modules inserted into both the yellow and black slots as two pairs of Dual-channel memory configuration.
-



- ASUS exclusively provides hyper DIMM support function.
 - Hyper DIMM support is subject to the physical characteristics of individual CPUs. Load the X.M.P. or D.O.C.P. settings in the BIOS for the hyper DIMM support.
 - Visit the ASUS website for the latest QVL.
-

1.2.5 Expansion slots



Unplug the power cord before adding or removing expansion cards. Failure to do so may cause you physical injury and damage motherboard components.

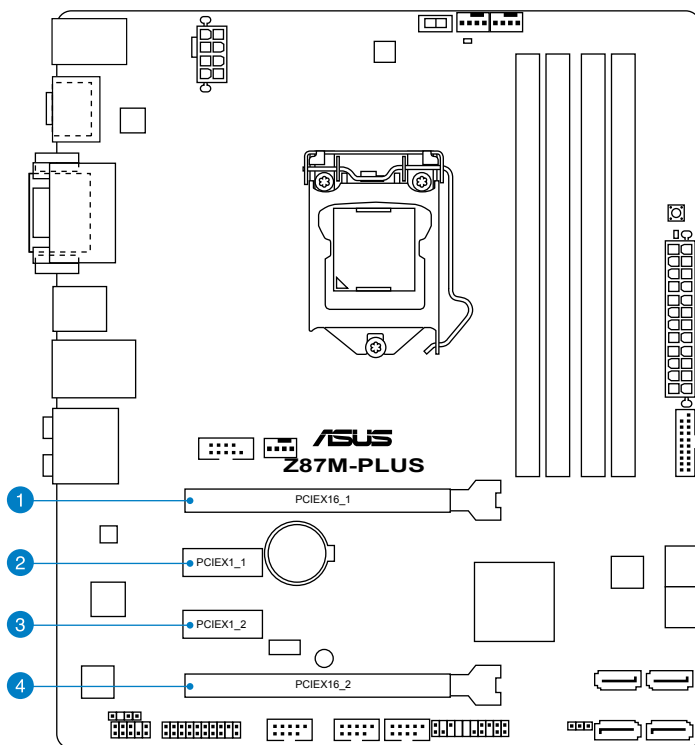

| Slot No. | Slot Description |
|----------|--|
| 1 | PCIe 3.0/2.0 x16_1 slot (at x16 mode) |
| 2 | PCIe 2.0 x1_1 slot |
| 3 | PCIe 2.0 x1_2 slot |
| 4 | PCIe 2.0 x16_2 slot (run at x4 mode, compatible with PCIe x1 and x4 devices) |

| VGA configuration | PCIe Express operating mode | |
|----------------------|------------------------------|----------------|
| | PCIe 3.0/2.0 x16_1 | PCIe 2.0 x16_2 |
| Single VGA/PCIe card | x16 (single VGA recommended) | N/A |
| Dual VGA/PCIe card | x16 | x4 |



- In single VGA card mode, use the PCIe 3.0/2.0 x16_1 slot (yellow) for a PCI Express x16 graphics card to get better performance.
- We recommend that you provide sufficient power when running CrossFireX™ mode.
- Connect a chassis fan to the motherboard connector labeled CHA_FAN1-2 when using multiple graphics cards for better thermal environment.
- The PCIe x16_2 slot shares bandwidth with PCIe x1_2 slot. The default setting is x2 mode. Go to the BIOS setup to change the settings.

IRQ assignments for this motherboard

| | A | B | C | D | E | F | G | H |
|-----------------------|--------|--------|--------|--------|--------|--------|--------|--------|
| PCIe x16_1 | shared | - | - | - | - | - | - | - |
| PCIe x16_2 | - | shared | - | - | - | - | - | - |
| PCIe x1_1 | - | - | - | shared | - | - | - | - |
| PCIe x1_2 | - | shared | - | - | - | - | - | - |
| Intel SATA Controller | - | - | - | shared | - | - | - | - |
| Realtek LAN | - | - | shared | - | - | - | - | - |
| Intel xHCI | - | - | - | - | - | shared | - | - |
| Intel EHCI 1 | - | - | - | - | - | - | - | shared |
| Intel EHCI 2 | - | - | - | - | shared | - | - | - |
| HD Audio | - | - | - | - | - | - | shared | - |

1.2.6 Jumpers

Clear RTC RAM (3-pin CLRRTC)

This jumper allows you to clear the Real Time Clock (RTC) RAM in CMOS. You can clear the CMOS memory of date, time, and system setup parameters by erasing the CMOS RTC RAM data. The onboard button cell battery powers the RAM data in CMOS, which include system setup information such as system passwords.

To erase the RTC RAM:

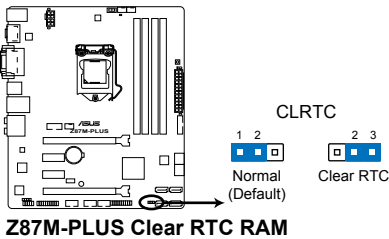

1. Turn OFF the computer and unplug the power cord.
2. Move the jumper cap from pins 1-2 (default) to pins 2-3. Keep the cap on pins 2-3 for about 5~10 seconds, then move the cap back to pins 1-2.
3. Plug the power cord and turn ON the computer.
4. Hold down the **** key during the boot process and enter BIOS setup to reenter data.



Except when clearing the RTC RAM, never remove the cap on CLRRTC jumper default position. Removing the cap will cause system boot failure!



- If the steps above do not help, remove the onboard battery and move the jumper again to clear the CMOS RTC RAM data. After clearing the CMOS, reinstall the battery.
 - You do not need to clear the RTC when the system hangs due to overclocking. For system failure due to overclocking, use the CPU Parameter Recall (C.P.R) feature. Shut down and reboot the system so the BIOS can automatically reset parameter settings to default values.
-

1.2.7 Onboard buttons and switches

Onboard switches and buttons allow you to fine-tune performance when working on a bare or open-case system. This is ideal for overclockers and gamers who continually change settings to enhance system performance.

1. MemOK! button

Installing DIMMs that are not compatible with the motherboard may cause system boot failure, and the DRAM_LED near the MemOK! switch lights continuously. Press and hold the MemOK! button until the DRAM_LED starts blinking to begin automatic memory compatibility tuning for successful boot.

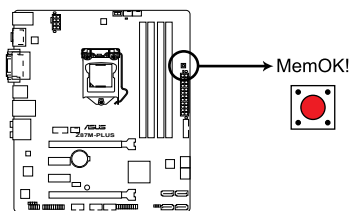

Z87M-PLUS MemOK! button



- Refer to section **1.2.8 Onboard LEDs** for the exact location of the DRAM_LED.
- The DRAM_LED also lights up when the DIMM is not properly installed. Turn off the system and reinstall the DIMM before using the MemOK! function.
- The MemOK! switch does not function under Windows® OS environment.
- During the tuning process, the system loads and tests failsafe memory settings. It takes about 30 seconds for the system to test one set of failsafe settings. If the test fails, the system reboots and test the next set of failsafe settings. The blinking speed of the DRAM_LED increases, indicating different test processes.
- Due to memory tuning requirement, the system automatically reboots when each timing set is tested. If the installed DIMMs still fail to boot after the whole tuning process, the DRAM_LED lights continuously. Replace the DIMMs with ones recommended in the Memory QVL (Qualified Vendors Lists) in this user manual or on the ASUS website at www.asus.com.
- If you turn off the computer and replace DIMMs during the tuning process, the system continues memory tuning after turning on the computer. To stop memory tuning, turn off the computer and unplug the power cord for about 5–10 seconds.
- If your system fails to boot up due to BIOS overclocking, press the MemOK! switch to boot and load the BIOS default settings. A message will appear during POST reminding you that the BIOS has been restored to its default settings.
- We recommend that you download and update to the latest BIOS version from the ASUS website at www.asus.com after using the MemOK! function.

2. GPU Boost switch

This switch allows you to enable or disable the GPU Boost function.

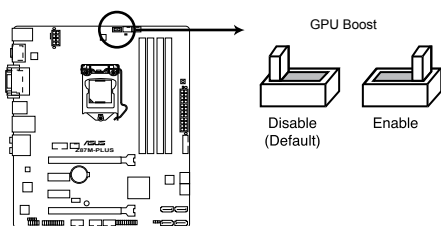

Z87M-PLUS GPU Boost switch



To ensure system performance, turn the switch setting to **Enable** when the system is powered off.



- The GPU Boost LED near the GPU Boost switch lights up when the GPU Boost switch is enabled. Refer to section **1.2.8 Onboard LEDs** for the exact location of the GPU Boost LED.
 - If you enable this switch under the Windows® OS environment, the GPU Boost function will be activated after the next system bootup.
-

1.2.8 Onboard LEDs

1. Standby Power LED

The motherboard comes with a standby power LED that lights up to indicate that the system is ON, in sleep mode, or in soft-off mode. This is a reminder that you should shut down the system and unplug the power cable before removing or plugging in any motherboard component. The illustration below shows the location of the onboard LED.

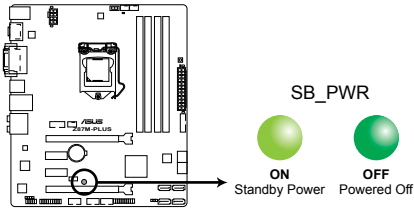

Z87M-PLUS Onboard LED

2. DRAM LED

DRAM LED checks the DRAM in sequence during motherboard booting process. If an error is found, the LED next to the error device will continue lighting until the problem is solved. This user-friendly design provides an intuitional way to locate the root problem within a second.

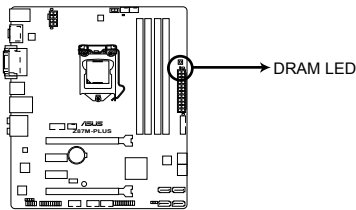

Z87M-PLUS DRAM LED

3. GPU Boost LED

The GPU Boost LED lights up when the GPU Boost switch is enabled.

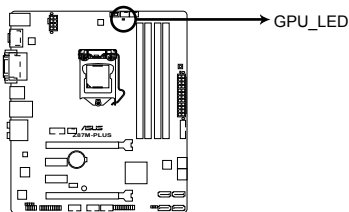

Z87M-PLUS GPU Boost LED

1.2.9 Internal connectors

1. Intel® Z87 Serial ATA 6.0 Gb/s connectors (7-pin SATA6G_1-6)

These connectors connect to Serial ATA 6.0 Gb/s hard disk drives via Serial ATA 6.0 Gb/s signal cables.

If you installed Serial ATA hard disk drives, you can create a RAID 0, 1, 5, and 10 configuration with the Intel® Rapid Storage Technology through the onboard Intel® Z87 chipset.

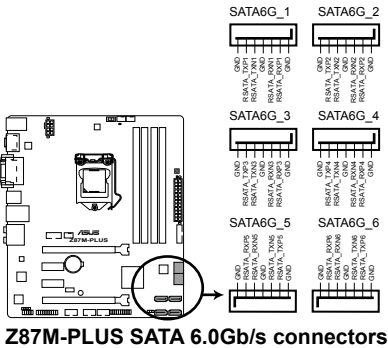

Z87M-PLUS SATA 6.0Gb/s connectors



- These connectors are set to **[AHCI]** by default. If you intend to create a Serial ATA RAID set using these connectors, set the SATA Mode item in the BIOS to **[RAID]**. Refer to section **3.6.3 SATA Configuration** for details.
- Before creating a RAID set, refer to section **5.1 RAID configurations** or the manual bundled in the motherboard support DVD.
- When using hot-plug and NCQ, set the type of the SATA connectors in the BIOS to **[AHCI]**. See section **3.6.3 SATA Configuration** for details.

2. USB 3.0 connector (20-1 pin USB3_12)

This connector allows you to connect a USB 3.0 module for additional USB 3.0 front or rear panel ports. With an installed USB 3.0 module, you can enjoy all the benefits of USB 3.0 including faster data transfer speeds of up to 4.8Gbps, faster charging time for USB-chargable devices, optimized power efficiency, and backward compatibility with USB 2.0.

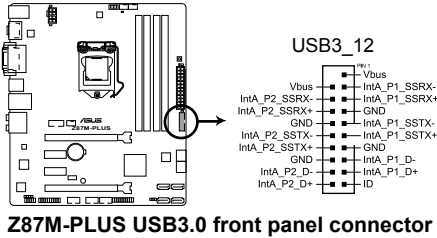

- The USB 3.0 module is purchased separately.
- These connectors are based on xHCI specification. We recommend you to install the related driver to fully use the USB 3.0 ports under Windows® 7.

3. Serial port connector (10-1 pin COM)

This connector is for a serial (COM) port. Connect the serial port module cable to this connector, then install the module to a slot opening at the back of the system chassis.

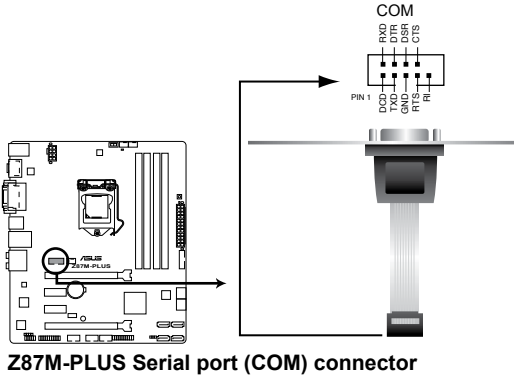

- The COM module is purchased separately.

4. USB 2.0 connectors (10-1 pin USB910; USB1112; USB1314)

These connectors are for USB 2.0 ports. Connect the USB module cable to any of these connectors, then install the module to a slot opening at the back of the system chassis. These USB connectors comply with USB 2.0 specification that supports up to 480 Mbps connection speed.

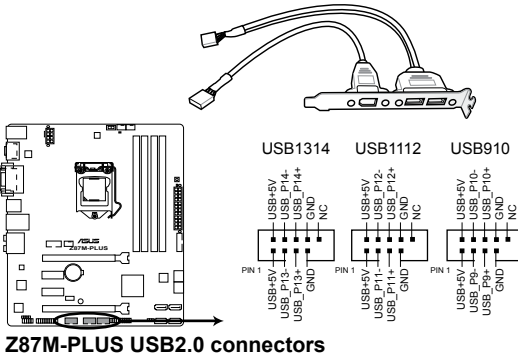

Never connect a 1394 cable to the USB connectors. Doing so will damage the motherboard!



- The USB 2.0 module is purchased separately.
- These connectors are based on xHCI specification. We recommend you to install the related driver to fully use the USB 2.0 ports under Windows® 7.

5. Digital audio connector (4-1 pin SPDIF_OUT)

This connector is for an additional Sony/Philips Digital Interface (S/PDIF) port. Connect the S/PDIF Out module cable to this connector, then install the module to a slot opening at the back of the system chassis.

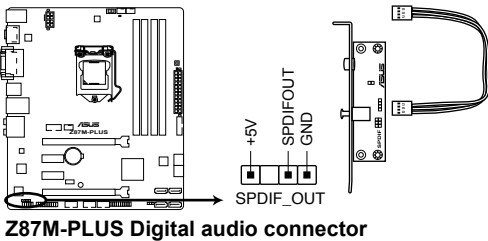

The S/PDIF module is purchased separately.

6. CPU and chassis fan connectors (4-pin CPU_FAN; 4-pin CHA_FAN1-2)

Connect the fan cables to the fan connectors on the motherboard, ensuring that the black wire of each cable matches the ground pin of the connector.

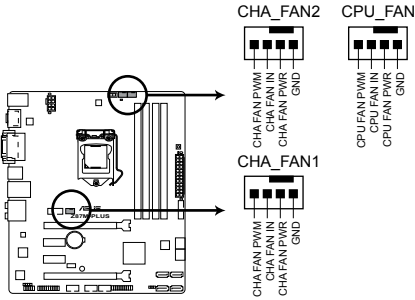

Z87M-PLUS Fan connectors



DO NOT forget to connect the fan cables to the fan connectors. Insufficient air flow inside the system may damage the motherboard components. These are not jumpers! Do not place jumper caps on the fan connectors!



- The CPU_FAN connector supports the CPU fan of maximum 1A (12 W) fan power.
- The CPU_FAN and CHA_FAN connectors support the ASUS Fan Xpert 2 feature.

7. Front panel audio connector (10-1 pin AAFP)

This connector is for a chassis-mounted front panel audio I/O module that supports either HD Audio or legacy AC'97 audio standard. Connect one end of the front panel audio I/O module cable to this connector.

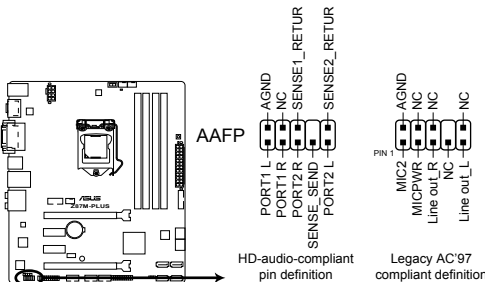

Z87M-PLUS Front panel audio connector



- We recommend that you connect a high-definition front panel audio module to this connector to avail of the motherboard's high-definition audio capability.
- If you want to connect a high-definition or an AC'97 front panel audio module to this connector, set the Front Panel Type item in the BIOS setup to **[HD]** or **[AC97]**.

8. ATX power connectors (24-pin EATXPWR; 8-pin EATX12V)

These connectors are for ATX power supply plugs. The power supply plugs are designed to fit these connectors in only one orientation. Find the proper orientation and push down firmly until the connectors completely fit.

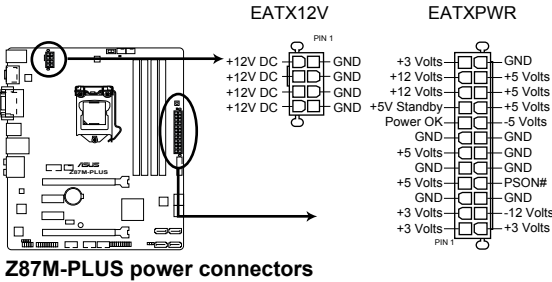

- For a fully configured system, we recommend that you use a power supply unit (PSU) that complies with ATX 12 V Specification 2.0 (or later version) and provides a minimum power of 350 W.
- DO NOT forget to connect the 4-pin/8-pin EATX12 V power plug. Otherwise, the system will not boot.
- We recommend that you use a PSU with a higher power output when configuring a system with more power-consuming devices. The system may become unstable or may not boot up if the power is inadequate.
- If you want to use two or more high-end PCI Express x16 cards, use a PSU with 1000W power or above to ensure the system stability.
- If you are uncertain about the minimum power supply requirement for your system, refer to the Recommended Power Supply Wattage Calculator at <http://support.asus.com/PowerSupplyCalculator/PSCalculator.aspx?SLanguage=en-us> for details.

9. TPM connector (20-pin TPM)

This connector supports a Trusted Platform Module (TPM) system, which securely store keys, digital certificates, passwords and data. A TPM system also helps enhance network security, protect digital identities, and ensures platform integrity.

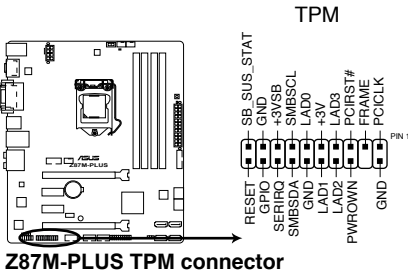

10. System panel connector (20-8 pin PANEL)

This connector supports several chassis-mounted functions.

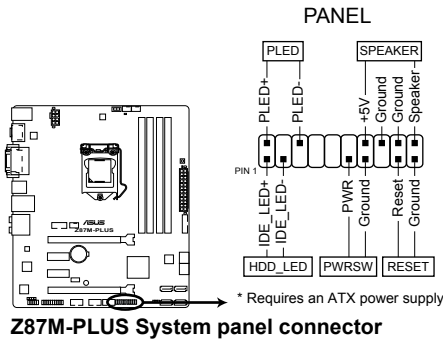

- **System power LED (2-pin PLED)**

This 2-pin connector is for the system power LED. Connect the chassis power LED cable to this connector. The system power LED lights up when you turn on the system power, and blinks when the system is in sleep mode.

- **Hard disk drive activity LED (2-pin HDD_LED)**

This 2-pin connector is for the HDD Activity LED. Connect the HDD Activity LED cable to this connector. The HDD LED lights up or flashes when data is read from or written to the HDD.

- **System warning speaker (4-pin SPEAKER)**

This 4-pin connector is for the chassis-mounted system warning speaker. The speaker allows you to hear system beeps and warnings.

- **ATX power button/soft-off button (2-pin PWRSW)**

This connector is for the system power button. Pressing the power button turns the system on or puts the system in sleep or soft-off mode depending on the operating system settings. Pressing the power switch for more than four seconds while the system is ON turns the system OFF.

- **Reset button (2-pin RESET)**

This 2-pin connector is for the chassis-mounted reset button for system reboot without turning off the system power.

Basic installation

2

2.1 Building your PC system

2.1.1 Motherboard installation



The diagrams in this section are for reference only. The motherboard layout may vary with models, but the installation steps are the same for all models.

1. Install the ASUS I/O shield to the chassis rear I/O panel.

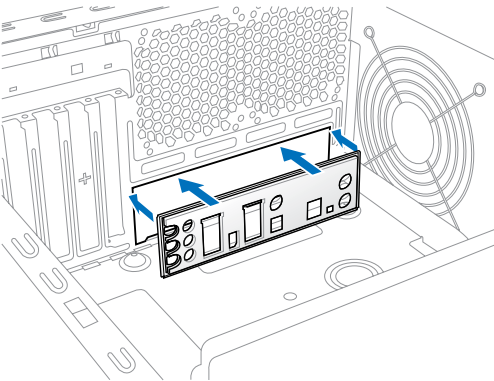

2. Place the motherboard into the chassis, ensuring that its rear I/O ports are aligned to the chassis' rear I/O panel.

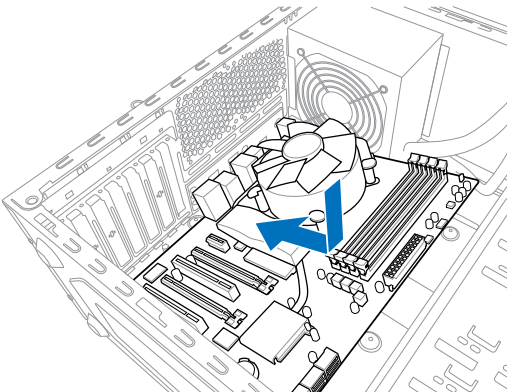

- Place six screws into the holes indicated by circles to secure the motherboard to the chassis.

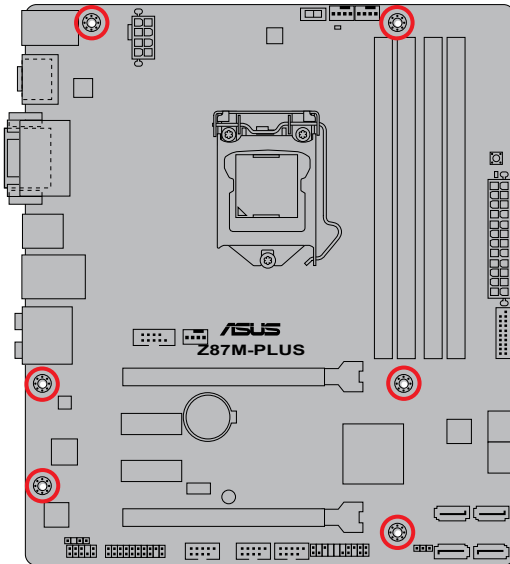
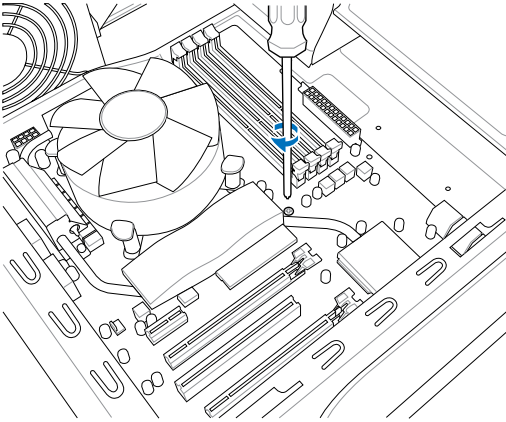

DO NOT overtighten the screws! Doing so can damage the motherboard.

2.1.2 CPU installation



Ensure that you install the correct CPU designed for LGA1150 socket only. DO NOT install a CPU designed for LGA1155 and LGA1156 socket on the LGA1150 socket.

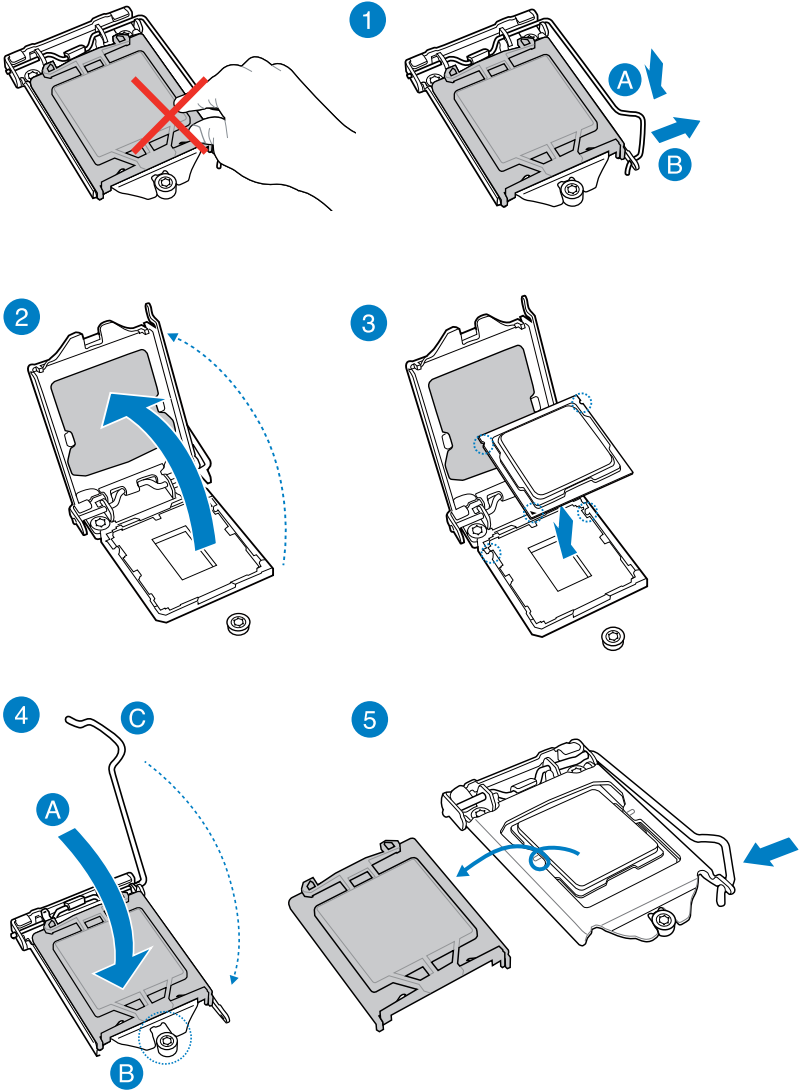

2.1.3 CPU heatsink and fan assembly installation

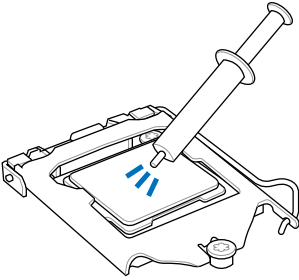

Apply the Thermal Interface Material to the CPU heatsink and CPU before you install the heatsink and fan, if necessary.

To install the CPU heatsink and fan assembly

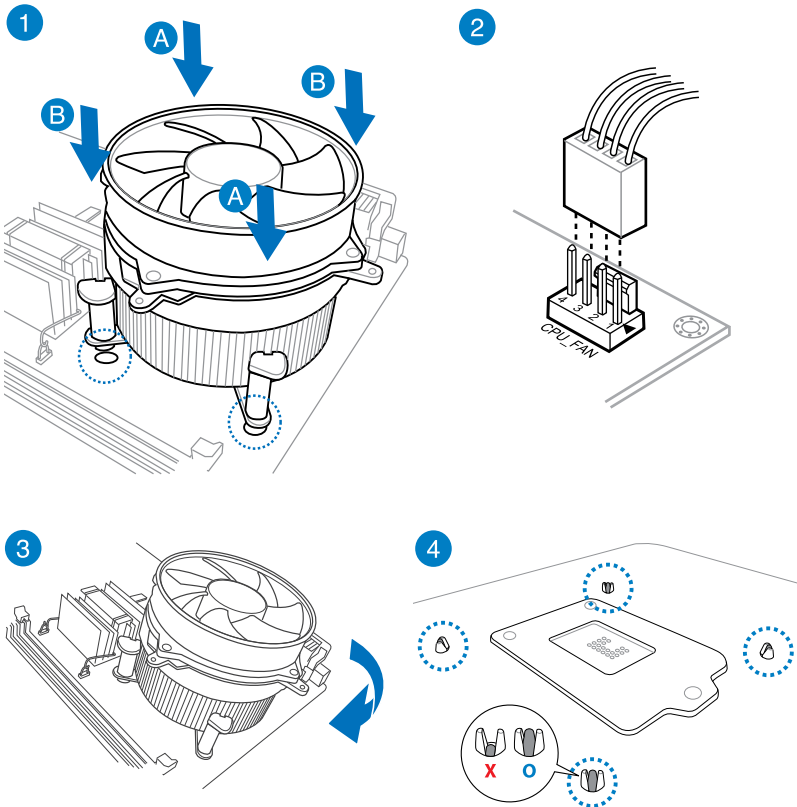

To uninstall the CPU heatsink and fan assembly

1

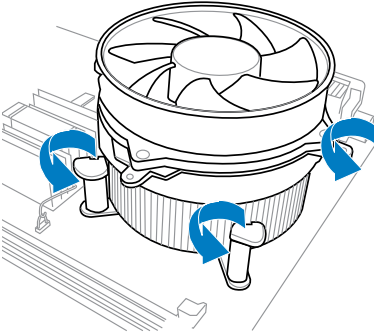

2

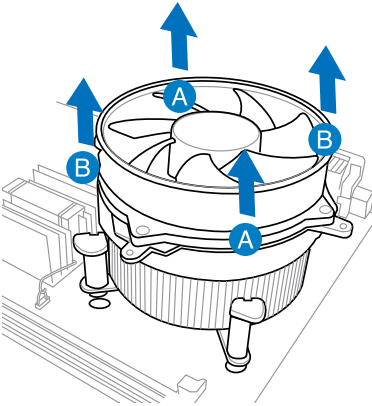

2.1.4 DIMM installation

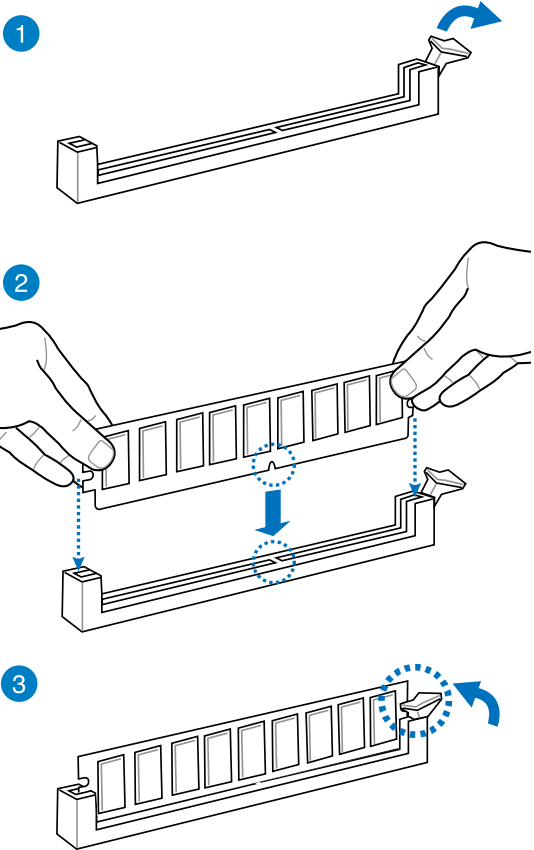

To remove a DIMM

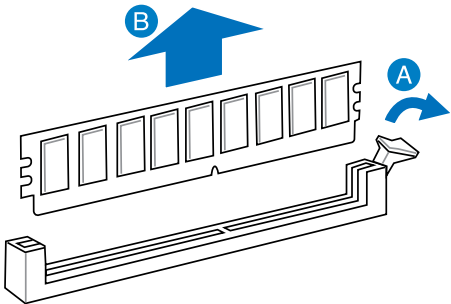

2.1.5 ATX Power connection

1

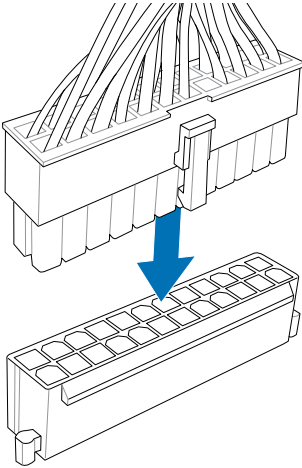

2

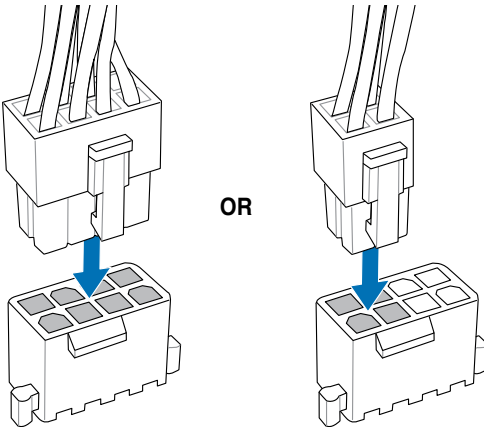

2.1.6 SATA device connection

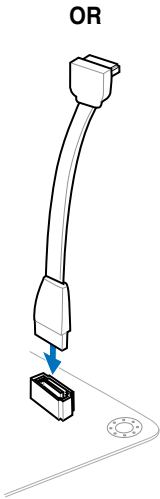
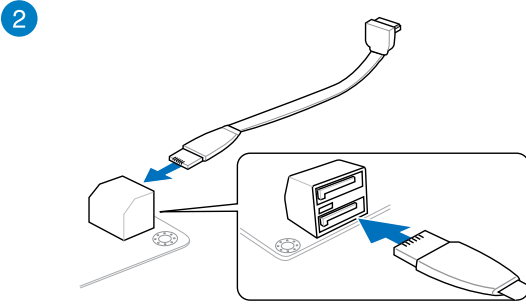
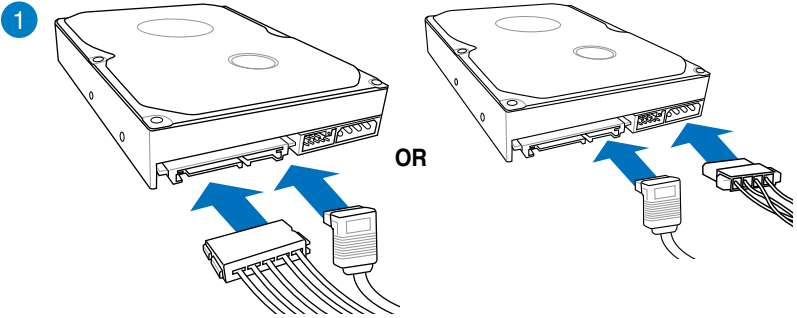

2.1.7 Front I/O Connector

To install the system panel connector

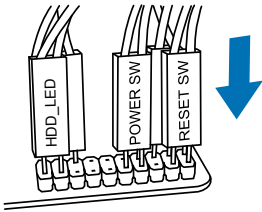

To install USB 2.0 connector

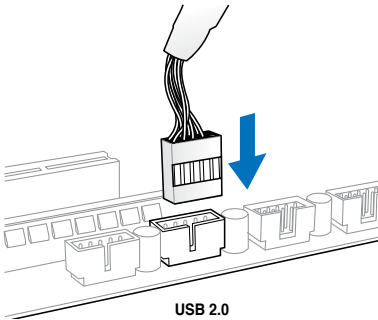

To install front panel audio connector

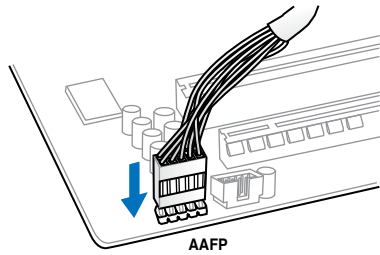

To install USB 3.0 connector

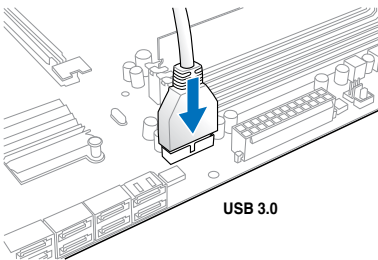

2.1.8 Expansion Card installation

To install PCIe x16 cards

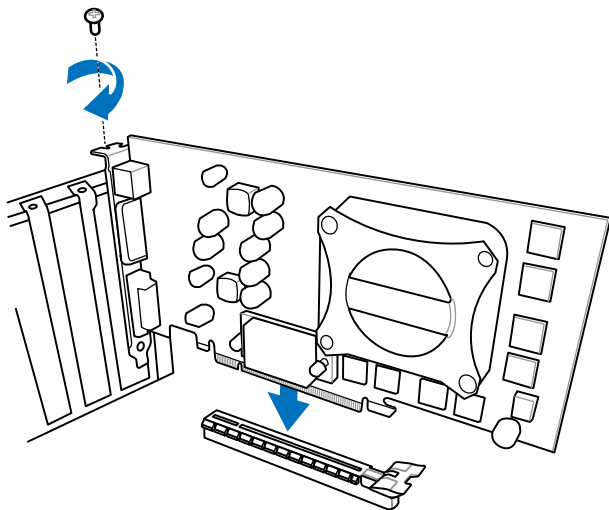

To install PCIe x1 cards

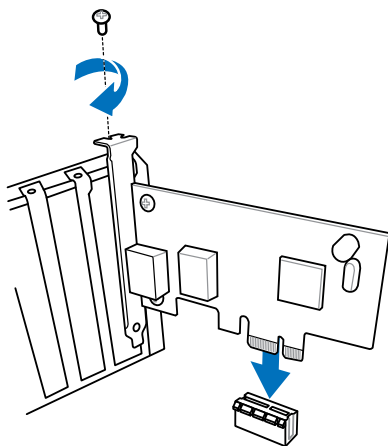

2.2 Motherboard rear and audio connections

2.2.1 Rear I/O connection

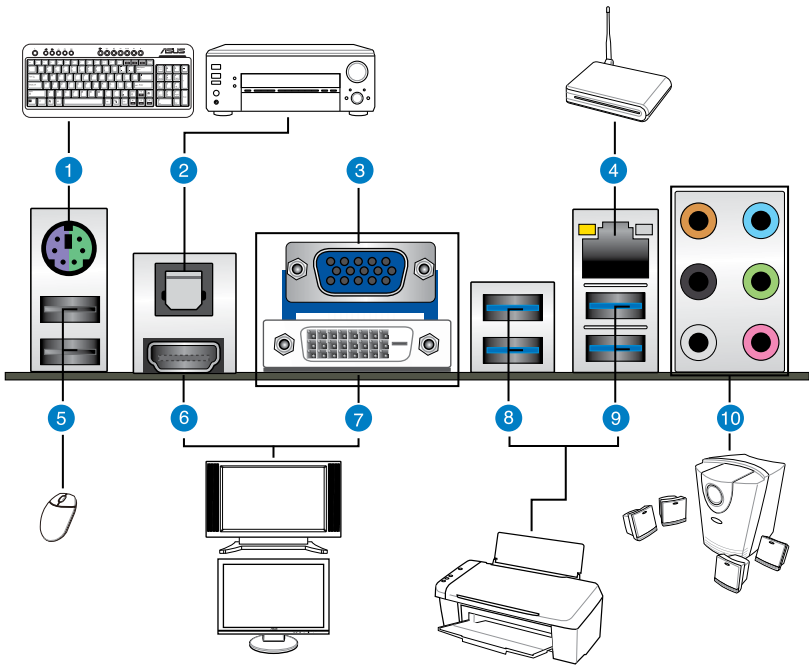

| Rear panel connectors | |
|--------------------------------------|--|
| 1. PS/2 keyboard / mouse combo port | 6. HDMI port |
| 2. Optical S/PDIF Out port | 7. DVI-D port |
| 3. Video Graphics Adapter (VGA) port | 8. Intel USB 3.0 ports 3-4, support ASUS USB 3.0 Boost |
| 4. Realtek® LAN (RJ-45) port* | 9. Intel USB 3.0 ports 5-6, support ASUS USB 3.0 Boost. Bottom port supports USB BIOS Flashback and USB Charger+ |
| 5. USB 2.0 ports 7 and 8 | 10. Audio I/O ports** |

* and **: Refer to the tables on the next page for LAN port LEDs, and audio port definitions.



- Due to USB 3.0 controller limitation, USB 3.0 devices can only be used under Windows® OS environment and after the USB 3.0 driver installation.
- USB 3.0 devices can only be used as data storage only.
- We strongly recommend that you connect USB 3.0 devices to USB 3.0 ports for faster and better performance for your USB 3.0 devices.
- Due to the design of the Intel® 8 series chipset, all USB devices connected to the USB 2.0 and USB 3.0 ports are controlled by the xHCI controller. Some legacy USB devices must update their firmware for better compatibility.
- Multi-VGA output supports up to three displays under Windows® OS environment, two displays under BIOS, and one display under DOS.
- Due to design of the Intel® display architecture, below are the following onboard graphics output and their maximum supported pixel clocks:
 - DVI port supports: 165 MHz
 - VGA port supports: 180 MHz
 - HDMI port supports: 300 MHz

*** LAN ports LED indications**

| Activity Link LED | | Speed LED | |
|-------------------------------|-------------------------------|-----------|---------------------|
| Status | Description | Status | Description |
| OFF | No link | OFF | 10 Mbps connection |
| ORANGE | Linked | ORANGE | 100 Mbps connection |
| Orange (Blinking) | Data activity | GREEN | 1 Gbps connection |
| Orange (Blinking then steady) | Ready to wake up from S5 mode | | |

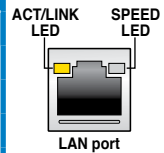

**** Audio 2, 4, 6, or 8-channel configuration**

| Port | Headset 2-channel | 4-channel | 6-channel | 8-channel |
|------------|-------------------|-------------------|-------------------|-------------------|
| Light Blue | Line In | Line In | Line In | Line In |
| Lime | Line Out | Front Speaker Out | Front Speaker Out | Front Speaker Out |
| Pink | Mic In | Mic In | Mic In | Mic In |
| Orange | – | – | Center/Subwoofer | Center/Subwoofer |
| Black | – | Rear Speaker Out | Rear Speaker Out | Rear Speaker Out |
| Gray | – | – | – | Side Speaker Out |

2.2.2 BIOS update utility

USB BIOS Flashback

USB BIOS Flashback allows you to easily update the BIOS without entering the existing BIOS or operating system. Simply insert a USB storage device to the USB port, press the reset button on your chassis for three seconds, and the BIOS is updated automatically.

To use USB BIOS Flashback:

1. Download the latest BIOS file from the ASUS website at <http://support.asus.com>
2. Extract and rename the BIOS image file to **Z87MPLUS.CAP**.
3. Copy **Z87MPLUS.CAP** to the root directory of the USB flash disk drive.
4. Insert the USB storage device to the USB BIOS Flashback port when the system is turned off.
5. Press the reset button and the power LED on your chassis begins to flash.
6. Wait until the power LED on your chassis goes out, indicating that the BIOS updating process is completed.

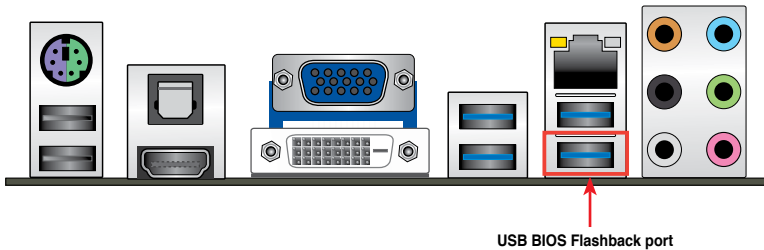

For more BIOS update utilities in BIOS setup, refer to the section **3.11.1 ASUS Update** in Chapter 3.



- Do not unplug portable disk, power system, or press the CLR_CMOS button while BIOS update is ongoing, otherwise update will be interrupted. In case of interruption, please follow the steps again.
- If the light flashes for five seconds and turns into a solid light, this means that the BIOS Flashback is not operating properly. This may be caused by improper installation of the USB storage device and filename/file format error. If this scenario happens, please restart the system to turn off the light.
- Updating BIOS may have risks. If the BIOS program is damaged during the process and results to the system's failure to boot up, please contact your local ASUS Service Center.

2.2.3 Audio I/O connections

Audio I/O ports

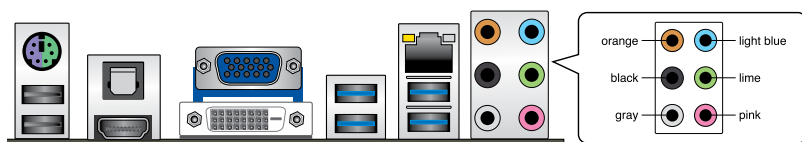

Connect to Headphone and Mic



Connect to Stereo Speakers

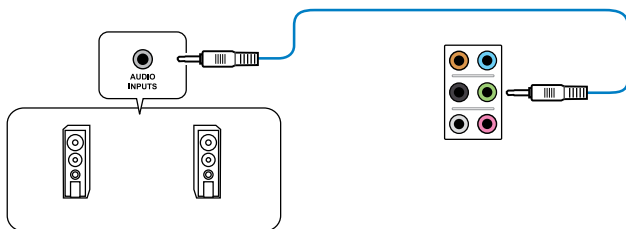

Connect to 2.1 channel Speakers

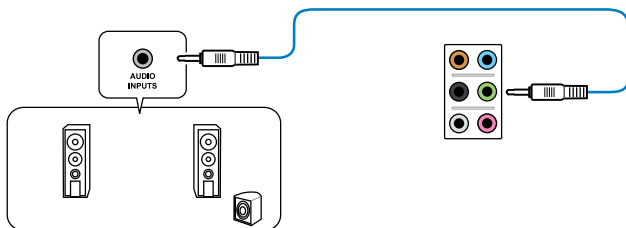

Connect to 4.1 channel Speakers

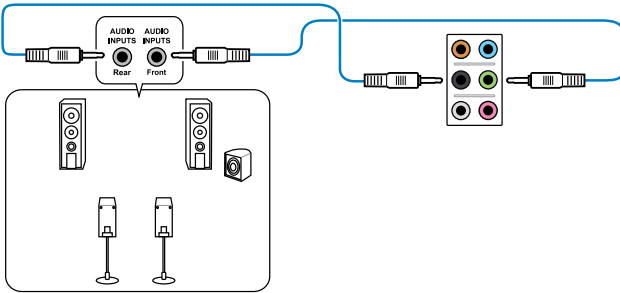

Connect to 5.1 channel Speakers

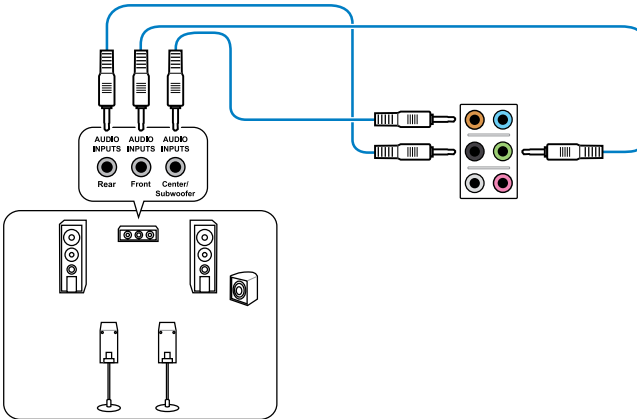

Connect to 7.1 channel Speakers

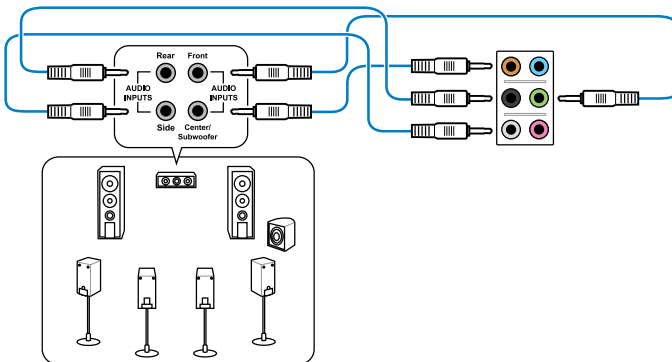

2.3 Starting up for the first time

1. After making all the connections, replace the system case cover.
2. Ensure that all switches are off.
3. Connect the power cord to the power connector at the back of the system chassis.
4. Connect the power cord to a power outlet that is equipped with a surge protector.
5. Turn on the devices in the following order:
 - a. Monitor
 - b. External SCSI devices (starting with the last device on the chain)
 - c. System power
6. After applying power, the system power LED on the system front panel case lights up. For systems with ATX power supplies, the system LED lights up when you press the ATX power button. If your monitor complies with the “green” standards or if it has a “power standby” feature, the monitor LED may light up or change from orange to green after the system LED turns on.

The system then runs the power-on self tests (POST). While the tests are running, the BIOS beeps (refer to the BIOS beep codes table) or additional messages appear on the screen. If you do not see anything within 30 seconds from the time you turned on the power, the system may have failed a power-on test. Check the jumper settings and connections or call your retailer for assistance.

| BIOS Beep | Description |
|---|--|
| One short beep | VGA detected Quick boot set to disabled No keyboard detected |
| One continuous beep followed by two short beeps then a pause (repeated) | No memory detected |
| One continuous beep followed by three short beeps | No VGA detected |
| One continuous beep followed by four short beeps | Hardware component failure |

7. At power on, hold down the <Delete> key to enter the BIOS Setup. Follow the instructions in Chapter 3.

2.4 Turning off the computer

While the system is ON, press the power button for less than four seconds to put the system on sleep mode or soft-off mode, depending on the BIOS setting. Press the power switch for more than four seconds to let the system enter the soft-off mode regardless of the BIOS setting.

BIOS setup

3

3.1 Knowing BIOS



The new ASUS UEFI BIOS is a Unified Extensible Interface that complies with UEFI architecture, offering a user-friendly interface that goes beyond the traditional keyboard-only BIOS controls to enable a more flexible and convenient mouse input. You can easily navigate the new UEFI BIOS with the same smoothness as your operating system. The term "BIOS" in this user manual refers to "UEFI BIOS" unless otherwise specified.

BIOS (Basic Input and Output System) stores system hardware settings such as storage device configuration, overclocking settings, advanced power management, and boot device configuration that are needed for system startup in the motherboard CMOS. In normal circumstances, the default BIOS settings apply to most conditions to ensure optimal performance. **DO NOT change the default BIOS settings** except in the following circumstances:

- An error message appears on the screen during the system bootup and requests you to run the BIOS Setup.
- You have installed a new system component that requires further BIOS settings or update.



Inappropriate BIOS settings may result to instability or boot failure. **We strongly recommend that you change the BIOS settings only with the help of a trained service personnel.**



When downloading or updating the BIOS file, rename it as **Z87MPLUS.CAP** for this motherboard.

3.2 BIOS setup program

Use the BIOS Setup to update the BIOS or configure its parameters. The BIOS screen include navigation keys and brief onscreen help to guide you in using the BIOS Setup program.

Entering BIOS at startup

To enter BIOS Setup at startup:

- Press <Delete> during the Power-On Self Test (POST). If you do not press <Delete>, POST continues with its routines.

Entering BIOS Setup after POST

To enter BIOS Setup after POST:

- Press <Ctrl>+<Alt>+<Delete> simultaneously.
- Press the reset button on the system chassis.
- Press the power button to turn the system off then back on. Do this option only if you failed to enter BIOS Setup using the first two options.



-
- The BIOS setup screens shown in this section are for reference purposes only, and may not exactly match what you see on your screen.
 - Ensure that a USB mouse is connected to your motherboard if you want to use the mouse to control the BIOS setup program.
 - If the system becomes unstable after changing any BIOS setting, load the default settings to ensure system compatibility and stability. Select the **Load Optimized Defaults** item under the **Exit** menu or press hotkey <F5>. See section 3.10 **Exit Menu** for details.
 - If the system fails to boot after changing any BIOS setting, try to clear the CMOS and reset the motherboard to the default value. See section 1.2.6 **Jumpers** for information on how to erase the RTC RAM.
 - The BIOS setup program does not support the bluetooth devices.
-

BIOS menu screen

The BIOS Setup program can be used under two modes: **EZ Mode** and **Advanced Mode**. You can change modes from the **Exit** menu or from the **Exit/Advanced Mode** screen.

3.2.1 EZ Mode

By default, the EZ Mode screen appears when you enter the BIOS setup program. The EZ Mode provides you an overview of the basic system information, and allows you to select the display language, system performance mode and boot device priority. To access the Advanced Mode, click **Exit/Advanced Mode**, then select **Advanced Mode** or press <F7> hot key for the advanced BIOS settings.



The default screen for entering the BIOS setup program can be changed. Refer to the **Setup Mode** item in section 3.7 **Boot menu** for details.

Displays the CPU temperature, CPU voltage output, DRAM information, and CPU/chassis fan speed

Selects the display language of the BIOS setup program

Exits the BIOS setup program without saving the changes, saves the changes and resets the system, or enters the Advanced Mode

Displays the selected shortcut items

Displays the Advanced mode menus

Selects the boot device priority

Displays the system properties of the selected mode on the right hand side

Loads optimized default settings

Selects the boot device priority



- The boot device options vary depending on the devices you installed to the system.
- The **Boot Menu (F8)** button is available only when the boot device is installed to the system.

3.2.2 Advanced Mode

The Advanced Mode provides advanced options for experienced end-users to configure the BIOS settings. The figure below shows an example of the Advanced Mode. Refer to the following sections for the detailed configurations.



To access the Advanced Mode, click **Exit**, then select **Advanced Mode** or press **F7** hotkey.

Menu bar

The menu bar on top of the screen has the following main items:

| | |
|---------------------|---|
| My Favorites | For saving the frequently-used system settings and configuration. |
| Main | For changing the basic system configuration |
| Ai Tweaker | For changing the overclocking settings |
| Advanced | For changing the advanced system settings |
| Monitor | For displaying the system temperature, power status, and changing the fan settings. |
| Boot | For changing the system boot configuration |
| Tool | For configuring options for special functions |
| Exit | For selecting the exit options and loading default settings |

Menu items

The highlighted item on the menu bar displays the specific items for that menu. For example, selecting **Main** shows the Main menu items.

The other items (My Favorites, Ai Tweaker, Advanced, Monitor, Boot, Tool, and Exit) on the menu bar have their respective menu items.

Back button

This button appears when entering a submenu. Press <Esc> or use the USB mouse to click this button to return to the previous menu screen.

Submenu items

A greater than sign (>) before each item on any menu screen means that the item has a submenu. To display the submenu, select the item and press <Enter>.

Pop-up window

Select a menu item and press <Enter> to display a pop-up window with the configuration options for that item.

Scroll bar

A scroll bar appears on the right side of a menu screen when there are items that do not fit on the screen. Press the Up/Down arrow keys or <Page Up> / <Page Down> keys to display the other items on the screen.

Navigation keys

At the bottom right corner of the menu screen are the navigation keys for the BIOS setup program. Use the navigation keys to select items in the menu and change the settings.



For the navigation key, it is only available in English. If you delete the default shortcuts, they will still appear on your next system bootup.

General help

At the top right corner of the menu screen is a brief description of the selected item. Use <F12> key to capture the BIOS screen and save it to the removable storage device.

Configuration fields

These fields show the values for the menu items. If an item is user-configurable, you can change the value of the field opposite the item. You cannot select an item that is not user-configurable.

A configurable field is highlighted when selected. To change the value of a field, select it and press <Enter> to display a list of options.

Quick Note button

This button allows you to enter notes of the activities that you have done in BIOS.



-
- The Quick Note function does not support the following keyboard functions: delete, cut, copy and paste.
 - You can only use the English letters to type your notes.
-

Last Modified button

This button shows the items that you last modified and saved in BIOS Setup.

3.3 My Favorites

MyFavorites is your personal space where you can easily save and access your favorite BIOS items.



Adding items to My Favorites

To add frequently-used BIOS items to My Favorites:

1. Use the arrow keys to select an item that you want to add. When using a mouse, hover the pointer to the item.
2. Press <F4> on your keyboard or right-click on your mouse to add the item to My Favorites page.



You cannot add the following items to My Favorite items:

- Items with submenu options
- User-managed items such as language and boot order
- Configuration items such as Memory SPD Information, system time and date.

3.4 Main menu

The Main menu screen appears when you enter the Advanced Mode of the BIOS Setup program. The Main menu provides you an overview of the basic system information, and allows you to set the system date, time, language, and security settings.



Security

The Security menu items allow you to change the system security settings.

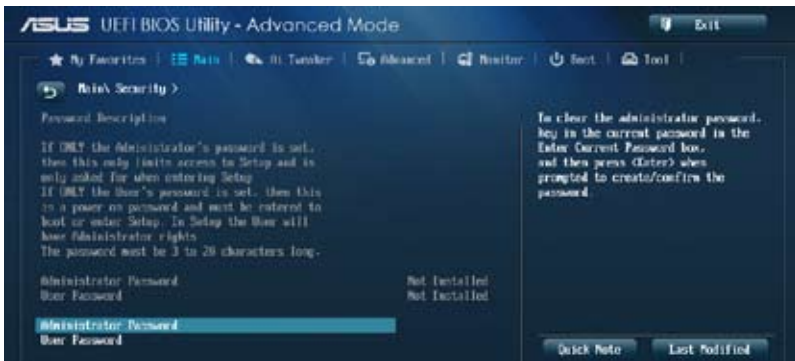

- If you have forgotten your BIOS password, erase the CMOS Real Time Clock (RTC) RAM to clear the BIOS password. See section 1.2.6 Jumpers for information on how to erase the RTC RAM.
- The Administrator or User Password items on top of the screen show the default **[Not Installed]**. After you set a password, these items show **[Installed]**.

Administrator Password

If you have set an administrator password, we recommend that you enter the administrator password for accessing the system. Otherwise, you might be able to see or change only selected fields in the BIOS setup program.

To set an administrator password:

1. Select the **Administrator Password** item and press <Enter>.
2. From the **Create New Password** box, key in a password, then press <Enter>.
3. Confirm the password when prompted.

To change an administrator password:

1. Select the **Administrator Password** item and press <Enter>.
2. From the **Enter Current Password** box, key in the current password, then press <Enter>.
3. From the **Create New Password** box, key in a new password, then press <Enter>.
4. Confirm the password when prompted.

To clear the administrator password, follow the same steps as in changing an administrator password, but press <Enter> when prompted to create/confirm the password. After you clear the password, the **Administrator Password** item on top of the screen shows **Not Installed**.

User Password

If you have set a user password, you must enter the user password for accessing the system. The User Password item on top of the screen shows the default Not Installed. After you set a password, this item shows Installed.

To set a user password:

1. Select the **User Password** item and press <Enter>.
2. From the **Create New Password** box, key in a password, then press <Enter>.
3. Confirm the password when prompted.

To change a user password:

1. Select the **User Password** item and press <Enter>.
2. From the **Enter Current Password** box, key in the current password, then press <Enter>.
3. From the **Create New Password** box, key in a new password, then press <Enter>.
4. Confirm the password when prompted.

To clear the user password, follow the same steps as in changing a user password, but press <Enter> when prompted to create/confirm the password. After you clear the password, the **User Password** item on top of the screen shows **Not Installed**.

3.5 Ai Tweaker menu

The Ai Tweaker menu items allow you to configure overclocking-related items.



Be cautious when changing the settings of the Ai Tweaker menu items. Incorrect field values can cause the system to malfunction.



The configuration options for this section vary depending on the CPU and DIMM model you installed on the motherboard.

Scroll down to display other BIOS items.



Ai Overclock Tuner [Auto]

Allows you to select the CPU overclocking options to achieve the desired CPU internal frequency. Select any of these preset overclocking configuration options:

- [Auto] Loads the optimal settings for the system.
- [Manual] Allows you to automatically optimize the CPU ratio and BCLK frequency.
- [X.M.P.] Allows your system to automatically optimize the CPU ratio, BCLK frequency, and memory parameters. If you install memory modules supporting the eXtreme Memory Profile (X.M.P.) Technology, select this item to set the profiles supported by your memory modules for optimizing the system performance.



The following item appears only when you set the Ai Overlocking Tuner to **[Auto]**.

ASUS MultiCore Enhancement [Enabled]

[Enabled] Default set to [Enabled] for maximum performance under XMP/ Manual/User-defined memory frequency mode.

[Disabled] Allows you to set to default core ratio settings.



The following two items appear only when you set the Ai Overlocking Tuner to **[Manual]**.

Filter PLL [Auto]

Allows you to select a BCLK (base clock) mode when running in a high or low BCLK. Configuration options: [Auto] [Low BCLK Mode] [High BCLK Mode]

BCLK/PEG Frequency [XXX]

Allows you to set the BCLK/PEG frequency to enhance the system performance. Use the <+> or <-> keys to adjust the value. The values range from 80.0MHz to 300.0MHz.



The following two items appear only when you set the Ai Overlocking Tuner to **[X.M.P.]**.

eXtreme Memory Profile

Allows you to select the X.M.P. mode supported by your memory module. Configuration options: [Profile #1] [Profile #2]

CPU Core Ratio [Auto]

Allows you to set the CPU ratio and synchronize automatically either per core or all cores. Configuration options: [Auto] [Sync All Cores] [Per Core]



When the CPU Core Ratio is set to **[Auto]**, the following item appears:

Min CPU Cache Ratio [Auto]

Allows you to set the minimum possible ratio on the Uncore part of the processor. Use the <+> or <-> keys to adjust the value. The values depend on the CPU installed.

Max CPU Cache Ratio [Auto]

Allows you to set the maximum possible ratio on the Uncore part of the processor. Use the <+> or <-> keys to adjust the value. The values depend on the CPU installed.



When the CPU Core Ratio is set to **[Per Core]**, the following item appears:

1-Core Ratio Limit [Auto]

Select **[Auto]** to apply the CPU default Turbo Ratio setting or manually assign a 1-Core Ratio Limit value that must be higher than or equal to the 2-Core Ratio Limit.

2-Core Ratio Limit [Auto]

Select **[Auto]** to apply the CPU default Turbo Ratio setting or manually assign a 2-Core Ratio Limit value that must be higher than or equal to the 3-Core Ratio Limit.



If you assign a value for 2-Core Ratio Limit, do not set the 1-Core Ratio Limit to **[Auto]**.

3-Core Ratio Limit [Auto]

Select **[Auto]** to apply the CPU default Turbo Ratio setting or manually assign a 3-Core Ratio Limit value that must be higher than or equal to the 4-Core Ratio Limit.



If you assign a value for 3-Core Ratio Limit, do not set the 1-Core Ratio Limit and 2-Core Ratio Limit to **[Auto]**.

4-Core Ratio Limit [Auto]

Select **[Auto]** to apply the CPU default Turbo Ratio setting or manually assign a 4-Core Ratio Limit value that must be higher than or equal to the 3-Core Ratio Limit.



If you assign a value for 4-Core Ratio Limit, do not set the 1-Core Ratio Limit, 2-Core Ratio Limit, and 3-Core Ratio to **[Auto]**.

Internal PLL Overvoltage [Auto]

Allows you to enable the internal PLL Overvoltage for K-SKU CPUs to get the extreme overclocking capability. Configuration options: **[Auto]** **[Enabled]** **[Disabled]**

CPU bus speed : DRAM speed ratio mode [Auto]

Allows you to set the CPU bus speed to DRAM speed ratio mode.

- [Auto]** DRAM speed is set to the optimized settings.
- [100:133]** The CPU bus speed to DRAM speed ratio is set to 100:133.
- [100:100]** The CPU bus speed to DRAM speed ratio is set to 100:100.

Memory Frequency [Auto]

Allows you to set the memory operating frequency. The configuration options vary with the BCLK/PEG Frequency item settings.

CPU Graphics Max. Ratio [Auto]

- [Auto]** The iGPU frequency is set to its optimized setting depending on the system loading.
- [Manual]** Use the <+> or <-> keys to adjust the optimal iGPU frequency value. The frequency may vary depending on the system load.

OC Tuner [Auto]

OC Tuner automatically overclocks the frequency and voltage of CPU and DRAM for enhancing the system performance and accelerates iGPU performance to the extreme according to the integrated graphics loading. Configuration options: **[Auto]** **[Ratio First]** **[BCLK First]**

EPU Power Saving Mode [Disabled]

Allows you to enable or disable the EPU power saving function. Configuration options: **[Disabled]** **[Enabled]**

DRAM Timing Control

The subitems in this menu allow you to set the DRAM timing control features. Use the <+> or <-> keys to adjust the value. To restore the default setting, type [auto] using the keyboard and press the <Enter> key.



Changing the values in this menu may cause the system to become unstable! If this happens, revert to the default settings.

Primary Timings

DRAM CAS# Latency [Auto]

Configuration options: [Auto] [1] – [31]

DRAM RAS# to CAS# Delay [Auto]

Configuration options: [Auto] [1] – [31]

DRAM RAS# PRE Time [Auto]

Configuration options: [Auto] [1] – [31]

DRAM RAS# ACT Time [Auto]

Configuration options: [Auto] [1] – [63]

DRAM COMMAND Mode [Auto]

Configuration options: [Auto] [1] – [3]

Secondary Timings

DRAM RAS# to RAS# Delay [Auto]

Configuration options: [Auto] [1] – [15]

DRAM REF Cycle Time [Auto]

Configuration options: [Auto] [1] – [511]

DRAM Refresh Interval [Auto]

Configuration options: [Auto] [1] – [65535]

DRAM WRITE Recovery Time [Auto]

Configuration options: [Auto] [1] – [16]

DRAM READ to PRE Time [Auto]

Configuration options: [Auto] [1] – [15]

DRAM FOUR ACT WIN Time [Auto]

Configuration options: [Auto] [1] – [255]

DRAM WRITE to READ Delay [Auto]

Configuration options: [Auto] [1] – [15]

DRAM CKE Minimum pulse width [Auto]

Configuration options: [Auto] [1] – [15]

DRAM CAS# Write to Latency [Auto]

Configuration options: [Auto] [1] – [31]

RTL IOL control

DRAM RTL (CHA_R0D0) [Auto]

Configuration options: [Auto] [1] - [63]

DRAM RTL (CHA_R0D1) [Auto]

Configuration options: [Auto] [1] - [63]

DRAM RTL (CHA_R1D0) [Auto]

Configuration options: [Auto] [1] - [63]

DRAM RTL (CHA_R1D1) [Auto]

Configuration options: [Auto] [1] - [63]

DRAM RTL (CHB_R0D0) [Auto]

Configuration options: [Auto] [1] - [63]

DRAM RTL (CHB_R0D1) [Auto]

Configuration options: [Auto] [1] - [63]

DRAM RTL (CHB_R1D0) [Auto]

Configuration options: [Auto] [1] - [63]

DRAM RTL (CHB_R1D1) [Auto]

Configuration options: [Auto] [1] - [63]

DRAM IO-L (CHA_R0D0) [Auto]

Configuration options: [Auto] [1] - [15]

DRAM IO-L (CHA_R0D1) [Auto]

Configuration options: [Auto] [1] - [15]

DRAM IO-L (CHA_R1D0) [Auto]

Configuration options: [Auto] [1] - [15]

DRAM IO-L (CHA_R1D1) [Auto]

Configuration options: [Auto] [1] - [15]

DRAM IO-L (CHB_R0D0) [Auto]

Configuration options: [Auto] [1] - [15]

DRAM IO-L (CHB_R0D1) [Auto]

Configuration options: [Auto] [1] - [15]

DRAM IO-L (CHB_R1D0) [Auto]

Configuration options: [Auto] [1] - [15]

DRAM IO-L (CHB_R1D1) [Auto]

Configuration options: [Auto] [1] - [15]

Third Timings

tRDRD [Auto]

Configuration options: [Auto] [1] – [7]

tRDRD_dr [Auto]

Configuration options: [Auto] [1] – [15]

tRDRD_dd [Auto]

Configuration options: [Auto] [1] – [15]

tWRRD [Auto]

Configuration options: [Auto] [1] – [63]

tWRRD_dr [Auto]

Configuration options: [Auto] [1] – [15]

tWRRD_dd [Auto]

Configuration options: [Auto] [1] – [15]

tWRWR [Auto]

Configuration options: [Auto] [1] – [7]

tWRWR_dr [Auto]

Configuration options: [Auto] [1] – [15]

tWRWR_dd [Auto]

Configuration options: [Auto] [1] – [15]

Dec_WRD

Configuration options: [Auto] [0] [1]

tRDWR [Auto]

Configuration options: [Auto] [1] – [31]

tRDWR_dr [Auto]

Configuration options: [Auto] [1] – [31]

tRDWR_dd [Auto]

Configuration options: [Auto] [1] – [31]

MISC**MRC Fast Boot [Auto]**

Allows you to enable, disable or automatically set the MRC fast boot. Configuration options: [Auto] [Enable] [Disable]

DRAM CLK Period [Auto]

Configuration options: [Auto] [1] – [14]

Channel A/B DIMM Control [Enable Bot...]

Configuration options: [Enable Both DIMMS] [Disable DIMM0] [Disable DIMM1] [Disable Both DIMMS]

Scrambler Setting [Optimized ...]

Allows you to set the optimized scrambler setting for stability. Configuration options: [Optimized (ASUS)] [Default (MRC)]

DIGI+ VRM

CPU Load-Line Calibration [Auto]

Load-line is defined by Intel VRM specification and affects CPU voltage. The CPU working voltage will decrease proportionally to CPU loading. Higher load-line calibration could get higher voltage and good overclocking performance, but increases the CPU and VRM thermal conditions. This item allows you to adjust the voltage range from the following percentages to boost the system performance: 0% (Regular), 25% (Medium), 50% (High), 75% (Ultra High), and 100% (Extreme). Configuration options: [Auto] [Regular] [Medium] [High] [Ultra High] [Extreme]



The actual performance boost may vary depending on your CPU specification.

CPU Fixed Frequency [XXX]

This item allows you to set a fixed CPU voltage frequency. Use the <+> or <-> keys to adjust the value. The values range from 300kHz to 500kHz with a 50kHz interval.

CPU Power Phase Control [Standard]

Allows you to set the power phase based on the CPU. Configuration options: [Standard] [Optimized] [Extreme] [Manual Adjustment]



DO NOT remove the thermal module when setting this item to **[Extreme]** and **[Manual Adjustment]**. The thermal conditions should be monitored.



This following item appears only when you set the CPU Power Phase Control item to **[Manual Adjustment]**.

Manual Adjustment [Fast]

Allows you to set a faster phase response for the CPU to increase system performance or to slower phase response to decrease DRAM power efficiency. Configuration options: [Ultra Fast] [Fast] [Medium] [Regular]

CPU Power Duty Control [T.Probe]

DIGI+ VRM Duty Control adjusts the current of every VRM phase and the thermal conditions of every phase component.

[T. Probe] Select to maintain the VRM thermal balance.
[Extreme] Select to maintain the current VRM balance.

CPU Current Capability [Auto]

DIGI+ VRM CPU Current Capability provides wider total power range for overclocking. A higher value setting gets higher VRM power consumption delivery and extends the overclocking frequency range simultaneously. Configuration options: [Auto] [100%] [110%] [120%] [130%] [140%]



Choose a higher value when overclocking, or under a high CPU loading for extra power support.

CPU Power Management

The subitems in this menu allow you to set the CPU ratio and features.

Enhanced Intel SpeedStep Technology [Enabled]

Allows the operating system to dynamically adjust the processor voltage and cores frequency, resulting to a decreased average power consumption and decreased average heat production. Configuration options: [Disabled] [Enabled]

Turbo Mode [Enabled]

Allows you to enable your core processor's speed to run faster than the base operating frequency when it is below operating power, current and temperature specification limit. Configuration options: [Disabled] [Enabled]



The following items appear only when you set the Turbo Mode to [Enabled].

Turbo Mode Parameters

Long Duration Package Power Limit [Auto]

Allows you to limit the Turbo Ratio's time duration that exceeds the TDP (Thermal Design Power) for maximum performance. Use the <+> or <-> keys to adjust the value. The values range from 1W to 4096W.

Package Power Time Window [Auto]

Also known as Power Limit 1, and allows you to maintain the time window for Turbo Ratio over TDP (Thermal Design Power). Use the <+> or <-> keys to adjust the value. The values range from 1 to 127 in seconds.

Short Duration Package Power Limit [Auto]

Also known as Power Limit 2, and allows you to provide rapid protection when the package power exceeds the Power Limit 1. Use the <+> or <-> keys to adjust the value. The values range from 1W to 4096W.

CPU Integrated VR Current Limit [Auto]

Allows you to set a higher current limit to prevent frequency and power throttling when overclocking. Use the <+> or <-> keys to adjust the value. The values range from 0.125 to 1023.875 with a 0.125 interval.

CPU Internal Power Switching Frequency

Frequency Tuning Mode [Auto]

Allows you to increase or decrease the switching frequency of the internal regulator. Decrease to help consume less power or increase to help voltage stability. When this item is set to [+] or [-], the Frequency Tuning Offset appears and allows you to set its value from 0% to 6%.

CPU Internal Power Fault Control

Thermal Feedback [Auto]

Allows your system to take precautionary actions to be taken by the CPU when the thermal conditions of the external regulator exceeds the threshold. Configuration options: [Auto] [Disabled] [Enabled]

CPU Integrated VR Fault Management [Auto]

Disable this item to prevent tripping the Fully Integrated Voltage Regulator when doing over-voltage. We recommend you to disable this item when overclocking. Configuration options: [Auto] [Disabled] [Enabled]

CPU Internal Power Configuration

CPU Integrated VR Efficiency Management [Auto]

Allows you to improve power saving when the processor is in low power state. Disable to make the Fully Integrated Voltage Regulator work in high performance at all times. Configuration options: [Auto] [High Performance] [Balanced]

Power Decay Mode [Auto]

Allows your system to improve the power saving mode on the Fully Integrated Voltage Regulator as the processor goes into low current state. Configuration options: [Auto] [Disabled] [Enabled]

Idle Power-in Response [Auto]

Allows you to set the slew rate for the Fully Integrated Voltage Regulator as it enters manual override mode. Configuration options: [Auto] [Regular] [Fast]

Idle Power-out Response [Auto]

Allows you to set the slew rate for the Fully Integrated Voltage Regulator as it exits manual override mode. Configuration options: [Auto] [Regular] [Fast]

Power Current Slope [Auto]

Allows you to set the gradient of the high-speed active phase current balance during load transients to eliminate current imbalance that can result from a load current oscillating near the switching frequency. Configuration options: [Auto] [LEVEL -4] - [LEVEL 4]

Power Current Offset [Auto]

Allows you to increase or decrease the output current sensed by the CPU. It finds the balance between optimal regulating while staying below the current threshold. Configuration options: [Auto] [100%] [87.5%] [75.0%] [62.5%] [50.0%] [37.5%] [25.0%] [12.5%] [0%] [-12.5%] [-25.0%] [-37.5%] [-50.0%] [-62.5%] [-75.0%] [-87.5%] [-100%]

Power Fast Ramp Response [Auto]

Allows you to increase to enhance the response of the voltage regulator during the load transient. Configuration options: [Auto] [0.00] - [1.50]

CPU Internal Power Saving Control

Power Saving Level 1 Threshold [Auto]

Lower value provides sufficient overclocking tolerance to enlarge the overclocking potential. Higher value provides better power-saving condition. Use <+> or <-> key to adjust the value. The values range from 0A to 80A at 1Amp increment.

Power Saving Level 2 Threshold [Auto]

Lower value provides sufficient overclocking tolerance to enlarge the overclocking potential. Higher value provides better power-saving condition. Use <+> or <-> key to adjust the value. The values range from 0A to 50A at 1Amp increment.

Power Saving Level 3 Threshold [Auto]

Lower value provides sufficient overclocking tolerance to enlarge the overclocking potential. Higher value provides better power-saving condition. Use <+> or <-> key to adjust the value. The values range from 0A to 30A at 1Amp increment.

VCCIN Voltage [Auto]

Allows you to set an input voltage for the processor by the external voltage regulator. Use the <+> or <-> keys to adjust the value. The values range from 0.800V to 3.040V with a 0.010V interval.

CPU Core Voltage [Auto]

Allows you to configure the voltage amount for the processor's cores. Increase the voltage when setting a high Core Frequency value. Configuration options: [Auto] [Manual Mode] [Offset Mode] [Adaptive Mode]



The following item appears only when you set the CPU Core Voltage to **[Manual Mode]**.

CPU Core Voltage Override [Auto]

Allows you to set the CPU Core Voltage override. Use the <+> or <-> keys to adjust the value. The values range from 0.001V to 1.920V with a 0.001V interval.



The following items appear only when you set the CPU Core Voltage to **[Offset Mode]** or **[Adaptive Mode]**.

Offset Mode Sign [+]

[+] To offset the voltage by a positive value.

[-] To offset the voltage by a negative value.

CPU Core Voltage Offset

Use the <+> or <-> keys to adjust the value. The values range from 0.001V to 0.999V with a 0.001V interval.



The following item appears only when you set the CPU Core Voltage to **[Adaptive Mode]**.

Additional Turbo Mode CPU Core Voltage [Auto]

This item allows you to add voltage for Turbo Mode CPU core. Use the <+> or <-> keys to adjust the value. The values range from 0.001V to 1.920V with a 0.001V interval.

CPU Graphics Voltage [Auto]

Allows you to configure the voltage amount for the integrated graphics processing unit (iGPU). Increase the voltage when setting a high iGPU frequency value. Configuration options: [Auto] [Manual Mode] [Offset Mode] [Adaptive Mode]



The following item appears only when you set the CPU Graphics Voltage to **[Manual Mode]**.

CPU Graphics Voltage Override [Auto]

Allows you to set the CPU Graphics Voltage override. By default, this item takes the standard value of the installed CPU. You can use the <+> or <-> keys to adjust the value. The values range from 0.001V to 1.920V with a 0.001V interval.



The following items appear only when you set the CPU Graphics Voltage to **[Offset Mode]** or **[Adaptive Mode]**.

Offset Mode Sign [+]

- [+] To offset the voltage by a positive value.
- [-] To offset the voltage by a negative value.

CPU Graphics Voltage Offset

By default, this item takes the standard value of the installed CPU. You can use the <+> or <-> keys to adjust the value. The values range from 0.001V to 0.999V with a 0.001V interval.



The following item appears only when you set the CPU Graphics Voltage to **[Adaptive Mode]**.

Additional Turbo Mode CPU Graphics Voltage [Auto]

This item allows you to increase the voltage for Turbo Mode CPU Graphics. By default, this item takes the standard value of the installed CPU. You can use the <+> or <-> keys to adjust the value. The values range from 0.001V to 1.920V with a 0.001V interval.

CPU Cache Voltage [Auto]

Allows you to configure the voltage fed to the uncore of the processor including its cache. Increase the voltage when increasing Ring frequency. Configuration options: [Auto] [Manual Mode] [Offset Mode] [Adaptive Mode]



The following item appears only when you set the CPU Cache Voltage to **[Manual Mode]**.

CPU Cache Voltage Override [Auto]

Allows you to set the CPU Cache Voltage override. Use the <+> or <-> keys to adjust the value. The values range from 0.001V to 1.920V with a 0.001V interval.



The following items appear only when you set the CPU Cache Voltage to **[Offset Mode]** or **[Adaptive Mode]**.

Offset Mode Sign [+]

- [+] To offset the voltage by a positive value.
- [-] To offset the voltage by a negative value.

CPU Cache Voltage Offset

Allows you to set the CPU cache voltage offset. Use the <+> or <-> keys to adjust the value. The values range from 0.001V to 0.999V with a 0.001V interval.



The following item appears only when you set the CPU Cache Voltage to **[Adaptive Mode]**.

Additional Turbo Mode CPU Cache Voltage [Auto]

Allows you to add voltage for Turbo Mode CPU Graphics. Use the <+> or <-> keys to adjust the value. The values range from 0.001V to 1.920V with a 0.001V interval.

CPU System Agent Voltage Offset Mode Sign [+]

- [+] To offset the voltage by a positive value.
- [-] To offset the voltage by a negative value.

CPU System Agent Voltage Offset [Auto]

Allows you to configure the amount of voltage fed to the system agent of the processor including its PCIe controller and power control unit. Increase the voltage when increasing DRAM frequency. Use the <+> or <-> keys to adjust the value. Use the <+> or <-> keys to adjust the value. The values range from 0.001V to 0.999V with a 0.001V interval.

CPU Analog I/O Voltage Offset Mode Sign [+]

- [+] To offset the voltage by a positive value.
- [-] To offset the voltage by a negative value.

CPU Analog I/O Voltage Offset [Auto]

Allows you to configure the amount of voltage fed to the analog portion of the I/O on the processor. By default, this item takes the standard value of the installed CPU. Increase voltage when increasing DRAM frequency. You can use the <+> or <-> keys to adjust the value. The values range from 0.001V to 0.999V with a 0.001V interval.

CPU Digital I/O Voltage Offset Mode Sign [+]

- [+] To offset the voltage by a positive value.
- [-] To offset the voltage by a negative value.

CPU Digital I/O Voltage Offset [Auto]

Allows you to configure the amount of voltage fed to the digital portion of the I/O on the processor. By default, this item takes the standard value of the installed CPU. Increase the voltage when increasing DRAM frequency. You can use the <+> or <-> keys to adjust the value. The values range from 0.001V to 0.999V with a 0.001V interval.

SVID Support [Auto]

When overclocking, set this item to **[Enabled]**. Disabling this item would stop the processor from communicating with the external voltage regulator. Configuration options: **[Auto]** **[Disabled]** **[Enabled]**



-
- We recommend that you disable this function when overclocking.
 - The following item appears only when you set SVID Support to **[Enabled]**.
-

SVID Voltage Override [Auto]

Allows you to set the SVID Voltage override. By default, this item takes the standard value of the installed CPU. You can use the <+> or <-> keys to adjust the value. The values range from 0.001V to 2.440V with a 0.001V interval.

DRAM Voltage [Auto]

Allows you to set the DRAM voltage. The values range from 1.185V to 1.800V with a 0.005V interval.



According to Intel CPU specifications, DIMMs with voltage requirement over 1.65V may damage the CPU permanently. We recommend that you install the DIMMs with the voltage requirement below 1.65V.

PCH VLX Voltage [Auto]

Allows you to set the I/O voltage on the PCH (Platform Controller Hub). You can use the <+> or <-> keys to adjust the value. The values range from 1.185V to 2.135V with a 0.005V interval.

PCH Voltage [Auto]

Allows you to set the Core voltage for the PCH (Platform Controller Hub). You can use the <+> or <-> keys to adjust the value. The values range from 0.735V to 1.500V with a 0.005V interval.



The system may need better cooling system for a more stable performance under high voltage settings.

DRAM CTRL REF Voltage [Auto]

This item is the DRAM reference voltage for the control lines from the memory bus. You can use the <+> or <-> keys to adjust the value. The values range from 0.3950x to 0.6300x with a 0.0050x interval.

DRAM DATA REF Voltage on CHA/CHB [Auto]

This item is the DRAM reference voltage for the data lines on Channels A and B. You can use the <+> or <-> keys to adjust the value. The values range from 0.3950x to 0.6300x with a 0.0050x interval. Different ratio might enhance DRAM overlocking ability.

CPU Spread Spectrum [Auto]

- [Auto] Automatic configuration.
- [Disabled] Enhances the BCLK overlocking ability.
- [Enabled] Sets to [Enabled] for EMI control.

3.6 Advanced menu

The Advanced menu items allow you to change the settings for the CPU and other system devices.



Be cautious when changing the settings of the Advanced menu items. Incorrect field values can cause the system to malfunction.



3.6.1 CPU Configuration

The items in this menu show the CPU-related information that the BIOS automatically detects.



The items in this menu may vary based on the CPU installed.

Scroll down to display other BIOS items.



Intel Adaptive Thermal Monitor [Enabled]

[Enabled] Enables the overheated CPU to throttle its clock speed to cool down.

[Disabled] Disables the CPU thermal monitor function.

Hyper-threading [Enabled]

The Intel Hyper-Threading Technology allows a hyper-threading processor to appear as two logical processors to the operating system, allowing the operating system to schedule two threads or processes simultaneously.

[Enabled] Two threads per activated core are enabled.

[Disabled] Only one thread per activated core is enabled.

Active Processor Cores [All]

Allows you to choose the number of CPU cores to activate in each processor package.

Configuration options: [All] [1] [2] [3]

Limit CPUID Maximum [Disabled]

When set to **[Enabled]**, this item allows the legacy OS to boot even without support for CPUs with extended CPUID functions. Configuration options: **[Enabled]** **[Disabled]**

Execute Disable Bit [Enabled]

Execute Disable prevents certain classes of malicious buffer overflow attacks when combined with a supporting OS (SuSE Linux 9.2, RedHat Enterprise 3 Update 3). Configuration options: **[Disabled]** **[Enabled]**

Intel Virtualization Technology [Disabled]

When set to **[Enabled]**, a VMM can utilize the additional hardware capabilities provided by Vanderpool Technology. Configuration options: **[Disabled]** **[Enabled]**

Hardware Prefetcher [Enabled]

Allows you to enable or disable the Mid Level Cache (L2) streamer prefetcher. Configuration options: **[Disabled]** **[Enabled]**

Adjacent Cache Line Prefetch [Enabled]

Allows you to enable or disable the Mid Level Cache (L2) prefetching of adjacent cache lines. Configuration options: **[Disabled]** **[Enabled]**

Boot Performance mode [Max Non-Tu...]

Allows you to select the performance state that the BIOS will set before OS handoff. Configuration options: **[Max Non-Turbo performance]** **[Max Battery]** **[Turbo Performance]**

Dynamic Storage Accelerator [Disabled]

Allows you to enable or disable Dynamic Storage Accelerator for C state configuration. Configuration options: **[Enabled]** **[Disabled]**

CPU Power Management Configuration

This item allows you to manage and configure the CPU's power.

Enhanced Intel SpeedStep Technology [Enabled]

Allows your system to adjust the processor's voltage and cores frequency, resulting in decreased power consumption and heat production.

[Disabled] The CPU runs at its default speed.

[Enabled] The system controls the CPU speed.

Turbo Mode [Enabled]

Allows you to automatically set the processor cores to run faster than the base frequency when operating below power, current and temperature specification limit.

Configuration options: **[Enabled]** **[Disabled]**

CPU C States

Allows you to enable or disable the CPU C states. Configuration options: [Auto] [Enabled] [Disabled]



The following items appear only when you set the CPU C States to **[Enabled]**.

Enhanced C1 state [Enabled]

Allows your processor to reduce power when the system is in idle mode.
Configuration options: [Enabled] [Disabled]

CPU C3 Report [Enabled]

Allows you to disable or enable the CPU C3 report to the operating system.
Configuration options: [Enabled] [Disabled]

CPU C6 Report [Enabled]

Allows you to disable or enable the CPU C6 report to the operating system.
Configuration options: [Enabled] [Disabled]

C6 Latency [Short]

Allows you to set the duration of C6 latency for C6 state. Configuration options: [Short] [Long]

CPU C7 Report [CPU C7s]

Allows you to disable or enable the CPU C7 report to the operating system.
Configuration options: [Disabled] [CPU C7] [CPU C7s]

C7 Latency [Long]

Allows you to set the duration of C7 latency for C7 state. Configuration options: [Short] [Long]

Package C State Support [Auto]

Allows you to set the a C-state according to the following configuration options: [Auto] [Enabled] [C0/C1] [C2] [C3] [C6] [CPU C7] [CPU C7s]

3.6.2 PCH Configuration

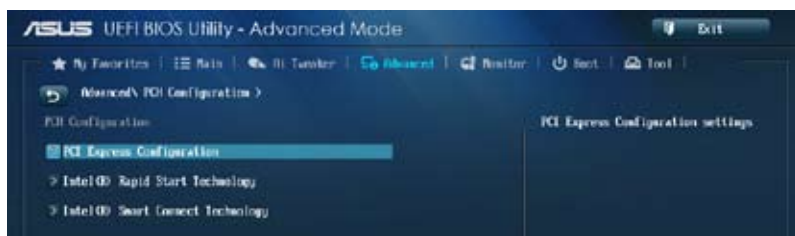

PCI Express Configuration

Allows you to configure the PCI Express slots.

DMI Link ASPM Control [Auto]

Allows you to control the ASPM (Active State Power Management) on both Northbridge side and Southbridge side of the DMI Link. Configuration options: [Disabled] [Enabled] [Auto]

ASPM Support [Disabled]

Allows you to set the ASPM level. Configuration options: [Disabled] [Auto] [L0s] [L1] [L0sL1]

PCIe Speed [Auto]

Allows you to select the PCI Express port speed. Configuration options: [Auto] [Gen1] [Gen2]

Intel Rapid Start Technology [Disabled]

Allows you to enable or disable Intel Rapid Start Technology. Configuration options: [Enabled] [Disabled]



The following items appear only when you set the Intel Rapid Start Technology to [Enabled].

Entry on S3 RTC Wake [Enabled]

The system automatically wakes up and set to Rapid Start Technology S4 mode. Configuration options: [Enabled] [Disabled]

Entry After [0]

Allows you to set the RTC wake-up timer at S3 entry. The time ranges from 0 minute (immediately) to 120 minutes.

Active Page Threshold Support [Enabled]

The system automatically goes into sleep mode when the partition size is not enough for the Intel® Rapid Start Technology to work. Configuration options: [Enabled] [Disabled]

Active Memory Threshold [0]

This item supports Intel Rapid Storage Technology when the partition size is greater than the Active Page Threshold size. When set to zero (0), it will go to Auto mode and checks if the partition size is enough at S3 entry.



Ensure that the caching partition size is larger than the total memory size.

Hybrid Hard Disk Support [Disabled]

Allows you to enable or disable the hybrid hard disk support. Configuration options: [Enabled] [Disabled]

Intel Smart Connect Technology

ISCT Support [Disabled]

Allow you to enable or disable the Intel® Smart Connect Technology. Configuration options: [Enabled] [Disabled]

3.6.3 SATA Configuration

While entering Setup, the BIOS automatically detects the presence of SATA devices. The SATA Port items show **Empty** if no SATA device is installed to the corresponding SATA port. Scroll down to display the other BIOS items.



SATA Mode Selection [AHCI]

Allows you to set the SATA configuration.

- [Disabled] Disables the SATA function.
- [IDE] Set to [IDE Mode] when you want to use the Serial ATA hard disk drives as Parallel ATA physical storage devices.
- [AHCI] Set to [AHCI Mode] when you want the SATA hard disk drives to use the AHCI (Advanced Host Controller Interface). The AHCI allows the onboard storage driver to enable advanced Serial ATA features that increases storage performance on random workloads by allowing the drive to internally optimize the order of commands.
- [RAID] Set to [RAID Mode] when you want to create a RAID configuration from the SATA hard disk drives.

Aggressive LPM Support [Auto]

This item appears only when you set the SATA Mode Selection item to [AHCI] or [RAID], and allow you to enable the PCH to aggressively enter link power state. Configuration options:

[Disabled] [Enabled] [Auto]

IDE Legacy / Native Mode Selection [Native]

This item appears only when you set the SATA Mode Selection item to [IDE]. Configuration options: [Native] [Legacy]

S.M.A.R.T. Status Check [Enabled]

S.M.A.R.T. (Self-Monitoring, Analysis and Reporting Technology) is a monitor system. When read/write of your hard disk errors occur, this feature allows the hard disk to report warning messages during the POST. Configuration options: [Enabled] [Disabled]

Hot Plug [Disabled] (SATA6G_1 - SATA6G_6 [Yellow])

This item appears only when you set the SATA Mode Selection item to [AHCI] or [RAID], and allow you to enable/disable SATA Hot Plug Support. Configuration options: [Disabled] [Enabled]

3.6.4 System Agent Configuration

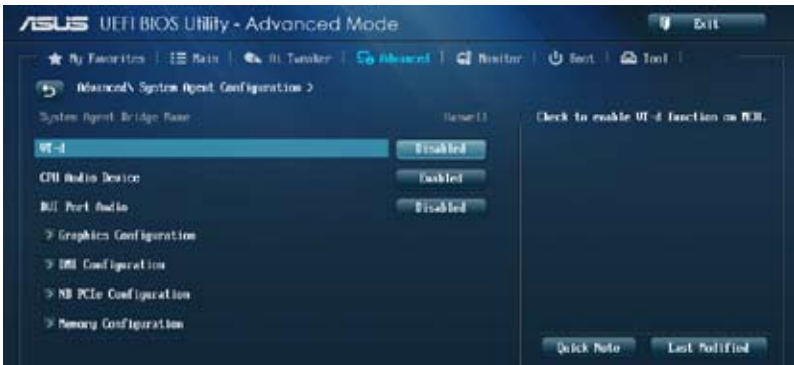

VT-d [Disabled]

Allows you to enable virtualization technology function on memory control hub.

[Enabled] Enables the function.

[Disabled] Disables this function.

CPU Audio Devices [Enabled]

Allows you to enable or disable CPU SA Audio devices. Configuration options: [Enabled] [Disabled]

DVI Port Audio [Disabled]

Allows you to enable or disable the DVI port. Configuration options: [Enabled] [Disabled]

Graphics Configuration

Allows you to select a primary display from iGPU, and PCIe graphical devices.

Primary Display [Auto]

Allows you to select the primary display from iGPU and PCIe Graphics devices.

Configuration options: [Auto] [iGPU] [PCIe]

iGPU Memory [Auto]

Allows you to set the system memory size allocated to DVMT 5.0 used by the iGPU.

Configuration options: [Auto] [32M] [64M] [96M] [128M] ~ [448M] [480M] [512M]

Render Standby [Auto]

Allows you to enable or disable Intel® Graphics Render Standby support to reduce iGPU power use when the system is idle.

Configuration options: [Auto] [Disabled] [Enabled]

iGPU Multi-Monitor [Disabled]

Allows you to enable the iGPU Multi-Monitor. For LucidLogix Virtu MVP function support, set this item to [Enabled] to empower both integrated and discrete graphics. The iGPU shared system memory size will be fixed at 64MB.

Configuration options: [Disabled] [Enabled]

DMI Configuration

Allows you to control various DMI (Desktop Management Interface) functions.

DMI Gen 2 [Auto]

Allows you to enable or disable DMI Gen 2. Configuration options: [Auto] [Enabled] [Disabled]

NB PCIe Configuration

Allows you to configure the NB PCI Express settings.

PCIEx16_1 Link Speed [Auto]

Allows you to configure the PCIEx16 speed for slot 1. Configuration options: [Auto] [Gen1] [Gen2] [Gen3]

DMI Link ASPM Control [Disabled]

Allows you to enable or disable the control of Active State Power Management on SA side of the DMI Link. Configuration options: [Disabled] [L0s] [L1] [L0sL1]

PEG - ASPM [Disabled]

Allows you to control ASPM support for the PEG device. Configuration options: [Disabled] [Auto] [ASPM L0s] [ASPM L1] [ASPM L0sL1]

Memory Configuration

Allows you to configure the memory configuration parameters.

Memory Scrambler [Enabled]

Allows you to enable or disable the Memory Scrambler support. Configuration options: [Enabled] [Disabled]

Memory Remap [Enabled]

Allows you to enable remapping the memory above 4GB. Configuration options: [Enabled] [Disabled]

3.6.5 USB Configuration

The items in this menu allow you to change the USB-related features.

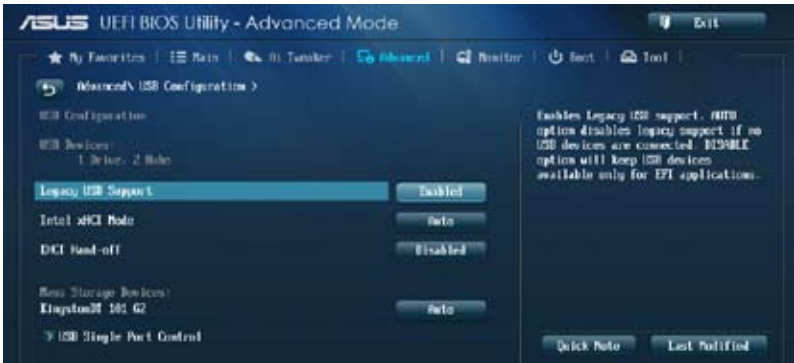

The **USB Devices** item shows the auto-detected values. If no USB device is detected, the item shows **None**.

Legacy USB Support [Enabled]

- [Enabled] Enables the support for USB devices on legacy operating systems (OS).
- [Disabled] The USB devices can be used only for the BIOS setup program. It cannot be recognized in boot devices list.
- [Auto] Allows the system to detect the presence of USB devices at startup. If detected, the USB controller legacy mode is enabled. If no USB device is detected, the legacy USB support is disabled.

Intel xHCI Mode [Auto]

- [Auto] Keeps the last operation of xHCI controller in OS during bootup.
- [Smart Auto] Enables the operation of xHCI controller.
- [Enabled] Enables the xHCI controller.
- [Disabled] Disables the xHCI controller.

EHCI Hand-off [Disabled]

- [Enabled] Enables the support for operating systems without an EHCI hand-off feature.
- [Disabled] Disables the EHCI Hand-off support.

USB Single Port Control

Allows you to enable or disable the individual USB port.



Refer to section **1.2.2 Motherboard layout** for the location of the USB ports.

3.6.6 Platform Misc Configuration

The items in this menu allow you to configure the platform-related features.



PCI Express Native Power Management [Disabled]

Allows you to enhance the power saving feature of PCI Express and perform ASPM operations in the operating system. Configuration options: [Disabled] [Enabled]



The following item appears only when you set the PCI Express Native Power Management to **[Enabled]**.

Native ASPM [Disabled]

[Enabled] Vista controls the ASPM support for the device.

[Disabled] BIOS controls the ASPM support for the device.

3.6.7 Onboard Devices Configuration

Scroll down to view the other BIOS items.



HD Audio Controller [Enabled]

[Enabled] Enables the High Definition Audio Controller.

[Disabled] Disables the controller.



The following two items appear only when you set the HD Audio Controller item to **[Enabled]**.

Front Panel Type [HD]

Allows you to set the front panel audio connector (AAFP) mode to legacy AC'97 or high-definition audio depending on the audio standard that the front panel audio module supports.

[HD] Sets the front panel audio connector (AAFP) mode to high definition audio.

[AC97] Sets the front panel audio connector (AAFP) mode to legacy AC'97

SPDIF Out Type [SPDIF]

[SPDIF] Sets to an SPDIF audio output.

[HDMI] Sets to an HDMI audio output.

PCI Express x16_2 slot (dark brown) bandwidth [X2 mode]

[X2 mode] PCIe x16_2 slot runs at X2 mode with all slots enabled.

[X4 mode] PCIe x16_2 slot runs at X4 mode for high performance support. PCIe x1_2 slot will be disabled.

Realtek LAN Controller [Enabled]

[Enabled] Enables the Realtek® LAN controller.

[Disabled] Disables the Realtek® LAN controller.



The following item appears only when you set the **Realtek LAN Controller** item to **[Enabled]**.

Realtek PXE OPROM [Disabled]

Allows you to enable or disable the PXE OptionRom of the Realtek LAN controller.

Configuration options: [Enabled] [Disabled]

Serial Port Configuration

The sub-items in this menu allow you to set the serial port configuration.



This item functions only if there is a serial port (COM) connector on the motherboard.

Serial Port [Enabled]

Allows you to enable or disable the serial port (COM). Configuration options: [Enabled] [Disabled]

Change Settings [IO=3F8h; IRQ=4]

Allows you to select the Serial Port base address. Configuration options: [IO=3F8h; IRQ=4] [IO=2F8h; IRQ=3] [IO=3E8h; IRQ=4] [IO=2E8h; IRQ=3]

3.6.8 APM



Deep S4 [Disabled]

When enabled, the system in S4 state will further reduce power usage and will power off the USB and PS/2 devices. The system in deep S4 state can be woken up via the power button, devices in LAN, or other ways except via the USB and PS/2 devices. Configuration options: [Disabled] [Enabled]

Restore AC Power Loss [Power Off]

- [Power On] The system goes into ON state after an AC power loss.
- [Power Off] The system goes into OFF state after an AC power loss.
- [Last State] The system goes into either OFF or ON state, whatever the system state was before the AC power loss.

Power On By PS/2 Keyboard [Disabled]

- [Disabled] Disables the Power On by a PS/2 keyboard.
- [Space Bar] Sets the Space Bar on the PS/2 keyboard to turn on the system.
- [Ctrl-Esc] Sets the Ctrl+Esc key on the PS/2 keyboard to turn on the system.
- [Power Key] Sets Power key on the PS/2 keyboard to turn on the system. This feature requires an ATX power supply that provides at least 1A on the +5VSB lead.

Power On By PCIE [Disabled]

- [Disabled] Disables the PCIE devices to generate a wake-on-LAN feature of the Realtek LAN device or other installed PCIE LAN devices.
- [Enabled] Enables the PCIE devices to generate a wake-on-LAN feature of the Realtek LAN device or other installed PCIE LAN devices.

Power On By Ring [Disabled]

- [Disabled] Disables Ring to generate a wake event.
- [Enabled] Enables Ring to generate a wake event.

Power On By RTC [Disabled]

- [Disabled] Disables RTC to generate a wake event.
- [Enabled] When set to [Enabled], the items **RTC Alarm Date (Days)** and **Hour/Minute/Second** will become user-configurable with set values.

3.6.9 Network Stack



Network Stack [Disabled]

This item allows user to disable or enable the UEFI network stack. Configuration options: [Disabled] [Enabled]



The following items appear only when you set the Network Stack to **[Enabled]**.

Ipv4/Ipv6 PXE Support [Enabled]

Allows you to enable or disable the Ipv4/Ipv6 PXE boot option. Configuration options: [Disabled] [Enabled]

3.7 Monitor menu

The Monitor menu displays the system temperature/power status, and allows you to change the fan settings.

Scroll down to display the other BIOS items.



CPU Temperature [xxx°C/xxx°F]

The onboard hardware monitor automatically detects and displays the CPU temperature. Select **[Ignore]** if you do not wish to display the detected temperature.

CPU Fan Speed [xxxx RPM] or [Ignore] / [N/A], Chassis Fan 1/2 Speed [xxxx RPM] or [Ignore] / [N/A]

The onboard hardware monitor automatically detects and displays the CPU and chassis fan speed in rotations per minute (RPM). If the fan is not connected to the motherboard, the field shows N/A. Select **[Ignore]** if you do not wish to display the detected speed.

VCCIN Voltage, 3.3V Voltage, 5V Voltage, 12V Voltage

The onboard hardware monitor automatically detects the voltage output through the onboard voltage regulators. Select **[Ignore]** if you do not want to detect this item.

CPU Q-Fan Control [Enabled]

- [Disabled] Disables the CPU Q-Fan control feature.
[Enabled] Enables the CPU Q-Fan control feature.



The following items appear only when you set the **CPU Q-Fan Control** item to **[Enabled]**.

CPU Fan Speed Low Limit [200 RPM]

Allows you to set the low limit warning for CPU Fan speed. Configuration options: [Ignore] [100 RPM] [200 RPM] [300 RPM] [400 RPM] [500 RPM]

CPU Fan Profile [Standard]

Allows you to set the appropriate performance level of the CPU fan.

- [Standard] Set to make the CPU fan adjust automatically depending on the CPU temperature.
[Silent] Set to minimize the fan speed for quiet CPU fan operation.
[Turbo] Set to achieve maximum CPU fan speed.
[Manual] Set to assign detailed fan speed control parameters.



The following four items appear only when you set CPU Fan Profile to **[Manual]**.

CPU Upper Temperature [70]

Use the <+> and <-> keys to adjust the upper limit of the CPU temperature. The values range from 20°C to 75°C.

CPU Fan Max. Duty Cycle(%) [100]

Use the <+> and <-> keys to adjust the maximum CPU fan duty cycle. The values range from 20% to 100%. When the CPU temperature reaches the upper limit, the CPU fan will operate at the maximum duty cycle.

CPU Lower Temperature [20]

Displays the lower limit of the CPU temperature.

CPU Fan Min. Duty Cycle(%) [20]

Use the <+> and <-> keys to adjust the minimum CPU fan duty cycle. The values range from 20% to 100%. When the CPU temperature is under 40°C, the CPU fan will operate at the minimum duty cycle.

Chassis1/2 Q-Fan Control [Enabled]

- [Disabled] Disables the Chassis Q-Fan control feature.
[Enabled] Enables the Chassis Q-Fan control feature.



The following items appear only when you set the **Chassis1/2 Q-Fan Control** items to **[Enabled]**.

Chassis1/2 Fan Speed Low Limit [600 RPM]

Allows you to disable or set the chassis fan warning speed. Configuration options: [Ignore] [200 RPM] [300 RPM] [400 RPM] [500 RPM] [600 RPM]

Chassis1/2 Fan Profile [Standard]

Allows you to set the appropriate performance level of the chassis fan.

[Standard] Set to make the CPU fan adjust automatically depending on the CPU temperature.

[Silent] Set to minimize the fan speed for quiet CPU fan operation.

[Turbo] Set to achieve maximum CPU fan speed.

[Manual] Set to assign detailed fan speed control parameters.



The following four items appear only when you set the Chassis1/2 Fan Profile items to **[Manual]**.

Chassis1/2 Upper Temperature [70]

Use the <+> and <-> keys to adjust the upper limit of the CPU temperature. The values range from 40°C to 75°C.

Chassis1/2 Fan Max. Duty Cycle(%) [100]

Use the <+> and <-> keys to adjust the maximum chassis fan duty cycle. The values range from 60% to 100%. When the chassis temperature reaches the upper limit, the chassis fan will operate at the maximum duty cycle.

Chassis1/2 Lower Temperature [40]

Displays the lower limit of the chassis temperature.

CPU Fan1/2 Min. Duty Cycle(%) [60]

Use the <+> and <-> keys to adjust the minimum chassis fan duty cycle. The values range from 60% to 100%. When the chassis temperature is under 40°C, the chassis fan will operate at the minimum duty cycle.

Anti Surge Support [Enabled]

This item allows you to enable or disable the Anti Surge function. Configuration options: [Disabled] [Enabled]

3.8 Boot menu

The Boot menu items allow you to change the system boot options.

Scroll down to display the other BIOS items.



Boot Configuration

Fast Boot [Enabled]

[Disabled] Allows your system to go back to its normal boot speed.

[Enabled] Allows your system to accelerate the boot speed.



The following four items appear only when you set **Fast Boot** to **[Enabled]**.

USB Support [Partial In...]

[Disabled] All USB devices will not be available until OS boot up for a fastest POST time.

[Full Initialization] All USB devices will be available during POST. This process will extend the POST time.

[Partial Initialization] For a faster POST time, only USB ports with keyboard and mouse connections will be detected.

PS/2 Keyboard and Mouse Support [Auto]

Select any of these settings when PS/2 keyboard and mouse are installed. These settings only apply when Fast Boot is enabled.

[Auto] For a faster POST time, PS/2 devices will only be available when the system boots up or rebooted when the PS/2 devices have not been reconnected or changed. If you disconnect or change PS/2 devices before restarting the system, PS/2 devices will not be available and BIOS setup program will not be accessible via PS/2 devices.

[Full Initialization] For full system control, PS/2 devices will be available during POST at any circumstances. This process will extend POST time.

[Disabled] For the fastest POST time, all PS/2 devices will not be available until your computer enters the operating system.

Network Stack Driver Support [Disabled]

[Disabled] Select to skip the network stack driver from loading during POST.

[Enabled] Select to load the network stack driver during POST.

Next Boot after AC Power Loss [Normal Boot]

[Normal Boot] Returns to normal boot on the next boot after an AC power loss.

[Fast Boot] Accelerates the boot speed on the next boot after an AC power loss.

Boot Logo Display [Enabled]

[Enabled] Enables the full screen boot logo display during POST.

[Disabled] Disables the full screen boot logo display during POST.



The following items appear only when you set the Boot Logo Display to **[Enabled]**.

Boot Logo Size Control [Auto]

[Auto] Automatically adjusts for Windows® requirements.

[Full Screen] Maximizes the boot logo size.

Post Delay Time [3 sec]

This item appears only when you set the Boot Logo Display item to [Enabled]. This item allows you to select a desired additional POST waiting time to easily enter the BIOS Setup. You can only execute the POST delay time during normal boot. The values range from 0 to 10 seconds.



This feature will only work when set under normal boot.



The following items appear only when you set the Boot Logo Display to **[Disabled]**.

Post Report [5 sec]

This item allows you to select a desired POST report waiting time. Configuration options: [1 sec] - [10 sec] [Until Press ESC]

Bootup NumLock State [On]

[On] Set the power-on state of the NumLock to **[On]**.

[Off] Set the power-on state of the NumLock to **[Off]**.

Wait For 'F1' If Error [Enabled]

[Disabled] Disables the function.

[Enabled] The system waits for the <F1> key to be pressed when error occurs.

Option ROM Messages [Force BIOS]

[Force BIOS] The third-party ROM messages will be displayed during the boot sequence.

[Keep Current] The third-party ROM messages will be displayed only if the third-party manufacturer had set the add-on device to do so.

Interrupt 19 Capture [Disabled]

Allows you to trap Interrupt 19 by the option ROMs. Configuration options: [Disabled]

[Enabled]

Setup Mode [EZ Mode]

[Advanced Mode] Allows you to go to Advanced Mode of the BIOS after POST.

[EZ Mode] Allows you to go to EZ Mode of the BIOS after POST.

CSM (Compatibility Support Module)

Allows you to configure the CSM (Compatibility Support Module) items to fully support the various VGA, bootable devices and add-on devices for better compatibility.

Launch CSM [Enabled]

[Auto] The system automatically detects the bootable devices and the add-on devices.

[Enabled] For better compatibility, enable the CSM to fully support the non-UEFI driver add-on devices or the Windows® UEFI mode.

[Disabled] Disable the CSM to fully support the Windows® Security Update and Security Boot.



The following four items appear when you set **Launch CSM** to **[Enabled]**.

Boot Devices Control [UEFI and Legacy OpROM]

Allows you to select the type of devices that you want to boot. Configuration options: [UEFI and Legacy OpROM] [Legacy OpROM only] [UEFI only]

Boot from Network Devices [Legacy OpROM first]

Allows you to select the type of network devices that you want to launch. Configuration options: [Legacy OpROM first] [UEFI driver first] [Ignore]

Boot from Storage Devices [Legacy OpROM first]

Allows you to select the type of storage devices that you want to launch. Configuration options: [Both, Legacy OpROM first] [Both, UEFI first] [Legacy OpROM first] [UEFI driver first] [Ignore]

Boot from PCIe/PCI Expansion Devices [Legacy OpROM first]

Allows you to select the type of PCIe/PCI expansion devices that you want to launch. Configuration options: [Legacy OpROM first] [UEFI driver first]

Secure Boot

Allows you to configure the Windows Secure Boot settings and manage its keys to protect the system from unauthorized access and malwares during POST.

OS Type [Windows UEFI mode]

- [Windows UEFI Mode] Allows you to select your installed operating system. Execute the Microsoft® Secure Boot check. Only select this option when booting on Windows® UEFI mode or other Microsoft® Secure Boot compliant OS.
- [Other OS] Get the optimized function when booting on Windows® non-UEFI mode, Windows® Vista/ Windows® XP, or other Microsoft® Secure Boot non-compliant OS. Microsoft® Secure Boot only supports Windows® UEFI mode.

Key Management

This item appears only when you set OS Type to **[Windows UEFI Mode]**. It allows you to manage the Secure Boot keys.

Install Default Secure Boot keys

Allows you to immediately load the default Security Boot keys, Platform key (PK), Key-exchange Key (KEK), Signature database (db), and Revoked Signatures (dbx). When the default Secure Boot keys are loaded, all the Secure boot keys' state will change from Unloaded mode to loaded mode. The settings are applied after reboot.

Clear Secure Boot keys

This item appears only when you load the default Secure Boot keys. This item allows you to clear all default Secure Boot keys.

Save Secure Boot Keys

Allows you to save all the Security Boot keys to a USB storage device.

PK Management

The Platform Key (PK) locks and secures the firmware from any permissible changes. The system verifies the PK before your system enters the OS.

Delete PK

Allows you to delete the PK from your system. Once the PK is deleted, all the system's Secure Boot keys will not be active. Configuration options:
[Yes] [No]

Load PK from File

Allows you to load the downloaded PK from a USB storage device.

[Yes] Load the default PK.

[Enabled] Load from a USB storage device.



The PK file must be formatted as a UEFI variable structure with time-based authenticated variable.

KEK Management

The KEK (Key-exchange Key or Key Enrollment Key) manages the Signature database (db) and Revoked Signature database (dbx).



Key-exchange Key (KEK) refers to Microsoft® Secure Boot Key-Enrollment Key (KEK).

Delete the KEK

Allows you to delete the KEK from your system. Once the KEK is deleted, the db and dbx cannot be updated under operating system. Configuration options: [Yes] [No]

Load KEK from File

Allows you to load the downloaded KEK from a USB storage device.

[Yes] Load the default KEK.

[Enabled] Load from a USB storage device.

Append KEK from File

Allows you to load the additional KEK from a storage device for an additional db and dbx loaded management.

[Yes] Load the default KEK.

[Enabled] Load from a USB storage device.



The KEK file must be formatted as a UEFI variable structure with time-based authenticated variable.

DB Management

The db (Authorized Signature database) lists the signers or images of UEFI applications, operating system loaders, and UEFI drivers that you can load on the single computer.

Delete the db

Allows you to delete the db file from your system. Deleting the db file may cause boot failure. Configuration options: [Yes] [No]

Load db from File

Allows you to load the downloaded db from a USB storage device.

[Yes] Load the default db.

[Enabled] Load from a USB storage device.

Append db from File

Allows you to load the additional db from a storage device so that more custom signed UEFI executable files can be loaded. UEFI executable files include UEFI boot loaders, drivers and applications.

[Yes] Load the default db.

[Enabled] Load from a USB storage device.



The db file must be formatted as a UEFI variable structure with time-based authenticated variable.

DBX Management

The dbx (Revoked Signature database) lists the forbidden images of db items that are no longer trusted and cannot be loaded.

Delete the dbx

Allows you to delete the dbx file from your system. Deleting the dbx exposes your system to security threats.

Load dbx from File

Allows you to load the downloaded dbx from a USB storage device.

[Yes] Load the default dbx.

[Enabled] Load from a USB storage device.

Append dbx from File

Allows you to load the additional dbx from a storage device so that more custom signed UEFI executable files can be loaded. UEFI executable files include UEFI boot loaders, drivers and applications.

[Yes] Load the default dbx.

[Enabled] Load from a USB storage device.



The dbx file must be formatted as a UEFI variable structure with time-based authenticated variable.

Boot Option Priorities

These items specify the boot device priority sequence from the available devices. The number of device items that appears on the screen depends on the number of devices installed in the system.



-
- To access Windows® OS in Safe Mode, do any of the following:
 - Press <F5> when ASUS Logo appears.
 - Press <F8> after POST.
 - To select the boot device during system startup, press <F8> when ASUS Logo appears.
-

Boot Override

These items displays the available devices. The number of device items that appears on the screen depends on the number of devices installed in the system. Click an item to start booting from the selected device.

3.9 Tools menu

The Tools menu items allow you to configure options for special functions. Select an item then press <Enter> to display the submenu.

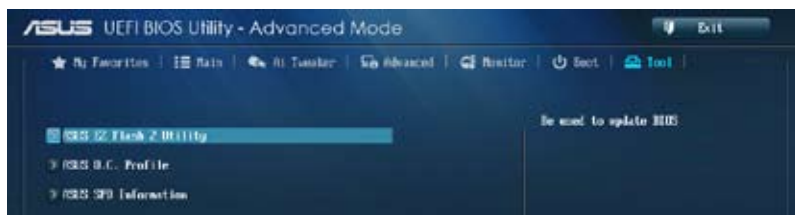

3.9.1 ASUS EZ Flash 2 Utility

Allows you to run ASUS EZ Flash 2. Press [Enter] to launch the ASUS EZ Flash 2 screen.



For more details, refer to section 3.11.2 ASUS EZ Flash 2.

3.9.2 ASUS O.C. Profile

This item allows you to store or load multiple BIOS settings.

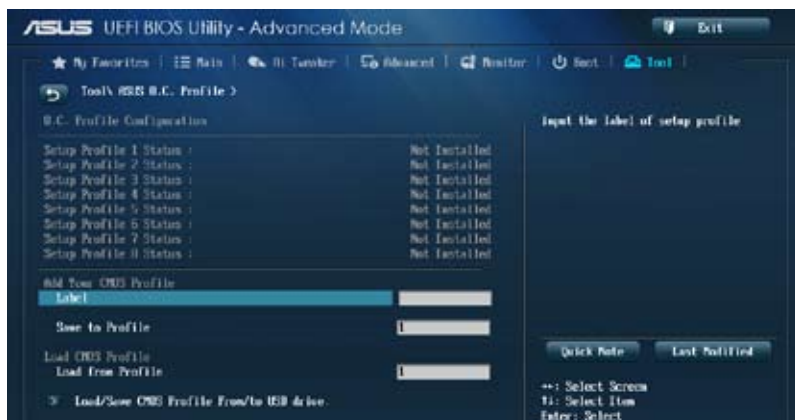

The Setup Profile Status items show **Not Installed** if no profile is created.

Label

Allows you to key in a label of the setup profile.

Save to Profile

Allows you to save the current BIOS settings to the BIOS Flash, and create a profile. Key in a profile number from one to eight, press <Enter>, and then select **Yes**.

Load from Profile

Allows you to load the previous BIOS settings saved in the BIOS Flash. Key in the profile number that saved your BIOS settings, press <Enter>, and then select **Yes**.



- DO NOT shut down or reset the system while updating the BIOS to prevent the system boot failure!
- We recommend that you update the BIOS file only coming from the same memory/ CPU configuration and BIOS version.

3.9.3 ASUS SPD Information

Allows you to view the DRAM SPD information.

ASUS UEFI BIOS Utility - Advanced Mode

Tools \ ASUS SPD Information >

DIMM Slot #1 DIMM Slot

Manufacturer: Undefined
Module Size: 1024 Mbytes
Maximum Bandwidth: 1333 MHz
Part Number:
Serial Number:
Product Week/Year:
SPD Ext.:

| JEDEC ID | JEDEC |
|------------------|-------|
| Frequency (MHz) | 1333 |
| Voltage (V) | 1.500 |
| CAS Latency (CL) | 9 |
| tRCD (tRCD) | 9 |
| tRCP (tRCP) | 9 |
| tRWD | 24 |
| tRFC | 33 |
| tRR | 10 |
| tRRD | 4 |
| tRFC | 60 |
| tRTP | 5 |
| tRTP | 5 |
| tRWD | 20 |

Quick Paste Last Modified

++: Select Screen
F1: Select Item
Enter: Select
+/-: Change Opt.
F1: General Help
F2: Previous Values
F3: Shortcut
F4: Add to ShortCut and My Favorites
F5: Optimized Defaults
F10: Save ESC: Exit
F12: Print Screen

Version 2.10.1200. Copyright (C) 2013 American Megatrends, Inc.

3.10 Exit menu

The Exit menu items allow you to load the optimal default values for the BIOS items, and save or discard your changes to the BIOS items. You can access the EZ Mode from the Exit menu.



Load Optimized Defaults

This option allows you to load the default values for each of the parameters on the Setup menus. When you select this option or if you press <F5>, a confirmation window appears. Select Yes to load the default values.

Save Changes & Reset

Once you are finished making your selections, choose this option from the Exit menu to ensure the values you selected are saved. When you select this option or if you press <F10>, a confirmation window appears. Select **Yes** to save changes and exit.

Discard Changes & Exit

This option allows you to exit the Setup program without saving your changes. When you select this option or if you press <Esc>, a confirmation window appears. Select **Yes** to discard changes and exit.

ASUS EZ Mode

This option allows you to enter the EZ Mode screen.

Launch EFI Shell from filesystem device

This option allows you to attempt to launch the EFI Shell application (shellx64.efi) from one of the available filesystem devices.

3.11 Updating BIOS

The ASUS website publishes the latest BIOS versions to provide enhancements on system stability, compatibility, or performance. However, BIOS updating is potentially risky. If there is no problem using the current version of BIOS, DO NOT manually update the BIOS. Inappropriate BIOS updating may result in the system's failure to boot. Carefully follow the instructions of this chapter to update your BIOS if necessary.



Visit the ASUS website at www.asus.com to download the latest BIOS file for this motherboard.

The following utilities allow you to manage and update the motherboard BIOS setup program.

1. ASUS Update: Updates the BIOS in Windows® environment.
2. ASUS EZ Flash 2: Updates the BIOS using a USB flash drive.
3. ASUS CrashFree BIOS 3: Restores the BIOS using the motherboard support DVD or a USB flash drive when the BIOS file fails or gets corrupted.
4. ASUS BIOS Updater: Updates and back ups the BIOS in DOS environment using the motherboard support DVD and a USB flash disk drive.



Save a copy of the original motherboard BIOS file to a USB flash disk in case you need to restore the BIOS in the future. Copy the original motherboard BIOS using the ASUS Update or BIOS Updater utilities.

3.11.1 ASUS Update

ASUS Update is a utility that allows you to manage, save, and update the motherboard BIOS in Windows® environment.



-
- ASUS Update requires an Internet connection either through a network or an ISP (Internet Service Provider).
 - This utility is available in the support DVD that comes with the motherboard package.
-

Launching ASUS Update

To launch ASUS Update, click **ASUS Update** on the AI Suite 3 main menu bar.



Quit all Windows® applications before you update the BIOS using this utility.

Updating the BIOS through the Internet

To update the BIOS through the Internet:

1. From the ASUS Update screen, select **Update BIOS from Internet**, and then click Next.



2. Select the ASUS FTP site nearest you to avoid network traffic.

If you want to enable the BIOS downgrade function, tick **Enable BIOS downgrade**.



3. Select the BIOS version that you want to download. Click **Next**.



4. You can decide whether to change the BIOS boot logo, which is the image appearing on screen during the Power-On Self-Tests (POST). Click **Yes** if you want to change the boot logo or **No** to continue.
5. Follow the onscreen instructions to complete the update process.



Updating the BIOS through a BIOS file

To update the BIOS through a BIOS file:

1. From the ASUS Update screen, select **Update BIOS from file**, and then click **Next**.



2. Locate the BIOS file and click **Next**.



3. You can decide whether to change the BIOS boot logo. Click **Yes** if you want to change the boot logo or **No** to continue.
4. Follow the onscreen instructions to complete the update process.



-
- The screenshots in this section are for reference only. The actual BIOS information vary by models.
 - Refer to the software manual in the support DVD or visit the ASUS website at www.asus.com for detailed software configuration.
-

3.11.2 ASUS EZ Flash 2

ASUS EZ Flash 2 allows you to update the BIOS without having to use a bootable floppy disk or an OS-based utility.



Before you start using this utility, download the latest BIOS from the ASUS website at www.asus.com.

To update the BIOS using EZ Flash 2:

1. Insert the USB flash disk that contains the latest BIOS file to the USB port.
2. Enter the Advanced Mode of the BIOS setup program. Go to the Tool menu to select ASUS EZ Flash Utility and press <Enter> to enable it.



3. Press <Tab> to switch to the Drive field.
4. Press the Up/Down arrow keys to find the USB flash disk that contains the latest BIOS, and then press <Enter>.
5. Press <Tab> to switch to the Folder Info field.
6. Press the Up/Down arrow keys to find the BIOS file, and then press <Enter> to perform the BIOS update process. Reboot the system when the update process is done.



-
- This function can support devices such as a USB flash disk with FAT 32/16 format and single partition only.
 - DO NOT shut down or reset the system while updating the BIOS to prevent system boot failure!
-



Ensure to load the BIOS default settings to ensure system compatibility and stability. Select the Load Optimized Defaults item under the Exit menu. See section **3.10 Exit Menu** for details.

3.11.3 ASUS CrashFree BIOS 3

The ASUS CrashFree BIOS 3 utility is an auto recovery tool that allows you to restore the BIOS file when it fails or gets corrupted during the updating process. You can restore a corrupted BIOS file using the motherboard support DVD or a USB flash drive that contains the BIOS file.



The BIOS file in the motherboard support DVD may be older than the BIOS file published on the ASUS official website. If you want to use the newer BIOS file, download the file at <http://support.asus.com> and save it to a USB flash drive.

Recovering the BIOS

To recover the BIOS:

1. Turn on the system.
2. Insert the motherboard support DVD to the optical drive, or the USB flash drive containing the BIOS file to the USB port.
3. The utility automatically checks the devices for the BIOS file. When found, the utility reads the BIOS file and enters ASUS EZ Flash 2 automatically.
4. The system requires you to enter BIOS Setup to recover the BIOS setting. To ensure system compatibility and stability, we recommend that you press <F5> to load default BIOS values.



DO NOT shut down or reset the system while updating the BIOS! Doing so can cause system boot failure!

3.11.4 ASUS BIOS Updater

The ASUS BIOS Updater allows you to update the BIOS in DOS environment. This utility also allows you to copy the current BIOS file that you can use as a backup when the BIOS fails or gets corrupted during the updating process.



The succeeding utility screens are for reference only. The actual utility screen displays may not be same as shown.

Before updating BIOS

1. Prepare the motherboard support DVD and a USB flash drive in FAT32/16 format and single partition.
2. Download the latest BIOS file and BIOS Updater from the ASUS website at <http://support.asus.com> and save them on the USB flash drive.



- NTFS is not supported under DOS environment. Do not save the BIOS file and BIOS Updater to a hard disk drive or USB flash drive in NTFS format.
- Do not save the BIOS file to a floppy disk due to low disk capacity.

3. Turn off the computer and disconnect all SATA hard disk drives (optional).

Booting the system in DOS environment

1. Insert the USB flash drive with the latest BIOS file and BIOS Updater to the USB port.
2. Boot your computer. When the ASUS Logo appears, press <F8> to show the BIOS Boot Device Select Menu. Insert the support DVD into the optical drive and select the optical drive as the boot device.

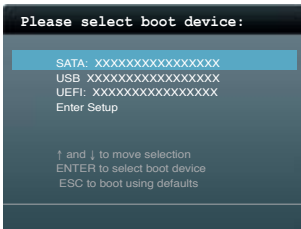

- When the Make Disk menu appears, select the FreeDOS command prompt item by pressing the item number.
- At the FreeDOS prompt, type d: and press <Enter> to switch the disk from Drive C (optical drive) to Drive D (USB flash drive).

```

Welcome to FreeDOS (http://www.freedos.org)!
C:\>d:
D:\>

```

Updating the BIOS file

To update the BIOS file using BIOS Updater:

- At the FreeDOS prompt, type bupdater /pc /g and press <Enter>.

```
D:\>bupdater /pc /g
```

- The BIOS Updater screen appears as below.

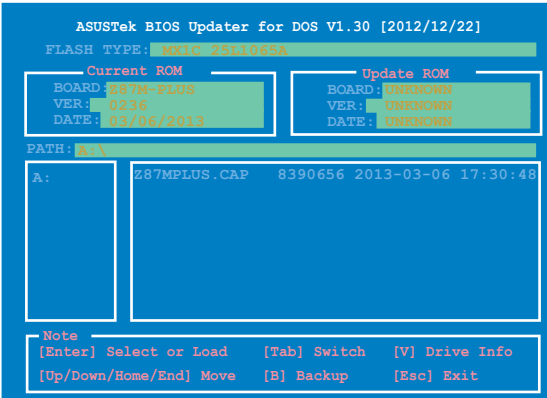

- Press <Tab> to switch between screen fields and use the <Up/Down/Home/End> keys to select the BIOS file and press <Enter>. BIOS Updater checks the selected BIOS file and prompts you to confirm BIOS update.



4. Select Yes and press <Enter>. When BIOS update is done, press <ESC> to exit BIOS Updater. Restart your computer.



DO NOT shut down or reset the system while updating the BIOS to prevent system boot failure!



- For BIOS Updater version 1.30 or later, the utility automatically exits to the DOS prompt after updating BIOS.
 - Ensure to load the BIOS default settings to ensure system compatibility and stability. Select the **Load Optimized Defaults** item under the **Exit BIOS** menu. See Chapter 3 of your motherboard user manual for details.
 - Ensure to connect all SATA hard disk drives after updating the BIOS file if you have disconnected them.
-

Software support

4

4.1 Installing an operating system



- This motherboard supports Windows® 7 32/64-bit and Windows® 8 32/64-bit operating systems (OS).
- Motherboard settings and hardware options vary. The setup procedures presented in this chapter are for reference only. Refer to Windows® operating system documentation for detailed information.

4.2 Support DVD information



The contents of the support DVD are subject to change at any time without notice. Visit the ASUS website at www.asus.com for updates.

4.2.1 Running the support DVD

Place the support DVD into the optical drive. The DVD automatically displays the Drivers menu if Autorun is enabled in your computer. Click each menu tab and select the items you want to install.

The Drivers menu shows the available device drivers if the system detects installed devices. Install the necessary drivers to use the devices.

The AHCI/RAID Driver menu contains items to create the RAID/AHCI driver disk.

The Manual menu contains the list of supplementary user manuals. Click an item to open the folder of the user manual.

The Utilities menu shows the applications and other software that the motherboard supports.

Click an item to install

Click the Contact tab to display the ASUS contact information.

Click an icon to display DVD/motherboard information



If Autorun is NOT enabled in your computer, browse the contents of the support DVD to locate the file ASSETUP.EXE from the BIN folder. Double-click the ASSETUP.EXE to run the DVD.

4.2.2 Obtaining the software manuals

The software manuals are included in the support DVD. Follow the instructions below to get the necessary software manuals.



The software manual files are in Portable Document Format (PDF). Install the Adobe® Acrobat® Reader from the **Utilities** tab before opening the files.

To read about your motherboard's utility guide:

1. Click **Manual** tab > **ASUS Motherboard Utility Guide**.

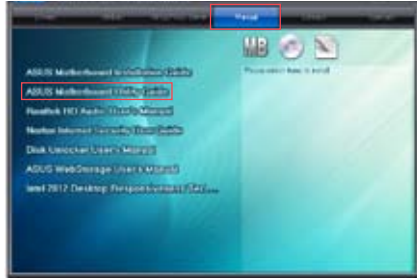

2. From the **Manual** folder, open the folder of the software manual that you wish to read.

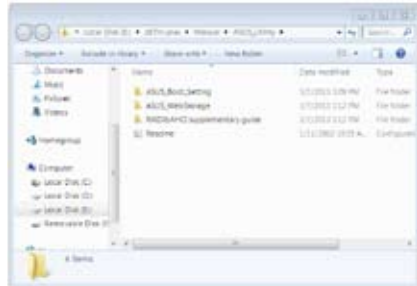

3. Some software manuals are provided in different languages. Open the language's folder to view the software manual.



The screenshots in this section are for reference only. The actual software manuals containing in the support DVD vary by models.

4.3 Software information

Most of the applications in the support DVD have wizards that will conveniently guide you through the installation. View the online help or readme file that came with the software application for more information.

4.3.1 AI Suite 3

AI Suite 3 is an all-in-one interface that integrates several ASUS utilities and allows you to launch and operate these utilities simultaneously.

Installing AI Suite 3

To install AI Suite 3 on your computer:

1. Place the support DVD to the optical drive. The **Specials** tab appears if your computer has enabled the Autorun feature.
2. Click **Utilities** tab > **ASUS AI Suite 3**.
3. Follow the onscreen instructions to complete the installation.
4. After the AI Suite 3 is installed, restart your computer.

Using AI Suite 3

You can launch the AI Suite 3 for the following Windows® operating systems:

- For Windows® 7, click  on the notification area.
- For Windows® 8, click the AI Suite 3 app from the Start Screen.

When launched, the main screen of the AI Suite 3 appears. To go to the AI Suite 3 main menu bar, click  on the top edge of the screen.



The main screen of the AI Suite 3 is for reference only and vary with models.

Main screen

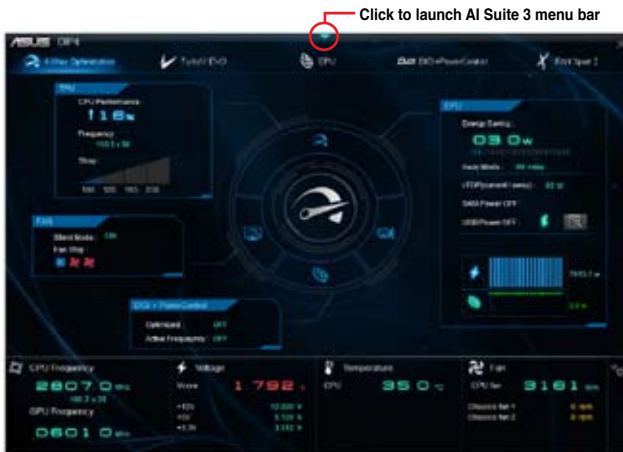

AI Suite 3 main menu bar

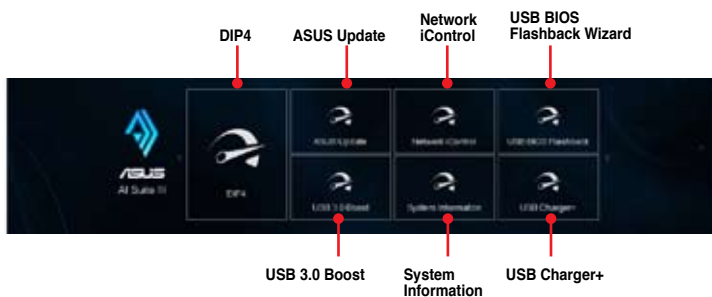

- The screenshots of AI Suite 3 in this user manual are for reference only. The actual screenshots vary with models.
- Refer to the software manual in the support DVD or visit the ASUS website at www.asus.com for detailed software configuration.

4.3.2 USB 3.0 Boost

USB 3.0 Boost technology supports UASP (USB Attached SCSI Protocol) that automatically speeds up the transfer rates of your USB storage devices.

Launching USB 3.0 Boost

To launch USB 3.0 Boost, click  on the top edge of the screen, then click **USB 3.0 Boost** on the AI Suite 3 main menu bar.

Using the USB 3.0 Boost

1. Connect a USB 3.0 device to the USB 3.0 port.
2. From the USB 3.0 Boost screen, click to select a USB device.
3. To enable UASP on your USB device, click **UASP**. To revert to its normal transfer rate, click **Normal**.

USB 3.0 Boost screen



- Refer to the software manual in the support DVD or visit the ASUS website at www.asus.com for detailed software configuration.
- Use the USB 3.0 devices for high performance. The data transfer speed varies with USB devices.

4.3.3 USB BIOS Flashback Wizard

USB BIOS Flashback Wizard allows you to check and save the latest BIOS version to a USB storage device. Use this utility to quickly check for the latest available BIOS and set a schedule to when you can download for a newer version.

USB BIOS Flashback Wizard screen



Scheduling the BIOS download

1. In the Download Setting field, tick **Schedule (days)** then select the number of days for the BIOS download schedule.
2. Click **Apply** to save the BIOS download schedule. Click **Cancel** to cancel the download schedule.

Downloading the updated BIOS





Before you start downloading, ensure that you have installed the USB storage device to your computer's USB port that supports USB BIOS Flashback. Refer to section **2.2.1 Rear I/O connection** of your user manual for more details.

To download the updated BIOS:

1. From the USB BIOS Flashback screen, click **Check for New BIOS Update** to check for the latest BIOS version.

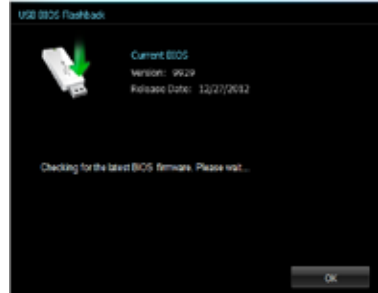
Wait for the system to check the latest BIOS version.



2. After the utility detects a new BIOS, click  from the Save to: field, select the USB flash drive, then click **Download**.

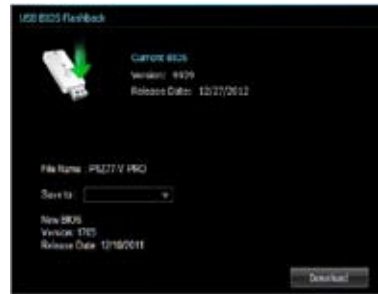

3. After the download is complete, click **OK**.



4.3.4 Network iControl

Network iControl is a one-stop setup network control center that allows you to manage your network bandwidth and set the bandwidth priority for your running programs.

Launching Network iControl

To launch Network iControl, click  on the top edge of the screen, then click **Network iControl** on the AI Suite 3 main menu bar.



- Ensure to install the LAN drivers before using this utility.
- Network iControl can only support the onboard LAN.

EZ Start screen



The screenshot shows the 'EZ Start' tab of the Network iControl interface. It features a central globe icon and a 'Start' button. Below the globe, there are sections for 'Profile Name' (set to 'Auto'), a 'Priority' dropdown menu, and a checkbox labeled 'Set the current network program as the highest priority'. A 'Apply' button is located at the bottom right. Callouts with red lines point to these elements:

- Click to activate Network iControl (points to the 'Start' button)
- Click to select a profile (points to the 'Profile Name' dropdown)
- Click to enable the network program as the highest priority (points to the 'Priority' dropdown)
- Click to apply the changes made (points to the 'Apply' button)

Quick Connection screen

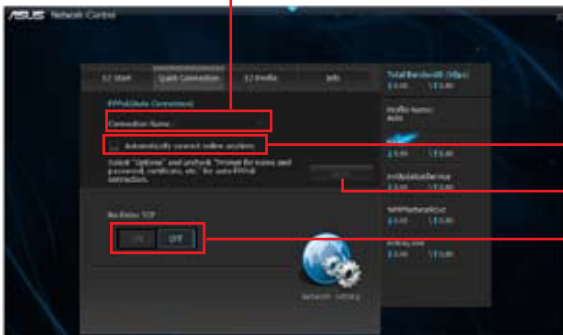

The screenshot shows the 'Quick Connection' tab of the Network iControl interface. It includes a 'Connection Name' field, a 'Connection Type' dropdown menu, a checkbox for 'Automatically connect when online', and a 'Profile VPI' dropdown menu. A 'Apply' button is at the bottom right. Callouts with red lines point to these elements:

- Click to select Connection Name (points to the 'Connection Name' field)
- Tick to set the auto PPPoE connection (points to the 'Automatically connect when online' checkbox)
- Click to apply settings (points to the 'Apply' button)
- Click ON to improve network performance (points to the 'Profile VPI' dropdown menu)

EZ Profile screen

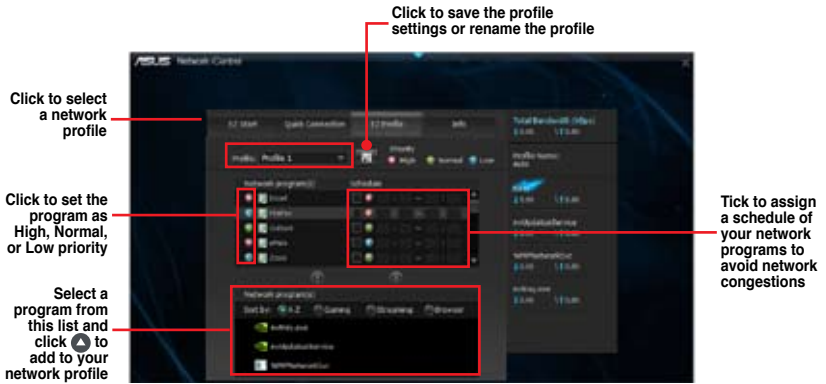

4.3.5 USB Charger+

USB Charger+ allows you to quick-charge your portable USB devices even if your computer is off, in sleep mode or hibernate mode.



The USB Charger+ will not work if the ErP-ready item in the BIOS is enabled.

Launching USB Charger+

To launch USB Charger+, click  on the top edge of the screen, then click **USB Charger+** on the AI Suite 3 main menu bar.

USB Charger+ screen



The screenshot shows the ASUS USB Charger+ utility interface. It features a central display area with the ASUS logo and a progress indicator. Below the display, there are several buttons and options. Red callout lines point to specific elements:

- Indicates that the connected USB device is in charging mode (points to the ASUS logo)
- Click to detect the connected USB device (points to a circular button)
- Click to fast-charge your USB device (points to a button with a lightning bolt icon)
- Click to stop charging your USB device (points to a button with a power icon)
- Click to apply the settings (points to a button with a checkmark icon)
- Click to discard the settings (points to a button with an 'X' icon)
- Click to select the type of USB device that you wish to charge when the system is off (points to a dropdown menu)



Ensure to connect your USB device into the USB port that supports this utility. Refer to section 2.2.1 **Rear I/O connection** of your user manual for more details.

4.3.6 System Information

This utility allows you get the detailed information of the motherboard, CPU, and memory settings.

Launching the System Information

To launch System Information, click  on the top edge of the screen, then click **System Information** on the AI Suite 3 main menu bar.

Viewing the motherboard information

From the System Information screen, click **MB** tab to view the motherboard's information.



Viewing the CPU information

From the System Information screen, click **CPU** tab to view the processor's information.



Viewing the SPD information

From the System Information screen, click **SPD** tab to view the memory's information.



4.3.7 ASUS Update

ASUS Update is a utility that allows you to manage, save, and update the motherboard BIOS in Windows® environment.

Launching ASUS Update

To launch ASUS Update, click  on the top edge of the screen, then click **ASUS Update** on the AI Suite 3 main menu bar.

Using ASUS Update

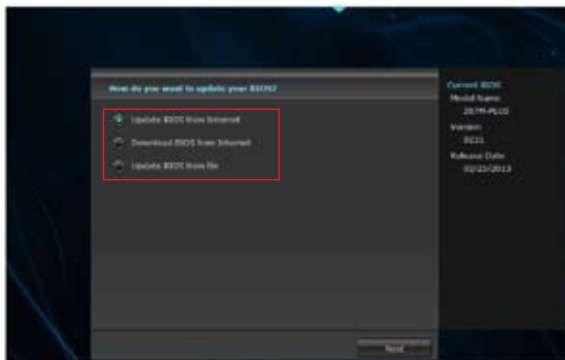

Select any of these options to update the BIOS:

- **Update BIOS from Internet**
Allows you to download the latest BIOS version from the ASUS website at www.asus.com and follow the onscreen instructions to update the BIOS.
- **Download BIOS from Internet**
Download the latest BIOS version from the ASUS website at www.asus.com and save it for later use.
- **Update BIOS from file**
Use the BIOS file that you had downloaded and saved to update the system BIOS.

4.3.8 Audio configurations

The Realtek® audio CODEC provides 8-channel audio capability to deliver the ultimate audio experience on your computer. The software provides Jack-Sensing function, S/PDIF Out support, and interrupt capability. The CODEC also includes the Realtek® proprietary UAJ® (Universal Audio Jack) technology for all audio ports, eliminating cable connection errors, and giving users plug and play convenience.

Follow the installation wizard to install the Realtek® Audio Driver from the support DVD that came with the motherboard package.

If the Realtek® audio software is correctly installed, you will find the Realtek® HD Audio Manager icon on the taskbar. Double-click on the icon to display the Realtek® HD Audio Manager.



Realtek® HD Audio Manager

Realtek® HD Audio Manager for Windows® 7/ Windows® 8



4.3.9 ASUS Boot Setting

ASUS Boot Setting utility allows you to quickly enter the BIOS setup with a click of the DirectBIOS button. It also allows you to select the system bootup process using Normal Boot or Fast Boot.



To fully support ASUS Boot Setting on your motherboard, download the latest BIOS from ASUS Support site at <http://www.asus.com> and update the BIOS to your system.



Using DirectBIOS button

This button allows you to restart your system and enters directly to BIOS Setup without having to press the key during POST.



Using the DirectBIOS function may result to data loss. We recommend to save your data before clicking this button.

To use DirectBIOS:

1. From the ASUS Boot Setting screen, click **DirectBIOS**.
2. On the confirmation message, click **OK** to restart your system and go to the BIOS setup directly.

Using Advanced setup

Advanced setup allows you to set the bootup process of your system.

There are two settings to boot up your system: **Fast Boot** and **Next boot after AC power loss**.

Enabling or disabling Fast Boot

This setting allows you to quickly boot your system.



This setting will take effect after shutting down or restarting your system normally.

To enable or disable Fast Boot:

1. Click **Advanced Setup** to show the boot setup settings.
2. In **Fast Boot**, click **Enabled**. If you want to turn off Fast Boot function, click **Disabled**.
3. On the confirmation message, click **Yes** to apply the setting.

Using Next boot after AC power loss

This setting allows you to boot your system in Fast Boot or Normal Boot under **Next boot after AC power loss**.

To use Fast Boot under AC power loss:

1. Click **Advanced Setup** to show the boot setup settings.
2. In **Fast Boot**, click **Enabled**.
3. In **Next boot after AC power loss**, click **Fast Boot**.
4. On the confirmation message, click **Yes** to apply this setting.

To use Normal Boot under AC power loss:

1. Click **Advanced Setup** to show the boot setup settings.
2. In **Next boot after AC power loss**, click **Normal Boot**.
3. On the confirmation message, click **Yes** to apply this setting.

RAID support

5

5.1 RAID configurations

The motherboard supports the following SATA RAID solutions:

- Intel® Rapid Storage Technology with RAID 0, RAID 1, RAID 10 and RAID 5 support.



If you want to install a Windows® operating system to a hard disk drive included in a RAID set, you have to create a RAID driver disk and load the RAID driver during OS installation. Refer to section **5.2 Creating a RAID driver disk** for details.

5.1.1 RAID definitions

RAID 0 (Data striping) optimizes two identical hard disk drives to read and write data in parallel, interleaved stacks. Two hard disks perform the same work as a single drive but at a sustained data transfer rate, double that of a single disk alone, thus improving data access and storage. Use of two new identical hard disk drives is required for this setup.

RAID 1 (Data mirroring) copies and maintains an identical image of data from one drive to a second drive. If one drive fails, the disk array management software directs all applications to the surviving drive as it contains a complete copy of the data in the other drive. This RAID configuration provides data protection and increases fault tolerance to the entire system. Use two new drives or use an existing drive and a new drive for this setup. The new drive must be of the same size or larger than the existing drive.

RAID 5 stripes both data and parity information across three or more hard disk drives. Among the advantages of RAID 5 configuration include better HDD performance, fault tolerance, and higher storage capacity. The RAID 5 configuration is best suited for transaction processing, relational database applications, enterprise resource planning, and other business systems. Use a minimum of three identical hard disk drives for this setup.

RAID 10 is data striping and data mirroring combined without parity (redundancy data) having to be calculated and written. With the RAID 10 configuration you get all the benefits of both RAID 0 and RAID 1 configurations. Use four new hard disk drives or use an existing drive and three new drives for this setup.

5.1.2 Installing Serial ATA hard disks

The motherboard supports Serial ATA hard disk drives. For optimal performance, install identical drives of the same model and capacity when creating a disk array.

To install the SATA hard disks for a RAID configuration:

1. Install the SATA hard disks into the drive bays.
2. Connect the SATA signal cables.
3. Connect a SATA power cable to the power connector on each drive.

5.1.3 Setting the RAID item in BIOS

You must enable the RAID function in the BIOS Setup before creating RAID sets using SATA HDDs. To do this:

1. Enter the BIOS Setup during POST.
2. Go to the **Advanced** menu > **SATA Configuration**, and then press <Enter>.
3. Set the SATA Mode item to [RAID Mode].
4. Save your changes, and then exit the BIOS Setup.



Refer to Chapter 3 for details on entering and navigating through the BIOS Setup



Due to chipset limitation, when SATA ports are set to RAID mode, all SATA ports run at RAID mode together.

5.1.4 Intel® Rapid Storage Technology Option ROM utility

To enter the Intel® Rapid Storage Technology Option ROM utility:

1. Turn on the system.
2. During POST, press <Ctrl> + <I> to display the utility main menu.

```
Intel(R) Rapid Storage Technology - Option ROM - v10.5.1.1070
Copyright(C) 2003-10 Intel Corporation. All Rights Reserved.

[ MAIN MENU ]
1. Create RAID Volume      4. Recovery Volume Options
2. Delete RAID Volume     5. Acceleration Options
3. Reset Disks to Non-RAID 6. Exit

[ DISK/VOLUME INFORMATION ]

RAID Volumes:
None defined.

Physical Devices:
Port Device Model      Serial #      Size  Type/Status (Vol ID)
0  ST3160812AS         9LS0HJA4    149.0GB Non-RAID Disk
1  ST3160812AS         9LS0F4HL    149.0GB Non-RAID Disk
2  ST3160812AS         3LS0JYL8    149.0GB Non-RAID Disk
3  ST3160812AS         9LS0B75H    149.0GB Non-RAID Disk

[↑↓]-Select      [ESC]-Exit      [ENTER]-Select Menu
```

The navigation keys at the bottom of the screen allow you to move through the menus and select the menu options.



The RAID BIOS setup screens shown in this section are for reference only and may not exactly match the items on your screen.



The utility supports maximum four hard disk drives for RAID configuration.

Creating a RAID set

To create a RAID set:

1. From the utility main menu, select **1. Create RAID Volume** and press <Enter>. The following screen appears:

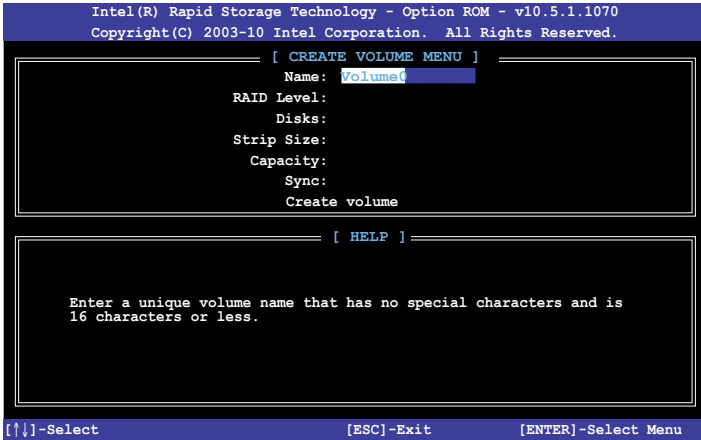

2. Enter a name for the RAID set and press <Enter>.
3. When the RAID Level item is selected, press the up/down arrow key to select a RAID level to create, and then press <Enter>.
4. When the Disks item is selected, press <Enter> to select the hard disk drives you want to include in the RAID set. The SELECT DISKS screen appears:

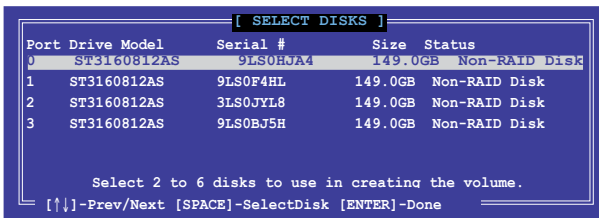

5. Use the up/down arrow key to select a drive, and then press <Space> to select. A small triangle marks the selected drive. Press <Enter> after completing your selection.
6. Use the up/down arrow key to select the stripe size for the RAID array (for RAID 0, 10 and 5 only), and then press <Enter>. The available stripe size values range from 4KB to 128KB. The following are typical values:
 - RAID 0: 128KB
 - RAID 10: 64KB
 - RAID 5: 64KB



We recommend a lower stripe size for server systems, and a higher stripe size for multimedia computer systems used mainly for audio and video editing.

7. When the **Capacity** item is selected, enter the RAID volume capacity that you want and press <Enter>. The default value indicates the maximum allowed capacity.
8. When the **Create Volume** item is selected, press <Enter>. The following warning message appears:

WARNING: ALL DATA ON SELECTED DISKS WILL BE LOST.
Are you sure you want to create this volume? (Y/N):

9. Press <Y> to create the RAID volume and return to the main menu, or <N> to go back to the CREATE VOLUME menu.

Deleting a RAID set



Be cautious when deleting a RAID set. You will lose all data on the hard disk drives when you delete a RAID set.

To delete a RAID set:

1. From the utility main menu, select **2. Delete RAID Volume** and press <Enter>. The following screen appears:

```
[ DELETE VOLUME MENU ]
Name      Level      Drives  Capacity  Status  Bootable
Volume0   RAID0 (Stripe)  2       298.0GB   Normal  Yes

[ HELP ]

Deleting a volume will reset the disks to non-RAID.

WARNING: ALL DISK DATA WILL BE DELETED.
(This does not apply to Recovery volumes)

[↑/↓]-Select      [ESC]-Previous Menu  [DEL]-Delete Volume
```

2. Use the up/down arrow key to select the RAID set you want to delete, and then press . The following warning message appears:

```
[ DELETE VOLUME VERIFICATION ]

ALL DATA IN THE VOLUME WILL BE LOST!
(This does not apply to Recovery volumes)

Are you sure you want to delete volume "Volume0"? (Y/N):
```

3. Press <Y> to delete the RAID set and return to the utility main menu, or press <N> to return to the DELETE VOLUME menu.

Exiting the Intel® Rapid Storage Technology Option ROM utility

To exit the utility:

1. From the utility main menu, select **5. Exit**, and then press <Enter>. The following warning message appears:

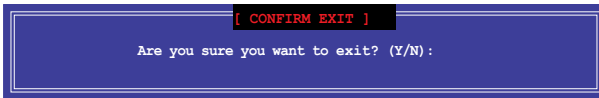

2. Press <Y> to exit or press <N> to return to the utility main menu.

5.2 Creating a RAID driver disk

A floppy disk with the RAID driver is required when installing a Windows® operating system on a hard disk drive that is included in a RAID set.



The motherboard does not provide a floppy drive connector. You have to use a USB floppy disk drive when creating a SATA RAID driver disk.

5.2.1 Creating a RAID driver disk without entering the OS

To create a RAID driver disk without entering the OS:

1. Boot your computer.
2. Press during POST to enter the BIOS setup utility.
3. Set the optical drive as the primary boot device.
4. Insert the support DVD into the optical drive.
5. Save changes and exit BIOS.
6. When the Make Disk menu appears, press <1> to create a RAID driver disk.
7. Insert a formatted floppy disk into the USB floppy disk drive, then press <Enter>.
8. Follow the succeeding screen instructions to complete the process.

5.2.2 Creating a RAID driver disk in Windows®

To create a RAID driver disk in Windows®:

1. Start Windows®.
2. Plug the USB floppy disk drive and insert a floppy disk.
3. Place the motherboard support DVD into the optical drive.
4. Go to the **AHCI/RAID Driver** tab then click **Intel AHCI/RAID Driver Path** to open the RAID driver folder.
5. Select **32bit** or **64bit** folder depending on your operating system. Copy the files of the selected folder to the root path of your USB floppy disk drive.



Write-protect the floppy disk to avoid a computer virus infection.

5.2.3 Installing the RAID driver during Windows® OS installation

To install the RAID driver for Windows® 7:

1. During the OS installation, click **Load Driver** to allow you to select the installation media containing the RAID driver.
2. Insert the USB flash drive with RAID driver into the USB port or the support DVD into the optical drive, and then click **Browse**.
3. Click the name of the device you've inserted, go to **Drivers > RAID**, and then select the RAID driver for the corresponding OS version. Click **OK**.
4. Follow the succeeding screen instructions to complete the installation.



Before loading the RAID driver from a USB flash drive, you have to use another computer to copy the RAID driver from the support DVD to the USB flash drive.

Intel® 2013 Desktop Responsiveness Technologies

This section details the overview of the installation and configuration procedures of the Intel® 2013 Desktop Responsiveness Technologies.

Intel® 2013 Desktop Responsiveness Technologies consists of three powerful technologies that helps your system boost its speed, responsiveness and overall performance.

Below are the features of Intel® 2013 Desktop Responsiveness Technologies:

- Intel® Smart Response Technology
- Intel® Rapid Start Technology
- Intel® Smart Connect Technology

System Requirements

In order for the system to run smoothly for the Intel® 2013 Desktop Responsiveness Technologies, your system must meet the following requirements.

CPU: 4th generation Intel® Core™ processor family

OS: Windows® 7 / Windows® 8 operating systems

SSD: One dedicated SSD (Solid State Disk) to support Intel® Smart Response and Intel® Rapid Start Technology.



Refer to the **SSD Capacity Requirements** table for the information of SSD size, partition capacity and system memory requirements.

HDD: At least one HDD (Hard Disk Drive) for the system OS drive.

DRAM: To enable Intel® Rapid Start Technology, 8GB or less system memory is required.



- Ensure that you use an unpartitioned SSD to enable the Intel® Smart Response Technology.
 - If you choose GPT (GUID Partition Table) store type for your operating system, ensure to reserve an unallocated space of 5MB for the Intel® Smart Response Technology.
-

SSD Capacity Requirements

| SSD Partition Capacity Requirements | | System DRAM | | |
|-------------------------------------|---|---|---|---|
| | | 2GB | 4GB | 8GB |
| Intel® storage combinations | Intel® Rapid Start | 2GB | 4GB | 8GB |
| | Intel® Smart Response | 20GB | 20GB | 20GB |
| | Intel® Smart Response and Intel® Rapid Start | Separate 20GB and 2GB partition (SSD size > 22GB) | Separate 20GB and 4GB partition (SSD size > 24GB) | Separate 20GB and 8GB partition (SSD size > 28GB) |
| | Intel® Smart Response, Intel® Rapid Start, and Intel® Smart Connect | Separate 20GB and 2GB partition (SSD size > 22GB) | Separate 20GB and 4GB partition (SSD size > 24GB) | Separate 20GB and 8GB partition (SSD size > 28GB) |



- Use the SSD only for the Intel® Rapid Start and Intel® Rapid Smart Response Technologies. DO NOT create a RAID set on the SSD.
- Due to OS behavior, Intel® Rapid Start Technology only works properly with system memory (RAM) over 4GB under 32-bit Windows® 7 OS.
- Intel® 2013 Desktop Responsiveness Technologies is supported only on your system's internal Intel® SATA ports. Ensure to connect your HDD and SDD SATA cables to the internal Intel® SATA ports.
- The performance of Intel® Smart Response Technology and Intel® Rapid Storage Technology vary with the installed SSD.
- Performance or results may vary depending on system configuration.

6.1 Intel® Smart Response Technology

Intel® Smart Response Technology helps boost your system's overall performance. It allows you to speed up data transmission and easily retrieve your recently-used applications.

Intel® Smart Response Technology uses an SSD (Solid State Drive) that performs as a cache of your hard disk drive and system memory.



- To set up the Intel® Rapid Start and Intel® Smart Response Technologies use an SSD that is not configured in RAID volume.
- Before enabling Intel® Smart Response Technology, set the SATA Mode item to **[RAID mode]** in the BIOS. Refer to section **SATA Configuration** of your user manual for more details.

Installing Intel® Smart Response Technology

To install Intel® Smart Response Technology:

1. Place the support DVD to the optical drive. If Autorun is enabled in your computer, the DVD automatically displays the installation wizard.
2. Click **Drivers** tab, then click **Intel® Rapid Storage Technology Driver software**.
3. Follow the onscreen instructions to complete the installation.



Using the Intel® Smart Response Technology

To use the Intel® Smart Response Technology:

1. On the task bar, click  to show hidden icons then click **Intel® Rapid Storage Technology** icon.
2. In Intel® Rapid Storage Technology window, click **Performance** to open Intel® Smart Response Technology settings.
3. In the middle pane of the window, click **Select device**.



4. In the **Accelerate Disk or Volume** window, you can do any of the following:
 - a. Select from the drop-down list the disk you want to use to accelerate your storage system.
 - b. Tick any of these acceleration modes:

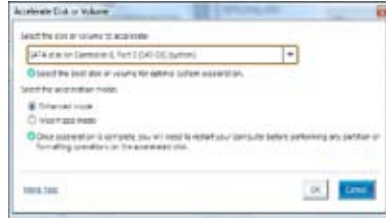

Enhanced mode: WRITE THROUGH, write to SSD and HDD at the same time.

Maximized mode: WRITE BACK, write to SSD and write back to HDD in a later time.

- c. Click **OK** to exit.

3. To change acceleration mode, click **Change Mode** then click **Yes**. To disable Intel® Smart Response Technology, click **Disable acceleration**.



- When using Intel® Smart Response Technology, you need at least one SSD (with at least 20GB of storage space) and an HDD.
- If you want to restore the OS, remove the disk/volume acceleration to disable the Intel® Smart Response Technology. Refer to section **Intel® Rapid Storage Technology Option ROM utility** of your user manual for more details.
- Ensure to restart your system after you enable or disable the Intel® Smart Response Technology for the changes to take effect.
- The maximum caching size that you can set on the SSD is 64GB. If your SSD is more than 64GB, the available space left can still be recognized by the system for normal storage.

6.2 Intel® Rapid Start Technology

Intel® Rapid Start Technology allows you to quickly resume your computer from hibernate or sleep mode. It reduces the amount of data transferred to SSD resulting in a faster or improved resume or wake up time.



- Ensure that you enable the Intel® Rapid Start Technology in BIOS before using the Intel® Rapid Start Technology. In BIOS, click **Advanced Mode > Advanced > PCH Configuration > Intel® Rapid Start Technology** then set Intel® Rapid Start Technology to [Enabled].
- Ensure to create a partition first before installing the Intel® Rapid Start Technology utility. The utility will not proceed with the installation if you have not created a partition.

Creating a partition



- Ensure to back up your data before creating a partition using the Microsoft partition tool. Incorrect partitioning results to data loss.
- The system may become unstable if DRAM is set to a high frequency.

To create a partition:

1. Launch the Computer Management window for the following Windows® operating systems:
 - a. For Windows® 7, click **Start** then right-click **Computer > Manage**.
 - b. For Window® 8, right-click on the Start screen to launch to launch All Apps bar, click **All Apps** icon then right-click **Computer > Manage**.
2. Click **Disk Management** on the left pane of Computer Management window.
3. Select the SSD that you want to partition.
4. Right-click the New Volume that you want to shrink from, then click **Shrink Volume**.

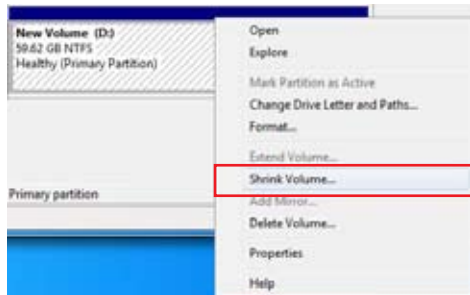

5. If your SSD is not initialized:
 - a. Right-click the disk that you to partition then select **Initialize**.
 - b. Right-click the unallocated volume then select **New Simple Volume**.
 - c. When the New Simple Wizard appears, click **Next** to proceed to a series of screens to specify volume size, assign drive path and format partition.
 - d. Click **Finish**.



If your SSD is smaller than 64GB and is set to **Full disk capacity** caching option for Intel® Smart Response, you cannot see the volume in the Disk Management window. Ensure to set your cache memory value of **18.6GB** (minimum cache size) in Intel® Smart Response to allow enough capacity for the Intel® Rapid Start partition.

6. Key in the required partition size then click **Shrink**.



The partition size must be equal to the size of your system memory (DRAM size).

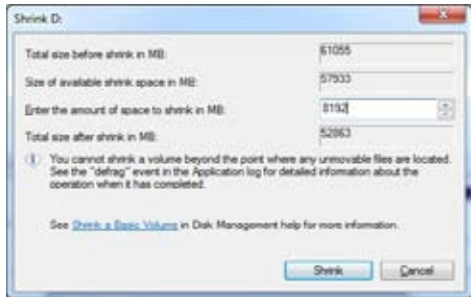

7. From your desktop, click **Start > Control Panel > System and Security > System** and check the DRAM size information. The unallocated volume is assigned to the selected disk.

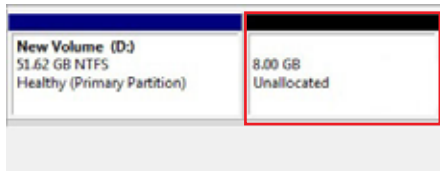

8. Launch the disk partitioning tool for the following Windows® operating systems:
 - a. For Windows® 7, click **Start > Programs > Accessories > Command Prompt**.
 - b. For Windows® 8, right click to launch All Apps bar, click **All Apps** icon then click **Command Prompt**.

9. At the command prompt C:\>, key in **diskpart** then press <Enter>.
10. From the DiskPart prompt, key in **list disk** then press <Enter>. To select a disk with unallocated volume, key in **select disk** and the disk number then press <Enter>.

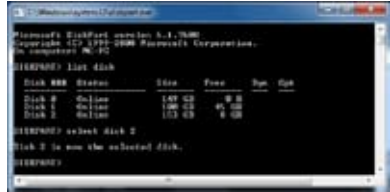

11. Key in **create partition primary** then press <Enter>.

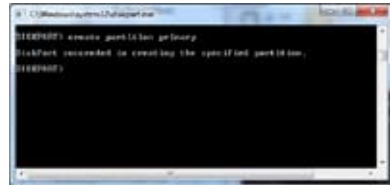

12. After creating a primary partition, key in **detail disk** then press <Enter> to view the details of the partitioned disk.



13. Select the RAW volume to store the Intel® Rapid Start partition. Key in **select volume** and the disk number then press <Enter>.



14. Key in **set id=84 override** then press <Enter>. After the shrinking process, the Disk Management utility identifies a new partition called **Hibernation Partition**.

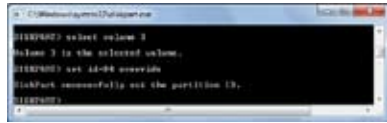

The command **set id=84 override** sets the selected volume into Hibernation Partition.



The **Hibernation Partition** does not appear when you choose GPT (GUID Partition Table) store type. Ensure the "Unallocated" label does not appear in the volume and a new partition is identified.

15. Reboot the system after creating the partition.



You need to reboot your system to ensure that the setup is completed and Intel® Rapid Start Technology will work properly.

Intel® Rapid Start Technology

The Intel® Rapid Start Technology Manager allows you to enable or disable Intel® Rapid Start Technology and set a time frame to utilize the Intel® Rapid Start Technology once the system goes to sleep mode.

Installing the Intel® Rapid Start Technology

To install Intel® Rapid Start Technology:

1. Place the support DVD into the optical drive. If Autorun is enabled in your computer, the DVD automatically displays the installation wizard.
2. From installation wizard window, click **Utilities** tab then click **Intel® Rapid Start Technology**.
3. Follow the onscreen instructions to complete the installation.
4. After the installation is completed, tick **Yes, I want to restart this computer now** then click **Finish**.

Using the Intel® Rapid Start Technology

To use Intel® Rapid Start Technology:

1. On the task bar, click  to show hidden icons then click **Intel® Rapid Start Technology** icon.

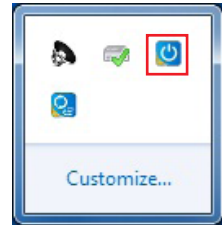

2. In the Intel® Rapid Start Technology, you may do any the following:
 - a. In Status field, click **On** to enable or click **Off** to disable Intel® Rapid Start Technology.
 - b. In Critical Battery field, this function only applies to notebooks. This function activates the notebook's battery saving mode
 - c. In Timer field, click **On** to enable the timer then move the slider to the desired time to activate Intel® Rapid Storage Technology.
3. Click **Save**.

Intel® Rapid Start Technology Manager

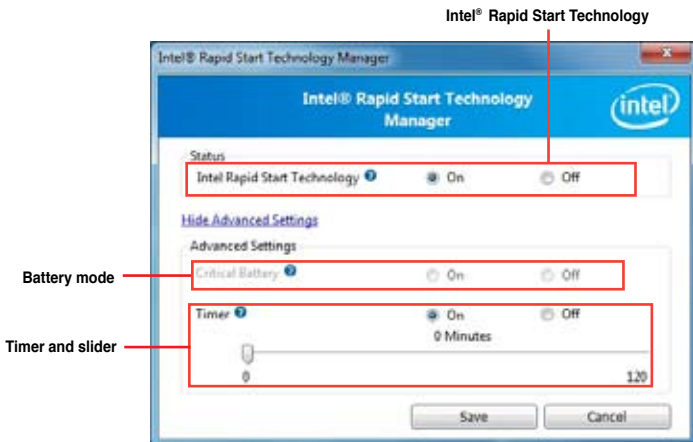

Recovering the partition

This procedure allows you to recover the partition that you made for the Intel® Rapid® Start Technology.

To recover the partition:

1. Launch the disk partitioning tool for the following Windows® operating systems:
 - a. For Windows® 7, click **Start > Programs > Accessories > Command Prompt**.
 - b. For Windows® 8, right click on the Start Screen to launch All Apps bar, click **All Apps** icon then click **Command Prompt**.

2. At the command prompt C:\>, key in **diskpart** then press <Enter>.
3. From the DiskPart prompt, key in **list disk** then press <Enter>.
4. To select the disk (SSD) where the Intel® Rapid Start Technology is installed, key in **select disk** and the disk number then press <Enter>.



5. Key in **list partition** then press <Enter>. To select the partition where the Intel® Rapid Start Technology is installed, key in **select partition** and the partition number then press <Enter>.



6. Key in **delete partition override** then press <Enter>.

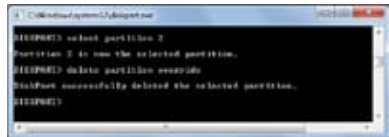

7. Launch the Computer Management window for the following Windows® operating systems:
 - a. For Windows® 7, click **Start** then right-click **Computer > Manage**.
 - b. For Window® 8, right-click on the Start screen to launch to launch All Apps bar, click **All Apps** icon then right-click **Computer > Manage**.
8. On the left side pane of the Computer Management window, click **Disk Management**.
9. Right-click the shrunk new volume then click **Extend Volume**.

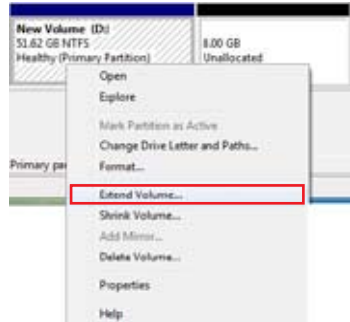

10. When the Extend Volume Wizard appears, click **Next**.



11. Click **Next** after selecting the default disk.
12. After the Extend volume setup is completed, click **Finish** to recover the Intel® Rapid Start Technology partition.
13. Restart the system after deleting the Intel® Rapid Start Technology partition.

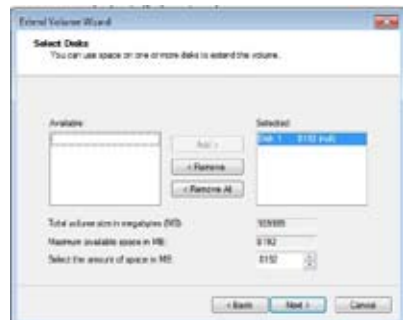

14. To remove the Intel® Rapid Start Manager from the following Windows® operating systems:
 - a. For Windows 7, click **Start > Control Panel > Programs > Programs and Features**. Click Intel® Rapid Start Technology then click **Uninstall**.
 - b. For Windows® 8, right-click on the Start screen to launch the All Apps bar, click **All Apps** icon then click **Control Panel Programs > Programs and Features**. Click Intel® Rapid Start Technology then click **Uninstall**.
15. Reboot your system.

6.3 Intel® Smart Connect Technology

Intel® Smart Connect Technology allows your system to automatically connect and update your cloud-based programs and applications by waking up your computer to a low power state. After the updates are done, your system goes back to sleep mode, thus helps reduce power consumption.



- Intel® Smart Connect Technology supports Windows® Live Mail, Microsoft Outlook and Seismic applications.
- Ensure to enable Intel® Rapid Smart Connect Technology in BIOS before installing Intel® Smart Connect Technology. To do this from the BIOS, go to **Advanced Mode > Advanced > PCH Configuration > Intel(R) Smart Connect Technology** then set ISCT Support to [Enabled].

Installing the Intel® Smart Connect Technology

To install the Intel® Smart Connect Technology:

1. Place the support DVD to the optical drive. If Autorun is enabled in your computer, the DVD automatically displays the installation wizard.
2. Click **Utilities** then click Intel® Smart Connect Technology.
3. When the setup wizard appears, click **Next** to begin the setup.
4. Tick **I accept the terms in the License Agreement** then click **Next**.
5. In Custom Setup, select all features then click **Next**.
6. Click **Install** to start the installation.
7. Click **Yes** to restart your system.



Configuring Intel® Smart Connect Technology

You need to configure the settings of Intel® Smart Connect Technology before using it for the first time.

To configure Intel® Smart Connect Technology:

1. On the task bar, click  to show hidden icons then click **Smart® Connect Technology** icon.
2. When the configuration wizard appears, click **Next** to begin the configuration.



3. Click **Enable** if you want your computer to wake up from sleep mode when updating active applications then click **Next**.



4. Slide the bar to set an update frequency then click **Next**.



5. Set the extended power settings period then click **Next**.



6. Click **Finish** to start using Intel® Smart Connect Technology.



Using the Intel® Smart Connect Technology



- Before the system goes to sleep mode, ensure to keep your applications running on the desktop and key in the passwords for applications that require authorization.
- Ensure that you are connected to the Internet when enabling the Intel® Smart Connect Technology.

1. Launch the Intel Smart Connect Technology window for the following Windows® operating systems:
 - a. For Windows® 7, click **Start > All Programs > Intel® > Intel® Smart Connect Technology**.
 - b. For Windows® 8, right-click on the Start screen to launch to launch All Apps bar, click **All Apps** icon then click **Intel® Smart Connect Technology**.
2. In the **Basic** tab, click **Enable Always Updated**. When enabled, the **Advanced** tab is available for advanced function settings.



Ensure to tick **Enable Always Updated** option to activate the slider for **Frequent Updates**, **Advanced** tab and **Reset All to Defaults** button.

3. In the **Advanced** tab, set up a schedule for extended power savings during low power usage time period.



4. To view event history and troubleshoot logs, click **Info** tab.

Multiple GPU support

7

AMD® CrossFireX™ technology

The motherboard supports the AMD® CrossFireX™ technology that allows you to install multi-graphics processing units (GPU) graphics cards. Follow the installation procedures in this section.

7.1 Requirements

- In Dual CrossFireX mode, you should have two identical CrossFireX-ready graphics cards or one CrossFireX-ready dual-GPU graphics card that are AMD® certified.
- Ensure that your graphics card driver supports the AMD® CrossFireX technology. Download the latest driver from the AMD® website (www.amd.com).
- Ensure that your power supply unit (PSU) can provide at least the minimum power required by your system. See Chapter 1 for details.



-
- We recommend that you install additional chassis fans for better thermal environment.
 - Visit the AMD® Game website (<http://game.amd.com>) for the latest certified graphics card and the supported 3D application list.
-

7.2 Before you begin

For AMD® CrossFireX to work properly, you have to uninstall all existing graphics card drivers before installing AMD® CrossFireX graphics cards to your system.

To uninstall existing graphics card drivers:

1. Close all current applications.
2. For Windows® 7, go to **Control Panel > Programs and Features**.
For Windows® 8, go to **Control Panel > Programs > Programs and Features**.
3. Select your current graphics card driver/s.
4. Select **Uninstall**.
5. Turn off your computer.

7.3 Installing AMD® CrossFireX™ graphics cards



The following pictures are for reference only. The graphics cards and the motherboard layout may vary with models, but the installation steps remain the same.

1. Prepare two CrossFireX-ready graphics cards.
2. Insert the two graphics card into the PCIEX16 slots. If your motherboard has more than two PCIEX16 slots, refer to Chapter 1 in this user manual for the locations of the PCIEX16 slots recommended for multi-graphics card installation.
3. Ensure that the cards are properly seated on the slots.
4. Align and firmly insert the CrossFireX bridge connector to the goldfingers on each graphics card. Ensure that the connector is firmly in place.

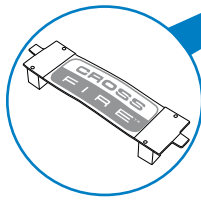
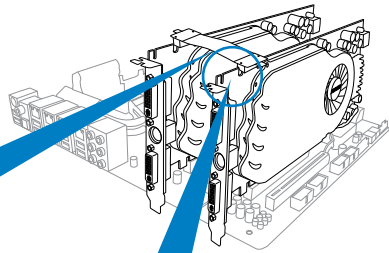
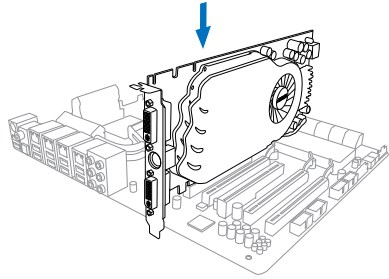

CrossFireX bridge
(bundled with
graphics cards)

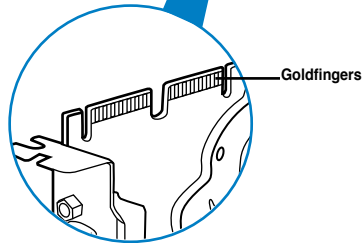

5. Connect two independent auxiliary power sources from the power supply to the two graphics cards separately.
6. Connect a VGA or a DVI cable to the graphics card.

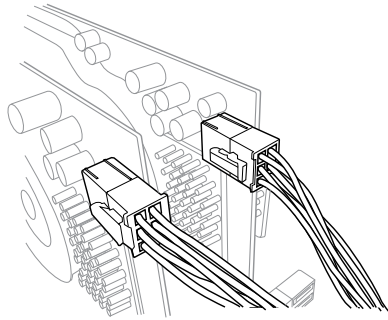

7.4 Installing the device drivers

Refer to the documentation that came with your graphics card package to install the device drivers.



Ensure that your PCI Express graphics card driver supports the AMD® CrossFireX™ technology. Download the latest driver from the AMD® website (www.amd.com).

7.5 Enabling the AMD® CrossFireX™ technology

After installing your graphics cards and the device drivers, enable the CrossFireX™ feature through the AMD® VISION Engine Control Center in Windows environment.

Launching the AMD VISION Engine Control Center

To launch the AMD® VISION Engine Control Center:

Right-click on the Windows® desktop and select **AMD VISION Engine Control Center**.



Enabling Dual CrossFireX technology

1. In the AMD VISION Engine Control Center window, click **Performance > AMD CrossFireX™**.
2. Select **Enable CrossFireX™**.
3. Select a GPU combination from the drop-down list.
4. Click **Apply** to save and activate the GPU settings made.

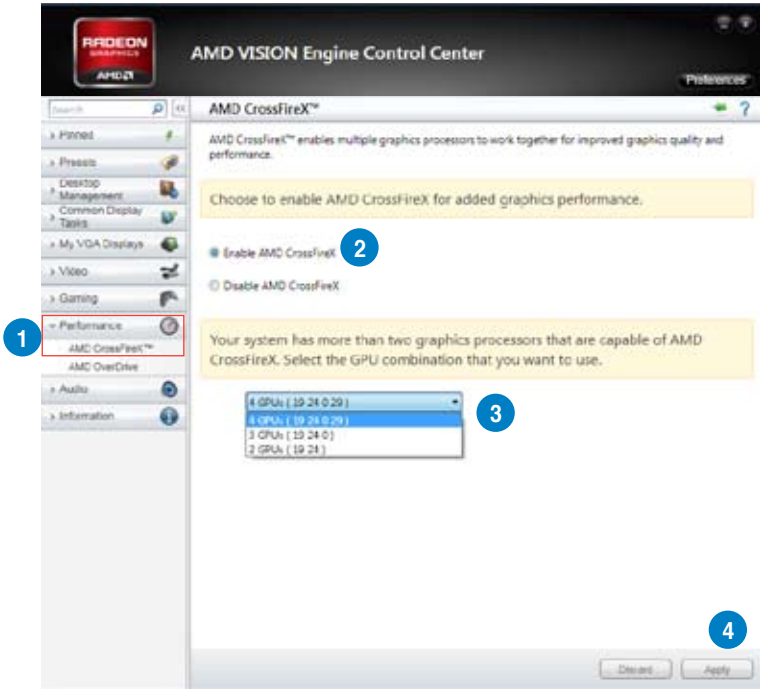

Appendices

Notices

Federal Communications Commission Statement

This device complies with Part 15 of the FCC Rules. Operation is subject to the following two conditions:

- This device may not cause harmful interference.
- This device must accept any interference received including interference that may cause undesired operation.

This equipment has been tested and found to comply with the limits for a Class B digital device, pursuant to Part 15 of the FCC Rules. These limits are designed to provide reasonable protection against harmful interference in a residential installation. This equipment generates, uses and can radiate radio frequency energy and, if not installed and used in accordance with manufacturer's instructions, may cause harmful interference to radio communications. However, there is no guarantee that interference will not occur in a particular installation. If this equipment does cause harmful interference to radio or television reception, which can be determined by turning the equipment off and on, the user is encouraged to try to correct the interference by one or more of the following measures:

- Reorient or relocate the receiving antenna.
- Increase the separation between the equipment and receiver.
- Connect the equipment to an outlet on a circuit different from that to which the receiver is connected.
- Consult the dealer or an experienced radio/TV technician for help.



The use of shielded cables for connection of the monitor to the graphics card is required to assure compliance with FCC regulations. Changes or modifications to this unit not expressly approved by the party responsible for compliance could void the user's authority to operate this equipment.

IC: Canadian Compliance Statement

Complies with the Canadian ICES-003 Class B specifications. This device complies with RSS 210 of Industry Canada. This Class B device meets all the requirements of the Canadian interference-causing equipment regulations.

This device complies with Industry Canada license exempt RSS standard(s). Operation is subject to the following two conditions: (1) this device may not cause interference, and (2) this device must accept any interference, including interference that may cause undesired operation of the device.

Cet appareil numérique de la Classe B est conforme à la norme NMB-003 du Canada. Cet appareil numérique de la Classe B respecte toutes les exigences du Règlement sur le matériel brouilleur du Canada.

Cet appareil est conforme aux normes CNR exemptes de licence d'Industrie Canada. Le fonctionnement est soumis aux deux conditions suivantes :

- (1) cet appareil ne doit pas provoquer d'interférences et
- (2) cet appareil doit accepter toute interférence, y compris celles susceptibles de provoquer un fonctionnement non souhaité de l'appareil.

Canadian Department of Communications Statement

This digital apparatus does not exceed the Class B limits for radio noise emissions from digital apparatus set out in the Radio Interference Regulations of the Canadian Department of Communications.

This class B digital apparatus complies with Canadian ICES-003.

VCCI: Japan Compliance Statement

VCCI Class B Statement

情報処理装置等電波障害自主規制について

この装置は、情報処理装置等電波障害自主規制協議会（VCCI）の基準に基づくクラスB情報技術装置です。この装置は家庭環境で使用されることを目的としています。この装置がラジオやテレビジョン受信機に近接して使用されると、受信障害を引き起こすことがあります。

取扱説明書に従って正しい取り扱いをして下さい。

KC: Korea Warning Statement

B급 기기 (가정용 방송통신기자재)

이 기기는 가정용(B급) 전자파적합기기로서 주로 가정에서 사용하는 것을 목적으로 하며, 모든 지역에서 사용할 수 있습니다.

*당해 무선설비는 전파혼신 가능성이 있으므로 인명안전과 관련된 서비스는 할 수 없습니다.

REACH

Complying with the REACH (Registration, Evaluation, Authorisation, and Restriction of Chemicals) regulatory framework, we published the chemical substances in our products at ASUS REACH website at <http://csr.asus.com/english/REACH.htm>.



DO NOT throw the motherboard in municipal waste. This product has been designed to enable proper reuse of parts and recycling. This symbol of the crossed out wheeled bin indicates that the product (electrical and electronic equipment) should not be placed in municipal waste. Check local regulations for disposal of electronic products.



DO NOT throw the mercury-containing button cell battery in municipal waste. This symbol of the crossed out wheeled bin indicates that the battery should not be placed in municipal waste.

ASUS Recycling/Takeback Services

ASUS recycling and takeback programs come from our commitment to the highest standards for protecting our environment. We believe in providing solutions for you to be able to responsibly recycle our products, batteries, other components as well as the packaging materials. Please go to <http://csr.asus.com/english/Takeback.htm> for detailed recycling information in different regions.

ASUS contact information

ASUSTeK COMPUTER INC.

Address 15 Li-Te Road, Peitou, Taipei, Taiwan 11259
Telephone +886-2-2894-3447
Fax +886-2-2890-7798
E-mail info@asus.com.tw
Web site www.asus.com.tw

Technical Support

Telephone +86-21-38429911
Online support support.asus.com

ASUS COMPUTER INTERNATIONAL (America)

Address 800 Corporate Way, Fremont, CA 94539, USA
Telephone +1-812-282-3777
Fax +1-510-608-4555
Web site usa.asus.com

Technical Support

Telephone +1-812-282-2787
Support fax +1-812-284-0883
Online support support.asus.com

ASUS COMPUTER GmbH (Germany and Austria)

Address Harkort Str. 21-23, D-40880 Ratingen, Germany
Fax +49-2102-959911
Web site www.asus.de
Online contact www.asus.de/sales

Technical Support

Telephone +49-1805-010923*
Support Fax +49-2102-9599-11
Online support support.asus.com

* EUR 0.14/minute from a German fixed landline; EUR 0.42/minute from a mobile phone.

DECLARATION OF CONFORMITY

Per FCC Part 2 Section 2.1077(a)



Responsible Party Name: Asus Computer International

Address: 800 Corporate Way, Fremont, CA 94539.

Phone/Fax No: (510)739-3777/(510)608-4555

hereby declares that the product

Product Name : Motherboard

Model Number : F2A85-V PRO

Conforms to the following specifications:

- FCC Part 15, Subpart B, Unintentional Radiators
- FCC Part 15, Subpart C, Intentional Radiators
- FCC Part 15, Subpart E, Intentional Radiators

Supplementary Information:

This device complies with part 15 of the FCC Rules. Operation is subject to the following two conditions: (1) This device may not cause harmful interference, and (2) this device must accept any interference received, including interference that may cause undesired operation.

Representative Person's Name : Steve Chang / President

Signature : *Steve Chang*
Date : Apr. 28, 2012

Ver. 110101

EC Declaration of Conformity



We, the undersigned,

Manufacturer: ASUS/ASUS COMPUTER INC
Address: 4F, No. 150, LI-TE RD., PEITOU, TAIPEI 112, TAIWAN
Country: TAIWAN
Authorized representative in Europe: ASUS COMPUTER GmbH
Address: HARKORT STR. 21-23, 40880 RATINGEN
Country: GERMANY

declare the following apparatus:

Product name: Motherboard
Model name: F2A85-V PRO

conform with the essential requirements of the following directives:

- 2009/108/EC-EMC Directive**
 - EN 55022:2010
 - EN 55024:2010
 - EN 55032:2007/A2:2008
 - EN 55033:2007/A2:2008
- 1999/5/EC-R&TTE Directive**
 - EN 300328 V1.7.1(2006-10)
 - EN 300440-1 V1.5.1(2010-08)
 - EN 300440-2 V1.5.1(2010-08)
 - EN 301511 V9.0.2(2003-03)
 - EN 301487-1 V1.3.1(2005-11)
 - EN 301487-2 V1.3.1(2005-11)
 - EN 301908-1 V5.2.1(2011-05)
 - EN 301908-2 V5.2.1(2011-05)
 - EN 301889 V1.6.1(2011-11)
 - EN 301889 V1.6.2(2011-11)
 - EN 302544-2 V1.1(2009-01)
 - EN 302544-2 V1.1(2009-01)
 - EN 300330-2 V1.7.1(2010-02)
 - EN 300330-2 V1.5.1(2010-02)
 - EN 300330-1 V1.7.1(2010-02)
 - EN 300330-1 V1.5.1(2010-02)
 - EN 550385:2002
 - EN 62311:2008
 - EN 62311:2008
- 2006/95/EC-LVD Directive**
 - EN 60950-1/A11:2009
 - EN 60950-1/A12:2011
 - EN 60950-2002/A2:2010
 - EN 60950-2002/A12:2011
- 2009/128/EC-EIP Directive**
 - Regulation (EC) No. 2786/2009

Ver. 121001



(EC conformity marking)

Position : CEO
Name : Jerry Shon

Jerry Shon

Signature : _____

Declaration Date: Dec. 10, 2012
Year to begin affixing CE marking:2012

Free Manuals Download Website

<http://myh66.com>

<http://usermanuals.us>

<http://www.somanuals.com>

<http://www.4manuals.cc>

<http://www.manual-lib.com>

<http://www.404manual.com>

<http://www.luxmanual.com>

<http://aubethermostatmanual.com>

Golf course search by state

<http://golfingnear.com>

Email search by domain

<http://emailbydomain.com>

Auto manuals search

<http://auto.somanuals.com>

TV manuals search

<http://tv.somanuals.com>