

User Guide

DSL-N12U

11N 300Mbps Wireless ADSL Modem Router



ASUS[®]
Inspiring Innovation • Persistent Perfection

E7218

Second Edition

February 2012

Copyright © 2012 ASUSTeK Computer Inc. All Rights Reserved.

No part of this manual, including the products and software described in it, may be reproduced, transmitted, transcribed, stored in a retrieval system, or translated into any language in any form or by any means, except documentation kept by the purchaser for backup purposes, without the express written permission of ASUSTeK Computer Inc. ("ASUS").

Product warranty or service will not be extended if: (1) the product is repaired, modified or altered, unless such repair, modification or alteration is authorized in writing by ASUS; or (2) the serial number of the product is defaced or missing.

ASUS PROVIDES THIS MANUAL "AS IS" WITHOUT WARRANTY OF ANY KIND, EITHER EXPRESS OR IMPLIED, INCLUDING BUT NOT LIMITED TO THE IMPLIED WARRANTIES OR CONDITIONS OF MERCHANTABILITY OR FITNESS FOR A PARTICULAR PURPOSE. IN NO EVENT SHALL ASUS, ITS DIRECTORS, OFFICERS, EMPLOYEES OR AGENTS BE LIABLE FOR ANY INDIRECT, SPECIAL, INCIDENTAL, OR CONSEQUENTIAL DAMAGES (INCLUDING DAMAGES FOR LOSS OF PROFITS, LOSS OF BUSINESS, LOSS OF USE OR DATA, INTERRUPTION OF BUSINESS AND THE LIKE), EVEN IF ASUS HAS BEEN ADVISED OF THE POSSIBILITY OF SUCH DAMAGES ARISING FROM ANY DEFECT OR ERROR IN THIS MANUAL OR PRODUCT.

SPECIFICATIONS AND INFORMATION CONTAINED IN THIS MANUAL ARE FURNISHED FOR INFORMATIONAL USE ONLY, AND ARE SUBJECT TO CHANGE AT ANY TIME WITHOUT NOTICE, AND SHOULD NOT BE CONSTRUED AS A COMMITMENT BY ASUS. ASUS ASSUMES NO RESPONSIBILITY OR LIABILITY FOR ANY ERRORS OR INACCURACIES THAT MAY APPEAR IN THIS MANUAL, INCLUDING THE PRODUCTS AND SOFTWARE DESCRIBED IN IT.

Products and corporate names appearing in this manual may or may not be registered trademarks or copyrights of their respective companies, and are used only for identification or explanation and to the owners' benefit, without intent to infringe.

Table of contents

1 A quick look	
Package contents	5
Your ADSL router	5
Mounting options	7
2 Creating your network	
Positioning your router	8
What you need	9
Connecting your devices	10
Wired connection.....	10
Before you proceed.....	11
Disable the proxy server, if enabled.....	11
Set the TCP/IP settings to automatically obtain an IP address.....	13
Disable the dial-up connection, if enabled.....	14
Setting up your ADSL router	15
3 Configuring via the web GUI	
Logging into the web GUI	18
Using Wi-Fi Protected Setup (WPS).....	20
Using the Network Map	22
Creating multiple SSID profiles	23
Managing bandwidth with EzQoS	24
Upgrading the firmware	25
Restoring/Saving/Uploading settings.....	26
4 Using the utilities	
Installing the utilities	27
To install the utilities:	27
Device Discovery	29

Table of contents

Firmware Restoration	30
ADSL Setting Wizard.....	31
Setting up your network printer	38
5 Troubleshooting	
Troubleshooting	42
ASUS DDNS Service	45
Frequently Asked Questions (FAQs)	45
Appendices	
Notices.....	47
ASUS Contact information	57
Networks Global Hotline Information.....	58

1 A quick look

Package contents

- ☑ DSL-N12U
- ☑ Power adapter
- ☑ Support CD (User Manual/utilities)
- ☑ RJ-45 cable
- ☑ RJ-11 cable
- ☑ Quick Start Guide
- ☑ Warranty card



NOTES:

- If any of the items is damaged or missing, contact ASUS for technical inquiries and support. Refer to the ASUS Support Hotline list at the back of this user manual.
- Keep the original packaging material in case you would need future warranty services such as repair or replacement.

Your ADSL router

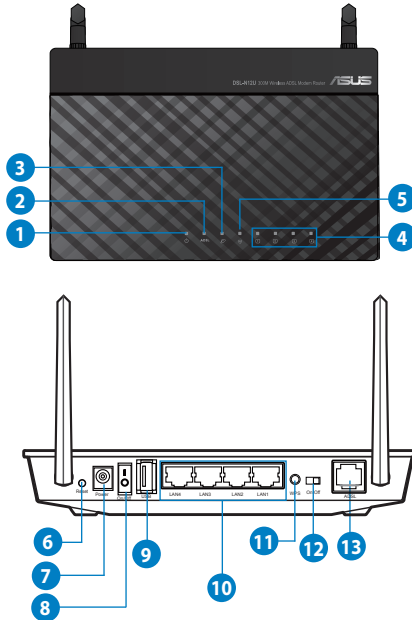

-
- 1 Power LED**
Off: No power.
On: Device is ready.
Flashing slow: Rescue mode
Flashing quick: WPS is processing.
-
- 2 ADSL LED**
Solid light: ADSL link is established.
Flashing: No ADSL link or unable to establish ADSL link.
-
- 3 WAN LED**
Off: No power or no physical connection.
On: Has physical connection to a wide area network (WAN).
-
- 4 LAN LED**
Off: No power or no physical connection.
On: Has physical connection to a local area network (LAN).
-
- 5 Wi-Fi LED**
Off: No Wi-Fi signal.
On: Wireless system is ready.
Flashing: Transmitting or receiving data via wireless connection.
-
- 6 Reset button**
This button resets or restores the system to its factory default settings.
-
- 7 Power (DC-In) port**
Insert the bundled AC adapter into this port and connect your router to a power source.
-
- 8 Power switch**
Press this button to turn the power on/off.
-
- 9 USB 2.0 / USB 1.1 port**
Insert a USB 2.0/USB 1.1 device such as USB hard disks or USB flash drives into this port.
Insert your iPad's USB cable into this port to charge your iPad.
Insert your printer's USB cable into one of these ports to set up your network printer. For details, refer to the section **Setting up your network printer**.
-
- 10 LAN 1 ~ 4 ports**
Connect network cables into these ports to establish LAN connection.
-
- 11 WPS button**
This button launches the WPS Push Button Configuration process.
-
- 12 Wi-Fi switch**
Switch to turn the WiFi feature on/off.
-
- 13 ADSL port**
Connect to a splitter or to a telephone outlet via an RJ-11 cable.
-



NOTES:

- Use only the adapter that came with your package. Using other adapters may damage the device.
- **Specifications:**

DC Power adapter	DC Input: +19V with max 1.58A current		
Operating Temperature	0~40°C	Storage	0~70°C
Operating Humidity	50~90%	Storage	20~90%

Mounting options

Out of the box, the ASUS ADSL router is designed to sit on a raised flat surface like a file cabinet or book shelf. The unit may also be converted for mounting to a wall or ceiling.

To mount the ASUS ADSL router:

1. Look on the underside of the two mounting hooks.
2. Mark two upper holes in a flat surface.
3. Tighten two ST3.5*40 screws until only 1/4" is showing.
4. Latch the hooks of your ADSL router onto the ST3.5*40 screws.

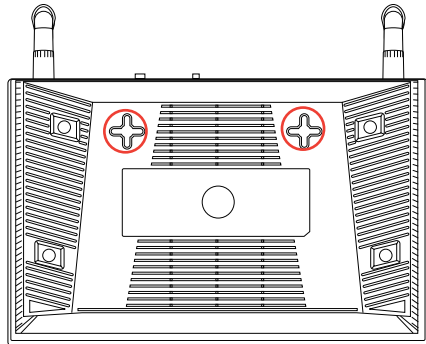

NOTE: Re-adjust the ST3.5*40 screws if you cannot latch DSL-N12U onto the ST3.5*40 screws or if it is too loose.

2 Creating your network

Positioning your router

For the best wireless signal transmission between the ADSL router and the network devices connected to it, ensure that you:

- Place the ADSL router in a centralized area for a maximum wireless coverage for the network devices.
- Keep the device away from metal obstructions and away from direct sunlight.
- Keep the device away from 802.11g or 20MHz only Wi-Fi devices, 2.4GHz computer peripherals, Bluetooth devices, cordless phones, transformers, heavy-duty motors, fluorescent lights, microwave ovens, refrigerators, and other industrial equipment to prevent signal interference or loss.
- Always update to the latest firmware. Visit the ASUS website at <http://www.asus.com> to get the latest firmware updates.
- To ensure the best wireless signal, orient the two antennas as shown in the drawing below.



What you need

To set up your network, you need one or two computers that meet the following system requirements:

- Ethernet RJ-45 (LAN) port (10Base-T/100Base-TX)
- IEEE 802.11b/g/n wireless capability
- An installed TCP/IP service
- Web browser such as Internet Explorer, Firefox, Safari, or Google Chrome



NOTES:

- If your computer does not have built-in wireless capabilities, you may install an IEEE 802.11b/g/n WLAN adapter to your computer to connect to the network.
 - The Ethernet RJ-45 cables that will be used to connect the network devices should not exceed 100 meters.
-

Connecting your devices



IMPORTANT!

- Use wired connection in setting up your ADSL router to avoid possible setup problems due to wireless uncertainty.
- Before setting up your DSL-N12U, do the following:
 - Disconnect the cables/wires from your existing modem setup. If your modem has a backup battery, remove it as well.
 - Reboot your computer (recommended).

Wired connection

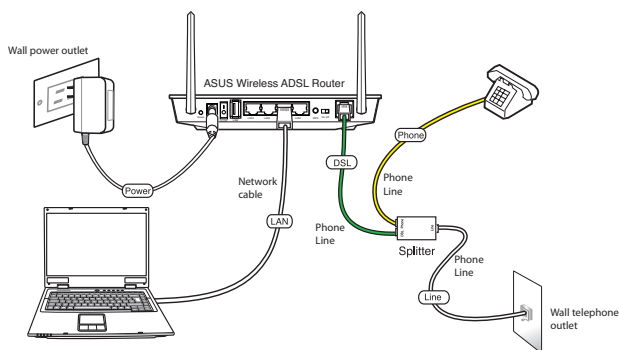

To set up your ADSL router via wired connection:

1. Insert the splitter's line connector to the phone outlet and connect your phone into the phone port.
2. Using the bundled phone cable, connect your DSL-N12U's ADSL port to the splitter's DSL port.
3. Using the bundled network cable, connect your computer to the ADSL router's LAN port.

Before you proceed



NOTE: Before configuring your DSL-N12U, do the steps described in this section for your host computer and network clients.

Disable the proxy server, if enabled.

Windows® 7

1. Click **Start > Internet Explorer** to launch the browser.
2. Click **Tools > Internet options > Connections tab > LAN settings.**
3. From the Local Area Network (LAN) Settings screen, untick **Use a proxy server for your LAN.**
4. Click **OK** when done.

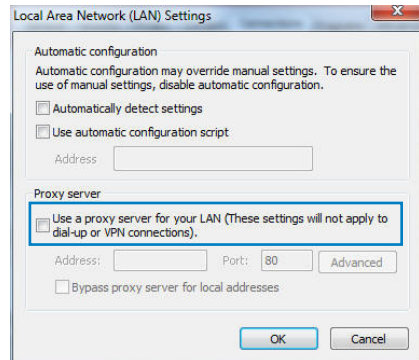
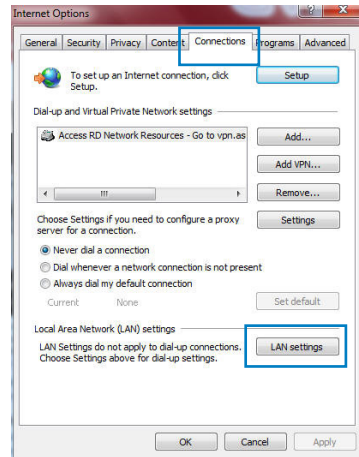

MAC OS

1. From your Safari browser, click **Safari > Preferences > Advanced > Change Settings...**
2. From the Network screen, deselect **FTP Proxy** and **Web Proxy (HTTP)**.
3. Click **Apply Now** when done.

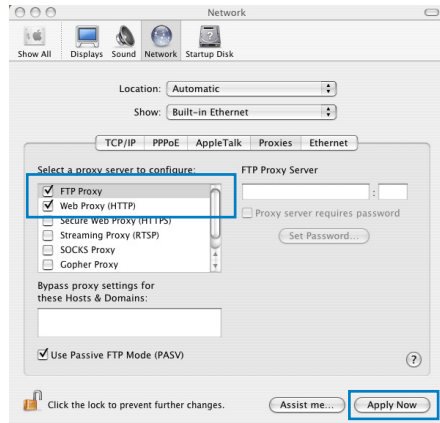

NOTE: Refer to your browser's help feature for details on disabling the proxy server.

Set the TCP/IP settings to automatically obtain an IP address.

Windows® 7

1. Click **Start > Control Panel > Network and Internet > Network and Sharing Center > Manage network connections.**
2. Select **Internet Protocol Version 4 (TCP/IPv4)** or **Internet Protocol Version 6 (TCP/IPv6)**, then click **Properties.**

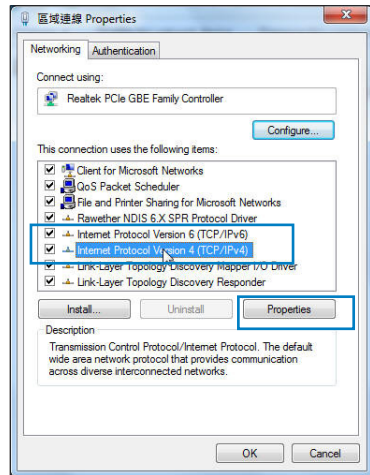

3. To obtain the IPv4 IP settings automatically, tick **Obtain an IP address automatically.**

To obtain the IPv6 IP settings automatically, tick **Obtain an IPv6 address automatically.**

4. Click **OK** when done.

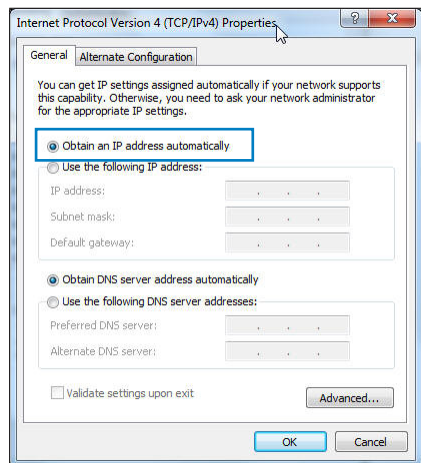

MAC OS

1. Click the Apple icon  located on the top left of your screen.
2. Click **System Preferences > Network > Configure...**
3. From the **TCP/IP** tab, select **Using DHCP** in the **Configure IPv4** dropdown list.
4. Click **Apply Now** when done.

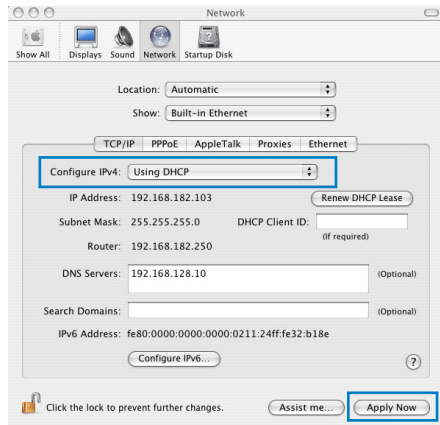

NOTE: Refer to your operating system's help and support feature for details on configuring your computer's TCP/IP settings.

Disable the dial-up connection, if enabled.

Windows® 7

1. Click **Start > Internet Explorer** to launch the browser.
2. Click **Tools > Internet options > Connections** tab.
3. Tick **Never dial a connection**.
4. Click **OK** when done.

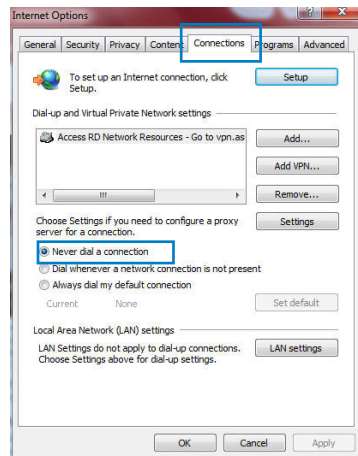

NOTE: Refer to your browser's help feature for details on disabling the dial-up connection.

Setting up your ADSL router

1. Before starting ADSL setting procedure, ensure that the ADSL indicator on DSL-N12U front panel becomes solid.

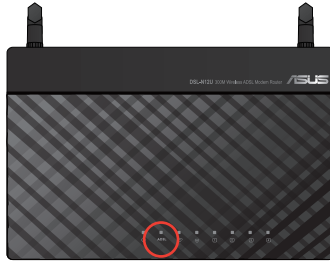

2. Launch your web browser. The QIS web page appears automatically and starts detecting your connection type, VPI/VCI value and encapsulation mode.



NOTE: If the QIS web page does not appear after you launched your web browser, disable the proxy settings on your web browser.

3. Key in the user name and password. Click **Apply**.

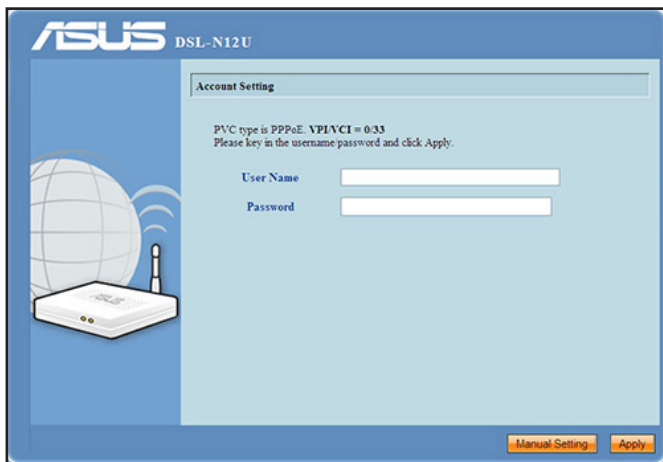

If the QIS cannot detect your Internet connection type, click **Manual Setting** and set up the Internet connection manually.



NOTES:

- The PPPoE Internet connection type is used in this setup case. The setup screen varies with different Internet connection types.
 - Obtain the required information such as the user name and password from your Internet Service Provider (ISP).
-

4. The Internet connection setup is completed.

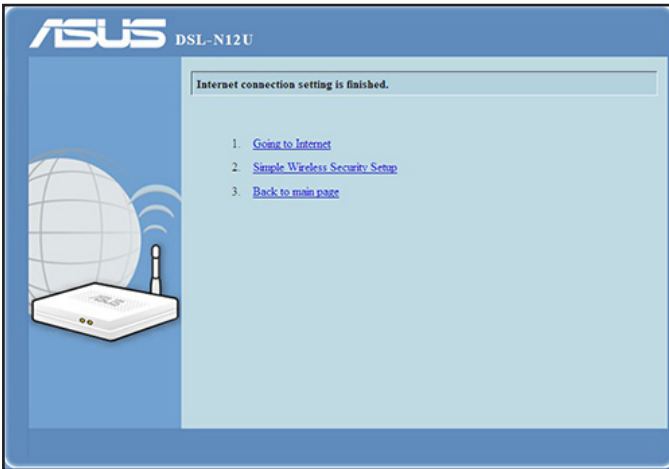

- Click **Going to Internet** to surf the Internet.
- Click **Simple Wireless Security Setup** to configure the basic security settings including the SSID, authentication, and encryption methods for the ADSL router. (Recommended)

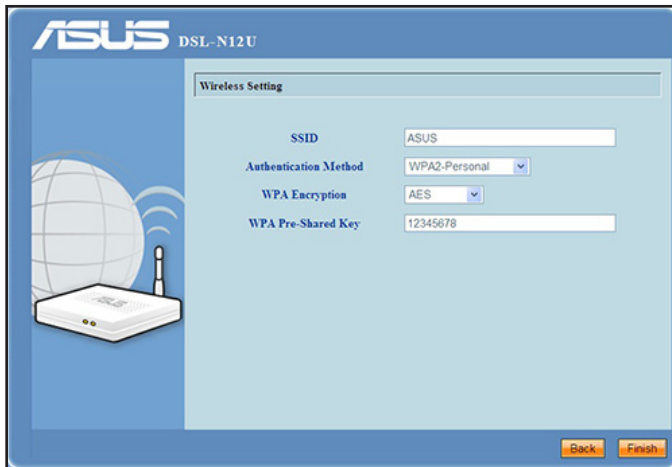

- Click **Back to main page** to go back to the main page of the web GUI.

3 Configuring via the web GUI

Logging into the web GUI

Your ASUS ADSL router comes with an intuitive web graphics user interface (GUI) that allows you to easily configure its various features through a web browser such as Internet Explorer, Firefox, Safari, or Google Chrome.

To log into the web GUI:

1. On your web browser such as Internet Explorer, Firefox, Safari, or Google Chrome, manually key in the ADSL router's default IP address: **192.168.1.1**

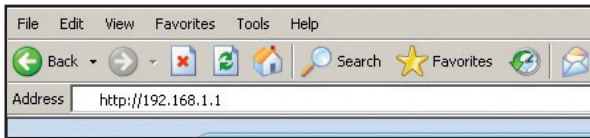

2. On the login page, key in the default user name (**admin**) and password (**admin**).

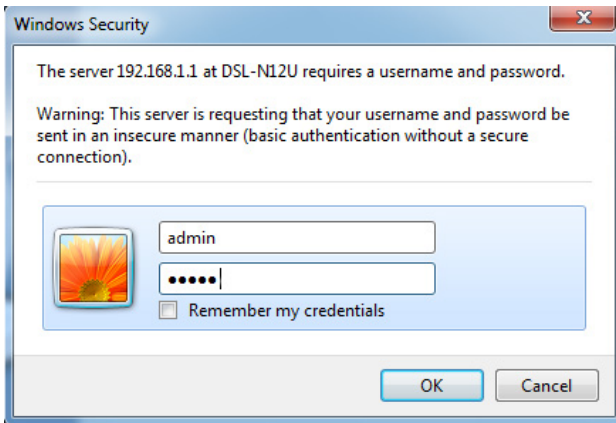



NOTES:

- For your network clients, ensure that you set the TCP/IP settings to obtain IP addresses automatically, disable the proxy server settings, disable the dial-up settings, and cancel the dial-up connection.
- For more details, refer to the section **Before you proceed** in this user manual.

3. The ADSL router's web GUI launches. Use the web GUI to configure various settings.



Using Wi-Fi Protected Setup (WPS)

WPS (Wi-Fi Protected Setup) allows you to set up a secure and protected wireless network easily



NOTES:

- Ensure that you use a wireless LAN adapter with WPS function on your network clients.
- Windows® operating systems and wireless LAN cards/adapters that support WPS:

OS Support	Wireless Adapter Support
Windows Vista 32/64 Windows 7 32/64 Windows 2008	ASUS/Intel wireless LAN card (except WL-167g and WL-160W) ASUS WL-167g v2 driver v.3.0.6.0 or later ASUS WL-160N/WL-130N driver v.2.0.0.0 or later
Windows XP SP2/SP3 Windows 2003 32-bit SP2/SP3	ASUS/Intel wireless LAN card (WL-167g and WL-160W not supported) ASUS WL-167g v2 driver v.1.2.2.0 or later ASUS WL-160N/WL-130N driver v.1.0.4.0 or later
Windows XP/2003 64-bit Windows XP 32-bit SP1/ XP 32-bit Windows 2003 32-bit SP1 / 2003 32-bit Windows 2000 SP4	ASUS wireless LAN card with ASUS WLAN Utility ASUS WL-167g v2 driver v.1.2.2.0 or later ASUS WL-160N/WL-130N driver v.1.0.4.0 or later

To use WPS:

1. In the WPS field, click the red button to launch the WPS Push Button Configuration.

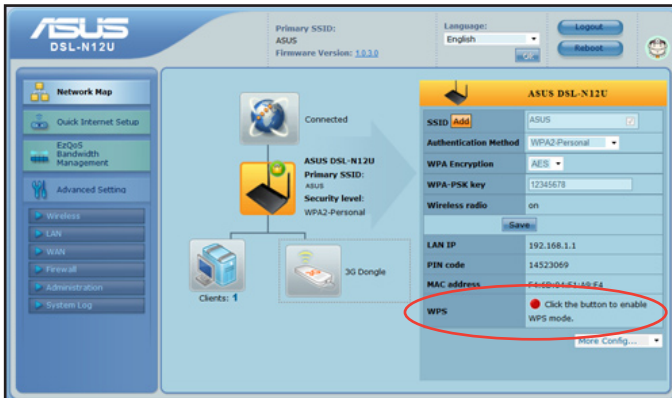

NOTE: You may also press the WPS button on your ADSL router to launch the WPS Push Button Configuration.

2. Follow the onscreen instructions to complete the wireless network setup.







IMPORTANT! Obtain the necessary information about your Internet connection type from your ISP.

Using the Network Map

Network Map allows you to view the status and configure the connection settings of the Internet, system, and clients in your network. It enables you to quickly set up your Wide Area Network (WAN) using the Quick Internet Setup (QIS) feature.

To view the status or configure the settings, click any of these icons displayed on the main page:

Icon	Description
	Internet status Click this icon to display information on the Internet connection status, WAN IP address, DNS, connection type, and gateway address. From the Internet status screen, use the Quick Internet Setup (QIS) feature to quickly set up your WAN.
	System status Click this icon to display information on the SSID, authentication and encryption methods, LAN IP, or MAC address. Enable the WPS mode from the System status screen.
	Client status Click this icon to display information about the clients or computers in the network, and allows you to block/unblock a client.
	USB printer status Click this icon to display information about the USB printer connected to the modem router.

Creating multiple SSID profiles

The wireless router allows you to create multiple SSID profiles that meet various working scenarios.

To create an SSID profile:

1. In the **SSID** field, click **Add**.

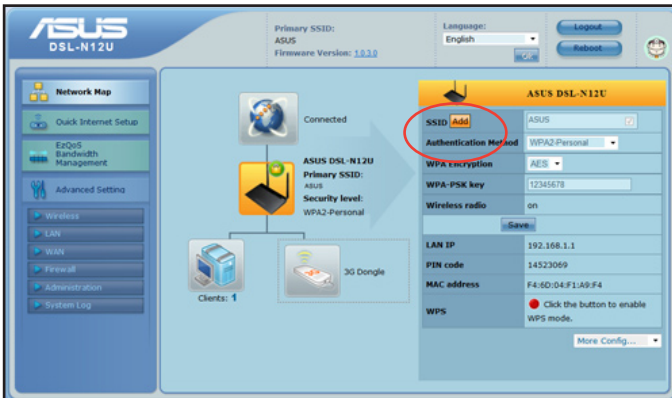

2. Configure the profile settings, then click **Add**.

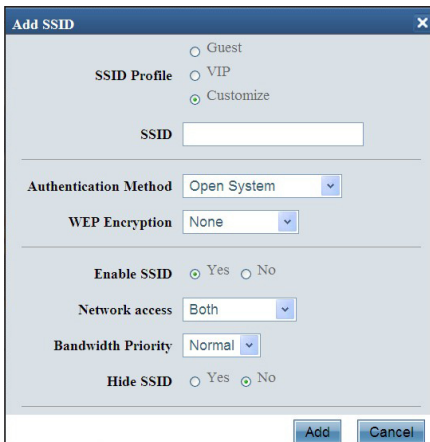
The image shows a 'Add SSID' dialog box with the following fields and options:

- SSID Profile:** Radio buttons for Guest, VIP, and Customizable (selected).
- SSID:** A text input field.
- Authentication Method:** A dropdown menu set to 'Open System'.
- WEP Encryption:** A dropdown menu set to 'None'.
- Enable SSID:** Radio buttons for Yes (selected) and No.
- Network access:** A dropdown menu set to 'Both'.
- Bandwidth Priority:** A dropdown menu set to 'Normal'.
- Hide SSID:** Radio buttons for Yes and No (selected).
- Buttons for 'Add' and 'Cancel' at the bottom.

Managing bandwidth with EzQoS

EzQoS Bandwidth Management enables you to set the bandwidth priority and manage the network traffic.



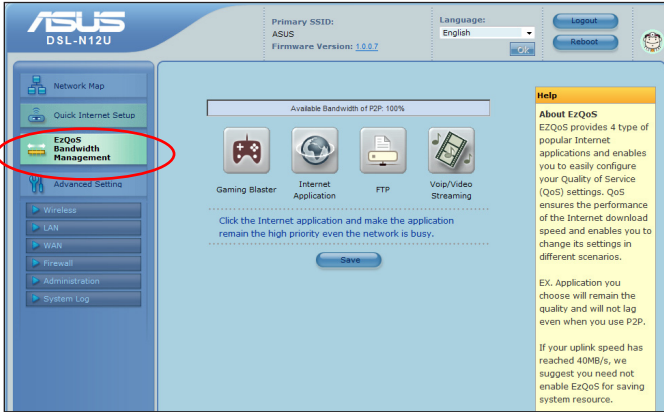

To set up the bandwidth priority:

1. Click **EzQoS Bandwidth Management** from the navigation



menu at the left side of your screen.

2. Click each of these four applications to set the bandwidth priority:

Icon	Description
	Gaming Blaster The router handles gaming traffic at first priority.
	Internet Application The router handles the e-mail, web browsing and other Internet applications traffic at first priority.
	FTP The router handles at first priority the traffic of downloading/ uploading data to/from the FTP server.
	Voip/Video Streaming The router handles the audio/video traffic at first priority.

3. Click **Save** to save the configuration settings.

Upgrading the firmware



NOTE: Download the latest firmware from the ASUS website at <http://www.asus.com>.

To upgrade the firmware:

1. Click **Advanced Setting** > **Administration** from the navigation menu at the left side of your screen.

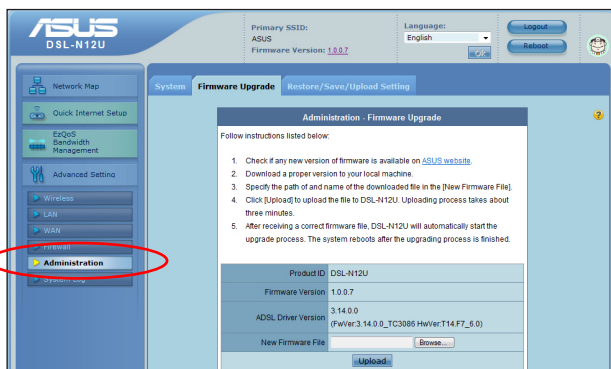

2. Click the **Firmware Upgrade** tab.
3. In the **New Firmware File** field, click **Browse** to locate the new firmware on your computer.
4. Click **Upload**. The uploading process takes about three minutes.



NOTE: If the upgrade process fails, use the Firmware Restoration utility to restore the system. For details on this utility, refer to the section **Firmware Restoration** in Chapter 5 of this user manual.

Restoring/Saving/Uploading settings

To restore/save/upload the settings:

1. Click **Advanced Setting** from the navigation menu at the left side of your screen.
2. Click the **Restore/Save/Upload Setting** tab.

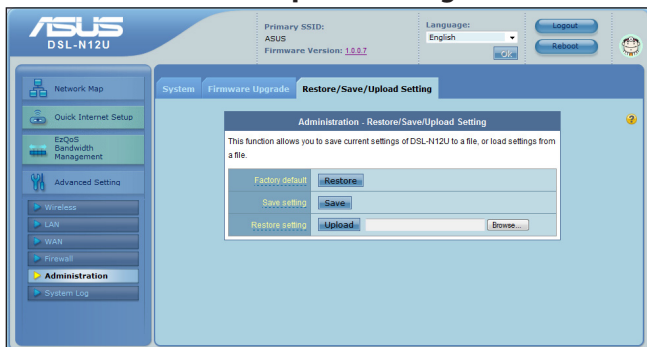

3. Select the tasks that you want to do:
 - To restore to the default factory settings, click **Restore**, and click **OK** in the confirmation message.
 - To save the current system settings, click **Save**, and click **Save** in the file download window to save the system file in your preferred path.
 - To restore previous system settings, click **Browse** to locate the system file that you want to restore, then click **Upload**.

For more information about Advanced Setting, click the hyperlinked text. The help information displayed on the right column guides you in using the router's functions.

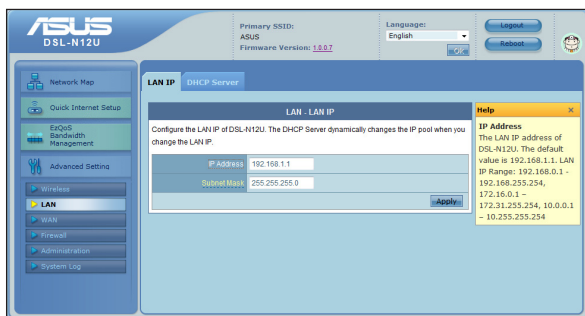

4 Using the utilities



NOTES:

- Install the ADSL router's utilities from the bundled support CD.
- If Autorun is disabled, run **setup.exe** from the root directory of the support CD.

Installing the utilities

To install the utilities:

1. Click **Install...Utilities.**

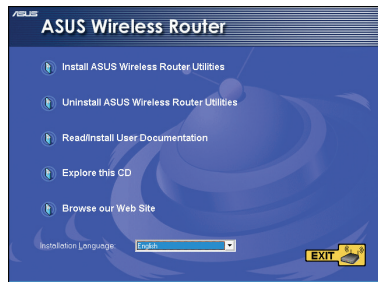

2. Click **Next.**

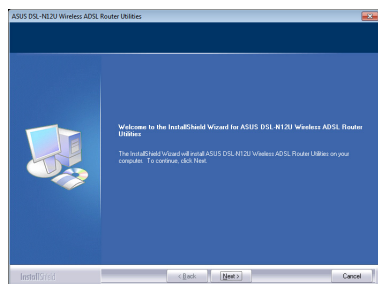

3. Click **Next** to accept the default destination folder or click **Browse** to specify another path.

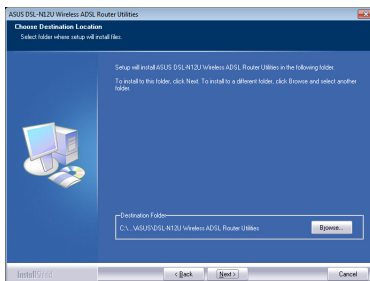

4. Click **Next** to accept the default program folder or enter another name.

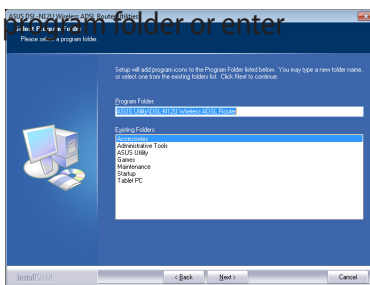

5. Click **Finish** when setup is completed.

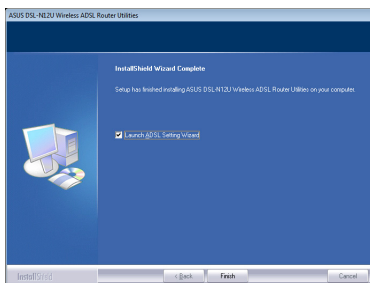

Device Discovery

Device Discovery is an ASUS WLAN utility that detects an ASUS Wireless ADSL Router and enables you to configure the device.

To launch the Device Discovery utility:

- From your computer's desktop, click **Start > All Programs > ASUS Utility > DSL-N12U Wireless ADSL Router > Device Discovery**.

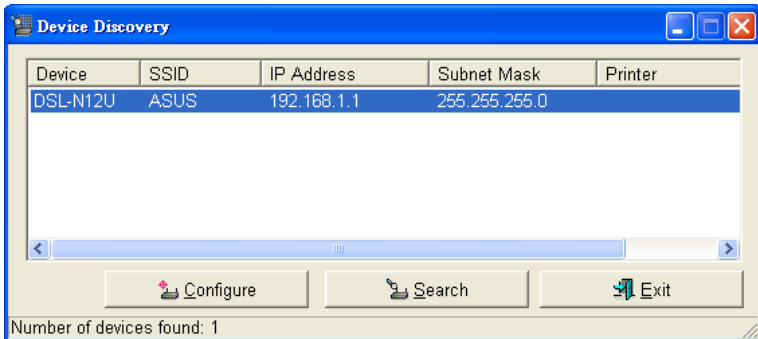

- Click **Configure** to access the web GUI and configure the wireless router.
- Click **Search** to search for ASUS wireless routers within range.
- Click **Exit** to exit the application.

Firmware Restoration

Firmware Restoration is used on an ASUS ADSL router that failed during its firmware upgrading process. It uploads the firmware that you specify. The process takes about three to four minutes.



IMPORTANT: Launch the rescue mode before using the Firmware Restoration utility.

To launch the rescue mode and use the Firmware Restoration utility:

1. Unplug the ADSL router from the power source.
2. Hold the Reset button at the rear panel and simultaneously re-plug the ADSL router into the power source. Release the Reset button when the Power LED at the front panel flashes slowly, which indicates that the ADSL router is in the rescue mode.

3. Use the following to set up your TCP/IP settings:

IP address: 192.168.1.x

Subnet mask: 255.255.255.0

4. From your computer's desktop, click **Start > All Programs > ASUS Utility > DSL-N12U ADSL router > Firmware Restoration.**

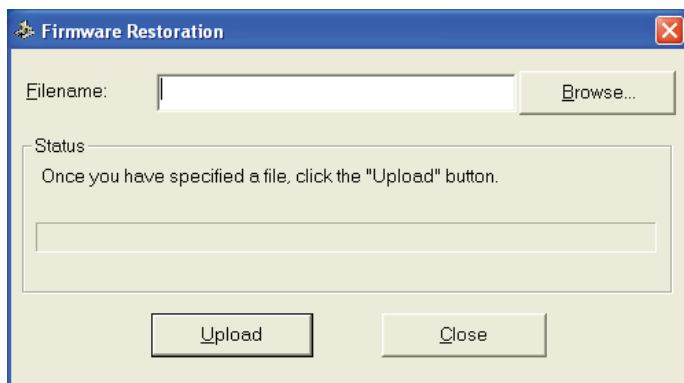

5. Specify a firmware file, then click **Upload**.



NOTE: This is not a firmware upgrade utility and cannot be used on a working ASUS ADSL router. Normal firmware upgrades must be done through the web interface. Refer to **Chapter 3: Configuring via the web GUI** for more details.

ADSL Setting Wizard

ADSL Setting Wizard helps you to set up your ADSL settings and establish a secure wireless network.

To use the ADSL Setup Wizard:

1. From your computer's desktop, click **Start > All Programs > ASUS Utility > DSL-N12U ADSL router > ADSL Setting Wizard**.
2. Follow the onscreen instructions to set up your hardware. When done, click **Next**.

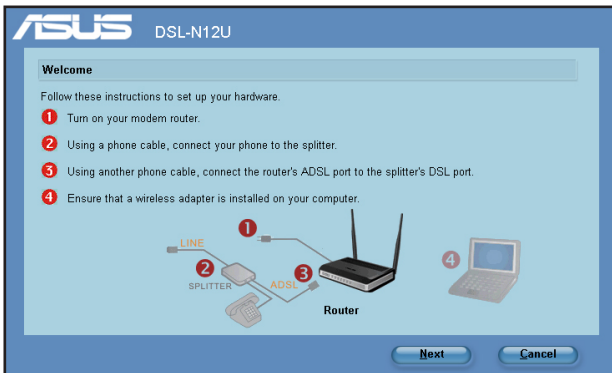

NOTE: Use the ADSL Setting Wizard with one wireless client at a time. If the wireless client cannot discover the wireless router, shorten the distance between the client and the router.

2. Press the WPS button on your router until the Power indicator flashes three times per second. (Use only with a wireless client card with WPS function)

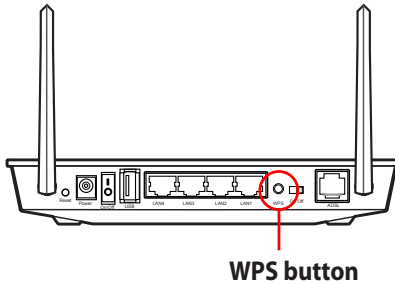

3. On the ADSL Setting Wizard, click **Next** to continue.



NOTES:

- When running WPS, the Internet connection pauses briefly then reestablishes the connection.
- If the WPS button is pushed without running the ADSL Setting Wizard, the Power LED indicator flashes and Internet connection pauses briefly and then reestablishes the connection.

4. Key in desired network name or SSID (service set identifier). When done, click **Next**.

The screenshot shows the 'ASUS DSL-N12U' configuration interface. The main heading is 'Assign a name for your network'. Below it, a text box contains 'ASUS_JUNDA_TMA ASUS' with a blue selection highlight. To the right is a 'Help' box with a yellow question mark icon, containing text about SSID. At the bottom are 'Next' and 'Cancel' buttons.

ASUS DSL-N12U

Assign a name for your network

Choose a name that people who connect to your network will recognize.

Network Name (SSID):

ASUS_JUNDA_TMA ASUS

You can type up to 32 letters or numbers.

Help

SSID is a string used to identify a wireless LAN. Use the automatically generated string as your SSID or assign the SSID manually.

Next **Cancel**

5. Create and key in a passphrase consisting of 8-63 characters or use the automatically generated passphrase then click **Next**.

A passphrase is a sentence, phrase, or sequence of alphanumeric characters used to generate a security key.

The screenshot shows the 'ASUS DSL-N12U' configuration interface. The main heading is 'Make your network more secure with a passphrase'. Below it, a text box contains the automatically generated passphrase '62E68JRYM7AUEP6R20IY' with a blue selection highlight. To the right is a 'Help' box with a yellow question mark icon, containing text about security keys. At the bottom are 'Back', 'Next', and 'Cancel' buttons.

ASUS DSL-N12U

Make your network more secure with a passphrase

WPS will use the passphrase provided below to generate a WPA2 security key for you.

Passphrase:

62E68JRYM7AUEP6R20IY

The passphrase must be between 8 and 63 characters or between 8 and 64 hex characters using digits 0-9 and letters A-F.

Display characters

▶ **Create a different passphrase for me**

▶ **Show advanced network security options**

Help

A security key prevents unauthorized access to your wireless network. Use the automatically generated string as your passphrase or assign the passphrase manually.

Back **Next** **Cancel**

6. When finished, click **Save or print settings** for future reference or **Save settings to a USB flash drive** to add other devices to the network. Click **Next** to connect to the Internet.

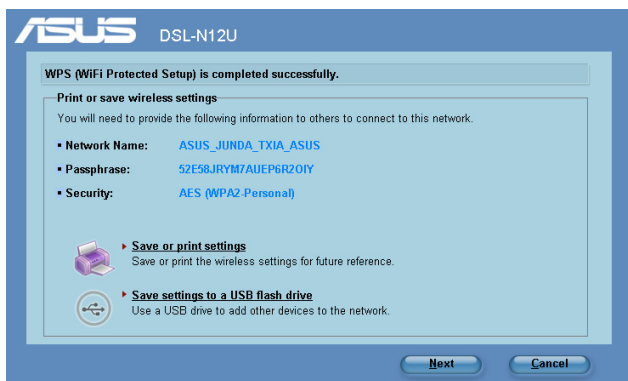

NOTE: For more details on adding devices to the network using a USB flash drive, refer to the section **Adding network devices using a USB flash drive** on the next page.

7. You have connected to the wireless router. If you want to configure the Internet (WAN) settings, click **Quick Internet Setup**.

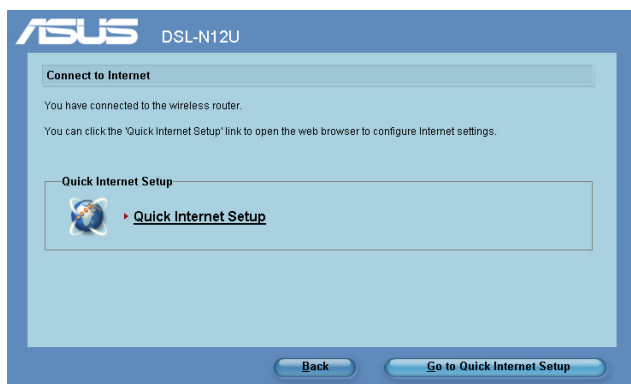

8. For Internet (WAN) settings, refer to section **Using the Quick Internet Setup (QIS)** in Chapter 2 of this manual.

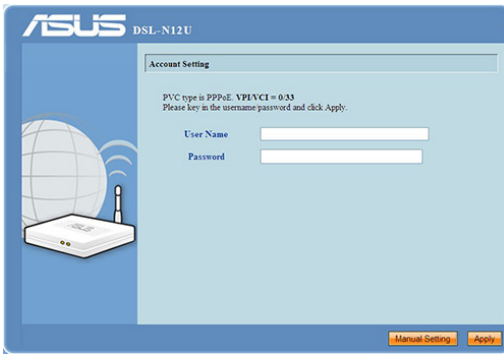

If you are a Russian user, follow the onscreen instructions to finish the ADSL Internet (WAN) settings.

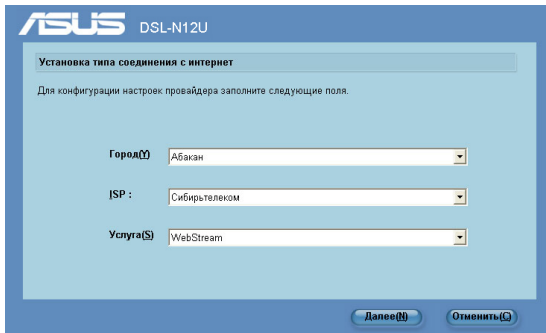

Adding network devices using a USB flash drive

With the ADSL Setting Wizard, you can add devices to your network using a USB flash drive.

To add network devices using a USB flash drive:

1. In the ADSL Setting Wizard, click **Save settings to a USB flash drive**.

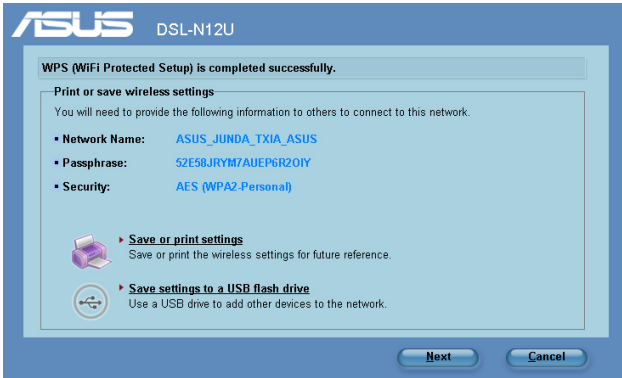

2. Insert a USB flash drive into your computer's USB port, then select the drive from the dropdown list. When done, click **Next**.

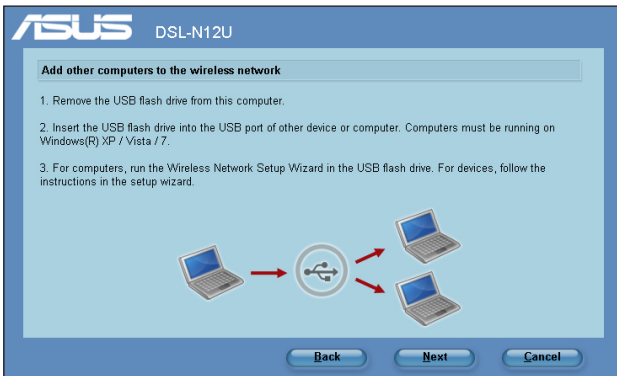

3. Unplug the USB flash drive from your computer then insert it to the other computer that you want to add to your wireless network.

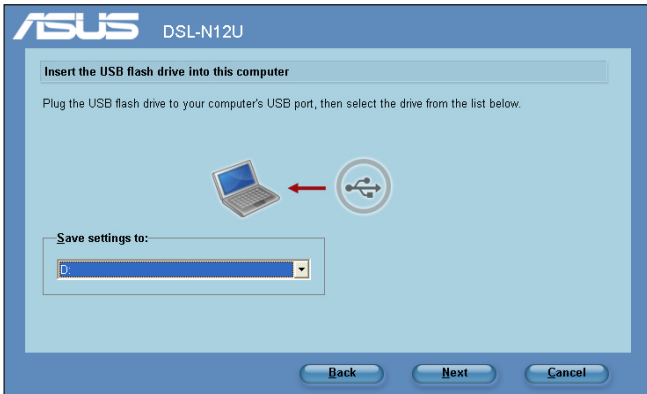

4. Locate **SetupWireless.exe** from the USB drive, and double-click to run it. Click **Yes** to add the computer to the wireless network.

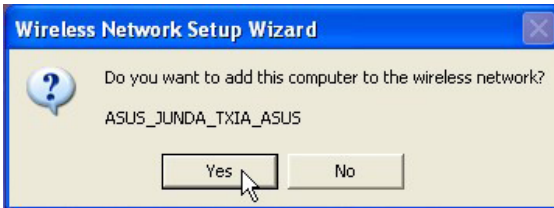

5. Click **OK** to exit the **Wireless Network Setup Wizard**.

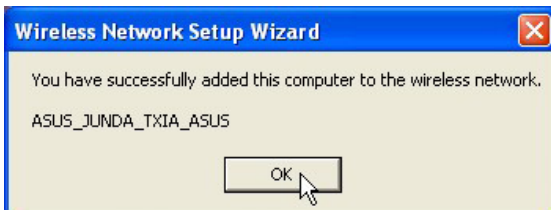

Setting up your network printer

Use the Network Printer Setup utility to set up a USB printer on your ADSL router and allow network clients to access the USB printer.



NOTES:

- To check if your USB printer is compatible with your ASUS ADSL router, refer to the Plug-n-Share Disk Support List at <http://event.asus.com/2009/networks/printersupport/DSL-N12U.htm>
- The ADSL router's printer server function is not supported on Windows® 2000.

To set up your USB Printer:

1. Run the ASUS Wireless Utilities from the support CD, then click **Run Network Printer Setup Program**.

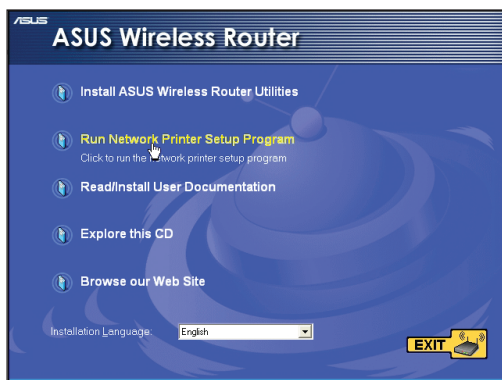

2. Follow the onscreen instructions to set up your hardware, then click **Next**.

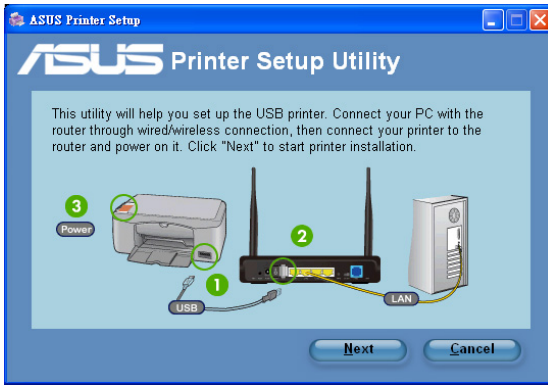

3. Wait for a few minutes for the initial setup to finish. Click **Next**.

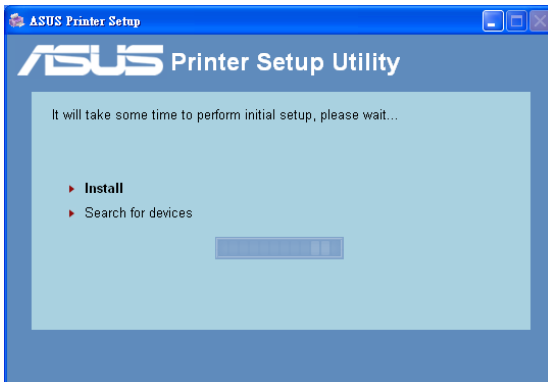

4. Click **Finish** to complete the installation.



5. Follow the Windows® OS instructions to install the printer driver.



6. After the printer's driver installation is completed, network clients can now use the printer.

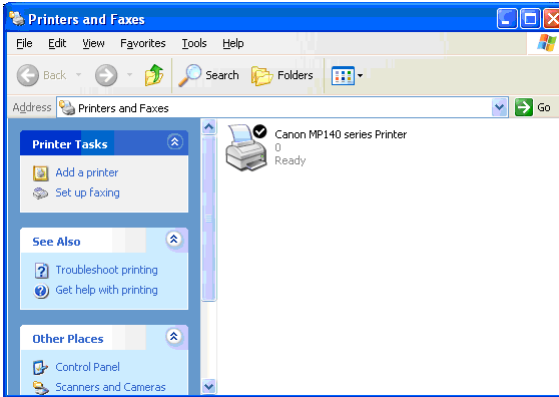

5 Troubleshooting



NOTE: If you encounter problems that are not mentioned in this chapter, contact the ASUS Technical Support.

Troubleshooting

I cannot access a web browser for configuring the router.

- Delete the cookies and files in your web browser. To do this, follow these steps:
 1. Launch your web browser, then click **Tools > Internet Options...**
 2. Under **Temporary Internet files**, click **Delete Cookies...** and **Delete Files...**



NOTE: The commands for deleting cookies and files vary with the web browser.

- Disable the proxy server settings, cancel the dial-up connection, and set the TCP/IP settings to obtain IP addresses automatically. For more details, refer to the section **Before you proceed** in this user manual.

The client cannot establish a wireless connection with the router.

Out of Range:

- Put the router closer to the wireless client.
- Try to change the channel settings.

Authentication:

- Use wired connection to connect to the router.
- Check the wireless security settings.
- Press the Reset button at the rear panel for more than five seconds.

Cannot find the router:

- Press the Reset button at the rear panel for more than five seconds.
- Check the setting in the wireless adapter such as SSID and encryption settings.
- Check if the wireless indicator on the front panel is off. Turn the wireless switch at the rear panel on/off.

Cannot access the Internet via wireless LAN adapter.

- Move the router closer to the wireless client.
- Check whether the wireless adapter is connected to the correct ADSL router.
- Check whether the wireless channel in use conforms to the channels available in your country/area.
- Check the encryption settings.
- Retry using another Ethernet cable.

Internet is not accessible.

- Check the status indicators on the ADSL modem and the ADSL router.
- Check if the WAN LED on the ADSL router is ON. If the LED is not ON, change the cable and try again.
- Check if the wireless indicator on the front panel is off. Turn the wireless switch at the rear panel on/off.

When ADSL Modem “Link” light is ON (not blinking), this means Internet Access is possible.

- Restart your computer.
- Refer to the Quick Start Guide of the ADSL router and re-configure the settings.
- Check if the WAN LED on the ADSL router is ON.
- Check the wireless encryption settings.
- Check if the computer can get the IP address (via both wired network and wireless network).
- Ensure that your web browser is configured to use the local LAN, and is not configured to use a proxy server.

If the ADSL “LINK” light blinks continuously or stays off, Internet access is not possible - the Router is unable to establish a connection with the ADSL network.

- Ensure that all your cables are all properly connected .
- Disconnect the power cord from the ADSL or cable modem, wait a few minutes, then reconnect the cord.
- If the ADSL light continues to blink or stays OFF, contact your ADSL service provider.

Network name or encryption keys are forgotten.

- Try setting up the wired connection and configuring the wireless encryption again.
- Press the Reset button at the rear panel of the ADSL router for more than five seconds.

How to restore the system to its default settings?

- Press the Reset button at the rear panel of the ADSL router for more than five seconds.
- Refer to the section **Restoring/Saving/Uploading settings** in Chapter 3 of this user manual.

The following are the factory default settings:

User Name:	admin
Password:	admin
Enable DHCP:	Yes (if WAN cable is plugged in)
IP address:	192.168.1.1
Domain Name:	(Blank)
Subnet Mask:	255.255.255.0
DNS Server 1:	192.168.1.1
DNS Server 2:	(Blank)
SSID (2.4GHz):	ASUS
SSID (5GHz):	ASUS_5G

ASUS DDNS Service

DSL-N12U supports the ASUS DDNS service. When exchanging devices at the service center, if you have registered the ASUS DDNS service and want to keep the original domain name, data transfer is a must. Visit your local service center for more information.



NOTES:

- If there is no activity in the domain - such as reconfiguring the router or accessing the registered domain name - within 90 days, the system automatically deletes the registered information.
 - If you encounter any problem or difficulty in using your device, contact the service center.
-

Frequently Asked Questions (FAQs)

1. Will the registered information be lost or registered by others?

If you have not updated the registered information in 90 days, the system automatically deletes the registered information and the domain name may be registered by others.

2. I did not register the ASUS DDNS for the router I bought six months ago. Can I still register it?

Yes, you can still register the ASUS DDNS service for your router. The DDNS service is embedded in your router, so you can register the ASUS DDNS service anytime. Before registering, click **Query** to check if the hostname has been registered or not. If not, the system registers the hostname automatically.

3. I have registered a domain name before and it has been working well until my friends told me that they could not access my domain name.

Check the following:

1. The internet is working well.
2. The DNS server is working well.
3. The last time you updated the

domain name.

If there are still problems in accessing your domain name, contact the service center.

4. Can I register two domain names to separately access my http and ftp servers?

No, you cannot. You can only register one domain name for one router. Use port mapping to implement security in the network.

5. After restarting the router, why is it that I see different WAN IPs in MS DOS and in the router configuration page?

This is normal. The interval time between the ISP DNS server and ASUS DDNS results in different WAN IPs in MS DOS and in the router configuration page. Different ISPs may have different interval time for IP updating.

6. Is the ASUS DDNS service free, or is it just a trial version?

The ASUS DDNS service is a free and embedded service in some ASUS routers. Check your ASUS router if it supports the ASUS DDNS service.

Appendices

Notices

ASUS Recycling/Takeback Services

ASUS recycling and takeback programs come from our commitment to the highest standards for protecting our environment. We believe in providing solutions for you to be able to responsibly recycle our products, batteries, other components, as well as the packaging materials. Please go to <http://csr.asus.com/english/Takeback.htm> for the detailed recycling information in different regions.

REACH

Complying with the REACH (Registration, Evaluation, Authorisation, and Restriction of Chemicals) regulatory framework, we published the chemical substances in our products at ASUS REACH website at

<http://csr.asus.com/english/index.aspx>

Prohibition of Co-location

This device and its antenna(s) must not be co-located or operating in conjunction with any other antenna or transmitter

Declaration of Conformity for R&TTE directive 1999/5/EC

Essential requirements – Article 3

Protection requirements for health and safety – Article 3.1a

Testing for electric safety according to EN 60950-1 has been conducted. These are considered relevant and sufficient.

Protection requirements for electromagnetic compatibility – Article 3.1b

Testing for electromagnetic compatibility according to EN 301 489-1 and EN 301 489-17 has been conducted. These are considered relevant and sufficient.

Effective use of the radio spectrum – Article 3.2

Testing for radio test suites according to EN 300 328- 2 has been conducted. These are considered relevant and sufficient.

CE Mark Warning

This is a Class B product, in a domestic environment, this product may cause radio interference, in which case the user may be required to take adequate measures.

GNU General Public License

Licensing information

This product includes copyrighted third-party software licensed under the terms of the GNU General Public License. Please see The GNU General Public License for the exact terms and conditions of this license. We include a copy of the GPL with every CD shipped with our product. All future firmware updates will also be accompanied with their respective source code. Please visit our web site for updated information. Note that we do not offer direct support for the distribution.

GNU GENERAL PUBLIC LICENSE

Version 2, June 1991

Copyright (C) 1989, 1991 Free Software Foundation, Inc.

59 Temple Place, Suite 330, Boston, MA 02111-1307 USA

Everyone is permitted to copy and distribute verbatim copies of this license document, but changing it is not allowed.

Preamble

The licenses for most software are designed to take away your freedom to share and change it. By contrast, the GNU General Public License is intended to guarantee your freedom to share and change free software--to make sure the software is free for all its users. This General Public License applies to most of the Free Software Foundation's software and to any other program whose

authors commit to using it. (Some other Free Software Foundation software is covered by the GNU Library General Public License instead.) You can apply it to your programs, too.

When we speak of free software, we are referring to freedom, not price. Our General Public Licenses are designed to make sure that you have the freedom to distribute copies of free software (and charge for this service if you wish), that you receive source code or can get it if you want it, that you can change the software or use pieces of it in new free programs; and that you know you can do these things.

To protect your rights, we need to make restrictions that forbid anyone to deny you these rights or to ask you to surrender the rights. These restrictions translate to certain responsibilities for you if you distribute copies of the software, or if you modify it.

For example, if you distribute copies of such a program, whether gratis or for a fee, you must give the recipients all the rights that you have. You must make sure that they, too, receive or can get the source code. And you must show them these terms so they know their rights.

We protect your rights with two steps: (1) copyright the software, and (2) offer you this license which gives you legal permission to copy, distribute and/or modify the software.

Also, for each author's protection and ours, we want to make certain that everyone understands that there is no warranty for this free software. If the software is modified by someone else and passed on, we want its recipients to know that what they have is not the original, so that any problems introduced by others will not reflect on the original authors' reputations.

Finally, any free program is threatened constantly by software patents. We wish to avoid the danger that redistributors of a free program will individually obtain patent licenses, in effect making the program proprietary. To prevent this, we have made it clear that any patent must be licensed for everyone's free use or not licensed at all.

The precise terms and conditions for copying, distribution and modification follow.

Terms & conditions for copying, distribution, & modification

0. This License applies to any program or other work which contains a notice placed by the copyright holder saying it may be distributed under the terms of this General Public License. The "Program"; below, refers to any such program or work, and a "work based on the Program" means either the Program or any derivative work under copyright law: that is to say, a work containing the Program or a portion of it, either verbatim or with modifications and/or translated into another language. (Hereinafter, translation is included without limitation in the term "modification".) Each licensee is addressed as "you".

Activities other than copying, distribution and modification are not covered by this License; they are outside its scope. The act of running the Program is not restricted, and the output from the Program is covered only if its contents constitute a work based on the Program (independent of having been made by running the Program). Whether that is true depends on what the Program does.

1. You may copy and distribute verbatim copies of the Program's source code as you receive it, in any medium, provided that you conspicuously and appropriately publish on each copy an appropriate copyright notice and disclaimer of warranty; keep intact all the notices that refer to this License and to the absence of any warranty; and give any other recipients of the Program a copy of this License along with the Program.

You may charge a fee for the physical act of transferring a copy, and you may at your option offer warranty protection in exchange for a fee.

2. You may modify your copy or copies of the Program or any portion of it, thus forming a work based on the Program, and copy and distribute such modifications or work under the terms of Section 1 above, provided that you also meet all of these conditions:

- a) You must cause the modified files to carry prominent notices stating that you changed the files and the date of any change.
- b) You must cause any work that you distribute or publish, that in whole or in part contains or is derived from the Program or any part thereof, to be licensed as a whole at no charge to all third parties under the terms of this License.
- c) If the modified program normally reads commands interactively when run, you must cause it, when started running for such interactive use in the most ordinary way, to print or display an announcement including an appropriate copyright notice and a notice that there is no warranty (or else, saying that you provide a warranty) and that users may redistribute the program under these conditions, and telling the user how to view a copy of this License. (Exception: if the Program itself is interactive but does not normally print such an announcement, your work based on the Program is not required to print an announcement.)

These requirements apply to the modified work as a whole. If identifiable sections of that work are not derived from the Program, and can be reasonably considered independent and separate works in themselves, then this License, and its terms, do not apply to those sections when you distribute them as separate works. But when you distribute the same sections as part of a whole which is a work based on the Program, the distribution of the whole must be on the terms of this License, whose permissions for other licensees extend to the entire whole, and thus to each and every part regardless of who wrote it.

Thus, it is not the intent of this section to claim rights or contest your rights to work written entirely by you; rather, the intent is to exercise the right to control the distribution of derivative or collective works based on the Program.

In addition, mere aggregation of another work not based on the Program with the Program (or with a work based on the Program) on a volume of a storage or distribution medium does not bring the other work under the scope of this License.

3. You may copy and distribute the Program (or a work based on it, under Section 2) in object code or executable form under the terms of Sections 1 and 2 above provided that you also do one of the following:
 - a) Accompany it with the complete corresponding machine-readable source code, which must be distributed under the terms of Sections 1 and 2 above on a medium customarily used for software interchange; or,
 - b) Accompany it with a written offer, valid for at least three years, to give any third party, for a charge no more than your cost of physically performing source distribution, a complete machine-readable copy of the corresponding source code, to be distributed under the terms of Sections 1 and 2 above on a medium customarily used for software interchange; or,
 - c) Accompany it with the information you received as to the offer to distribute corresponding source code. (This alternative is allowed only for noncommercial distribution and only if you received the program in object code or executable form with such an offer, in accord with Subsection b above.)

The source code for a work means the preferred form of the work for making modifications to it. For an executable work, complete source code means all the source code for all modules it contains, plus any associated interface definition files, plus the scripts used to control compilation and installation of the executable. However, as a special exception, the source code distributed need not include anything that is normally distributed (in either source or binary form) with the major components (compiler, kernel, and so on) of the operating system on which the executable runs, unless that component itself accompanies the executable.

If distribution of executable or object code is made by offering access to copy from a designated place, then offering equivalent access to copy the source code from the same place counts as distribution of the source code, even though third parties are not compelled to copy the source along with the object code.

4. You may not copy, modify, sublicense, or distribute the Program except as expressly provided under this License. Any attempt otherwise to copy, modify, sublicense or distribute the Program is void, and will automatically terminate your rights under this License. However, parties who have received copies, or rights, from you under this License will not have their licenses terminated so long as such parties remain in full compliance.
5. You are not required to accept this License, since you have not signed it. However, nothing else grants you permission to modify or distribute the Program or its derivative works. These actions are prohibited by law if you do not accept this License. Therefore, by modifying or distributing the Program (or any work based on the Program), you indicate your acceptance of this License to do so, and all its terms and conditions for copying, distributing or modifying the Program or works based on it.
6. Each time you redistribute the Program (or any work based on the Program), the recipient automatically receives a license from the original licensor to copy, distribute or modify the Program subject to these terms and conditions. You may not impose any further restrictions on the recipients' exercise of the rights granted herein. You are not responsible for enforcing compliance by third parties to this License.
7. If, as a consequence of a court judgment or allegation of patent infringement or for any other reason (not limited to patent issues), conditions are imposed on you (whether by court order, agreement or otherwise) that contradict the conditions of this License, they do not excuse you from the conditions of this License. If you cannot distribute so as to satisfy simultaneously your obligations under this License and any other pertinent obligations, then as a consequence you may not distribute the Program at all. For example, if a patent license would not permit royalty-free redistribution of the Program by all those who receive copies directly or indirectly through you, then the only way you could satisfy both it and this License would be to refrain entirely from distribution of the Program.

If any portion of this section is held invalid or unenforceable under any particular circumstance, the balance of the section is intended to apply and the section as a whole is intended to apply in other circumstances.

It is not the purpose of this section to induce you to infringe any patents or other property right claims or to contest validity of any such claims; this section has the sole purpose of protecting the integrity of the free software distribution system, which is implemented by public license practices. Many people have made generous contributions to the wide range of software distributed through that system in reliance on consistent application of that system; it is up to the author/donor to decide if he or she is willing to distribute software through any other system and a licensee cannot impose that choice.

This section is intended to make thoroughly clear what is believed to be a consequence of the rest of this License.

8. If the distribution and/or use of the Program is restricted in certain countries either by patents or by copyrighted interfaces, the original copyright holder who places the Program under this License may add an explicit geographical distribution limitation excluding those countries, so that distribution is permitted only in or among countries not thus excluded. In such case, this License incorporates the limitation as if written in the body of this License.

9. The Free Software Foundation may publish revised and/or new versions of the General Public License from time to time. Such new versions will be similar in spirit to the present version, but may differ in detail to address new problems or concerns.

Each version is given a distinguishing version number. If the Program specifies a version number of this License which applies to it and "any later version", you have the option of following the terms and conditions either of that version or of any later version published by the Free Software Foundation. If the Program does not specify a version number of this License,

you may choose any version ever published by the Free Software Foundation.

10. If you wish to incorporate parts of the Program into other free programs whose distribution conditions are different, write to the author to ask for permission.

For software which is copyrighted by the Free Software Foundation, write to the Free Software Foundation; we sometimes make exceptions for this. Our decision will be guided by the two goals of preserving the free status of all derivatives of our free software and of promoting the sharing and reuse of software generally.

NO WARRANTY

- 11 BECAUSE THE PROGRAM IS LICENSED FREE OF CHARGE, THERE IS NO WARRANTY FOR THE PROGRAM, TO THE EXTENT PERMITTED BY APPLICABLE LAW. EXCEPT WHEN OTHERWISE STATED IN WRITING THE COPYRIGHT HOLDERS AND/OR OTHER PARTIES PROVIDE THE PROGRAM "AS IS" WITHOUT WARRANTY OF ANY KIND, EITHER EXPRESSED OR IMPLIED, INCLUDING, BUT NOT LIMITED TO, THE IMPLIED WARRANTIES OF MERCHANTABILITY AND FITNESS FOR A PARTICULAR PURPOSE. THE ENTIRE RISK AS TO THE QUALITY AND PERFORMANCE OF THE PROGRAM IS WITH YOU. SHOULD THE PROGRAM PROVE DEFECTIVE, YOU ASSUME THE COST OF ALL NECESSARY SERVICING, REPAIR OR CORRECTION.

- 12 IN NO EVENT UNLESS REQUIRED BY APPLICABLE LAW OR AGREED TO IN WRITING WILL ANY COPYRIGHT HOLDER, OR ANY OTHER PARTY WHO MAY MODIFY AND/OR REDISTRIBUTE THE PROGRAM AS PERMITTED ABOVE, BE LIABLE TO YOU FOR DAMAGES, INCLUDING ANY GENERAL, SPECIAL, INCIDENTAL OR CONSEQUENTIAL DAMAGES ARISING OUT OF THE USE OR INABILITY TO USE THE PROGRAM (INCLUDING BUT NOT LIMITED TO LOSS OF DATA OR DATA BEING RENDERED INACCURATE OR LOSSES SUSTAINED BY YOU OR THIRD PARTIES

OR A FAILURE OF THE PROGRAM TO OPERATE WITH ANY OTHER PROGRAMS), EVEN IF SUCH HOLDER OR OTHER PARTY HAS BEEN ADVISED OF THE POSSIBILITY OF SUCH DAMAGES.

END OF TERMS AND CONDITIONS

ASUS Contact information

ASUSTeK COMPUTER INC. (Asia Pacific)

Address 15 Li-Te Road, Peitou, Taipei, Taiwan 11259

Website www.asus.com

Technical Support

Telephone +886228943447

Support Fax +886228907698

Online support support.asus.com

ASUS COMPUTER INTERNATIONAL (America)

Address 800 Corporate Way, Fremont, CA 94539, USA

Telephone +15107393777

Fax +15106084555

Website usa.asus.com

Online support support.asus.com

ASUS COMPUTER GmbH (Germany and Austria)

Address Harkort Str. 21-23, D-40880 Ratingen, Germany

Telephone +491805010923*

Fax +492102959911

Website www.asus.de

Online contact www.asus.de/sales

Technical Support

Telephone (Component, Networking) +491805010923*

Telephone (System/Notebook/Eee/LCD) +491805010920*

Fax +492102959911

Online support support.asus.com

* EUR 0.14/minute from a German fixed landline; EUR 0.42/minute from a mobile phone.

Networks Global Hotline Information

Area	Hotline Number	Support Languages	Working Hour	Working Day
Australia	1300-2787-88	English	9:00-18:00	Mon. to Fri.
Austria	0043-820240513	German	9:00-18:00	Mon. to Fri.
Belgium	0032-78150231	Dutch /French	9:00-17:00	Mon. to Fri.
China	400-620-6655	Simplified Chinese	9:00-18:00	Mon. to Sun.
Denmark	0045-3832-2943	Denish/English	9:00-17:00	Mon. to Fri.
Finland	00358-9693-7969	Finnish/English/ Swedish	10:00-18:00	Mon. to Fri.
France	0033-170949400	France	9:00-17:45	Mon. to Fri.
Greece	00800-44-14-20-44	Greek	9:00-13:00; 14:00-18:00	Mon. to Fri.
Hong Kong	3582-4770	Cantonese/ Chinese/ English	10:00-20:00	Mon. to Fri.
			10:00-17:00	Sat.
Ireland	0035-31890719918	English	9:00-17:00	Mon. to Fri.
Japan	0800-123-2787	Japanese	9:00-18:00	Mon. to Fri.
			9:00-17:00	Sat. to Sun.
Malaysia	+603 2148 0827 (Check Repair Detail Status Only) +603-6279-5077	Bahasa Melayu/ English	10:00-19:00	Mon. to Fri.
Netherlands / Luxembourg	0031-591-570290	Dutch / English	9:00-17:00	Mon. to Fri.
New Zealand	0800-278-788 / 0800-278-778	English	9:00-17:00	Mon. to Fri.
Norway	0047-2316-2682	Norwegian /English	9:00-17:00	Mon. to Fri.
Philippine	+632-636 8504; 180014410573	English	9:00-18:00	Mon. to Fri.
Poland	00225-718-033	Polish	9:00-17:00	Mon. to Fri.
	00225-718-040		8:30-17:30	
Portugal	707-500-310	Portuguese	9:00-17:00	Mon. to Fri.

Networks Global Hotline Information

Area	Hotline Number	Support Languages	Working Hour	Working Day
Russia	+8-800-100-ASUS; +7-495-231-1999	Russian/ English	9:00-18:00	Mon. to Fri.
Singapore	+65-6720-3835 (Check Repair Detail Status Only) -66221701	English	11:00-19:00	Mon. to Fri.
Slovak	00421-232-162-621	Czech	8:00-17:00	Mon. to Fri.
Spain	902-88-96-88	Spanish	9:00-18:00	Mon. to Fri.
Sweden	0046-8587-6940	Swedish/ English	9:00-17:00	Mon. to Fri.
Switzerland	0041-848111010	German/French	9:00-18:00	Mon. to Fri.
	0041-848111014	French	9:00-17:45	Mon. to Fri.
	0041-848111012	Italian	9:00-17:00	Mon. to Fri.
Taiwan	0800-093-456; 02-81439000	Traditional Chinese	9:00-12:00; 13:30-18:00	Mon. to Fri.
Thailand	+662-679-8367 -70; 001 800 852 5201	Thai/English	9:00-18:00	Mon. to Fri.
Turkey	+90-216-524-3000	Turkish	09:00-18:00	Mon. to Fri.
United Kingdom	0044-870-1208340; 0035-31890719918	English	9:00-17:00	Mon. to Fri.
USA/Canada	1-812-282-2787	English	8:30-12:00am EST (5:30am- 9:00pm PST) 9:00am- 6:00pm EST (6:00am- 3:00pm PST)	Mon. to Fri. Sat. to Sun.



NOTE: For more information, visit the ASUS support site at:
<http://support.asus.com>

Manufacturer:	ASUSTeK Computer Inc. Tel: +886-2-2894-3447 Address: No. 150, LI-TE RD., PEITOU, TAIPEI 112, TAIWAN
Authorised representative in Europe:	ASUS Computer GmbH Address: HARKORT STR. 21-23, 40880 RATINGEN, GERMANY
Authorised distributors in Turkey:	BOGAZICI BIL GISAYAR SAN. VE TIC. A.S. Tel: +90 212 3311000 Address: AYAZAGA MAH. KEMERBURGAZ CAD. NO.10 AYAZAGA/ISTANBUL
	CIZGI Elektronik San. Tic. Ltd. Sti. Tel: +90 212 3567070 Address: CEMAL SURURI CD. HALIM MERIC IS MERKEZI No: 15/C D:5-6 34394 MECIDIYEKOY/ISTANBUL

EEE Yönetmeliğine Uygundur.

Free Manuals Download Website

<http://myh66.com>

<http://usermanuals.us>

<http://www.somanuals.com>

<http://www.4manuals.cc>

<http://www.manual-lib.com>

<http://www.404manual.com>

<http://www.luxmanual.com>

<http://aubethermostatmanual.com>

Golf course search by state

<http://golfingnear.com>

Email search by domain

<http://emailbydomain.com>

Auto manuals search

<http://auto.somanuals.com>

TV manuals search

<http://tv.somanuals.com>