

D710/D710PK
D7104/D7104PK
7" Portable DVD Player

Table of Contents

A. Introduction	7
B. DVD and Disc Information	7
C. Contents	8
D. Powering and installation	8
E. Vehicle Installation	9
F. Controls, Indicators, and Connectors.....	10
G. Loading and Playing a Disc	11
H. Basic Operation.....	12
I. Menu	13
J. Display.....	13
K. Playing Audio CDs.....	18
L. Playing JPEG Files.....	19
M. Connecting to Other Equipment.....	20
N. Setup	21
O. Specifications	29
P. Rechargeable Built-in Battery use.....	29
Q. Troubleshooting	31

Table des matières

A. Introduction	38
B. Renseignements sur les DVD et disques.....	38
C. Contenus.....	39
D. Alimentation et installation.....	39
E. Installation dans un véhicule.....	40
F. Commandes, témoins et branchements.....	41
G. Chargement et lecture d'un disque.....	42
H. Fonctionnement de base.....	43
I. Menu	44
J. Affichage.....	44
K. Lecture de CD audio.....	49
L. Visionnement de fichiers JPEG.....	50
M. Branchement f d'autres appareils.....	51
N. Configuration.....	52
O. Caractéristiques techniques.....	60
P. Pile rechargeable intégrée.....	60
Q. Dépannage	62

Contenido

A. Introducción	69
B. Información sobre DVD y Disco.....	69
C. Contenido	70
D. Suministro de energía e instalación	70
E. Instalación en vehículo	71
F. Controles, Indicadores y Conectores	72
G. Carga y reproducción de un disco.....	73
H. Operación básica	74
I. Menú	75
J. Visualización.....	75
K. Reproducción de CDs de Audio.....	80
L. Reproducción de archivos JPEG.....	81
M. Conexión a otro equipo.....	82
N. Configuración.....	83
O. Especificaciones	91
P. Batería integrada recargable	91
Q. Solución de Problemas	93

Important Safety Instructions

Some of the following information may not apply to your particular product; however, as with any electronic product, precautions should be observed during handling and use.

- | Read these instructions.
- | Keep these instructions.
- | Heed all warnings.
- | Follow all instructions.
- | Do not use this apparatus near water.
- | Clean only with dry cloth.
- | Do not block any ventilation openings. Install in accordance with the manufacturer's instructions.
- | Do not install near any heat sources such as radiators, heat registers, stoves, or other apparatus (including amplifiers) that produce heat.
- | Do not defeat the safety purpose of the polarized or grounding-type plug. A polarized plug has two blades with one wider than the other. A grounding type plug has two blades and a third grounding prong. The wide blade or the third prong is provided for your safety. If the provided plug does not fit into your outlet, consult an electrician for replacement of the obsolete outlet.
- | Protect the power cord from being walked on or pinched particularly at plugs, convenience receptacles, and the point where they exit from the apparatus.
- | Only use attachments/accessories specified by the manufacturer.
- | Use only with the cart, stand, tripod, bracket, or table specified by the manufacturer, or sold with the apparatus. When a cart is used, use caution when moving the cart/apparatus combination to avoid injury from tip-over.
- | Unplug this apparatus during lightning storms or when unused for long periods of time.
- | Refer all servicing to qualified service personnel. Servicing is required when the apparatus has been damaged in any way, such as power-supply cord or plug is damaged, liquid has been spilled or objects have fallen into the apparatus, the apparatus has been exposed to rain or moisture, does not operate normally, or has been dropped.



Additional Safety Information

- | Apparatus shall not be exposed to dripping or splashing and no objects filled with liquids, such as vases, shall be placed on the apparatus.
- | Always leave sufficient space around the product for ventilation. Do not place product in or on a bed, rug, in a bookcase or cabinet that may prevent air flow through vent openings.
- | Do not place lighted candles, cigarettes, cigars, etc. on the product.
- | Connect power cord only to AC power source as marked on the product.
- | Care should be taken so that objects do not fall into the product.
- | Do not attempt to disassemble the cabinet. This product does not contain customer serviceable components.
- | Do not use the unit immediately after transportation from a cold place to a warm place; condensation problems may result. Wait for about one hour till the moisture evaporates before operating the unit.
- | When using your portable DVD player, do not sit or stand too close to the screen.
- | To use a headset safely, please keep the following in mind:
 - Do not play your headset at a high volume. Hearing experts advise against continuous extended play.
 - If you experience ringing in your ears, turn down the volume or stop using the headset.
 - Do not use a headset while driving a motorized vehicle or riding a bike. It may cause a traffic hazard and is illegal in many areas.
 - Even if your headset is an open-air type designed to let you hear outside sounds, don't turn up the volume so high that can't hear sounds around you.
- | CAUTION! CD and DVD products utilize a laser. Do not try to open the product. Refer all servicing to qualified service personnel.
- | CAUTION! Danger of explosion if battery is incorrectly replaced. Replace only with the same or equivalent type.
- | Warning: Your DVD player contains a battery and charging system which is designed to work in temperatures that do not exceed 50°C (122°F). Leaving this product in a closed automobile or in the trunk of an automobile where temperature may exceed 50°C may result in permanent battery damage, fire, or explosion. Please remove your product from the automobile when you exit, do not place your product in the trunk of your automobile, and do not leave your product in any location where temperature may exceed 50°C.

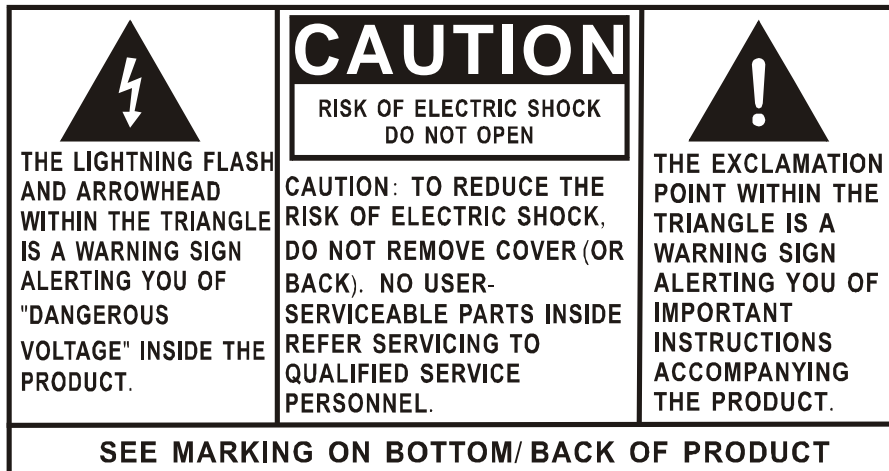

WARNING: TO PREVENT FIRE OR ELECTRICAL SHOCK HAZARD, DO NOT EXPOSE THIS PRODUCT TO RAIN OR MOISTURE.

FCC Information

This device complies with part 15 of the FCC rules. Operation is subject to the following two conditions: (1) This device may not cause harmful interference, and (2) This device must accept any interference received, including interference which may cause undesired operation.

This equipment has been tested and found to comply with the limits for a Class B digital device, pursuant to Part 15 of the FCC Rules. These limits are designed to provide reasonable protection against harmful interference in a residential installation. This equipment generates, uses and can radiate radio frequency energy and, if not installed and used in accordance with the instructions, may cause harmful interference to radio communications. However, there is no guarantee that interference will not occur in a particular installation.

If this equipment does cause harmful interference to radio or television reception, which can be determined by turning the equipment off and on, the user is encouraged to try to correct the interference by one or more of the following measures:

- Reorient or relocate the receiving antenna.
- Increase the separation between the equipment and receiver.

- Connect the equipment into an outlet on a circuit different from that to which the receiver is connected.
- Consult the dealer or an experienced radio / TV technician for help.

In accordance with FCC requirements, changes or modifications not expressly approved by manufacturer could void the user's authority to operate this product.

Manufacturer/Responsible Party

Audiovox Electronics Corp.,
150 Marcus Blvd., Hauppauge, NY 11788

This class B digital apparatus complies with Canadian ICES-003.
Cet appareil numérique de la classe B est conforme à la norme NMB-003 du Canada.

Service Information

This product should be serviced only by those specially trained in appropriate servicing techniques. For instructions on how to obtain service, refer to the warranty included in this user manual.

For Your Records

Keep your sales receipt for proof of purchase to obtain warranty parts and service.

In the event that service should be required, you may need both the model number and the serial number. In the space below, record the date and place of purchase, and the serial number:

Model No.
Date of Purchase
Place of Purchase
Serial No.

A. Introduction

Thank you for choosing the portable DVD player. The main features include a 7" wide Screen (16:9 Aspect Ratio) Liquid Crystal Display (LCD) monitor and a DVD player. The unit applies the latest state of the art electronics and is designed for use in hotels, offices or your home. The unit is constructed to provide years of reliable, trouble-free service and is compact so that you can take it with you anywhere and is designed for quick and easy installation. Please read the entire instruction manual supplied with this product prior to using. The documentation will assist you in using the system properly to obtain the best equipment performance. Please save this manual for later use.

B. DVD and Disc Information

DVD Copy Protection - This Product incorporates copyright protection technology that is protected by method claims of certain U.S. Patents and other intellectual property rights owned by Macrovision Corporation and other rights owners. Use of this copyright protection technology must be authorized by Macrovision Corporation, and is intended for home and other limited viewing uses only unless otherwise authorized by Macrovision Corporation. Reverse engineering or disassembly is prohibited.

DVD Regional Code - Your DVD player has been designed to process regional management information that is stored on DVD discs. The regional code for your player is 1 (The U.S., U.S. Territories and Canada). Only DVD discs that have regional codes of 1 or ALL (for all regions) can be played by your player.



Disc - Do not use irregularly shaped discs such as heart or star-shaped discs as they may cause the unit to malfunction. Do not stick paper, tape or glue on the disc. Do not expose the disc to direct sunlight or heat sources such as hot air ducts. Do not touch the surface of disc. Handle the disc by its edge. Clean the disc by wiping the disc from the center out with a cleaning cloth. Remove the disc from the unit and store it in its case after playing. Some playback operations of discs may be intentionally fixed by software producers. Since this unit plays discs according to the disc contents the software producers designed, some playback features may not be available. Also refer to the instructions supplied with the discs.

C. Contents

1. 1 x 7" Portable DVD Player with built in battery*
2. 1 x AC to DC Power Adapter
3. 1 x Automotive Power Adapter
4. 1 x Carrying Bag**
5. 2 x Foldable Headphones**
6. 1 x Instruction Manual
7. 1 x Product Registration Card
8. 1 x eMusic Card

* D710 & D710PK can operate on a fully charged battery *about 2 hours*;
D7104 & D7104PK can operate on a fully charged battery *about 4 hours*.
** Only for D710PK and D7104PK.

D. Powering and Installation

- 1. Powering the System Indoors** (Refer to Figure 1, "in door use")
Plug one end of the AC to DC adapter into the DC input jack on the right side of the main unit, then plug the other end into the 100~240V AC power receptacle.
- 2. Powering the System in a Car** (Refer to Figure 1, "Mobile Use")
Plug one end of the Automotive Power adapter into the DC input jack on the unit, then plug the other end into the vehicle power outlet.

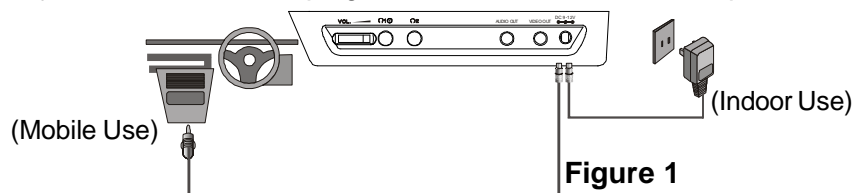

- 3. To Charge the Built-in Battery**

Plug one end of the AC to DC power adapter into the DC jack on the side of the player, as shown in Figure 1, then plug the other end into the 100~240V AC power outlet. If the player is powered off, the charge indicator will turn red indicating the battery is charging. Once fully charged, the charge indicator will turn off. Once the indicator is off, remove the AC to DC power adapter wall plug.

NOTE: Your new battery must be charged a minimum of 8 hours before the first usage. D710/D710PK needs around 3.5 hours to fully recharge the battery and D7104/D7104PK needs around 6.5 hours to fully recharge the battery.

E. Vehicle Installation *

Installing the DVD Player onto the Seat Back in a Car

(Refer to Figure 2) Carrying Bag Opened

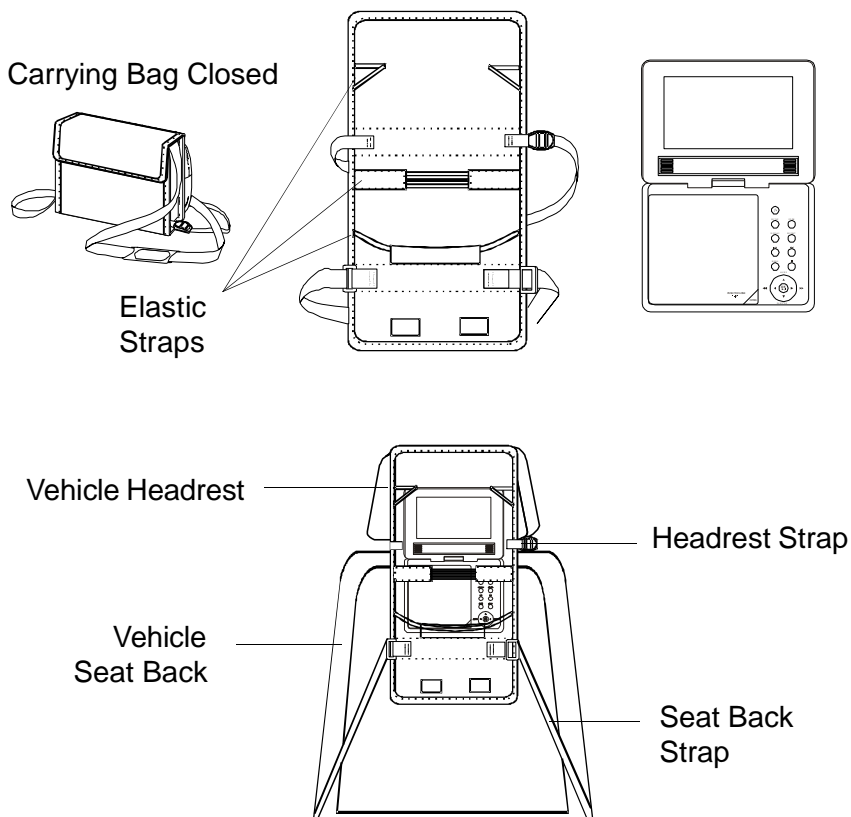

Figure 2

- 1). Unfold the carrying bag, and place the DVD player on the bag beneath the elastic straps. Ensure that the unit's corners are secured by the elastic straps.
- 2). Secure the upper portion of the carrying bag to headrest support bars using the headrest strap. Adjust the headrest strap until the bag is firmly secured.
- 3). Secure the lower portion of the carrying bag to the vehicle seat back using the seat back strap. Adjust the seat back strap until the bag is firmly secured.

* The bag is only provided for D710PK, D7104PK.

F. Controls, Indicators, and Connectors

1. Unit View (Refer to Figure 3)

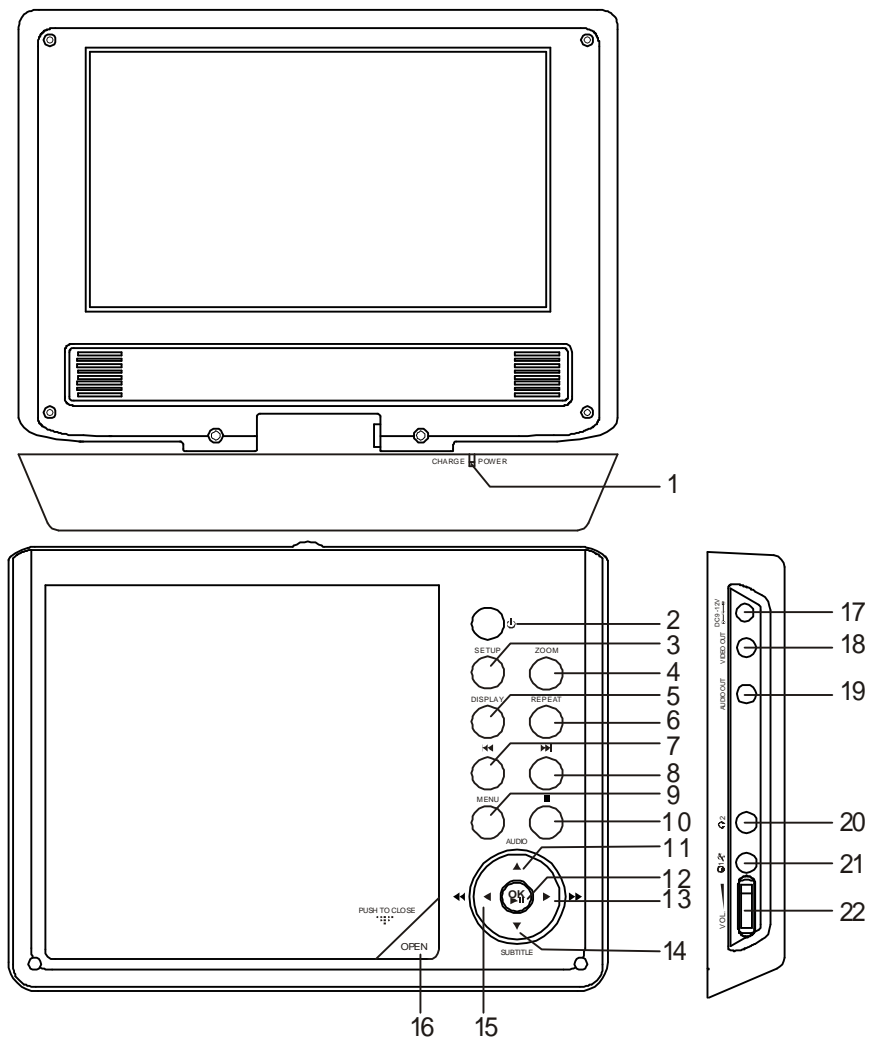

Figure 3

- | | |
|-----------------------|--------------------------------------|
| 1) Charge/Power LED | 12) OK/ ► OK play/pause Button |
| 2) ⏻ Power Button | 13) ► / ►► Right/Fast Forward Button |
| 3) Setup Button | 14) ▼Down/Subtitle Button |
| 4) Zoom Button | 15) ◀/◀◀ Left/Fast Backward Button |
| 5) Display Button | 16) Cover Open Button |
| 6) Repeat Button | 17) DC 9-12 V Input Jack |
| 7) ◀◀ Previous Button | 18) Video Out Jack |
| 8) ►► Next Button | 19) Audio Out Jack |
| 9) Menu Button | 20) Headphone Jack 2 |
| 10) ■ Stop Button | 21) Headphone Jack 1* |
| 11) ▲UP/AUDIO button | 22) Volume Control |

* *Connecting to this headphone jack will disable the internal speakers.*

G. Loading and Playing a Disc

- After connecting power to the unit, press the ⏻ button to power ON the unit. The power indicator will turn green.
- Open the disc tray by pressing the OPEN button and place a disc onto the tray with the label side facing up.
- Close the tray by pressing the area marked "PUSH TO CLOSE". The unit will load the disc and start playing.
- Rotate VOLUME control to adjust the DVD player's volume.
- To stop playing a disc, press the ■ button.
- To turn off the DVD player, press the ⏻ button.

H. Basic Operation

POWER	Turn the unit on
OPEN	Remove/load the disc
PLAY	Start Play/Execute item or setting
PAUSE	Still Picture
STOP	(1 time) Stop at the present playing point / (2 times) Stop playback of the DVD/CD
NEXT	Go to the next chapter, track or scene during playback
PREVIOUS	Go back to the previous chapter, track or scene during playback
LEFT/RIGHT/UP/DOWN	Use for Menu Navigation
OK	Execute item or confirm setting
MENU	Display the main menu of the disc
REPEAT	Repeat playing title, chapter, or track
DISPLAY	Display information (title, chapter, track, time, etc.)
SUBTITLE	Select the subtitle language or turn it on/off
AUDIO	Select the audio language
ZOOM	Enlarge an image to 2, 3, or 4 times the original size during DVD playback.
SETUP	Display the setup menu to select and set items, and exit the setup menu.

I. Menu

A DVD is divided into sections called titles and chapters. When you play a DVD, a root menu of the disc will appear on the screen of your TV or Monitor. The contents of the menu vary from disc to disc. Press MENU during playback to display the menu. Some DVDs only allow you to select disc playback options using the DVD root menu.

J. Display (Display contents vary from disc to disc.)

1. Playing Time and Remaining Time

- a. During playback press the DISPLAY button to display the current Title Number (1), the total Number of Titles (2), the current Chapter Number (3), the total Number of Chapters (4), and the elapsed playing Time for the title (5). The heading will disappear automatically after 3 seconds if no buttons are pressed.

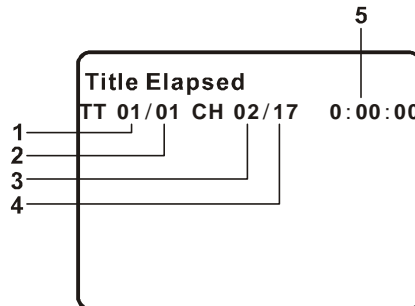

Title, Chapter Number and Time Screen Display

- b. Press "DISPLAY" button again to display the Remaining Time of the title. The heading will disappear automatically in 3 seconds.

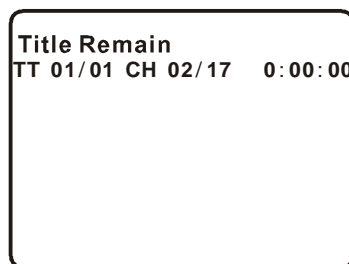

Title Remaining Time Screen Display

- c. Press "DISPLAY" button a third time to display the Elapsed Time for the chapter. The heading will disappear automatically in 3 seconds.

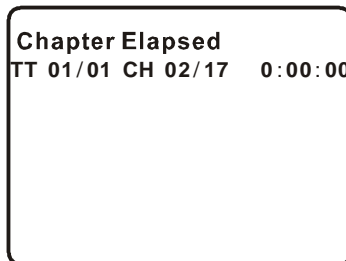

Chapter Elapsed Time Screen Display

- d. Press "DISPLAY" button a fourth time to display the Remaining Time for the chapter. The heading will disappear automatically in 3 seconds.

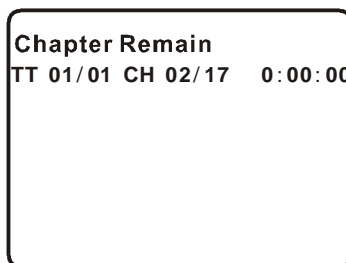

Chapter Remaining Time Screen Display

- e. Press "DISPLAY" button a fifth time to exit, "DISPLAY OFF" will be displayed and will disappear automatically in 3 seconds.

2. Subtitle

During disc playback press SUBTITLE button to select the subtitle language you desire*, with the current Subtitle Language Number (1) and the total Number of Subtitle Languages (2) displayed. If there are multiple languages press SUBTITLE button again to select another subtitle language. To turn subtitles OFF, press the SUBTITLE button until 'Subtitle off' is displayed. The Subtitle display will disappear automatically if the SUBTITLE button is not pressed again within 3 seconds.

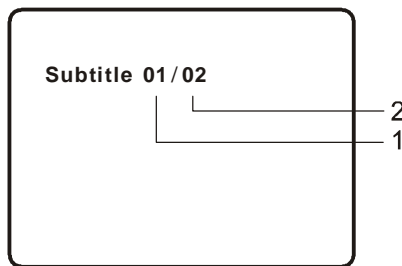

Subtitle Screen Display

3. Audio

During playback press AUDIO button to select the audio language you desire*, with the current Audio Channel Number (1) and the total number of Audio Channels (2) displayed. Press AUDIO again to select another audio language. The audio display will disappear automatically if the AUDIO button is not pressed within 3 seconds.

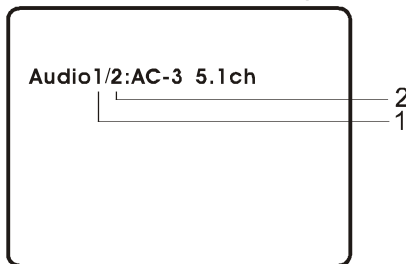

Audio Language Screen Display

* Some DVDs only allow access to this function through the DVD menu.

4. Zoom

During playback press ZOOM button to enlarge the picture by 2x, 3x or 4X with the current zoom multiple. Press ZOOM button one time, the picture will be enlarged 2X. Press ZOOM button a second time, the picture will be enlarged 3X. Press ZOOM button a third time, the picture will be enlarged 4X. Press ZOOM button a fourth time, the picture will return to normal size.

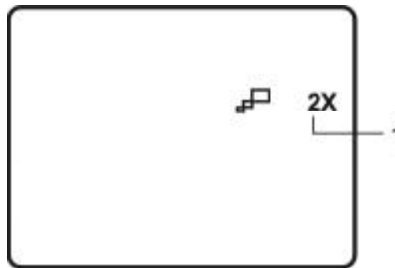

ZOOM Screen Display

5. Repeat

- a. During playback press REPEAT button once to repeatedly play the current chapter.

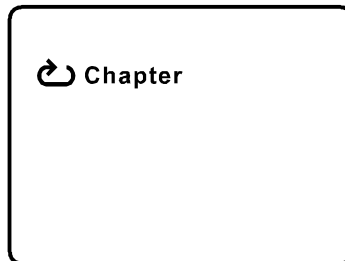

Chapter Repeat ON Screen Display

b. Press the REPEAT button again to repeatedly play the current title.

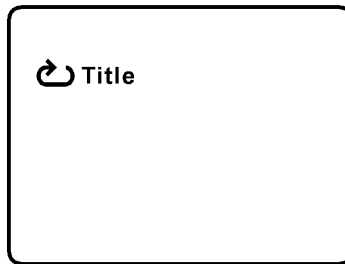

English

Title Repeat ON Screen Display

c. Press the REPEAT button a third time to repeat all chapters and titles.



All Repeat ON Screen Display

d. Press the REPEAT button a fourth time, to resume normal playback.

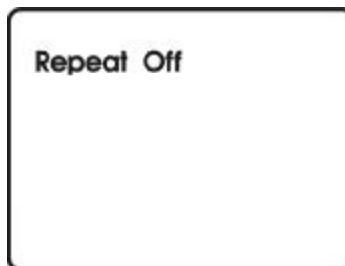

Repeat Off Screen Display

K. PLAYING AUDIO CDS

When a CD is Loaded into the unit, the Menu Screen will appear. You can use Up and DOWN button to choose the song you desired. Press OK to play.

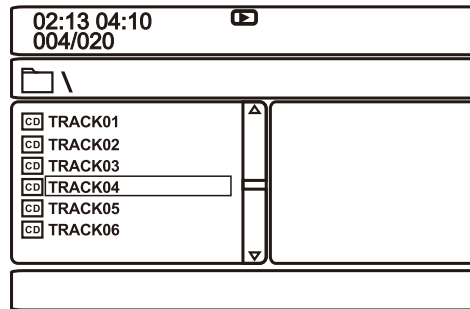

USING THE REPEAT FEATURE

The default mode for the Repeat feature is OFF. Pressing REPEAT consecutively changes the repeat options:

- *Repeat One* - repeats the track that is playing.
- *Repeat Folder* - repeats the disc that is playing.
- *Repeat Off*

As you toggle through the options, the repeat option changes. The selected repeat option loops repeatedly until you turn it off.

L. Playing JPEG Files

- 1) Load a JPEG disc onto the disc tray.
- 2) A screen showing folders or picture files contained on the disc will be displayed automatically after loading.
- 3) Press ▲, ▼ and OK button to select a folder or a picture. If a picture is selected, photo slideshow will start with the selected picture.
- 4) Press the ZOOM button to enlarge the picture size by 100%,125%, 150%,200%. When the image is enlarged, you can use the navigation buttons to view the blocked parts of the picture.
- 5) During photo slideshow or in slideshow PAUSE mode:
 - Press ◀ to rotate the picture counterclockwise by 90 degree.
 - Press ▼ to mirror the picture horizontally.
 - Press ▲ to mirror the picture vertically.
 - Press ▶ to rotate the picture clockwise by 90 degree.
 - Press ◀◀ or ▶▶ to view the previous / next photo.
- 6) Press ▶|| button then the slideshow will pause.
Press the button again to resume the slideshow playback.
- 7) Press MENU or ■ STOP to go to the folder where the picture is in.

M. Connecting to Other Equipment

1. AV Out

Connecting to a TV or Another Monitor (Refer to Figure 4)

1) Connect one end (1/8" stereo plug) of the audio cable (not supplied) into the unit's AUDIO OUT jack, and connect the other end (2 terminals, RCA jack) to the Left and Right channel input jacks on your TV or monitor. (white = left audio channel, red = right audio channel.)

2) Connect one end(1/8" plug) of the video cable (not supplied) into the unit's VIDEO OUT jack, and connect the other end (RCA jack) to the VIDEO INPUT jack on your TV or Monitor (yellow=video).

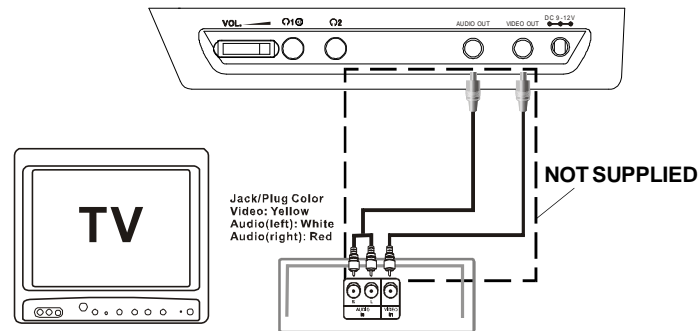

Figure 4

2. Connecting Headphones*

Simply plug the headphones into either Headphone jack 1 or Headphone jack 2 on the right side of the DVD Player.
(Refer to Figure 5)

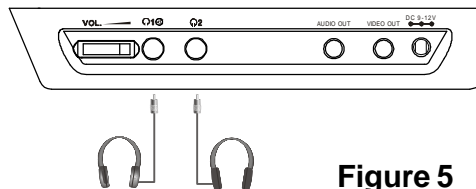

Figure 5

Plugging into Headphone jack 1 will disable the internal speakers.

* The headphones are only provided for D710PK, D7104PK.

N. Setup

Press SETUP button to display the Main screen of the SETUP Menu on the screen. Press SETUP button again to exit the SETUP Menu.

- 1) Press SETUP, the 'GENERAL SETUP PAGE' will display on the screen.



Main SETUP Menu Screen Display

- a) Select 'TV DISPLAY' using the DOWN button, and then press RIGHT to enter the submenu. Select the TV display mode on the screen using UP/DOWN, and press OK to confirm the setting. Press the LEFT button to exit the TV DISPLAY menu.

*NORMAL/PS: The wide-screen image will be displayed on the normal TV (4:3) in its native aspect ratio with some part on the left and right cut off.

*NORMAL/LB: The wide-screen image will be displayed on the normal TV (4:3) in its native aspect ratio with black bands on the upper and lower sections of the screen.

*WIDE: If the unit is connected to a wide-screen TV set, select this option. The widescreen image will be displayed in full screen in its native aspect ratio.

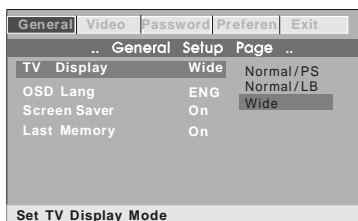

TV Display Screen Display

- b) Select 'OSD LANG' using the DOWN button, and then press the RIGHT button to enter the submenu. Choose the language you desire as the display language. Press the LEFT button to return.

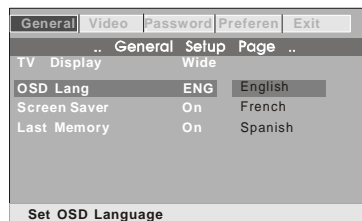

OSD Language Screen Display

- c) Select 'SCREEN SAVER' using the DOWN button. and then press the RIGHT button to enter the submenu. Choose Screen saver on or off using the UP/DOWN buttons and then press OK button to confirm the setting. Press the LEFT button to return.

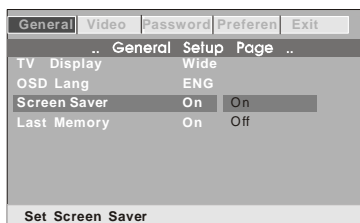

Screen Saver Screen Display

**ON: Enables screen saver.*

**OFF: Disables screen saver.*

NOTE: The DVD player will enter the Screen Saver mode after approximately five minutes if the same image remains on the screen.

- d) Select 'LAST MEMORY' by using the DOWN button. and then press the RIGHT button to enter the submenu. Choose Last Memory on or off using the UP/DOWN buttons and then press OK button to confirm the setting. Press the LEFT button to return.

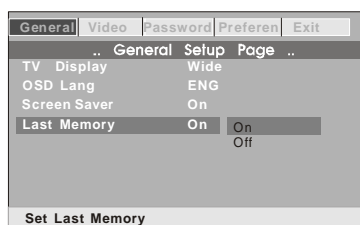

Last Memory Screen Display

**ON: During playback or in the pause mode, if you open the disc tray and then close without changing a disc, the unit will memorize the last playback status and resume playback from the memorized point.*

**OFF: The unit will not return to the last position on the disc.*

- 2) Select 'VIDEO SETUP PAGE' by using the LEFT/RIGHT buttons, press OK button to enter the VIDEO SETUP PAGE.

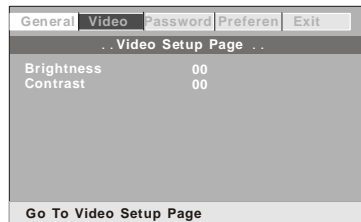

Video Setup Page Screen Display

- a) Select 'BRIGHTNESS' by using the UP or DOWN button, then press OK button. Adjust the Brightness by pressing the LEFT or RIGHT button. To exit Brightness Setting, press OK button again.

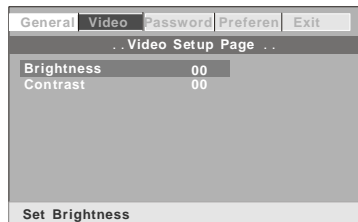

Brightness Screen Display

- b) Use the same way as setting BRIGHTNESS to set the other items on this menu. Press LEFT button to exit the VIDEO QUALITY SETUP menu.

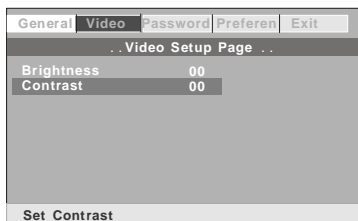

Contrast Screen Display

- 3) Select 'PASSWORD' using the LEFT or RIGHT buttons, then press the OK button to enter the submenu.

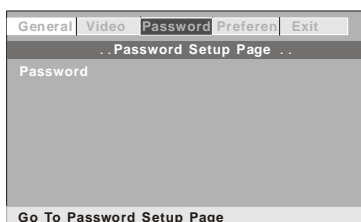

English

Password Setup Page Screen Display

Press OK button twice to enter the PASSWORD CHANGE PAGE. Input the Old Password or the Default Password, the New Password, and the Confirmed New Password. Press OK button to confirm the change.

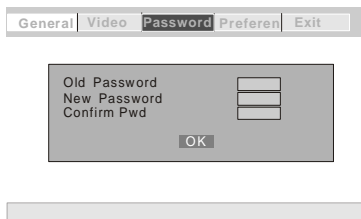

Password Change Page Screen Display

NOTE: The Default Password is LEFT,LEFT,RIGHT,RIGHT(◀◀▶▶). This password is always effective even after you have selected your own password and changed it. To avoid the possibility of others using the default password to set the parental level and change the password, you can record this default password in another area and delete it from this manual. Some discs can be limited depending on the age of users while some discs cannot. Only the LEFT or RIGHT Button (◀ or ▶ button) can be used to configure the password.

- 4) With no disc inside the player select 'PREFERENCE' using the LEFT or RIGHT button, then press OK button to enter the 'PREFERENCE PAGE'.

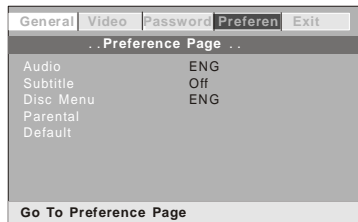

Preference Page Screen Display

- a) Select 'AUDIO' using the DOWN button, then press OK button to enter the submenu. Select the audio language you desire using the UP or DOWN buttons, then press OK button to confirm the setting. Press LEFT button to return.



Preferred Audio Language Screen Display

- b) Select 'SUBTITLE' using the DOWN button, then press OK button to enter the submenu. Select the desired subtitle language or OFF using the UP or DOWN buttons, then press OK to confirm the setting. Press LEFT to return.

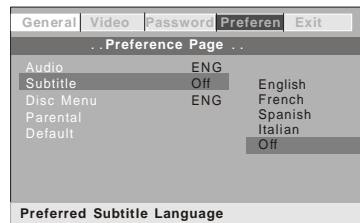

Preferred Subtitle Language

- c) Select 'DISC MENU' using the DOWN button, then press OK button to enter the submenu. Select the Disc Menu Language you desire using the UP or DOWN buttons, then press OK button to confirm the setting. Press LEFT to return.

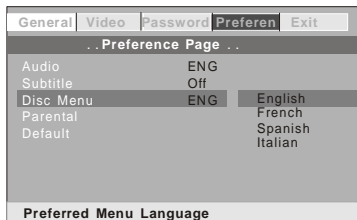

Preferred Disc Menu Language Screen Display

NOTE: Language and subtitle selection is only available for discs that are recorded in the above listed languages. If the selected language is not available, the player will play and display on the screen the original recorded language contained in the disc.

- d) Select 'PARENTAL' using the DOWN button, then press OK button to enter the submenu.

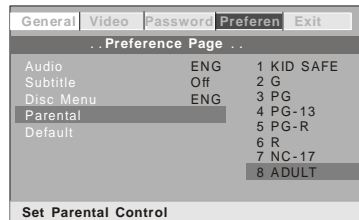

Parental Preference Screen Display

Select the parental level you desire using the UP or DOWN button for discs with lock-out function or multiple rating levels. These are listed from the lowest level (1 KID SAFE) to the highest level (8 ADULT). Enter a 4 digit password, then press OK button to confirm the parental level setting.

NOTE: The level of 8 ADULT is the factory default.

- e) Select 'DEFAULT' using the DOWN button, then press ENTER button to enter the submenu. Press OK button to make the setting return to the factory default mode.

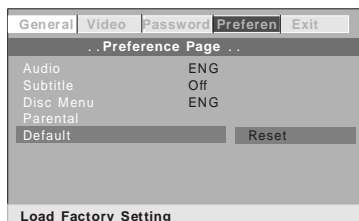

Load Factory Setting Screen Display

NOTE: The parental setting is not affected by the default reset function.

O. Specifications

Compatible DISC: DVD, CD, CD-R, CD-RW, DVD+/-R, DVD+/-RW

Signal system: NTSC

Panel size: 7 inch

Frequency response: 20 Hz to 20 kHz

Video output: 1 V_{p-p}/75 Ohm, unbalanced

Audio output: 1.4V_{rms}/10kOhm

Audio S/N: Better than 60 dB

Dynamic range : Better than 85 dB

Laser: Semiconductor Laser, Wave Length: 650 nm/795 nm

Power source: DC 9-12V

Power consumption: 7W

Operating temperature: 41~95°F (5~35°C)

Weight : 1.65 lbs (0.75 kg)

Dimensions (W x D x H): 8.19 X 6.14 X1.57 inches
(208 x 156 x 40 mm)

Built in lithium polymer battery: 7.4V,1300mAh for D710/D710PK;
7.4V, 2300mAh for D7104/D7104PK

P. Rechargeable Built-in Battery Use

The DVD player utilizes a long-life Li-Polymer battery for portability. Li-Polymer batteries feature high storage capacity and low level of degradation. This means the Li-Polymer batteries do not have “Memory Effect” and thus can be recharged regardless of whether the battery is fully or only partially discharged. **The battery must be charged at least 8 hours prior to first use.**

NOTE: If you plan not to use the battery for an extended period of time (one week or longer), we recommend that you fully charge the battery. For longer periods of storage, please recharge the battery at least once every two months to maintain the battery in optimum condition.

Each full recharge takes approximately five hours.

During recharge, the red indicator will stay on. Once fully recharged, the red light will turn off. At this point you may remove the wall plug and stop charging.

Precautions Related to Battery Recharge:

1. The DVD player must be set to power off.
2. Once the battery is fully discharged, immediately recharge (regardless of whether you plan to use battery or not) in order to maximize battery life.
3. To charge the battery, please connect the power jack directly into the DVD Player and leave connected until the red charge indicator turns off.

Using and Maintaining Your Rechargeable Batteries

1. Please make sure you always use **only** the AC adapter included with the player to recharge your battery. The battery can only be charged with the AC adaptor and will **NOT** charge with the car DC adaptor.
2. Recharge efficiency will degrade when environmental temperatures drop below 41°F (5°C) or exceed 95°F (35°C).
3. Do not leave the DVD player in a hot automobile or temperatures exceeding 122°F (50°C). Permanent battery damage, fire, or explosion may result.

Q. Troubleshooting

PROBLEM	SOLUTION
No sound or distorted sound	<ul style="list-style-type: none"> • Make sure the DVD player is connected properly. Make sure all cables are securely inserted into the appropriate jacks.
Can't advance through a movie	<ul style="list-style-type: none"> • You can't advance through the opening credits and warning information that appears at the beginning of movies because the disc is programmed to prohibit that action.
The icon (⏮) appears on screen	<p>The feature or action cannot be completed at this time because:</p> <ol style="list-style-type: none"> 1. The disc's software restricts it. 2. The disc's software doesn't support the feature (e.g., angles) 3. The feature is not available at the moment. 4. You've requested a title or chapter number that is out of range.
Picture is distorted	<ul style="list-style-type: none"> • The disc might be damaged. Try another disc. • It is normal for some distortion to appear during forward or reverse scan.
No forward or reverse scan	<ul style="list-style-type: none"> • Some discs have sections that prohibit rapid scanning or title and chapter skip. • You will not be able to skip through the warning information and credits at the beginning of a movie. This part of the movie is often programmed to prohibit skipping through it.

Troubleshooting (Cont)

PROBLEM	SOLUTION
Disc won't play	<ul style="list-style-type: none">• Check the type of disc you put into disc tray. This DVD player only plays DVDs and audio CDs.
Play starts, but then stops immediately	<ul style="list-style-type: none">• Your DVD player has been designed to process regional management information that is stored on DVD discs. The regional code for your player is 1 (The U.S., U.S. Territories and Canada). Only DVD discs that have regional codes of 1 or ALL (for all regions) can be played by your player.• The disc is dirty. Clean it.• Condensation has formed. Allow player to dry out.
Disc stops playing after the unit is bumped	<ul style="list-style-type: none">• Remove the disc. Go to the Setup menu and set Last Memory to "OFF". Replace disc.

The descriptions and characteristics in this owner's manual are for the purpose of general reference only and not as a guarantee. In order to provide you with the highest quality product, we may make changes or modifications without prior notice. The English version serves as the final reference on all product and operation details should any discrepancies arise in other languages.



AUDIOVOX
ELECTRONICS CORP.

90 DAY LIMITED WARRANTY

Applies to Audiovox Video Products

AUDIOVOX ELECTRONICS CORP. (the Company) warrants to the original retail purchaser of this product that should this product or any part thereof, under normal use and conditions, be proven defective in material or workmanship within ninety (90) days from the date of original purchase, such defect(s) will be repaired or replaced with reconditioned product (at the Company's option) without charge for parts and repair labor. A game controller, if supplied, is similarly warranted for ninety (90) days.

To obtain repair or replacement within the terms of this Warranty, the product is to be delivered with proof of warranty coverage (e.g. dated bill of sale), specification of defect(s), transportation prepaid, to the Company at the address shown below.

This Warranty does not extend to the elimination of externally generated static or noise, to correction of antenna problems, to costs incurred for installation, removal or reinstallation of the product, or to damage to digital memory/media devices, gaming devices, discs, speakers, accessories, or electrical systems.

This Warranty does not apply to any product or part thereof which, in the opinion of the Company, has suffered or been damaged through alteration, improper installation, mishandling, misuse, neglect, accident, or by removal or defacement of the factory serial number/bar code label(s). THE EXTENT OF THE COMPANY'S LIABILITY UNDER THIS WARRANTY IS LIMITED TO THE REPAIR OR REPLACEMENT PROVIDED ABOVE AND, IN NO EVENT, SHALL THE COMPANY'S LIABILITY EXCEED THE PURCHASE PRICE PAID BY PURCHASER FOR THE PRODUCT.

This Warranty is in lieu of all other express warranties or liabilities. ANY IMPLIED WARRANTIES, INCLUDING ANY IMPLIED WARRANTY OF MERCHANTABILITY, SHALL BE LIMITED TO THE DURATION OF THIS WRITTEN WARRANTY. ANY ACTION FOR BREACH OF ANY WARRANTY HEREUNDER INCLUDING ANY IMPLIED WARRANTY OF MERCHANTABILITY MUST BE BROUGHT WITHIN A PERIOD OF 12 MONTHS FROM DATE OF ORIGINAL PURCHASE. IN NO CASE SHALL THE COMPANY BE LIABLE FOR ANY CONSEQUENTIAL OR INCIDENTAL DAMAGES FOR BREACH OF THIS OR ANY OTHER WARRANTY. No person or representative is authorized to assume for the Company any liability other than expressed herein in connection with the sale of this product.

Some states do not allow limitations on how long an implied warranty lasts or the exclusion or limitation of incidental or consequential damage so the above limitations or exclusions may not apply to you. This Warranty gives you specific legal rights and you may also have other rights which vary from state to state.

Audiovox Electronics Corporation, 150 Marcus Blvd., Hauppauge, New York 11788 • 1-800-645-4994

128-5556G

English

Free Manuals Download Website

<http://myh66.com>

<http://usermanuals.us>

<http://www.somanuals.com>

<http://www.4manuals.cc>

<http://www.manual-lib.com>

<http://www.404manual.com>

<http://www.luxmanual.com>

<http://aubethermostatmanual.com>

Golf course search by state

<http://golfingnear.com>

Email search by domain

<http://emailbydomain.com>

Auto manuals search

<http://auto.somanuals.com>

TV manuals search

<http://tv.somanuals.com>