

BenQ

SP920P Digital Projector

User Manual

Welcome

Table of contents

Important safety instructions 3

Introduction 6

Projector features.....	6
Shipping contents	7
Projector exterior view	8
Controls and functions.....	9
Projector	9
Remote control.....	10

Positioning your projector..... 12

Choosing a location	12
Obtaining a preferred projected image size	13

Connection 16

Connecting a computer or monitor.....	16
Connecting Video source devices	18

Operation..... 23

Starting up the projector	23
Using the On-Screen Display (OSD) menus	24
Securing the projector	24
Using a security cable lock.....	24
Utilizing the password function	25
Switching input signal	27
Adjusting the projected image	28
Adjusting the projection angle.....	28
Auto-adjusting the image	28
Fine-tuning the image size and clarity .	28
Correcting keystone	29
Magnifying and searching for details.....	29
Selecting the aspect ratio	30
Optimizing the image.....	31
Using Wall Color.....	31
Selecting a picture mode	31
Fine-tuning the image quality in user modes	32

Setting the presentation timer	34
Remote paging operations	35
Hiding the image	36
Freezing the image.....	36
Utilizing FAQ function	36
Locking control keys.....	37
Operating in a high altitude environment	37
Creating your own startup screen	38
Adjusting the sound	38
Setting the lamp mode	39
Personalizing the On-Screen Display (OSD) menus	39
Shutting down the projector	40
On-Screen Display (OSD) Menus.....	41
Menu structure	41
Description of each menu	43

Maintenance 46

Care of the projector	46
Lamp information	46
Replacing the lamp	48
Indicators	50

Troubleshooting 51

Specifications 52

Projector specifications	52
Dimensions	52
Timing chart	53

Other information 55

Warranty and Copyright information.....	55
Regulation statements	55

Thank you for your purchase of this quality BenQ projector! It has been designed to provide you with an enjoyable viewing experience in various situations. For the best results, please read this manual through carefully as it is your guide through the control menus and operation.

Important safety instructions

Your projector is designed and tested to meet the latest standards for safety of information technology equipment. However, to ensure safe use of this product, it is important that you follow the instructions mentioned in this manual and marked on the product.

1. Please read this manual before you operate your projector. Save it for future reference.

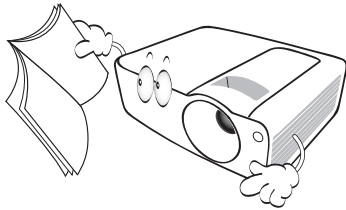

2. Do not look straight at the projector lens during operation. The intense light beam may damage your eyes.

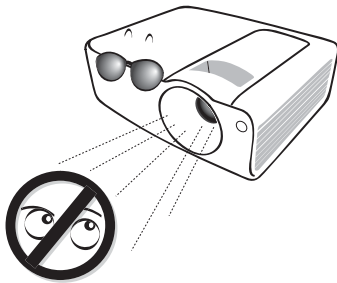

3. Refer servicing to qualified service personnel.

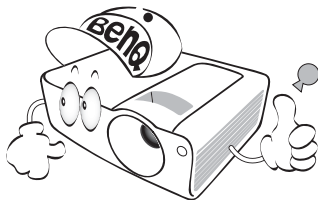

4. Do not place this projector in any of the following environments.

- Space that is poorly ventilated or confined. Allow at least 50 cm clearance from walls and free flow of air around the projector.
- Locations where temperatures may become excessively high, such as the inside of a car with all windows rolled up.
- Locations where excessive humidity, dust, or cigarette smoke may contaminate optical components, shortening the projector's life span and darkening the image.

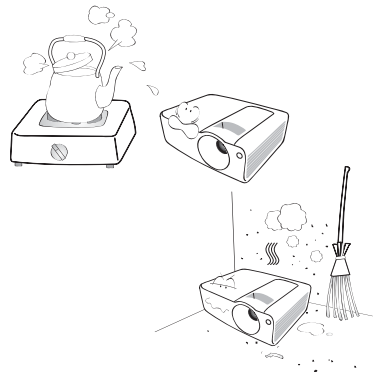

- Locations near fire alarms
- Locations with an ambient temperature above 40°C / 104°F
- Locations where the altitudes are higher than 3000 m (10000 feet)

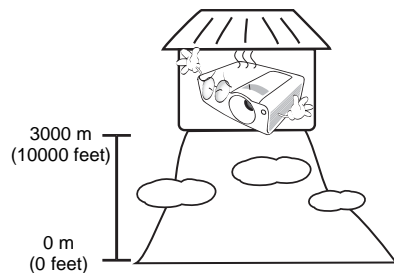

5. In areas where the mains voltage may fluctuate or cut out, it is recommended that you connect your projector through a power stabilizer, surge protector or uninterruptible power supply (UPS).

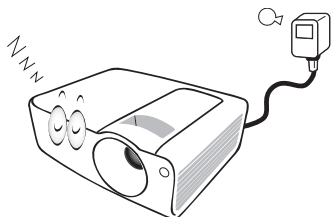

6. The lamp becomes extremely hot during operation. Allow the projector to cool for approximately 45 minutes prior to removing the lamp assembly for replacement.

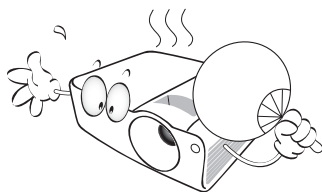

7. Do not operate lamps beyond the rated lamp life. Excessive operation of lamps beyond the rated life could cause them to break on rare occasions.

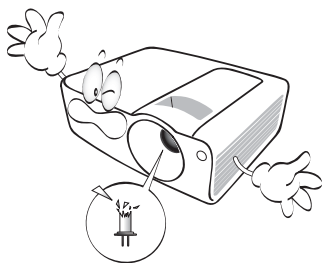

8. Never replace the lamp assembly or any electronic components unless the projector is unplugged.

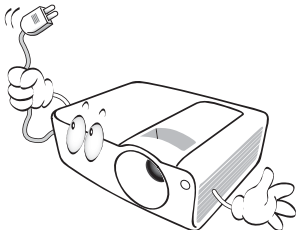

9. Do not attempt to disassemble this projector. There are dangerous high voltages inside which may cause death if you should come into contact with live parts. The only user serviceable part is the lamp which has its own removable cover. Under no circumstances should you ever undo or remove any other covers. Refer servicing only to suitably qualified professional service personnel.

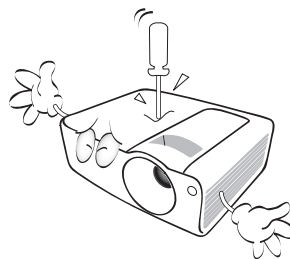

10. Do not step on the projector or place any objects upon it. Besides probable physical damage to the projector, doing so may result in accidents and possible injury.



11. Do not block the ventilation holes.
- Do not place this projector on a blanket, bedding or any other soft surface.
 - Do not cover this projector with a cloth or any other item.
 - Do not place inflammables near the projector.

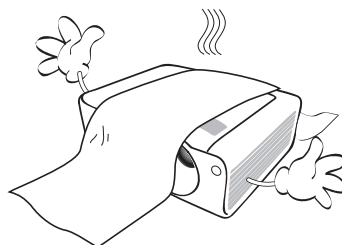

12. Always place the projector on a level, horizontal surface during operation.
- Do not use if tilted at an angle of more than 10 degrees left to right, nor at angle of more than 15 degrees front to back. Using the projector when it is not fully horizontal may cause a malfunction of, or damage to, the lamp.

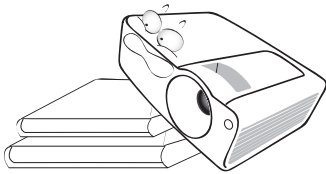

13. Do not stand the projector on end vertically. Doing so may cause the projector to fall over, causing injury or resulting in damage to the projector.

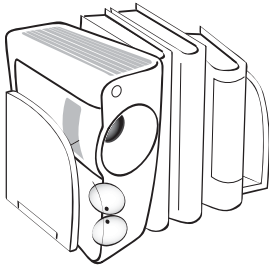

14. This product is capable of displaying inverted images for ceiling mount installation.



Use only BenQ's ceiling mount kit for mounting the projector and ensure it is securely installed.

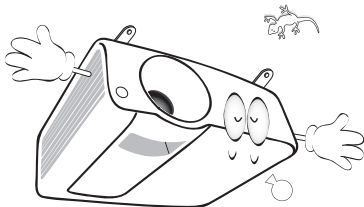

15. When the projector is under operation, you may sense some heated air and odor from its ventilation grill. It is a normal phenomenon and not a product defect.
16. Do not block the projection lens with any objects when the projector is under operation as this could cause the objects to become heated and deformed or even cause a fire. To temporarily turn off the lamp, press **BLANK** on the projector or remote control.

17. Do not place liquids near or on the projector. Liquids spilled into the projector may cause it to fail. If the projector does become wet, disconnect it from the power supply's wall socket and call BenQ to have the projector serviced.

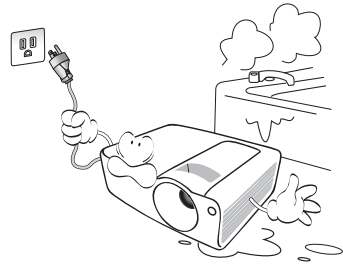

Ceiling mounting the projector

We want you to have a pleasant experience using your BenQ projector, so we need to bring this safety matter to your attention to prevent possible damage to person and property.

If you intend to mount your projector on the ceiling, we strongly recommend that you use a proper fitting BenQ projector ceiling mount kit and that you ensure it is securely and safely installed.

If you use a non-BenQ brand projector ceiling mount kit, there is a safety risk that the projector may fall from the ceiling due to an improper attachment through the use of the wrong gauge or length screws.

You can purchase a BenQ projector ceiling mount kit from the place you purchased your BenQ projector. BenQ recommends that you also purchase a separate Kensington lock compatible security cable and attach it securely to both the Kensington lock slot on the projector and the base of the ceiling mount bracket. This will perform the secondary role of restraining the projector should its attachment to the mounting bracket become loose.

Introduction

Projector features

The projector integrates high-performance optical engine projection and a user-friendly design to deliver high reliability and ease of use.

The projector offers the following features.

- Selectable dual-lamp projection capable of displaying super-bright images
 - Wall color correction allowing projection on surfaces of several predefined colors
 - Quick auto search speeding up the signal detecting process
 - Selectable password protected function
 - Up to 11 sets of picture modes providing multiple choices for different projection purposes
 - 3D color management allowing color adjustments to your liking
 - Splash Screen lock to prevent unauthorized use
 - Selectable quick cooling function makes the projector cool in a shorter time
 - FAQ to troubleshoot operational problems with one quick key press
 - Presentation timer for a better control of time during presentations
 - High quality manual zoom lens
 - One-key auto-adjustment to display the best picture quality
 - Digital keystone correction to correct distorted images
 - Adjustable color balance control for data/video display
 - High brightness projection lamp
 - Ability to display 16.7 million colors
 - Multi-language On-Screen Display (OSD) menus
 - Built-in speakers provide mixed mono audio when an audio input is connected
 - Powerful AV function to provide high quality video image
 - Component HDTV compatibility (YPbPr)
 - HDCP compatibility
 - HDMI 1.3 compatibility
-  • **The apparent brightness of the projected image will vary depending on the ambient lighting conditions, selected input signal contrast/brightness settings, and is directly proportional to projection distance.**
- **The lamp brightness will decline over time and may vary within the lamp manufacturers specifications. This is normal and expected behavior.**

Shipping contents

Carefully unpack and verify that you have all of the items shown below. If any of these items are missing, please contact your place of purchase.

Standard accessories

 The supplied accessories will be suitable for your region, and may differ from those illustrated.

*The warranty card is only supplied in some specific regions. Please consult your dealer for detailed information.

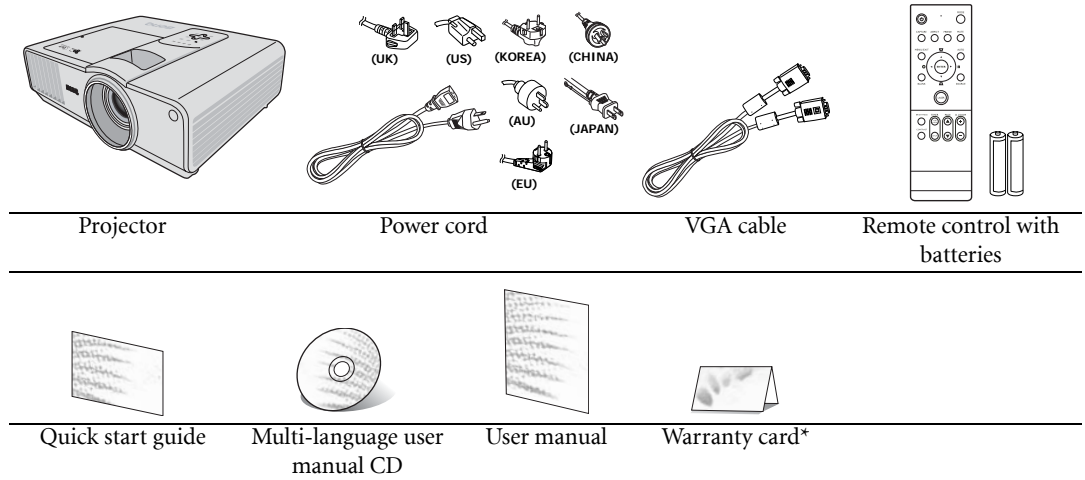

Optional accessories

If you need to purchase the accessories listed below, please also contact your local dealer.

- | | |
|----------------------|----------------------|
| 1. Spare lamp kit | 3. Presentation Plus |
| 2. Ceiling mount kit | 4. RS232 cable |

Installing or replacing the remote control batteries

- To open the battery cover, turn the remote control over to view its back, push on the finger grip on the cover and slide it up in the direction of the arrow as illustrated. The cover will slide off.
- Remove any existing batteries (if necessary) and install two AAA batteries observing the battery polarities as indicated in the base of the battery compartment. Positive (+) goes to positive and negative (-) goes to negative.
- Refit the cover by aligning it with the base and sliding it back down into position. Stop when it clicks into place.

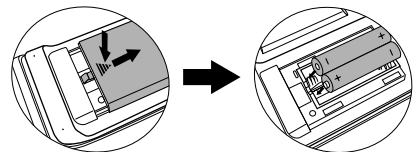

-  **Avoid leaving the remote control and batteries in an excessive heat or humid environment like the kitchen, bathroom, sauna, sunroom or in a closed car.**
- Replace only with the same or equivalent type recommended by the battery manufacturer.**
- Dispose of the used batteries according to the manufacturer's instructions and local environment regulations for your region.**
- Never throw the batteries into a fire. There may be danger of an explosion.**
- If the batteries are dead or if you will not be using the remote control for an extended period of time, remove the batteries to avoid damage to the remote control from possible battery leakage.**

Projector exterior view

Front/upper side

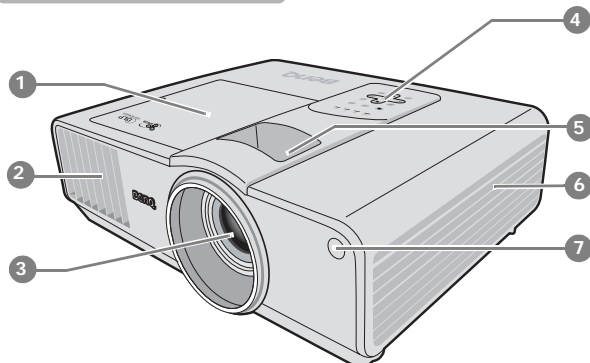

Rear/lower side

See "Connection" on page 16 for connection details.

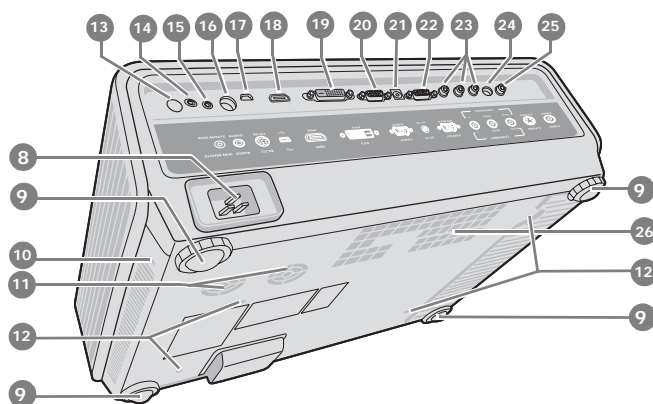

1. Lamp cover
2. Vent (heated air exhaust)
3. Projection lens
4. External control panel
(See page 9 for details.)
5. Focus ring and Zoom ring
(See page 9 for details.)
6. Vent (cool air intake)
7. Front IR remote sensor
8. AC power cord inlet
9. Adjuster feet
10. Kensington anti-theft lock slot
11. Speaker grill
12. Ceiling mount holes
13. Rear IR remote sensor
14. Wired remote control port
15. Audio signal input socket
16. RS232 control port
17. USB socket
18. HDMI port
19. DVI-D signal input socket
20. RGB (PC)/Component Video
(YPbPr/ YCbCr) signal input
socket
21. DC 12V output terminal
Used to trigger external devices
such as an electric screen or light
control, etc. Consult your dealer
for how to connect these devices.
22. RGB signal output socket
23. Component Video (YPbPr/
YCbCr) signal input sockets
24. S-Video signal input socket
25. Composite Video signal input
socket
26. Vent (heated air exhaust)

Controls and functions

Projector

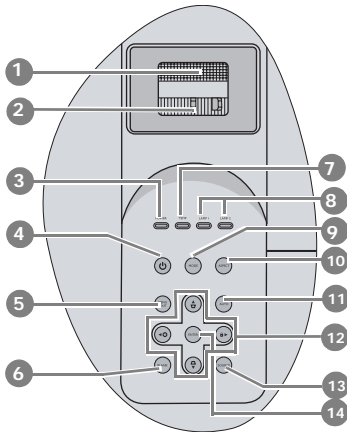

1. **Focus ring**
Adjusts the focus of the projected picture. See ["Fine-tuning the image size and clarity" on page 28](#) for details.
2. **Zoom ring**
Adjusts the size of the projected picture. See ["Fine-tuning the image size and clarity" on page 28](#) for details.
3. **POWER indicator light**
Lights up or flashes when the projector is under operation. See ["Indicators" on page 50](#) for details.
4. **Power**
Toggles the projector between standby mode and on. See ["Starting up the projector" on page 23](#) and ["Shutting down the projector" on page 40](#) for details.
5. **MENU/EXIT**
Turns on the On-Screen Display (OSD) menu. When the OSD menu is activated, exits and saves the menu settings. See ["Using the On-Screen Display \(OSD\) menus" on page 24](#) for details.
6. **BLANK**
Used to hide the screen picture. See ["Hiding the image" on page 36](#) for details.
7. **TEMPERature indicator light**
Lights up if the projector's temperature becomes too high. See ["Indicators" on page 50](#) for details.
8. **LAMP indicator light**
Indicates the status of the lamp. Lights up when the lamp has developed a problem. See ["Indicators" on page 50](#) for details.
9. **MODE**
Depending upon which input signal is selected, selects an available picture setup mode. See ["Selecting a picture mode" on page 31](#) for details.
10. **ASPECT**
Selects the display aspect ratio. See ["Selecting the aspect ratio" on page 30](#) for details.
11. **AUTO**
Automatically determines the best picture timings for the displayed picture. See ["Auto-adjusting the image" on page 28](#) for details.
12. **Keystone/Arrow keys** (◁ / ▲ Up, ▷ / ▼ Down)
Manually corrects distorted images resulting from an angled projection. See ["Correcting keystone" on page 29](#) for details.
◀ Left/ ?
Starts the FAQ function. See ["Utilizing FAQ function" on page 36](#) for details.
▶ Right/ 🔒
Locks the keys on the projector. See ["Locking control keys" on page 37](#) for details.
When the On-Screen Display (OSD) menu is activated, the arrow keys are used as directional arrows to select the desired menu items and to make adjustments. See ["Using the On-Screen Display \(OSD\) menus" on page 24](#) for details.
13. **SOURCE**
Displays the source selection bar. See ["Switching input signal" on page 27](#) for details.
14. **ENTER**
Enacts the selected On-Screen Display (OSD) menu item. See ["Using the On-Screen Display \(OSD\) menus" on page 24](#) for details.

Remote control

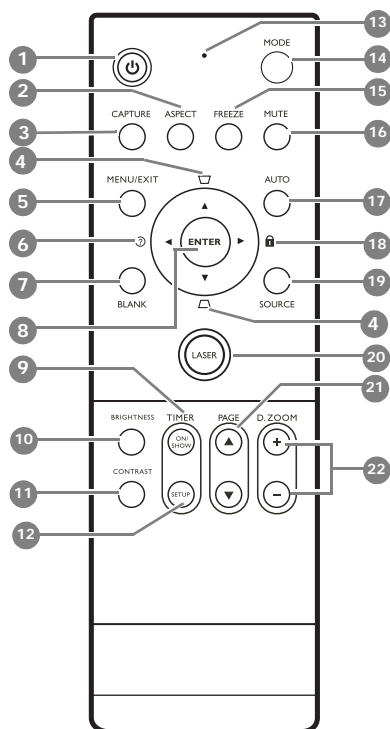

1. **Power**
Toggles the projector between standby mode and on. See ["Starting up the projector" on page 23](#) and ["Shutting down the projector" on page 40](#) for details.
2. **ASPECT**
Selects the display aspect ratio. See ["Selecting the aspect ratio" on page 30](#) for details.
3. **CAPTURE**
Captures the projected picture and save it as your startup screen. See ["Creating your own startup screen" on page 38](#) for details.
4. **Keystone/Arrow keys** (◓ / ▲ Up, ◓ / ▼ Down)
Manually corrects distorted images resulting from an angled projection. See ["Correcting keystone" on page 29](#) for details.
5. **MENU/EXIT**
Turns on the On-Screen Display (OSD) menu. When the OSD menu is activated, exits and saves the menu settings. See ["Using the On-Screen Display \(OSD\) menus" on page 24](#) for details.
6. **◀ Left/ ?**
Starts the FAQ function. See ["Utilizing FAQ function" on page 36](#) for details.
7. **BLANK**
Used to hide the screen picture. See ["Hiding the image" on page 36](#) for details.
8. **ENTER**
Enacts the selected On-Screen Display (OSD) menu item. See ["Using the On-Screen Display \(OSD\) menus" on page 24](#) for details.
9. **TIMER ON/SHOW**
Activates or displays an on-screen timer based on your own timer setting. See ["Setting the presentation timer" on page 34](#) for details.
10. **BRIGHTNESS**
Displays the **BRIGHTNESS** adjustment bar. See ["Adjusting Brightness" on page 32](#) for details.
11. **CONTRAST**
Displays the **CONTRAST** adjustment bar. See ["Adjusting Contrast" on page 32](#) for details.
12. **TIMER SETUP**
Enters presentation timer setting directly. See ["Setting the presentation timer" on page 34](#) for details.
13. **Indicator light**
Flashes or lights red when any key on the remote control is pressed.
14. **MODE**
Depending upon which input signal is selected, selects an available picture mode. See ["Selecting a picture mode" on page 31](#) for details.
15. **FREEZE**
Freezes the projected picture. See ["Freezing the image" on page 36](#) for details.
16. **MUTE**
Toggles projector audio between on and off. See ["Muting the sound" on page 38](#) for details.
17. **AUTO**
Automatically determines the best picture timings for the displayed picture. See ["Auto-adjusting the image" on page 28](#) for details.

18. ► Right/🔒

Locks the keys on the projector. See "[Locking control keys](#)" on page 37 for details.

When the On-Screen Display (OSD) menu is activated, the #4, #6 and #18 keys are used as directional arrows to select the desired menu items and to make adjustments. See "[Using the On-Screen Display \(OSD\) menus](#)" on page 24 for details.

19. SOURCE

Displays the source selection bar. See "[Switching input signal](#)" on page 27 for details.

20. LASER

Emits visible laser pointer light for presentation purposes. See "[Operating the LASER pointer](#)" on page 11 for details.

21. PAGE ▲/▼

Operate your display software program (on a connected PC) which responds to page up/down commands (like Microsoft PowerPoint). See "[Remote paging operations](#)" on page 35 for details.

22. D. ZOOM (+, -)

Magnifies or reduces the projected image size. See "[Magnifying and searching for details](#)" on page 29 for details.

Operating the LASER pointer

The **LASER** Pointer is a presentation aid for professionals. It emits red colored light when you press it and the indicator lights up red.

The laser beam is visible. It is necessary to press and hold **LASER** for continuous output.

Avoid Exposure
Laser radiation is emitted from this aperture

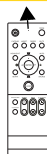

Do not look into the laser light window or shine the laser light beam on yourself or others. See the warning messages on the back of the remote control prior to using it.

The laser pointer is not a toy. Parents should be mindful of the dangers of laser energy and keep this remote control out of the reach of children.

Remote control effective range

Infra-Red (IR) remote control sensors are located on the front and the back of the projector. The remote control must be held at an angle within 30 degrees perpendicular to the projector's IR remote control sensors to function correctly. The distance between the remote control and the sensors should not exceed 8 meters (~ 26 feet).

Make sure that there are no obstacles between the remote control and the IR sensors on the projector that might obstruct the infra-red beam.

- **Operating the projector from the front**

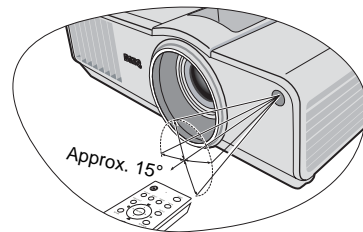

- **Operating the projector from the rear**

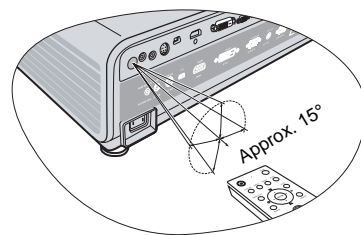

Making the remote control a wired control

The remote control is equipped with a jack on the top allowing connection to the projector with a 2.5mm mini jack cable available in the market. This helps you easily locate the remote control when needed as it is connected to the projector and within the distance no greater than the cable's length.

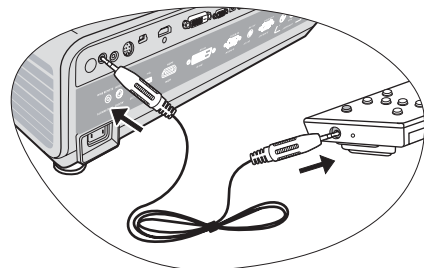

Positioning your projector

Choosing a location

Your room layout or personal preference will dictate which installation location you select. Take into consideration the size and position of your screen, the location of a suitable power outlet, as well as the location and distance between the projector and the rest of your equipment.

Your projector is designed to be installed in one of four possible installation locations:

1. Front Table

Select this location with the projector placed near the floor in front of the screen. This is the most common way to position the projector for quick setup and portability.

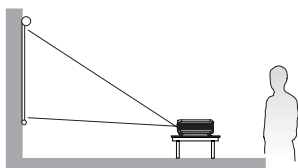

2. Front Ceiling

Select this location with the projector suspended upside-down from the ceiling in front of the screen. Purchase the BenQ projector ceiling mount kit from your dealer to mount your projector on the ceiling.

*Set **Front Ceiling** after you turn the projector on.

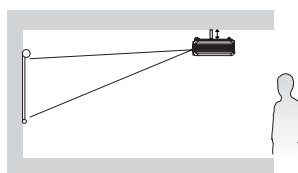

3. Rear Table

Select this location with the projector placed near the floor behind the screen.

Note that a special rear projection screen is required.

*Set **Rear Table** after you turn the projector on.

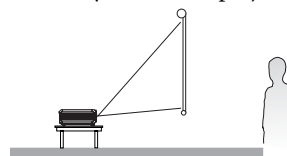

4. Rear Ceiling

Select this location with the projector suspended upside-down from the ceiling behind the screen.

Note that a special rear projection screen and the BenQ projector ceiling mount kit are required for this installation location.

*Set **Rear Ceiling** after you turn the projector on.

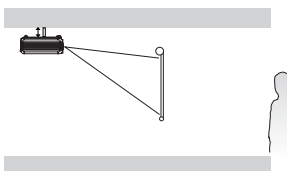

*To set the projector position:

1. Press **MENU/EXIT** on the projector or remote control and then press **◀/▶** until the **SYSTEM SETUP: Basic** menu is highlighted.
2. Press **▲/▼** to highlight **Projector Position** and press **◀/▶** until the correct position is selected.

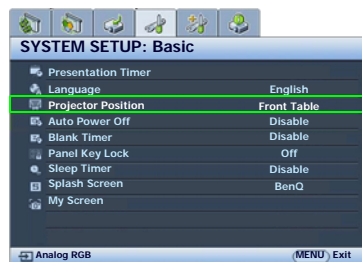

Obtaining a preferred projected image size

The distance from the projector lens to the screen, the zoom setting, and the video format each factors in the projected image size.

4:3 is the native aspect ratio of this projector. To be able to project a complete 16:9 (widescreen) aspect ratio image, the projector can resize and scale a widescreen image to the projector's native aspect width. This will result in a proportionally smaller height equivalent to 75% of the projector's native aspect height.

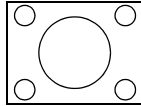

4:3 aspect image in a 4:3 aspect display area

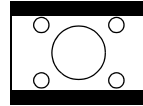

16:9 aspect image scaled to a 4:3 aspect display area

Thus, a 16:9 aspect image will not utilize 25% of the height of a 4:3 aspect image displayed by this projector. This will be seen as darkened (unlit) bars along the top and bottom (vertical 12.5% height respectively) of the 4:3 projection display area whenever displaying a scaled 16:9 aspect image in the vertical center of the 4:3 projection display area.

The projector should always be placed horizontally level (like flat on a table), and positioned directly perpendicular (90° right-angle square) to the horizontal center of the screen. This prevents image distortion caused by angled projections (or projecting onto angled surfaces).

The modern digital projector does not project directly forward (like older style reel-to-reel film projectors did). Instead, digital projectors are designed to project at a slightly upward angle above the horizontal plane of the projector. This is so that they can be readily placed on a table and will project forward and upwards onto a screen positioned so that the bottom edge of the screen is above the level of the table (and everyone in the room can see the screen).

If the projector is mounted on a ceiling, it must be mounted upside-down so that it projects at a slightly downward angle.

You can see from the diagram on page 15, that this type of projection causes the bottom edge of the projected image to be vertically offset from the horizontal plane of the projector. When ceiling mounted, this refers to the top edge of the projected image.

If the projector is positioned further away from the screen, the projected image size increases, and the vertical offset also increases proportionately.

When determining the position of the screen and projector, you will need to account for both the projected image size and the vertical offset dimension, which are directly proportional to the projection distance.

BenQ has provided a table of 4:3-aspect-ratio screen sizes to assist you in determining the ideal location for your projector. There are two dimensions to consider, the perpendicular horizontal distance from the center of the screen (projection distance), and the vertical offset height of the projector from the horizontal edge of the screen (offset).

How to determine the position of the projector for a given screen size

1. Select your screen size.
2. Refer to the table and find the closest match to your screen size in the left columns labelled "[4:3 screen diagonal](#)". Using this value, look across this row to the right to find the corresponding average distance from screen value in the column labelled "[Average](#)". This is the projection distance.
3. On that same row, look across to the right column and make note of the "[Vertical offset in mm](#)" value. This will determine the final vertical offset placement of the projector in relation to the edge of the screen.
4. The recommended position for the projector is aligned perpendicular to the horizontal center of the screen, at the distance from the screen determined in step 2 above, and offset by the value determined in step 3 above.

For example, if you are using a 120-inch screen, the average projection distance is 4416 mm and with a vertical offset of 210 mm.

If you place the projector in a different position (to that recommended), you will have to tilt it down or up to center the image on the screen. In these situations, some image distortion will occur. Use the Keystone function to correct the distortion. See "[Correcting keystone](#)" on [page 29](#) for details.

How to determine the recommended screen size for a given distance

This method can be used for situations where you have purchased this projector and would like to know what screen size will fit in your room.

The maximum screen size is limited by the physical space available in your room.

1. Measure the distance between the projector and where you want to position the screen. This is the projection distance.
2. Refer to the table and find the closest match to your measurement in the average distance from screen column labelled "[Average](#)". Check that your measured distance is between the min and max distances listed on either side of the average distance value.
3. Using this value, look across that row to the left to find the corresponding screen diagonal listed in that row. That is the projected image size of the projector at that projection distance.
4. On that same row, look across to the right column and make note of the "[Vertical offset in mm](#)" value. This will determine the final placement of the screen in relation to the horizontal plane of the projector.

For example, if your measured projection distance was 4.5 m (4500 mm), the closest match in the "[Average](#)" column is 4416 mm. Looking across this row shows that a 120-inch screen is required. If you can only obtain metric sized screens, the listed screen sizes on either side of the 120-inch screen are the 3.0 m (3000 mm) and 3.5 m (3500 mm) screens.

Checking the min and max projection distance values for these screen sizes, indicates that the 4.5 m measured projection distance will also fit the 3.0 m (3000 mm) size screen. Be aware that these different screens have different vertical offset values.

 **There is 3% tolerance among these numbers due to optical component variations. BenQ recommends that if you intend to permanently install the projector, you should physically test the projection size and distance using the actual projector in situ before you permanently install it, so as to make allowance for this projector's optical characteristics. This will help you determine the exact mounting position so that it best suits your installation location.**

Projection dimensions

Refer to "Dimensions" on page 52 for the center of lens dimensions of this projector before calculating the appropriate position.

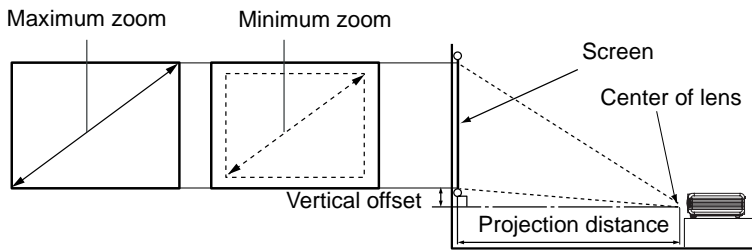

4:3 screen diagonal			Distance from screen in mm			Vertical offset in mm
Feet	Inches	mm	Min length (with max. zoom)	Average	Max length (with min. zoom)	
4.0	48	1219	1635	1766	1897	84
	59	1500	2012	2173	2334	104
5.0	60	1524	2044	2208	2371	105
	6.0	1829	2453	2649	2846	126
6.0	79	2000	2683	2897	3112	138
	7.0	2134	2862	3091	3320	147
8.0	96	2438	3271	3533	3794	168
	98	2500	3353	3622	3890	173
9.0	108	2743	3680	3974	4268	189
	118	3000	4024	4346	4668	207
10.0	120	3048	4089	4416	4743	210
	138	3500	4695	5070	5446	242
12.0	144	3658	4906	5299	5691	252
	157	4000	5366	5795	6224	276
15.0	180	4572	6133	6624	7114	315
	197	5000	6707	7244	7780	345
18.0	216	5486	7359	7948	8537	379
	236	6000	8048	8692	9336	414
25.0	300	7620	10221	11039	11857	526

Connection

When connecting a signal source to the projector, be sure to:

1. Turn all equipment off before making any connections.
2. Use the correct signal cables for each source.
3. Ensure the cables are firmly inserted.

 In the connections shown below, some cables may not be included with the projector (see ["Shipping contents" on page 7](#)). They are commercially available from electronics stores.

Connecting a computer or monitor

Connecting a computer

The projector provides a VGA input socket that allows you to connect it to both IBM® compatibles and Macintosh® computers. A Mac adapter (an optional accessory) is needed if you are connecting legacy version Macintosh computers.

Additionally, you can also connect the projector to a computer via the USB cable so you can perform paging operations of the application on the PC or notebook.

To connect the projector to a notebook or desktop computer:

- **With a VGA cable:**
 1. Take a VGA cable and connect one end to the D-Sub output socket of the computer. Connect the other end of the VGA cable to the **D-SUB/COMP. IN** signal input socket on the projector.
 2. If you wish to use the remote paging function, take a USB cable and connect the larger end to the USB port of the computer, and the smaller end to the  (USB) socket on the projector. See ["Remote paging operations" on page 35](#) for details.
 3. If you wish to make use of the projector (mixed mono) speakers in your presentations, take a suitable audio cable and connect one end of the cable to the audio output socket of the computer, and the other end to the **AUDIO** socket of the projector.
- **With a DVI-D cable:**

 **Your computer must be equipped with a DVI-D output socket.**

 1. Take a DVI-D cable and connect one end to the DVI-D output socket of the computer. Connect the other end of the cable to the **DVI-D** signal input socket on the projector.
- **With a HDMI cable:**

 **Your computer must be equipped with a HDMI output socket.**

 1. Take a HDMI cable and connect one end to the HDMI socket of the computer. Connect the other end of the cable to the **HDMI** signal input socket on the projector.

Once connected, the audio can be controlled by the projector On-Screen Display (OSD) menus. See ["Audio Settings" on page 44](#) for details.

The final connection path should be like that shown in the following diagram:

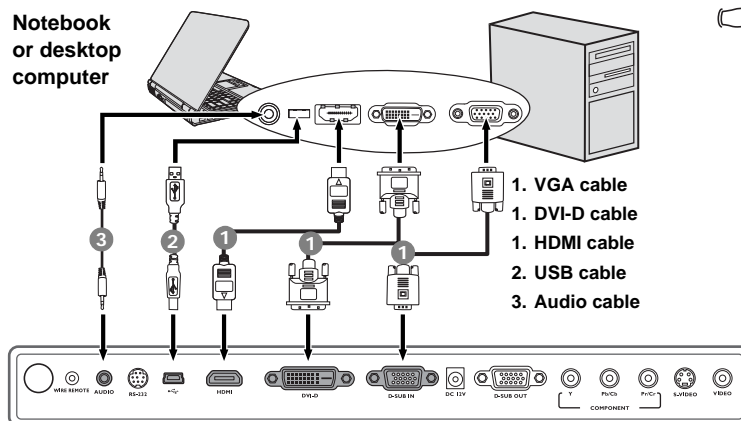

 **Many notebooks do not turn on their external video ports when connected to a projector. Usually a key combo like FN + F3 or CRT/LCD key turns the external display on/off. Locate a function key labeled CRT/LCD or a function key with a monitor symbol on the notebook. Press FN and the labeled function key simultaneously. Refer to your notebook's documentation to find your notebook's key combination.**

Connecting a monitor

If you want to view your presentation close-up on a monitor as well as on the screen, you can connect the **D-SUB OUT** signal output socket on the projector to an external monitor with a VGA or VGA to DVI-A cable by following the instructions below.

To connect the projector to a monitor:

- **With a VGA cable:**
 1. Connect the projector to a computer as described in "Connecting a computer" on page 16.
The D-SUB output only works when an appropriate D-SUB input is made to the projector. Be sure the projector is connecting with the computer using the **D-SUB/COMP. IN** socket, not the **DVI-D** socket.
 2. Take a suitable VGA cable (only one supplied) and connect one end of the cable to the D-Sub input socket of the video monitor.
 3. Connect the other end of the cable to the **D-SUB OUT** socket on the projector.
- **With a VGA to DVI-A cable:**

☞ **Your monitor must be equipped with a DVI input socket.**

 1. Connect the projector to a computer as described in "Connecting a computer" on page 16.
The D-SUB output only works when an appropriate D-SUB input is made to the projector. Be sure the projector is connecting with the computer using the **D-SUB/COMP. IN** socket, not the **DVI-D** socket.
 2. Take a VGA to DVI-A cable and connect the DVI end of the cable to the DVI input socket of the video monitor.
 3. Connect the VGA end of the cable to the **D-SUB OUT** socket on the projector.

The final connection path should be like that shown in the following diagram:

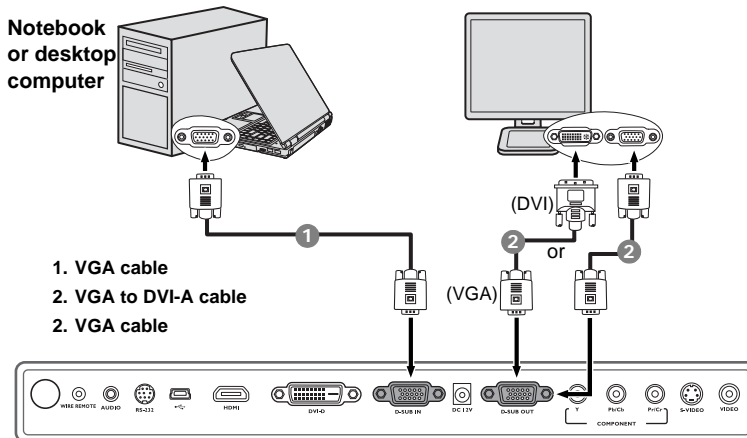

Connecting Video source devices

This section describes how to connect the projector to Video source devices using video cables. Video cable connections are recommended for Video presentations.

You can connect your projector to various Video source devices that provide any one of the following output sockets:

- HDMI
- DVI-D
- Component Video
- S-Video
- Video (composite)

You need only connect the projector to a Video source device using just one of the above connecting methods, however each provides a different level of video quality. The method you choose will most likely depend upon the availability of matching terminals on both the projector and the Video source device as described below:

Best video quality

The best available video connection method is HDMI. If your source device is equipped with a HDMI socket, you can enjoy uncompressed digital video quality.

See ["Connecting a HDMI source device" on page 19](#) for how to connect the projector to a HDMI source device and other details.

If no HDMI source is available, the next best video signal is DVI-D. If your source device is equipped with a DVI-D socket, you can enjoy digital video quality.

See ["Connecting a DVI-D source device" on page 20](#) for how to connect the projector to a DVI-D source device and other details.

If no DVI-D source is available, the next best video signal is Component Video (not to be confused with composite Video). Digital TV tuners and DVD players output Component Video natively, so if available on your devices, they should be your connection method of choice in preference to S-Video or (composite) Video.

See ["Connecting a Component Video source device" on page 21](#) for how to connect the projector to a Component Video device.

Better video quality

The S-Video method provides a better quality analog video than standard composite Video. If you have both composite Video and S-Video output terminals on your Video source device, you should elect to use the S-Video option.

Least video quality

Composite Video is an analog video and will result in a perfectly acceptable, but less than optimal result from your projector, being the least video quality of the available methods described here.

See ["Connecting an S-Video or a composite Video source device" on page 22](#) for how to connect the projector to an S-Video or Video device.

Connecting Audio

The projector has built-in mono speakers which are designed to provide basic audio functionality accompanying data presentations for business purposes only. They are not designed for, nor intended for stereo audio reproduction use as might be expected in home theater or home cinema applications. Any stereo audio input (if provided), is mixed into a common mono audio output through the projector speakers.

Connecting a HDMI source device

The projector provides a **HDMI** input socket that allows you to connect it to a HDMI source device like a DVD player, a DTV tuner or a display.

HDMI (High-Definition Multimedia Interface) supports uncompressed video data transmission between compatible devices like DTV tuners, DVD players and displays over a single cable. It provides pure digital viewing and listening experience.

Examine your source device to determine if it has an unused HDMI output socket available:

- If so, you can continue with this procedure.
- If not, you will need to reassess which method you can use to connect to the device.

To connect the projector to a HDMI source device:

1. Take a HDMI cable and connect one end to the HDMI output socket of the HDMI source device. Connect the other end of the cable to the **HDMI** signal input socket on the projector.

Once connected, the audio can be controlled by the projector On-Screen Display (OSD) menus. See "[Audio Settings](#)" on page 44 for details.

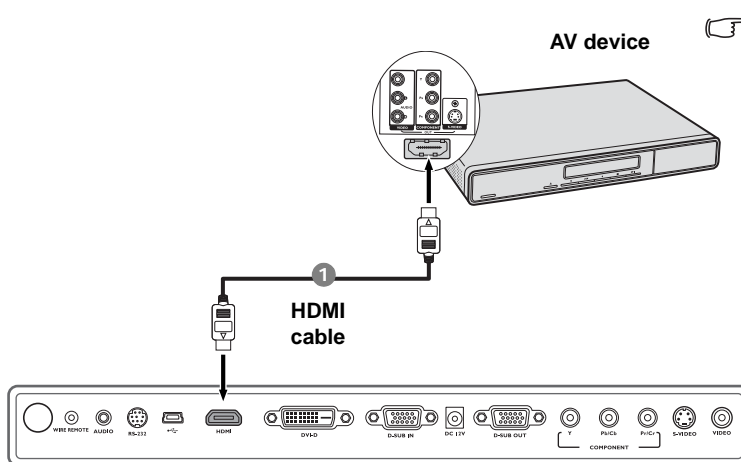

- In the unlikely event that you connect the projector to a DVD player and the projected picture displays wrong colors, please change the color space to YUV. See "[Changing Color Space](#)" on page 27 for details.

- If no signal is detected after establishing the connection, turn off the Quick Auto Search function in the SOURCE menu. See "[Switching input signal](#)" on page 27 for details.

Connecting a DVI-D source device

The projector provides a **DVI-D** input socket that allows you to connect it to a DVI-D source device like a DVD player.

DVI-D format is used to directly carry a digital signal to a digital display without signal conversion. The pure digital connection provides faster and higher image quality than an analog connection, due to the nature of the digital format.

Examine your source device to determine if it has an unused DVI-D output socket available:

- If so, you can continue with this procedure.
- If not, you will need to reassess which method you can use to connect to the device.

To connect the projector to a DVI-D source device:

1. Take a DVI-D cable and connect one end to the DVI-D output socket of the DVI-D source device. Connect the other end of the cable to the **DVI-D** signal input socket on the projector.
2. If you wish to make use the projector (mixed mono) speakers, take a suitable audio cable and connect one end of the cable to the audio output sockets of the video device, and the other end to the **AUDIO** socket of the projector.

Once connected, the audio can be controlled by the projector On-Screen Display (OSD) menus. See ["Audio Settings" on page 44](#) for details.

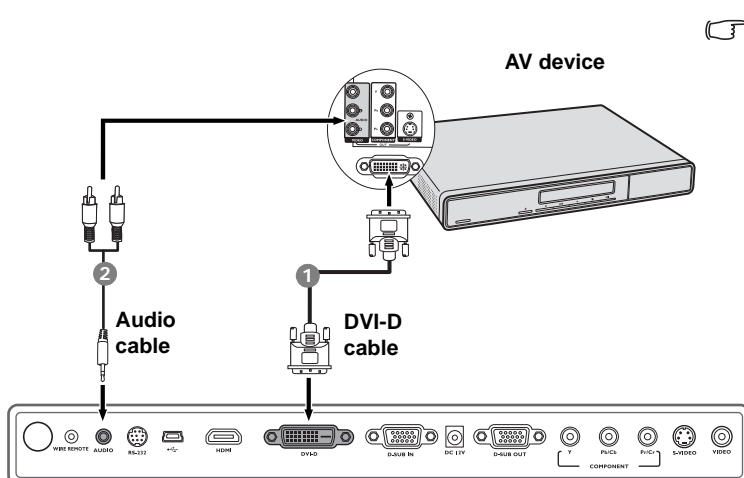

- **The projector is only capable of playing mixed mono audio, even if a stereo audio input is connected. See ["Connecting Audio" on page 18](#) for details.**
- **In the unlikely event that you connect the projector to a DVD player and the projected picture displays wrong colors, please change the color space to YUV. See ["Changing Color Space" on page 27](#) for details.**
- **If no signal is detected after establishing the connection, turn off the Quick Auto Search function in the SOURCE menu. See ["Switching input signal" on page 27](#) for details.**

Connecting a Component Video source device

Examine your Video source device to determine if it has a set of unused Component Video output sockets available:

- If so, you can continue with this procedure.
- If not, you will need to reassess which method you can use to connect to the device.

To connect the projector to a Component Video source device:

- **With a Component Video cable:**
 1. Take a Component Video cable and connect the end with 3 RCA type connectors to the Component Video output sockets of the Video source device. Match the color of the plugs to the color of the sockets; green to green, blue to blue, and red to red.
 2. Connect the other end with 3 RCA type connectors to the **COMPONENT** sockets of the projector. Match the color of the plugs to the color of the sockets; green to green, blue to blue, and red to red.
 3. If you wish to make use of the projector (mixed mono) speakers in your presentations, take a suitable audio cable and connect one end of the cable to the audio output socket of the device, and the other end to the **AUDIO** socket of the projector.
Once connected, the audio can be controlled by the projector On-Screen Display (OSD) menus. See "[Audio Settings](#)" on page 44 for details.
- **With a Component Video to VGA (D-Sub) adaptor cable:**
 1. Take a Component Video to VGA (D-Sub) adaptor cable and connect the end with 3 RCA type connectors to the Component Video output sockets of the Video source device. Match the color of the plugs to the color of the sockets; green to green, blue to blue, and red to red.
 2. Connect the other end of the Component Video to VGA (D-Sub) adaptor cable (with a D-Sub type connector) to the **D-SUB/COMP. IN** socket on the projector.
 3. If you wish to make use of the projector (mixed mono) speakers in your presentations, take a suitable audio cable and connect one end of the cable to the audio output socket of the device, and the other end to the **AUDIO** socket of the projector.
Once connected, the audio can be controlled by the projector On-Screen Display (OSD) menus. See "[Audio Settings](#)" on page 44 for details.

The final connection path should be like that shown in the following diagram:

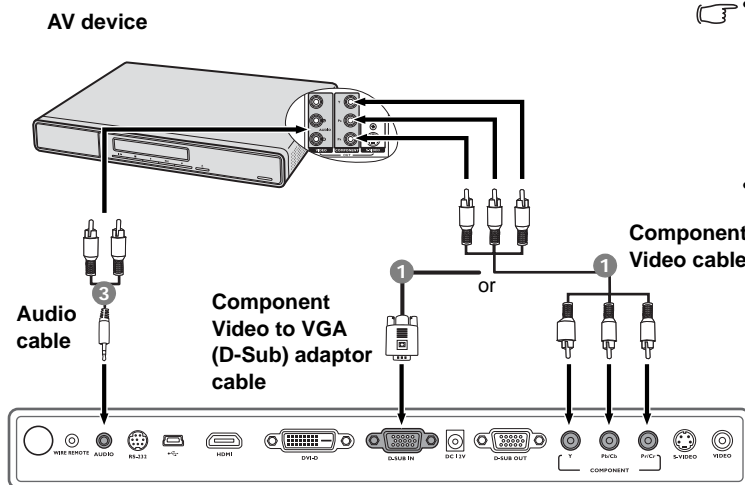

• The projector is only capable of playing mixed mono audio, even if a stereo audio input is connected. See "[Connecting Audio](#)" on page 18 for details.

- If the selected video image is not displayed after the projector is turned on and the correct video source has been selected, check that the Video source device is turned on and operating correctly. Also check that the signal cables have been connected correctly.

Connecting an S-Video or a composite Video source device

Examine your Video source device to determine if it has an unused S-Video or Video output socket available:

- If it has both sockets, use the S-Video output socket for connection as the S-Video terminal provides better picture quality than the Video terminal. See "[Connecting Video source devices](#)" on page 18 for details.
- If it has either of the output socket, you can also continue with this procedure.
- If not, you will need to reassess which method you can use to connect to the device.

If you have already made a Component Video connection between the projector and the video source device, you need not connect to this device again using an S-Video or composite Video connection as this makes an unnecessary second connection of poorer picture quality. You need only connect using a composite Video connection if both Component Video and S-Video are not supplied on the video source device (for example, with some analog video cameras).

To connect the projector to an S-Video/Video source device:

1. Take an S-Video/Video cable and connect one end to the S-Video/Video output socket of the Video source device.
2. Connect the other end of the S-Video/Video cable to the **S-VIDEO/VIDEO** socket on the projector.
3. If you wish to make use of the projector (mixed mono) speakers in your presentations, take a suitable audio cable and connect one end of the cable to the audio output socket of the device, and the other end to the **AUDIO** socket of the projector.

Once connected, the audio can be controlled by the projector On-Screen Display (OSD) menus. See "[Audio Settings](#)" on page 44 for details.

The final connection path should be like that shown in the following diagram:

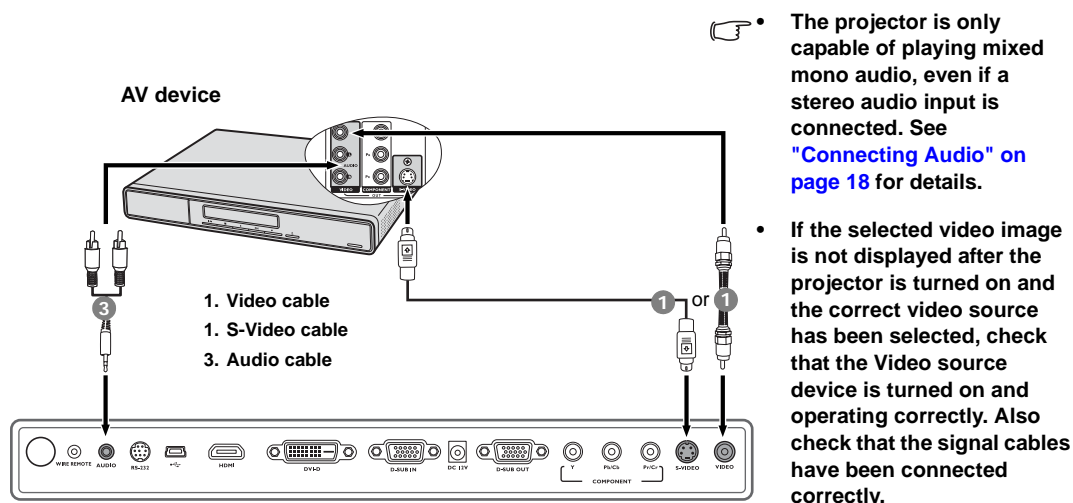

Operation

Starting up the projector

1. Plug the power cord into the projector and into a wall socket. Turn on the wall socket switch (where fitted).

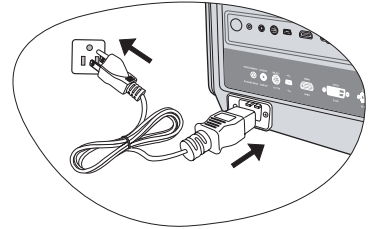

⚠ For safety reasons, use a 15A extension cord if needed.

2. Press **Power** on the projector or remote control to start the projector. As soon as the lamp lights up, a "Power On Tone" will be heard. The **POWER indicator light** flashes green and stays green when the projector is on.

The start up procedure takes about 30 seconds. In the later stage of start up, a startup logo is projected.

(If necessary) Rotate the focus ring to adjust the image clearness.

To turn of the ring tone, see "[Turning off the Power on/off ring tone](#)" on page 38 for details.

3. If you are prompted for a password, press the arrow keys to enter a six digit password. See "[Utilizing the password function](#)" on page 25 for details.
4. Switch all of the connected equipment on.
5. The projector will start to search for input signals. The current input signal being scanned displays in the upper left corner of the screen. If the projector doesn't detect a valid signal, the 'No Signal' message will continue displaying until an input signal is found.

You can also press **SOURCE** on the projector or remote control to select your desired input signal. See "[Switching input signal](#)" on page 27 for details.

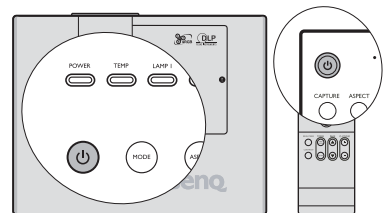

☞ If the projector is still hot from previous activity, it will run the cooling fans for approximately 90 seconds before energizing the lamp.

☞ If the frequency/resolution of the input signal exceeds the projector's operating range, you will see the message 'Out of Range' displayed on a blank screen. Please change to an input signal which is compatible with the projector's resolution or set the input signal to a lower setting. See "[Timing chart](#)" on page 53 for details.

⚠ To maintain the lamp life, once you turn the projector on, wait at least 5 minutes before turning it off.

Using the On-Screen Display (OSD) menus

The projector is equipped with On-Screen Display (OSD) menus for making various adjustments and settings. Below is the overview of the OSD menu.



To use the OSD menus, please set the OSD menu to your familiar language first.

1. Press **MENU/EXIT** on the projector or remote control to turn the OSD menu on.
2. Press **▼** to highlight **Language** and press **◀/▶** to select a preferred language.



3. Use **◀/▶** to highlight the **SYSTEM SETUP: Basic** menu.
4. Press **MENU/EXIT** twice* on the projector or remote control to leave and save the settings.



*The first press leads you back to the main menu and the second press closes the OSD menu.

Securing the projector

Using a security cable lock

The projector has to be installed in a safe place to prevent theft. Otherwise, purchase a lock, such as a Kensington lock, to secure the projector. You can locate a Kensington lock slot on the left side of the projector. See item 10 on page 8 for details.

A Kensington security cable lock is usually a combination of key(s) and a lock. Refer to the lock's documentation for finding out how to use it.

Utilizing the password function

For security purposes and to help prevent unauthorized use, the projector includes an option for setting up password security. The password can be set through the On-Screen Display (OSD) menu.

- ⚠ **You will be inconvenienced if you activate the password functionality and subsequently forget the password. Print out this manual (if necessary) and write the password you used in this manual, and keep the manual in a safe place for later recall.**

Setting a password

- ☞ **Once a password has been set and the power on lock is activated, the projector cannot be used unless the correct password is entered every time the projector is started.**

Once a password has been set and the Splash Screen Lock is activated, you cannot change the splash screen that displays at projector startup unless the correct password is entered.

1. Open the OSD menu and go to the **SYSTEM SETUP: Advanced > Security Settings** menu. Press **ENTER** on the projector or remote control. The **Security Settings** page displays.
2. Highlight **Change Security Settings** and press **ENTER** on the projector or remote control.
3. As pictured to the right, the four arrow keys (▲, ▶, ▼, ◀) respectively represent 4 digits (1, 2, 3, 4). According to the password you desire to set, press the arrow keys to enter six digits for the password.
4. Confirm the new password by re-entering the new password.
Once the password is set, the OSD menu returns to the **Security Settings** page.
5. To activate the **Power On Lock** function, press ▲/▼ to highlight **Power On Lock** and press ◀/▶ to select **On**.
6. To activate the **Splash Screen Lock** function, press ▲/▼ to highlight **Splash Screen Lock** and press ◀/▶ to select **On**.



When the **Splash Screen Lock** is activated, the **My Screen** function in the **SYSTEM SETUP: Basic** menu will be password-protected.

- ⚠ **The digits being input will display as asterisks on-screen. Write your selected password down here in this manual in advance or right after the password is entered so that it is available to you should you ever forget it.**

Password: _____

Keep this manual in a safe place.

7. To leave the OSD menu, press **MENU/EXIT**.

If you forget the password

If the password function is activated, you will be asked to enter the six digit password every time you turn on the projector. If you enter the wrong password, the password error message as pictured to the right displays lasting for three seconds, and the **INPUT PASSWORD** message follows. You can retry by entering another six-digit password, or if you did not record the password in this manual, and you absolutely do not remember it, you can use the password recall procedure. See "[Entering the password recall procedure](#)" on [page 26](#) for details.

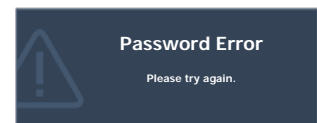

If you enter an incorrect password 5 times in succession, the projector will automatically shut down in a short time.

Entering the password recall procedure

Press and hold **AUTO** on the projector or remote control for 3 seconds. The projector will display a coded number on the screen. Write down the number and turn off your projector. Seek help from the local BenQ service center to decode the number. You may be required to provide proof of purchase documentation to verify that you are an authorized user of the projector.

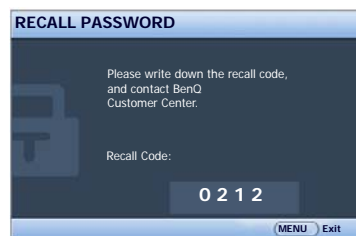

Changing the password

1. Open the OSD menu and go to the **SYSTEM SETUP: Advanced > Security Settings > Change Password** menu.
2. Press **ENTER** on the projector or remote control. The message 'INPUT CURRENT PASSWORD' displays.
3. Enter the old password.
 - i. If the password is correct, another message 'INPUT NEW PASSWORD' displays.
 - ii. If the password is incorrect, the password error message displays lasting for three seconds, and the message 'INPUT CURRENT PASSWORD' displays for your retry. You can press **MENU/EXIT** to cancel the change or try another password.
4. Enter a new password.

 **The digits being input will display as asterisks on-screen. Write your selected password down here in this manual in advance or right after the password is entered so that it is available to you should you ever forget it.**

Password: _ _ _ _ _

Keep this manual in a safe place.

5. Confirm the new password by re-entering the new password.
6. You have successfully assigned a new password to the projector. Remember to enter the new password next time the projector is started.
7. To leave the OSD menu, press **MENU/EXIT**.

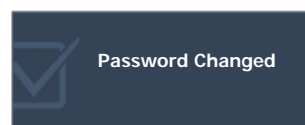

Disabling the password function

To disable password protection, go back to the **SYSTEM SETUP: Advanced > Security Settings > Change Security Settings** menu after opening the OSD menu system. Press **ENTER**. The message 'INPUT PASSWORD' displays. Enter the current password.

- i. If the password is correct, the OSD menu returns to the **Security Settings** page.
 - Press **▼** to highlight **Power On Lock** and press **◀/▶** to select **Off**. You will not have to enter the password next time when turning on the projector.
 - Press **▼** to highlight **Splash Screen Lock** and press **◀/▶** to select **Off**. The **Splash Screen** function in the **SYSTEM SETUP: Basic** menu will be available for your change.
- ii. If the password is incorrect, the password error message displays lasting for three seconds, and the message 'INPUT PASSWORD' displays for your retry. You can press **MENU/EXIT** to cancel the change or try another password.

 **Though the password function is disabled, you need to keep the old password in hand should you ever need to re-activate the password function by entering the old password.**

Switching input signal

The projector can be connected to multiple devices at the same time. However, it can only display one full screen at a time. When starting up, the projector automatically search for the available signals.

Be sure the **Quick Auto Search** function in the **SOURCE** menu is **On** (which is the default of this projector) if you want the projector to automatically search for the signals.

You can also manually cycle through the available input signals.

1. Press **SOURCE** on the projector or remote control. A source selection bar displays.
2. Press **▲** / **▼** until your desired signal is selected and press **ENTER** on the projector or remote control.

Once detected, the selected source information will display at the corner of the screen for seconds. If there is multiple equipment connected to the projector, repeat steps 1-2 to search for another signal.

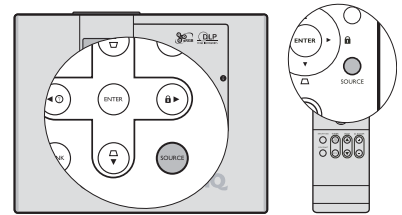

- **The brightness level of the projected image will change accordingly when you switch between different input signals. Data (graphic) "PC" presentations using mostly static images are generally brighter than "Video" using mostly moving images (movies).**
- **The input signal type effects the options available for the Picture Mode. See ["Selecting a picture mode" on page 31](#) for details.**
- **The native display resolution of this projector is in a 4:3 aspect ratio. For best display picture results, you should select and use an input signal which outputs at this resolution. Any other resolutions will be scaled by the projector depending upon the 'aspect ratio' setting, which may cause some image distortion or loss of picture clarity. See ["Selecting the aspect ratio" on page 30](#) for details.**

Changing Color Space

In the unlikely event that you connect the projector to a DVD player via the projector's **DVI-D** input and the projected picture displays wrong colors, please change the color space to **YUV**.

To do this:

1. Press **MENU/EXIT** and then press **◀/▶** until the **SOURCE** menu is highlighted.
2. Press **▼** to highlight **Color Space Conversion** and press **◀/▶** to select **YUV**.

☞ **This function is only available when the DVI-D or HDMI input socket is in use.**

Adjusting the projected image

Adjusting the projection angle

The projector is equipped with 4 adjuster feet. These adjusters change the picture height and projection angle.

To adjust the projector, slightly lift the front or the back of the projector and screw the feet in or out until the picture is positioned where you want it.

If the projector is not placed on a flat surface or the screen and the projector are not perpendicular to each other, the projected picture becomes trapezoidal. To correct this situation, see "[Correcting keystone](#)" on page 29 for details.

Auto-adjusting the image

In some cases, you may need to optimize the picture quality. To do this, press **AUTO** on the projector or remote control. Within 3 seconds, the built-in Intelligent Auto Adjustment function will re-adjust the values of Frequency and Clock to provide the best picture quality.

The current source information will be displayed in the corner of the screen for 3 seconds.

 **The screen will be blank while AUTO is functioning.**

Fine-tuning the image size and clarity

1. Adjust the projected image to the size that you need using the zoom ring.
2. Then sharpen the image by rotating the focus ring.

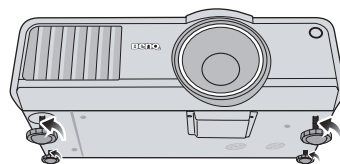

-  i. Be aware of the vent where hot air comes from.
- ii. Do not look into the lens while the lamp is on. The strong light from the lamp may cause damage to your eyes.

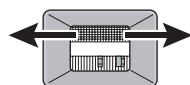
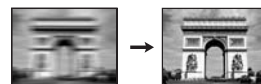
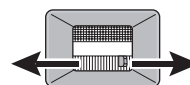
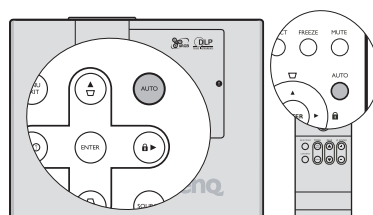

Correcting keystone

Keystoning refers to the situation where the projected image is noticeably wider at either the top or bottom. It occurs when the projector is not perpendicular to the screen.

To correct this, besides adjusting the height of the projector, you will need to manually correct it by following one of these steps.

- Using the remote control

Press ∇ / \triangle on the control panel of the projector or remote control to display the Keystone correction page. Press ∇ to correct keystoning at the top of the image. Press \triangle to correct keystoning at the bottom of the image.

- Using the OSD menu

- Press **MENU/EXIT** and then press \blacktriangleleft / \blacktriangleright until the **DISPLAY** menu is highlighted.
- Press \blacktriangledown to highlight **Keystone** and press **ENTER**. The Keystone correction page displays.
- Press ∇ to correct keystoning at the top of the image or press \triangle to correct keystoning at the bottom of the image.

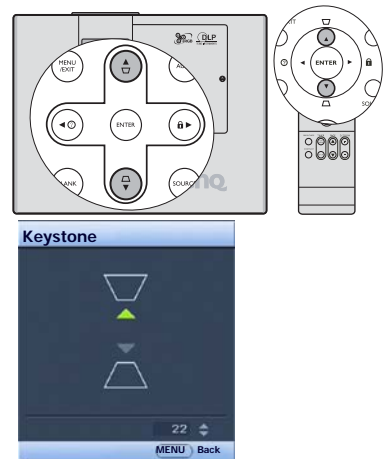

Magnifying and searching for details

If you need to find the details on the projected picture, magnify the picture. Use the direction arrow keys for navigating the picture.

- Using the remote control

- Press **D. ZOOM +/-** to display the Zoom bar.
- Press **D. ZOOM +** to magnify the center of the picture. Press the key repeatedly until the picture size is suitable for your need.
- Use the directional arrows (\blacktriangle , \blacktriangledown , \blacktriangleleft , \blacktriangleright) on the projector or remote control to navigate the picture.
- To restore the picture to its original size, press **AUTO**. You can also press **D. ZOOM -**. When the key is pressed again, the picture is further reduced until it is restored to the original size.

- Using the OSD menu

- Press **MENU/EXIT** and then press \blacktriangleleft / \blacktriangleright until the **DISPLAY** menu is highlighted.
- Press \blacktriangledown to highlight **Digital Zoom** and press **ENTER**. The Zoom bar displays.
- Repeat steps 2-4 in the section of "[Using the remote control](#)" above. Or if you are using the projector control panel, continue to the following steps.
- Press \blacktriangle on the projector repeatedly to magnify the picture to a desired size.
- To navigate the picture, press **ENTER** to switch to the panning mode and press the directional arrows (\blacktriangle , \blacktriangledown , \blacktriangleleft , \blacktriangleright) to navigate the picture.
- To reduce size of the picture, press **ENTER** to switch back to the zoom in/out function, and press **AUTO** to restore the picture to its original size. You can also press \blacktriangledown repeatedly until it is restored to the original size.

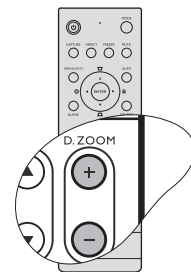

The picture can only be navigated after the picture is magnified. You can further magnify the picture while searching for details.

Selecting the aspect ratio

The 'aspect ratio' is the ratio of the image width to the image height. Most analog TV and computers are in 4:3 ratio, and digital TV and DVDs are usually in 16:9 ratio.

With the advent of digital signal processing, digital display devices like this projector can dynamically stretch and scale the image output to a different aspect than that of the image input signal.

To change the projected picture ratio (no matter what aspect the source is):

- Using the remote control
 1. Press **ASPECT** to show the current setting.
 2. Press **ASPECT** repeatedly to select an aspect ratio to suit the format of the video signal and your display requirements.
- Using the OSD menu
 1. Press **MENU/EXIT** and then press ◀ / ▶ until the **DISPLAY** menu is highlighted.
 2. Press ▼ to highlight **Aspect Ratio**.
 3. Press ◀ / ▶ to select an aspect ratio to suit the format of the video signal and your display requirements.

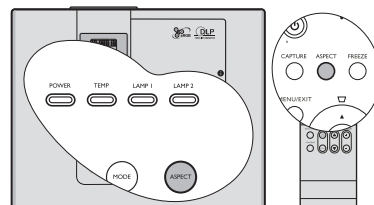

About the aspect ratio

 In the pictures below, the black portions are inactive areas and the white portions are active areas.

1. **4:3**: Scales an image so that it is displayed in the center of the screen with a 4:3 aspect ratio. This is most suitable for 4:3 images like computer monitors, standard definition TV and 4:3 aspect DVD movies, as it displays them without aspect alteration.
2. **16:9**: Scales an image so that it is displayed in the center of the screen with a 16:9 aspect ratio. This is most suitable for images which are already in a 16:9 aspect, like high definition TV, as it displays them without aspect alteration.
3. **Auto**: Scales an image proportionally to fit the projector's native resolution in its horizontal width. This is suitable for the incoming image which is neither in 4:3 nor 16:9 and you want to make most use of the screen without altering the image's aspect ratio.
4. **Real**: The image is projected as its original resolution, and with no pixel conversion. For input signals with lower resolutions, the projected image will display smaller than if resized to full screen. You could adjust the zoom setting or move the projector towards the screen to increase the image size if necessary. You may also need to refocus the projector after making these adjustments.

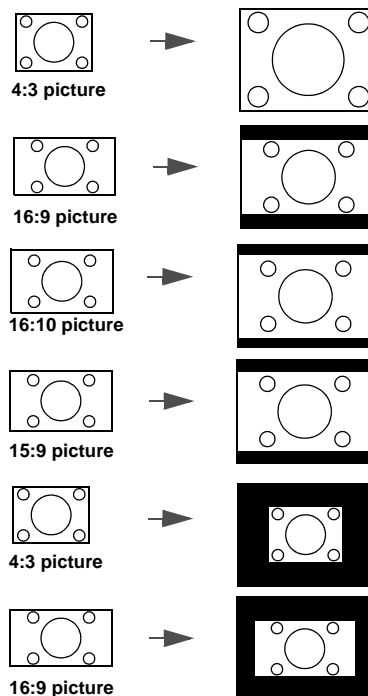

 **OSD menus can be displayed on those unused black areas.**

Optimizing the image

Using Wall Color

In the situation where you are projecting onto a colored surface such as a painted wall which may not be white, the Wall Color feature can help correct the projected picture's color to prevent possible color difference between the source and projected pictures.

To use this function, go to the **DISPLAY > Wall Color** menu and press ◀/▶ to select a color which is the closest to the color of the projection surface. There are several precalibrated colors to choose from: **Light Yellow, Pink, Light Green, Blue, and Blackboard**

Selecting a picture mode

The projector is preset with several predefined picture modes so that you can choose one to suit your operating environment and input signal picture type.

To select a operation mode that suits your need, perform one of the following steps.

- Press **MODE** on the projector or remote control repeatedly until your desired mode is selected.
- Go to the **PICTURE > Picture Mode** menu and press ◀/▶ to select a desired mode.

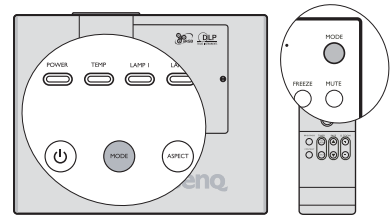

A slight variation in the picture brightness and colors may be observed during the very short time of switching picture modes.

The picture modes available for different types of signals are listed below.

PC input signals: D-Sub/Comp. (analog RGB) and DVI-D (DVI-D)

1. **Dynamic mode (Default):** Maximizes the brightness of the projected image. This mode is suitable for environments where extra-high brightness is required, such as using the projector in well lit rooms.
2. **Presentation mode:** Is designed for presentations. The brightness is emphasized in this mode to match PC and notebook coloring.
3. **sRGB mode:** Maximizes the purity of RGB colors to provide true-to-life images regardless of brightness setting. It is most suitable for viewing photos taken with an sRGB compatible and properly calibrated camera, and for viewing PC graphic and drawing applications such as AutoCAD.
4. **Cinema mode:** Is appropriate for playing colorful movies, video clips from digital cameras or DVs through the PC input for best viewing in a blackened (little light) environment.
5. **User 1/User 2 mode:** Recalls the settings customized based on the current available picture modes. See "[Setting the User 1/User 2 mode](#)" on page 32 for details.

Video input signals: Component (YPbPr), S-Video, Video, D-Sub/Comp. (YPbPr), DVI-D (HDCP/HDMI), HDMI, HDCP

1. **Dynamic mode:** Is suitable for playing gamebox-based video games in a normal living room lighting level environment.
2. **Standard mode (Default):** Is appropriate for viewing colorful movies, video clips from digital cameras or DVs.
3. **Cinema mode:** Is suitable for enjoying dark movies or DVD movies best viewed in a blackened (little light) home cinema or lounge room environment.
4. **User 1/User 2 mode:** Recalls the settings customized based on the current available picture modes. See "[Setting the User 1/User 2 mode](#)" on page 32 for details. The **User 1** and **User 2** modes here are different from the **User 1** and **User 2** modes defined under the **D-Sub/Comp. (analog RGB)/DVI-D (DVI-D)** signal input.

Setting the User 1/User 2 mode

There are two user-definable modes if the current available picture modes are not suitable for your need. You can use one of the picture modes (except the **User 1/2**) as a starting point and customize the settings.

1. Press **MENU/EXIT** and then press **◀/▶** until the **PICTURE** menu is highlighted.
2. Press **▼** to highlight **Picture Mode** and press **◀/▶** to select **User 1** or **User 2**.
3. Press **▼** to highlight **Reference Mode**.

 **This function is only available when User 1, or User 2 mode is selected up in the Picture Mode sub-menu item.**

4. Press **◀/▶** to select a picture mode that is closest to your need.
5. Press **▼** to select a menu item to be changed and adjust the value with **◀/▶**. See "[Fine-tuning the image quality in user modes](#)" below for details.
6. When all settings have been done, highlight **Save Settings** and press **ENTER** on the projector or remote control to store the settings.
7. The confirmation message '**Setting Saved**' displays.

Fine-tuning the image quality in user modes

According to the detected signal type, there are some user-definable functions available when **User 1** or **User 2** is selected. You can make adjustments to these functions based on your needs.

Adjusting Brightness

Press **BRIGHTNESS** on the remote control or highlight **Brightness** in the **PICTURE** menu and adjust the values by pressing **◀/▶** on the projector or remote control.

The higher the value, the brighter the image. And lower the setting, darker the image. Adjust this control so the black areas of the image appear just as black and that detail in the dark areas is visible.



Adjusting Contrast

Press **CONTRAST** on the remote control or highlight **Contrast** in the **PICTURE** menu and adjust the values by pressing **◀/▶** on the projector or remote control.

The higher the value, the greater the contrast. Use this to set the peak white level after you have previously adjusted the Brightness setting to suit your selected input and viewing environment.



Adjusting Color

Highlight **Color** in the **PICTURE** menu and adjust the values by pressing **◀/▶** on the projector or remote control.

Lower setting produces less saturated colors. If the setting is too high, colors on the image will be overpowering, which makes the image unrealistic.

Adjusting Tint

Highlight **Tint** in the **PICTURE** menu and adjust the values by pressing **◀/▶** on the projector or remote control.

The higher the value, the more reddish the picture becomes. The lower the value, the more greenish the picture becomes.

Adjusting Sharpness

Highlight **Sharpness** in the **PICTURE** menu and adjust the values by pressing **◀/▶** on the projector or remote control.

The higher the value, the sharper the picture becomes. The lower the value, the softer the picture becomes.

Adjusting Brilliant Color

Highlight **Brilliant Color** in the **PICTURE** menu and select by pressing ◀/▶ on the projector or remote control.

This feature utilizes a new color-processing algorithm and system level enhancements to enable higher brightness while providing truer, more vibrant colors in picture. It enables a greater than 50% brightness increase in mid-tone images, which are common in video and natural scenes, so the projector reproduces images in realistic and true colors. If you prefer images with that quality, select **On**. If you don't need it, select **Off**.

On is the default and recommended selection for this projector. When **Off** is selected, the **Color Temperature** function is not available.

Selecting a color temperature

Highlight **Color Temperature** in the **PICTURE** menu and adjust the values by pressing ◀/▶ on the projector or remote control.

There are four color temperature* settings available.

1. **T1:** With the highest color temperature, T1 makes the image appear the most bluish white than other settings.
2. **T2:** Makes images appear bluish white.
3. **T3:** Maintains normal colorings for white.
4. **T4:** Makes images appear reddish white.

*About color temperatures:

There are many different shades that are considered to be "white" for various purposes. One of the common methods of representing white color is known as the "color temperature". A white color with a low color temperature appears to be reddish white. A white color with a high color temperature appears to have more blue in it.

3D Color Management

In most installation situations, color management will not be necessary, such as in classroom, meeting room, or lounge room situations where lights remain on, or where building external windows allow daylight into the room.

Only in permanent installations with controlled lighting levels such as boardrooms, lecture theaters, or home theaters, should color management be considered. Color management provides fine color control adjustment to allow for more accurate color reproduction, should you require it.

Proper color management can only be achieved under controlled and reproducible viewing conditions. You will need to use a colorimeter (color light meter), and provide a set of suitable source images to measure color reproduction. These tools are not provided with the projector, however, your projector supplier should be able to provide you with suitable guidance, or even an experienced professional installer.

The Color Management provides six sets (RGBCMY) of colors to be adjusted. When you select each color, you can independently adjust its range and saturation according to your preference.

If you have purchased a test disc which contains various color test patterns and can be used to test the color presentation on monitors, TVs, projectors, etc. You can project any image from the disc on the screen and enter the **3D Color Management** menu to make adjustments.

To adjust the settings:

1. Go to the **PICTURE** menu and highlight **3D Color Management**.
2. Press **ENTER** on the projector or remote control and the **3D Color Management** page displays.
3. Highlight **Primary Color** and press ◀/▶ to select a color from among Red, Yellow, Green, Cyan, Blue, or Magenta.
4. Press ▼ to highlight **Hue** and press ◀/▶ to select its range. Increase in the range will include colors consisted of more proportions of its two adjacent colors.

Please refer to the illustration to the right for how the colors relate to each other.

For example, if you select Red and set its range at 0, only pure red in the projected picture will be selected. Increasing its range will include red close to yellow and red close to magenta.

- Press **▼** to highlight **Saturation** and adjust its values to your preference by pressing **◀/▶**. Every adjustment made will reflect to the image immediately.
For example, if you select Red and set its value at 0, only the saturation of pure red will be affected.
- Press **▼** to highlight **Gain** and adjust its values to your preference by pressing **◀/▶**. This will affect the contrast level of the selected primary color. Every adjustment made will be reflected to the image immediately.
- Repeat steps 3 to 6 for other color adjustments.
- Make sure you have carried out all of the desired adjustments.
- Press **MENU/EXIT** to exit and save the settings.

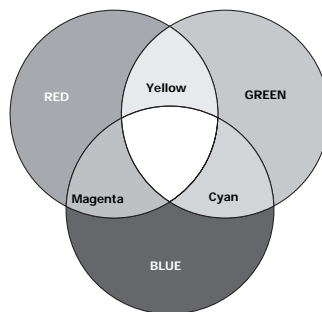

Saturation is the amount of that color in a video picture. Lower settings produce less saturated colors; a setting of "0" removes that color from the image entirely. If the saturation is too high, that color will be overpowering and unrealistic.

Setting the presentation timer

The presentation timer can indicate the presentation time on the screen to help you achieve better time management when giving presentations.

The Presentation Timer is only available when the input signal is a PC or notebook with D-SUB/COMP. IN, DVI-D or HDMI terminal in use. It is not available when the input signal is a DVI-D or HDMI signal with HDCP format.

Follow these steps to utilize this function:

- Press **TIMER SETUP** on the remote control or go to the **SYSTEM SETUP: Basic > Presentation Timer** menu and press **ENTER** to display the **Presentation Timer** page.
- Highlight **Timer Period** and decide the time period by pressing **◀/▶**. The length of time can be set from 1 to 5 minutes in 1-minute increments and 5 to 240 minutes in 5-minute increments.

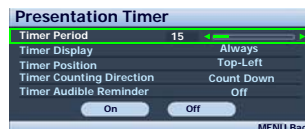
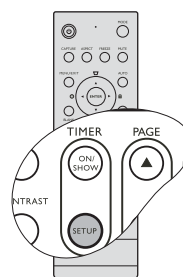

If the timer is already on, the timer will restart whenever the Timer Period is reset.

- Press **▼** to highlight **Timer Display** and choose if you want the timer to show up on the screen by pressing **◀/▶**.

Selection	Description
Always	Displays the timer on screen throughout the presentation time.
1 min/2 min/3 min	Displays the timer on screen in the last 1/2/3 minute(s).
Never	Hides the timer throughout the presentation time.

- Press **▼** to highlight **Timer Position** and set the timer position by pressing **◀/▶**.

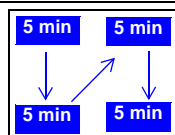

5. Press ▼ to highlight **Timer Counting Direction** and select your desired counting direction by pressing ◀/▶.

Selection	Description
Count Up	Increases from 0 to the preset time.
Count down	Decreases from the preset time to 0.

6. Press ▼ to highlight **Timer Audible Reminder** and decide if you want to activate the sound reminder by pressing ◀/▶. If you select **On**, a double beep sound will be heard at the last 30 seconds of counting down/up, and a triple beep sound will be generated when the timer is up.
7. To activate the presentation timer, press ▼ and press ◀/▶ to highlight **On** and press **ENTER**.
8. A confirmation message displays. Highlight **Yes** and press **ENTER** on the projector or remote control to confirm. You will see the message “**Timer is On**” displaying on the screen. The timer start counting at the time the timer is on.

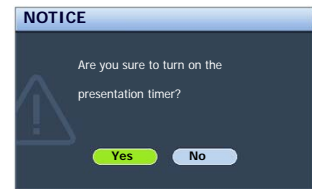

To cancel the timer, perform the following steps.

- **Using the remote control**

Press **TIMER ON/SHOW** and press ◀/▶ to highlight **Off** and press **ENTER**.

- **Using the OSD menu**

1. Press **MENU/EXIT** and then press ◀/▶ until the **SYSTEM SETUP: Basic** menu is highlighted.
2. Press ▼ to highlight **Presentation Timer** and press **ENTER** to display the **Presentation Timer** page.
3. Press ▼ and press ◀/▶ to highlight **Off** and press **ENTER**. A confirmation message displays.
4. Highlight **Yes** and press **ENTER** to confirm. You will see the message “**Timer is Off**” displaying on the screen.

How to use the **TIMER ON/SHOW** key?

It is a multi-functional key.

- If the presentation timer is off, pressing this key displays a confirmation message. You can decide whether to activate the timer or not by following the on-screen instruction.
- If the timer is already on, pressing this key displays a confirmation message. You can decide whether to restart, continue or turn off the timer by following the on-screen instruction.

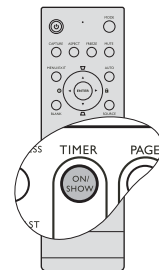

Remote paging operations

Connect the projector to your PC or notebook with a USB cable prior to using the paging function. See "[Connecting a computer](#)" on page 16 for details.

You can operate your display software program (on a connected PC) which responds to page up/down commands (like Microsoft PowerPoint) by pressing **PAGE ▲/▼** on the remote control.

If remote paging function doesn't work, check if the USB connection is correctly made and the mouse driver on your computer is updated to the latest version.

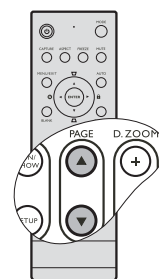

☞ **The remote paging function cannot work with Microsoft® Windows®98 operating system. Windows®XP or higher operating systems are recommended.**

Hiding the image

In order to draw the audience's full attention to the presenter, you can use **BLANK** on the projector or remote control to hide the screen image. The word '**BLANK**' appears in the corner of the screen while the image is hidden. When this function is activated with an audio input connected, the audio can still be heard.

You can set the blank time in the **SYSTEM SETUP: Basic > Blank Timer** menu to let the projector return the image automatically after a period of time when there is no action taken on the blank screen. The length of time can be set from 5 to 30 minutes in 5-minute increments.

If the preset time spans are not suitable for your personation, select **Disable**.

No matter **Blank Timer** is activated or disabled, you can press any key except **PAGE ▲/▼**, **ENTER** and **LASER** on the remote control, or **ENTER** on the projector to restore the picture.

- ⚠ **Do not look into the laser light window or shine the laser light beam on yourself or others. See the warning messages on the back of the remote control prior to using it.**

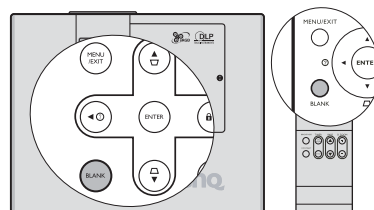

☞ **When the projector lamp is in Dual-Brightest mode, once BLANK is pressed, the projector lamp enters Dual-Reliable mode automatically.**

⚠ **Do not block the projection lens from projecting as this could cause the blocking object to become heated and deformed or even cause a fire.**

Freezing the image

Press **FREEZE** on the remote control to freeze the image. The word '**FREEZE**' will display in the upper left corner of the screen. To release the function, press any key except **PAGE ▲/▼** and **LASER** on the remote control.

Even if an image is frozen on the screen, the pictures are running on the video or other device. If the connected devices have active audio output, you will still hear the audio even though the image is frozen onscreen.

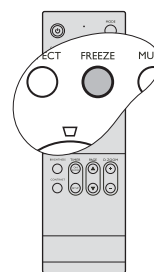

Utilizing FAQ function

The **INFORMATION** menu contains possible solutions to problems encountered by users regarding image quality, installation, special feature operation and service information.

To get the FAQ information:

1. Press **◀/?** or press **MENU/EXIT** to open the OSD menu and press **◀/▶** to highlight the **INFORMATION** menu.
2. Press **▼** to highlight **FAQ-Image and Installation** or **FAQ-Features and Service** based on the information you want to know.
3. Press **ENTER**.
4. Press **▲/▼** to select the a problem and press **ENTER** for possible solutions.

To exit the OSD menu, press **MENU/EXIT**.

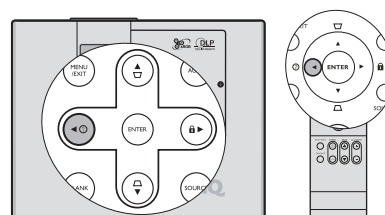

Locking control keys

With the control keys on the projector locked, you can prevent your projector settings from being changed accidentally (by children, for example). When the **Panel Key Lock** is on, no control keys on the projector will operate except **Power**.

1. Press **▶/🔒** or go to the **SYSTEM SETUP: Basic > Panel Key Lock** menu, and select **On** by pressing **◀/▶**. A confirmation message displays.
2. Highlight **Yes** and press **ENTER** to confirm.

To release panel key lock, press and hold **▶/🔒** on the remote control or projector for 3 seconds.

You can also use the remote control to enter the **SYSTEM SETUP: Basic > Panel Key Lock** menu and press **◀/▶** to select **Off**.

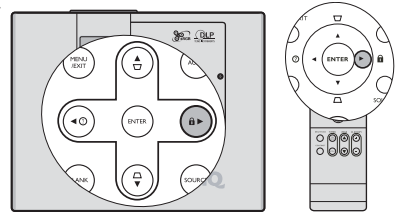

- Keys on the remote control are still in use when panel key lock is enabled.
- If you press Power to turn off the projector without disabling panel key lock, the projector will still be in locked status the next time it is turned on.

Operating in a high altitude environment

We recommend you use the **High Altitude Mode** when your environment is between 1500 m–3000 m above sea level, and temperature is between 0°C–35°C.

⚠ Do not use the High Altitude Mode if your altitude is between 0 m and 1500 m and temperature is between 0°C and 35°C. The projector will be over cooled, if you turn the mode on under such condition.

To activate the **High Altitude Mode**,

1. Press **MENU/EXIT** and then press **◀/▶** until the **SYSTEM SETUP: Advanced** menu is highlighted.
2. Press **▼** to highlight **High Altitude Mode** and press **◀/▶** to select **On**. A confirmation message displays.
3. Highlight **Yes** and press **ENTER**.

Operation under **High Altitude Mode** may cause a higher decibel operating noise level because of increased fan speed necessary to improve overall system cooling and performance.

If you use this projector under other extreme conditions excluding the above, it may display auto shut-down symptoms, which is designed to protect your projector from over-heating. In cases like this, you should switch to High Altitude mode to solve these symptoms.

However, this is not to state that this projector can operate under any and all harsh or extreme conditions.

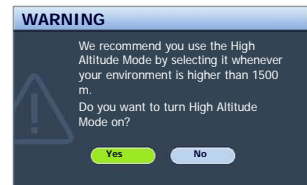

Creating your own startup screen

In addition to selecting the projector preset startup screen from among BenQ logo, Black or Blue screen, you can make your own startup screen that is a picture projected from your computer or video source.

To create your own startup screen, project the picture you want to use as your startup screen from either a computer or video source. The rest steps are as follows.

- Using the remote control
 1. Press **CAPTURE**.
 2. A confirmation message displays. Press **CAPTURE** or **ENTER** again.
 3. The message '**Screen Capturing...**' displays while the projector is processing the picture. Please wait.
 4. If the action is successful, you see the message '**Captured Succeeded**' on the screen. The captured picture is saved as **My Screen**.
 5. To view the captured picture displayed as the startup screen, set **My Screen** in the **SYSTEM SETUP: Basic > Splash Screen** menu and restart the projector.
- Using the OSD menu
 1. Press **MENU/EXIT** and then press ◀/▶ until the **SYSTEM SETUP: Basic** menu is highlighted.
 2. Press ▼ to highlight **My Screen** and press **ENTER**.
 3. Repeat steps 2-5 in the "[Using the remote control](#)" section to capture and view the captured picture.

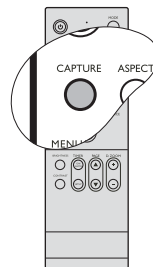

In the unlikely event that the capturing action fails, change your target picture.

Adjusting the sound

The sound adjustments made as below will have an effect on the projector speakers. Be sure you have made a correct connection to the projector audio input. See "[Connection](#)" on page 16 for how the audio input is connected.

Muting the sound

To temporarily turn off the sound,

- Using the remote control
Press **MUTE** to temporarily turn off the sound. While the sound is off, the screen will display  in the upper right corner of the screen.

To restore the sound, press **MUTE** again.

- Using the OSD menu
 1. Press **MENU/EXIT** and then press ◀/▶ until the **SYSTEM SETUP: Advanced** menu is highlighted.
 2. Press ▼ to highlight **Audio Settings** and press **ENTER**. The **Audio Settings** page displays.
 3. Highlight **Mute** and press ◀/▶ to select **On**.
 4. To restore the sound, repeat steps 1-3 and press ◀/▶ to select **Off**.

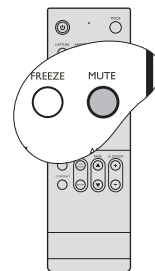

Adjusting the sound level

To adjust the sound level,

1. Repeat steps 1-2 above.
2. Press ▼ to highlight **Volume** and press ◀/▶ to select a desired sound level.

Turning off the Power on/off ring tone

To turn off the ring tone,

1. Repeat steps 1-2 above.
2. Press ▼ to highlight **Power on/off ring tone** and press ◀/▶ to select **Off**.

 **The only way to change Power on/off ring tone is setting On or Off here. Setting the sound mute or changing the sound level will not affect the Power on/off ring tone.**

Setting the lamp mode

This projector is capable of dual-lamp projection and provides three lamp modes for different purposes:

Lamp mode	User Benefit	Suitable environment
Dual-Brightest (Two lamps are used in normal mode)	<ul style="list-style-type: none"> Delivering super-bright and clear images Suitable for high-ambient-light environments Allowing continuous and non-stop operation under critical situations 	Large, well lit meeting rooms or auditoriums
Dual-Reliable (Two lamps are used in economic mode)	<ul style="list-style-type: none"> Extending the lamp life Allowing continuous and non-stop operation under critical situations 	Mid-large boardrooms
Single-Alternative (The lamp with shorter operating hours is selected automatically and used in normal mode)	<ul style="list-style-type: none"> Extending the total operation time Reducing lamp replacement frequency 	Normal sized rooms

You can perform the following steps to choose a lamp mode according to your preference.

1. Press **MENU/EXIT** and then press **◀/▶** until the **SYSTEM SETUP: Advanced** menu is highlighted.
2. Press **▼** to highlight **Lamp Settings** and press **ENTER**.
3. Press **▼** to highlight **Lamp Mode** and press **ENTER**.
4. Press **▼** to highlight your preferred lamp mode and press **ENTER**.
5. A confirmation message displays. Highlight **Yes** and press **ENTER**.

- ☞ **If one lamp fails, the projector enters Single-Alternative mode automatically. Dual-Brightest and Dual-Reliable settings are not available.**
- **After switching from Dual-Brightest/Dual-Reliable mode to Single-Alternative mode or vice versa, wait for 90 seconds before you can adjust the lamp mode again.**
- **Setting the projector in Dual-Reliable mode extends the lamp timer automatic shutdown feature. See "Setting Lamp Mode as Dual-Reliable" on page 47 for details.**

Personalizing the On-Screen Display (OSD) menus

The On-Screen Display (OSD) menus can be set according to your preferences. The following settings do not affect the projection settings, operation, or performance.

- **Menu Display Time** in the **SYSTEM SETUP: Advanced > Menu Settings** menu sets the length of time the OSD will remain active after your last key press. The time length ranges from 5 to 30 seconds in 5-second increments. Use **◀/▶** to select a suitable time.
- **Menu Position** in the **SYSTEM SETUP: Advanced > Menu Settings** menu sets the OSD position in five locations. Use **◀/▶** to select a preferred position.
- **Language** in the **SYSTEM SETUP: Basic** menu sets your familiar language for the On-Screen (OSD) Menus. Use **◀/▶** to select your language.
- **Splash Screen** in the **SYSTEM SETUP: Basic** menu sets a preferred logo screen to be displayed during projector start-up. Use **◀/▶** to select a screen.

Shutting down the projector

1. Press **Power** and a confirmation message displays prompting you.
If you don't respond in a few seconds, the message will disappear.
If you want to cancel the message, press any key except **PAGE ▲/▼** and **LASER** on the remote control.

! Do not look into the laser light window or shine the laser light beam on yourself or others. See the warning messages on the back of the remote control prior to using it.

2. Press **Power** a second time. The **POWER indicator light** flashes orange, the projection lamp shuts down, and the fans will continue to run for approximately 90 seconds to cool down the projector.
3. Once the cooling process finishes, a "**Power Off Ring Tone**" will be heard. The **POWER indicator light** is a steady orange and fans stop.
4. Disconnect the power cord from the wall socket if the projector will not be used in an extended period of time.

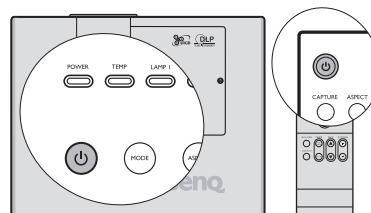

- To protect the lamp, the projector will not respond to any commands during the cooling process.
- To shorten the cooling time, you can also activate the Quick cooling function. See "[Quick Cooling](#)" on page 44 for details.
- To turn off the power ring tone, see "[Turning off the Power on/off ring tone](#)" on page 38 for details.

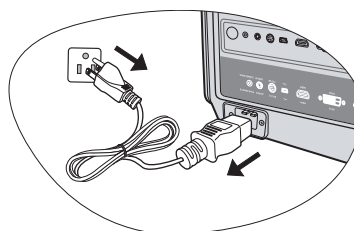

- If the projector is not properly shut down, to protect the lamp, when you attempt to re-start the projector, the fans will run for a few minutes to cool down. Press **Power** again to start the projector after the fans stop and the **POWER indicator light** turns orange.

On-Screen Display (OSD) Menus

Menu structure

Please note that the on-screen display (OSD) menus vary according to the signal type selected. Some functions are available only when certain input signals are in use.



The menu items are available when the projector detects at least one valid signal. If there is no equipment connected to the projector or no signal detected, limited menu items are accessible.

Main menu	Sub-menu	Options	
1. DISPLAY	Wall Color	Off/Light Yellow/Pink/Light Green/Blue/Blackboard	
	Aspect Ratio	4:3/16:9/Auto/Real	
	Keystone		
	Position		
	Phase		
	H. Size		
	Digital Zoom		
2. PICTURE	Picture Mode	PC source: Dynamic/Presentation/sRGB/Cinema/User 1/User 2 Video source: Dynamic/Standard/Cinema/User 1/User 2	
	Reference Mode	PC source: Dynamic/Presentation/sRGB/Cinema Video source: Dynamic/Standard/Cinema	
	Brightness		
	Contrast		
	Color		
	Tint		
	Sharpness		
	Brilliant Color	On/Off	
	Color Temperature	T1/T2/T3/T4	
	3D Color Management	Primary Color Hue Saturation Gain	
	Save Settings		
	3. SOURCE	Quick Auto Search	On/Off
		Color Space Conversion	RGB/YUV
6. INFORMATION	FAQ-Image and Installation		
	FAQ-Features and Service		
	Current System Status	<ul style="list-style-type: none"> • Source • Picture Mode • Resolution • Color System • Lamp Mode • Equivalent Lamp #1 Hour • Equivalent Lamp #2 Hour 	

	Timer Period	1~240 minutes	
	Timer Display	Always/1 min/2 min/3 min/Never	
	Timer Position	Bottom-Right/Top-Right/Bottom-Left/Top-Left	
	Presentation Timer	Timer Counting Direction	Count Down/Count Up
		Timer Audible Reminder	On/Off
		On/Off	
4. SYSTEM SETUP: Basic	Language	English / Français / Deutsch / Italiano / Español / Русский / 繁體中文 / 简体中文 / 日本語 / 한국어 / Svenska / Nederlands / Türkçe / Čeština / Português / తెలుగు / Polski	
	Projector Position	Front Table/Rear Table/Rear Ceiling/ Front Ceiling	
	Auto Power Off	Disable/5 min/10 min/15 min/20 min/25 min/30 min	
	Blank Timer	Disable/5 min/10 min/15 min/20 min/25 min/30 min	
	Panel Key Lock	On/Off	
	Sleep Timer	Disable/30 min/1 hr/2 hr/3 hr/4 hr/8 hr/12 hr	
	Splash Screen	BenQ/Black/Blue/My Screen	
	My Screen		
		Quick Cooling	On/Off
		High Altitude Mode	On/Off
		Audio Settings	Mute Volume Power on/off ring tone
			On/Off
5. SYSTEM SETUP: Advanced	Menu Settings	Menu Display Time	5 sec/10 sec/15 sec/20 sec/25 sec/30 sec
		Menu Position	Center/Top-Left/Top-Right/Bottom-Right/Bottom-Left
	Lamp Settings	Lamp Mode	Dual-Brightest Dual-Reliable Single-Alternative
		Reset Lamp #1 Timer	
		Reset Lamp #2 Timer	
		Equivalent Lamp #1 Hour	
		Equivalent Lamp #2 Hour	
		Change Password	
	Security Settings	Change Security Settings	<ul style="list-style-type: none"> • Power On Lock • Splash Screen Lock
		Baud Rate	2400/4800/9600/14400/19200/38400/57600/115200
		Test Pattern	On/Off
		Reset All Settings	

The default values listed in this manual, especially on pages 43-45, are for reference only. They may vary from the projectors due to the continuous improvement to the products.

Description of each menu

	FUNCTION (default setting/value)	DESCRIPTION
1. DISPLAY menu	Wall Color (Off)	Corrects the projected picture's color when the projection surface is not white. See " Using Wall Color " on page 31 for details.
	Aspect Ratio (Auto)	There are four options to set the image's aspect ratio depending on your input signal. See " Selecting the aspect ratio " on page 30 for details.
	Keystone (0)	Corrects any keystone of the image. See " Correcting keystone " on page 29 for details.
	Position (0)	Displays the position adjustment page. To move the projected image, use the directional arrow keys. The values shown on the lower position of the page change with every key press you made until they reach their maximum or minimum.
	Phase (depends on the selected input signal)	Adjusts the clock phase to reduce image distortion. 
	H. Size (depends on the selected input signal)	Adjusts the horizontal width of the image.
	Digital Zoom (100%)	Magnifies or reduces the projected image. See " Magnifying and searching for details " on page 29 for details.
2. PICTURE menu	Picture Mode (PC/DVI-D: Dynamic ; YPbPr/ S-Video/ Video/ HDMI/HDCP: Standard)	Pre-defined picture modes are provided so you can optimize your projector image set-up to suit your program type. See " Selecting a picture mode " on page 31 for details.
	Reference Mode	Selects a picture mode that most suits your need for the image quality and further fine-tune the image based on the selections listed on the same page below. See " Setting the User 1/User 2 mode " on page 32 for details.
	Brightness	Adjusts the brightness of the image. See " Adjusting Brightness " on page 32 for details.
	Contrast	Adjusts the degree of difference between dark and light in the image. See " Adjusting Contrast " on page 32 for details.
	Color (0)	Adjusts the color saturation level -- the amount of each color in a video image. See " Adjusting Color " on page 32 for details.
	Tint (0)	Adjusts the red and green color tones of the image. See " Adjusting Tint " on page 32 for details.  The function is only available when Video or S-Video with NTSC system is selected.
	Sharpness (15)	Adjusts the image to make it look sharper or softer. See " Adjusting Sharpness " on page 32 for details.
	Brilliant Color (On)	See " Adjusting Brilliant Color " on page 33 for details.
	Color Temperature (T3)	See " Selecting a color temperature " on page 33 for details.
	3D Color Management	See " 3D Color Management " on page 33 for details.
	Save Settings	Saves the settings made for User 1 or User 2 mode.

	FUNCTION (default setting/value)	DESCRIPTION
3. SOURCE menu	Quick Auto Search (On)	See "Switching input signal" on page 27 for details.
	Color Space Conversion (RGB)	See "Changing Color Space" on page 27 for details.
4. SYSTEM SETUP: Basic menu	Presentation Timer	Reminds the presenter to finish the presentation within a certain time frame. See "Setting the presentation timer" on page 34 for details.
	Language	Sets the language for the On-Screen Display (OSD) menus. See "Using the On-Screen Display (OSD) menus" on page 24 for details.
	Projector Position (Front Table)	The projector can be installed on a ceiling or behind a screen, or with one or more mirrors. See "Choosing a location" on page 12 for details.
	Auto Power Off (Disable)	Allows the projector to turn off automatically if no input signal is detected after a set period of time. See "Setting Auto Power Off" on page 47 for details.
	Blank Timer (Disable)	Sets the image blank time when the Blank feature is activated, once elapsed the image will return to the screen. See "Hiding the image" on page 36 for details.
	Panel Key Lock (Off)	Disables or enables all panel key functions except Power on the projector and keys on the remote control. See "Locking control keys" on page 37 for details.
	Sleep Timer (Disable)	Sets the auto-shutdown timer. The timer can be set to a value between 30 minutes and 12 hours.
	Splash Screen (BenQ logo)	Allows you to select which logo screen will display during projector start-up. Four options are available: BenQ logo, Black screen, Blue screen or My Screen.
	My Screen	Captures and stores the projected picture as My Screen. See "Creating your own startup screen" on page 38 for details.
5. SYSTEM SETUP: Advanced menu	Quick Cooling (Off)	Enables or disables the Quick Cooling function. Selecting On enables the function and projector cooling time will be shortened from a normal 90-second duration to approximately 30 seconds.  If you attempt to restart the projector right after the 30-second quick cooling process, it will rerun its cooling fans for approximately 60 seconds before energizing the lamp.
	High Altitude Mode (Off)	A mode for operation in high altitude areas. See "Operating in a high altitude environment" on page 37 for details.
	Audio Settings	Mute (Off) Volume (5) Power on/off ring tone (On) See "Adjusting the sound" on page 38 for details.
	Menu Settings	Menu Display Time (5 sec) Sets the length of time the OSD will remain active after your last key press. The range is from 5 to 30 seconds in 5-second increments. Menu Position (Center) Sets the On-Screen Display (OSD) menu position.

FUNCTION (default setting / value)	DESCRIPTION
5. SYSTEM SETUP: Advanced menu	Lamp Settings Lamp Mode (Dual-Brightest) See "Setting the lamp mode" on page 39 for details. Reset Lamp #1 Timer Reset Lamp #2 Timer Once the lamp is renewed, select Reset to return the corresponding lamp timer to '0'. See "Resetting the corresponding lamp timer" on page 49 for details. Equivalent Lamp #1 Hour Equivalent Lamp #2 Hour Displays the number of hours the lamp has been used. See "Getting to know the lamp hour" on page 46 for details on how the total lamp hour is calculated.
	Security Settings Change Password You will be asked to enter the current password before changing to a new one. See "Utilizing the password function" on page 25 for details. Change Security Settings Power On Lock (Off) Splash Screen Lock (Off) See "Utilizing the password function" on page 25 for details.
	Baud Rate (115200) For service personnel and professional technicians use. The baud rate should be adjusted to fit your equipment.
	Test Pattern (Off) Displays the grid test pattern. It helps you adjust the image size and the focus to ensure that the projected image is free of distortion.
	Reset All Settings  The following settings will still remain: Position, Phase, H. Size, User 1, User 2, Color Space Conversion, Language, Projector Position, My Screen, High Altitude Mode, Lamp Settings, Security Settings.
6. INFORMATION menu	FAQ-Image and Installation FAQ-Features and Service Displays possible solutions to problems you may encounter.
	Current System Status Source Shows the current signal source. Picture mode Shows the selected mode in the PICTURE menu. Resolution Shows the native resolution of the input signal. Color system Shows input system format, NTSC, PAL, SECAM, or RGB. Lamp Mode Shows the current lamp mode status. Equivalent Lamp #1 Hour Equivalent Lamp #2 Hour Displays the number of hours the lamp has been used.

 The INFORMATION menu shows you the current operating status of the projector.

Maintenance

Care of the projector

Your projector needs little maintenance. The only thing you need to do on a regular basis is to keep the lens clean. Never remove any parts of the projector except the lamp. Contact your dealer if other parts need replacing.

Cleaning the lens

Clean the lens whenever you notice dirt or dust on the surface.

- Use a canister of compressed air to remove dust.
- If there is dirt or smears, use lens-cleaning paper or moisten a soft cloth with lens cleaner and gently wipe the lens surface.

 **Never rub the lens with abrasive materials.**

Cleaning the projector case

Before you clean the case, turn the projector off using the proper shutdown procedure as described in "[Shutting down the projector](#)" on page 40 and unplug the power cord.

- To remove dirt or dust, wipe the case with a soft, lint-free cloth.
- To remove stubborn dirt or stains, moisten a soft cloth with water and a neutral pH detergent. Then wipe the case.

 **Never use wax, alcohol, benzene, thinner or other chemical detergents. These can damage the case.**

Storing the projector

If you need to store the projector for an extended time, please follow the instructions below:

- Make sure the temperature and humidity of the storage area are within the recommended range for the projector. Please refer to "[Specifications](#)" on page 52 or consult your dealer about the range.
- Retract the adjuster feet.
- Remove the batteries from the remote control.
- Pack the projector in its original packing or equivalent.

Transporting the projector

It is recommended that you ship the projector with its original packing or equivalent. When you carry the projector yourself, please use the original box or a suitable soft carry case.

Lamp information

Getting to know the lamp hour

When the projector is in operation, the duration (in hours) of lamp usage is automatically calculated by the built-in timer. The method of calculating the equivalent lamp hour is as follows:

Total (equivalent) lamp hour
 = 1 (hours used in Dual-Reliable mode) + 3/2 (hours used in Dual-Brightest mode) + 3/2 (hours used in Single-Alternative mode)

 **See "[Setting the lamp mode](#)" on page 39 below for more information.**

To obtain the lamp hour information:

1. Press **MENU/EXIT** and then press **◀/▶** until the **SYSTEM SETUP: Advanced** menu is highlighted.
2. Press **▼** to highlight **Lamp Settings** and press **ENTER**. The **Lamp Settings** page displays.
3. You will see the **Equivalent Lamp #1 Hour/Equivalent Lamp #2 Hour** information displaying on the menu.
4. To leave the menu, press **MENU/EXIT**.

You can also get the lamp hour information on the **INFORMATION** menu.

Extending lamp life

The projection lamp is a consumable item that normally can last up to 2000-3000 hours with proper usage. To keep the lamp life as long as possible, you can do the following settings via the OSD menus.

- **Setting Lamp Mode as Dual-Reliable**

Compared to **Dual-Brightest** mode, using **Dual-Reliable** mode reduces system noise and power consumption. If the **Dual-Reliable** mode is selected, the light output for the individual lamp will be reduced.

Setting the projector in **Dual-Reliable** mode also extends the individual lamp operation life. See "[Setting the lamp mode](#)" on page 39 for how **Dual-Reliable** mode is set.

- **Setting Auto Power Off**

This function allows the projector to turn off automatically if no input signal is detected after a set period of time to prevent unnecessary waste of lamp life.

To set **Auto Power Off**, go into the **SYSTEM SETUP: Basic > Auto Power Off** menu and press ◀/▶. The time period can be set from 5 to 30 minutes in 5-minute increments. If the preset time lengths are not suitable for your presentation, select **Disable**. The projector will not automatically shut down in a certain time period.

Timing of replacing the lamp

When the **LAMP indicator light** is red or a message appears suggesting it is time to replace the lamp, please install a new lamp or consult your dealer. An old lamp may cause a malfunction in the projector and in some instances the lamp may explode.

⚠ **The LAMP indicator light and TEMPerature indicator light will light up if the lamp becomes too hot. Turn the power off and let the projector cool for 45 minutes. If the LAMP or TEMPerature indicator light still lights up after turning the power back on, please contact your dealer. See "[Indicators](#)" on page 50 for details.**

The following Lamp warning displays will remind you to change lamp 1 or lamp 2. Warning messages for lamp 1 are illustrated below.

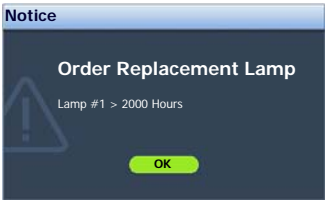
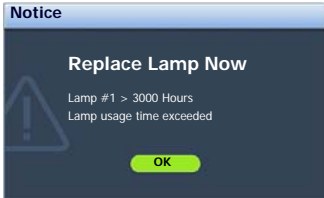
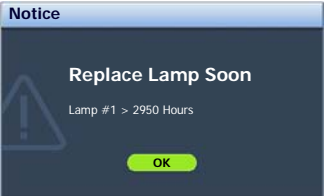
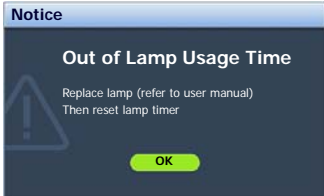
Status & Message	Status & Message
<ul style="list-style-type: none"> • The lamp has been in operation for 2000 hours. Install a new lamp for optimal performance. If the projector is normally run with Dual-Reliable Mode selected (See "Lamp Mode (Dual-Brightest)" on page 45), you may continue to operate the projector until the 2950 hour lamp warning appears. 	<ul style="list-style-type: none"> • The lamp has been in operation for 3000 hours. It is strongly recommended that you replace the lamp at this age. The lamp is a consumable item. The lamp brightness diminishes with use. This is normal lamp behavior. You can replace the lamp whenever you notice that the brightness level has significantly diminished. If the lamp is not replaced beforehand, it must be replaced after 3000 hours usage. 
<ul style="list-style-type: none"> • The lamp has been in operation for 2950 hours. A new lamp should be fitted to avoid the inconvenience when the projector runs out of lamp time. 	<ul style="list-style-type: none"> • The lamp MUST be replaced before the projector will operate normally. 

Replacing the lamp

- ⚠ • To reduce the risk of electrical shock, always turn the projector off and disconnect the power cord before changing the lamp.
- To reduce the risk of severe burns, allow the projector to cool for at least 45 minutes before replacing the lamp.
- To reduce the risk of injuries to fingers and damage to internal components, use caution when removing lamp glass that has shattered into sharp pieces.
- To reduce the risk of injuries to fingers and/or compromising image quality by touching the lens, do not touch the empty lamp compartment when the lamp is removed.
- This lamp contains mercury. Consult your local hazardous waste regulations to dispose of this lamp in a proper manner.
- Since a pair of non-interchangeable lamps is designed for this projector, only the specified BenQ projector lamp can be used for lamp replacement. Make sure the correct lamp is purchased beforehand.
- If lamp replacement is performed while the projector is suspended upside-down from the ceiling, make sure that no one is underneath the lamp socket to avoid any possible injury or damage to the human eyes caused by fractured lamp.

1. Turn the power off and disconnect the projector from the wall socket. If the lamp is hot, avoid burns by waiting for approximately 45 minutes until the lamp has cooled.
2. Loosen the screw on the lamp cover with a slotted screwdriver.
4. Identify the lamp you want to replace by looking at the top of the lamp.

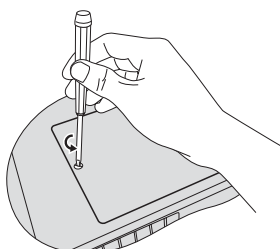

3. Remove the lamp cover from the projector.

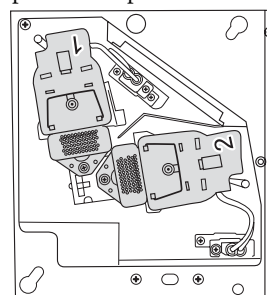
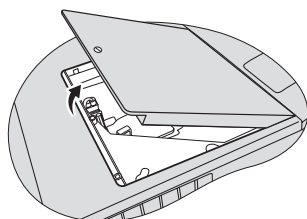

5. Loosen the screws that secure the lamp and the lamp connector.

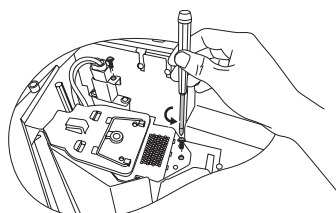

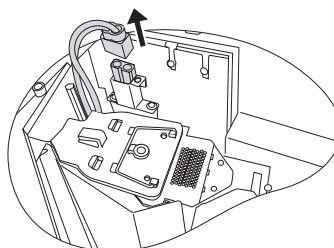

6. Disconnect the lamp connector from the projector.

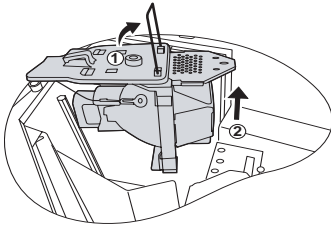

- ⚠ **Do not turn the power on with the lamp cover removed.**

7. Lift the handle so that it stands up. Use the handle to slowly pull the lamp out of the projector.



 **Pulling it too quickly may cause the lamp to break and scatter broken glass in the projector.**

Do not place the lamp in locations where water might splash on it, children can reach it, or near flammable materials.

Do not insert your hands into the projector after the lamp is removed. If you touch the optical components inside, it could cause color unevenness and distortion of the projected pictures.

8. As shown in the figure, hold the new lamp and align the two locators on the lamp with the holes on the projector, and then insert the lamp all the way into the projector.

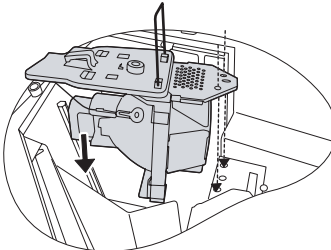

9. Tighten the screw that secures the lamp.
10. Connect the lamp connector to the projector and tighten the screw that secures the lamp connector.

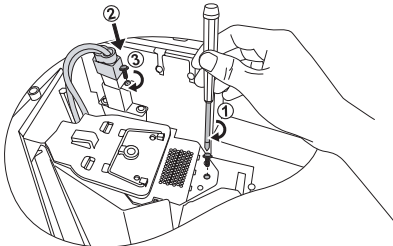

 **Loose screw may cause a bad connection, which could result in malfunction.**

Do not over tighten the screw.

11. Ensure the handle is fully laid flat and locked in place.

12. Replace the lamp cover on the projector.

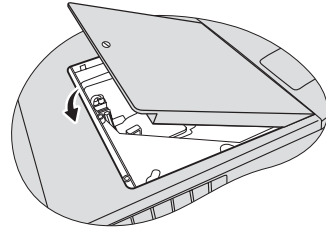

13. Tighten the screw that secures the lamp cover.

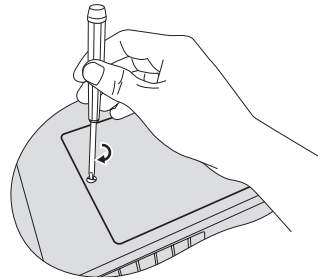

 **Loose screw may cause a bad connection, which could result in malfunction.**

Do not over tighten the screw.

14. Restart the projector.



Do not turn the power on with the lamp cover removed.

Resetting the corresponding lamp timer

15. After the startup logo, open the On-Screen Display (OSD) menu.

Go to the **SYSTEM SETUP: Advanced > Lamp Settings** menu.

Press **ENTER** and the **Lamp Settings** page displays.

Highlight **Reset Lamp #1 Timer/Reset Lamp #2 Timer**. A warning message displays asking if you want to reset the lamp timer.

Highlight **Reset** and press **ENTER** on the projector or remote control. The lamp time will be reset to '0'.

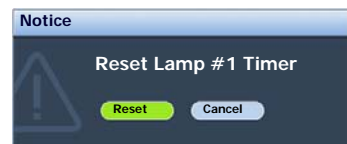

Do not reset if the lamp is not new or replaced as this could cause damage.

Indicators

Light				Status & Description
POWER	TEMP	LAMP1	LAMP2	
Power events				
Orange	Off	Off	Off	Stand-by mode.
Green Flashing	Off	Off	Off	Powering up.
Green	Off	Off	Off	Normal operation.
Orange Flashing	Off	Off	Off	<ol style="list-style-type: none"> The projector needs 90 seconds to cool down as it was abnormally shut down without the normal cooling down process. Or The projector needs to cool for 90 seconds after the power is turned off.
Orange Flashing	Off	Off	Off	The projector has shutdown automatically. If you try to re-start the projector, it will shutdown again. Please contact your dealer for assistance.
Orange Flashing	Off	Red	Off	
Lamp events				
Off	Off	Red	Off	Lamp 1 failed. The projector has entered Single-Alternative mode automatically. Replace lamp 1 as soon as possible.
Off	Off	Off	Red	Lamp 2 failed. The projector has entered Single-Alternative mode automatically. Replace lamp 2 as soon as possible.
Off	Off	Red	Red	The projector has shutdown automatically. If you try to re-start the projector, it will shutdown again. Please contact your dealer for assistance.
Thermal events				
Off	Red	Off	Off	The projector has shutdown automatically. If you try to re-start the projector, it will shutdown again. Please contact your dealer for assistance.
Off	Red	Red	Off	
Off	Red	Green	Off	
Off	Red	Orange	Off	
Off	Red	Off	Red	
Off	Red	Off	Green	
Off	Red	Off	Orange	
Red	Red	Red	Off	
Red	Red	Green	Off	
Red	Red	Orange	Off	
Green	Red	Red	Off	

Troubleshooting

② The projector does not turn on.

Cause	Remedy
There is no power from the power cable.	Plug the power cord into the AC inlet on the projector, and plug the power cord into the power outlet. If the power outlet has a switch, make sure that it is switched on.
Attempting to turn the projector on again during the cooling process.	Wait until the cooling down process has completed.

② No picture

Cause	Remedy
The video source is not turned on or connected correctly.	Turn the video source on and check that the signal cable is connected correctly.
The projector is not correctly connected to the input signal device.	Check the connection.
The input signal has not been correctly selected.	Select the correct input signal with the SOURCE key on the projector or remote control.
The lens cover is still closed.	Open the lens cover.

② Blurred image

Cause	Remedy
The projection lens is not correctly focused.	Adjust the focus of the lens using the focus ring.
The projector and the screen are not aligned properly.	Adjust the projection angle and direction as well as the height of the projector if necessary.
The lens cover is still closed.	Open the lens cover.

② Remote control does not work

Cause	Remedy
The batteries are out of power.	Replace the batteries with new ones.
There is an obstacle between the remote control and the projector.	Remove the obstacle.
You are too far away from the projector.	Stand within 8 meters (26 feet) of the projector.

② The password is incorrect

Cause	Remedy
You do not remember the password.	Please see " Entering the password recall procedure " on page 26 for details.

Specifications

Projector specifications

 All specifications are subject to change without notice.

Optical

Resolution
1024 x 768 XGA

Display system
1-CHIP DMD

Lens F/Number
F=2.4 to 2.55, f=23.88 to 27.46 mm

Lamp
280 W lamp x 2

Electrical

Power supply
AC 100–240 V, 7.7 A, 50-60 Hz (Automatic)

Power consumption
805 W (Max); 5 W (Standby)

Mechanical

Weight
11 kg

Output terminals

RGB output
D-Sub 15-pin (female) x 1

Speaker
(Stereo) 5 watt x 2

12 VDC (Max. 1 A)

Control

USB serial control
Type mini B

RS-232 serial control
Mini Din 8 pin x 1

Input terminals

Computer input
RGB input
D-Sub 15-pin (female) x 1
DVI-D input

Video signal input
S-VIDEO
Mini DIN 4-pin port x 1
VIDEO
RCA jack x 1
SD/HDTV signal input
Analog - Component RCA jack x 3,
D-Sub 15-pin
Digital - DVI-D (supports HDCP)
Digital - HDMI

Audio signal input
Audio in
PC audio jack x 1

Wire remote
2.5 mm wire jack

Environmental Requirements

Operating temperature
0°C–40°C at sea level

Operating relative humidity
10%–90% (without condensation)

Operating altitude
0–1499 m at 0°C–35°C
1500–3000 m at 0°C–30°C (with
High Altitude Mode on)

Dimensions

443.0 mm (W) x 167.0 mm (H) x 355.0 mm (D)

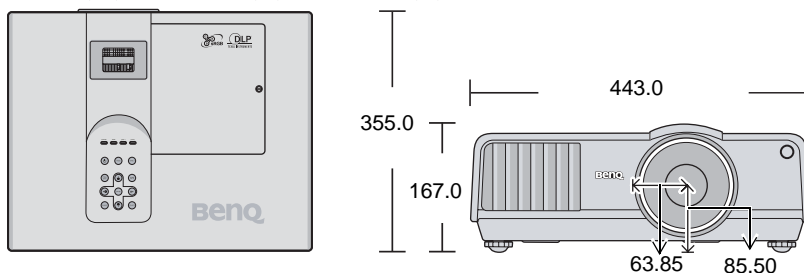

Timing chart

Supported timing for Analog RGB input

Resolution	Horizontal Frequency (kHz)	Vertical Frequency (Hz)	Pixel Frequency (MHz)	Mode
640 x 480	31.469	59.940	25.175	VGA_60
	37.861	72.809	31.500	VGA_72
	37.500	75.000	31.500	VGA_75
	43.269	85.008	36.000	VGA_85
720 x 400	31.469	70.087	28.3221	720 x 400_70
800 x 600	37.879	60.317	40.000	SVGA_60
	48.077	72.188	50.000	SVGA_72
	46.875	75.000	49.500	SVGA_75
	53.674	85.061	56.250	SVGA_85
1024 x 768	48.363	60.004	65.000	XGA_60
	56.476	70.069	75.000	XGA_70
	60.023	75.029	78.750	XGA_75
	68.667	84.997	94.500	XGA_85
1280 x 800	49.65	59.96	83.500	WXGA_60
1280 x 1024	63.981	60.020	108.000	SXGA3_60
	79.976	75.025	135.000	SXGA3_75
	91.146	85.024	157.500	SXGA3_85
1280 x 960	60.000	60.000	108	1280 x 960_60
	85.938	85.002	148.500	1280 x 960_85
1440 x 900	55.935	59.887	106.500	WXGA+_60
	70.635	74.984	136.750	WXGA+_75
1400 x 1050	65.317	59.978	121.750	SXGA+_60
1600 x 1200	75.000	60.000	162.000	UXGA
640 x 480@67Hz	35.000	66.667	30.240	MAC13
832 x 624@75Hz	49.722	74.546	57.280	MAC16
1024 x 768@75Hz	60.241	75.020	80.000	MAC19
1152 x 870@75Hz	68.68	75.06	100.000	MAC21

Supported timing for Component-YPbPr input

Signal Format	Horizontal Frequency (kHz)	Vertical Frequency (Hz)
480i(525i)@60Hz	15.73	59.94
480p(525p)@60Hz	31.47	59.94
576i(625i)@50Hz	15.63	50.00
576p(625p)@50Hz	31.25	50.00
720p(750p)@60Hz	45.00	60.00
720p(750p)@50Hz	37.50	50.00
1080i(1125i)@60Hz	33.75	60.00
1080i(1125i)@50Hz	28.13	50.00
1080P@60HZ	67.5	60.00
1080P@50HZ	56.26	50.00

 Displaying a 1080i(1125i)@60Hz or 1080i(1125i)@50Hz signal may result in slight image vibration.

Supported timing for Video and S-Video inputs

Video mode	Horizontal Frequency (kHz)	Vertical Frequency (Hz)	Color sub-carrier Frequency (MHz)
NTSC	15.73	60	3.58
PAL	15.63	50	4.43
SECAM	15.63	50	4.25 or 4.41
PAL-M	15.73	60	3.58
PAL-N	15.63	50	3.58
PAL-60	15.73	60	4.43
NTSC4.43	15.73	60	4.43

Supported timing for DVI-D and HDMI (HDCP) input

Resolution	Horizontal Frequency (kHz)	Vertical Frequency (Hz)	Pixel Frequency (MHz)	Mode
720 x 400	31.469	70.087	28.3221	720 x 400_70
640 x 480	31.469	59.940	25.175	VGA_60
	37.861	72.809	31.500	VGA_72
	37.500	75.000	31.500	VGA_75
	43.269	85.008	36.000	VGA_85
800 x 600	37.879	60.317	40.000	SVGA_60
	48.077	72.188	50.000	SVGA_72
	46.875	75.000	49.500	SVGA_75
	53.674	85.061	56.250	SVGA_85
1024 x 768	48.363	60.004	65.000	XGA_60
	56.476	70.069	75.000	XGA_70
	60.023	75.029	78.750	XGA_75
	68.667	84.997	94.500	XGA_85
1280 x 800	49.65	59.96	83.458	WXGA_60
1280 x 1024	63.981	60.020	108.000	SXGA_60
	79.976	75.025	135.000	SXGA_75
	91.146	85.024	157.500	SXGA_85
1280 x 960	60.000	60.000	108.000	1280 x 960_60
	85.938	85.002	148.500	1280 x 960_85
1440 x 900	55.935	59.887	106.500	WXGA+_60
	70.635	74.984	136.750	WXGA+_75
1400 x 1050	65.317	59.978	121.750	SXGA+_60
1600 x 1200	75.000	60.000	162.000	UXGA
640 x 480@67Hz	35.000	66.667	30.240	MAC13
832 x 624@75Hz	49.722	74.546	57.280	MAC16
1024 x 768@75Hz	60.241	75.020	80.000	MAC19
1152 x 870@75Hz	68.68	75.06	100.000	MAC21
VIDEO	31.47	60	27	480p
	31.25	50	27.000	576p
	37.50	50	74.25	720p_50
	45.00	60	74.25	720p_60
	28.13	50	74.25	1080i_50
	33.75	60	74.25	1080i_60
	67.5	60	148.5	1080p
	56.26	50	148.5	1080p

☞ Displaying a 1080i_50 or 1080i_60 signal may result in slight image vibration.

Other information

Warranty and Copyright information

Limited warranty

BenQ warrants this product against any defects in material and workmanship, under normal usage and storage.

Proof of purchase date will be required with any warranty claim. In the event this product is found to be defective within the warranty period, BenQ's only obligation and your exclusive remedy shall be replacement of any defective parts (labor included). To obtain warranty service, immediately notify the dealer from which you purchased the product of any defects.

Important: The above warranty shall be void if the customer fails to operate the product in accordance with BenQ's written instructions, especially the ambient humidity must be in-between 10% and 90%, temperature in-between 0°C and 35°C, altitude lower than 4920 feet, and avoiding to operate the projector in a dusty environment. This warranty gives you specific legal rights, and you may have other rights which vary from country to country.

For other information, please visit www.BenQ.com.

Copyright

Copyright 2008 by BenQ Corporation. All rights reserved. No part of this publication may be reproduced, transmitted, transcribed, stored in a retrieval system or translated into any language or computer language, in any form or by any means, electronic, mechanical, magnetic, optical, chemical, manual or otherwise, without the prior written permission of BenQ Corporation.

Disclaimer

BenQ Corporation makes no representations or warranties, either expressed or implied, with respect to the contents hereof and specifically disclaims any warranties, merchantability or fitness for any particular purpose. Further, BenQ Corporation reserves the right to revise this publication and to make changes from time to time in the contents hereof without obligation to notify any person of such revision or changes.

*DLP, Digital Micromirror Device and DMD are trademarks of Texas Instruments. Others are copyrights of their respective companies or organizations.

Regulation statements

FCC statement

CLASS B: This equipment generates, uses and can radiate radio frequency energy and, if not installed and used in accordance with the instructions, may cause harmful interference to radio communications. However, there is no guarantee that interference will not occur in a particular installation. If this equipment does cause harmful interference to radio or television reception, which can be determined by turning the equipment off and on, the user is encouraged to try to correct the interference by one or more of the following measures:

- Reorient or relocate the receiving antenna.
- Increase the distance between the equipment and receiver.
- Connect the equipment into an outlet on a circuit different from that to which the receiver is connected.
- Consult the dealer or an experienced radio/TV technician for help.

EEC statement

This machine was tested against the 89/336/EEC (European Economic Community) for EMC (Electronic Magnetic Compatibility) and fulfills these requirements.

WEEE directive

Disposal of Waste Electrical and Electronic Equipment by users in private households in the European Union.

This symbol on the product or on the packaging indicates that this can not be disposed of as household waste. You must dispose of your waste equipment by handling it over to the applicable take-back scheme for the recycling of electrical and electronic equipment. For more information about recycling of this equipment, please contact your city office, the shop where you purchased the equipment or your household waste disposal service. The recycling of materials will help to conserve natural resources and ensure that it is recycled in a manner that protects human health and environment.



Free Manuals Download Website

<http://myh66.com>

<http://usermanuals.us>

<http://www.somanuals.com>

<http://www.4manuals.cc>

<http://www.manual-lib.com>

<http://www.404manual.com>

<http://www.luxmanual.com>

<http://aubethermostatmanual.com>

Golf course search by state

<http://golfingnear.com>

Email search by domain

<http://emailbydomain.com>

Auto manuals search

<http://auto.somanuals.com>

TV manuals search

<http://tv.somanuals.com>