

CHICAGO
Electric® Power Tools

PAINT SPRAYER
HVLP-ELECTRIC
Model 97750

SET UP AND OPERATING INSTRUCTIONS



Diagrams within this manual may not be drawn proportionally.
Due to continuing improvements, actual product may differ slightly from the product described herein.

Distributed exclusively by Harbor Freight Tools®.

3491 Mission Oaks Blvd., Camarillo, CA 93011

Visit our website at: <http://www.harborfreight.com>



Read this material before using this product.
Failure to do so can result in serious injury.
SAVE THIS MANUAL.

Copyright© 2008 by Harbor Freight Tools®. All rights reserved. No portion of this manual or any artwork contained herein may be reproduced in any shape or form without the express written consent of Harbor Freight Tools.

For technical questions or replacement parts, please call 1-800-444-3353.

SAVE THIS MANUAL

Keep this manual for the safety warnings and precautions, assembly, operating, inspection, maintenance and cleaning procedures. Write the product's serial number in the back of the manual near the assembly diagram (or month and year of purchase if product has no number). Keep this manual and the receipt in a safe and dry place for future reference.

IMPORTANT SAFETY INFORMATION

In this manual, on the labeling, and all other information provided with this product:



This is the safety alert symbol. It is used to alert you to potential personal injury hazards. Obey all safety messages that follow this symbol to avoid possible injury or death.

DANGER

DANGER indicates a hazardous situation which, if not avoided, will result in death or serious injury.

WARNING

WARNING indicates a hazardous situation which, if not avoided, could result in death or serious injury.

CAUTION

CAUTION, used with the safety alert symbol, indicates a hazardous situation which, if not avoided, could result in minor or moderate injury.

NOTICE

NOTICE is used to address practices not related to personal injury.

CAUTION

CAUTION, without the safety alert symbol, is used to address practices not related to personal injury.

GENERAL POWER TOOL SAFETY WARNINGS



WARNING Read all safety warnings and instructions.

Failure to follow the warnings and instructions may result in electric shock, fire and/or serious injury.

Save all warnings and instructions for future reference.

The term "power tool" in the warnings refers to your line-operated (corded) power tool.

1. **Work area safety**
 - a. **Keep work area clean and well lit.**
Cluttered or dark areas invite accidents.
 - b. **Do not operate power tools in explosive atmospheres, such as in the presence of flammable liquids, gases or dust.** *Power tools create sparks which may ignite the dust or fumes.*
 - c. **Keep children and bystanders away while operating a power tool.**
Distractions can cause you to lose control.
2. **Electrical safety**
 - a. **Power tool plugs must match the outlet. Never modify the plug in any way. Do not use any adapter plugs with grounded power tools.**

Unmodified plugs and matching outlets will reduce risk of electric shock.

- b. Avoid body contact with grounded surfaces such as pipes, radiators, ranges and refrigerators.** *There is an increased risk of electric shock if your body is grounded.*
 - c. Do not expose power tools to rain or wet conditions.** *Water entering a power tool will increase the risk of electric shock.*
 - d. Do not abuse the Power Cord (34).** **Never use the Cord for carrying, pulling or unplugging the power tool. Keep Cord away from heat, oil, sharp edges or moving parts.** *Damaged or entangled Cords increase the risk of electric shock.*
 - e. When operating a power tool outdoors, use an extension cord suitable for outdoor use.** *Use of a cord suitable for outdoor use reduces the risk of electric shock.*
 - f. If operating a power tool in a damp location is unavoidable, use a Ground Fault Circuit Interrupter (GFCI) protected supply.** *Use of a GFCI reduces the risk of electric shock.*
- 3. Personal safety**
 - a. Stay alert, watch what you are doing and use common sense when operating a power tool. Do not use a power tool while you are tired or under the influence of drugs, alcohol or medication.** *A moment of inattention while operating power tools may result in serious personal injury.*
 - b. Use safety equipment. Always wear ANSI-approved safety impact goggles and NIOSH-approved dust**
- mask/respirator.** *Safety equipment such as non-skid safety shoes, hard hat, or hearing protection used for appropriate conditions will reduce personal injuries.*
 - c. Prevent unintentional starting.** **Ensure the Power Switch (33) is in the off-position before connecting to the power source, picking up or carrying the tool.** *Carrying power tools with your finger on the Power Switch or energizing power tools that have the Power Switch on invites accidents.*
 - d. Remove any adjusting key or wrench before turning the power tool on.** *A wrench or a key left attached to a rotating part of the power tool may result in personal injury.*
 - e. Do not overreach. Keep proper footing and balance at all times.** *This enables better control of the power tool in unexpected situations.*
 - f. Dress properly. Do not wear loose clothing or jewelry. Keep your hair, clothing and gloves away from moving parts.** *Loose clothes, jewelry or long hair can be caught in moving parts.*
- 4. Power tool use and care**
 - a. Do not force the power tool. Use the correct power tool for your application.** *The correct power tool will do the job better and safer at the rate for which it was designed.*
 - b. Do not use the power tool if the Power Switch (33) does not turn it on and off.** *Any power tool that cannot be controlled with the Power Switch is dangerous and must be repaired.*

- c. **Disconnect the Power Cord (34)** from the power source before making any adjustments, changing accessories, or storing power tools. *Such preventive safety measures reduce the risk of starting the power tool accidentally.*
 - d. **Store idle power tools out of the reach of children and do not allow persons unfamiliar with the power tool or these instructions to operate the power tool.** *Power tools are dangerous in the hands of untrained users.*
 - e. **Maintain power tools.** Check for misalignment or binding of moving parts, breakage of parts and any other condition that may affect the power tool's operation. If damaged, have the power tool repaired before use. *Many accidents are caused by poorly maintained power tools.*
 - f. **Keep the power tool clean.** *Improper cleaning of the Paint Sprayer and its accessories is a common reason for the Spray Gun to jam or not perform properly.*
 - g. **Use the power tool, accessories and tool bits etc. in accordance with these instructions, taking into account the working conditions and the work to be performed.** *Use of the power tool for operations different from those intended could result in a hazardous situation.*
- 5. Service**
- a. **Have your power tool serviced by a qualified repair person using only identical replacement parts.** *This will ensure that the safety of the power tool is maintained.*

SPECIFIC SAFETY WARNINGS

1. **Maintain labels and nameplates on the Paint Sprayer.** *These carry important safety information. If unreadable or missing, contact Harbor Freight Tools for a replacement.*
2. **Avoid unintentional starting.** *Prepare to begin work before turning on the Paint Sprayer.*
3. **For your safety, maintenance should be performed regularly by a qualified service technician.** *The Paint Sprayer and its accessories must be thoroughly cleaned after every use.*
4. **Do not spray near open flames, pilot lights, stoves, heaters, or any other heat source.** *Most solvents and coatings are highly flammable, particularly when sprayed. Do not smoke while spraying.*
5. **Read all of the information concerning coating products and cleaning solvents.** *Chlorinated solvents (i.e., trichlorethylene and methylene chloride) can chemically react with aluminum and may explode. Many Paint Sprayers contain aluminum. If you have any doubt about potential chemical reactions contact the solvent or coating manufacturer.*
6. **Materials used when painting or cleaning may be harmful or fatal if inhaled or swallowed.** *Only use in an area with adequate ventilation. Use a NIOSH-approved dust mask or respirator when painting or using solvents.*

7. **Never release the Lower Cover (24) while the Cup (27) is pressurized.**
8. **Industrial applications must follow OSHA requirements.**
9. **Make sure air intake guard is in place before use.**
10. **Never point a Spray Gun at people or animals.** *Serious injury could occur.*
11. **Spraying hazardous materials may result in death or serious injury.** *Do not spray pesticides, acids, corrosive materials, fertilizers, and toxic chemicals.*
12. **Do not leave the Paint Sprayer unattended when it is plugged into an electrical outlet.** *Turn off the tool, and unplug it from its electrical outlet before leaving.*
13. **This product is not a toy.** *Keep it out of reach of children.*
14. **People with pacemakers should consult their physician(s) before use.** *Electromagnetic fields in close proximity to heart pacemaker could cause pacemaker interference or pacemaker failure. In addition, people with pacemakers should:*
 - *Avoid operating alone.*
 - *Do not use with power switch locked on.*
 - *Properly maintain and inspect to avoid electrical shock.*
 - *Any power cord must be properly grounded. Ground Fault Circuit Interrupter (GFCI) should also be implemented – it prevents sustained electrical shock.*
15. **Some dust created by power sanding, sawing, grinding, drilling,**

and other construction activities, contains chemicals known [to the State of California] to cause cancer, birth defects or other reproductive harm. *Some examples of these chemicals are:*

- *Lead from lead-based paints*
- *Crystalline silica from bricks and cement or other masonry products*
- *Arsenic and chromium from chemically treated lumber*

Your risk from these exposures varies, depending on how often you do this type of work. To reduce your exposure to these chemicals: work in a well ventilated area, and work with approved safety equipment, such as those dust masks that are specially designed to filter out microscopic particles. (California Health & Safety Code § 25249.5, et seq.)

16. **WARNING!** *The brass components of this product contain lead, a chemical known to the State of California to cause birth defects (or other reproductive harm). (California Health & Safety Code 25249.5, et seq.)*
17. **The warnings, precautions, and instructions discussed in this instruction manual cannot cover all possible conditions and situations that may occur.** *It must be understood by the operator that common sense and caution are factors which cannot be built into this product, but must be supplied by the operator.*



SAVE THESE INSTRUCTIONS.

GROUNDING

⚠️ WARNING TO PREVENT ELECTRIC SHOCK



AND DEATH FROM INCORRECT GROUNDING WIRE CONNECTION:

Check with a qualified electrician if you are in doubt as to whether the outlet is properly grounded. Do not modify the Power Cord Plug (34) provided with the tool. Never remove the grounding prong from the Plug. Do not use the tool if the Power Cord or Plug is damaged. If damaged, have it repaired by a service facility before use. If the Plug will not fit the outlet, have a proper outlet installed by a qualified electrician.

Grounded Tools: Tools with Three Prong Plugs

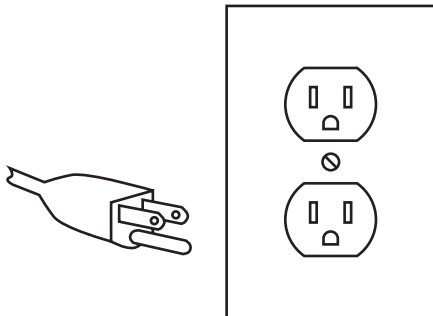

3-Prong Plug and Outlet

1. Tools marked with "Grounding Required" have a three wire cord and three prong grounding Plug. The plug must be connected to a properly grounded outlet. If the tool should electrically malfunction or break down, grounding provides a low resistance path to carry electricity away from the user, reducing the risk

of electric shock. (See 3-Prong Plug and Outlet.)

2. The grounding prong in the Plug is connected through the green wire inside the cord to the grounding system in the tool. The green wire in the cord must be the only wire connected to the tool's grounding system and must never be attached to an electrically "live" terminal. (See 3-Prong Plug and Outlet.)
3. The tool must be plugged into an appropriate outlet, properly installed and grounded in accordance with all codes and ordinances. The Plug and outlet should look like those in the preceding illustration. (See 3-Prong Plug and Outlet.)

Double Insulated Tools: Tools with Two Prong Plugs

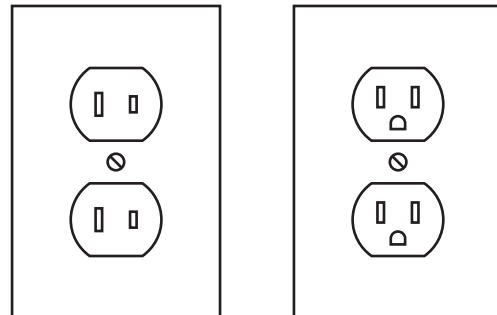

Outlets for 2-Prong Plug

1. Tools marked "Double Insulated" do not require grounding. They have a special double insulation system which satisfies OSHA requirements and complies with the applicable standards of Underwriters Laboratories, Inc., the Canadian Standard Association, and the National Electrical Code. (See Outlets for 2-Prong Plug.)

- Double insulated tools may be used in either of the 120 volt outlets shown in the preceding illustration. **(See Outlets for 2-Prong Plug.)**

Extension Cords

- Grounded** tools require a three wire extension cord. **Double Insulated** tools can use either a two or three wire extension cord.
- As the distance from the supply outlet increases, you must use a heavier gauge extension cord. Using extension cords with inadequately sized wire causes a serious drop in voltage, resulting in loss of power and possible tool damage. **(See Table A.)** The smaller the gauge number of the wire, the greater the capacity of the cord. For example, a 14 gauge cord can carry a higher current than a 16 gauge cord. **(See Table A.)**
- When using more than one extension cord to make up the total length, make sure each cord contains at least the minimum wire size required. **(See Table A.)**
- If you are using one extension cord for more than one tool, add the nameplate amperes and use the sum to determine the required minimum cord size. **(See Table A.)**
- If you are using an extension cord outdoors, make sure it is marked with the suffix "W-A" ("W" in Canada) to indicate it is acceptable for outdoor use.
- Make sure the extension cord is properly wired and in good electrical condition. Always replace a damaged







extension cord or have it repaired by a qualified electrician before using it.

- Protect the extension cords from sharp objects, excessive heat, and damp or wet areas.

RECOMMENDED MINIMUM WIRE GAUGE FOR EXTENSION CORDS* (120/240 VOLT)					
NAMEPLATE AMPERES (at full load)	EXTENSION CORD LENGTH				
	25'	50'	75'	100'	150'
0 – 2.0	18	18	18	18	16
2.1 – 3.4	18	18	18	16	14
3.5 – 5.0	18	18	16	14	12
5.1 – 7.0	18	16	14	12	12
7.1 – 12.0	18	14	12	10	-
12.1 – 16.0	14	12	10	-	-
16.1 – 20.0	12	10	-	-	-

TABLE A * Based on limiting the line voltage drop to five volts at 150% of the rated amperes.

Symbology

	Double Insulated
	Canadian Standards Association
	Underwriters Laboratories, Inc.
	Volts Alternating Current
	Amperes
	No Load Revolutions per Minute (RPM)

SPECIFICATIONS

Electrical Requirements	120 V~ / 60 Hz / 450 Watts 5.5 Amps (Start Up) 3.3 Amps (Load & No Load) Motor Speed: 30,000 RPM Power Plug: 2-Prong Power Switch: ON/OFF Rocker
Spray Cup Capacity	1 Quart
Output Pressure	1.45 to 4.35 PSI
Activation Method	Trigger Style
Fluid Control Knob	Clockwise (For round pattern) Counterclockwise (For flat pattern)
Air Control	Adjustable Lever
Adjustable Spray Patterns	Horizontal (2.0" H x 6-1/4" W) Vertical (6-1/4" H x 2.0" W) Round (2-1/2" Diameter)
Product Limitations	Not recommended for use with latex and other water-based paints.
Construction Materials	Polypropylene Housing Rubber/Thermoplastic Hose Brass Needle & Knob Aluminum Paint Cup & Nozzle Sheet Steel Trigger Polyester Shoulder Strap Die Cast Aluminum Spray Gun

UNPACKING

When unpacking, check to make sure that the item is intact and undamaged. If any parts are missing or broken, please call Harbor Freight Tools at the number shown on the cover of this manual as soon as possible.

PRODUCT FEATURES



Read the **ENTIRE IMPORTANT SAFETY INFORMATION** section at the beginning of this manual including all text under subheadings therein before set up or use of this product.

⚠ WARNING TO PREVENT SERIOUS INJURY FROM ACCIDENTAL OPERATION:
Turn the Power Switch (33) of the Paint Sprayer to its "OFF" position and unplug the tool from its electrical outlet before assembling, operating, or making any adjustments to the tool.

Note: For additional information regarding the parts listed in the following pages, refer to the Assembly Diagram near the end of this manual.

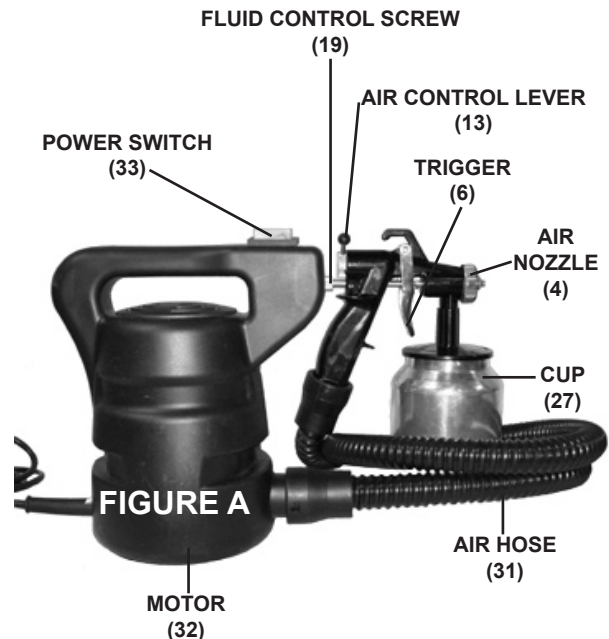

PREPARATION

1. **IMPORTANT:** Due to the viscosity of latex and other water-based paints, they are **NOT** recommended for use with this HVLP Paint Sprayer.

Work Piece and Work Area Set Up

1. Designate a work area that is clean and well-lit. The work area must not allow access by children or pets to prevent injury and distraction.
2. Route the Power Cord (34) along a safe route to reach the work area without creating a tripping hazard or exposing the Power Cord to possible damage. The Power Cord must reach the work area with enough extra length to allow free movement while working.
3. Secure loose workpieces using a vise or clamps (not included) to prevent movement while working.
4. There must not be hazardous objects, such as utility lines or foreign objects, nearby that will present a hazard while working.
5. Cover all furniture, decorations, floors, walls, etc. not intended to be painted.
6. Only paint in well ventilated dust free area.
4. Plug the Power Cord (34) into the nearest 120 volt, grounded, electrical outlet. Then turn the Power Switch (33) to its "ON" position. **(See Figure A, on page 8.)**
5. Adjust the air pressure during operation with the Trigger (6) and the Air Control Lever (13). Turn the Air Control Lever clockwise to provide less air to the Spray Gun. Turn the Air Control Lever counterclockwise to provide more air to the Spray Gun. **(See Figure A, on page 8.)**
6. Set up a piece of scrap material to practice on. While practicing on the scrap material, check to see that the paint/fluid you are spraying has the appropriate consistency. If it appears too thick, add a very small amount of thinner (not included).
7. To change the direction of the fan from horizontal to vertical, loosen the Air Cap Screw (5) and turn the Air Nozzle (4) 90 degrees. After the adjustment, tighten the Air Cap Screw. **(See Figure B.)**

Tool Set Up

1. Mix and thin the paint or other fluid thoroughly according to the manufacturer's directions.
2. Carefully strain the paint/fluid through a paint strainer or piece of cheese cloth.
3. Fill the Cup (27) to approximately 3/4 full. Then attach the Cup to the Spray Gun. **(See Figure A, on page 8.)**
8. To set the pattern size specific to the job, use the Fluid Control Screw (19). Turn it clockwise for a round pattern. Turn the Screw counterclockwise (all the way open) to flatten the pattern. **(See Figure C, next page.)**

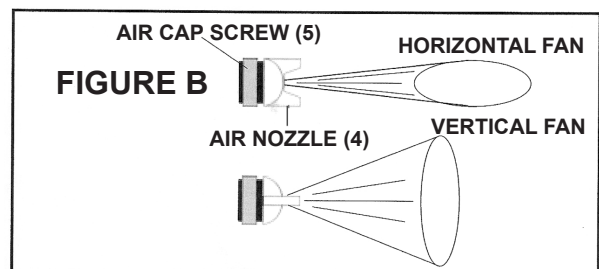

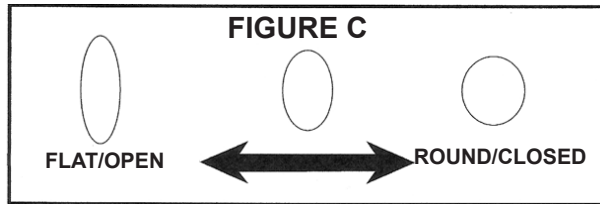

- After setting up a piece of scrap material, squeeze the Trigger (6) in short bursts while turning the Fluid Control Screw (19) counterclockwise and observe the pattern for consistency. Too much air may cause the spray to come out too fine. Reduce the air pressure or allow more paint/fluid to come out by opening the Fluid Control Screw. If the spray appears too thick (you see globs of paint/fluid), close down the Fluid Control Screw slowly, checking the mixture after each adjustment. (See Figure D.)

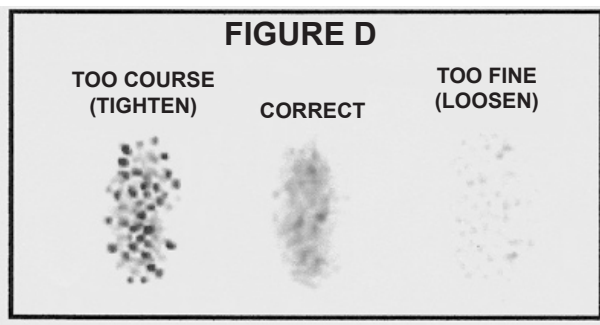

TECHNIQUES

- Always keep the Spray Gun at right angles to the workpiece. Pull the Trigger (6) slowly and move the Spray Gun in parallel strokes to the object being painted. Keep the distance from the object being painted at 6" to 9". This may slightly differ depending on the flow adjustment and the paint/fluid being sprayed. Do not stop the Spray Gun movement while spraying.

If you stop the Spray Gun for even just a slight pause while spraying, the paint/fluid will build up and run down the workpiece. (See Figure E.)

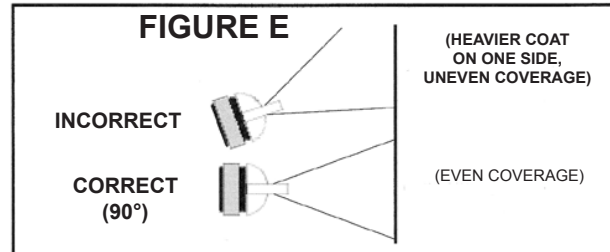

- To ensure you don't allow paint to build up, start moving the Spray Gun before you squeeze the Trigger (6). When you are finished spraying, release the Trigger before you stop moving the Spray Gun. Doing so will eliminate distinct overlaps, producing a blended (feathered) affect. (See Figure F.)

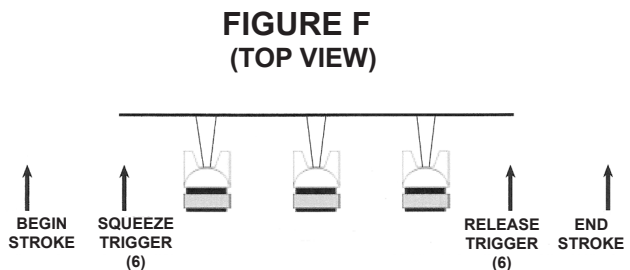

- NOTE: The speed of the stroke, the adjustment of the Fluid Control Screw (19), and the distance from the workpiece will determine how much paint/fluid is being applied. To get the best results, try to apply two thin coats of paint/fluid versus one thick coat.
- When finished, thoroughly clean out the Paint Sprayer and its accessories. (See "Maintenance and Servicing" section, next page.)

MAINTENANCE AND SERVICING



Procedures not specifically explained in this manual must be performed only by a qualified technician.

⚠️ WARNING

TO PREVENT SERIOUS INJURY

FROM ACCIDENTAL OPERATION:

Turn the Power Switch (33) of the Paint Sprayer to its “OFF” position and unplug the tool from its electrical outlet before performing any inspection, maintenance, or cleaning procedures.

TO PREVENT SERIOUS INJURY FROM TOOL FAILURE:

Do not use damaged equipment. If abnormal noise or vibration occurs, have the problem corrected before further use.

Inspection, Maintenance, and Cleaning

- BEFORE EACH USE**, inspect the general condition of the Paint Sprayer and its accessories. Check for loose screws, misalignment or binding of moving parts, cracked or broken parts, damaged electrical wiring/air hose, and any other condition that may affect its safe operation.
- IMPORTANT:** The Spray Gun must be cleaned immediately after each use. Improper cleaning is a common reason for the Spray Gun not to operate properly. Materials dry quickly which will render the Spray Gun useless. It is extremely difficult to remove dry paint/fluid from small passages within the Gun.
- SOLVENT SELECTION:** Always follow the paint/fluid manufacturer’s recommendations for cleaning, solvent type, and disposing of used solvent.
 - Oil-based paints/fluids: Use mineral spirits.
 - Latex (water-based) paints/fluids: Use warm, soapy water.
 - IMPORTANT:** Do not use mineral spirits on latex (water-based) paints/fluids or the mixture will congeal, making it very difficult to remove.
 - If a flammable solvent is used, adhere to the following: (1) Follow all of the solvent manufacturer’s clean up instructions and safety precautions at all times. (2) If collecting flushed solvents into a metal container, transfer into a larger non-metal container, and flush the metal container.
- AFTER USE:**
 - Empty the Cup (27), and clean it with solvent for oil-based paint/fluid or soap and water for water-based paint/fluid.
 - Fill the Cup (27) with solvent (or water) and spray it through the Gun into a container while shaking the Gun. Once the Cup is empty, repeat the process until the solvent/water comes out clean.
 - Turn the Power Switch (33) to its “OFF” position and disconnect from the electrical outlet. After disconnecting, be aware that air pressure

may still remain in the Spray Gun. Point the Gun into the spent solvent container and squeeze the Trigger (6) again to make sure no air remains.

- Remove the Top Cover (22) and soak it in solvent/water until it is clean. Use an old toothbrush and toothpicks to remove any remaining paint/fluid. Do not use metal objects to clean the Top Cover or you may damage the drilled passages. Inspect the Fluid Needle (16) and make sure it is not bent. If it is bent, have it replaced by a qualified service technician.
 - **WARNING! Do not immerse the Spray Gun Body in solvent.**
 - Use the appropriate solvent (or water if water-based) to wipe down the Gun Body.
 - Always lubricate the Spray Gun after cleaning. You may use a non-silicon oil or a light lubricant on all threaded connections prior to storing the Paint Sprayer.
5. **DISPOSAL:** After cleaning the Paint Sprayer and its accessories, properly dispose of your cleaning solutions according to the solution manufacturer's direction and local hazardous waste authority instructions.
6. **▲WARNING! If the Power Cord (34) of this Paint Sprayer is damaged, it must be replaced only by a qualified service technician.**

PLEASE READ THE FOLLOWING CAREFULLY

THE MANUFACTURER AND/OR DISTRIBUTOR HAS PROVIDED THE PARTS LIST AND ASSEMBLY DIAGRAM IN THIS MANUAL AS A REFERENCE TOOL ONLY. NEITHER THE MANUFACTURER OR DISTRIBUTOR MAKES ANY REPRESENTATION OR WARRANTY OF ANY KIND TO THE BUYER THAT HE OR SHE IS QUALIFIED TO MAKE ANY REPAIRS TO THE PRODUCT, OR THAT HE OR SHE IS QUALIFIED TO REPLACE ANY PARTS OF THE PRODUCT. IN FACT, THE MANUFACTURER AND/OR DISTRIBUTOR EXPRESSLY STATES THAT ALL REPAIRS AND PARTS REPLACEMENTS SHOULD BE UNDERTAKEN BY CERTIFIED AND LICENSED TECHNICIANS, AND NOT BY THE BUYER. THE BUYER ASSUMES ALL RISK AND LIABILITY ARISING OUT OF HIS OR HER REPAIRS TO THE ORIGINAL PRODUCT OR REPLACEMENT PARTS THERETO, OR ARISING OUT OF HIS OR HER INSTALLATION OF REPLACEMENT PARTS THERETO.

TROUBLESHOOTING - GENERAL

IMPORTANT:

Improper cleaning is a common reason for the unit not to work properly. Most problems can be avoided or remedied with prompt, thorough cleaning.

Problem	Possible Causes	Possible Solutions
Sputtering spray.	<ol style="list-style-type: none"> 1. Low fluid level. 2. Cup tipped too far. 3. Clogged air vent. 4. Loose fluid inlet connections. 5. Dry or loose fluid needle packing nut. 6. Loose/damaged fluid tip or seat. 	<ol style="list-style-type: none"> 1. Refill cup. 2. Hold cup upright. 3. Clean vent hole. 4. Tighten inlet connections. 5. Lubricate and/or tighten. 6. Adjust or replace.
Will not spray.	<ol style="list-style-type: none"> 1. No pressure at gun. 2. Fluid control not open enough. 3. Fluid too thick. 	<ol style="list-style-type: none"> 1. Check air hose. 2. Open fluid control. 3. Thin fluid or increase air pressure.
Overspray.	<ol style="list-style-type: none"> 1. Improper application speed. 2. Improper distance from workpiece. 3. Too much air pressure. 	<ol style="list-style-type: none"> 1. Move moderately and parallel. 2. Adjust distance. 3. Reduce air pressure.
Fluid tip leakage.	<ol style="list-style-type: none"> 1. Dirty tip. 2. Tight packing nut. 3. Broken fluid needle spring. 4. Worn or damaged tip. 	<ol style="list-style-type: none"> 1. Clean tip. 2. Loosen packing nut. 3. Replace fluid needle spring. 4. Replace tip and/or needle.
Air leaking from air cap.	<ol style="list-style-type: none"> 1. Dirty air valve and/or seat. 2. Sticking air valve. 3. Damaged air valve spring. 4. Worn/damaged air valve and/or seat. 5. Bent valve stem. 	<ol style="list-style-type: none"> 1. Clean air valve and/or seat. 2. Lubricate air valve. 3. Replace air valve spring. 4. Replace air valve and/or seat. 5. Replace valve stem.
Fluid leaking from packing nut.	<ol style="list-style-type: none"> 1. Packing nut loose. 2. Packing worn or dry. 	<ol style="list-style-type: none"> 1. Tighten without restricting. 2. Lubricate and/or tighten without restricting.





Follow all safety precautions whenever diagnosing or servicing the tool. Disconnect power supply before service. If the steps above do not solve the problem, or if the repairs involved are too complex, contact a qualified service technician.

TROUBLESHOOTING - SPRAY PATTERN

IMPORTANT:

Improper cleaning is a common reason for the unit not to work properly. Most problems can be avoided or remedied with prompt, thorough cleaning.

The illustrations below resemble symptoms of spray pattern problems. Refer to the illustration your Spray Gun may be experiencing. Then refer to the "*Possible Causes*" and "*Possible Solutions*" sections.

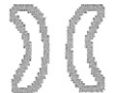
Problem	Possible Causes	Possible Solutions
	<ol style="list-style-type: none"> Fluid Control Screw (19) is partially closed. Fluid is too thick. Air pressure is too low. 	<ol style="list-style-type: none"> Open Fluid Control Screw (19). Thin material according to manufacturer's instructions. Adjust Air Control Lever (13).
	<ol style="list-style-type: none"> Air pressure is too high. Not enough fluid. Fluid Control Screw (19) open too much. 	<ol style="list-style-type: none"> Adjust Air Control Lever (13). Refill Cup (27). Partially close Fluid Control Screw (19).
	<ol style="list-style-type: none"> Air Nozzle (4) plugged. Air Nozzle (4) loose, or dirty Seat. Dried material on fluid tip. 	<ol style="list-style-type: none"> Clean Air Nozzle (4). Clean and tighten. Use a non-metallic point to clean the Air Nozzle (4).
	<ol style="list-style-type: none"> Dirt on one side of the fluid tip. Holes on one side of the Air Nozzle (4) are plugged. 	<ol style="list-style-type: none"> Clean the fluid tip. Use a non-metallic point to clean the Air Nozzle (4).



Follow all safety precautions whenever diagnosing or servicing the tool. Disconnect power supply before service. If the steps above do not solve the problem, or if the repairs involved are too complex, contact a qualified service technician.

PARTS LIST & ASSEMBLY DIAGRAM

Part #	Description	Part #	Description
1	Seal Nut	19	Fluid Control Screw
2	Gasket	20	O-Ring
3	Fluid Nozzle	21	Gasket
4	Air Nozzle	22	Top Cover
5	Air Cap Screw	23	Cup Gasket
6	Trigger	24	Lower Cover
7	Bolt	25	Screw
8	Locking Plate	26	Material Suction Tube
9	Cowskin Ring	27	Cup
10	O-Ring	28	Nut
11	Fluid Packing Nut	29	Gun Body
12	O-Ring	30	Air Hose Connector
13	Air Control Lever	31	Air Hose
14	Seal Screw	32	Motor
15	Needle Valve Seat	33	Power Switch
16	Fluid Needle	34	Power Cord
17	Locking Plate	35	Shoulder Strap
18	Needle Valve Spring		

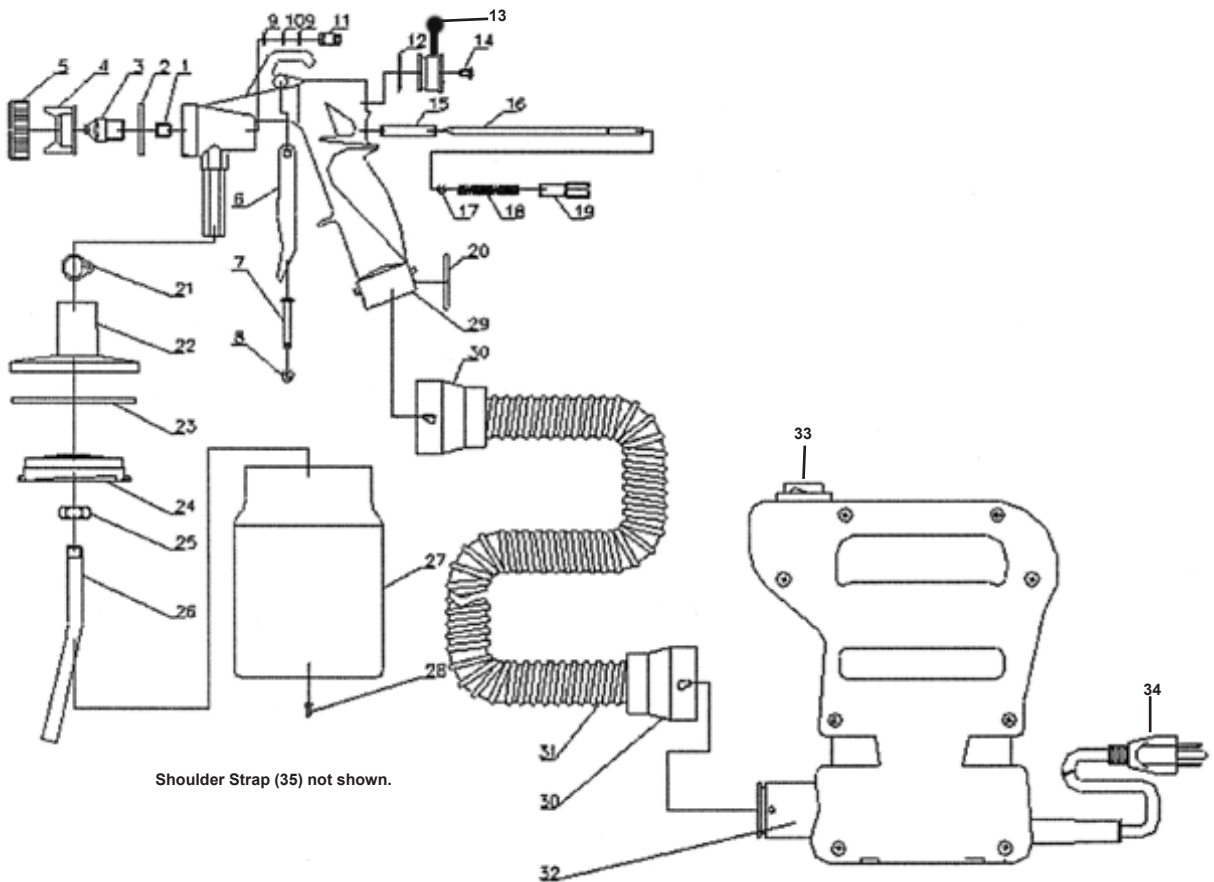

LIMITED 90 DAY WARRANTY

Harbor Freight Tools Co. makes every effort to assure that its products meet high quality and durability standards, and warrants to the original purchaser that this product is free from defects in materials and workmanship for the period of 90 days from the date of purchase. This warranty does not apply to damage due directly or indirectly, to misuse, abuse, negligence or accidents, repairs or alterations outside our facilities, criminal activity, improper installation, normal wear and tear, or to lack of maintenance. We shall in no event be liable for death, injuries to persons or property, or for incidental, contingent, special or consequential damages arising from the use of our product. Some states do not allow the exclusion or limitation of incidental or consequential damages, so the above limitation of exclusion may not apply to you. THIS WARRANTY IS EXPRESSLY IN LIEU OF ALL OTHER WARRANTIES, EXPRESS OR IMPLIED, INCLUDING THE WARRANTIES OF MERCHANTABILITY AND FITNESS.

To take advantage of this warranty, the product or part must be returned to us with transportation charges prepaid. Proof of purchase date and an explanation of the complaint must accompany the merchandise. If our inspection verifies the defect, we will either repair or replace the product at our election or we may elect to refund the purchase price if we cannot readily and quickly provide you with a replacement. We will return repaired products at our expense, but if we determine there is no defect, or that the defect resulted from causes not within the scope of our warranty, then you must bear the cost of returning the product.

This warranty gives you specific legal rights and you may also have other rights which vary from state to state.

3491 Mission Oaks Blvd. • PO Box 6009 • Camarillo, CA 93011 • (800) 444-3353

Record Product's Serial Number Here: _____

Note: If product has no serial number, record month and year of purchase instead.

Note: Some parts are listed and shown for illustration purposes only, and are not available individually as replacement parts.

Free Manuals Download Website

<http://myh66.com>

<http://usermanuals.us>

<http://www.somanuals.com>

<http://www.4manuals.cc>

<http://www.manual-lib.com>

<http://www.404manual.com>

<http://www.luxmanual.com>

<http://aubethermostatmanual.com>

Golf course search by state

<http://golfingnear.com>

Email search by domain

<http://emailbydomain.com>

Auto manuals search

<http://auto.somanuals.com>

TV manuals search

<http://tv.somanuals.com>