

# SOFTWARE USER'S GUIDE

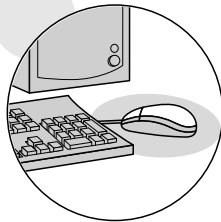
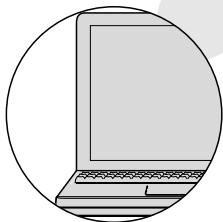
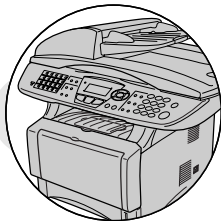
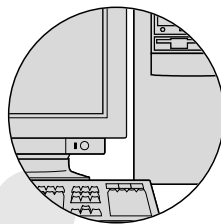
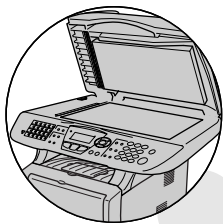

**brother.**

# Table of contents

## 1

<b>Using the machine as a printer .....</b>	<b>1-1</b>
Using the Brother printer driver.....	1-1
How to print your document.....	1-2
Simultaneous printing and faxing.....	1-3
Two-sided printing (Duplex Printing).....	1-3
Automatic Duplex Printing (For MFC-8640D, MFC-8840D, MFC-8840DN and DCP-8045D) ...	1-3
Manual Duplex Printing .....	1-4
Face-down output tray .....	1-4
Printing on plain paper.....	1-5
The manual feed tray (For MFC-8440 and DCP-8040) .....	1-5
The MP tray (For MFC-8640D, MFC-8840D, MFC-8840DN and DCP-8045D).....	1-6
Printing on thicker paper and card stock .....	1-7
The manual feed tray (For MFC-8440 and DCP-8040) .....	1-7
The multi-purpose tray (MP tray) (For MFC-8640D, MFC-8840D, MFC-8840DN and DCP-8045D) .....	1-9
Printing on envelopes .....	1-11
Printer operation keys.....	1-16
Job Cancel.....	1-16
Secure key.....	1-16
Setting the Emulation Selection.....	1-17
Printing the Internal Font List.....	1-18
Printing the Print Configuration List .....	1-18
Restoring factory default settings .....	1-18

## 2

<b>Printer driver settings (Windows® Only) .....</b>	<b>2-1</b>
Printer driver settings.....	2-1
How to access the printer driver settings .....	2-1
Features in the Brother Native Driver .....	2-3
Basic tab .....	2-3
Paper Size .....	2-4
Multiple Page.....	2-4
Orientation .....	2-4
Copies .....	2-5
Collate .....	2-5
Media Type.....	2-5
Advanced tab.....	2-6

Print Quality .....	2-6
Duplex Printing .....	2-8
Watermark .....	2-9
Page Setting .....	2-11
Device Options .....	2-12
Secure Print .....	2-12
Accessories tab .....	2-16
Support tab .....	2-17
Features in the PS printer driver (For Windows®) .....	2-18
Ports tab .....	2-18
Device Settings tab .....	2-19
Layout tab .....	2-20
Booklet (For MFC-8640D, MFC-8840D, MFC-8840DN and DCP-8045D) (For Windows® 2000/XP) .....	2-20
Paper / Quality tab .....	2-21
Advanced Options .....	2-22

### 3

<b>How to scan using Windows® .....</b>	<b>3-1</b>
Scanning a document (For Windows® XP only) .....	3-2
WIA compliant .....	3-2
How to access the scanner .....	3-2
Scanning a document into the PC .....	3-3
Scanning a document using the ADF .....	3-3
PreScanning to crop a portion you want to scan using the scanner glass .....	3-5
Brother Scanner Utility .....	3-7
TWAIN compliant scanner driver for Windows® XP .....	3-7
Scanning a document .....	3-8
TWAIN compliant .....	3-8
How to access the Scanner .....	3-9
Scanning a document into the PC .....	3-10
Scanning a whole page .....	3-10
PreScanning to crop a portion you want to scan .....	3-11
Settings in the Scanner window .....	3-13
Image Type .....	3-13
Resolution .....	3-13
Scan Type .....	3-14
Brightness .....	3-14
Contrast .....	3-14
Document Size .....	3-15

Using the scan key (For USB or Parallel interface cable users) .....	3-17
Scan to E-mail .....	3-18
Scan to Image .....	3-18
Scan to OCR.....	3-19
Scan to File.....	3-19
Using ScanSoft® PaperPort® 9.0SE and OmniPage® OCR .....	3-20
Viewing items.....	3-21
Organizing your items in folders .....	3-22
Quick links to other applications .....	3-22
ScanSoft® OmniPage® OCR lets you convert image text into text you can edit .....	3-23
You can Import items from other applications .....	3-23
You can Export items in other formats.....	3-24
Exporting an image file .....	3-24
How to Uninstall PaperPort® 9.0SE and ScanSoft® OmniPage® OCR .....	3-25

## 4

<b>Using ControlCenter2.0 (For Windows®) .....</b>	<b>4-1</b>
ControlCenter2.0 .....	4-1
How to turn off the AutoLoad feature in ControlCenter2.0 .....	4-2
SCAN.....	4-3
CUSTOM SCAN .....	4-3
COPY .....	4-4
PC-FAX (For MFC-8440, MFC-8640D, MFC-8840D and MFC-8840DN only).....	4-4
DEVICE SETTING (For MFC-8440, MFC-8640D, MFC-8840D and MFC-8840DN only) .....	4-4
SCAN.....	4-5
Image (example: Microsoft Paint) .....	4-5
OCR (Word Processing program).....	4-7
E-mail.....	4-8
File attachments .....	4-9
File.....	4-10
CUSTOM SCAN .....	4-11
Customizing a user-defined button .....	4-12
Scan to Image: .....	4-12
Scan to OCR: .....	4-13
Scan to E-mail: .....	4-14
Scan to File:.....	4-15
COPY.....	4-16

PC-FAX (For MFC-8440, MFC-8640D, MFC-8840D and MFC-8840DN only).....	4-18
Send .....	4-18
Receive / View Received.....	4-19
Address Book .....	4-20
Setup .....	4-20
DEVICE SETTING (For MFC-8440, MFC-8640D, MFC-8840D and MFC-8840DN only) .....	4-21
Remote Setup.....	4-21

## 5

### Using MFC Remote Setup (For Windows®)

(For MFC-8440, MFC-8640D, MFC-8840D and MFC-8840DN only).... 5-1

MFC Remote Setup.....	5-1
-----------------------	-----

## 6

### Using Brother PC-FAX software (For Windows®)

(For MFC-8440, MFC-8640D, MFC-8840D and MFC-8840DN only) 6-1

PC-FAX sending.....	6-1
Setting up user information.....	6-2
Sending setup.....	6-3
Outside line access .....	6-3
Include header.....	6-3
User interface .....	6-4
Simple style .....	6-4
Facsimile style.....	6-4
Address Book .....	6-5
Speed-Dial setup .....	6-6
Brother Address Book .....	6-7
Setting up a Member in the Address Book.....	6-8
Setting up a Group for Broadcasting .....	6-9
Editing Member information.....	6-10
Deleting a Member or Group.....	6-10
Exporting the Address Book.....	6-10
Importing to the Address Book .....	6-12
Setting up a Cover Page .....	6-14
Entering Cover Page Information .....	6-15
Sending a file as a PC-FAX using the Facsimile style user interface .....	6-16
Redial .....	6-17
Sending a file as a PC-FAX using the Simple style user interface .....	6-17
Setting up PC-FAX receiving.....	6-19
Running PC-FAX Receiving .....	6-19
Setting up your PC .....	6-19
Viewing new PC-FAX messages.....	6-20

<b>Using your machine with a Macintosh®</b> .....	<b>7-1</b>
Setting up your USB-equipped Apple® Macintosh® .....	7-1
Using the Brother printer driver with your Apple®	
Macintosh® (Mac OS® 8.6 - 9.2) .....	7-2
Using the Brother Printer Driver with Your Apple®	
Macintosh® (Mac OS® X) .....	7-5
Choosing page setup options .....	7-5
Specific settings .....	7-6
Using the PS driver with your Apple® Macintosh® .....	7-7
For Mac OS® 8.6 to 9.2 users .....	7-7
For Mac OS® X users .....	7-11
Sending a fax from your Macintosh® application	
(For MFC-8440, MFC-8640D, MFC-8840D and	
MFC-8840DN only) .....	7-14
For Mac OS® 8.6 - 9.2 users .....	7-14
For Mac OS® X users .....	7-16
Drag a vCard from the Mac OS® X Address Book	
application .....	7-18
Using the Brother TWAIN scanner driver with your	
Macintosh® .....	7-20
Accessing the scanner .....	7-20
Scanning an image into your Macintosh® .....	7-21
Scanning a whole page .....	7-21
PreScanning an image .....	7-22
Settings in the Scanner window .....	7-23
Image .....	7-23
Scanning Area .....	7-25
Business Card Size .....	7-25
Adjusting the Image .....	7-26
Using Presto!® PageManager® .....	7-27
Highlights .....	7-27
System requirements .....	7-28
Technical Support .....	7-28
Using ControlCenter2.0	
(For Mac OS® X 10.2.1 or greater) .....	7-29
How to turn off the AutoLoad feature in	
ControlCenter2.0 .....	7-30
SCAN .....	7-31
CUSTOM SCAN .....	7-31
COPY .....	7-32
DEVICE SETTINGS (For MFC-8440, MFC-8640D,	
MFC-8840D and MFC-8840DN only) .....	7-32
SCAN .....	7-33
Image (example: Apple PreView) .....	7-33

OCR (Word Processing program) .....	7-35
E-mail .....	7-36
File attachments .....	7-37
File.....	7-38
CUSTOM SCAN .....	7-39
Customizing a user-defined button.....	7-40
Scan to Image: .....	7-40
Scan to OCR: .....	7-41
Scan to E-mail: .....	7-42
Scan to File: .....	7-43
COPY .....	7-44
DEVICE SETTINGS (For MFC-8440, MFC-8640D MFC-8840D and MFC-8840DN only) .....	7-46
Remote Setup .....	7-46
MFC Remote Setup (Mac OS® X) (For MFC-8440, MFC-8640D, MFC-8840D and MFC-8840DN only) ....	7-47

## 8

<b>Network Scanning (Windows® 98/98SE/Me/ 2000 Professional and XP only) .....</b>	<b>8-1</b>
Network License .....	8-1
Registering your PC with the machine .....	8-2
Using the Scan key.....	8-5
Scan to E-mail (PC).....	8-5
Scan to E-mail (E-mail server) (For MFC-8440, MFC-8640D, MFC-8840D and MFC-8840DN only) .....	8-6
Scan to Image .....	8-7
Scan to OCR .....	8-8
Scan to File.....	8-9

## 9

<b>Brother Network PC-FAX software (For MFC-8440, MFC-8640D, MFC-8840D and MFC-8840DN only) .....</b>	<b>9-1</b>
Enable Network PC-FAX .....	9-1
Sending setup .....	9-1
Extra options in Address Book .....	9-3
Using the Brother Network PC-FAX software.....	9-4
Quick Tips: .....	9-4
Sending a Network PC-FAX from your Macintosh® application .....	9-5
For Mac OS® 8.6-9.2 users .....	9-5
For Mac OS® X users.....	9-5

## I

<b>Index .....</b>	<b>I-1</b>
--------------------	------------

# 1 Using the machine as a printer

## Using the Brother printer driver

A Printer Driver is software that translates data from the format used by a computer into the format required by a particular printer, using a printer command language or page description language.

The printer drivers are on the CD-ROM we have supplied. Install the drivers first by following the Quick Setup Guide. Also, the latest printer driver can be downloaded from the Brother Solutions Center at:

<http://solutions.brother.com>

### Windows® Printing

The dedicated printer driver and TrueType™ compatible fonts for Microsoft® Windows® 98/98SE/Me/2000 Professional/XP and Windows NT® workstation 4.0 are available on the CD-ROM supplied with your machine. You can install them easily into your Windows® system using our installer program. The driver supports our unique compression mode to enhance printing speed in Windows® applications, and allows you to set various printer settings, including economy printing mode and custom paper size.

### Popular Printer Emulation Support

The machine supports HP LaserJet (PCL level 6) and BR-Script 3 (PostScript® 3™) printer emulation mode. If you use DOS application software, you can use HP LaserJet (PCL level 6) and BR-Script 3 (PostScript® 3™) emulation mode for printer operations.



# How to print your document

When the machine receives data from your computer, it begins printing by picking up paper from the paper tray. The paper tray can feed many types of paper and envelopes.

- 1** From your computer select the Print command.  
If your computer is also connected to any other printers, select **Brother MFC-XXXX** or **DCP-XXXX (USB) Printer** (Where XXXX is your model name) as your printer driver from the Print or Print Settings menu in your software application, and then click on OK to begin printing.
  - 2** Your computer sends a print command and data to the machine.
  - 3** The LED blinks in yellow and the machine starts to print.
-  You can select the paper size and orientation in your application software.

If your application software does not support your custom paper size, select the next largest paper size.

Then adjust the print area by changing the right and left margins in your application software.

# Simultaneous printing and faxing

Your machine can print from your computer while scanning the document into the computer, or while sending/receiving a fax in memory. (MFC-8440, MFC-8640D, MFC-8840D and MFC-8840DN only) Fax sending will not be stopped during PC printing.

## Two-sided printing (Duplex Printing)

---

The supplied printer driver supports duplex printing. (For more information, see *Duplex Printing* on page 2-8.)

### Automatic Duplex Printing (For MFC-8640D, MFC-8840D, MFC-8840DN and DCP-8045D)

In this mode, the machine prints on both sides of A4, Letter or Legal paper automatically.

- 1 Open the Properties dialog box in the printer driver.
- 2 Select Duplex Printing mode in the Advanced tab, make sure that '**Use Duplex Unit**' has been selected, and then click the **OK** button. (See *Duplex Printing* on page 2-8.) The printer will print on both sides of the paper automatically.



- When you select **Use Duplex Unit**, HQ 1200 is not available.
- If you also want to use Duplex Printing for fax and copy operations, see To use Automatic Duplexing for fax, copy and print operations (For MFC-8640D, MFC-8840D, MFC-8840DN and DCP-8045D) in the User's Guide.

## Manual Duplex Printing

The machine prints all the even-numbered pages on one side of the paper first. Then, the Windows® driver instructs you (with a pop-up message) to reinsert the paper. Before reinserting the paper, straighten it well, or you may get a paper jam. Very thin or very thick paper is not recommended.

We recommend 20 to 24 lb (75 to 90 g/m<sup>2</sup>) paper.

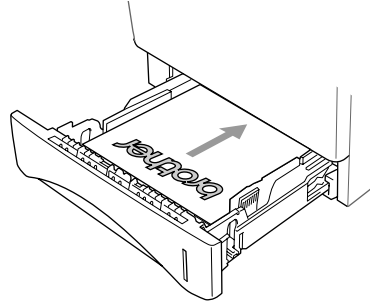

## Face-down output tray

---

The machine ejects paper with printed surfaces *face down* into the output tray in the front of the machine. Unfold the support flap to support the printed pages.



When printing transparencies, remove each one from the support flap after it exits the machine.

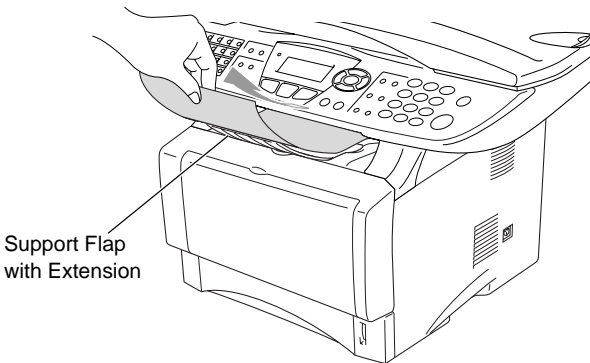

# Printing on plain paper

## The manual feed tray (For MFC-8440 and DCP-8040)

 The machine automatically turns on the Manual Feed mode when you put paper in the manual feed tray.

- 1 Select the **Paper Size**, **Media Type**, **Paper Source**, and other settings in the printer driver.

**Media Type:** Plain Paper

**Paper Source:** Manual

- 2 Send the print data to the machine.
- 3 Open the manual feed tray. Slide the paper guides to fit the paper size.
- 4 Using both hands put paper in the manual feed tray until the front edge of the paper touches the paper feed roller and the machine grips the paper.

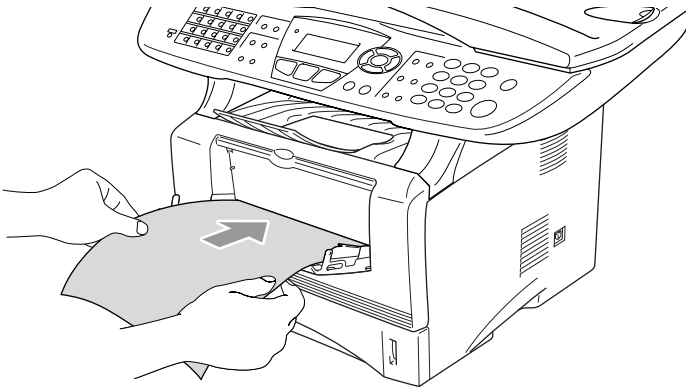

 ■ Make sure that the paper is straight and in the proper position on the manual feed tray. If it is not, the paper may not be fed properly, resulting in a skewed printout or a paper jam.

■ Do not put more than one piece of paper in the manual feed tray at any one time, or it may cause a jam.

- 5 After the printed page comes out of the machine, put in the next sheet of paper as in Step 4 above. Repeat for each page that you want to print.

## The MP tray (For MFC-8640D, MFC-8840D, MFC-8840DN and DCP-8045D)

- 1 Select the **Paper Size**, **Media Type**, **Paper Source**, and other settings in the printer driver.

**Media Type:** Plain Paper

**Paper Source:** MP Tray

- 2 Open the MP tray and lower it gently.
- 3 Pull out the MP tray support flap.
- 4 When loading paper in the MP tray, make sure it touches the back of the tray.

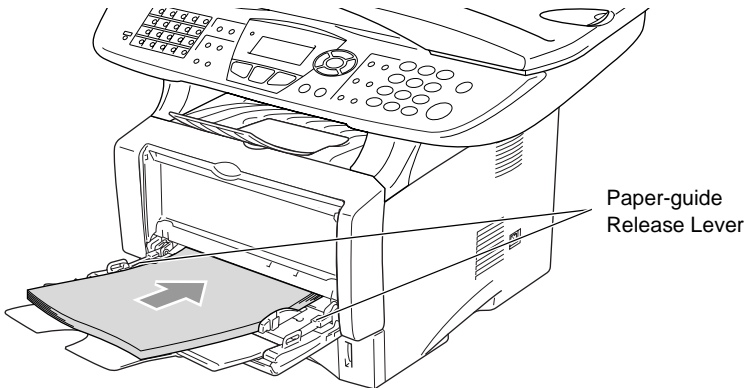

-  Make sure that the paper is straight and in the proper position on the MP tray. If it is not, the paper may not be fed properly, resulting in a skewed printout or a paper jam.

- 5 While pressing the paper-guide release lever, slide the paper guide to fit the paper size.

-  When you put paper in the MP tray, please remember the following:

- The side to be printed on must be face up.
- During printing, the inside tray rises to feed paper into the machine.
- Put the leading edge (top of the paper) in first and push it gently into the tray.

- 6 Send the print data to the machine.

## Printing on thicker paper and card stock

---

When the back output tray is pulled down, the machine has a straight paper path from the manual feed tray or the MP tray through to the back of the machine. Use this paper feed and output method when you want to print on thicker paper or card stock.

### The manual feed tray (For MFC-8440 and DCP-8040)

- 1 Select the **Paper Size**, **Media Type**, **Paper Source**, and other settings in the printer driver.

**Media Type:** Thick paper or Thicker paper

**Paper Source:** Manual

- 2 Open the back output tray.

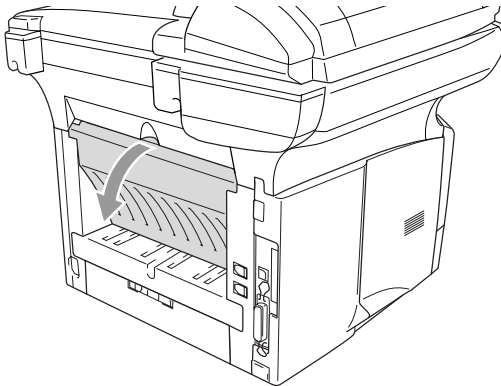

- 3 Open the manual feed tray. Slide the paper guides to fit the paper size.
- 4 Using both hands put the paper in the manual feed tray until the front edge of the paper touches the paper feed roller and the machine grips the paper.



- Make sure that the paper is straight and in the proper position in the manual feed tray. If it is not, the paper may not be fed properly, resulting in a skewed printout or a paper jam.
- Do not put more than one piece of paper in the manual feed tray at any one time, or it may cause a jam.

- 5 Send the print data to the machine.

- 6 After the printed page comes out of the machine, put in the next sheet of paper as in Step 4 above. Repeat for each page that you want to print.
- 7 When you have finished the print job, close the back output tray.

**! Caution**

Remove each sheet immediately after printing. If you allow the sheets to stack, you may cause the machine to jam or curl the paper.

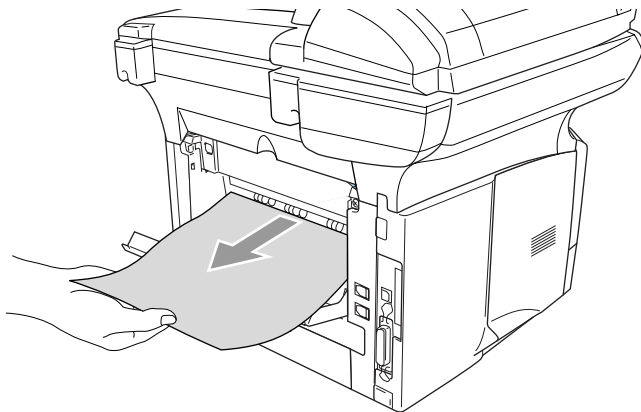

## The multi-purpose tray (MP tray) (For MFC-8640D, MFC-8840D, MFC-8840DN and DCP-8045D)

- 1 Select the **Paper Size**, **Media Type**, **Paper Source**, and other settings in the printer driver.

**Media Type:** Thick paper or Thicker paper

**Paper Source:** MP Tray

- 2 Open the back output tray, and then unfold the face-up output tray support if necessary.

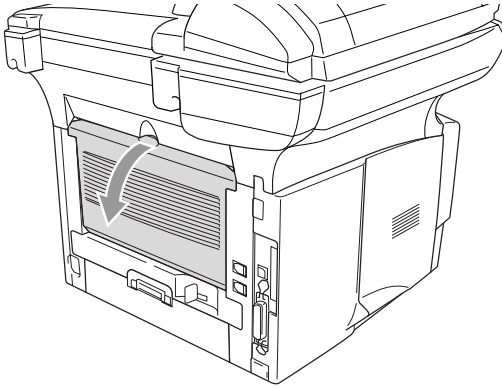

- 3 Open the MP tray and lower it gently.
  - 4 Pull out the MP tray support flap.
  - 5 When putting paper in the MP tray, make sure it touches the back of the tray.
-  Make sure that the paper is straight and in the proper position in the MP tray. If it is not, the paper may not be fed properly, resulting in a skewed printout or a paper jam.
- 6 While pressing the paper-guide release lever, slide the paper guide to fit the paper size.





When you put paper in the MP tray, please remember the following;

- During printing, the inside tray rises to feed paper into the machine.
- The side to be printed on must be face up.
- Put the leading edge (top of the paper) in first and push it gently into the tray.

**7** Send the print data to the machine.

**8** When you have finished the print job, close the back output tray.



### Caution

Remove each sheet immediately after printing. Stacking the sheets may cause a paper jam or the paper to curl.

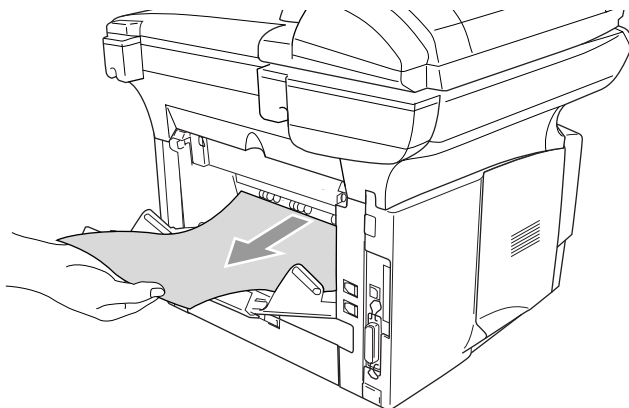

# Printing on envelopes

---

To print on envelopes use manual feed tray or multi-purpose tray.



- The machine automatically turns on the Manual Feed mode when you put paper in the manual feed tray.
- All sides should be properly folded without any wrinkles or creases.

**1** Select the **Paper Size, Media Type, Paper Source**, and other settings in the printer driver.

**Media Type:** Envelope, Env.thin or Env.thick

*For MFC-8440 and DCP-8040:*

**2** Open the back output tray.

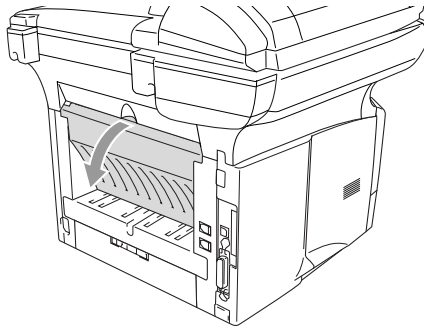

**3** Open the manual feed tray. Slide the paper guides to fit the envelope size.



If envelopes are creased after they have been printed:

At the back of the machine, open the back output tray and push down the blue tabs at the left and right hand sides (as shown in the figure on the next page). When you have finished printing your envelopes, close the back output tray to reset the two blue tabs back to their original position.

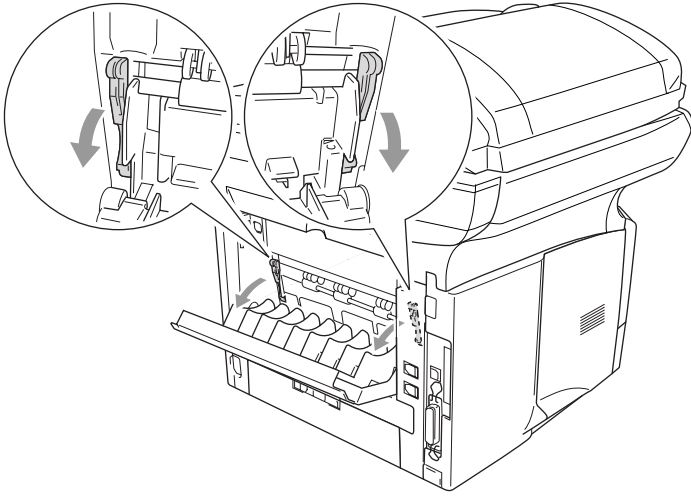

- 4** Using both hands put the envelope in the manual feed tray until the front edge of the envelope touches the paper feed roller. Hold the envelope in this position until the machine automatically feeds it in for a short distance, and then let go of the envelope.

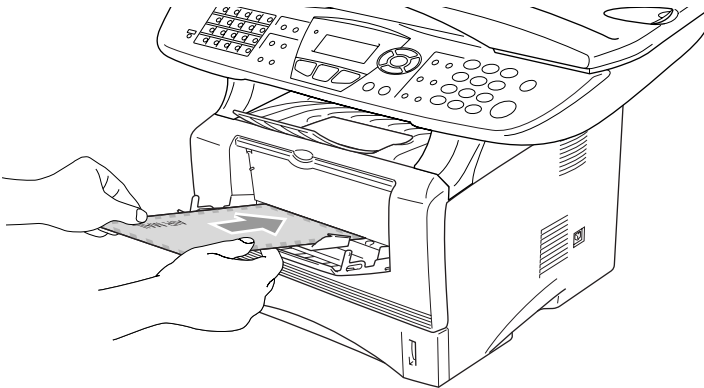

- Make sure the envelope is straight as you insert it in the manual feed tray. If it is not, the envelope may not be fed properly, resulting in a skewed printout or a jam.
- Do not put more than one envelope in the manual feed tray at any one time, or it may cause a jam.
- Put the envelope in the manual feed tray, making sure that the side to be printed on is face up in the tray.

- 5** After the printed envelope comes out of the machine, the machine will wait until you put in the next envelope. Repeat Step 4 for each envelope you want to print.
- 6** Send the print data to the machine.
- 7** After you finish the print job, close the back output tray.

*For MFC-8640D, MFC-8840D, MFC-8840DN and DCP-8045D:*

- 2** Open the back output tray, and then unfold the face-up output tray support if necessary.

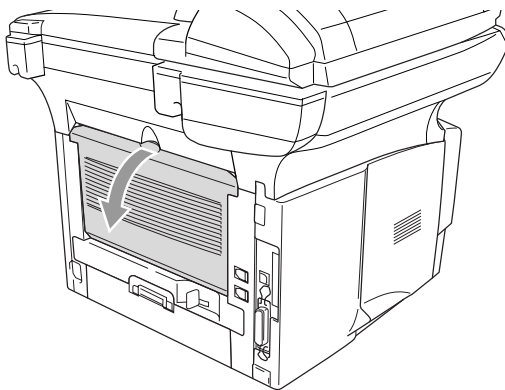

- 3** Open the MP tray and lower it gently.
- 4** Pull out the MP tray support flap.



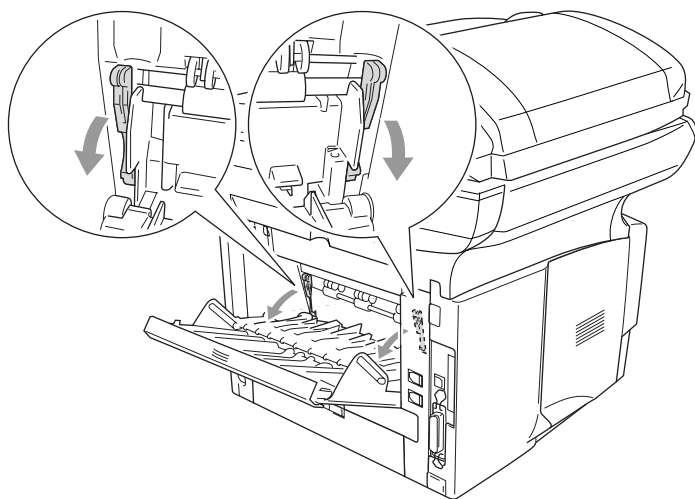

If envelopes are creased after they have been printed:

At the back of the machine, open the back output tray and push down the blue tabs at the left and right hand sides (as shown in the figure on the next page). When you have finished printing your envelopes, close the back output tray to reset the two blue tabs back to their original position.

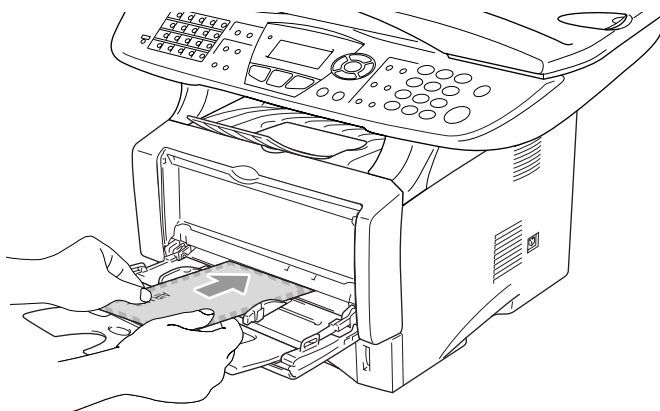

- 5** Put the envelopes in the MP tray so that they touch the back of the tray. Do not put more than 3 envelopes in the MP tray at any one time, or it may cause a jam.



-  Make sure that the envelopes are neatly stacked and in the proper position in the MP tray. If they are not, the envelopes may not be fed properly, resulting in a skewed printout or a jam.

**6** Press and slide the paper-width guide to fit the envelope size.



When you put envelopes in the MP tray, please remember the following:

- During printing, the inside tray rises to feed envelopes into the machine.
- The side to be printed on must be face up.
- Put the leading edge (top of the envelope) in first and push it gently into the tray.

**7** Send the print data to the machine.

**8** After you finish the print job, close the back output tray.

# Printer operation keys

## Job Cancel

You can clear data from the memory.

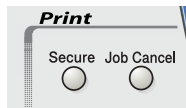

## Secure key

Secured data is password protected. Only those people that know the password will be able to print the data. The machine will not print secure data until the password is entered. After the document is printed, the data will be cleared from the memory. To use this function, you need to set your password in the printer driver dialog box. (See *Device Options* on page 2-12.)



The Secure Key function is not available when using the Brother BR-Script driver.

### 1 Press **Secure**.

—OR—

The LCD displays **No Data!** if there is no secured data in the memory.

### 2 Press or to select the user name.

Press **Set**. The LCD displays job selections.



### 3 Press or to select the job.



Press **Set**. The LCD prompts you to enter your four-digit password.



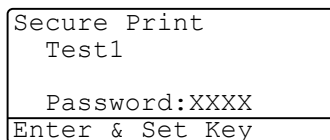

### 4 Enter your password using the control panel.

Press **Set**.



5 Press  or  to select **Print**.  
Press **Set**. The machine prints the data.

—OR—

If you want to delete the secured data press  or  to select **Delete**.

Press **Stop/Exit**.



- If you turn the power switch Off, the secured data saved in memory will be cleared.
- After you print the secured data it will be cleared from memory.

## Setting the Emulation Selection

---



The LCD screen shown in this section is from MFC-8440, MFC-8640D, MFC-8840D and MFC-8840DN.

This machine has an Automatic Emulation Selection function. When the machine receives information from the PC, it automatically chooses the emulation mode. This function has been set at the factory to AUTO.

You can change the default emulation mode manually by using the control panel.

1 Press **Menu, 4, 1**.  
(For DCP-8040 and DCP-8045D, press **Menu, 3, 1**)

2 Press  or  to select **Auto**, **HP Laser Jet** or **BR-Script3**.

Press **Set**.

3 Press **Stop/Exit**.

41.Emulation
▲ Auto
HP LaserJet
▼ BS-Script 3
Select ▲▼ & Set



Try this function with your application software or network server. If the function does not work properly, either select the required emulation mode manually using the machine panel buttons or use the emulation selection commands in your software.



## Printing the Internal Font List

---

You can print a list of the machine's internal (or resident) fonts to see how each font looks before you select it.

- 1 Press **Menu, 4, 2, 1**.  
(For DCP-8040 and DCP-8045D, press **Menu, 3, 2, 1**)
- 2 Press **Start**. The machine prints the list.
- 3 Press **Stop/Exit**.

42.Print Options 1.Internal Font
Press Start

## Printing the Print Configuration List

---

You can print a list of current printer settings.

- 1 Press **Menu, 4, 2, 2**.  
(For DCP-8040 and DCP-8045D, press **Menu, 3, 2, 2**)
- 2 Press **Start**. The machine prints the settings.
- 3 Press **Stop/Exit**.

42.Print Options 2.Configuration
Press Start

## Restoring factory default settings

---

You can return the machine to the original factory settings. Fonts and macros in the temporary settings are cleared.

- 1 Press **Menu, 4, 3**.  
(For DCP-8040 and DCP-8045D, press **Menu, 3, 3**)
- 2 Press **1** to restore the factory settings  
—OR—  
Press **2** to exit without making a change.
- 3 Press **Stop/Exit**.

43.Reset Printer
▲ 1.Reset
▼ 2.Exit
Select ▲▼ & Set



- Only the printer settings will be returned to the original factory settings.
- The LCD screens shown on this page are from MFC-8440, MFC-8640D, MFC-8840D and MFC-8840DN.

# 2

## Printer driver settings

(Windows® Only)

### Printer driver settings

You can change the following printer settings when you print from your computer:

- **Media Type**
- **Multiple Page**
- **Duplex**
- **Watermark**\*1\*2
- **Scaling**\*2
- **Print Date & Time**\*1\*2
- **Quick Print Setup**\*1\*2
- **Secure Print**\*1

\*1 These settings are not available with the BR-script driver.

\*2 These settings are not available with the Universal printer driver.

### How to access the printer driver settings

- 1 Select **Print** from the **File** menu in your application software.
- 2 Select **Brother XXX-XXXX (USB) Printer** (Where XXX-XXXX is your model name) as your printer and click **Preferences** for Windows® 2000/XP (**Properties** for Windows® 98/98SE and Me, **Document Default** for Windows NT® 4.0). The **Printing Preferences** dialog box will appear.



- The way you access the printer driver settings depends on your operating system and software applications.
- The screens shown in this chapter are from Windows® XP. The screens on your computer may vary depending on your Windows Operating System.
- Some descriptions in this chapter are based on the MFC-8840D. These descriptions also apply to the MFC-8440, MFC-8640D, MFC-8840D, MFC-8840DN, DCP-8040 and DCP8045D.

# Features in the Brother Native Driver

The Brother Native driver is a printer driver developed exclusively by Brother, this driver includes more features than the Microsoft® Windows® Universal printer driver.

## Basic tab

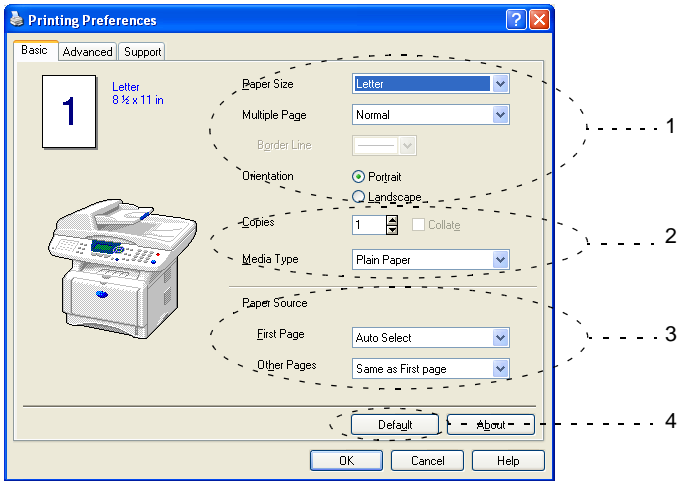

- 1 Select the **Paper Size**, **Multiple Page**, **Border Line** (if any) and **Orientation**.
- 2 Select number of **Copies** and **Media Type**.
- 3 Select **Paper Source** (**First Page** and **Other Pages**).
- 4 **Auto Select** allows the printer driver to select a suitable tray for **Paper Size** automatically. You can set the paper size for each tray in the *Accessories* tab. (See *Accessories tab* on page 2-16.) To return to the default settings, click the **Default** button.

## Paper Size

From the drop-down box select the Paper Size you are using.

## Multiple Page

The Multiple Page selection can reduce the image size of a page allowing multiple pages to be printed on one sheet of paper or enlarging the image size for printing one page on multiple sheets of paper.

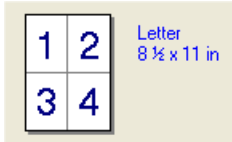

Ex. 4 in 1



Ex. 1 in 2 x 2 pages

## Border Line

When printing multiple pages on one sheet with the Multiple Page feature you can select to have a solid border, dash border or no border around each page on the sheet.

## Orientation

Orientation selects the position of how your document will be printed (**Portrait** or **Landscape**).

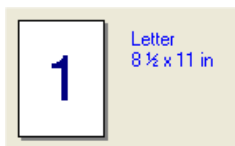

Portrait



Landscape

## Copies

The copies selection sets the number of copies that will be printed.

## Collate

With the **Collate** check box selected, one complete copy of your document will be printed and then repeated for the number of copies you selected. If the **Collate** check box is not selected, then each page will be printed for all the copies selected before the next page of the document is printed.

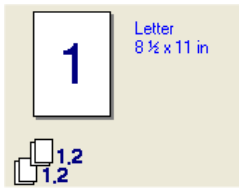

Collate box checked

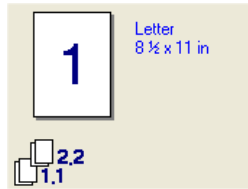

Collate box not checked

## Media Type

You can use the following types of media in your machine. For the best print quality, select the type of media that you wish to use.

**Plain Paper**

**Thin Paper**

**Thick Paper**

**Thicker Paper**

**Bond Paper**

**Transparencies**

**Envelopes**

**Env. Thick**

**Env. Thin**



■ When using ordinary plain paper (19 to 25 lb), select **Plain Paper**. When using heavier weight paper, or rough paper select **Thick Paper** or **Thicker Paper**. For bond paper, select **Bond Paper**, for OHP transparencies, select **Transparencies**.

■ When you use envelopes, select **Envelopes**. If the toner is not fixed to the envelope correctly when **Envelopes** has been selected, select **Env. Thick**. If the envelope is crumpled when **Envelopes** has been selected, select **Env. Thin**.

# Advanced tab

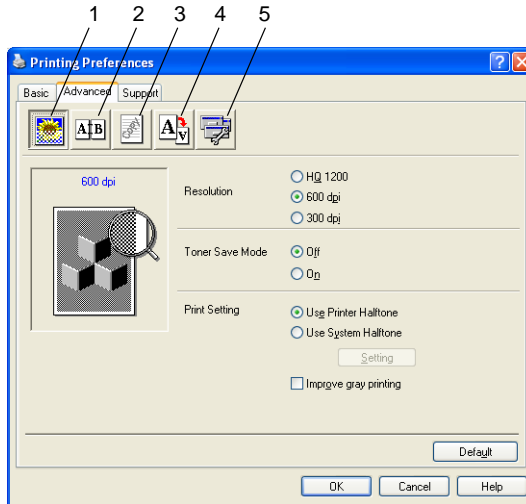

 To return to the default settings, click the **Default** button.

Change the tab settings by selecting one of the following icons:

1 **Print Quality**

2 **Duplex**

3 **Watermark**

4 **Page Setting**

5 **Device Options**

## Print Quality

### Resolution

You can select from the following resolutions:

■ HQ 1200

■ 600 dpi

■ 300 dpi

 When you select **Use Duplex Unit**, HQ 1200 is not available.

## Toner Save

You can save running costs by turning on the Toner Save Mode, which reduces the print density.

## Print Setting

*For Windows® 98/98SE/Me*

Print Setting is used for optimizing your print quality for the type of original being printed (Photos, Graphics or Scanned Images). When you choose **Auto (Recommended)**, the printer automatically prints with the most suitable print settings.

With the Print Setting set to Manual, you can change the Brightness, Contrast and Graphics Quality options manually.

*For Windows® 2000/XP/NT® WS 4.0*

- Check **Use Printer Halftone** to print using Halftone.
- Check **Use System Halftone** to print using Halftone of the system. To change the setting, press **Setting**.
- If the halftone cannot be printed correctly, check **Improve gray printing**.



## Duplex Printing

Choosing the Duplex Printing icon displays the Duplex features available.

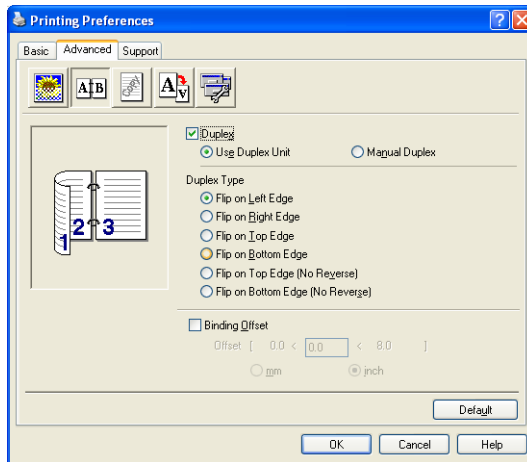

### Use Duplex Unit

(For MFC-8640D, MFC-8840D, MFC-8840DN and DCP-8045D)

Check the Duplex box and then select **Use Duplex Unit**. In this mode the machine prints on both sides of the paper automatically.

### Manual Duplex

Check the Duplex box and then select **Manual Duplex**. In this mode, the machine prints all the even numbered pages first. Then the printer driver stops and shows the instructions required to re-install the paper. When you click OK the odd numbered pages are printed.

### Duplex Type

You can select **Duplex Type**. There are six types of duplex directions available for each orientation.

**Flip on Left Edge**



**Flip on Right Edge**



**Flip on Top Edge**



**Flip on Bottom Edge**



**Flip on Top Edge (No Reverse)**



**Flip on Bottom Edge (No Reverse)**



## Binding Offset

Check the Binding Offset option, you can specify the offset value of the binding side in inches or millimeters (0 - 8 inches) [0 - 203.2 mm].

## Watermark

You can place a logo or text into your document as a Watermark. You can select one of the preset Watermarks, or you can use a bitmap file or text file that you have created.

Check **Use Watermark**, and then select the watermark you want to use.

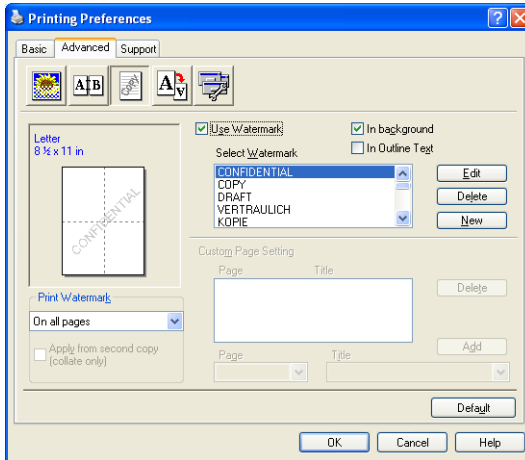

## In background

Check **In background** to print the watermark image in the background of your document. If this feature is not checked then the Watermark will be printed on top of your document.

## In Outline Text

**(Windows® 2000 Professional/XP/NT® 4.0 Only)**

Check **In Outline Text** if you only want to print an outline of the watermark.

## Print Watermark

The **Print Watermark** feature offers the following print choices:

- **On all pages**
- **On first page only**
- **From second page**
- **Custom**
- **Apply from second copy (collate only)**  
(For Windows® 2000/XP/Windows NT® 4.0)

## Watermark Setting

You can change the Watermark's size and position on the page by selecting the Watermark, and clicking the **Edit** button. If you want to add a new Watermark, click the **New** button, and then select **Text** or **Bitmap** in the **Watermark Style**.

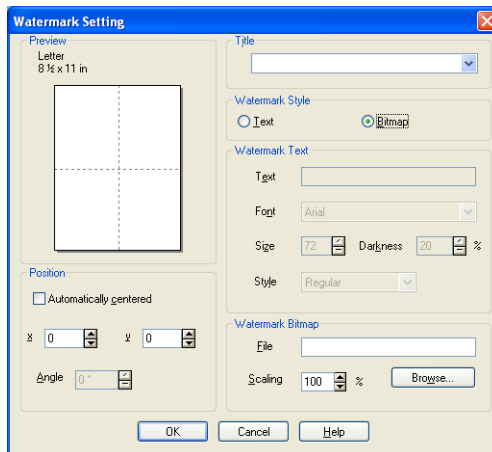

- **Title**  
You can select the **CONFIDENTIAL**, **COPY** or **DRAFT** as the standard title or enter a title you like in the field.
- **Watermark Text**  
Enter your Watermark text into the **Text** Box, and then select the **Font**, **Size**, **Darkness** and **Style**.
- **Watermark Bitmap**  
Enter the file name and location of your bitmap image in the **File** box, or **Browse** for the file location. You can also set the scaling size of the image.

## ■ Position

This setting offers you the control for where the Watermark is to be positioned on the page.

## Page Setting

You can change the print size of your document with the Scaling feature.

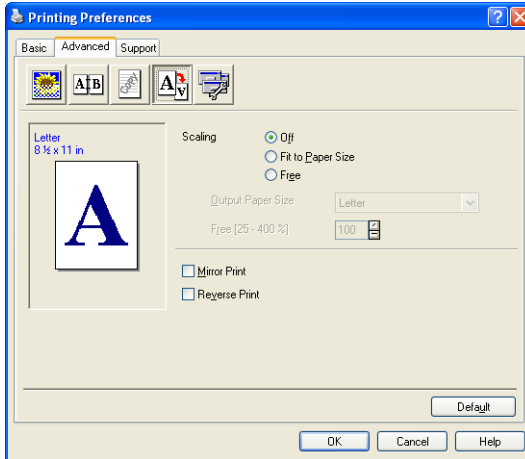

- Check **Off** if you want to print the document as it appears on your screen.
- Check **Fit to Paper Size**, if your document has an unusual size, or if you have only the standard size paper.
- Check the **Free** box if you want to manually reduce or enlarge the output.
- You can also use the **Mirror Print** or **Reverse Print** feature for your page setting.

## Device Options

Lets you set the following Printer Functions:

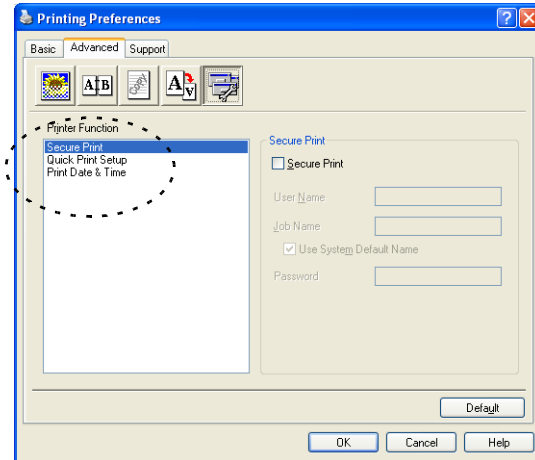

## Secure Print

Secure documents are documents that are password protected when they are sent to the machine. Only the people who know the password will be able to print them. Since the documents are secured at the machine, you must use the control panel of the machine (with the password) to print them.

*To send a secured document:*

- 1** Select **Secure Print** from **Printer Function** and check **Secure Print**.
- 2** Enter your password, user name and job name and click OK.
- 3** You must print the secured documents from the control panel of the machine. (See *Secure key* on page 1-16.)

*To delete a secured document:*

You need to use the control panel of the machine to delete a secured document. (See *Secure key* on page 1-16.)



You can store up to 8 MB of secured data in the machine's memory.

## Quick Print Setup

The Quick Print Setup feature allows you to quickly select driver settings. To view setting, simply click your mouse button on the task tray  icon. This feature can be set to ON or OFF from the Device Options section.

 The factory setting is OFF.

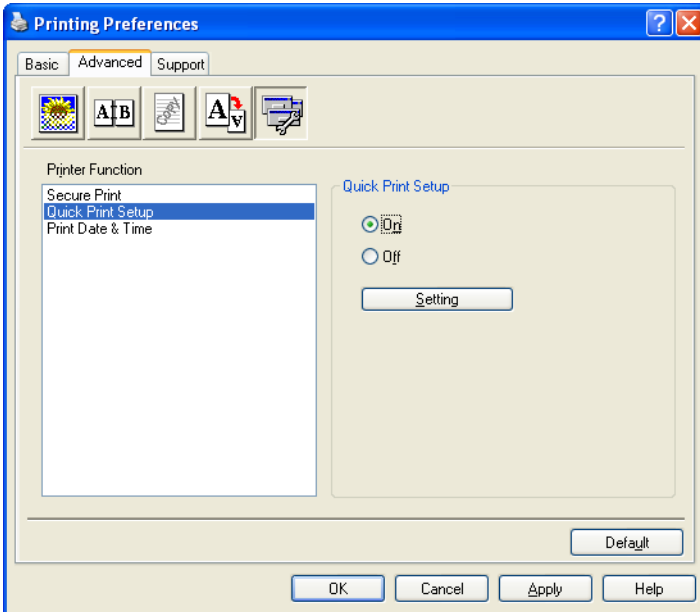

## Administrator (For Windows® 98/98SE/Me Users Only)

The administrator selection permits the Copy, Scaling and Watermark features to be locked and password protected.

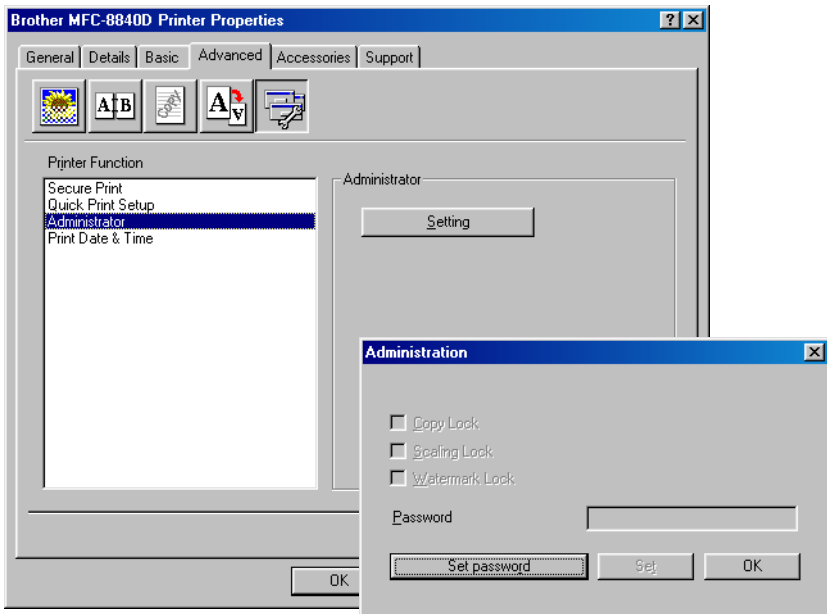

Record your password and keep it in a safe place for future reference. If you forget your password these settings can not be accessed.

## Print Date & Time

When enabled the **Print Date and Time** feature will automatically print the date and time from your computers system clock on your document.

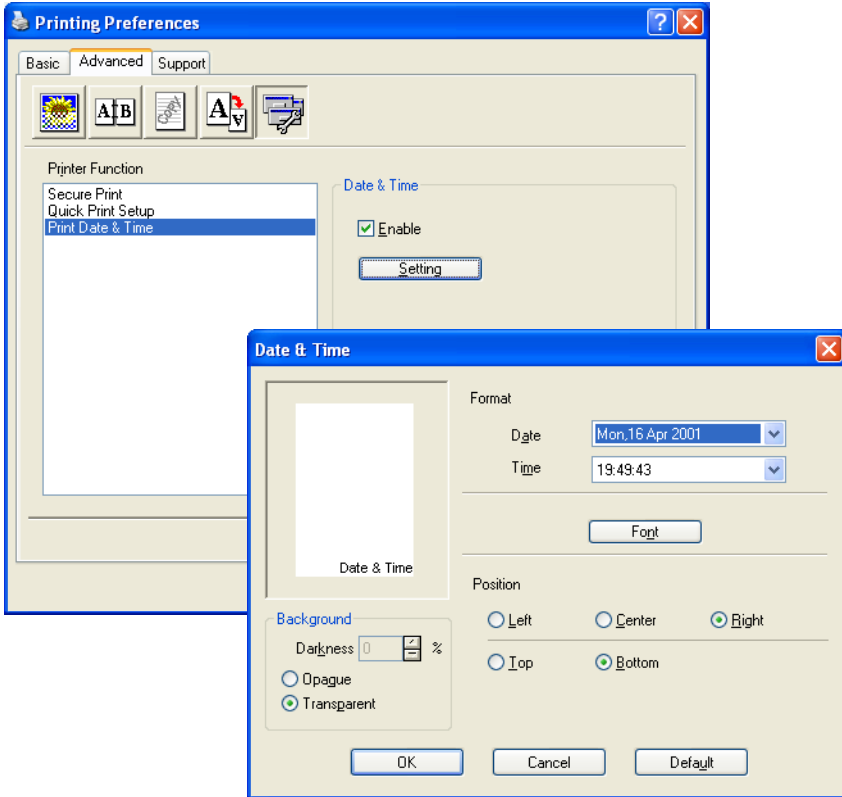

Click the **Setting** button to change the **Date** and **Time** Format. You can change the Font by clicking the **Font** button or the **Position**. To include a background with the **Date** and **Time** select **Opaque**. When **Opaque** is selected you can set the **Darkness** of the **Date** and **Time** background by changing the percentage.



The Date and Time indicated in the selection box represents the format that will be printed. The actual Date and Time printed on your document is automatically retrieved from the settings of your computer.



## Accessories tab

The **Accessories** Tab includes the settings for configuring the printer driver for the size of paper loaded in each paper source. This tab also installs any additional options into the driver settings.

### Paper Source Setting

To configure the paper size for each paper source, highlight the source in the **Paper Source Setting** list. Select the **Paper Size** from the pull-down box and click **Update**. When **Auto Select** (default paper source) is set in the **Basic** tab of the printer driver (see *Basic tab* on page 2-3), the printer driver will automatically use the **Paper Source Setting** to select a tray that matches the **Paper Size** setting in the printer driver.

### Default Source

The **Default Source** allows you to choose the paper source that will be used when the paper size of the document being sent does not match the Paper Source settings.

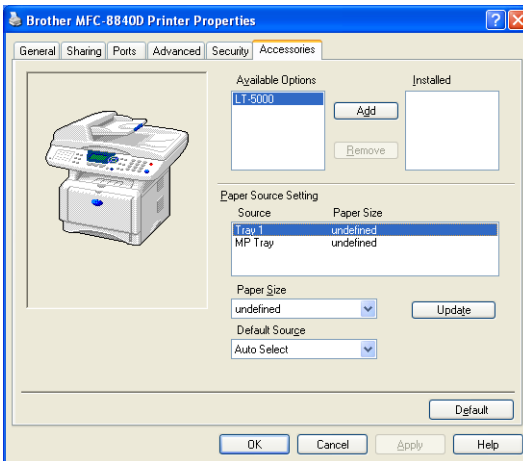

### Available Options

In order to use the optional 2nd paper tray, you must install the option in the driver. Highlight the model number from the **Available Options** list and click **Add**. The optional tray will then be listed in the **Installed** box, **Paper Source Setting** list and the screen illustration will display the 2nd tray.

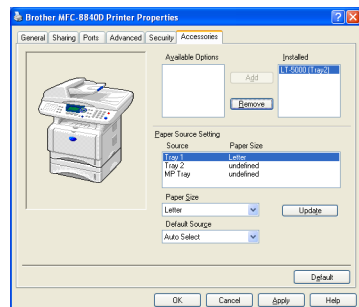

## Support tab

The **Support** tab provides driver version and setting information. In addition there are links to the **Brother Solutions Center** and the Driver Update Web sites.

Click the **Support** tab to display the following screen:



## Brother Solutions Center

The **Brother Solutions Center** is a Web site offering information about your Brother product including FAQs (Frequently Asked Questions), User Guides, Driver Updates and Tips for using your machine.

## Web Update

**Web Update** checks the Brother web site for updated drivers, and automatically downloads and updates the printer driver on your computer.

## Check Setting

The **Check Setting** selection displays a list of your current driver settings.

# Features in the PS printer driver (For Windows®)

The Windows® 98/98SE/Me/2000 Professional/XP and Windows NT® 4.0 utilizes BR-Script 3 (PostScript® 3™ language emulation) driver.

## To install the PS driver

If you have already installed the printer driver following the instruction in the Quick Setup Guide, insert the CD-ROM into the CD-ROM drive on your PC and click **Install MFL-Pro Suite** and follow the on-screen instructions. When the **Select Components** screen appears, check **PS Printer Driver**, and then continue following the on-screen instructions.

If you have not previously installed the driver and software, insert the CD-ROM into the CD-ROM drive on your PC and click **Install MFL-Pro Suite** and follow the on-screen instructions. When the **Connection Type** screen appears, select **Custom Install** and check the **PS Printer Driver**. Then continue following on-screen instructions.



- You can download the latest driver by accessing the Brother Solutions Center at <http://solutions.brother.com>
- The screens in this section are from Windows® XP for MFC-8840D.
- The screens on your PC will vary depending on your Operating System and machine.

## Ports tab

---

Select the port where your printer is connected or the path to the network printer you are using.

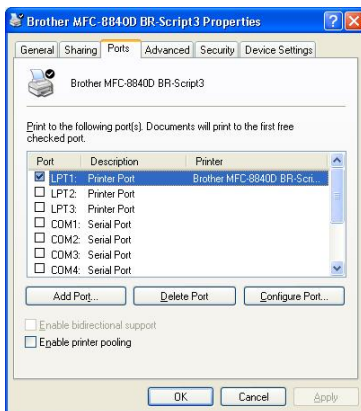

# Device Settings tab

Select the options you installed.



## Layout tab

 If you are using Windows NT® 4.0, Windows® 2000 or XP, you can access the **Layout** tab by clicking **Printing Preferences...** in the **General** tab of the **Brother MFC-8840D BR-Script3 Properties** screen.

You can change the Layout setting by selecting the setting in the **Orientation**, **Page Order** and **Page Per Sheet**.

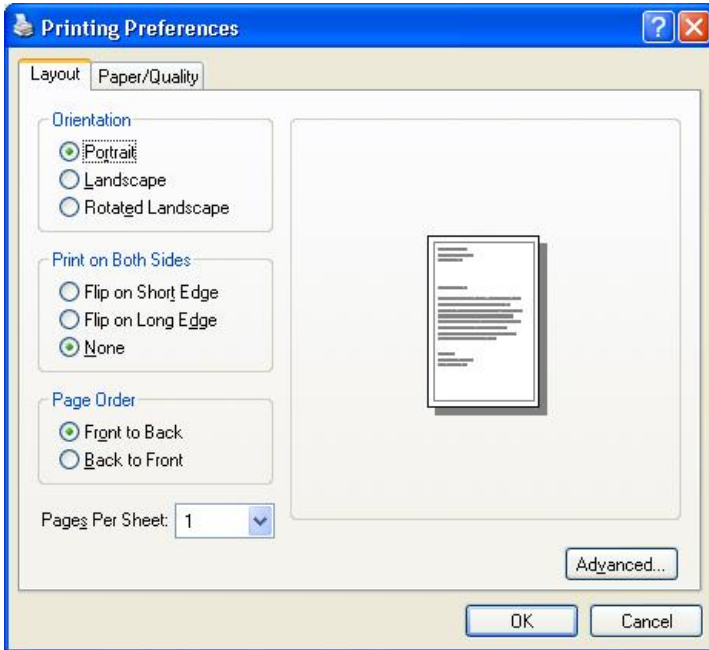

## Booklet (For MFC-8640D, MFC-8840D, MFC-8840DN and DCP-8045D) (For Windows® 2000/XP)

You can print a booklet by selecting **Booklet** from **Pages Per Sheet** list.

## Paper / Quality tab



If you are using Windows NT® 4.0, Windows® 2000 or XP, you can access the **Paper/Quality** tab by clicking **Printing Preferences...** in the **General** tab of the **Brother MFC-8840D BR-Script3 Properties** screen.

Select the **Paper Source**.

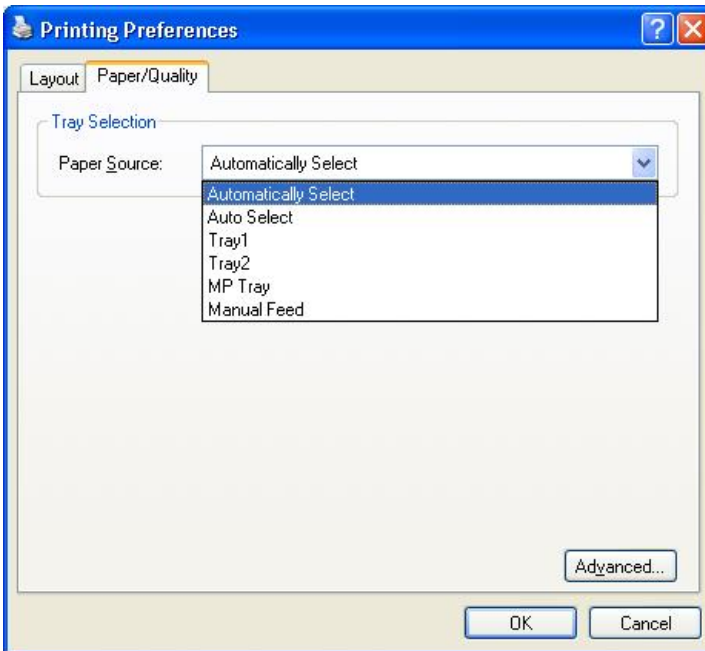

# Advanced Options

 If you are using Windows NT® 4.0, Windows® 2000 or XP, you can access the **Brother MFC-8840D BR-Script3 Advanced Options** tab by clicking **Advanced...** button in the **Layout** tab or the **Paper/Quality** tab.

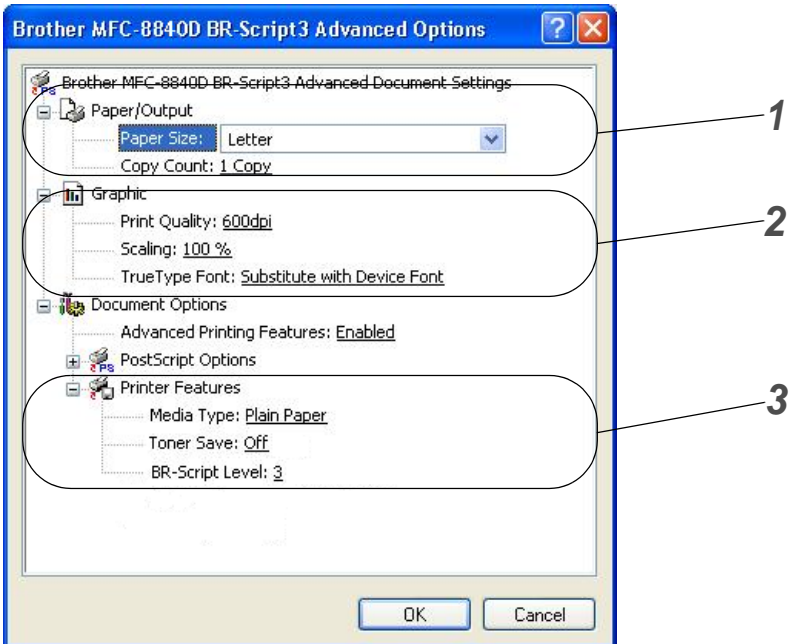

- 1 Select the **Paper Size** and **Copy Count**.
- 2 Set the **Print Quality**, **Scaling** and **TrueType Font** setting.
- 3 You can change settings by selecting the setting in the Printer Features list:
  - **Media Type**
  - **Toner Save**
  - **BR-Script Level**

# 3

## How to scan using Windows®



- The scanning operations and drivers will be different depending on your operating system.
- The screens shown in this chapter are from MFC-8840D.

### For Windows® XP

The machine uses Windows® Imaging Acquisition (WIA) for scanning documents. (See *Scanning a document (For Windows® XP only)* on page 3-2.)

In addition to the WIA driver, there is also a TWAIN compliant scanner driver installed. If you want to use it, you can switch TWAIN on from the **MFC-XXXX** or **DCP-XXXX (for advanced user)** located in the **Start/All Programs/Brother/MFL-Pro Suite MFC-XXXX**, or **DCP-XXXX/Enable-Disable TWAIN/MFC-XXXX** or **DCP-XXXX (for advanced user)** on your computer. (See *TWAIN compliant* on page 3-8.)

### For Windows® 98/98SE/Me and 2000 Professional

The machine uses a TWAIN Compliant driver for scanning documents from your applications. (See *Scanning a document* on page 3-8.)

### For Macintosh®

Go to *Using the Brother TWAIN scanner driver with your Macintosh®* on page 7-20.



### For ScanSoft® PaperPort® 9.0SE and OmniPage® OCR

Go to *Using ScanSoft® PaperPort® 9.0SE and OmniPage® OCR* on page 3-20.



# Scanning a document (For Windows® XP only)

## WIA compliant

---

Windows® XP uses Windows Image Acquisition (WIA) for scanning images from the scanner. You can scan images directly into the PaperPort® 9.0SE viewer that Brother included with your scanner or you can scan images directly into any other software application that supports WIA or TWAIN scanning.

## How to access the scanner

---

**1** Open your software application to scan a document.



The instructions for scanning in this guide are for when you use ScanSoft® PaperPort® 9.0SE. The steps for scanning from another application may vary.

**2** Select **Scan** from the **File** drop-down menu or click the Scan button.

The **Scan** pane appears in the left panel.

**3** Select the scanner you are using from the **Scanner** drop-down list box.

**4** Click **Scan**.

The Scan dialog box will appear:

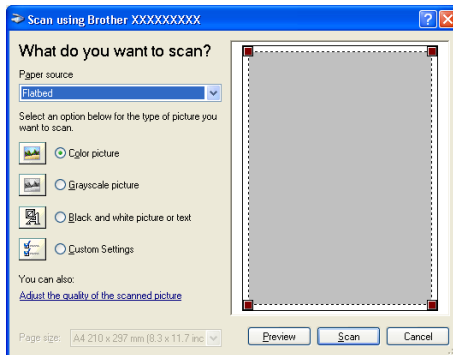

# Scanning a document into the PC

There are two ways in which you can scan a whole page. You can either use the ADF (automatic document feeder) or the Flatbed scanner glass.

If you would like to scan and then crop a portion of the page after pre-scanning the document, you will need to use the scanner glass (Flatbed). (See *PreScanning to crop a portion you want to scan* on page 3-11.)

## Scanning a document using the ADF

- 1 Place the original face up in the ADF (automatic document feeder).

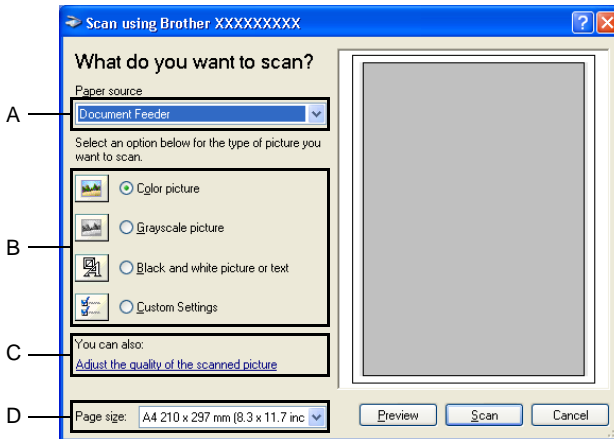

- 2 Select the **Document Feeder** from the **Paper source** drop-down list box (A).
- 3 Select the picture type (B).
- 4 Select the **Paper size** from the drop-down list box (D).
- 5 If you require advanced settings, click **Adjust the quality of the scanned picture** (C). You can select **Brightness**, **Contrast**, **Resolution** and **Picture Type** from the **Advanced Properties**. Click the **OK** button after you choose your settings.

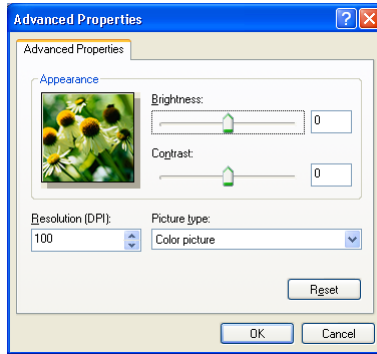

- The scanner resolution you can select is up to 1200 × 1200 dpi.
  - For resolutions greater than 1200 dpi, use the Brother Scanner Utility. (See *Brother Scanner Utility* on page 3-7.)
- 6** To start scanning your document, click the **Scan** button in the Scan dialog box.

## PreScanning to crop a portion you want to scan using the scanner glass

The **Preview** button is used to preview an image for cropping any unwanted portions from the image. When you are satisfied with the preview, click the **Scan** button from the scanner window to scan the image.

- 1 Place the original face down on the scanner glass.
- 2 Make sure you selected **Flatbed** in the Paper source pull-down box (A).

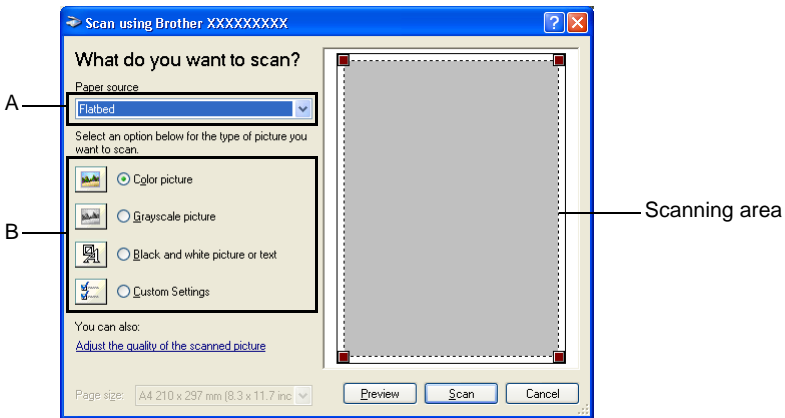

- 3 Select the picture type (B).
- 4 In the Scan dialog box, click the **Preview** button. The entire original will be scanned into the PC and will appear in the scanning area.
- 5 Select the portion you want to scan by clicking the left mouse button and dragging it over the area.



- 6 If you require advanced settings, click **Picture Type** from the **Adjust the quality of the scanned picture (C)**. You can select **Brightness, Contrast, Resolution** and **Advanced Properties**. Click the **OK** button after you choose your settings.

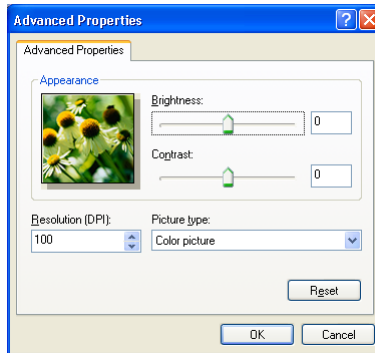
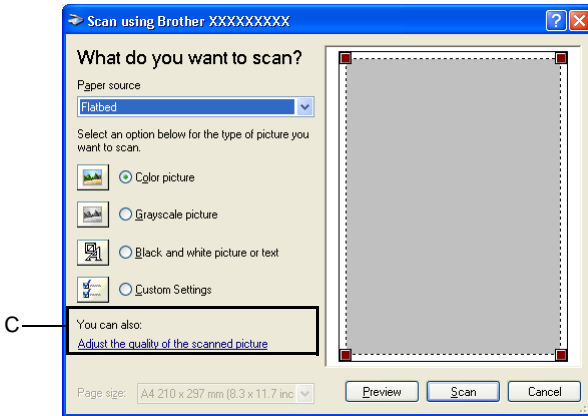

- 7 To start scanning your document, click the **Scan** button in the Scan dialog box. This time only the selected area of the original will appear in the PaperPort® window (or your software application window).

## Brother Scanner Utility

The Brother Scanner Utility is used for configuring the scanner driver for resolutions greater than 1200 dpi and for changing the paper size. If you want to set Legal size as the default size, change the setting using this utility. You must restart your PC for the new settings to take effect.

### To run the utility:

You can run the utility by selecting the **Scanner Utility** located in the **Start/All Programs/Brother/MFL-Pro Suite XXX-XXXX** menu.

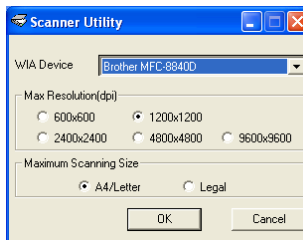

If you scan the document at a resolution of greater than 1200 dpi, the file size may be very large. Please make sure that you have sufficient memory and hard disk space for the size of the file you are trying to scan. If you do not have enough memory or hard disk space then your computer may freeze and you could lose your file.

## TWAIN compliant scanner driver for Windows® XP

If you have chosen to use the optional TWAIN Driver supplied for Windows® XP, follow the description for Windows® 98/98SE/Me and 2000 Professional. (See *How to scan using Windows®* on page 3-1 for instructions on how to turn the Windows® XP TWAIN driver ON.)

# Scanning a document

## TWAIN compliant

---

The Brother MFL-Pro Suite software includes a TWAIN compliant scanner driver. TWAIN drivers meet the standard universal protocol for communicating between scanners and software applications. This means that not only can you scan images directly into the PaperPort® 9.0SE viewer that Brother included with your machine, but you can also scan images directly into hundreds of other software applications that support TWAIN scanning. These applications include popular programs like Adobe® Photoshop®, Adobe® PageMaker®, CorelDraw® and many more.

# How to access the Scanner

 The instructions for scanning in this Guide are for when you use ScanSoft® PaperPort® 9.0SE.

- 1 Open the software application (ScanSoft® PaperPort® 9.0SE) to scan a document.
- 2 Select **Scan** from the **File** drop-down menu or select the **Scan** button. The **Scan** pane appears in the left panel.
- 3 Select the scanner you are using from the **Scanner** drop-down list box.
- 4 Click **Scan**.

 If the machine is connected via:

Parallel - use 'Brother XXX-XXXX.'

USB - use 'Brother XXX-XXXX USB'

LAN - use 'Brother XXX-XXXX LAN'

The **Scanner Setup** dialog box will appear:

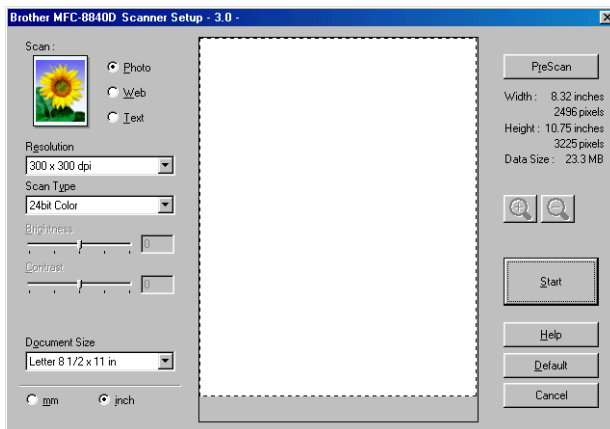



# Scanning a document into the PC

---

You can scan a whole page

—OR—

Scan a portion of the page after pre-scanning the document.

## Scanning a whole page

- 1 Place the original face up in the ADF (automatic document feeder), or face down on the scanner glass.
- 2 Adjust the following settings, if required, in the Scanner window:
  - **Image Type**
  - **Resolution**
  - **Scan Type**
  - **Brightness**
  - **Contrast**
  - **Document Size**



After you select a document size, you can adjust the scanning area further by clicking the left mouse button and dragging it. This is required when you want to crop an image when scanning.

See *Settings in the Scanner window* on page 3-13.

- 3 Click the **Start** button in the scanner window. When scanning is completed, click **Cancel** to return to the PaperPort® 9.0SE window.

## PreScanning to crop a portion you want to scan

The **Pre-Scan** button is used to preview an image for cropping any unwanted areas from the image. When you are satisfied with the preview, click the **Start** button in the scanner window to scan the image.

- 1 Place the original face up in the ADF, or face down on the scanner glass.

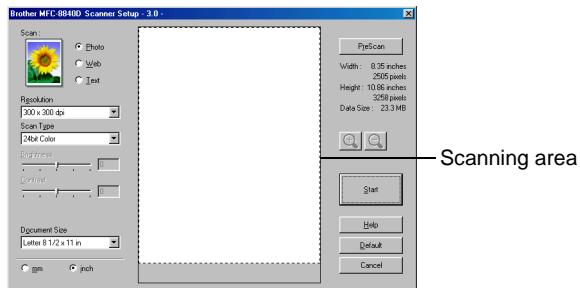

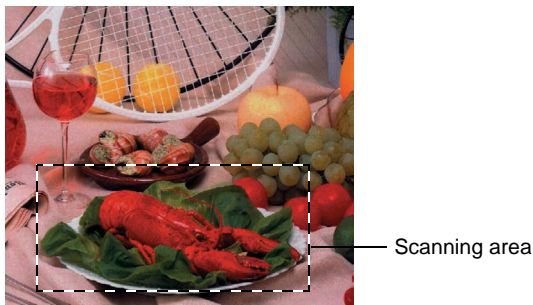

- 2 Select the settings for **Image Type**, **Resolution**, **Scan Type**, **Brightness** and **Contrast**, as needed.
- 3 In the **Scanner Setup** dialog box, click the **PreScan** button. The entire original will be scanned into the PC and will appear in the Scanning Area.



- 4 Select the portion you want to scan by clicking the left mouse button and dragging it.



You can enlarge the portion you selected by pressing  to check it. If you want to select the different portion, use  to undo the image.

- 5** Place the original face up in the ADF again, if you used the ADF in Step 1.
- 6** Click **Start**.  
This time only the selected area of the original will appear in the PaperPort® 9.0SE window (or your software application window).
- 7** In the PaperPort® 9.0SE window, use the options available to refine the image.

# Settings in the Scanner window

---

## Image Type

Select the output image type from **Photo**, **Web** or **Text**. **Resolution** and **Scan Type** will be altered for each default setting.

The default settings are:

Image Type		Resolution	Scan Type
<b>Photo</b>	Select for scanning photo images.	300 x 300 dpi	24-bit color
<b>Web</b>	Select for attaching the scanned image to web pages.	100 x 100 dpi	24-bit color
<b>Text</b>	Select for scanning text documents.	200 x 200 dpi	Black & White

## Resolution

You can change the scanning resolution from the **Resolution** drop down list. Higher resolutions take more memory and transfer time, but can achieve a finer scanned image. The following table shows the resolution settings available for each color mode.

Resolution	Black & White / Gray (Error Diffusion)	256 color	True Gray / 24 bit color / 24 bit color (Fast)
100 × 100 dpi	Yes	Yes	Yes
150 × 150 dpi	Yes	Yes	Yes
200 × 200 dpi	Yes	Yes	Yes
300 × 300 dpi	Yes	Yes	Yes
400 × 400 dpi	Yes	Yes	Yes
600 × 600 dpi	Yes	Yes	Yes
1200 × 1200 dpi	Yes	No	Yes
2400 × 2400 dpi	Yes	No	Yes
4800 × 4800 dpi	Yes	No	Yes
9600 × 9600 dpi	Yes	No	Yes

## Scan Type

- Black & White:** Set the Scan Type to **Black & White** for text or line art.
- Gray Scale:** Set the Scan Type to **Gray (Error Diffusion)** or **True Gray** for photographic images.
- Colors:** Set either:  
**256 Color**, which scans up to 256 colors, or **24-bit color** which scans up to 16.8 million colors, **24-bit color (Fast)** which does not use Color Matching and is faster than **24-bit color**. Although using **24-bit color** creates an image with the most accurate colors, the image file will be approximately three times larger than a file created with **256 Color**.

## Brightness

Adjust this settings (-50 to 50) to obtain the best image. The default value is 0, representing an 'average'.

You can set the level by dragging the slide bar to the right or left to lighten or darken the image. You can also type a value in the box for the setting.

If the scanned image is too light, set a lower brightness value and scan the document again. If the image is too dark, set a higher brightness value and scan the document again.

## Contrast

This setting is adjustable only when you have selected one of the gray scale settings. It is not available when **Black & White** and **Color** settings are selected as the **Scan Type**.

You can increase or decrease the contrast level by moving the slide bar to the left or right. An increase emphasizes dark and light areas of the image, while a decrease reveals more detail in gray areas. You can also type a value in the box for the setting.

## Document Size

Set the Size to one of the following:

- Letter (8 1/2 × 11 in.)
- A4 (210 × 297 mm)
- Legal (8 1/2 × 14 in.)
- A5 (148 × 210 mm)
- B5 (182 × 257 mm)
- Executive (7 1/4 × 10 1/2 in.)
- Business Card (90 × 60 mm)
- Photo 3.5 × 5 in. (9 × 13cm)
- Photo 5 × 7 in. (13 × 18cm)
- APS C 4 × 6 in. (10 × 15cm)
- Custom (User adjustable from 0.35 × 0.35 in. to 8.5 × 14 in. or 8.9 × 8.9 mm to 215.9 × 355.6 mm)

To scan photographs or business cards, select the document size, and then place the document face down at the center of scanner glass.

When scanning photographs or other images for use in a word processor or other graphics application. You should try different settings for the contrast and resolution modes to see which best suits your needs.

If you selected **Custom** as the size, The **Custom Document Size** dialog box will appear.

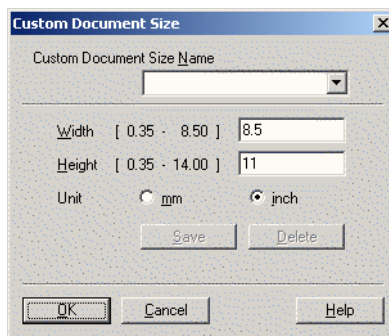

Type the **Name**, **Width** and **Height** for the document.

You can choose “mm” or “inch” as the unit for Width and Height.



You can see the actual paper size you selected on the screen.

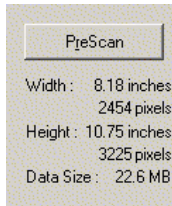

- **Width:** shows the width of scanning area
- **Height:** shows the height of scanning area
- **Data Size:** shows the approximate data size calculated in a Bitmap format. The size will be different for other file formats such as JPEG.

# Using the scan key (For USB or Parallel interface cable users)



If you use the Scan key on a network, please refer to *Using the Scan key* on page 8-5.

You can use **Scan** on the control panel to scan originals into your word processing, graphics or E-mail applications or your computer folder. The advantage of using **Scan** is that you avoid the mouse clicks required to scan from your computer.



**scan**

MFC-8440, MFC-8640D, MFC-8840D,  
MFC-8840DN



**Scan**

DCP-8040, DCP-8045D



Before you can use **Scan** on the control panel, you must have connected the machine to your Windows<sup>®</sup> based computer and loaded the appropriate Brother Drivers for your version of Windows<sup>®</sup>.

For details about how to configure ControlCenter 2.0 buttons to launch the application of your choice using **Scan**, go to the appropriate chapter:

- For Windows<sup>®</sup>, see *Using ControlCenter2.0* on page 4-1.
- For Macintosh<sup>®</sup>, see *Using ControlCenter2.0 (For Mac OS<sup>®</sup> X 10.2.1 or greater)* on page 7-29.





## Scan to E-mail

---

You can either scan a black and white or color original into your E-mail application as a file attachment. You can change the **Scan** configuration. (See *Scan to E-mail*: on page 4-14.)

**1** Place the original face up in the ADF, or face down on the scanner glass.

**2** Press **Scan**.

**3** Press  or  to select

Scan to E-mail.

Press **Set**.

▲ Scan to E-mail
Scan to Image
Scan to OCR
▼ Scan to File
Select ▲▼ & Set

**4** Press  or  to select PC.

Press **Set**.

The machine will scan the original, create a file attachment, and launch your E-mail application, displaying the new message waiting to be addressed.



## Scan to Image

---

You can scan a color picture into your graphics application for viewing and editing. You can change the **Scan** configuration. (See *Scan to Image*: on page 4-12.)

**1** Place the original face up in the ADF, or face down on the scanner glass.

**2** Press **Scan**.

**3** Press  or  to select

Scan to Image.

Press **Set**.



▲ Scan to E-mail
Scan to Image
Scan to OCR
▼ Scan to File
Select ▲▼ & Set

The machine will start the scanning process.

## Scan to OCR

---

If your original is text only, you can have it converted by ScanSoft® OmniPage® to an editable text file and then have the result displayed in your word processing application for viewing and editing. You can change the **Scan** configuration. (See *Scan to OCR*: on page 4-13.)



- 1 Place the original face up in the ADF, or face down on the scanner glass.
- 2 Press **Scan**.
- 3 Press  or  to select Scan to OCR.  
Press **Set**.  
The machine will start the scanning process.

▲ Scan to E-mail
Scan to Image
Scan to OCR
▼ Scan to File
Select ▲▼ & Set

## Scan to File

---

You can scan a black and white or a color original into your computer and save it as a file in the folder you choose. The file type and specific folder are based on the settings you have chosen in the Scan to File screen of the ControlCenter2.0. (See *Scan to File*: on page 4-15.)

- 1 Place the original face up in the ADF, or face down on the scanner glass.
- 2 Press **Scan**.
- 3 Press  or  to select Scan to File.  
Press **Set**.
- 4 The machine will start the scanning process.

▲ Scan to E-mail
Scan to Image
Scan to OCR
▼ Scan to File
Select ▲▼ & Set

# Using ScanSoft® PaperPort® 9.0SE and OmniPage® OCR

ScanSoft® PaperPort® 9.0SE for Brother is a document management application. You will use PaperPort® 9.0SE to view scanned documents.

PaperPort® 9.0SE has a sophisticated, yet easy-to-use, filing system that will help you organize your graphics and text documents. It allows you to combine or “stack” documents of different formats for printing, faxing or filing.

ScanSoft® PaperPort® 9.0SE can be accessed through the ScanSoft® PaperPort® 9.0SE program group.

See *Documentation for ScanSoft® PaperPort® 9.0SE on the CD-ROM.*

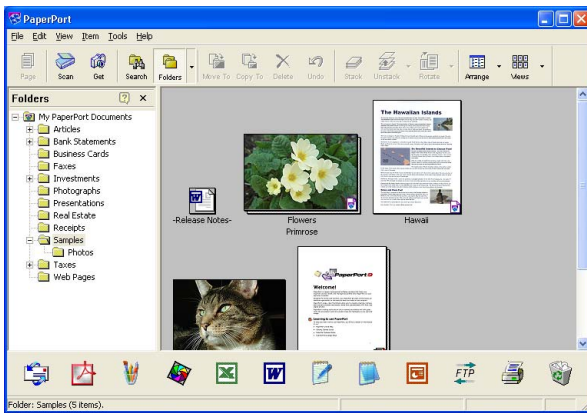

The complete ScanSoft® PaperPort® 9.0SE User’s Guide, including ScanSoft® OmniPage® OCR, is in the documentation on the CD-ROM.

This chapter is only an introduction to the basic operations.

When you install MFL-Pro Suite, ScanSoft® PaperPort® 9.0SE for Brother and ScanSoft® OmniPage® OCR are installed with it automatically.



If you are using Windows® XP, Windows NT® 4.0 or Windows® 2000 Professional, we recommend that you are logged on with administrator rights.

# Viewing items

ScanSoft® PaperPort® 9.0SE provides several ways to view items:

**Desktop View** displays a thumbnail (a small graphic that represents each item in a Desktop or folder).

Items in the selected folder appear on the PaperPort® 9.0SE Desktop. You can see PaperPort® 9.0SE items (MAX files) and non-PaperPort® 9.0SE items (files created using other applications).

Non-PaperPort® 9.0SE items include an icon that indicates the application that was used to create the item; a non-PaperPort® 9.0SE item is represented by a small rectangular thumbnail and not an actual image.

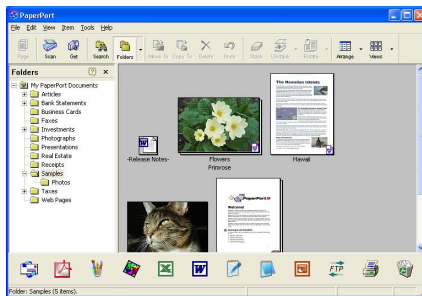

Desktop View displays items as thumbnails

**Page View** displays a close-up of a single page. You can open a PaperPort® 9.0SE item by double-clicking on it.

As long as you have the appropriate application on your computer to display it, you can also double-click a non-PaperPort® 9.0SE item to open it.

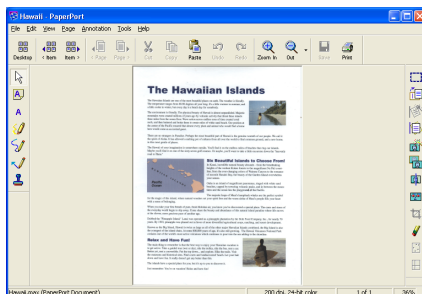

Page View displays each item as a full page

## Organizing your items in folders

---

PaperPort® 9.0SE has an easy-to-use filing system for organizing your items. The filing system consists of folders and items that you select to view in Desktop View. An item can be a PaperPort® 9.0SE item or a non-PaperPort® 9.0SE item:

- Folders are arranged in a “tree” structure in the Folder View. You use this section to select folders and view their items in Desktop View.
- You can simply drag and drop an item onto a folder. When the folder is highlighted, release the mouse button and the item is stored in that folder.
- Folders can be “nested”—that is, stored in other folders.
- When you double-click a folder, its items (both PaperPort® 9.0SE MAX files and non PaperPort® 9.0SE files) appear on the Desktop.
- **You can also use Windows® Explorer to manage the folders and items shown in Desktop View.**

## Quick links to other applications

---

ScanSoft® PaperPort® 9.0SE automatically recognizes many other applications on your computer and creates a “working link” to them. The Send To Bar at the bottom of the Desktop view shows icons of those linked applications.

To use a link, drag an item onto one of the icons to start the application represented by the icon. A typical use of the Send To Bar is to select an item and then fax it.

This sample Send To Bar shows several applications with links to PaperPort® 9.0SE.



If PaperPort® 9.0SE does not automatically recognize one of the applications on your computer, you can manually create a link using the **New Program Link...** command.

(See PaperPort® 9.0SE in the Documentation section on the CD-ROM for more information about creating new links.)

# ScanSoft® OmniPage® OCR lets you convert image text into text you can edit

---

Software by:



ScanSoft® OmniPage® OCR is installed automatically with PaperPort® 9.0SE when you install MFL-Pro Suite on your computer.

ScanSoft® PaperPort® 9.0SE can quickly convert the text on a ScanSoft® PaperPort® 9.0SE item (which is really just a picture of the text) into text that you can edit with a word processing application.

PaperPort® 9.0SE uses the optical character recognition application ScanSoft® OmniPage®, which comes with PaperPort® 9.0SE

—OR—

PaperPort® 9.0SE can use your preferred OCR application if it is already on your computer. You can convert the entire item, or by using the **Copy Text** command, you can select only a portion of the text to convert.

Dragging an item onto a word-processing link icon starts PaperPort® 9.0SE's built-in OCR application, or you can use your own OCR application.



## You can Import items from other applications

---

In addition to scanning items, you can bring items into PaperPort® 9.0SE in a variety of ways and convert them to PaperPort® 9.0SE (MAX) files in several different ways:

- Print to the Desktop View from another application, such as Microsoft® Excel.
- Import files saved in other file formats, such as Windows® Bitmap (BMP) or Tagged Image File Format (TIFF).

## You can Export items in other formats

---

You can export or save PaperPort® 9.0SE items in several popular file formats, such as BMP, JPEG, TIFF, PDF or self-viewing.

For example, to create a file for an Internet Web site, export it as a JPEG file. Web pages often use JPEG files for displaying images.

### Exporting an image file

- 1** Select the **Save As** command from the File pull-down menu in the PaperPort® 9.0SE window. The Save 'XXXXX' as dialog box will be displayed.
- 2** Select the drive and directory where you want to store the file.
- 3** Enter the new file name and choose the file type or select a name from the File Name text box. (You can scroll through the Directories and File Name listing for prompting.)
- 4** Select the **Save** button to save your file, or **Cancel** to return to the PaperPort® 9.0SE without saving it.

# How to Uninstall PaperPort® 9.0SE and ScanSoft® OmniPage® OCR

---

*For Windows® 98/98SE, Windows® Me and Windows NT® 4.0:*

Select **Start, Settings, Control Panel, Add/Remove Programs** and the **Install/Uninstall** tab.

Select **PaperPort** and click the **Add/Remove** button.

Select **PaperPort** from the list and click the **Add/Remove** button.

*For Windows® 2000 Professional:*

Select **Start, Settings, Control Panel** and **Add/Remove Programs**.

Select **PaperPort** and click the **Change/Remove** button.

Select **PaperPort** from the list and click the **Change** button.

*For Windows® XP:*

Select **Start, Control Panel, Add or Remove Programs** and the **Change or Remove Programs** icon.

Select **PaperPort** from the list and click the **Change/Remove** button.



# 4

## Using ControlCenter2.0

(For Windows®)



- The screens shown in this chapter are from MFC-8840D.
- The functions that can be used in ControlCenter2.0 may vary depending upon the model.

## ControlCenter2.0

ControlCenter2.0 is a software utility that allows you to quickly and easily access your frequently used applications. Using ControlCenter2.0 eliminates the need to manually launch the specific applications. ControlCenter2.0 provides the following five categories of operations:

- 1 Scan directly to a file, E-mail, word processor or graphics application of your choice.
- 2 Custom Scan buttons allow you to configure a button to meet your own application requirements.
- 3 Access the Copy features available via your computer.
- 4 Access the “PC-FAX” applications available for your device.  
(For MFC-8440, MFC-8640D, MFC-8840D and MFC-8840DN only)
- 5 Access the settings available to configure your device.

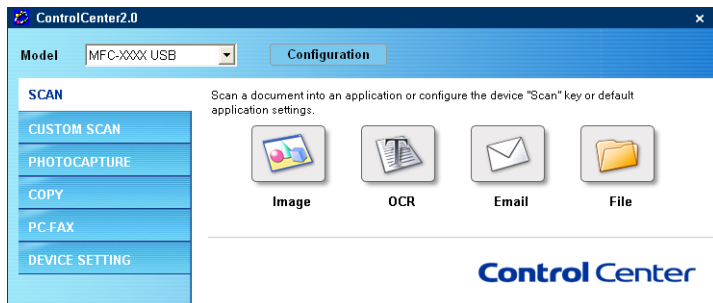

You can select which machine ControlCenter2.0 will connect with from the **Model** pull-down list.

Also you can open the configuration window for each function by clicking the **Configuration** button.

# How to turn off the AutoLoad feature in ControlCenter2.0

---

Once you start ControlCenter2.0 from the Start menu, the icon will appear on the task tray. You can open ControlCenter2.0 window by double-clicking on the  icon.

If you do not want ControlCenter2.0 to run automatically each time the computer is started;

- 1 Right-click on ControlCenter2.0 icon  in the Task Tray, and select **Preferences**.
- 2 ControlCenter2.0 preference window appears, then uncheck the **Start ControlCenter on computer startup** check box.
- 3 Click **OK** to close the window.

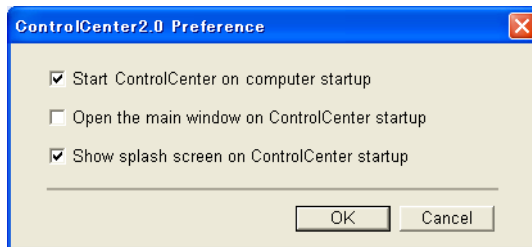

## SCAN

---

This section contains four buttons for **Scan to Image**, **Scan to OCR**, **Scan to E-mail** and **Scan to File** applications.

- **Image** (*Default: Microsoft Paint*) — enables you to scan a page directly into any graphic viewer/editor application. You can select the destination application, such as MS Paint, Corel PhotoPaint, Adobe PhotoShop, or any kind of image editing application you have installed on your computer.
- **OCR** (*Default: MS WordPad*) — enables you to scan a page or document, automatically run the OCR application and insert the text (not a graphic image) into a word processing application. You have the option of selecting the target word processing application, such as WordPad, MS Word, Word Perfect or whichever word processing application is installed on your computer.
- **E-mail** (*Default: your default E-mail software*) — enables you to scan a page or document directly into an E-mail application as a standard attachment. You have the option of selecting the file type and resolution for the attachment.
- **File** — enables you to scan directly to a disk file. You can change the file type and destination folder, as needed.

ControlCenter2.0 gives you the ability to configure the hardware **Scan** key on your machine for each scan feature. Select the **Device Button** in the configuration menu for each of the **SCAN** buttons.

## CUSTOM SCAN

---

You can configure the button name and settings for each of these buttons to meet your specific requirements by right-clicking on a button and following the configuration menus.

## COPY

---

**Copy** — allows you to use the PC and any printer driver for enhanced copy operations. You can scan the page on the machine and print the copies using any of the features of the machine printer driver—**OR**—you can direct the copy output to any standard printer driver installed on the PC including network printers.

You can configure your preferred settings on up to four buttons.

## PC-FAX (For MFC-8440, MFC-8640D, MFC-8840D and MFC-8840DN only)

---

These buttons are for sending or receiving faxes using the Brother PC-FAX application.

- **Send** — enables you to scan a page or document and automatically send the image as a fax from the PC using the Brother PC-FAX software. (See *PC-FAX sending* on page 6-1.)
- **Receive** — enables you to receive a PC-FAX by clicking this button. After running the PC-FAX receive software, this button changes to View Received to open the application and see the received fax. (See *Setting up PC-FAX receiving* on page 6-19.)



When the machine is connected to a network, you cannot use this function.

- **Address Book** — enables you to open Brother PC-FAX address book. (See *Brother Address Book* on page 6-7.)
- **Setup** — enables you to configure the PC-FAX sending settings. (See *Sending setup* on page 6-3.)

## DEVICE SETTING (For MFC-8440, MFC-8640D, MFC-8840D and MFC-8840DN only)

---

You can configure the machine setting.

- **Remote Setup** — enables you to open the Remote Setup Program. (See *MFC Remote Setup* on page 5-1.)



When the machine is connected to a network, you cannot use this function.

# SCAN

This section contains four buttons for **Scan to Image**, **Scan to OCR**, **Scan to E-mail** and **Scan to File** applications.

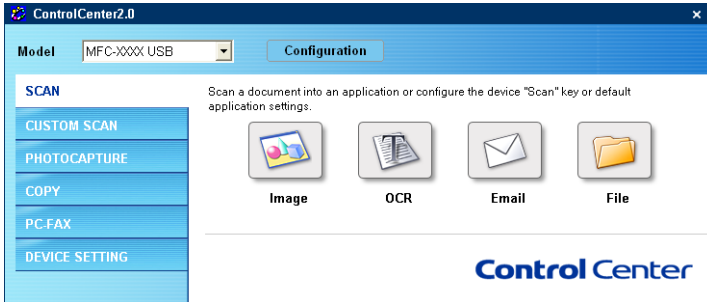

## Image (example: Microsoft Paint)

**Scan to Image** feature allows you to scan an image directly into your graphics application for image editing. To change the default settings, right-click on the button and select **Software Button**.

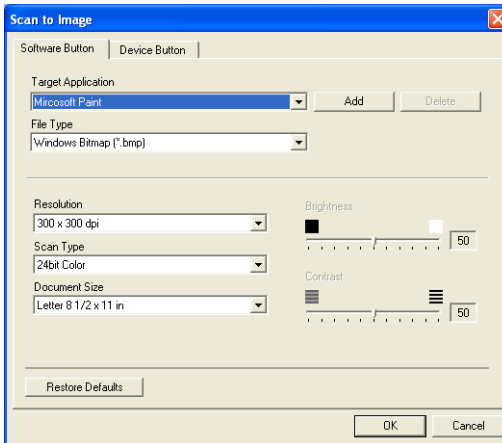



Change the other settings, if needed.

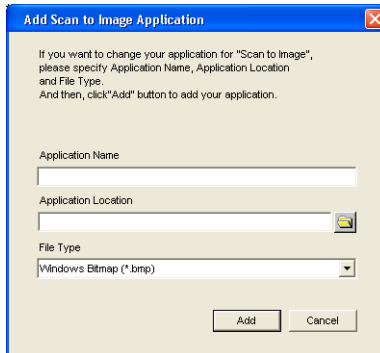

By selecting **Device Button** at each Scan button, you can configure the **Scan** key on your machine for each scan feature.

To change the destination application, select the appropriate application from the **Target Application** pull down list. You can add an application to the list by clicking the **Add** button.



Enter the **Application Name** (up to 30 characters) and the **Application Location**. You can also find the application location by clicking  button. Choose the **File Type** from the pull-down list. If you want to delete application you have added, select **Application Name** from the pull down list.

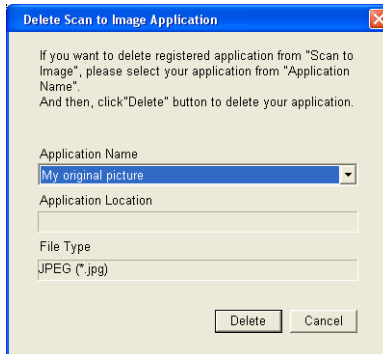

This function is also available for Scan to E-mail and Scan to OCR. The window may vary depending upon the function.

# OCR (Word Processing program)

**Scan to OCR** converts the graphic page image data into text which can be edited by any word processor program. You can change the default word processor program.

To configure **Scan to OCR**, right-click on the button and select **Software Button**.

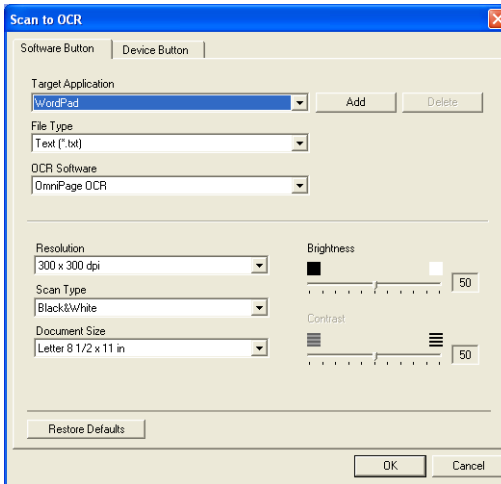

To change the word processing application, select the destination word processing application from the **Target Application** pull down list. You can add an application to the list by clicking on the **Add** button. An application can be deleted by clicking on the **Delete** button. You can also configure the other settings for this selection.

# E-mail

**Scan to E-mail** feature allows you to scan a document to your default E-mail application, so you can send the scanned job as an attachment. To change the default E-mail application or attachment file type, right-click on the button and select **Software Button**.

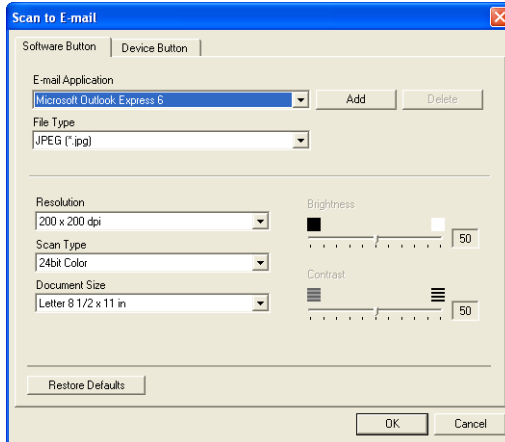

To change the E-mail application, select your preferred E-mail application from the **E-mail Application** pull down list. You can add an application to the list by clicking the **Add** button. An application can be deleted by clicking on the **Delete** button.

You can also change the other settings used to create the file attachments.



## File attachments

---

You can choose from the following list of file types for attachment to your E-mail or for saving to a folder.

**File Type** — Select from the pull-down list the type of file you want the scanned images to be saved in.

Windows Bitmap (\*.bmp)

JPEG (\*.jpg)

TIFF - Uncompressed (\*.tif)

TIFF - Compressed (\*.tif)

TIFF Multi-Page - Uncompressed (\*.tif)

TIFF Multi-Page - Compressed (\*.tif)

Portable Network Graphics (\*.png)

PDF (\*.pdf)



Additional file format support is available by scanning to PaperPort® and then use the save as function and choose the file format. (See *Using ScanSoft® PaperPort® 9.0SE and OmniPage® OCR* on page 3-20.)

The additional file types supported are:

TIFF - Group 4 (\*.tif)

TIFF - Class F (\*.tif)

TIFF Multi Page - Group 4 (\*.tif)

TIFF Multi Page - Class F (\*.tif)

# File

**Scan to File** button allows you to scan an image and save it in a specific file type to any directory on your PC. This allows you to easily archive your paper documents. To configure the file type and save to directory, right-click on the button and select **Software Button**.

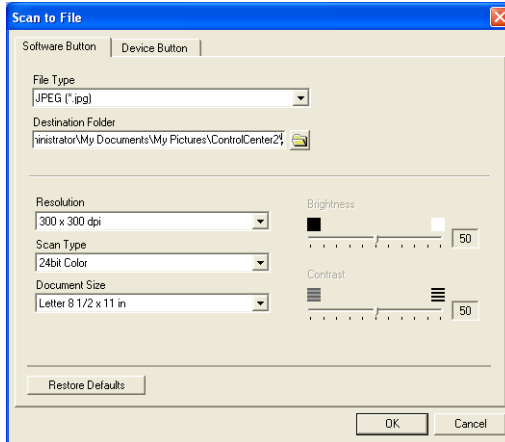

Select the file type for the saved image by selecting from the **File Type** pull-down list. You can save the file to the default folder which is shown currently in the **Destination Folder** box, or you can select another folder/directory by clicking  button.



For the supported file types, please refer to the *File attachments* on page 4-9.

# CUSTOM SCAN

There are four buttons from which you can set your own preferences and configuration to fit your required usage for scanning.

To configure a button, right-click on the button, and the configuration window will appear. You have four function choices of scan action, **Scan to Image**, **Scan to OCR**, **Scan to E-mail** and **Scan to File**.

**Scan to Image:** This setting allows you to scan a page directly into any graphic viewer/editor software. You can select any kind of image editor application you have installed on your computer as a destination application.

**Scan to OCR:** Scanned documents will be converted into editable text files. If you have a third party OCR software package installed on your PC you can select it. You can also select the destination application for the editable text.

**Scan to E-mail:** Scanned images will be attached to an E-mail message. You can choose which E-mail application to use if you have more than one installed on your system. You can also select the file type for the attachment and create a quick send list of E-mail addresses chosen from your default E-mail address book.

**Scan to File:** This setting allows you to save a scanned image to any directory on a local or network hard disk. You can also select the file type to be used.

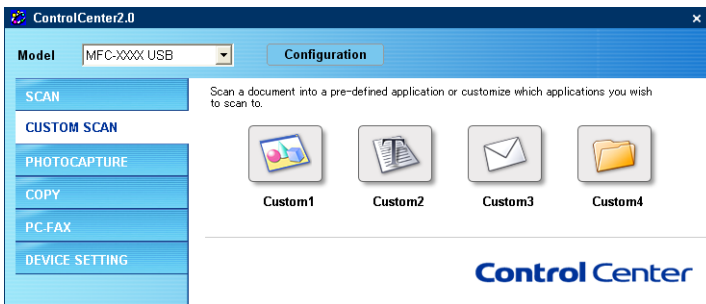

# Customizing a user-defined button

To configure a button, right-click on the button, and the configuration window will appear. Please read the following guide lines for the button configuration.

## Scan to Image:

In the **General** tab

You can enter up to 30 characters in the **Name for Custom** field. This name will appear as the button name.

Select the type of scan from the **Scan Action** field.

In the **Settings** tab

You can select **Target Application**, **File Type**, **Resolution**, **Scan Type**, **Document Size**, **Brightness** and **Contrast** settings.

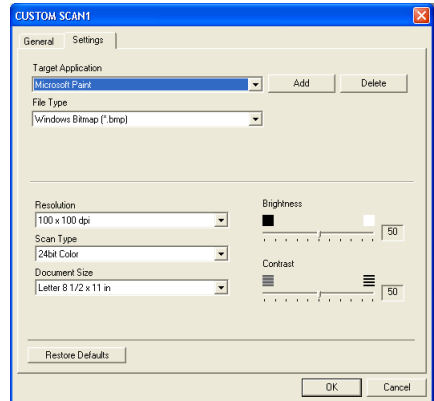
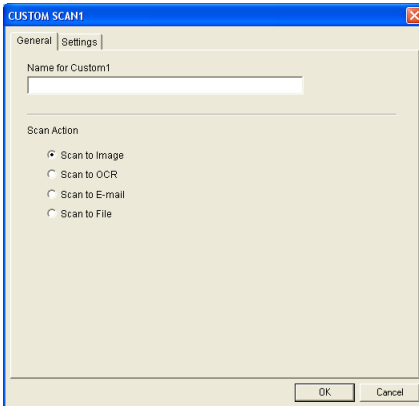

## Scan to OCR:

In the **General** tab

You can enter up to 30 characters in the **Name for Custom** field. This name will appear as the button name.

Select the type of scan from the **Scan Action** field.

In the **Settings** tab

You can select **Target Application**, **File Type**, **OCR Software**, **Resolution**, **Scan Type**, **Document Size**, **Brightness** and **Contrast** settings.

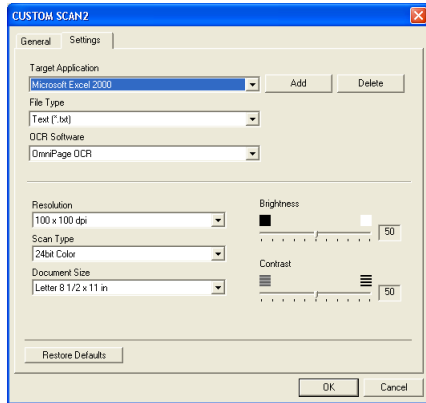
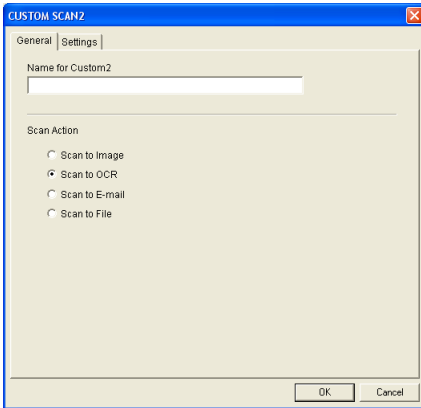

## Scan to E-mail:

In the **General** tab

You can enter up to 30 characters in the **Name for Custom** field. This name will appear as the button name.

Select the type of scan from the **Scan Action** field.

In the **Settings** tab

You can select **E-mail Application**, **File Type**, **Resolution**, **Scan Type**, **Document Size**, **Brightness** and **Contrast** settings.

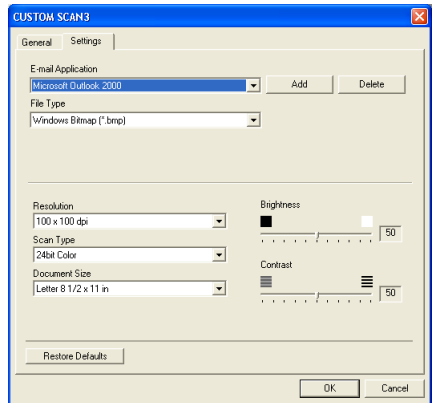
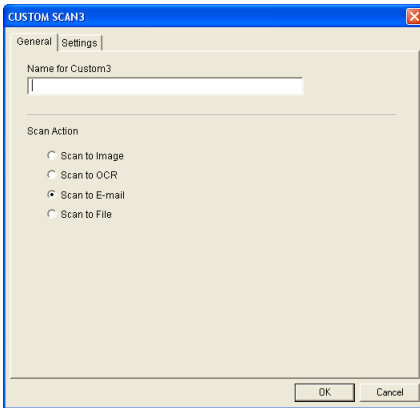

## Scan to File:

In the **General** tab

You can enter up to 30 characters in the **Name for Custom** field. This name will appear as the button name.

Select the type of scan from the **Scan Action** field.

In the **Settings** tab

Select the file format from the **File Type** pull down list. You can either send the file to the default folder which is shown currently in the **Destination Folder** box or select your preferred folder by using  button.

You can also select **Resolution**, **Scan Type**, **Document Size**, **Brightness** and **Contrast** settings.

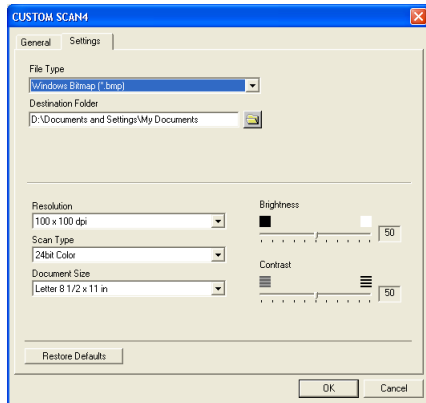
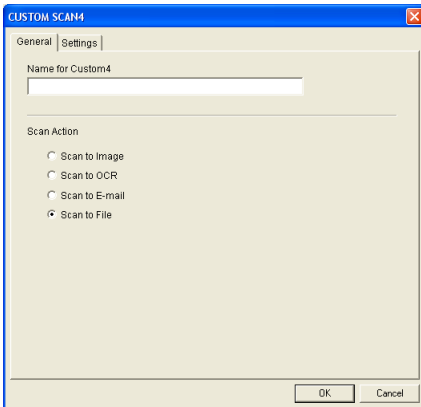

# COPY

The **Copy** buttons (1-4) can be customized to allow you to take advantage of the features built into the Brother printer drivers to do advanced copy functions such as N-in-1 printing.

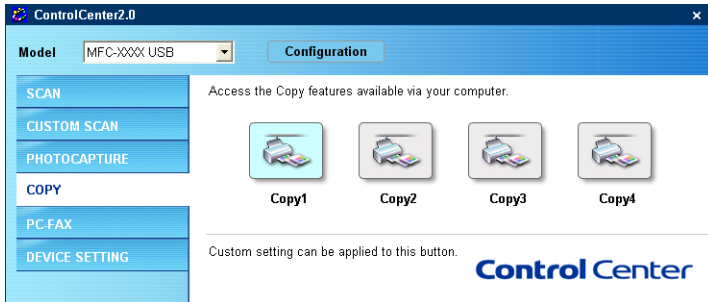

Before you can use the **Copy** buttons you must first configure the printer driver by right-clicking on the button.

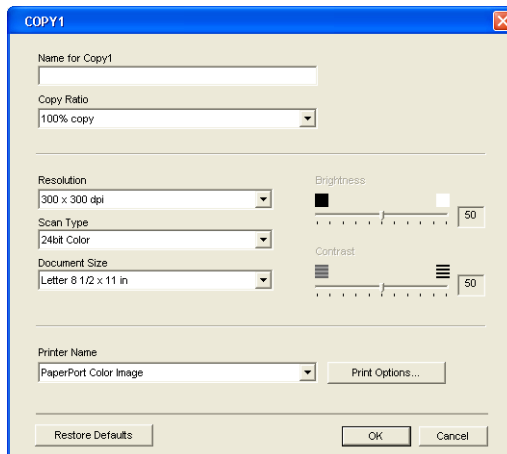

You can enter up to 30 characters in the **Name for Copy** field and select **Copy Ratio**.

In the **Scan setting** field you can select the **Resolution**, **Scan Type**, **Document Size**, **Brightness** and **Contrast** settings to be used.



Before finishing the **Copy** button configuration, you must set the **Printer Name**. Then click the **Print options** button to display the printer driver settings.

 The **Print options** screen will vary depending upon which model printer you have selected.

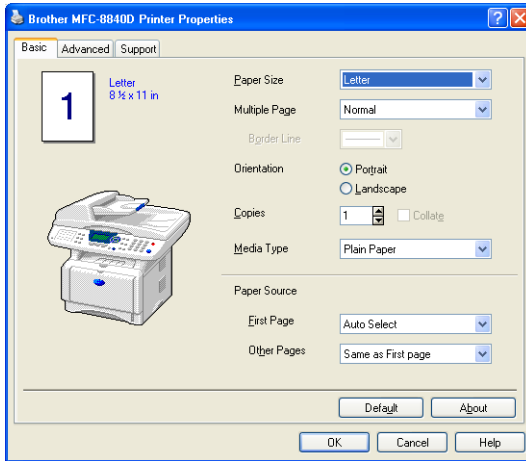

In the printer driver settings window you can choose advanced settings for printing.

 You must configure each of the copy buttons before they can be used.

# PC-FAX (For MFC-8440, MFC-8640D, MFC-8840D and MFC-8840DN only)

This section allows you to easily open the software for sending or receiving a PC-FAX or edit the address book by clicking the appropriate button.

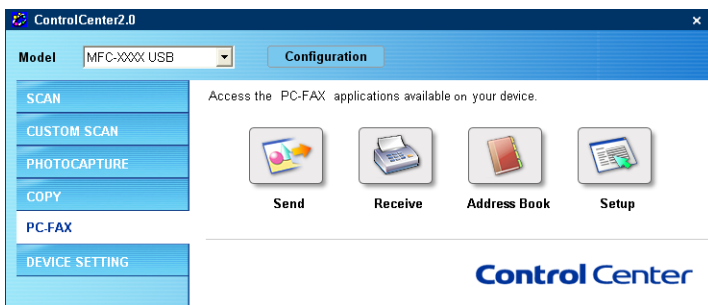

## Send

The **Send** button allows you to scan a document and automatically send the image as a fax from the PC using the Brother PC-FAX software. (See *PC-FAX sending* on page 6-1.)

To change the **Send** settings, right-click on the button to open the configuration window. You can change **Resolution**, **Scan Type**, **Document Size**, **Brightness** and **Contrast** settings.

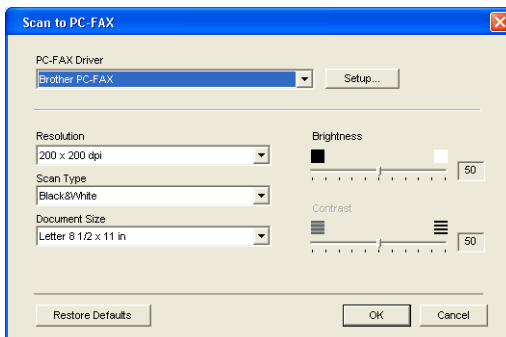

# Receive / View Received

The **Receive** button allows you to start receiving PC-FAXes to your computer. By clicking this button, the PC-FAX receiving software is activated and starts receiving fax data. (See *Running PC-FAX Receiving* on page 6-19.)



When the machine is connected to the network, you cannot use this function.

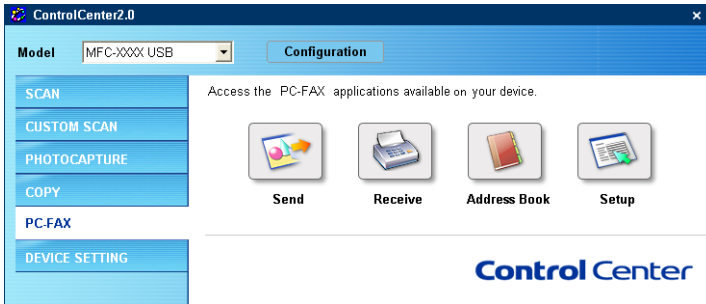

When the PC-FAX receiving software is running, the **View Received** button. Clicking this button will open the viewer application. (PaperPort® 9.0SE)

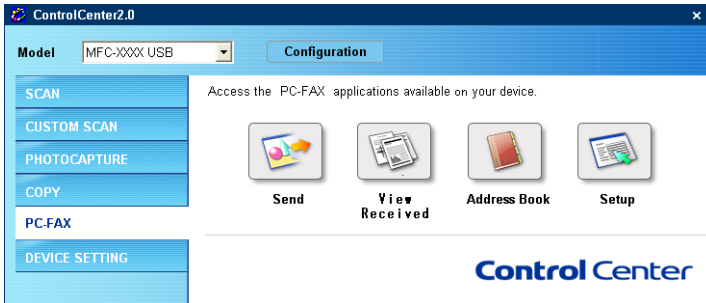

## Address Book

---

The **Address Book** button allows you to configure, add, amend or delete contacts from your address book. By clicking the button, the address book window will open for editing. (See *Brother Address Book* on page 6-7.)

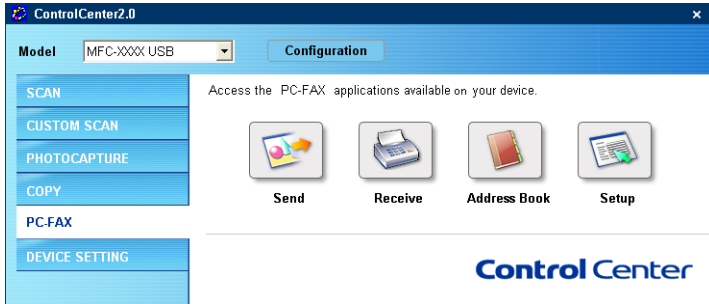

## Setup

---

By clicking the **Setup** button, you can configure the user settings used by the PC-FAX application. (See *Setting up user information* on page 6-2.)

# DEVICE SETTING (For MFC-8440, MFC-8640D, MFC-8840D and MFC-8840DN only)

In this section you can configure the machine setting by clicking the button.



When the machine is connected to a network, you cannot use this function.

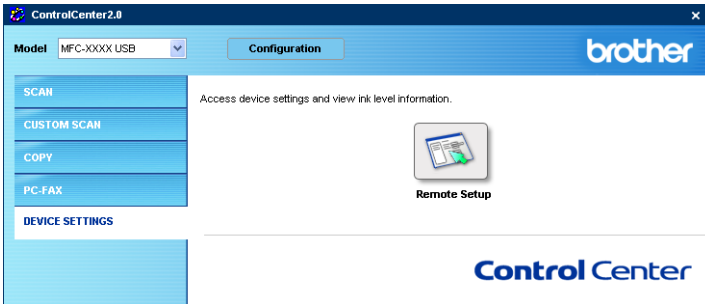

## Remote Setup

The **Remote Setup** button allows you to open the Remote Setup Program window with which you can configure the machine setting menus.

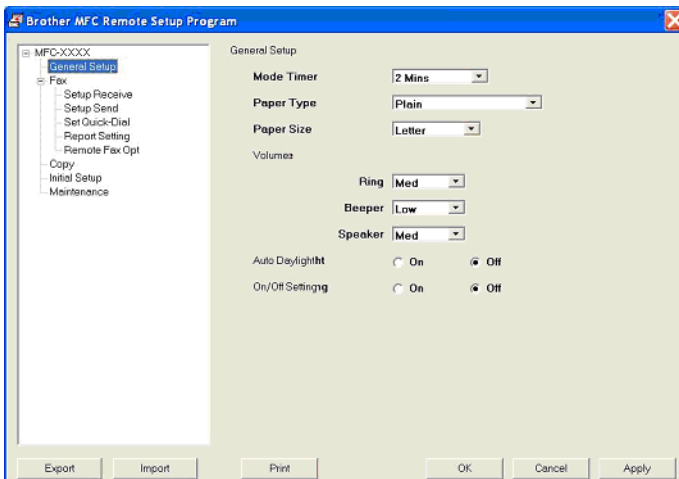

# 5

## Using MFC Remote Setup

(For Windows®)

(For MFC-8440, MFC-8640D, MFC-8840D and MFC-8840DN only)

### MFC Remote Setup

The MFC Remote Setup application lets you quickly and easily set up your MFC directly from your PC screen. When you access this application, the settings on your MFC will be downloaded to your PC and displayed on your computer screen. If you change the settings, you can upload them directly to the MFC.



You can't use the MFC Remote Setup application if your MFC is only connected to a Network with the optional Network LAN board (NC-9100h). (See Web Based Management in the NC-9100h Network User's Guide.)

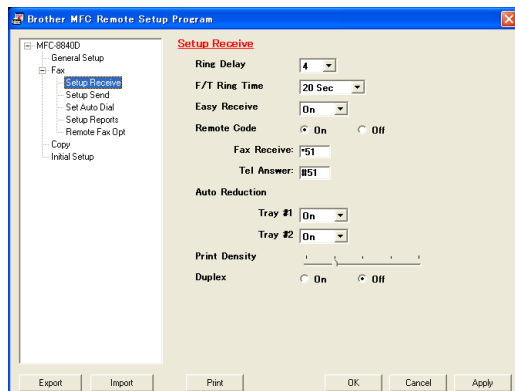

#### OK button

When you click **OK**, the process of uploading the data to the MFC begins. The MFC Remote Setup program is closed if an error message is displayed, enter the correct data again and then click **OK**.

#### Cancel button

The **Cancel** button clears your changes and exits the MFC Remote Setup application without uploading any data to the MFC.

## Apply button

The **Apply** button uploads the data to the MFC, but stays in the Remote Setup application so you can make more changes.

## Print button

The **Print** button prints the selected items on the MFC. You cannot print the MFC Remote Setup changes until you click the **Apply** button to upload the new data to the MFC. Then you can click the **Print** button to get an up-to-date printout.

## Export button

Click the **Export** button to save your current settings to a file.

## Import button

Click the **Import** button to read the settings from your saved file into the MFC Remote Setup screen.



You can use the **Export** and **Import** buttons to save and use several sets of settings for your MFC.

# 6

# Using Brother PC-FAX software

(For Windows®)

(For MFC-8440, MFC-8640D, MFC-8840D and MFC-8840DN only)

## PC-FAX sending

The Brother PC-FAX feature allows you to use your PC to send any application or document file as a standard fax. You can create a file in any application on your PC, and then send it as a PC-FAX. You can even attach a cover page note. All you have to do is set up the receiving parties as Members or Groups in your PC-FAX Address Book or simply enter the destination address or fax number into the User interface. You can use the Address Book Search feature to quickly find members to send your fax to.



- PC-FAX is available in Black & White only.
- If you are using Windows® XP, Windows NT® 4.0 or Windows® 2000 Professional, we recommend that you are logged on with administrator rights.
- Please check Brother Solutions Center for the latest updates available for Brother PC-FAX. Visit <http://solutions.brother.com/>



## Setting up user information

---



You can access the User Information from the FAX Sending dialog box by clicking .

(See *Sending a file as a PC-FAX using the Facsimile style user interface* on page 6-16.)

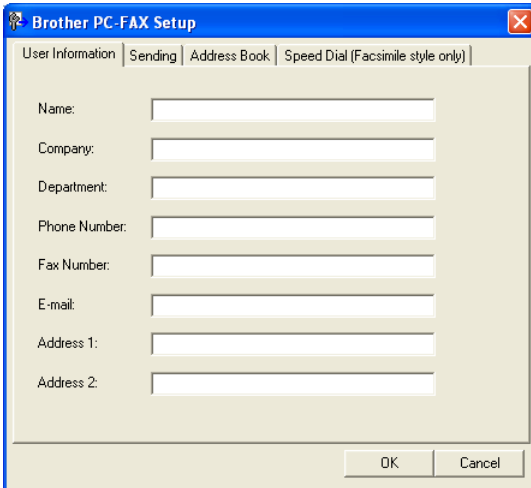

The screenshot shows the 'Brother PC-FAX Setup' dialog box with the 'User Information' tab selected. The dialog box has a blue title bar and a light beige background. It contains several text input fields for user information, each with a label to its left: 'Name:', 'Company:', 'Department:', 'Phone Number:', 'Fax Number:', 'E-mail:', 'Address 1:', and 'Address 2:'. At the bottom right, there are two buttons: 'OK' and 'Cancel'.

- 1 From the **Start** menu, select **All Programs, Brother, MFL-Pro Suite MFC-XXXX** (Where XXXX is your model name), and then select **PC-FAX Setup**.  
The **Brother PC-FAX Setup** dialog box will appear:
- 2 You must enter this information to create the Fax Header and Cover Page.
- 3 Click **OK** to save the **User Information**.

## Sending setup

---

From the **Brother PC-FAX Setup** dialog box, click the **Sending** tab to display the screen below.

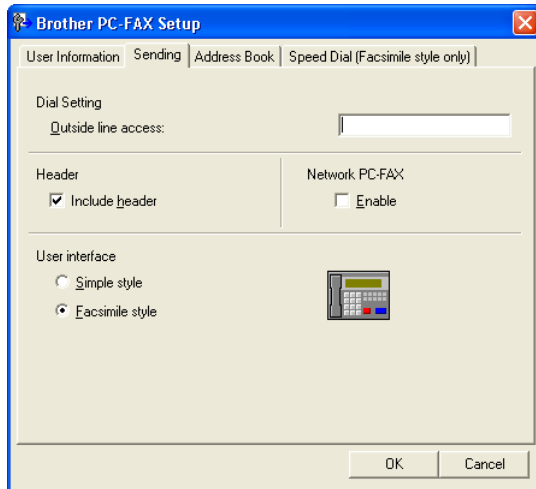

The user has the choice of two user interfaces: Simple style or Facsimile style. To change the user interface select the interface setting you want: Simple style or Facsimile style. (See *User interface* on page 6-4.)

## Outside line access

---

If you need to enter a number to access an outside line, enter it here. This is sometimes required by a local PBX telephone system (for example, if you must dial 9, to get an outside line in your office).

## Include header

---

To add header information to the top of the fax pages you send, check the Include header box.

# User interface

---

In the **Sending** tab, select the user interface you wish to use. You can choose the **Simple Style** or the **Facsimile Style**.

## Simple style

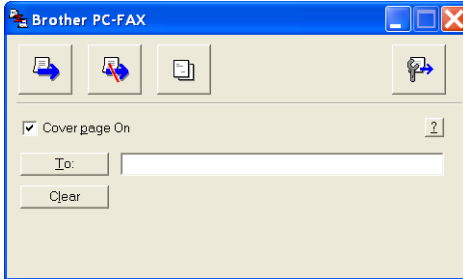

## Facsimile style



# Address Book

If Outlook® Express is installed on your PC, you can select which address book to use for PC-FAX sending, Brother Address Book or Outlook® Express from the **Address Book** tab. (not available for Windows NT® 4.0)

For the Address book file, you must enter the path and file name of the database file which contains the address book information.

—OR—

Use the **Browse** button to find the database to select.

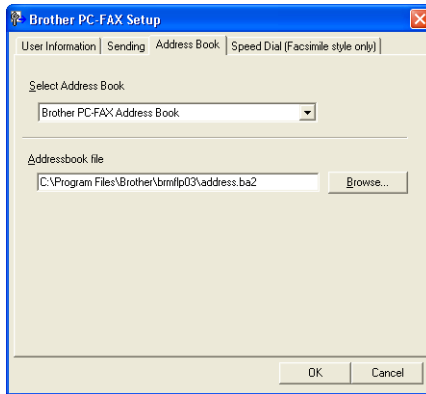

If you select Outlook® Express, you can use the Outlook® Express Address book when clicking the Address Book button on the sending window.

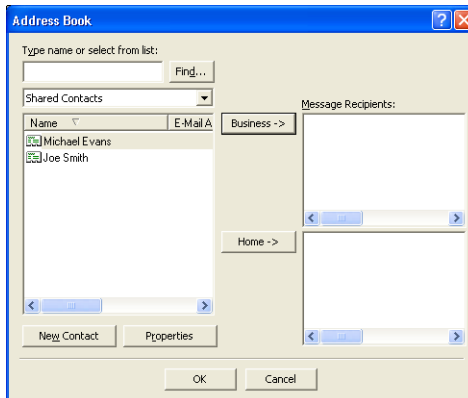

# Speed-Dial setup

From the **Brother PC-FAX Setup** dialog box, click the **Speed-Dial** tab. (To use this feature, you must select the **Facsimile Style** user interface.)

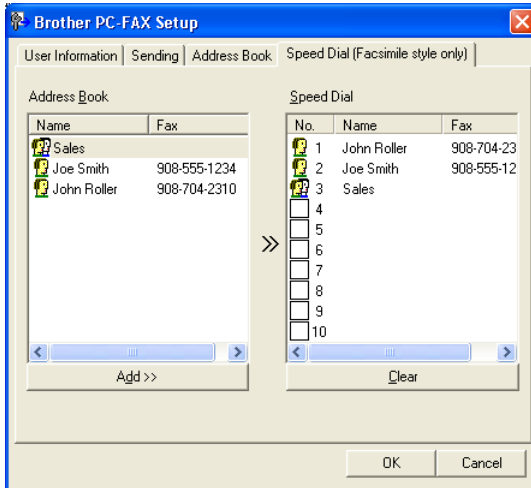

You can register a Member or Group on each of the ten Speed-Dial buttons.

## To register an address in a Speed-Dial button:

- 1 Click the Speed-Dial button you want to program.
- 2 Click the Member or Group you want to store on the Speed-Dial button.
- 3 Click **Add >>** to save it.

## To clear a Speed-Dial button:

- 1 Click the Speed-Dial button you want to clear.
- 2 Click **Clear** to erase it.

# Brother Address Book

---

From the **Start** menu, select **Programs, Brother, MFL-Pro Suite MFC-XXXX** (Where XXXX is your model name), and then click **PC-FAX Address Book**.

The **Brother Address Book** dialog box will appear:

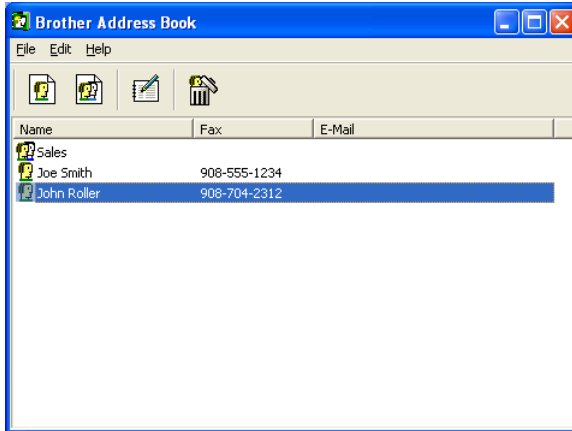

# Setting up a Member in the Address Book

In the **Brother Address Book** dialog box you can add, edit and delete stored information of Members and Groups.

- 1 In the Address Book dialog box, click the  icon to add a Member.

The **Brother Address Book Member Setup** dialog box will appear:

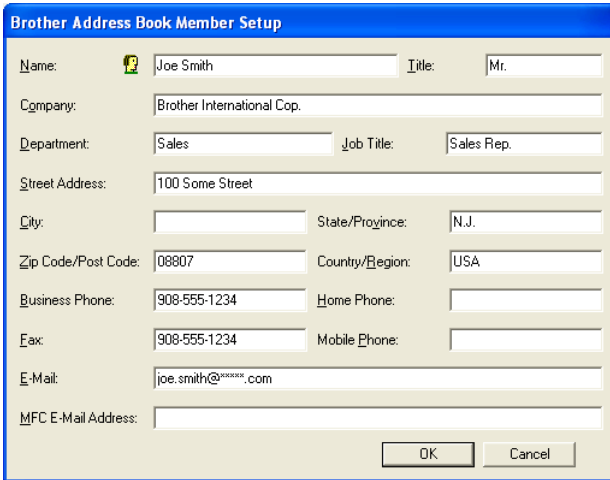

**Brother Address Book Member Setup**

Name:  Joe Smith Title: Mr.

Company: Brother International Cop.

Department: Sales Job Title: Sales Rep.

Street Address: 100 Some Street

City: State/Province: N.J.

Zip Code/Post Code: 08807 Country/Region: USA

Business Phone: 908-555-1234 Home Phone:

Fax: 908-555-1234 Mobile Phone:

E-Mail: joe.smith@\*\*\*\*\*.com

MFC E-Mail Address:

OK Cancel

- 2 In the Member Setup dialog box, type the Member's information. **Name** is a required field. Click **OK** to save the information.

## Setting up a Group for Broadcasting

If you often send the same PC-FAX to several recipients, you can combine them in to a Group.

- 1 In the **Brother Address Book** dialog box, click the  icon to create a Group.

The **Brother Address Book Group Setup** dialog box appears:

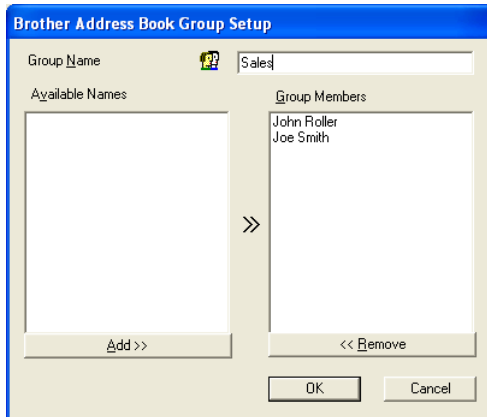

- 2 Type the name of the new Group in the **Group Name** field.
- 3 In the **Available Names** box, select each Member to be included in the Group, and then click **Add >>**.  
Members you add to the Group will be added to the **Group Members** box.
- 4 After all the members you want have been added, click **OK**.



## Editing Member information

---

- 1 Select the Member or Group you want to edit.
- 2 Click the edit  icon.
- 3 Change the Member or Group information.
- 4 Click **OK** to save your changes.

## Deleting a Member or Group

---

- 1 Select the Member or Group you want to delete.
- 2 Click the delete  icon.
- 3 When the **Confirm Item Delete** dialog box appears, click **OK**.

## Exporting the Address Book

---

You can export the whole Address Book to an ASCII text file (\*.csv). Or if you wish, you can select and create a Vcard that will be attached to that Member's outgoing E-mail. (A Vcard is an electronic business card that contains the sender's contact information.)

### To export the whole current Address book:



If you are creating a Vcard, you must first select the member.

If you select Vcard in Step 1, **Save as type:** will be **Vcard (\*.vcf)**.

- 1 From the Address Book select **File**, point to **Export**, and then click **Text**.

—OR—

Click **Vcard** and go to Step 5.

- 2 From the **Available Items** column, select the data fields you wish to Export and then click **Add >>**.



Select the items in the order you want them listed.

- 3 If you are exporting to an ASCII file, select the **Divide Character - Tab** or **Comma**. This selects between a **Tab** or **Comma** to separate the data fields.
- 4 Select **OK** to save the data.

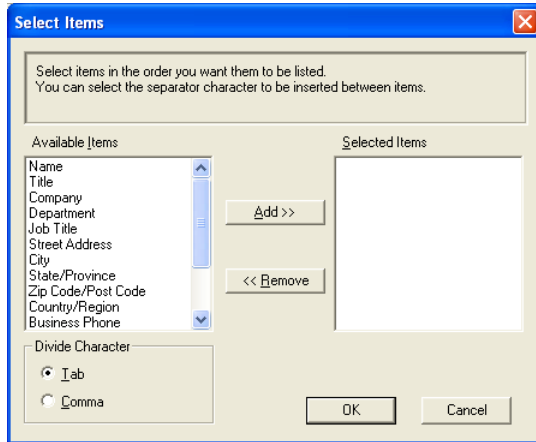

- 5 Type the name of the file, and then select **Save**.

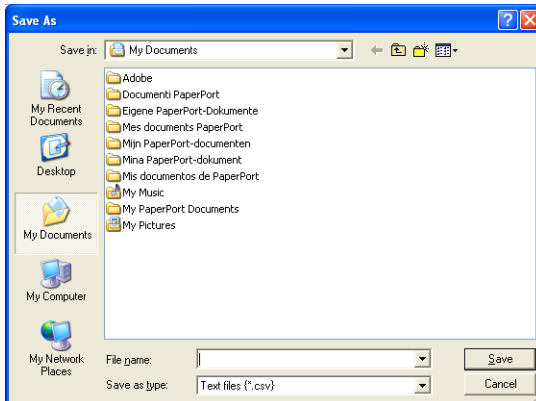

# Importing to the Address Book

You can import ASCII text files (\*.csv) or Vcards (electronic business cards) into your Address Book.

## To import an ASCII text file:

- 1 From the Address Book select **File**, point to **Import**, and then click **Text**.

—OR—

Click **Vcard** and go to Step 5.

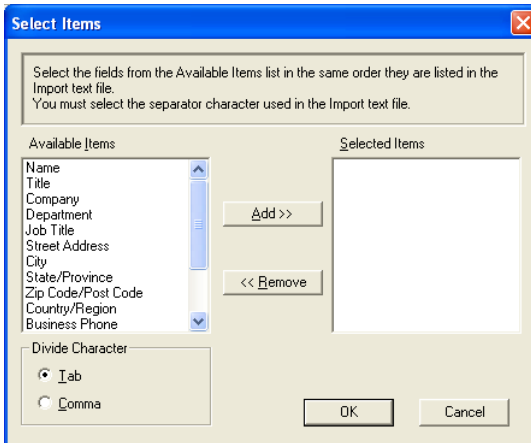

- 2 From the **Available Items** column select the data fields you want to import, and click **Add >>**.



From the Available Items list select the fields in the same order they are listed in the Import text file.

- 3 Select the **Divide Character - Tab** or **Comma** based on the file format you are importing.
- 4 To import the data, click **OK**.

5 Type the name of the file, and then select **Open**.

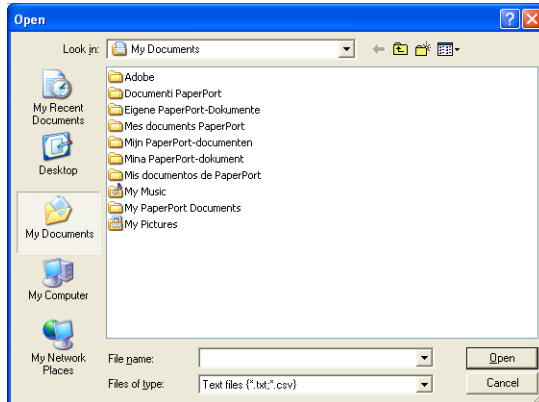

 If you selected a text file in Step 1, the **Files of type:** will be **Text file (\*.csv)**.

# Setting up a Cover Page

From the PC-FAX dialog box, click  to access the PC-Fax Cover page setup screen.

The **Brother PC-FAX Cover Page Setup** dialog box will appear:

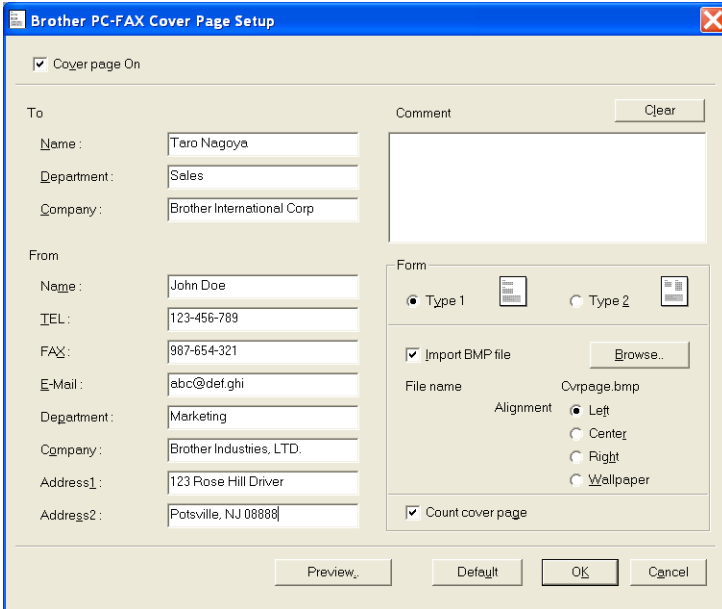

## Entering Cover Page Information

---



If you are sending a fax to more than one recipient, the recipient information will not be printed on the Cover Page.

### **To**

### **From**

### **Comment**

Type the comment you want to add to the cover page.

### **Form**

Select the cover page format you want to use.

### **Import BMP file**

You can insert a bitmap file, such as your company logo, in the cover page.

Use the browse button to select the BMP file, and then select the alignment style.

### **Count cover page**

When the Count Cover Page box is checked, the Cover Page will be included in the page numbering. When this box is not checked, the Cover Page will not be included.

# Sending a file as a PC-FAX using the Facsimile style user interface

- 1 Create a file in Word, Excel, Paint, Draw or any other application on your PC.
- 2 From the **File** menu, select **Print**.  
The **Print** dialog box will appear:

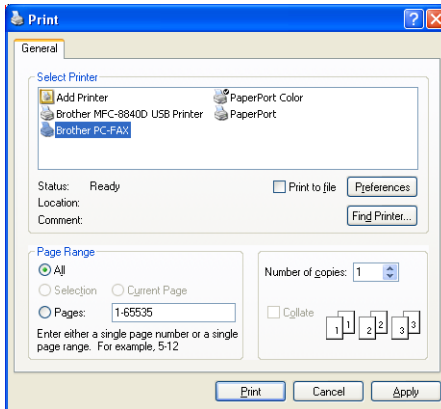



- 3 Select **Brother PC-FAX** as your printer, and then click **Print**.  
The Facsimile style user interface will appear, if it does not check the user interface selection setting as detailed on page 6-3.



- 4 Enter the fax number using any of the following methods:
  - Using the dial pad enter the number.
  - Click any of the 10 **Speed-Dial** buttons.
  - Click the **Address Book** button, and then select a Member or Group from the Address Book.

 If you make a mistake, click **Clear** to delete all the entries.

- 5 To include a Cover Page, click  **Cover Page On**, and then click the Cover Page  icon to enter or edit the Cover Page information.

- 6 Click **Start** to send the fax.

 If you want to cancel the fax, click **Stop**.

## Redial

If you want to redial a number, click **Redial** to scroll through the last five fax numbers, and then click **Start**.

## Sending a file as a PC-FAX using the Simple style user interface

---

- 1 Create a file in Word, Excel, Paint, Draw or any other application on your PC.
- 2 From the **File** menu, select **Print**.  
The **Print** dialog box will appear:

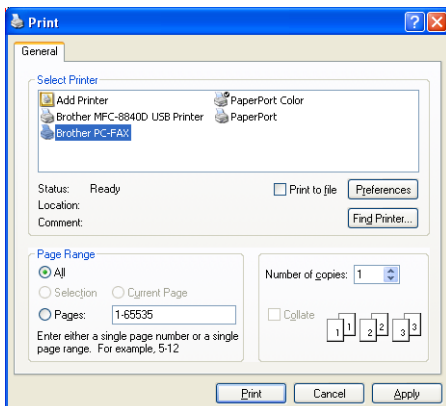



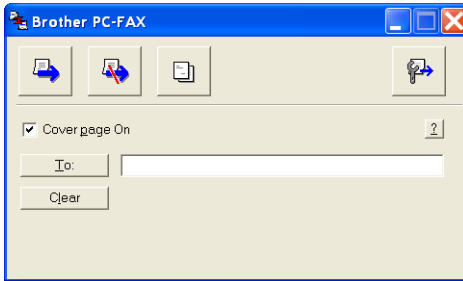

- 3** Select **Brother PC-FAX** as your printer, and then click **Print**.  
The Simple style user interface will appear; if it does not check the user interface selection setting as detailed on page 6-3.



- 4** In the **To:** field, type the fax number of the recipient. You can also use the Address Book to select destination fax numbers by clicking the **To:** button. If you made a mistake entering a number, click the **Clear** button to delete all the entries.
- 5** To send a Cover Page and note, click the **Cover Page On** check box.



You can also click the  icon to create or edit a cover page.

- 6** When you are ready to send your fax, click the Send  icon.
- 7** If you want to cancel the fax, click the Cancel  icon.

# Setting up PC-FAX receiving

The PC-FAX Receive function will automatically upload incoming faxes received by your machine to your PC for viewing, printing or deleting.



PC-FAX receiving is only available when using the USB and parallel connection, not the LAN connection.

## Running PC-FAX Receiving

From the **Start** menu, select **All Programs, Brother, MFL-Pro Suite MFC-XXXX** (Where XXXX is your model name), and then select '**PC-FAX Receiving**'.

The PC-FAX  icon will appear on your PC Task bar for this Windows® session.

## Setting up your PC

- 1 Right-click the PC-FAX  icon on your PC Task Bar, and then click **PC-Fax RX Setup**.
- 2 The PC-Fax RX Setup dialog box will appear:

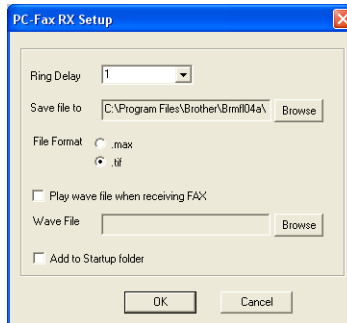

- 3 In **Ring Delay**, select the number of rings before you want your PC to answer incoming calls.
- 4 In **Save file to**, use the Browse button if you want to change the path where PC-FAX files will be saved.
- 5 In **File Format**, select **.tif** or **.max** for the format the received document will be saved in. The default format is **.tif**.
- 6 If you want to, you can check the **Play wave file when receiving FAX** check box, and then enter the path of the wave file.
- 7 To load PC FAX receiving automatically when you start up Windows®, select the **Add to Startup folder** check box.

## Viewing new PC-FAX messages

---

Each time you start to receive a PC-FAX, the icon will flash  blue and red. Once the fax has been received the icon will remain red. The red icon will change to green once the received fax has been viewed.

- 1 Run PaperPort®.
- 2 Open the Fax Received folder.
- 3 Double-click any of the new faxes to open and view them.

 The title of your unread PC message will be the date and time until you assign a file name.  
For example “Fax 2-20-2002 16:40:21.tif”

# 7 Using your machine with a Macintosh®

## Setting up your USB-equipped Apple® Macintosh®



- Before you can connect the machine to your Macintosh®, you must buy a USB cable that is not longer than 6 feet (2 metres).

**Do not connect the machine to a USB port on a keyboard or a non-powered USB hub.**

- Some descriptions in this chapter are based on the MFC-8840D. These descriptions also apply to the MFC-8440, MFC-8640D, MFC-8840DN, DCP-8040 and DCP-8045D.
- The screens shown in this chapter are from MFC-8840D.

The features supported by the machine will depend on the operating system you are using. The chart below shows which features are supported.

Feature	Mac OS®		Mac OS® X	
	8.6	9.X	10.1	10.2.1 or greater*2
Printing	Yes	Yes	Yes	Yes
Scanning (TWAIN)	Yes	Yes	No	Yes
ControlCenter2.0*1	No	No	No	Yes
PC-FAX sending	Yes	Yes	Yes	Yes
Remote Setup	No	No	Yes	Yes

\*1 For the details of ControlCenter2.0, see *Using ControlCenter2.0 (For Mac OS® X 10.2.1 or greater)* on page 7-29.

\*2 For Mac OS® X 10.2 users, please upgrade to Mac OS® X 10.2.1 or greater. (For the latest information for Mac OS® X, please visit at: <http://solutions.brother.com>)

# Using the Brother printer driver with your Apple® Macintosh® (Mac OS® 8.6 - 9.2)

To select a Printer:

- 1 Open the **Chooser** from the Apple menu.

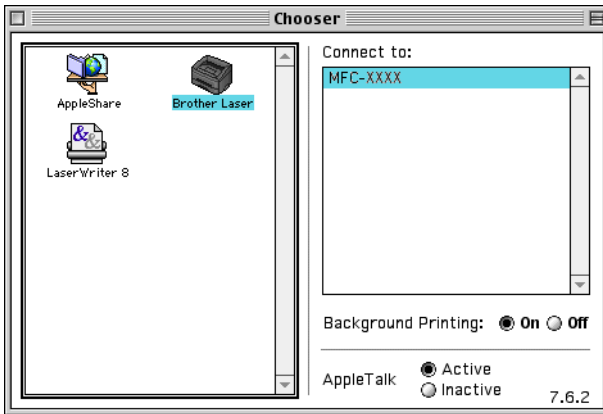

- 2 Click the **Brother Laser** icon. On the right side of the **Chooser** window, click the printer you want to print to. Close the **Chooser**.

## To print a document:

- 1 From the application software such as Presto!® PageManager®, click **File** menu and select **Page Setup**. You can change the settings for **Paper Size**, **Orientation**, and **Scaling**, and then click **OK**.

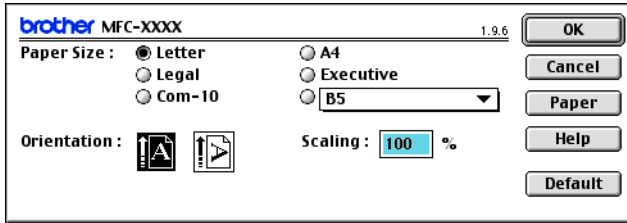

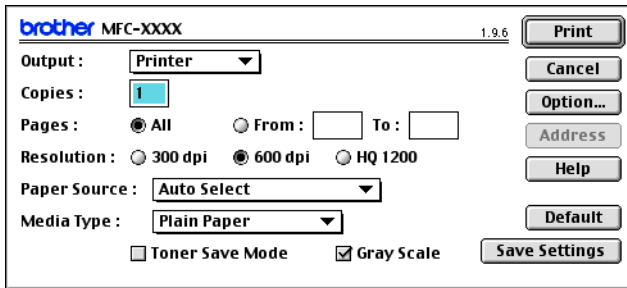

- 2 From application software such as Presto!® PageManager®, click **File** menu and select **Print**. Click **Print** to start printing.

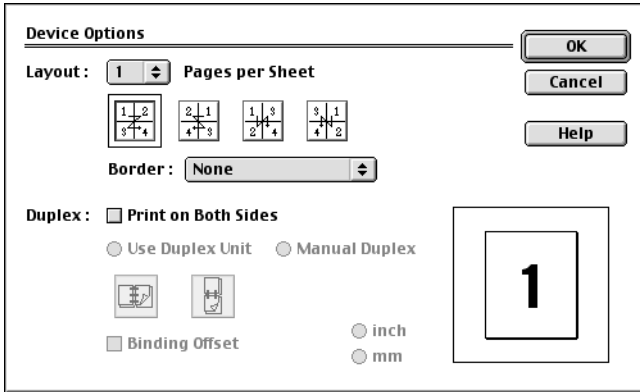

If you want to change **Copies**, **Pages**, **Resolution**, **Paper Source** and **Media Type**, select your settings before clicking **Print**.

Device Options allows you to select **Duplex**.



 Automatic Duplex is only available with the MFC-8640D, MFC-8840D, MFC-8840DN and DCP-8045D.

# Using the Brother Printer Driver with Your Apple® Macintosh® (Mac OS® X)

## Choosing page setup options

- 1 From application software such as Presto!® PageManager®, click the **File** menu and select **Page Setup**. Make sure your machine is selected in the **Format for** pop-up menu. You can change the settings for **Paper Size**, **Orientation** and **Scaling**, then click **OK**.

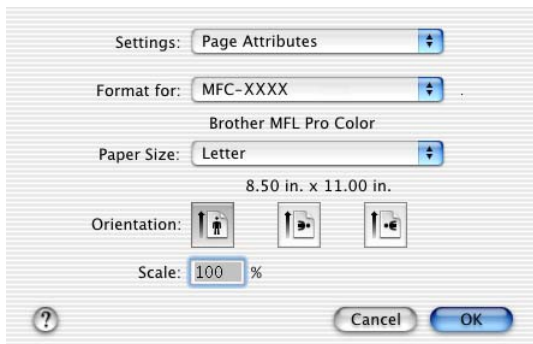

- 2 From application software such as Presto!® PageManager®, click **File** menu and select **Print**. Click **Print** to start printing.

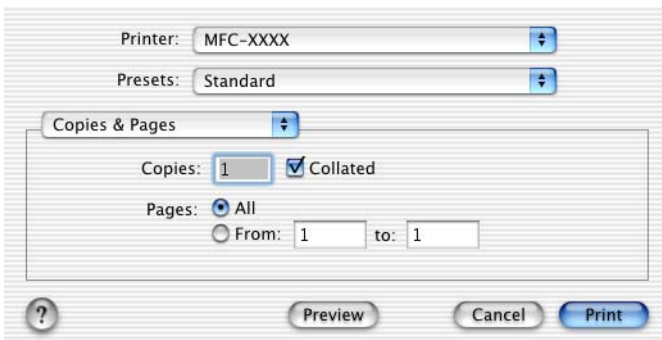



## Specific settings

Set the **Media Type**, **Resolution**, **Toner Save**, and other settings. Press **Copies & Pages** to select settings you want to change.

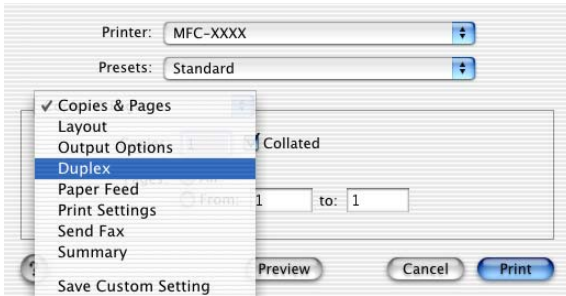

### Duplex

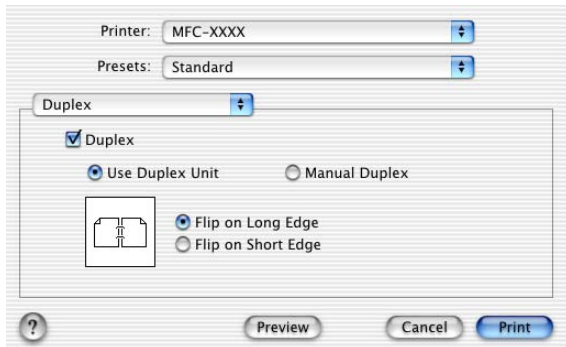

Automatic Duplex is only available with the MFC-8640D, MFC-8840D, MFC-8840DN and DCP-8045D.

### Printer settings

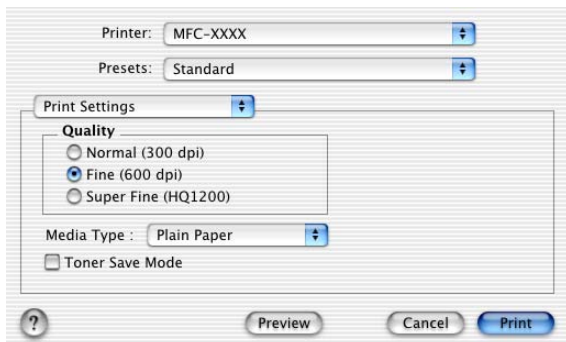

# Using the PS driver with your Apple® Macintosh®



To use the PS driver on a Network, see the NC-9100h Network User's Guide on CD-ROM.



To use the PS driver with a USB cable, you need to set the Emulation to **BR-Script3** (For MFC-8440, MFC-8640D MFC-8840D and MFC-8840DN, **Menu, 4, 1.** DCP-8040 and DCP-8045D, **Menu, 3, 1.**) before connecting the USB cable. (See *Setting the Emulation Selection* on page 1-17.)



The PS driver does not support the following functions:

- HQ 1200
- Secure Print
- PC-Fax Sending (for MFC models only)

## For Mac OS® 8.6 to 9.2 users

### 1 For Mac OS® 8.6 to 9.04 Users:

Open the **Apple Extras** folder. Open the **Apple LaserWriter Software** folder.

### For Mac OS® 9.1 to 9.2 Users:

Open the **Applications** (Mac OS® 9) folder. Open the **Utilities** folder\*.

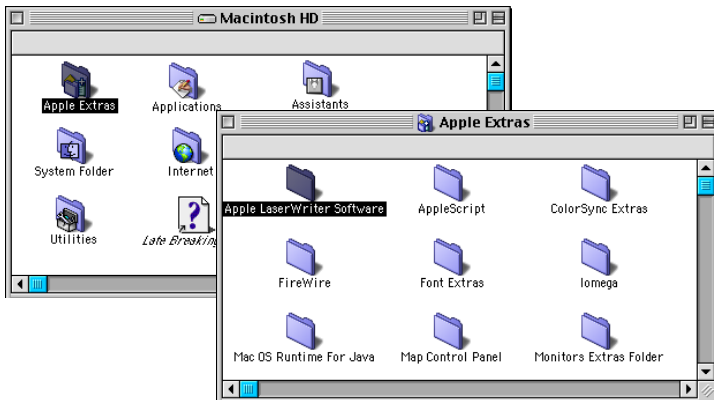

\* The screens are based on Mac OS® 9.04.

2 Open the **Desktop Printer Utility** icon.

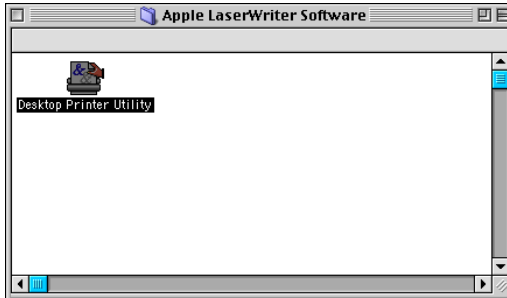

3 Select **Printer (USB)**, and then click **OK**.

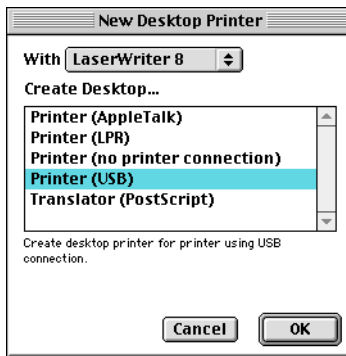

4 Click **Change...** in the PostScript™ Printer Description (PPD) file.

Select your machine, and then click **Select**.

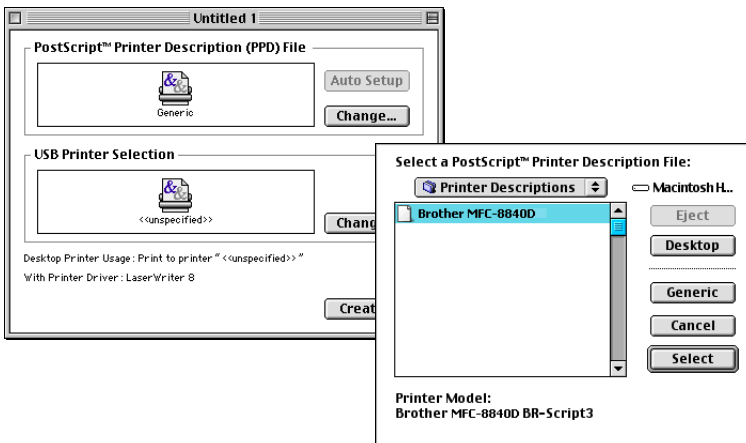

- 5 Click **Change...** in the **USB Printer Selection**.  
Select your machine, and then click **OK**.

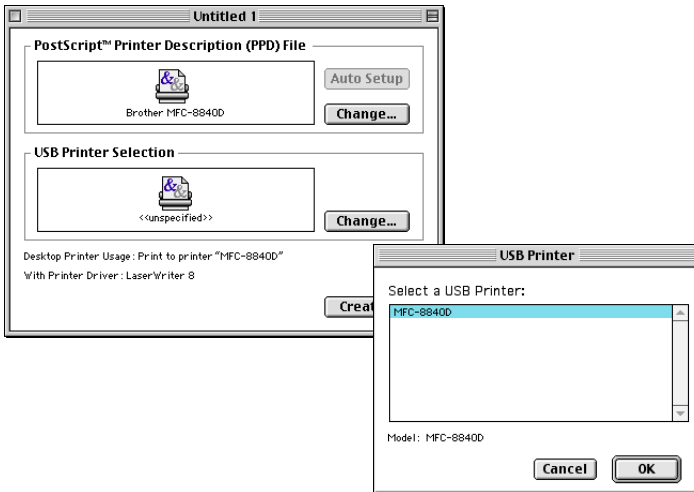

- 6 Click **Create...**

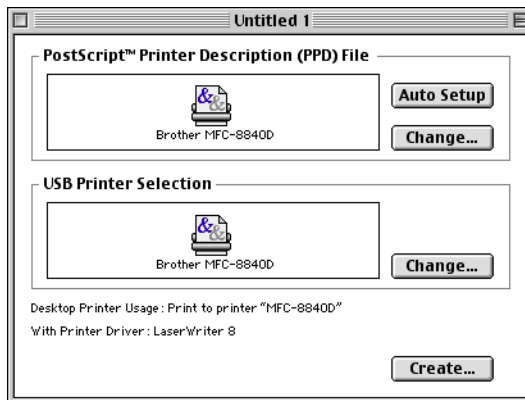

7 Enter your machine name, and then click **Save**.

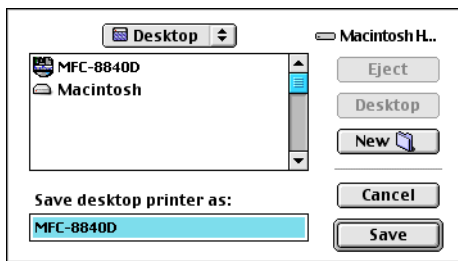

8 Select **Quit** from the **File** menu.



9 Click the **MFC-8840D** icon on the Desktop.



10 Select **Set Default Printer** from the **Printing** menu.

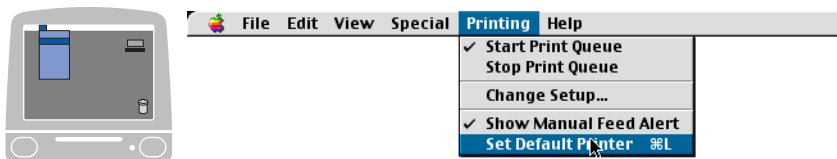

## For Mac OS® X users

You need to install the PS driver using the following instructions.

- If you use a USB cable and your Macintosh® is “Mac OS® X”, only one printer driver for a machine can be registered in Print Center.
- If a Brother Native Driver (MFC-XXX) is already listed in Printer list, you will need to delete it and then install the PS driver.
- To use the PS driver with a USB cable, you need to set the Emulation to BR-Script3 (For MFC-8440, MFC-8640D, MFC-8840D and MFC-8840DN, **Menu, 4, 1.** DCP-8040 and DCP-8045D, **Menu, 3, 1.**) before connecting the USB cable. (See *Setting the Emulation Selection* on page 1-17.)

### 1 Select **Applications** from the **Go** menu.

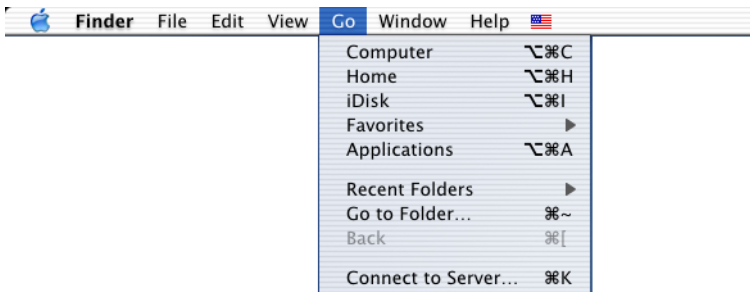

### 2 Open the **Utilities** folder.



3 Open the **Print Center** icon.



4 Click **Add Printer...**

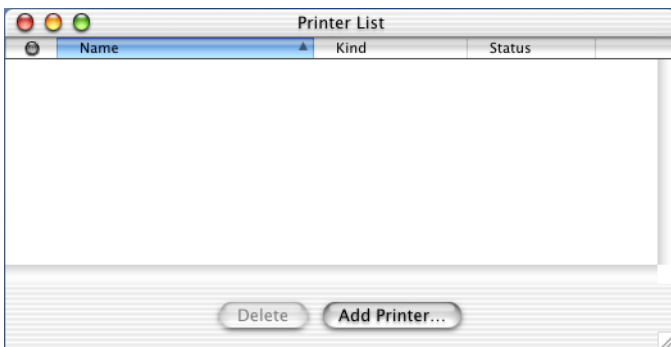

5 Select **USB**.

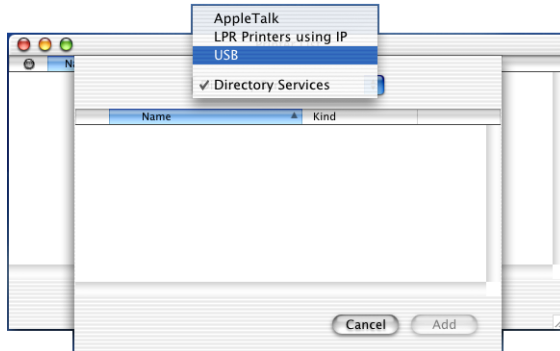

6 Select your machine, and then click **Add**.

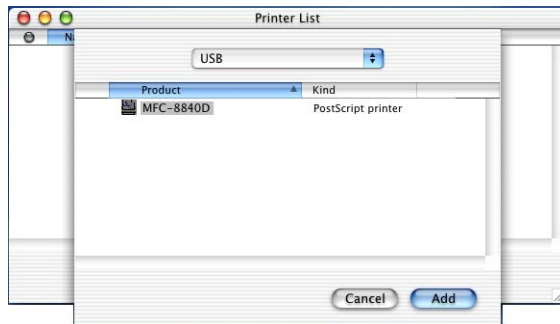

7 Select **Quit Print Center** from the **Print Center** menu.

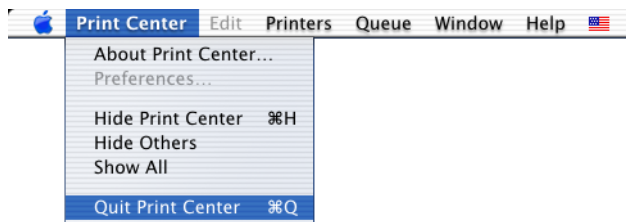
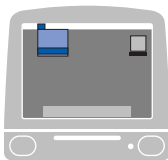



# Sending a fax from your Macintosh<sup>®</sup> application (For MFC-8440, MFC-8640D, MFC-8840D and MFC-8840DN only)

## For Mac OS<sup>®</sup> 8.6 - 9.2 users

You can send a fax directly from a Macintosh<sup>®</sup> application by doing the following:



The PS driver does not support the following function.

- 1 Create a document in a Macintosh application.
- 2 To send a fax, select **Print** from the **File** menu.  
The Printer dialog box will appear:

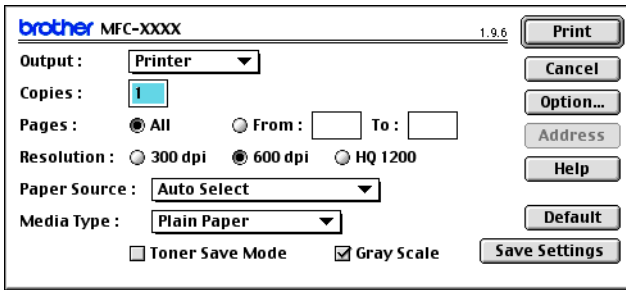

When *Printer* is selected, the top button shows **Print** and the **Address** button is grayed.

- 3 From the **Output** pull-down menu, select *Facsimile*.

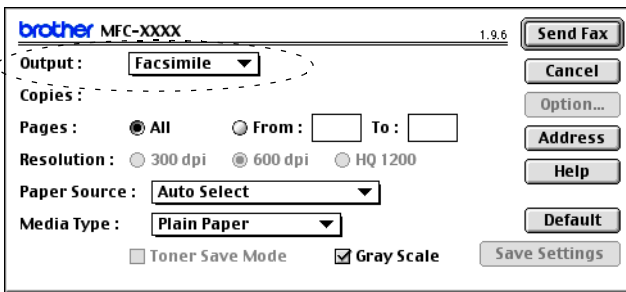

When *Facsimile* is selected, the top button changes to **Send Fax** and the **Address** button will be available.

#### 4 Click **Send Fax**.

The **Send Fax** dialog box appears:

The **Send Fax** dialog box contains the following elements:

- Input Fax Number:** A text field for entering a fax number.
- Stored Fax Numbers:** A list box containing the following entries:

Barbie	908-477-8888
Bob	908-869-8888
Frank	908-236-8888
Tony	908-569-8888
- Destination Fax Numbers:** An empty list box for selecting numbers to fax to.
- Navigation:** '>>' and '<<' buttons between the list boxes.
- Buttons:** 'New', 'Group', 'Edit', 'Delete', 'Save', 'Cancel', and 'Send Fax' buttons at the bottom.

The **Send Fax** dialog box has two list boxes. The left box shows all the previously **Stored Fax Numbers** and the right box shows the **Destination Fax Numbers** as you select them.

5 To address the fax, type a fax number in the **Input Fax Number** box.

6 When you are finished addressing your fax, click **Send Fax**.



- To select and only send certain pages of the document, click **OK** to go to the Print dialog box.
- If you click **Send Fax** without addressing your fax, the following error message will appear:

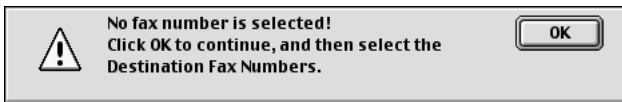

Click **OK** to go to the **Send Fax** dialog box.

## For Mac OS® X users

You can send a fax directly from a Macintosh® application by doing the following:

 The PS driver does not support the following function.

- 1 Create a document in a Macintosh application.
- 2 To send a fax, select **Print** from the **File** menu.

The Printer dialog box will appear:

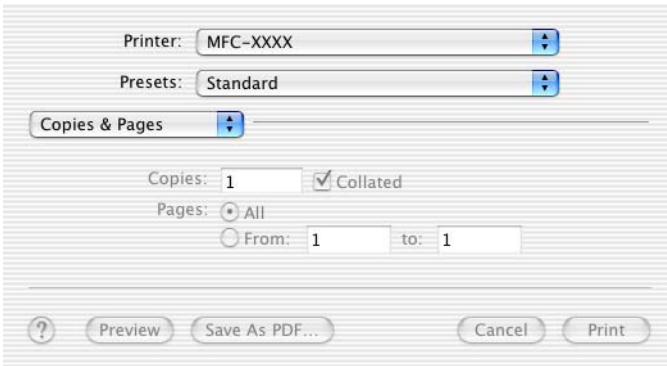

- 3 Select **Send Fax** from pull-down menu.

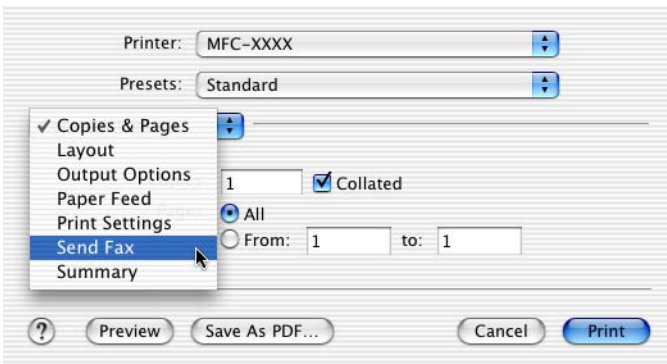

#### 4 Select **Facsimile** from the **Output** pull-down menu.

Printer: MFC-XXXX  
Presets: Standard

Send Fax

Output: Printer

Input Fax Number :  
[ ] Add

Stored Fax Numbers :  
work fax Address Book

Destination Fax Numbers :  
Name FAX#  
[ ]  
Delete

Preview Save As PDF... Cancel Print

Printer: MFC-XXXX  
Presets: Standard

Send Fax

Output: Facimile

Input Fax Number :  
[ ] Add

Stored Fax Numbers :  
work fax Address Book

Destination Fax Numbers :  
Name FAX#  
[ ]  
Delete

Preview Save As PDF... Cancel Print

#### 5 To address the fax, type a fax number in the **Input Fax Numbers** box, and then click **Print**.

 If you want to send a fax to more than one number, click **Add** after entering the first fax number. The destination fax numbers will be listed in the dialog box.

Printer: MFC-XXXX  
Presets: Standard

Send Fax

Output: Facimile

Input Fax Number :  
[ ] Add

Stored Fax Numbers :  
work fax Address Book

Destination Fax Numbers :  
Name FAX#  
Bob 123-456-0000  
[ ]  
Delete

Preview Save As PDF... Cancel Print

# Drag a vCard from the Mac OS® X Address Book application

- 1 Click **Address Book** button.
- 2 Drag a vCard from the Mac OS® X **Address Book** application to the **Destination Fax Numbers** field.

When you are finished addressing your fax, click **Print**.

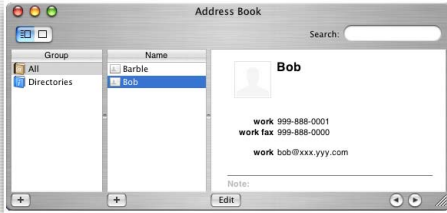
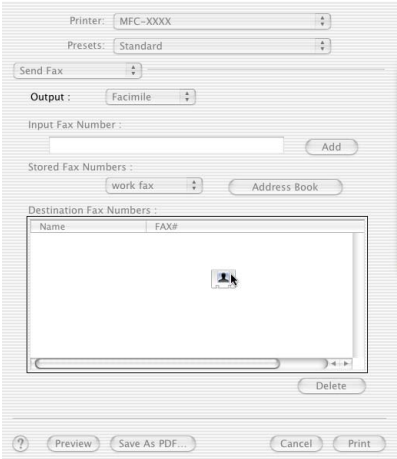



- The vCard used must contain a **work fax** or **home fax** number.
- When you choose **work fax** or **home fax** from the **Stored Fax Numbers** pull-down list, only the fax number stored in the Mac OS® X Address Book for the selected category will be used. If the fax number is stored in only one of the Mac OS® X Address Book categories, the number will be retrieved no matter which category you have selected (work or home).

# Using the Brother TWAIN scanner driver with your Macintosh®

The Brother software includes a TWAIN Scanner driver for Macintosh®. You can use this Macintosh® TWAIN Scanner driver with any applications that support the TWAIN specifications.

 Mac OS® X Scanning is supported in Mac OS® X 10.2.1 or greater.

## Accessing the scanner

Run your Macintosh® TWAIN-compliant application software. The first time you use the Brother TWAIN driver (MFL Pro/P2500), set it as the default by choosing **Select Source** (or the other menu name to select the device). Afterwards, for each document you scan choose **Acquire Image** or **Scan**. The scanner setup dialog box will appear.

-  ■ The screen shown in this section are from Mac OS® 9. The screen on your Macintosh® may vary depending on your Operating System.
- The method of selecting the source or choosing to scan may vary depending on the application software you are using.

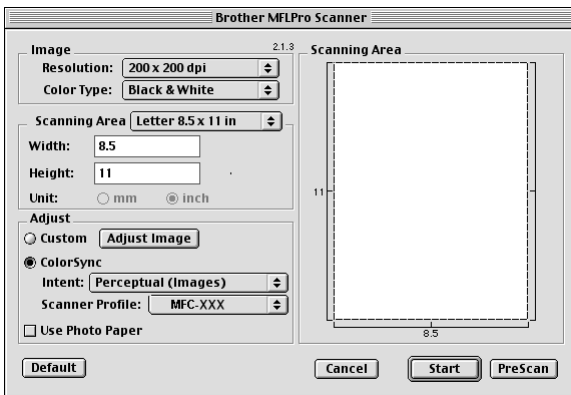

(Mac OS® 8.6–9.2)

# Scanning an image into your Macintosh®

---

You can scan a whole page

—OR—

scan a portion after prescanning the document.

## Scanning a whole page

- 1** Place the original face up in the ADF, or face down on the scanner glass.
- 2** Adjust the following settings, if needed, in the Scanner Setup dialog box:

**Resolution**

**Color Type**

**Scanning Area**

**Brightness**

**Contrast**

- 3** Click **Start**.  
When scanning has finished, the image will appear in your graphics application.



## PreScanning an image

---

PreScanning allows you to scan an image quickly at a low resolution. A thumbnail version will appear in the **Scanning Area**. This is only a preview of the image, so you can see how it will look. The **PreScan** button will allow you to crop unwanted areas from the images. When you are satisfied with the preview, click **Start** to scan the image.

- 1 Insert the original face up in the ADF, or face down on the scanner glass.
- 2 Click **PreScan**.  
The whole image will be scanned into your Macintosh® and will appear in the **Scanning Area** of the Scanner dialog box:
- 3 To scan a portion of the prescanned image, click and drag the mouse to crop it.

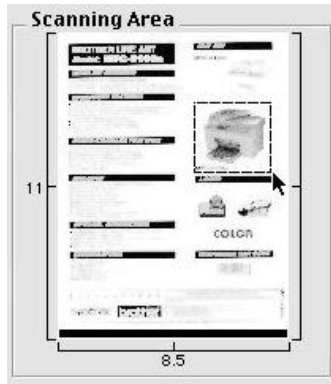

- 4 Insert original in the ADF, if you are using ADF.
- 5 Make your adjustments to the settings for **Resolution**, **Color Type** (Gray Scale), **Brightness**, **Contrast**, and **Size** in the Scanner Setup dialog box.
- 6 Click **Start**.  
This time only the cropped area of the original will appear in the **Scanning Area**.
- 7 You can refine the image in your editing software.

# Settings in the Scanner window

---

## Image

### Resolution

From the **Resolution** pop-up menu choose the scanning resolution. Higher resolutions use more memory and transfer time, but produce a finer scanned image.

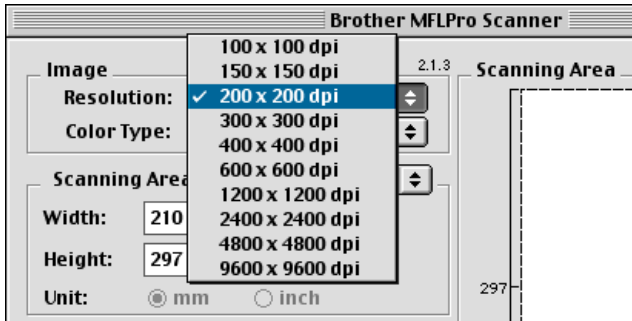

## Color Type

**Black & White**—Set the image type to *Black and White* for text or line art. For photographic images, set the image type to Gray (Error diffusion) or True Gray.

**Gray (Error Diffusion)**—is used for documents with photographic images or graphics. (Error Diffusion is a method for creating simulated gray images by placing black dots instead of the true gray dots in a specific matrix instead of true gray dots.)

**True Gray**—is used for documents with photographic images or graphics. This mode is more exact because it uses up to 256 shades of gray. It requires the most memory and takes the longest transfer time.

**Colors**—Choose either 8-bit Color, which scans up to 8-bit Color or 24-bit Color which scans up to 16.8 million colors. Although using 24-bit Color creates an image with the most accurate colors, the image file will be about three times larger than a file created with 8-bit Color.

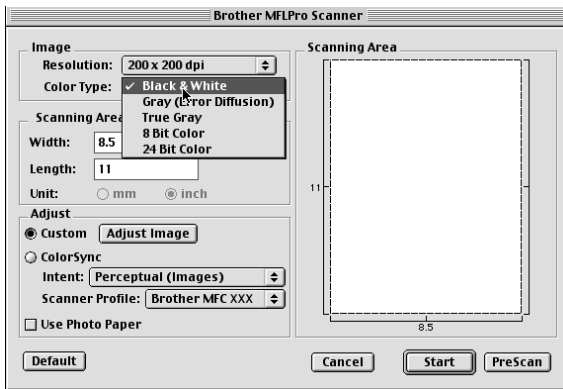

## Scanning Area

Set the **Size** to one of the following:

- *Letter (8.5 × 11 inches)*
- *A4 (210 × 297 mm)*
- *Legal (8 1/2 × 14 in.)*
- *A5 (148 × 210 mm)*
- *B5 (182 × 257 mm)*
- *Executive (7.25 × 10.5 inches)*
- *Business Card (90 × 60 mm)*
- *Custom (user adjustable it from 0.35 × 0.35 in. to 8.5 × 11.69 in. or 8.9 × 8.9 mm to 216 × 356 mm)*

After you choose a custom size, you can adjust the scanning area. Click and hold the mouse button as you drag the mouse to crop the image.

**Width:** Enter the width of the custom size.

**Height:** Enter the height of the custom size.

## Business Card Size

To scan business cards, select the Business Card size (90 × 60 mm) and place the business card at the center of scanner glass.

When you are scanning photographs or other images to use in a word processor or other graphics application, it is a good idea to try different settings for the Contrast, Mode and Resolution to determine which settings look the best.

## Adjusting the Image

### Brightness

Adjust the **Brightness** setting to get the best image. The Brother TWAIN Scanner driver offers 100 Brightness levels (-50 to 50). The default value is 0, representing an 'average' setting.

You can set the **Brightness** level by dragging the slide bar to the right to lighten the image or to the left to darken the image. You can also type a value in the box to set the level. Click **OK**.

If the scanned image is too light, set a lower Brightness level and scan the image again.

If the image is too dark, set a higher Brightness level and scan the image again.

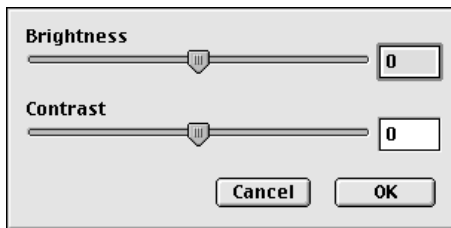

### Contrast

You can only adjust the **Contrast** level when you have selected one of the Gray Scale settings, it is not available when you have selected Black & White as the selected **Color Type**.

Increasing the **Contrast** level (by dragging the slide bar to the right) emphasizes dark and light areas of the image, while reducing the **Contrast** level (by dragging the slide bar to the left) reveals more detail in the gray areas. Instead of using the slide bar, you can type a value in the box to set the Contrast. Click **OK**.

# Using Presto!® PageManager®

Presto!® PageManager® is application software for managing the documents in your computer. Since it is compatible with most image editors and word processing programs, Presto!® PageManager® gives you unmatched control over your computer files. You can easily manage your documents, edit your E-mail files, and read documents with the OCR software built into Presto!® PageManager®.

If you use the machine as a scanner, we recommend that you install Presto!® PageManager®. To install Presto!® PageManager®, see Quick Setup Guide.



The complete NewSoft Presto!® PageManager® 4.0 User's Guide can be found on the Macintosh CD-ROM supplied with your machine.

## Highlights

---

- **OCR:** In one step you can scan an image, recognize the text, and edit it with a word processor.
- **Image Editing:** Enhance, crop and rotate images, or open them with an image-editing program of your choice.
- **Annotation:** Add removable notes, stamps, and drawings to images.
- **Treeview Window:** View and arrange your folder hierarchy for easy access.
- **Thumbnail Window:** View files as thumbnails for easy identification.

## System requirements

---

- PowerPC processor
- System 8.6, 9X, 10.1/10.2.1 or greater
- CD-ROM drive
- Hard disk drive with at least 120 MB of free disk space

### Recommended:

- 8-bit color or higher video adapter.
- Eudora Mail, or Outlook<sup>®</sup> Express electronic mail software

## Technical Support

---

### For USA

Newsoft America Inc.

Postal Address: 4113 Clipper Court Fremont, CA 94538, USA

Telephone: 510-4458600

FAX: 510-4458601

E-mail Address: [contactus@newsoftinc.com](mailto:contactus@newsoftinc.com)

URL: <http://www.newsoft.com/>

### For Canada

E-mail Address: [contactus@newsoftinc.com](mailto:contactus@newsoftinc.com)

# Using ControlCenter2.0 (For Mac OS® X 10.2.1 or greater)



- The screen shown in this section are from the MFC8840D.
- The functions that can be used in ControlCenter2.0 may vary depending upon the model.

ControlCenter2.0 is a software utility that allows you to quickly and easily access the most frequently used applications. Using ControlCenter2.0 eliminates the need to manually launch the specific applications. ControlCenter2.0 provides the following five categories of operations:

- 1 Scan directly to a file, E-mail, word processor or graphics application of your choice.
- 2 Custom Scan buttons allow you to configure a button to meet your own application requirements.
- 3 Access the Copy features available via your Macintosh®.
- 4 Access the settings available to configure your device.



You can open the configuration window for each function by clicking the **Configuration** button.

Also you can select which machine will connect with ControlCenter2.0 from the **Model** pull-down list.



# How to turn off the AutoLoad feature in ControlCenter2.0

---

The icon will appear on the menu bar. To open ControlCenter2.0 window, click on the icon  and select **Open**.

If you do not want ControlCenter2.0 to run automatically each time the computer is started;

- 1 Click on ControlCenter2.0 icon in the menu bar and select **Preference**.
- 2 ControlCenter2.0 preference window appears, then uncheck the **Start ControlCenter on computer startup** check box.
- 3 Click **OK** to close the window.



ControlCenter2.0 application icon is in  
Macintosh HD/Library/Printers/Brother/Utilities/ControlCenter.

## SCAN

---

This section contains four buttons for **Scan to Image**, **Scan to OCR**, **Scan to E-mail** and **Scan to File** applications.

- **Image** (*Default: Apple PreView*) — enables you to scan a page directly into any graphic viewer/editor application. You can select the destination application, such as Adobe® PhotoShop® or any kind of image editing application you already have installed on your computer.
- **OCR** (*Default: Apple Text Edit*) — enables you to scan a page or document, automatically run the OCR application and insert the text (not a graphic image) into a word processing application. You have the option of selecting the target word processing application, such as MS Word or whichever word processing application is installed on your computer.
- **E-mail** (*Default: your default E-mail software*) — enables you to scan a page or document directly into an E-mail application as a standard attachment. You have the option of selecting the file type and resolution for the attachment.
- **File** — enables you to scan directly to a disk file. You can change the file type and destination folder, as needed.

ControlCenter2.0 gives you the ability to configure the hardware **Scan** key on your machine for each scan feature. Select the **Device Button** in the configuration menu for each of the **SCAN** buttons.



For details about how to use the **Scan** key, see *Using the scan key (For USB or Parallel interface cable users)* on page 3-17.

## CUSTOM SCAN

---

You can configure the button name and settings for each of these buttons to meet your specific requirements by clicking on a button while holding down the Ctrl key and following the configuration menus.

## COPY

---

**COPY** — allows you to use the PC and any printer driver for enhanced copy operations. You can scan the page on the machine and print the copies using any of the features of the machine printer driver—**OR**—you can direct the copy output to any standard printer driver installed on the PC including network printers.

You can configure your preferred settings on up to four buttons.

## DEVICE SETTINGS (For MFC-8440, MFC-8640D, MFC-8840D and MFC-8840DN only)

---

You can configure the machine setting.

- **Remote Setup** — enables you to open the Remote Setup Program. (See *MFC Remote Setup (Mac OS® X) (For MFC-8440, MFC-8640D, MFC-8840D and MFC-8840DN only)* on page 7-47.)



When the machine is connected to a network, you cannot use this function.

# SCAN

This section contains four buttons for **Scan to Image**, **Scan to OCR**, **Scan to E-mail** and **Scan to File** applications.



## Image (example: Apple PreView)

**Scan to Image** feature allows you to scan an image directly into your graphics application for image editing. To change the default settings, click on the button while holding down the Ctrl key and select **Software Button**.

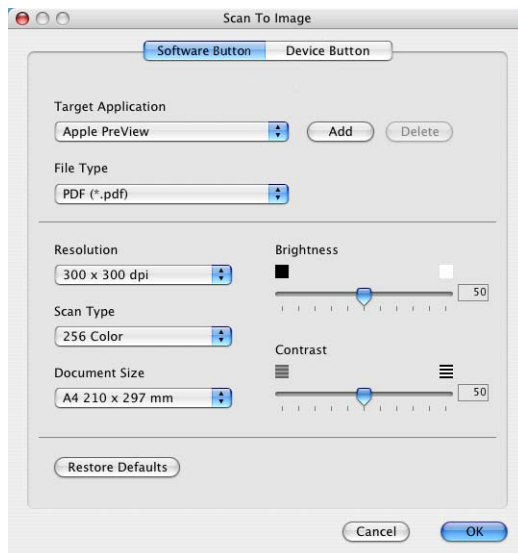

Change the other settings, if needed.



By selecting **Device Button** at each Scan button, you can configure the **Scan** key on your machine for each scan feature.

To change the destination application, select the appropriate application from the **Target Application** pull down list. You can add an application to the lists by clicking the **Add** button.

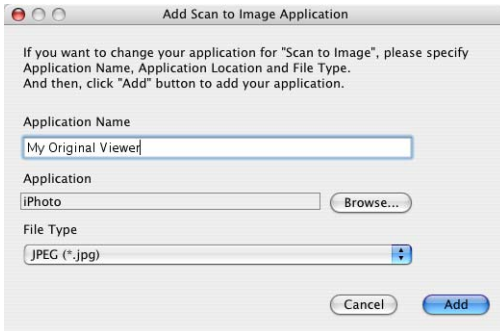

Enter the **Application Name** (up to 30 characters) and select your preferred application by clicking the **Browse** button. Also choose the **File Type** from the pull-down list.

You can delete applications that you have added. Just select the **Application Name** and click the **Delete** button.



This function is also available for Scan to E-mail and Scan to OCR. The window may vary depending upon the function.

## OCR (Word Processing program)

**Scan to OCR** converts the graphic page image data into text which can be edited by any word processor program. You can change the default word processor program.

To configure **Scan to OCR**, click on the button while holding down the Ctrl key and select **Software Button**.

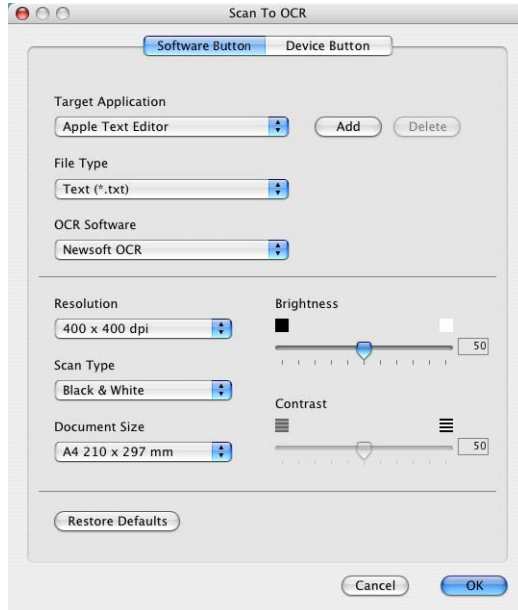

To change the word processing application, select the destination word processing application from the **Target Application** pull down list. You can add an application to the lists by clicking the **Add** button. An application can be deleted by clicking on the **Delete** button. You can also configure the other settings for this selection.

## E-mail

**Scan to E-mail** feature allows you to scan a document to your default E-mail application, so you can send the scanned job as an attachment. To change the default E-mail application or attachment file type, click on the button while holding down the Ctrl key and select **Software Button**.

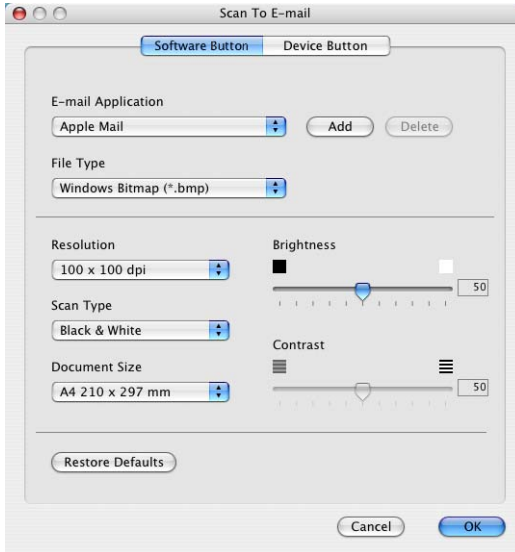

To change the E-mail application, select your preferred E-mail application from the **E-mail Application** pull down list. You can add an application to the lists by clicking the **Add** button. An application can be deleted by clicking on the **Delete** button.

You can also change the other settings used to create the file attachments.

## File attachments

You can choose from the following list of file types for attachment to your E-mail or for saving to a folder.

**File type** — Select from the pull-down list the type of file you want the scanned images to be saved in.

Windows Bitmap (\*.bmp)

JPEG (\*.jpg)

TIFF - Uncompressed (\*.tif)

TIFF - Compressed (\*.tif)

TIFF Multi-Page - Uncompressed (\*.tif)

TIFF Multi-Page - Compressed (\*.tif)

Portable Network Graphics (\*.png)

PDF (\*.pdf)



Additional file format support is available by scanning to Presto!® PageManager® and then use the save as function and choose the file format. (See *Using Presto!® PageManager®* on page 7-27.)

The additional file types supported are:

TIFF - Group 4 (\*.tif)

TIFF - Class F (\*.tif)

TIFF Multi Page - Group 4 (\*.tif)

TIFF Multi Page - Class F (\*.tif)



## File

**Scan to File** button allows you to scan an image and save it in a specific file type to any directory on your hard disk. This allows you to easily archive your paper documents. To configure the file type and save to directory, click on the button while holding down the Ctrl key and select **Software Button**.

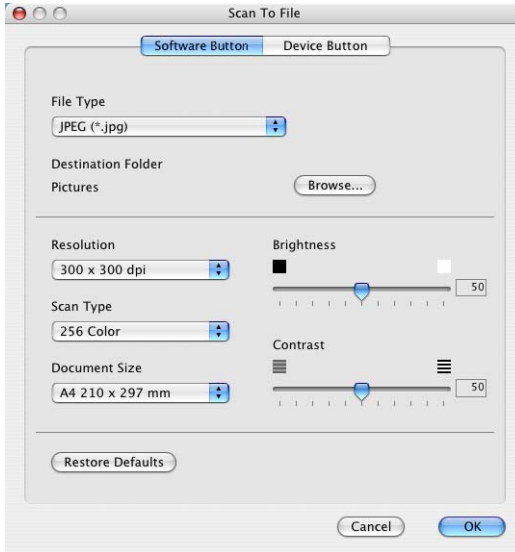

Select the file type for the saved image by selecting from the **File Type** pull down list. You can save the file to the default Pictures folder, or you can select another folder/directory by clicking the **Browse** button.



For the supported file types, please refer to the *File attachments* on page 7-37.

# CUSTOM SCAN

There are four buttons from which you can set your own preferences and configuration to fit your required usage for scanning.

To configure a button, click on the button while holding down the Ctrl key, and the configuration window will appear. You have four function choices of scan action, **Scan to Image**, **Scan to OCR**, **Scan to E-mail** and **Scan to File**.

**Scan to Image:** This setting allows you to scan a page directly into any graphic viewer/editor software. You can select any kind of image editor application you have installed on your computer as a destination application.

**Scan to OCR:** Scanned documents will be converted to editable text files. If you have a third party OCR software package installed on your computer, you can select it. You can also select the destination application for the editable text.

**Scan to E-mail:** Scanned images will be attached to an E-mail message. You can choose which E-mail application to use if you have more than one installed on your system. You can also select the file type for the attachment and create a quick send list of E-mail addresses chosen from your default E-mail address book.

**Scan to File:** This setting allows you to save a scanned image to any directory on a local or network hard disk. You can also select the file type to be used.



## Customizing a user-defined button

To configure a button, click on the button while holding down the Ctrl key, and the configuration window will appear. Please follow the following guide lines for the button configuration.

### Scan to Image:

In the **General** tab

You can enter up to 30 characters in the **Name for Custom** field. This name will appear as the button name.

Select the type of scan from the **Scan Action** field.

In the **Settings** tab

You can select **Target Application**, **File Type**, **Resolution**, **Scan Type**, **Document Size**, **Brightness** and **Contrast** settings.

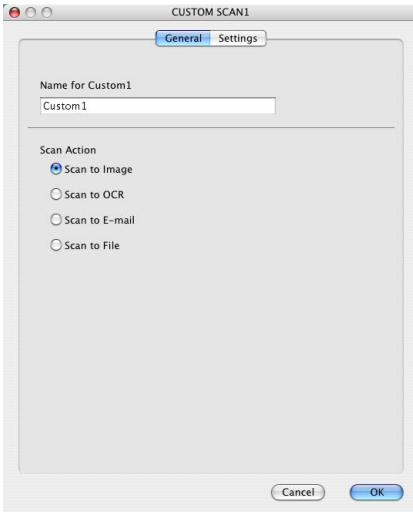

## Scan to OCR:

In the **General** tab

You can enter up to 30 characters in the **Name for Custom** field. This name will appear as the button name.

Select the type of scan from the **Scan Action** field.

In the **Settings** tab

You can select **Target Application**, **File Type**, **OCR Software**, **Resolution**, **Scan Type**, **Document Size**, **Brightness** and **Contrast** settings.

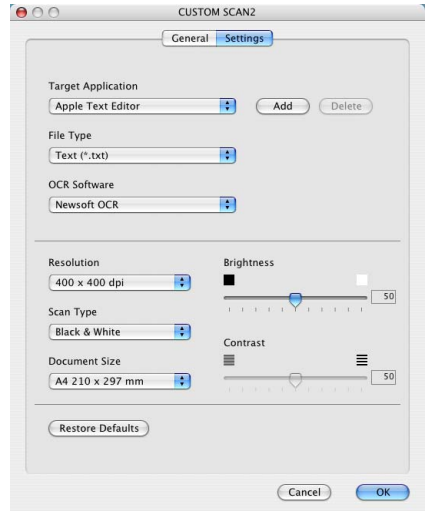
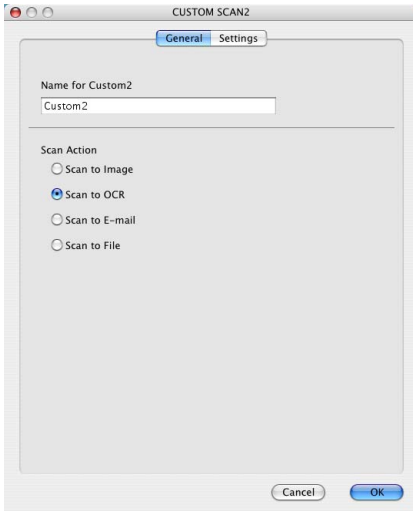

## Scan to E-mail:

In the **General** tab

You can enter up to 30 characters in the **Name for Custom** field. This name will appear as the button name.

Select the type of scan from the **Scan Action** field.

In the **Settings** tab

You can select **E-mail Application**, **File Type**, **Resolution**, **Scan Type**, **Document Size**, **Brightness** and **Contrast** settings.

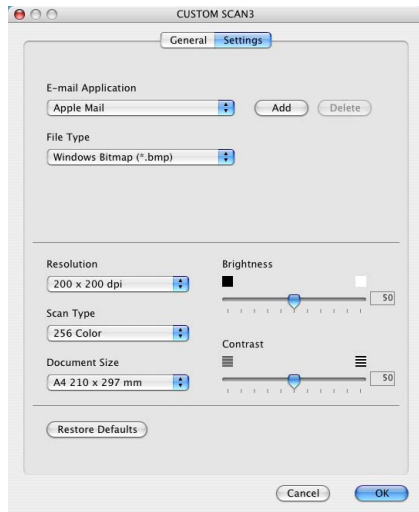
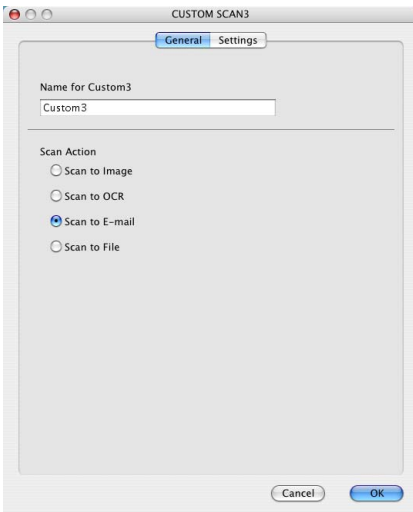

## Scan to File:

In the **General** tab

You can enter up to 30 characters in the **Name for Custom** field. This name will appear as the button name.

Select the type of scan from the **Scan Action** field.

In the **Settings** tab

Select the file format from the **File Type** pull down list. You can either send the file to the default My pictures folder or select your own destination folder by using the **Browse** button.

You can also select **Resolution**, **Scan Type**, **Document Size**, **Brightness** and **Contrast** settings.

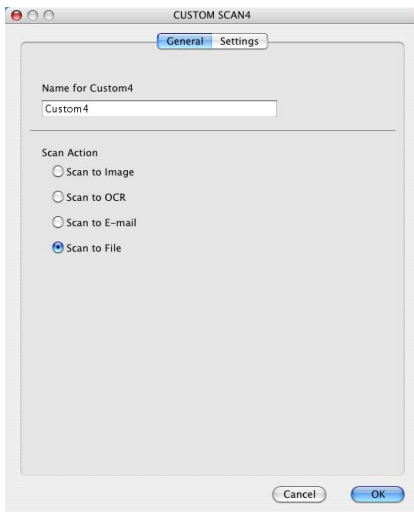

# COPY

The **Copy** buttons (1-4) can be customized to allow you to take advantage of the features built into the Brother printer drivers to do advanced copy functions such as N-in-1 printing.

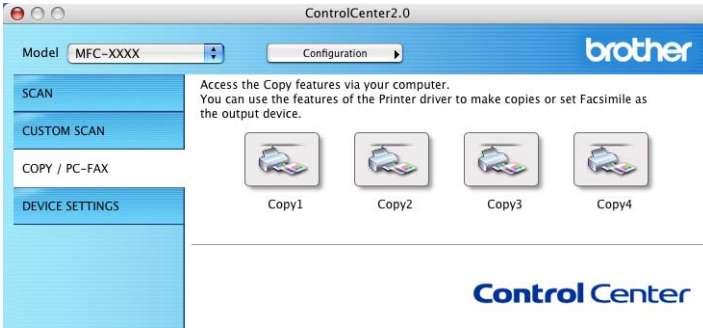

Before you can use the **Copy** buttons you must first configure the printer driver by clicking on the button while holding down the Ctrl key.

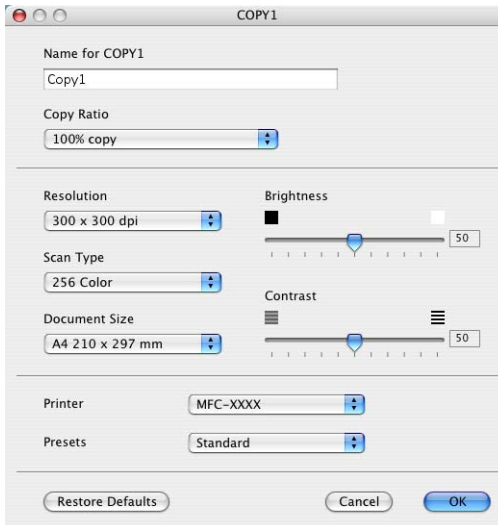

You can enter up to 30 characters in the **Name for Copy** field and select **Copy Ratio**.

You can select the **Resolution**, **Scan Type**, **Document Size**, **Brightness** and **Contrast** settings to be used.

Before finishing the **Copy** button configuration, you must set the **Printer**. Then select your print settings from the Presets pull-down list, then click OK to close the window. By clicking the configured copy button, the print dialog window will open.

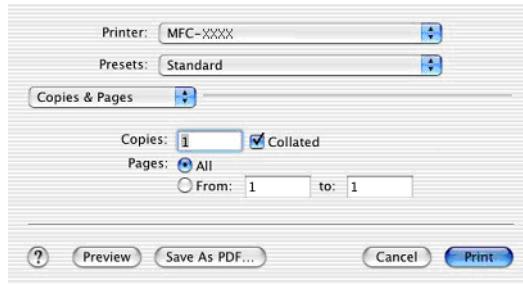

- You must configure each of the copy buttons before they can be used.
- By using the Copy button, you can also send a fax using the printer driver. (See *Sending a fax from your Macintosh® application (For MFC-8440, MFC-8640D, MFC-8840D and MFC-8840DN only)* on page 7-14.)



# DEVICE SETTINGS (For MFC-8440, MFC-8640D, MFC-8840D and MFC-8840DN only)

In this section you can configure the machine setting by clicking the button.



When the machine is connected to a network, you cannot use this function.



## Remote Setup

The **Remote Setup** button allows you to open the Remote Setup Program window in which you can configure the machine setting menus.

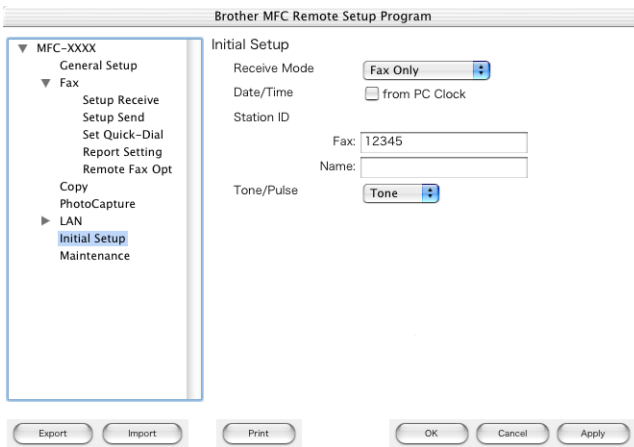

# MFC Remote Setup (Mac OS<sup>®</sup> X) (For MFC-8440, MFC-8640D, MFC-8840D and MFC-8840DN only)

The MFC Remote Setup application allows you to quickly set up your MFC by taking advantage of the ease and speed of programming on your Macintosh<sup>®</sup>. When you access this application, the settings on your MFC will be downloaded automatically to your Macintosh<sup>®</sup> and displayed on your computer screen. If you change the settings, you can upload them directly to the MFC.



The 'MFC Remote Setup' application icon is in Macintosh HD/Library/Printers/Brother/Utility.

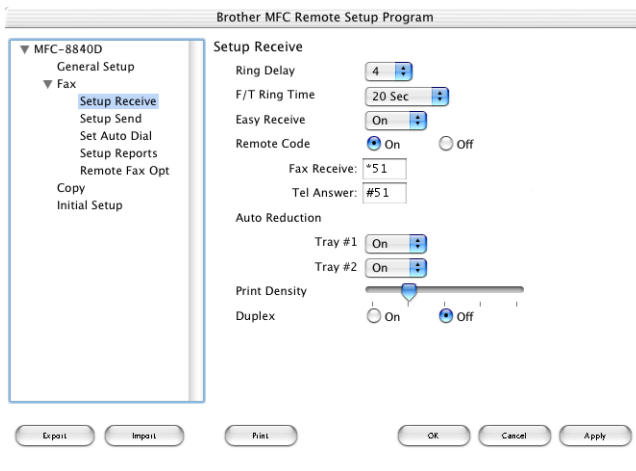

## OK

This starts the process of uploading the data to the MFC and exiting the remote setup program. If an error message is displayed enter the correct data again. Click **OK**.

## Cancel

This exits the remote setup application without uploading the data to the MFC.

**Apply**

This uploads the data to the MFC, but does not exit the remote setup application.

**Print**

This command prints the selected items on the MFC. You can not print the data until it is uploaded to the MFC. Click **Apply** to upload the new data to the MFC and click **Print**.

**Export**

This command saves the current configuration settings to a file.

**Import**

This command reads the settings from a file.

# 8

# Network Scanning (Windows® 98/98SE/Me/2000 Professional and XP only)



The screens shown in this chapter are from MFC-8840D.

To use the machine as a Network Scanner, the NC-9100h Network board should be installed into the machine (MFC-8840DN standard) and configured with TCP/IP and mail server settings if you use Scan to E-mail (E-mail server). You can set or change NC-9100h settings from your machine's control panel, with the BRAdmin Professional utility and with Web Management. (Please see the NC-9100h Network User's Guide on the CD-ROM.)

## Network License

---

This product includes a single PC license. If you purchase an optional Network LAN board NC-9100h that includes the license for up to 4 additional Users, you can install the MFL-Pro Software Suite including ScanSoft® PaperPort® 9.0SE on up to 5 PCs for use on a network. If you want to use more than 5 PCs with ScanSoft® PaperPort® 9.0SE installed, please purchase NL-5 which is a multiple PC license agreement pack for up to an additional 5 Users. To purchase NL-5, please contact your Brother Sales Office.



Max. 25 clients can be connected to one machine on a Network. For example, if 30 clients try to connect at a time, 5 clients will not be shown on the LCD.

# Registering your PC with the machine

If you need to change the machine that was registered to your PC during the installation of MFL-Pro, follow the steps below.

## 1 For Windows® 98/Me/2000

From the **Start** menu, select **Control panel, Scanners and Cameras**, and then right-click Scanner Device icon and select **Properties** to view the Network Scanner Properties dialog box.

*For Windows® XP*

From the **Start** menu, select **Control panel, Printers and Other Hardware, Scanner and Cameras** (or **Control panel, Scanners and Cameras**).

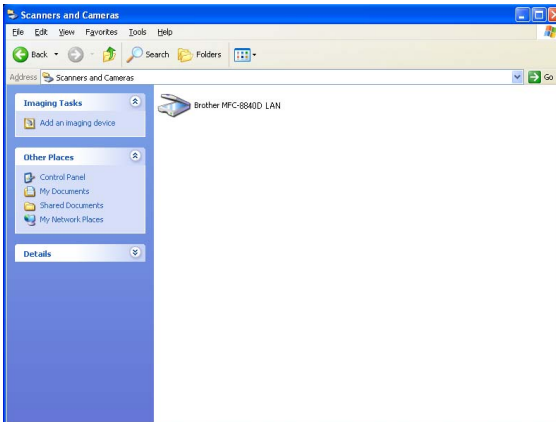

Right-click Scanner Device icon and select properties to view the Network Scanner Properties dialog box.

- 2 Click the **Network Setting** tab in the dialog box and select a method to specify your machine as a Network scanner for your PC.

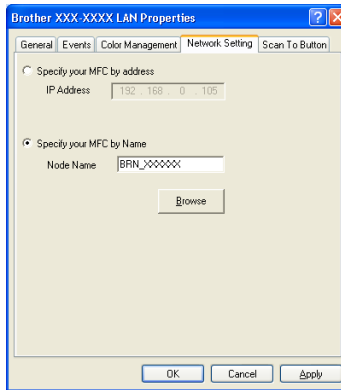

### **Specify your machine by address**

Enter the IP address of the machine in the IP Address field.

Click **Apply** and then **OK**.

### **Specify your machine by Name**

Enter the machine Node name in the Node Name field.

Click **Apply** and then **OK**.

### **Search from a list of available device**

Click Browse and select the appropriate device you want to use.

Click **OK**.

Click **Apply** and then **OK**.

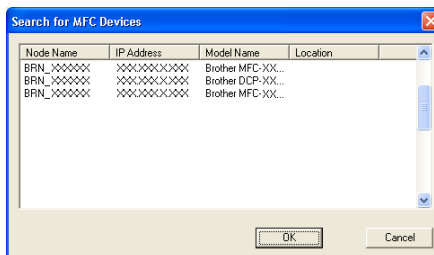

- 3 Click the **Scan To Button** tab in the dialog box and enter your PC Name in the Display Name field. The machine's LCD displays the name you enter. Default setting is your PC Name. You can enter a name if you like.

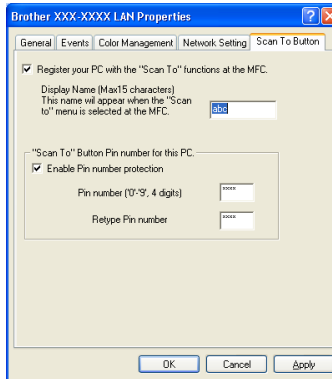

- 4 You can avoid receiving unwanted documents by setting a 4-digit PIN Number. Enter your PIN Number in the PIN Number and Retype PIN Number field. To send data to a PC protected by a PIN Number, the LCD prompts to enter the PIN Number before the document can be scanned and sent to the machine. (See *Using the Scan key* on page 8-5 to 8-9.)

# Using the Scan key

## Scan to E-mail (PC)



---

When you select Scan to E-mail (PC) your original will be scanned and sent directly to the PC you designated on your network. ControlCenter2.0 will activate the default E-mail application on the designated PC for addressing to the recipient. You can scan a black and white or color original and it will be sent with the E-mail from the PC as an attachment.

You can change the **Scan** configuration. (See *Scan to E-mail*: on page 4-14.)

**1** Place the original face up in the ADF, or face down on the scanner glass.

**2** Press **Scan**.

**3** Press  or  to select Scan to E-mail.



Press **Set**.

**4** Press  or  to select PC.

Press **Set**.

—OR—

Go to Step 5 if you have set up only one E-mail server.

**5** Press  or  to select the destination PC you want to use for E-mailing your original.

Press **Set**.

If the LCD prompts you to enter a PIN Number, enter the 4-digit PIN Number for the destination PC on the control panel.

Press **Set**.

The machine will start the scanning process.

▲ Scan to E-mail
Scan to Image
Scan to OCR
▼ Scan to File
Select ▲▼ & Set





# Scan to E-mail (E-mail server) (For MFC-8440, MFC-8640D, MFC-8840D and MFC-8840DN only)



When you select Scan to E-mail (E-mail server) you can scan a black and white or color original and send it directly to an E-mail address from the machine. You can choose PDF or TIFF for Black and White and PDF or JPEG for color.

 Scan to E-mail (E-mail Server) requires SMTP/POP3 mail server support. (See NC-9100h Network User's Guide on the CD-ROM)

1 Place the original face up in the ADF, or face down on the scanner glass.

2 Press **Scan**.



3 Press  or  to select Scan to E-mail.  
Press **Set**.



4 Press  or  to select E-mail Server.  
Press **Set**.

▲ Scan to E-mail
Scan to Image
Scan to OCR
▼ Scan to File
Select ▲▼ & Set

5 Press  or  to select Change Quality. Press **Set**.

—OR—

If you don't have to change the quality, press  or  to select Enter Address. Press **Set** and then go to Step 9.

6 Press  or  to select Color 150 dpi, Color 300 dpi, Color 600 dpi, B/W 200 dpi or B/W 200×100 dpi. Press **Set**.

If you select Color 150 dpi, Color 300 dpi or Color 600 dpi in Step 6, go to Step 7.

—OR—

If you select B/W 200 dpi or B/W 200×100 dpi in Step 6, go to Step 8.

7 Press  or  to select PDF or JPEG.  
Press **Set**.

8 Press  or  to select PDF or TIFF.  
Press **Set**.





9 The LCD prompts you to enter an address. Enter the destination E-mail address from the dial pad or use the One-Touch key or Speed-Dial key.

10 Press **Start**. The machine will start the scanning process.

## Scan to Image

---

When you select Scan to Image your original will be scanned and sent directly to the PC you designated on your network. ControlCenter2.0 will activate the default graphics application on the designated PC. You can change the **Scan** configuration. (See *Scan to Image*: on page 4-12.)

- 1 Place the original face up in the ADF, or face down on the scanner glass.
- 2 Press **Scan**.
- 3 Press  or  to select Scan to Image.  
Press **Set**.
- 4 Press  or  to select a destination you want to send to.  
Press **Set**.

▲ Scan to E-mail
Scan to Image
Scan to OCR
▼ Scan to File
Select ▲▼ & Set

If the LCD prompts you to enter a PIN Number, enter the 4-digit PIN Number for the destination PC on the control panel.

Press **Set**.

The machine will start the scanning process.

## Scan to OCR



---

When you select Scan to OCR your original will be scanned and sent directly to the PC you designated on your network. ControlCenter2.0 will activate ScanSoft® OmniPage® and convert your original into text for viewing and editing from a word processing application on the designated PC. You can change the **Scan** configuration.



(See *Scan to OCR*: on page 4-13.)

**1** Place the original face up in the ADF, or face down on the scanner glass.

**2** Press **Scan**.

**3** Press  or  to select Scan to OCR.

Press **Set**.

**4** Press  or  to select a destination you want to send to.

Press **Set**.

If the LCD prompts you to enter a PIN Number, enter the 4-digit PIN Number for the destination PC on the control panel.

Press **Set**.

The machine will start the scanning process.

▲	Scan to E-mail
	Scan to Image
	Scan to OCR
▼	Scan to File
Select ▲▼ & Set	

## Scan to File



---

When you select Scan to File you can scan a black and white or color original and send it directly to a PC you designate on your network. The file will be saved in the folder and file format that you have configured in ControlCenter2.0 on the designated PC. You can change the Scan configuration.



(See *Scan to File*: on page 4-15.)

**1** Place the original face up in the ADF, or face down on the scanner glass.

**2** Press **Scan**.

**3** Press  or  to select Scan to File.

Press **Set**.

**4** Press  or  to select a destination you want to send to.

Press **Set**.

If the LCD prompts you to enter a PIN Number, enter the 4-digit PIN Number for the destination PC on the control panel.

Press **Set**.

The machine will start the scanning process.

▲	Scan to E-mail
	Scan to Image
	Scan to OCR
▼	Scan to File
Select ▲▼ & Set	

# 9

# Brother Network PC-FAX software

(For MFC-8440, MFC-8640D, MFC-8840D and  
MFC-8840DN only)

To use the MFC as a Network PC-FAX, the NC-9100h Network board should be installed into the MFC (MFC-8840DN standard) and configured with TCP/IP and mail server settings if you use Scan to E-mail (E-mail server). (See *Using Brother PC-FAX software* on page 6-1.)

## Enable Network PC-FAX

---

To use the MFC for Network PC-FAX, see *Using Brother PC-FAX software* on page 6-1.



The items described below are specific items relating to the Network version of PC-FAX software that is installed from the "Optional network applications" on the CD-ROM supplied with your MFC.

Brother Network PC-FAX can be configured through PC-FAX Setup, Sending tab.

### Sending setup

In order to use the full functionality of Network PC-FAX it is strongly recommended that you enable the Network PC-FAX Setup option on the Sending tab Brother PC-FAX Setup.

- 1 Access the Sending Tab from the PC-FAX dialog box by clicking .

—OR—

From the **Start** menu, select **All programs, Brother, MFL-Pro Suite MFC-XXXX**, and then select **PC-FAX Setup**.

## 2 Check **Enable** box.

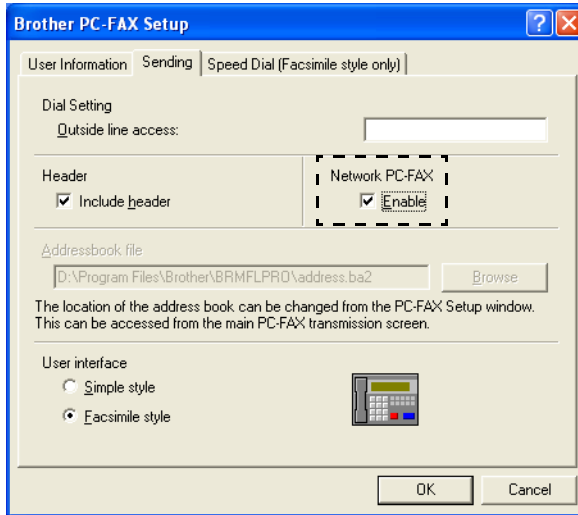

 This software can be used in a network environment and with a locally connected machine. It is important that when used in a network environment the Network PC Fax is set to enable.

## Extra options in Address Book

When the Enable Network PC-FAX option is selected, three additional options appear in the address book contact window.

- 1 In the Address Book dialog box, click the  icon to add a member.

The **Brother Address Book Member Setup** dialog box will appear:

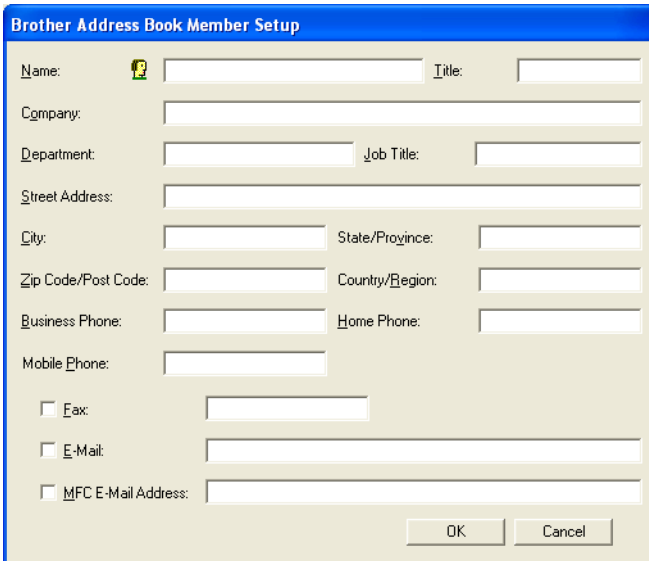

**Brother Address Book Member Setup**

Name:   Title:

Company:

Department:  Job Title:

Street Address:

City:  State/Province:

Zip Code/Post Code:  Country/Region:

Business Phone:  Home Phone:

Mobile Phone:

Fax:

E-Mail:

MFC E-Mail Address:

OK Cancel

- 2 In the **Brother Address Book Member Setup** dialog box, type the member's information.  
**Name** is required field. You can also enter an E-mail contact address and MFC address for the address book member.
- 3 You will need to specify the preferred way to send to this contact by checking the **Fax**, **E-mail** or **MFC E-mail Address** box.
- 4 Click the **OK** button to save the member's information.



If you wish to send a document to this contact by more than one method you must create a second contact and select a different option, Fax, E-Mail or MFC Address.

To use the MFC for Network PC-FAX Send, see *Using Brother PC-FAX software* on page 6-1.

# Using the Brother Network PC-FAX software

The Brother Network PC-FAX feature allows you to use your PC to send any application or document file as a standard fax. You can create a file in any application on your PC, and then send it as a Network PC-FAX. You can even attach a cover page note. All you have to do is set up the receiving parties as Members or Groups in your PC-FAX Address Book or simply enter the destination address or fax number into the User Interface. You can use the Address Book Search feature to quickly find members to send your fax.



Please check Brother Solutions Center for the latest updates available for Brother Network PC-FAX. Visit <http://solutions.brother.com/>

## Quick Tips:

Please see *Enable Network PC-FAX* on page 9-1 before using Brother Network PC-FAX.

- 1 Ensure that Network PC-FAX is set to “Enable” in the Sending tab of Setup. (See *Enable Network PC-FAX* on page 9-1.)

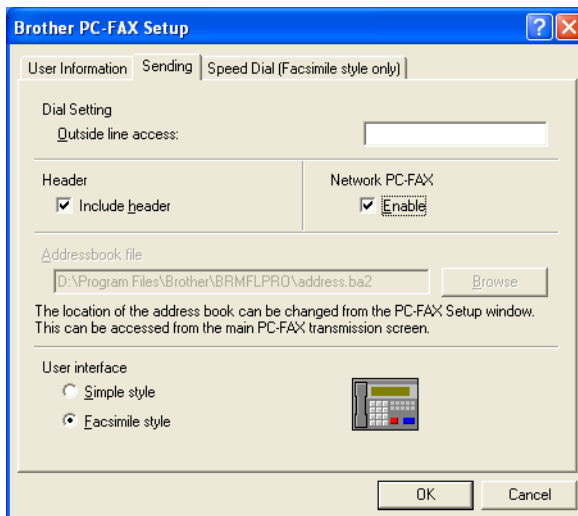



- 2 To send an E-mail from Brother Network PC-FAX you can either enter the E-mail address in the To: field or in the display for Facsimile Style using the PC keyboard or select the member from the Address Book. The member must have E-mail selected as the chosen destination for that member.
- 3 To send an Internet Fax from Brother Network PC-FAX you can either enter the Internet Fax address in the To: field or in the display for Facsimile style using the PC keyboard or select the member from the Address Book. The member must have MFC Mail Address selected as the chosen destination for that member.
- 4 To send a Network Fax simply select a member from the address book or enter the fax number into the User Interface with the PC keyboard. The member must have Fax selected as the chosen destination for that member.



Sending a Network PC-Fax to an E-mail address or sending an Internet Fax requires SMTP/POP3 mail server support.

## **Sending a Network PC-FAX from your Macintosh® application**

---

You can send a fax directly from your Macintosh® application using the following steps:



The PS driver does not support following function.

### **For Mac OS® 8.6-9.2 users**

- 1 Follow the steps *For Network Interface Cable Users* in the Quick Setup Guide.
- 2 Follow the steps on pages 7-14 and 7-15.

### **For Mac OS® X users**

- 1 Follow the steps *For Network Interface Cable Users* in the Quick Setup Guide.
- 2 Follow the steps on pages 7-16 to 7-19.

# Index

## C

- ControlCenter2.0 ..... 4-1
- ControlCenter2.0 for Macintosh  
..... 7-29

## D

- drivers
  - printer ..... 2-1
  - TWAIN Compliant ..... 3-8
  - Windows®
    - printer ..... 1-1

## F

- Fax
  - sending a fax from Macintosh®  
..... 7-14
  - Windows®
    - PC-FAX (Windows®) ..... 6-1
    - receiving ..... 6-19
    - sending
      - address book ..... 6-7
      - cover page ..... 6-14
      - facsimile style ..... 6-16
      - group ..... 6-9
      - simple style ..... 6-17

## M

- manual feed tray ..... 1-5, 1-7

## P

- PaperPort®
  - accessing ..... 3-9
  - exporting ..... 3-24
  - importing ..... 3-23

## print

- driver ..... 2-1
- emulation
  - Windows® ... 1-1, 1-17, 2-17
  - Emulation Selection ..... 1-17
  - envelopes ..... 1-11
  - manual feed tray ..... 1-5
  - multi-purpose tray ..... 1-6
  - on thick paper ..... 1-7
  - reports and lists ..... 1-18
  - Secure key ..... 1-16
  - two-sided (duplex printing)  
..... 1-3
- printer driver ..... 2-17
- PS printer driver ..... 2-17

## R

- resolution
  - Scan ..... 3-13

## S

- Scanning into PC ..... 3-10
- ScanSoft® OmniPage® OCR  
..... 3-23
- ScanSoft® PaperPort®  
..... 3-20
- software
  - Macintosh®
    - Scanning into Macintosh®  
..... 7-21
  - ScanSoft® PaperPort®  
..... 3-20



Brother International Corporation  
100 Somerset Corporate Boulevard  
P.O. Box 6911  
Bridgewater, NJ 08807-0911 USA

Brother International Corporation (Canada) Ltd.  
1 rue Hôtel de Ville,  
Dollard-des-Ormeaux, QC, CANADA H9B 3H6

**Visit us on the World Wide Web**  
**<http://www.brother.com>**

These machines are made for use in the USA and CANADA only. We cannot recommend using them overseas because it may violate the Telecommunications Regulations of that country and the power requirements of your multi-function center may not be compatible with the power available in foreign countries. **Using USA or CANADA models overseas is at your own risk and may void your warranty.**

## Free Manuals Download Website

<http://myh66.com>

<http://usermanuals.us>

<http://www.somanuals.com>

<http://www.4manuals.cc>

<http://www.manual-lib.com>

<http://www.404manual.com>

<http://www.luxmanual.com>

<http://aubethermostatmanual.com>

Golf course search by state

<http://golfingnear.com>

Email search by domain

<http://emailbydomain.com>

Auto manuals search

<http://auto.somanuals.com>

TV manuals search

<http://tv.somanuals.com>