

**FAX-1840C**  
**FAX-1940CN**  
**MFC-3240C**  
**MFC-3340CN**

---

**brother**

## If you need to call Customer Service

Please complete the following information for future reference:

**Model Number: FAX-1840C, FAX-1940CN, MFC-3240C and MFC-3340CN**

**(Circle your model number)**

**Serial Number:\*** \_\_\_\_\_

**Date of Purchase:** \_\_\_\_\_

**Place of Purchase:** \_\_\_\_\_

**\* The serial number is on the back of the unit. Retain this User's Guide with your sales receipt as a permanent record of your purchase, in the event of theft, fire or warranty service.**

**Register your product on-line at**

**<http://www.brother.com/registration>**

By registering your product with Brother International Corporation, you will be recorded as the original owner of the product. Your registration with Brother:

- may serve as confirmation of the purchase date of your product should you lose your receipt;
- may support an insurance claim by you in the event of product loss covered by insurance; and,
- will help us notify you of enhancements to your product and special offers.

The most convenient and efficient way to register your new product is on-line at <http://www.brother.com/registration>

# Brother numbers

## IMPORTANT

For technical help, you must call the country where you bought the machine. Calls must be made **from within** that country.

## Register your product

---

By registering your product with Brother International Corporation, you will be recorded as the original owner of the product. Your registration with Brother:

- may serve as confirmation of the purchase date of your product should you lose your receipt;
- may support an insurance claim by you in the event of product loss covered by insurance; and,
- will help us notify you of enhancements to your product and special offers.

Please complete and fax the Brother Warranty Registration And Test Sheet or, for your convenience and most efficient way to register your new product, register on-line at

<http://www.brother.com/registration>

## Frequently asked questions (FAQs)

---

The Brother Solutions Center is our one-stop resource for all your Fax Machine/Multi-Function Center needs. You can download the latest software and utilities, read FAQs and troubleshooting tips to learn how to get the most from your Brother product.

<http://solutions.brother.com>



You can check here for Brother driver updates.

## For Customer Service

---

**In USA:** 1-800-284-4329 (voice)  
1-901-379-1215 (fax)  
1-800-284-3238 (TTY service for the hearing-impaired)

**In Canada:** 1-877-BROTHER (voice)  
(514) 685-4898 (fax)

### Service Center Locator (USA only)

For the location of a Brother authorized service center, call 1-800-284-4357.

### Service Center Locations (Canada only)

For the location of a Brother authorized service center, call 1-877-BROTHER.

## Brother fax back system (USA only)

Brother has installed an easy-to-use fax back system, so you can get instant answers to common technical questions and product information for all Brother products. This system is available 24 hours a day, 7 days a week. You can use the system to receive faxed instructions and an Index of fax back subjects.

**In USA only:** 1-800-521-2846

## Ordering accessories and supplies

For best quality results use only genuine Brother accessories, which are available at most Brother retailers. If you cannot find the accessory you need and you have a Visa, MasterCard, Discover, or American Express credit card, you can order accessories directly from Brother. (In the USA, you can visit us online for a complete selection of the Brother accessories and supplies that are available for purchase.)

**In USA:** 1-888-879-3232 (voice)  
1-800-947-1445 (fax)

<http://www.brothermall.com>

**In Canada:** 1-877-BROTHER (voice)

Description	Item
Ink Cartridge Standard <black>	LC41BK (Prints up to 500 pages)
Ink Cartridge High Yield <black>	LC41HYBK (Prints up to 900 pages)
Ink Cartridge <cyan> (blue)	LC41C (Prints up to 400 pages)
Ink Cartridge <magenta> (red)	LC41M (Prints up to 400 pages)
Ink Cartridge <yellow>	LC41Y (Prints up to 400 pages)
Premium Glossy Photo Paper (Letter size / 20 sheets)	BP60 GLL
Matte Inkjet Paper (Letter size / 25 sheets)	BP60 ML
Inkjet Plain Paper (Letter size / 250 sheets)	BP60 PL
Telephone Line Cord	LG3077001
Telephone Handset (FAX-1840C and FAX-1940CN only)	LE0446011
Handset Curled Cord (FAX-1840C and FAX-1940CN only)	LE6681001
Power Protector for A/C Power Telephone Line Surges and Voltage Spikes (2 outlets)	QPD120
Power Protector for A/C Power Telephone Line Surges and Voltage Spikes (8 outlets)	FX120
User's Guide	LF5686001 (English for USA and Canada) LF5710001 (French For Canada)

## **Notice - Disclaimer of Warranties (USA and Canada)**

BROTHER'S LICENSOR(S), AND THEIR DIRECTORS, OFFICERS, EMPLOYEES OR AGENTS (COLLECTIVELY BROTHER'S LICENSOR) MAKE NO WARRANTIES, EXPRESS OR IMPLIED, INCLUDING WITHOUT LIMITATION THE IMPLIED WARRANTIES OF MERCHANTABILITY AND FITNESS FOR A PARTICULAR PURPOSE, REGARDING THE SOFTWARE. BROTHER'S LICENSOR(S) DOES NOT WARRANT, GUARANTEE OR MAKE ANY REPRESENTATIONS REGARDING THE USE OR THE RESULTS OF THE USE OF THE SOFTWARE IN TERMS OF ITS CORRECTNESS, ACCURACY, RELIABILITY, CURRENTNESS OR OTHERWISE. THE ENTIRE RISK AS TO THE RESULTS AND PERFORMANCE OF THE SOFTWARE IS ASSUMED BY YOU. THE EXCLUSION OF IMPLIED WARRANTIES IS NOT PERMITTED BY SOME STATES IN THE USA AND SOME PROVINCES IN CANADA. THE ABOVE EXCLUSION MAY NOT APPLY TO YOU.

IN NO EVENT WILL BROTHER'S LICENSOR(S) BE LIABLE TO YOU FOR ANY CONSEQUENTIAL, INCIDENTAL OR INDIRECT DAMAGES (INCLUDING DAMAGES FOR LOSS OF BUSINESS PROFITS, BUSINESS INTERRUPTION, LOSS OF BUSINESS INFORMATION, AND THE LIKE) ARISING OUT OF THE USE OR INABILITY TO USE THE SOFTWARE EVEN IF BROTHER'S LICENSOR HAS BEEN ADVISED OF THE POSSIBILITY OF SUCH DAMAGES. BECAUSE SOME STATES IN THE USA AND SOME PROVINCES IN CANADA DO NOT ALLOW THE EXCLUSION OR LIMITATION OF LIABILITY FOR CONSEQUENTIAL OR INCIDENTAL DAMAGES, THE ABOVE LIMITATIONS MAY NOT APPLY TO YOU. IN ANY EVENT BROTHER'S LICENSOR'S LIABILITY TO YOU FOR ACTUAL DAMAGES FROM ANY CAUSE WHATSOEVER, AND REGARDLESS OF THE FORM OF THE ACTION (WHETHER IN CONTRACT, TORT (INCLUDING NEGLIGENCE), PRODUCT LIABILITY OR OTHERWISE), WILL BE LIMITED TO \$50.

### **Compilation and Publication Notice**

Under the supervision of Brother Industries Ltd., this manual has been compiled and published, covering the latest product descriptions and specifications.

The contents of this manual and the specifications of this product are subject to change without notice.

Brother reserves the right to make changes without notice in the specifications and materials contained herein and shall not be responsible for any damages (including consequential) caused by reliance on the materials presented, including but not limited to typographical and other errors relating to the publication.

# Brother® One Year Limited Warranty and Replacement Service (USA only)

## Who is covered:

- This limited warranty ("warranty") is given only to the original end-use/retail purchaser (referred to in this warranty as "Original Purchaser") of the accompanying product, consumables and accessories (collectively referred to in this warranty as "this Product").
- If you purchased a product from someone other than an authorized Brother reseller in the United States or if the product was used (including but not limited to floor models or refurbished product), prior to your purchase you are not the Original Purchaser and the product that you purchased is not covered by this warranty.

## What is covered:

- This Product includes a Machine and Consumable and Accessory Items. Consumable and Accessory Items include but are not limited to print heads, toner, drums, ink cartridges, print cartridges, refill ribbons, therma PLUS paper and thermal paper.
- Except as otherwise provided herein, Brother warrants that the Machine and the accompanying Consumable and Accessory Items will be free from defects in materials and workmanship, when used under normal conditions.
- This warranty applies only to products purchased and used in the United States. For products purchased in, but used outside, the United States, this warranty covers only warranty service within the United States (and does not include shipping outside the United States).

## What is the length of the Warranty Periods:

- Machines: one year from the original purchase date.
- Accompanying Consumable and Accessory Items: 90 days from the original purchase date or the rated life of consumable, whichever comes first.

## What is NOT covered:

This warranty does not cover:

- (1) Physical damage to this Product;
- (2) Damage caused by improper installation, improper or abnormal use, misuse, neglect or accident (including but not limited to transporting this Product without the proper preparation and/or packaging);
- (3) Damage caused by another device or software used with this Product (including

but not limited to damage resulting from use of non Brother®-brand parts and Consumable and Accessory Items);

- (4) Consumable and Accessory Items that expired in accordance with a rated life; and,
- (5) Problems arising from other than defects in materials or workmanship.
- (6) Normal Periodic Maintenance Items, such as Paper Feeding Kit, Fuser and Laser Units.

This limited warranty is VOID if this Product has been altered or modified in any way (including but not limited to attempted warranty repair without authorization from Brother and/or alteration/removal of the serial number).

## What to do if you think your Product is eligible for warranty service:

Report your issue to either our Customer Service Hotline at 1-800-284-4329 for Fax, MFC and DCP and 1-800-276-7746 for Printers, or to a Brother Authorized Service Center **within the applicable warranty period.** Supply Brother or the Brother Authorized Service Center with a copy of your dated bill of sale showing that this Product was purchased within the U.S. For the name of local Brother Authorized Service Center(s), call 1-800-521-2846.

## What Brother will ask you to do:

After contacting Brother or a Brother Authorized Service Center, you may be required to deliver (by hand if you prefer) or send the Product properly packaged, freight prepaid, to the Authorized Service Center together with a photocopy of your bill of sale.

**You are responsible for the cost of shipping, packing product, and insurance (if you desire). You are also responsible for loss or damage to this Product in shipping.**

## What Brother will do:

If the problem reported concerning your Machine and/or accompanying Consumable and Accessory Items is covered by this warranty and if you first reported the problem to Brother or an Authorized Service Center within the applicable warranty period, Brother or its Authorized Service Center will repair or replace the Machine and/or accompanying Consumable and Accessory Items at no charge to you for parts or labor. The decision as to whether to repair or replace the Machine and/or accompanying Consumable and Accessory Items is made

## Brother® One Year Limited Warranty and Replacement Service (USA only)

by Brother in its sole discretion. Brother reserves the right to supply a refurbished or remanufactured replacement Machine and/or accompanying Consumable and Accessory Items and use refurbished parts provided such replacement products conform to the manufacturer's specifications for new product/parts. The repaired or replacement Machine and/or accompanying Consumable and Accessory Items will be returned to you freight prepaid or made available for you to pick up at a conveniently located Authorized Service Center.

If the Machine and/or accompanying Consumable and Accessory Items are not covered by this warranty (either stage), you will be charged for shipping the Machine and/or accompanying Consumable and Accessory Items back to you and charged for any service and/or replacement parts/products at Brother's then current published rates.

**The foregoing are your sole (i.e., only) and exclusive remedies under this warranty.**

**What happens when Brother elects to replace your Machine:**

When a replacement Machine is authorized by Brother, and you have delivered the Machine to an Authorized Service Center, the Authorized Service Center will provide you with a replacement Machine after receiving one from Brother. If you are dealing directly with Brother, Brother will send to you a replacement Machine with the understanding that you will, after receipt of the replacement Machine, supply the required proof of purchase information, together with the Machine that Brother agreed to replace. You are then expected to pack the Machine that Brother agreed to replace in the package from the replacement Machine and return it to Brother using the pre-paid freight bill supplied by Brother in accordance with the instructions provided by Brother. Since you will be in possession of two machines, Brother will require that you provide a valid major credit card number. Brother will issue a hold against the credit card account number that you provide until Brother receives your original Product and determines that your original Product is entitled to warranty coverage. Your credit card will be charged up to the cost of a new Product only if: (i) you do not return your original Product to Brother within five (5) business days; (ii) the problems with your original Product are not covered by the limited warranty; (iii) the proper packaging instructions are not followed and has caused

damage to the product; or (iv) the warranty period on your original Product has expired or has not been sufficiently validated with a copy of the proof of purchase (bill of sale). The replacement Machine you receive (even if refurbished or remanufactured) will be covered by the balance of the limited warranty period remaining on the original Product, plus an additional thirty (30) days. You will keep the replacement Machine that is sent to you and your original Machine shall become the property of Brother. **Retain your original Accessory Items and a copy of the return freight bill, signed by the courier.**

### Limitations:

Brother is not responsible for damage to or loss of any equipment, media, programs or data related to the use of this Product. Except for that repair or replacement as described above, Brother shall not be liable for any direct, indirect, incidental or consequential damages or specific relief. Because some states do not allow the exclusion or limitation of consequential or incidental damages, the above limitation may not apply to you.

THIS WARRANTY IS GIVEN IN LIEU OF ALL OTHER WARRANTIES, WRITTEN OR ORAL, WHETHER EXPRESSED BY AFFIRMATION, PROMISE, DESCRIPTION, DRAWING, MODEL OR SAMPLE. ANY AND ALL WARRANTIES OTHER THAN THIS ONE, WHETHER EXPRESS OR IMPLIED, INCLUDING IMPLIED WARRANTIES OF MERCHANTABILITY AND FITNESS FOR A PARTICULAR PURPOSE, ARE HEREBY DISCLAIMED.

- This Limited Warranty is the only warranty that Brother is giving for this Product. It is the final expression and the exclusive and only statement of Brother's obligations to you. It replaces all other agreements and understandings that you may have with Brother or its representatives.
- This warranty gives you certain rights and you may also have other rights that may vary from state to state.
- This Limited Warranty (and Brother's obligation to you) may not be changed in any way unless you and Brother sign the same piece of paper in which we (1) refer to this Product and your bill of sale date, (2) describe the change to this warranty and (3) agree to make that change.

**Important:** *We recommend that you keep all original packing materials, in the event that you ship this Product.*

## **BROTHER MULTIFUNCTION CENTER/FACSIMILE MACHINE LIMITED WARRANTY (Canada only)**

Pursuant to this limited warranty of 1 year from the date of purchase for labour and parts, Brother International Corporation (Canada) Ltd. ("Brother"), or its Authorized Service Centers, will repair this MFC/Facsimile machine free of charge if defective in material or workmanship. This Limited Warranty does not include cleaning, consumables (including, without limitation, print cartridges, print head, toner and drum) or damage caused by accident, neglect, misuse or improper installation or operation, any damage caused from service, maintenance, modifications, or tampering by anyone other than a Brother Authorized Service Representative, or from the use of supplies or consumable items that are non-Brother products. Operation of the MFC/Facsimile machine in excess of the specifications or with the Serial Number or Rating Label removed shall be deemed abuse and all repairs thereafter shall be the sole liability of the end-user/purchaser. In order to obtain warranty service, the machine/Facsimile machine must be delivered or shipped freight prepaid by the end user/purchaser to a "Brother" Authorized Service Center, together with your Proof of Purchase in the form of a Sales Receipt.

For laser products: Failure to remove the Toner Cartridge (and Toner Drum Unit on applicable models) during shipping will cause severe damage to the MFC/Facsimile and will VOID the Warranty. (Refer to your User's Guide for proper packaging.)

For ink-jet products: Do not remove the ink cartridges during shipping. Damage to your print head resulting from packing without the ink cartridges will VOID your warranty. (Refer to your User's Guide for proper packaging.)

**BROTHER DISCLAIMS ALL OTHER WARRANTIES EXPRESSED OR IMPLIED INCLUDING, WITHOUT LIMITATION, ANY IMPLIED WARRANTIES OF MERCHANTABILITY OR FITNESS FOR A PARTICULAR PURPOSE, EXCEPT TO THE EXTENT THAT ANY WARRANTIES IMPLIED BY LAW CANNOT BE VALIDLY WAIVED.**

No oral or written information, advice or representation provided by Brother, its Authorized Service Centers, Distributors, Dealers, Agents or employees, shall create another warranty or modify this warranty. This warranty states Brother's entire liability and your exclusive remedy against Brother for any failure of the MFC/Facsimile machine to operate properly.

Neither Brother nor anyone else involved in the development, production, or delivery of this MFC/Facsimile machine shall be liable for any indirect, incidental, special, consequential, exemplary, or punitive damages, including lost profits, arising from the use of or inability to use the product, even if advised by the end user/purchaser of the possibility of such damages. Since some Provinces do not allow the above limitation of liability, such limitation may not apply to you.

This Limited Warranty gives you specific legal rights and you may also have other rights which vary from Providence to Providence.

**Warranty Service is available at Brother Authorized Service Centers throughout Canada. For Technical Support or for the name and location of your nearest Authorized Service Center call 1-877-BROTHER.**

**Internet support: [support@brother.ca](mailto:support@brother.ca) or browse**

**Brother's Web Site: [www.brother.com](http://www.brother.com)**

Brother International Corporation (Canada) Ltd.

1 Rue Hôtel de Ville

Dollard-Des-Ormeaux, QC H9B 3H6

At your side.  
**brother**®









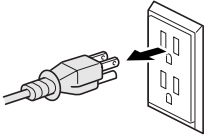

# Safety precautions

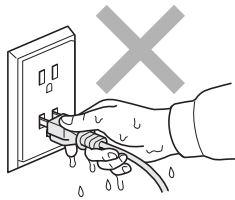
## To use the machine safely

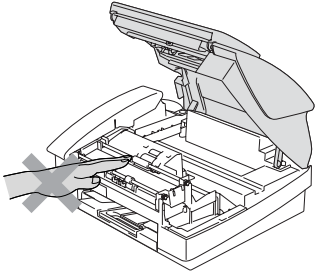
Please refer to these instructions for later reference and before attempting any maintenance.

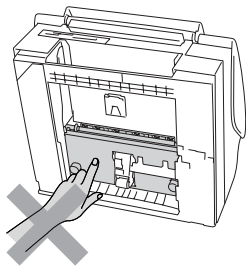
### WARNING

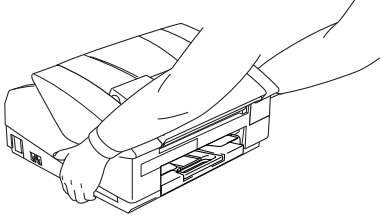
	<p>There are high voltage electrodes inside the machine. Before you clean the machine, make sure you have unplugged the telephone line cord first and then the power cord from the AC power outlet.</p> 		<p>Do not handle the plug with wet hands. Doing this might cause an electrical shock.</p> 
	<p>To prevent injuries, be careful not to touch the area shaded in the illustration.</p> 		<p>When you move the machine, grasp the side handholds as shown in the illustration.</p> 
	<p>When you move the machine, place a hand at each side of the unit so you are supporting the base when you lift it. (See the illustration on the right.)</p> 		

- Use caution when installing or modifying telephone lines. Never touch telephone wires or terminals that are not insulated unless the telephone line has been disconnected at the wall jack. Never install telephone wiring during a lightning storm. Never install a telephone wall jack in a wet location.
- This product must be installed near an AC power outlet that is easily accessible. In case of emergencies, you must disconnect the power cord from the AC power outlet in order to shut off power completely.
- To reduce the risk of shock or fire, use only a No. 26 AWG or larger telecommunication line cord.

 **Caution**

- Lightning and power surges can damage this product! We recommend that you use a quality surge protection device on the AC power line and on the telephone line, or unplug the cords during a lightning storm.

**IMPORTANT SAFETY INSTRUCTIONS**

When using your telephone equipment, basic safety precautions should always be followed to reduce the risk of fire, electric shock and injury to persons, including the following:

1. Do not use this product near water, for example, near a bath tub, wash bowl, kitchen sink or washing machine, in a wet basement or near a swimming pool.
2. Avoid using this product during an electrical storm. There may be a remote risk of electric shock from lightning.
3. Do not use this product to report a gas leak in the vicinity of the leak.
4. Use only the power cord provided with the machine.

**SAVE THESE INSTRUCTIONS**

# Choosing a location

Place your machine on a flat, stable surface that is free of vibration and shocks, such as a desk. Put the machine near a telephone wall jack and a standard, grounded AC power outlet. Choose a location where the temperature remains between 50° and 95°F (10°-35°C).

## ! Caution

- Avoid placing your machine in a high-traffic area.
- Avoid placing your machine on the carpet.
- Do not place near heaters, air conditioners, water, chemicals, or refrigerators.
- Do not expose the machine to direct sunlight, excessive heat, moisture, or dust.
- Do not connect your machine to electrical outlets controlled by wall switches or automatic timers.
- Disruption of power can wipe out information in the machine's memory.
- Do not connect your machine to electrical outlets on the same circuit as large appliances or other equipment that might disrupt the power supply.
- Avoid interference sources, such as speakers or the base units of cordless phones.

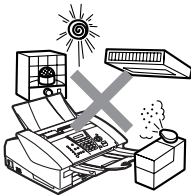

# Quick Reference Guide

## Sending faxes

### Automatic Transmission

- 1 If it is not illuminated in green, press  (**Fax**).
- 2 Load your document.
- 3 Enter the fax number using One-Touch, Speed-Dial, Search or the dial pad.
- 4 Press **Black Start** or **Color Start**.

## Storing numbers

### Storing One-Touch Dial numbers

- 1 Press **Menu/Set, 2, 3, 1**.
- 2 Press the One-Touch key where you want to store the number.



To access a One-Touch number that is shown in a black square on the control panel, hold down **Shift** as you press the One-Touch key.

- 3 Enter a number (up to 20 digits), and then press **Menu/Set**.
- 4 Enter a name up to 15 characters (or leave it blank), and then press **Menu/Set**.
- 5 Press **Stop/Exit**.

## Storing Speed-Dial numbers

- 1 Press **Menu/Set, 2, 3, 2**.
- 2 Using the dial pad, enter a two-digit Speed-Dial location number, and then press **Menu/Set**.
- 3 Enter a number (up to 20 digits), and then press **Menu/Set**.
- 4 Enter a name up to 15 characters (or leave it blank), and then press **Menu/Set**.
- 5 Press **Stop/Exit**.

## Dialing operations

### One-Touch Dialing/ Speed-Dialing

- 1 If it is not illuminated in green, press  (**Fax**).
- 2 Load your document.
- 3 Press the One-Touch key of the number you want to call.



To dial a One-Touch number that is shown in a black square on the control panel, hold down **Shift** as you press the One-Touch key.

—OR—

Press **Search/Speed Dial**, press #, and then press the two-digit Speed-Dial number.

- 4 Press **Black Start** or **Color Start**.

### Using Search

- 1 If it is not illuminated in green, press  (**Fax**).
- 2 Load your document.
- 3 Press **Search/Speed Dial**, and then enter the first letter of the name you're looking for.
- 4 Press ◀ or ▶ to search the memory.
- 5 Press **Black Start** or **Color Start**.

## Making copies

- 1 Press  (**Copy**) to illuminate it in green.
- 2 Load your document.
- 3 Press **Black Start** or **Color Start**.

# Table of Contents

## 1

<b>Introduction .....</b>	<b>1-1</b>
Using this Guide .....	1-1
Finding information.....	1-1
Symbols used in this Guide.....	1-1
Control panel overview .....	1-2
Turning the machine on and off.....	1-6
On/Off Setting.....	1-6
Load documents .....	1-8
Using the automatic document feeder (ADF) .....	1-8
Recommended environment .....	1-8
About paper .....	1-10
Recommended Paper.....	1-10
Handling and using special paper .....	1-11
Paper type and size for each operation.....	1-12
Paper weight, thickness and capacity .....	1-13
Paper capacity of the output paper tray .....	1-13
Printable area .....	1-14
How to load paper, envelopes and post cards .....	1-15
To load paper or other media .....	1-15
To load envelopes .....	1-17
To load post cards.....	1-18
About fax machines.....	1-19
Custom features .....	1-19
Do you have Voice Mail on the phone line? .....	1-19
Why should there be problems?.....	1-19
How can you avoid possible problems? .....	1-19
Fax tones and handshake .....	1-20
ECM (Error Correction Mode).....	1-21

## 2

<b>Getting started .....</b>	<b>2-1</b>
Initial Setup.....	2-1
Setting the Date and Time.....	2-1
Setting Tone and Pulse dialing mode.....	2-1
Setting the Station ID.....	2-2
General Setup .....	2-3
Setting the Mode Timer	
(MFC-3240C and MFC-3340CN only).....	2-3
Setting the Mode Timer	
(FAX-1840C and FAX-1940CN only) .....	2-3
Setting the Paper Type .....	2-4
Setting the Paper Size .....	2-4

Setting the Ring Volume .....	2-5
Setting the Beeper Volume .....	2-5
Setting the Speaker Volume .....	2-6
Setting the Handset Volume (FAX-1840C and FAX-1940CN only) .....	2-7
Choosing the Handset Volume (For Volume Amplify) (FAX-1840C and FAX-1940CN only) .....	2-8
Setting Volume Amplify (FAX-1840C and FAX-1940CN only) .....	2-9
Turning on Automatic Daylight Savings Time .....	2-10
Setting the LCD Contrast .....	2-10
<b>Setup Send .....</b>	<b>3-1</b>
How to enter Fax mode .....	3-1
How to dial .....	3-1
Manual dialing .....	3-1
One-Touch dialing .....	3-2
Speed-Dialing .....	3-2
Search .....	3-3
Fax Redial .....	3-3
How to Fax (B&W and Color) .....	3-4
Color fax transmission .....	3-4
Faxing from the ADF .....	3-4
Automatic transmission .....	3-5
Manual transmission .....	3-5
Sending a fax at the end of a conversation .....	3-6
Out of Memory message .....	3-6
Basic sending operations .....	3-7
Sending faxes using multiple settings .....	3-7
Contrast .....	3-7
Fax Resolution .....	3-8
Dual Access (Not available for color faxes) .....	3-9
Real Time Transmission .....	3-10
Checking job status .....	3-11
Canceling a fax in progress .....	3-11
Canceling a scheduled job .....	3-11
Advanced sending operations .....	3-12
Broadcasting (Not available for color faxes) .....	3-12
Overseas Mode .....	3-13
Delayed Fax (Not available for color faxes) .....	3-14
Setting up Polled Transmit (Not available for color faxes) .....	3-15
Delayed Batch Transmission (Not available for color faxes) .....	3-16

<b>Setup Receive .....</b>	<b>4-1</b>
Basic receiving operations	
(FAX-1840C, MFC-3240C and MFC-3340CN only) .....	4-1
Choosing the Receive Mode .....	4-1
To select or change your Receive Mode .....	4-2
Setting the Ring Delay .....	4-2
Basic receiving operations (FAX-1940CN only) .....	4-3
Choosing the Receive Mode .....	4-3
To select or change your Receive Mode .....	4-4
Setting the Ring Delay .....	4-5
Setting Toll Saver (Msg Ctr mode) .....	4-6
Setting the F/T Ring Time (Fax/Tel mode only) .....	4-7
Setting the Fax/Tel Announcement	
(FAX-1940CN only) .....	4-7
Easy Receive (MFC-3240C and MFC-3340CN only) ...	4-8
Easy Receive (FAX-1840C and FAX-1940CN only) ...	4-9
Printing a reduced incoming fax (Auto Reduction)....	4-10
Receiving a fax at the end of a conversation.....	4-10
Printing a fax from the memory .....	4-10
Polling .....	4-11
Setting up Polling Receive .....	4-11
Setting up Sequential Polling Receive .....	4-11

<b>Quick-Dial numbers and dialing options .....</b>	<b>5-1</b>
Storing numbers for easy dialing .....	5-1
Storing One-Touch Dial numbers .....	5-1
Storing Speed-Dial numbers .....	5-2
Changing One-Touch and Speed-Dial numbers .....	5-3
Setting up Groups for Broadcasting .....	5-4
Dialing options .....	5-6
Access codes and credit card numbers.....	5-6
Pause .....	5-6
Tone or Pulse .....	5-7
Telephone (voice) operations	
(FAX-1840C and FAX-1940CN only) .....	5-8
How to dial.....	5-8
Making a telephone call.....	5-8
Answering calls with the Speaker Phone	
(FAX-1940CN only) .....	5-9
Hold (FAX-1840C and FAX-1940CN only) .....	5-9



## 6

<b>Remote Fax Options (Not available for color faxes) .....</b>	<b>6-1</b>
Setting up Fax Forwarding.....	6-1
Programming your pager number.....	6-2
Setting Fax Storage .....	6-3
Setting PC Fax Receive (MFC-3340CN only) .....	6-3
Turning off Remote Fax Options.....	6-4
Setting your Remote Access Code.....	6-5
Remote Retrieval .....	6-6
Using your Remote Access Code.....	6-6
Remote commands.....	6-7
Retrieving fax messages .....	6-10
Changing your Fax Forwarding number .....	6-10

## 7

<b>Message Center (FAX-1940CN only) .....</b>	<b>7-1</b>
Message Center mode .....	7-1
Setting up the Message Center .....	7-1
Recording Message Center Outgoing Message .....	7-2
Listening to Outgoing Message (OGM) .....	7-3
Erasing Outgoing Message (OGM) .....	7-3
Activating Message Center mode.....	7-3
Message indicator.....	7-4
Playing voice messages .....	7-4
Printing a fax message .....	7-5
Erasing incoming messages .....	7-5
To erase voice messages individually .....	7-5
To erase messages all at once.....	7-6
Setting Maximum Time for incoming messages .....	7-6
Setting Toll Saver .....	7-6
ICM Recording Monitor.....	7-7
Recording a conversation .....	7-7
Record Fax/Tel Outgoing Announcement (F/T OGM) ...	7-7

## 8

<b>Printing reports .....</b>	<b>8-1</b>
Fax settings and activity .....	8-1
Customizing the Transmission Verification Report .....	8-1
Setting the Journal Period .....	8-2
Printing reports .....	8-3
How to print a report.....	8-3

## 9

<b>Making copies .....</b>	<b>9-1</b>
Using the machine as a copier .....	9-1
Enter Copy mode.....	9-1
Making a single copy .....	9-2
Making multiple copies .....	9-2

Stop copying.....	9-2
Using the temporary Copy keys (Temporary settings) .....	9-3
Increasing copy speed or quality .....	9-4
Changing the temporary copy settings .....	9-5
Enlarging or reducing the image copied .....	9-6
Setting paper type .....	9-7
Setting paper size.....	9-8
Adjusting brightness .....	9-8
Adjusting contrast.....	9-9
Sorting copies (FAX-1940CN and MFC-3340CN only) .....	9-9
Making N in 1 copies (Page Layout) .....	9-10
Changing the default copy settings .....	9-12
Increasing copy speed or quality .....	9-12
Adjusting brightness .....	9-12
Adjusting contrast.....	9-12
Adjusting color saturation .....	9-13
Out of Memory message .....	9-13
Legal limitations.....	9-14

## 10

<b>Walk-Up PhotoCapture Center™ (MFC-3340CN only) .....</b>	<b>10-1</b>
Introduction.....	10-1
PhotoCapture Center™ requirements.....	10-2
Getting started .....	10-3
Printing the Index (Thumbnails).....	10-5
Printing images.....	10-6
DPOF printing.....	10-8
Changing the default settings.....	10-9
Increasing print speed or quality .....	10-9
Setting the paper & size .....	10-9
Adjusting brightness .....	10-10
Adjusting contrast.....	10-10
Color enhancement (True2Life®).....	10-10
Cropping.....	10-12
Borderless .....	10-12
Understanding the Error Messages.....	10-13
Using PhotoCapture Center™ from your PC.....	10-14
Using PhotoCapture Center™ for scanning documents .....	10-14

## 11

<b>Important information .....</b>	<b>11-1</b>
Standard telephone and FCC Notices These notices are in effect on models sold and used in the United States only.....	11-1

Federal Communications Commission (FCC)	
Declaration of Conformity (USA only).....	11-3
Important .....	11-4
Industry Canada Compliance Statement	
(Canada only) .....	11-4
For your safety.....	11-4
LAN connection	
(FAX-1940CN and MFC-3340CN only) .....	11-4
International ENERGY STAR® Compliance Statement ...	11-5
Important safety instructions.....	11-6
Trademarks.....	11-8

## 12

<b>Troubleshooting and routine maintenance .....</b>	<b>12-1</b>
Troubleshooting .....	12-1
Error messages .....	12-1
Document Jam.....	12-5
Document is jammed inside the front of	
the machine.....	12-5
Printer jam or paper jam .....	12-6
Paper is jammed inside the paper tray .....	12-6
Paper is jammed inside the machine.....	12-7
If you are having difficulty with your machine .....	12-9
Compatibility .....	12-14
How to improve print quality .....	12-15
Cleaning the print head.....	12-15
Checking the print quality .....	12-16
Checking the printing alignment .....	12-18
Checking the ink volume.....	12-19
Packing and shipping the machine .....	12-20
Routine maintenance.....	12-23
Cleaning the Scanner.....	12-23
Cleaning the machine Printer Platen .....	12-24
Replacing the ink cartridges .....	12-25

## A

<b>Appendix A .....</b>	<b>A-1</b>
Setting up telephone services.....	A-1
Distinctive Ring.....	A-1
What does your telephone company's	
‘Distinctive Ring’ do? .....	A-1
What does Brother’s ‘Distinctive Ring’ do?.....	A-2
Do you have Voice Mail? .....	A-2
Before you choose the ring pattern to register .....	A-3
Registering the Distinctive Ring pattern.....	A-4
Turning off the Distinctive Ring.....	A-4

Caller ID.....	A-5
Viewing Caller ID List .....	A-6
Printing Caller ID List.....	A-6
Advanced receiving operations .....	A-7
Operation from extension telephones.....	A-7
Fax/Tel mode when power key is On .....	A-8
Fax/Tel mode when power key is Off .....	A-8
Using a cordless external handset .....	A-9
Changing the remote codes .....	A-9
Connecting an external device to your machine.....	A-10
Connecting an external telephone.....	A-10
Connecting an external telephone answering	
device (TAD) .....	A-11
Sequence .....	A-11
Connections .....	A-12
Recording outgoing message (OGM) on	
an external TAD .....	A-13
Special line considerations .....	A-14
Roll over phone lines.....	A-14
Two-line phone system .....	A-14
Converting telephone wall outlets .....	A-15
Installing machine, external two-line TAD and	
two-line telephone .....	A-16
Multi-line connections (PBX) .....	A-17
If you are installing the machine to work	
with a PBX.....	A-17
Custom features on your phone line.....	A-17

## B

<b>Appendix B .....</b>	<b>B-1</b>
On-screen programming.....	B-1
Menu table.....	B-1
Memory storage.....	B-1
Navigation keys .....	B-2
Entering Text .....	B-12
Inserting spaces .....	B-12
Making corrections .....	B-12
Repeating letters .....	B-12
Special characters and symbols.....	B-13

## G

<b>Glossary .....</b>	<b>G-1</b>
-----------------------	------------

<b>Specifications .....</b>	<b>S-1</b>
Product description .....	S-1
General .....	S-1
Print media.....	S-3
Copy .....	S-3
PhotoCapture Center™ (MFC-3340CN only) .....	S-4
Fax.....	S-5
Scanner (MFC-3240C and MFC-3340CN only).....	S-6
Printer .....	S-7
Interfaces .....	S-8
Computer requirements .....	S-8
Consumable items .....	S-9
Network (LAN)	
(FAX-1940CN and MFC-3340CN only) .....	S-10
Optional External Wireless Print/Scan Server	
(NC-2200w) (MFC-3240C and MFC-3340CN only)....	S-11
<b>Index .....</b>	<b>I-1</b>
<b>Remote Retrieval Access card (FAX-1940CN only) .....</b>	<b>R-1</b>
<b>Remote Retrieval Access card</b>	
<b>(FAX-1840C, MFC-3240C and MFC-3340CN only) .....</b>	<b>R-3</b>

# 1 Introduction

## Using this Guide

Thank you for buying a Brother fax machine or Multi-Function Center (MFC). Your machine is simple to use, with LCD screen instructions to guide you through programming it. You can make the most of your machine by reading through this Guide.

## Finding information

---





All the chapter headings and subheadings are listed in the Table of Contents. You will be able to find information about a specific feature or operation by checking the Index at the back of this Guide.

## Symbols used in this Guide

---

Throughout this Guide you will see special symbols alerting you to important warnings, notes and actions. To make things clearer and to help you press the correct keys, we used special fonts and added some of the messages that will appear in the LCD.

- |                |   |
|----------------|---|
| <b>Bold</b>    | Bold typeface identifies specific keys on the machine control panel.                |
| <i>Italics</i> | Italicized typeface emphasizes an important point or refers you to a related topic. |
| Courier New    | Courier New type face identifies the messages on the LCD of the machine.            |

-  Warnings inform you what to do to avoid possible personal injury.
-  Cautions specify procedures you must follow or avoid to prevent possible damage to the machine.
-  Notes tell you how you should respond to a situation that may arise or give tips about how the current operation works with other features.
-  Improper Setup alerts you to devices and operations that are not compatible with the machine.

# Control panel overview

MFC-3240C

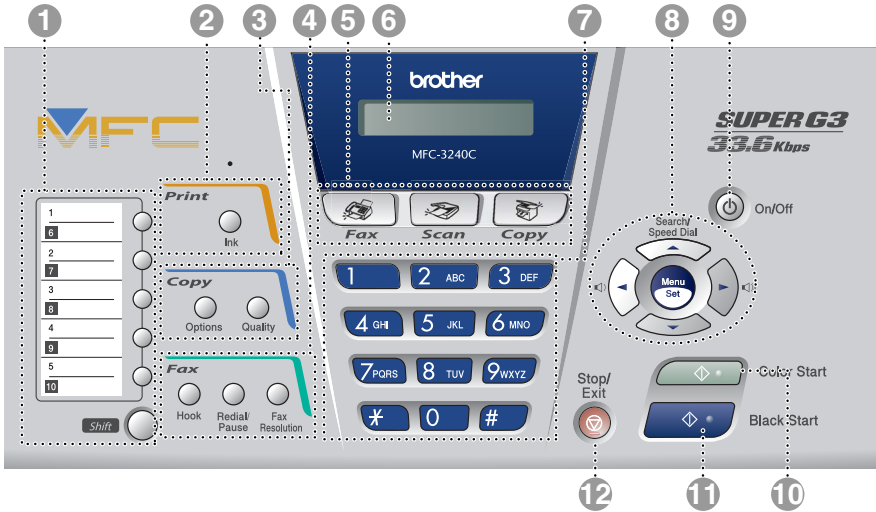

MFC-3340CN

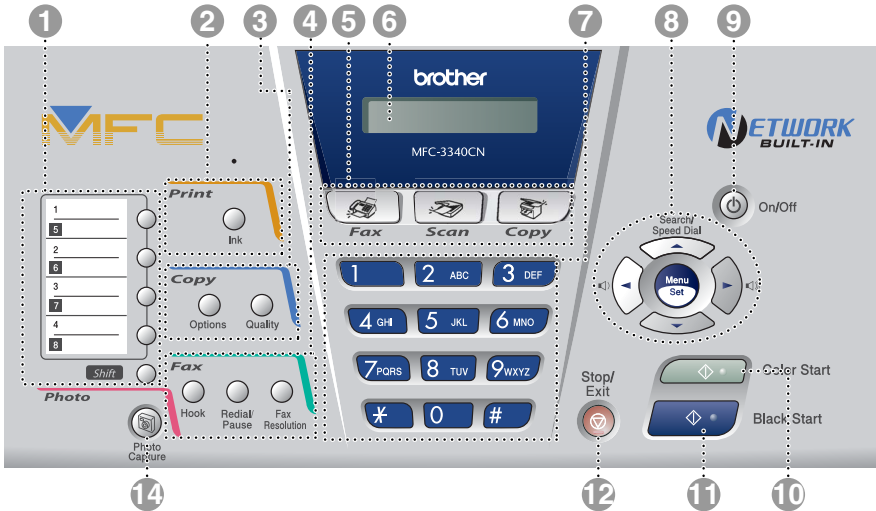

## FAX-1840C

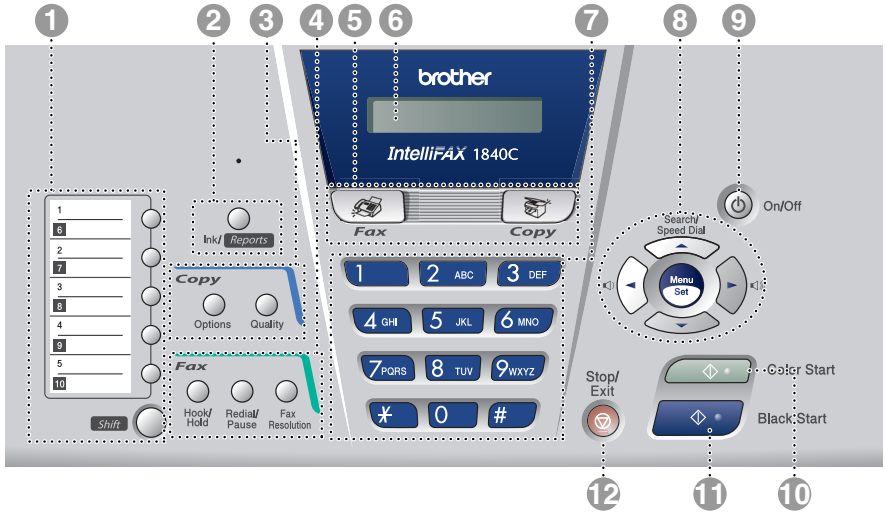

## FAX-1940CN

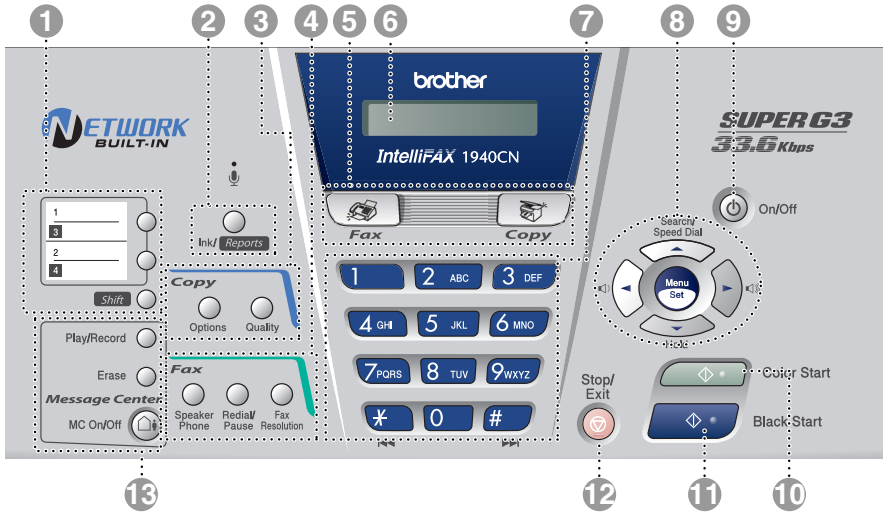



### 1 One-Touch keys

These keys give you instant access to previously stored Quick-Dial numbers.

#### Shift

To access a One-Touch number in a black square on the control panel, hold down this key as you press the One-Touch key.

### 2 Ink (MFC-3240C and MFC-3340CN only)

Lets you clean the print head, check the print quality, and check the available ink volume.

#### Ink/Reports (FAX-1840C and FAX-1940CN only)

Lets you clean the print head, check the print quality, and check the available ink volume.

—OR—

Lets you access the Reports menu if pressed while holding it down with the **shift** key.

### 3 Copy keys

#### Options

You can quickly and easily select temporary settings for copying.

#### Quality

Use this key for temporary copy settings.

### 4 Fax and telephone keys

#### Hook/Hold (FAX-1840C only)

Press before dialing if you want to make sure a fax machine will answer, and then press **Black Start** or **Color Start**.

—OR—

Lets you place telephone calls on hold.

#### Hook (MFC-3240C and MFC-3340CN only)

Press before dialing if you want to make sure a fax machine will answer, and then press **Black Start** or **Color Start**.

#### Speaker Phone (FAX-1940CN only)

Lets you speak to another party without lifting the handset.

—OR—

Press before dialing if you want to make sure a fax machine answers, and then press **Black Start** or **Color Start**.

#### Redial/Pause

Redials the last number you called. It also inserts a pause in quick-dial numbers.

#### Fax Resolution

Adjusts the resolution when you send a fax.

#### ● Microphone 🎤 (FAX-1940CN only)

Picks up your voice when you speak to another party using Speaker Phone.

### 5 Mode keys:



**Fax**

Lets you access Fax mode.



**Scan (MFC-3240C and MFC-3340CN only)**

Lets you access Scan mode.



**Copy**

Lets you access Copy mode.

### 6 Liquid Crystal Display (LCD)

Displays messages on the screen to help you set up and use your machine.

## 7 Dial Pad

Use these keys to dial telephone and fax numbers and as a keyboard for entering information into the machine.

The # key lets you temporarily switch the dialing mode during a telephone call from Pulse to Tone.

## 8 Navigation keys:

### Menu/Set

The same key is used for Menu and Set operations.

Lets you access the Menu to program and store your settings in the machine.



You can press these keys to adjust the volume.

### ▲ Search/Speed Dial

Lets you look up numbers that are stored in the dialing memory. It also lets you dial stored numbers by pressing # and a two-digit number.



Press to scroll backward to a menu selection.



Press to scroll through the menus and options.

### ▼ Hold (FAX-1940CN only)

Lets you place telephone calls on hold.

## 9 On/Off

You can turn the machine on or off. Also, you can set the On/Off Setting so the machine can still receive faxes when it is turned off.

## 10 Color Start

Lets you start sending faxes or making copies in full color.

Also for MFC-3240C and MFC-3340CN, lets you start a scanning operation (in color or mono, depending on the scanning setting on your PC).

## 11 Black Start

Lets you start sending faxes or making copies in black and white.

Also for MFC-3240C and MFC-3340CN, lets you start a scanning operation (in color or mono, depending on the scanning setting on your PC).

## 12 Stop/Exit

Stops an operation or exits from the menu.

## 13 Message Center keys (FAX-1940CN only)

### MC On/Off

Lets you activate the Message Center and will blink if you have new messages.

### Play/Record

Lets you listen to voice messages stored in memory. Also, lets you record telephone calls.

### Erase

Lets you delete voice messages, all fax messages or all messages.

## 14 PhotoCapture (MFC-3340CN only)

Lets you access the PhotoCapture Center™ mode.

## Turning the machine on and off

---

When the machine is idle, you can turn it on and off by pressing the **On/Off** key. In Off mode, no machine operations will be available. Even if you turned the machine off, it will periodically clean the print head to preserve print quality.

### Turning the machine off

Press and hold down the **On/Off** key until the LCD shows:

Shutting Down

The LCD light will go off.

### Turning the machine on

Press and hold down the **On/Off** key until the LCD shows:

Please Wait

The LCD will show the date and time (Fax mode).



Even in Off mode, you can receive fax and telephone calls by customizing the **On/Off** key as explained below.



If you have connected an external telephone or TAD, it is always available.

## On/Off Setting

---

You can customize the machine's **On/Off** key. The default setting is `Fax Receive:Off`. Your machine will not work when it is switched Off, but it will purge the ink head periodically. If you turn this setting to `Fax Receive:On`, you can receive faxes or calls even when the machine is switched Off.

- 1 Press **Menu/Set**, **1**, **6**.
- 2 Press **▲** or **▼** to select `On` (or `Off`).
- 3 Press **Menu/Set**.
- 4 Press **Stop/Exit**.

6.On/Off Setting

On/Off Setting	Receive Mode	Available Operations
Fax Receive:Off (default)	—	No machine operations will be available.
Fax Receive:On	Fax Only External TAD (Except FAX-1940CN)	Fax Receive (automatically), Easy Receive, Delayed Fax* <sup>1</sup> , Remote Fax Options* <sup>1</sup> , Remote Retrieval* <sup>1</sup> ■ (FAX-1840C and FAX-1940CN only) You can receive telephone calls by lifting the handset.
	MC:Msg. Ctr. (FAX-1940CN only)	Fax Receive (automatically), Recording of incoming messages, Fax Detect, Delayed Fax* <sup>1</sup> , Remote Fax Options* <sup>1</sup> , Remote Retrieval* <sup>1</sup> ■ You can receive telephone calls by lifting the handset.
	Manual Fax/Tel* <sup>2</sup>	Delayed Fax* <sup>1</sup> , Easy Receive ■ (FAX-1840C and FAX-1940CN only) You can receive telephone calls by lifting the handset.

\*<sup>1</sup> Should be set before you switch off the machine.

\*<sup>2</sup> (MFC-3240C and MFC-3340CN only) You can not receive a fax automatically even if you have set the receive mode to Fax/Tel.



The external telephone is always available.

# Load documents

You can send a fax, make copies, and scan from the ADF (automatic document feeder).

## Using the automatic document feeder (ADF)

---

The ADF can hold up to 20 pages and feeds each sheet individually. Use standard 20 lb (80 g/m<sup>2</sup>) paper and always fan the pages before putting them in the ADF.

### Recommended environment

Temperature: 68° - 86° F (20° - 30° C)

Humidity: 50% - 70%

Paper: 20 lb LTR (80 g/m<sup>2</sup> A4)

 DO NOT use paper that is curled, wrinkled, folded, ripped, stapled, paper clipped, pasted or taped.

DO NOT use cardboard, newspaper or fabric.

- Make sure documents written with ink are completely dry.
- Documents to be faxed must be from 3.5 to 8.5 inches (8.9 to 21.6 cm) wide and 5 to 14 inches (12.7 to 35.6 cm) long.

- 1 Fan the pages well and stagger them at an angle.
- 2 Open the document support (1) and the document tray (2), then pull out the extension (3).

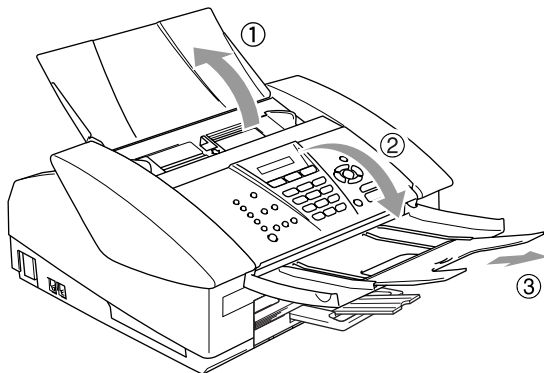

- 3 Put the documents **face down, top edge first** in the ADF until you feel them touch the feed roller (4).
- 4 Adjust the paper guides to fit the width of your documents (5).

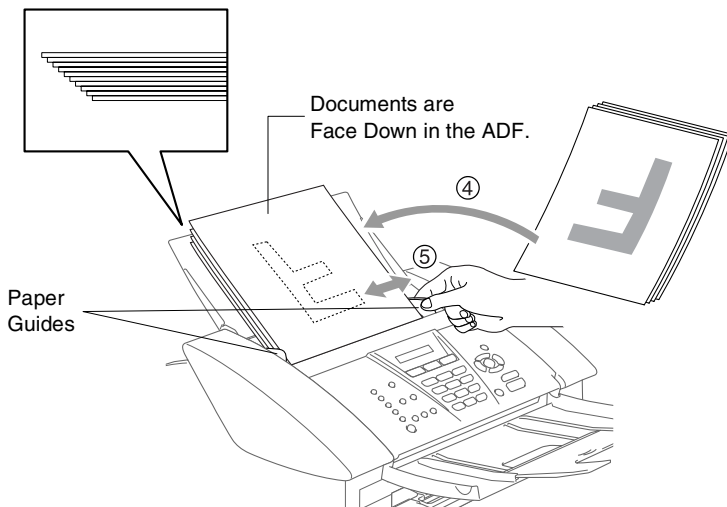

**!** **DO NOT** pull on the document while it is feeding.

# About paper

The print quality can be affected by the type of paper you use in the machine.

To get the best print quality for the settings you've chosen, always set the Paper Type to match the type of paper you load.

You can use plain paper, inkjet paper (coated paper), glossy paper, transparencies and envelopes.

We recommend testing various paper types before purchasing large quantities.

For best results, use the recommended paper.



- When you print on inkjet paper (coated paper), transparencies and glossy paper, be sure to select the proper media in the “Basic” tab of the printer driver or in the Paper Type setting of the menu (**Menu/Set, 1, 2**).
- When you print on Brother glossy paper, load the instruction sheet included with the glossy paper in the paper tray first, and then place the glossy paper on the instruction sheet.
- When you use transparencies or glossy paper, remove each sheet immediately to prevent smudging or paper jams.
- Avoid touching the printed surface of the paper immediately after printing; the surface may not be completely dry and may stain your fingers.

## Recommended Paper

---

To get the best print quality, we suggest using Brother paper. (See table below.)

We recommend using “3M Transparency Film” when you print on transparencies.

### Brother Paper

Paper Type	Item
Letter Plain	BP60PL
Letter Glossy	BP60GLL
Letter Inkjet (Photo Matte)	BP60ML

## Handling and using special paper

---

- Store paper in its original packaging, and keep it sealed. Keep the paper flat and away from moisture, direct sunlight and heat.
- The coated side of glossy paper is shiny. Avoid touching the shiny (coated) side. Load glossy paper with the shiny side facing down.
- Avoid touching either side of transparencies, because they absorb water and perspiration easily, and this may cause decreased output quality. Transparencies designed for laser printers/copiers may stain your next document. Use only transparencies recommended for inkjet printing.

⊘ Do not use paper:

- that are damaged, curled, wrinkled, or irregularly shaped

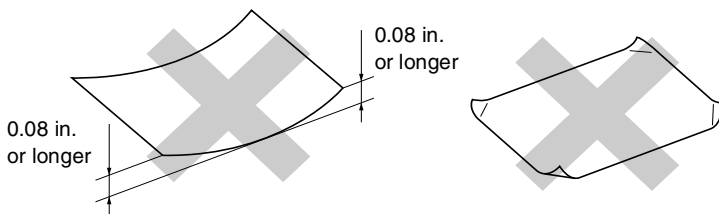

- that are extremely shiny or highly textured
- that were previously printed by a printer
- that cannot be arranged uniformly when stacked
- that are made with a short grain



## Paper type and size for each operation

Paper Type	Paper Size	Usage				
		Fax	Copy	PhotoCapture (MFC-3340CN only)	Printer	
Cut Paper	Letter	Yes	Yes	Yes	Yes	
	A4	Yes	Yes	Yes	Yes	
	Legal	Yes	Yes	-	Yes	
	Executive	-	-	-	Yes	
	JIS B5	-	-	-	Yes	
	A5	-	Yes	-	Yes	
	A6	-	-	-	Yes	
	Cards	Photo	-	Yes	Yes	Yes
		Photo L	-	-	-	Yes
		Photo 2L	-	-	Yes	Yes
Index Card		-	-	-	Yes	
Post Card 1		-	-	-	Yes	
Post Card 2 (Double)		-	-	-	Yes	
Envelopes	C5 Envelope	-	-	-	Yes	
	DL Envelope	-	-	-	Yes	
	COM-10	-	-	-	Yes	
	Monarch	-	-	-	Yes	
	JE4 Envelope	-	-	-	Yes	
	Transparencies	Letter	-	Yes	-	Yes
A4		-	Yes	-	Yes	

## Paper weight, thickness and capacity

Paper Type		Weight	Thickness	No. of sheets
Cut Paper	Plain Paper	17 to 32 lb (64 to 120 g/m <sup>2</sup> )	0.003" to 0.006" (0.08 to 0.15 mm)	100*
	Inkjet Paper	17 to 53 lb (64 to 200 g/m <sup>2</sup> )	0.003" to 0.01" (0.08 to 0.25 mm)	20
	Glossy Paper	Up to 58 lb (Up to 220 g/m <sup>2</sup> )	Up to 0.01" (Up to 0.25 mm)	20
Cards	Photo Card	Up to 64 lb (Up to 240 g/m <sup>2</sup> )	Up to 0.01" (Up to 0.28 mm)	20
	Index Card	Up to 32 lb (Up to 120 g/m <sup>2</sup> )	Up to 0.006" (Up to 0.15 mm)	30
	Post Card	Up to 53 lb (Up to 200 g/m <sup>2</sup> )	Up to 0.01" (Up to 0.23 mm)	30
Envelopes		20 to 25 lb (75 to 95 g/m <sup>2</sup> )	Up to 0.02" (Up to 0.52 mm)	10
Transparencies		-	-	10

\* Up to 50 sheets for Legal size paper (20 lb).

\* Up to 100 sheets of 20 lb.

## Paper capacity of the output paper tray

Output Paper Tray	<p>Up to 50 sheets of 20 lb (Letter)</p> <ul style="list-style-type: none"> <li>■ Transparencies or glossy paper must be picked up from the output paper tray one page at a time to avoid smudging.</li> <li>■ Legal paper cannot be stacked on the output paper tray.</li> </ul>
-------------------	---

## Printable area

The printable area depends on the settings in the application you are using. The figures below show the unprintable areas on cut sheet paper and envelopes.

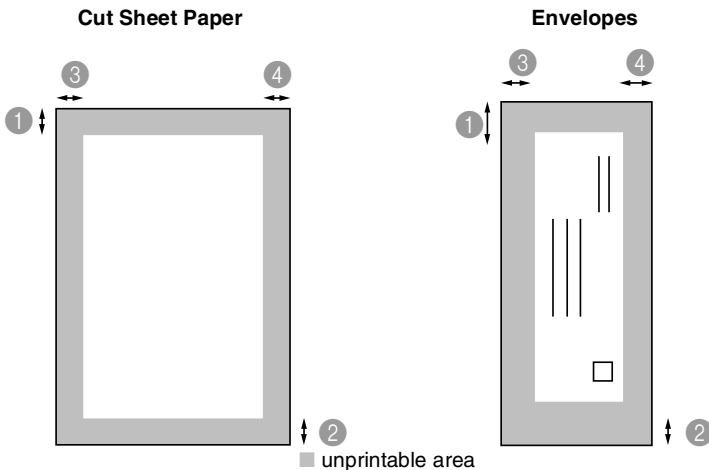

	① Top	② Bottom	③ Left	④ Right
Cut Sheet	0.12 in. (0 in.)* <sup>1</sup>	0.12 in. (0 in.)* <sup>1</sup>	0.12 in. (0 in.)* <sup>1</sup>	0.12 in. (0 in.)* <sup>1</sup>
Envelopes	0.47 in.	0.94 in.	0.12 in.	0.12 in.



\*1 When you set the Borderless feature to On.

Printable area depends on the Printer driver settings.

The figures above are approximate and the printable area may vary depending on the type of cut sheet paper you are using.

# How to load paper, envelopes and post cards

## To load paper or other media

- 1 Pull the paper tray completely out of the machine and remove the output paper tray.

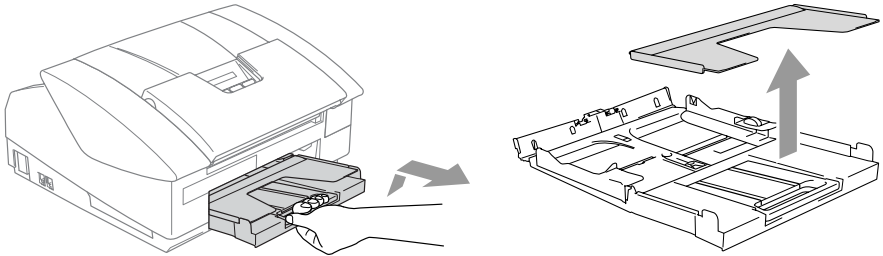

- 2 Press and slide the paper side guide to fit the paper width.

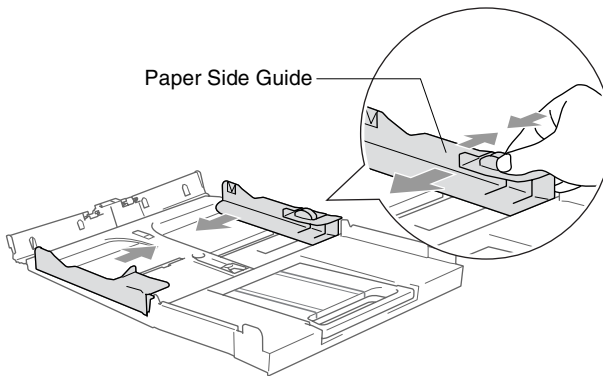

- 3 Pull out the paper support and unfold the paper support flap.

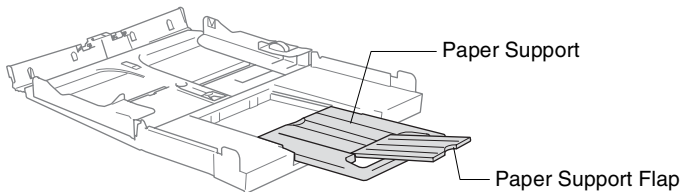

-  Use the paper support flap for Letter, Legal and A4.

- 4** Fan the stack of paper well to avoid paper jams and mis-feeds.

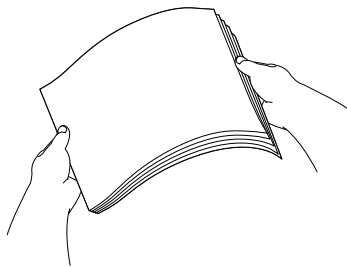

- 5** Gently insert the paper into the paper tray print side down and the leading edge (top of the paper) in first.

Check that the paper is flat in the tray and below the maximum paper mark.

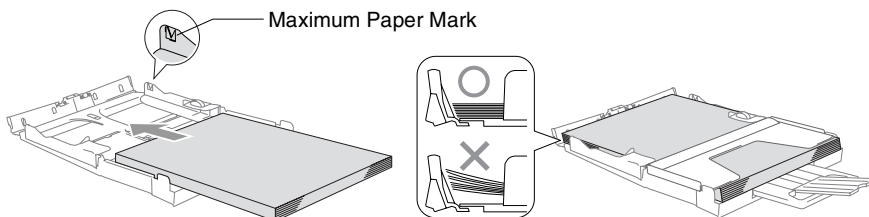

- Make sure the paper side guides touch the sides of the paper.

- Be careful that you do not push the paper in too far; it may lift at the back of the tray and cause feed problems.

- 6** Put the output paper tray back on and push the paper tray firmly back into the machine.

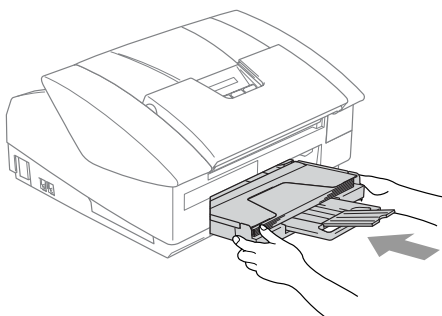

## To load envelopes

- Use envelopes that weigh from 20 to 25 lb.
- Some envelopes require margin settings in the application. Make sure you do a test print first.
- ⊘ To prevent possible damage to the feeding mechanism, do not use the types of envelopes shown below.

### DO NOT USE ENVELOPES:

- that are of a baggy construction
- that are embossed (have raised writing on them)
- that have clasps on them
- that are not sharply creased
- that are preprinted on the inside

#### ■ Glue

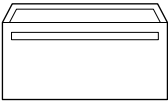

#### ■ Rounded flap

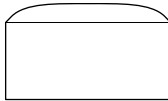

#### ■ Double flap

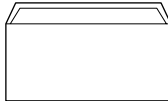

#### ■ Triangular flap

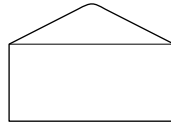

## How to load envelopes

- 1 Before loading, press the corners and sides of the envelopes to make them as flat as possible.

-  If the envelopes are 'double-feeding,' put one envelope in the paper tray at a time.

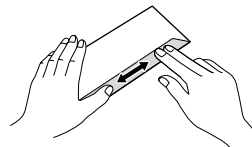
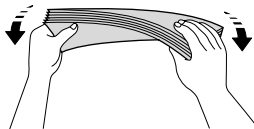
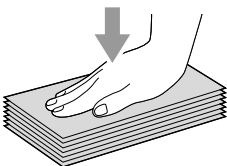

- 2 Insert the envelopes into the paper tray with the address side down and the leading edge (top of the envelopes) in first. Slide the paper side guide to fit the width of the envelopes.

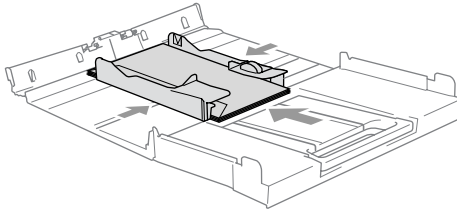

***If you have problems when printing on envelopes, try the following suggestions:***

- 1 Open the envelope flap.
- 2 Make sure the open flap is either to the side of the envelope or to the back edge of the envelope when printing.
- 3 Adjust the size and margin in your application.

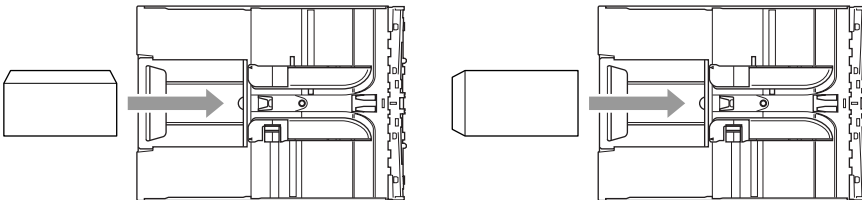

## **To load post cards**

- 1 Raise the paper stop and insert the post cards into the paper tray. Slide the paper side guide to fit the width of the post cards.

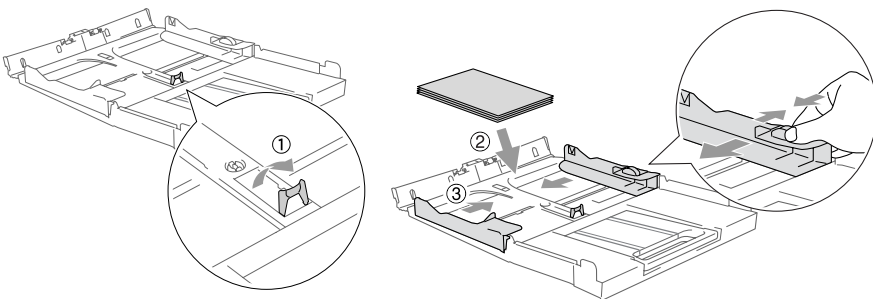

# About fax machines

## Custom features

---

### **Do you have Voice Mail on the phone line?**

If you have Voice Mail on the phone line where you will install your new machine, *there is a strong possibility that Voice Mail and the machine may conflict with each other while receiving incoming calls.*

### **Why should there be problems?**

Since both the machine and Voice Mail will pick up the call, after the number of rings you have set, each of them has the ability to keep the other from receiving calls.

For example, if Voice Mail is set to answer after two rings and your machine is set to answer after four, Voice Mail will stop your machine from receiving faxes.

If you set Voice Mail and the Brother machine to answer after the same number of rings, there is no way of knowing which one will answer first. It is important to remember that neither Voice Mail nor the machine can pass the call back to the other after the call has been answered.

### **How can you avoid possible problems?**

A very good way to avoid problems like the one mentioned, *is to get a second phone number on your present phone line.*

Many people with Voice Mail choose an alternative service, which is called "Distinctive Ring", and they are very satisfied with it.

(See *Distinctive Ring* on page A-1.)

Another way to avoid possible problems is to replace Voice Mail with an answering machine. Your Brother machine is designed to work with an answering machine or TAD (telephone answering device).

(See *Connecting an external telephone answering device (TAD)* on page A-11.)



## Fax tones and handshake

---

When someone is sending a fax, the machine sends fax calling tones (CNG tones). These are quiet, intermittent beeps every 4-seconds. You'll hear them after you dial and press **Black Start** or **Color Start** and they will continue for about 60 seconds after dialing. During that time, the sending machine must begin the "handshake", or connection, with the receiving machine.

Each time you use automatic procedures to send a fax, you are sending CNG tones over the phone line. You will soon learn to listen for these quiet beeps each time you answer a phone on your fax line, so you will know if you are receiving a fax message.

The receiving fax responds with fax receiving tones, which are loud, chirping sounds. A receiving fax chirps for about 40 seconds over the phone line, and the LCD shows *Receiving*.

If your machine is set to the Fax Only mode, it will answer every call automatically with fax receiving tones. If the other person hangs up, your machine will continue to send the "chirps" for about 40 seconds, and the LCD continues to show *Receiving*. To cancel receiving, press **Stop/Exit**.

The fax 'handshake' is the time in which the sending machine's CNG tones and the receiving machine's "chirps" overlap. This must be for at least 2 to 4 seconds, so both machines can understand how each is sending and receiving the fax. The handshake cannot begin until the call is answered, and the CNG tones only last for about 60 seconds after the number is dialed. So it is important for the receiving machine to answer the call in as few rings as possible.



When you have an external Telephone Answering Device (TAD) on your fax line, your TAD will decide the number of rings before the call is answered.

## **ECM (Error Correction Mode)**

---

The Error Correction Mode (ECM) is a way for the machine to check a fax transmission while it is in progress. If the machine detects errors during fax transmission, it resends the pages of the fax that had an error. ECM transmissions are only possible between fax machines that both have this feature. If they do, you may send and receive fax messages that are continuously being checked by the machine. Your machine must have enough memory for this feature to work.

# 2 Getting started

## Initial Setup

### Setting the Date and Time

---

When the machine is not in use it will display the date and time. If you set up the Station ID the date and time displayed by your machine will be printed on every fax you send. If there is a power failure, you may have to reset the date and time. No other settings will be affected.

- 1 Press **Menu/Set**, **0**, **2**. 2.Date/Time
- 2 Enter the last two digits of the year.  
Press **Menu/Set**.
- 3 Enter two digits for the month.  
Press **Menu/Set**.  
(For example, enter 09 for September, or 10 for October.)
- 4 Enter two digits for the day.  
Press **Menu/Set**. (For example, enter 06 for 6th.)
- 5 Enter the time in 24-Hour format.  
Press **Menu/Set**. (For example, enter 15:25 for 3:25 P.M.)
- 6 Press **Stop/Exit**.  
The LCD now shows the date and time whenever the machine is in Fax mode.

### Setting Tone and Pulse dialing mode

---

- 1 Press **Menu/Set**, **0**, **4**. 4.Tone/Pulse
- 2 Press **▲** or **▼** to select **Pulse** (or **Tone**).  
Press **Menu/Set**.
- 3 Press **Stop/Exit**.

## Setting the Station ID

---

You should store your name or company name and fax number so they print on all fax pages you send.

**1** Press **Menu/Set, 0, 3.**

3.Station ID

**2** Enter your fax number  
(up to 20 digits).

Press **Menu/Set.**

 You cannot enter a hyphen. To enter a space press ► once between numbers.

**3** Use the dial pad to enter your name (up to 20 characters).  
(See *Entering Text* on page B-12.)

Press **Menu/Set.**

**4** Press **Stop/Exit.**

 If the Station ID has already been programmed, the LCD will ask you to press **1** to make a change or **2** to exit without changing.

### NOTICE (For USA)

The Telephone Consumer Protection Act of 1991 makes it unlawful for any person to use a computer or electronic device to send any message via a telephone fax machine unless such messages clearly contain, in a margin at the top or bottom of each transmitted page, or on the first page of the transmission, the date and time it is sent and an identification of the business or other entity or other individual sending the message and the telephone number of the sending machines or such business, other entity or individual.

To program this information into your machine, see *Setting the Date and Time* on page 2-1 and *Setting the Station ID* on page 2-2.

# General Setup

## Setting the Mode Timer (MFC-3240C and MFC-3340CN only)

---

The machine has four temporary mode keys on the control panel: PhotoCapture (MFC-3340CN only), Fax, Scan and Copy. You can change the number of seconds or minutes the machine takes after the last Scan, Copy or PhotoCapture operation before it returns to Fax mode. If you select *Off*, the machine stays in the mode you used last.

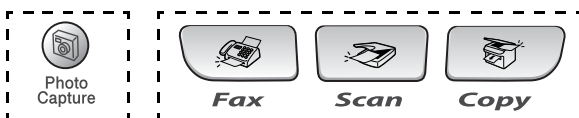

- 1 Press **Menu/Set**, **1**, **1**. 1.Mode Timer
- 2 Press **▲** or **▼** to select  
0 Sec, 30 Secs, 1 Min, 2 Mins, 5 Mins or *Off*.  
Press **Menu/Set**.
- 3 Press **Stop/Exit**.

## Setting the Mode Timer (FAX-1840C and FAX-1940CN only)

---

The machine has two temporary mode keys on the control panel: Fax and Copy. You can change the number of seconds or minutes the machine takes after the last Copy operation before it returns to Fax mode. If you select *Off*, the machine stays in the mode you used last.



- 1 Press **Menu/Set**, **1**, **1**. 1.Mode Timer
- 2 Press **▲** or **▼** to select  
0 Sec, 30 Secs, 1 Min, 2 Mins, 5 Mins or *Off*.
- 3 Press **Menu/Set**.
- 4 Press **Stop/Exit**.

## Setting the Paper Type

---

To get the best print quality, set the machine for the type of paper you are using.

**1** Press **Menu/Set**, **1**, **2**.

2.Paper Type

**2** Press **▲** or **▼** to select

Plain, Inkjet, Glossy or Transprncy.

Press **Menu/Set**.

**3** Press **Stop/Exit**.



The machine ejects paper with printed surfaces face up onto the paper tray in the front of the machine. When you use transparencies or glossy paper, remove each sheet immediately to prevent smudging or paper jams.

## Setting the Paper Size

---

You can use five sizes of paper for printing copies: Letter, Legal, A4, A5, and 4" x 6" and three sizes for printing faxes: Letter, Legal and A4. When you change the type of paper you load in the machine, you will need to change the setting for Paper Size at the same time so your machine can fit an incoming fax on the page.

**1** Press **Menu/Set**, **1**, **3**.

3.Paper Size

**2** Press **▲** or **▼** to select

Letter, Legal, A4, A5 or 4" x6".

Press **Menu/Set**.

**3** Press **Stop/Exit**.

## Setting the Ring Volume

---

You can turn the ring `Ring Volume:Off` or you can select the ring volume level.

**1** Press **Menu/Set, 1, 4, 1.**



1.Ring

**2** Press **▲** or **▼** to select  
Low, Med, High or Off.

Press **Menu/Set.**

**3** Press **Stop/Exit.**

—OR—

You can adjust the ring volume when your machine is idle (not being used). In Fax mode , press  or  to adjust the volume level. Every time you press these keys, the machine will ring so you can hear the active setting as the LCD shows it. The volume changes with each key press. The new setting will stay until you change it again.

## Setting the Beeper Volume

---

You can change the beeper volume. The default (factory) setting is `Beeper:Low`. When the beeper is on, the machine will beep when you press a key, make a mistake or after you send or receive a fax.

**1** Press **Menu/Set, 1, 4, 2.**

2.Beeper

**2** Press **▲** or **▼** to select your option.  
(Low, Med, High or Off)

Press **Menu/Set.**

**3** Press **Stop/Exit.**

## Setting the Speaker Volume

---

You can adjust the speaker volume.

**1** Press **Menu/Set**, **1**, **4**, **3**.

3.Speaker

**2** Press **▲** or **▼** to select  
Low, Med, High or Off.

Press **Menu/Set**.

**3** Press **Stop/Exit**.

—OR—

Press **Hook**, and then adjust the speaker volume by pressing **◀** or **▶**. The LCD shows the setting you are choosing. Each key press changes the volume to the next setting. The new setting will remain until you change it again.

*FAX-1940CN only*

When  (**Fax**) is illuminated you can also change the speaker volume in the following ways:

Press **Speaker Phone**, and then adjust the speaker volume by pressing **◀** or **▶**. The LCD shows the setting you are choosing. Each key press changes the volume to the next setting. The new setting will remain until you change it again.

—OR—

You can adjust the speaker volume while you are listening to your OGM (Outgoing Message) and ICMs (Incoming Messages) by pressing **◀** or **▶**.

 If you turn Incoming Recording Monitor to OFF (**Menu/Set**, **2**, **7**, **3**) the Speaker for screening calls will be disabled and you won't hear callers leaving messages. The volume for other operations can still be controlled using **◀** or **▶**.



## Setting the Handset Volume (FAX-1840C and FAX-1940CN only)

---

- 1 Press **Menu/Set, 1, 4, 4.**
- 2 Press ▼ to select **High** or **Low.**  
Press **Menu/Set.**
- 3 Press **Stop/Exit.**

4.Handset

—OR—

You can adjust the handset volume any time you are talking on the telephone. There are two handset volume levels, **Low** and **High**. The default setting is **Low**.



Press ◀ or ▶ to adjust the volume level. The LCD shows the setting you are choosing. The new setting will remain until you change it again.

## Choosing the Handset Volume (For Volume Amplify) (FAX-1840C and FAX-1940CN only)



---

Before you begin to use the machine, you must decide if you need to set the handset volume to `Volume Amplify:On` for a user who is hearing-impaired. The AMPLIFY volume level complies with FCC standards.



`Volume Amplify:Off`

This default setting is appropriate if *none* of the users are hearing-impaired. During a conversation, users can press  or  on the control panel to adjust the volume to `Low` or `High`. When the handset is replaced, the handset volume will remain until you change it again.



`Volume Amplify:On—Temporary`

This setting is appropriate if *some* of the users are hearing-impaired. During a conversation, users can press  or  on the control panel to adjust the volume to `Low`, `High` or `Volume Amplify`. When the handset is replaced, the handset volume returns to the default setting of `Low`.

`Volume Amplify:On—Permanent`

Choose `Volume Amplify:On—Permanent` if *all* of the users are hearing-impaired. During a conversation, users can press  or  on the control panel to adjust the volume to `Beeper:Low`, `Beeper:High` or `Volume Amplify`. When the handset is replaced, the handset volume returns to the default setting of `Volume Amplify`.



When you press  or  on the control panel to adjust the volume, the LCD shows the setting you are choosing. Each key press changes the volume to the next setting.



### WARNING

**It is important that you do NOT choose `Permanent` unless ALL the users are hearing-impaired.** Otherwise, the default setting of `Volume Amplify` may damage the hearing of some users.

## Setting Volume Amplify (FAX-1840C and FAX-1940CN only)

---

Please carefully read *Choosing the Handset Volume* on page 2-8 before you do the following steps:

- 1** Press **Menu/Set, 1, 4, 5.** 5.Volume Amplify
- 2** If *none* of the users are hearing-impaired, press ▲ or ▼ to select **Off**, and then press **Menu/Set** and go to Step 4.  
—OR—  
If *some* or *all* of the users are hearing-impaired, select **On**, and then press **Menu/Set**.
- 3** If all the users are hearing-impaired, press ▲ or ▼ to select **Permanent**, and then press **Menu/Set**.  
—OR—  
If only *some* of the users are hearing-impaired, select **Temporary**, and then press **Menu/Set**.
- 4** Press **Stop/Exit**.

## Turning on Automatic Daylight Savings Time

---

You can set the machine to change automatically for Daylight Savings Time. It will reset itself forward one hour in the Spring and backward one hour in the Fall. Make sure you have set the correct day and time in the `Date/Time` setting.

- 1** Press **Menu/Set**, **1**, **5**.
- 2** Press **▲** or **▼** to select `On` (or `Off`).  
Press **Menu/Set**.
- 3** Press **Stop/Exit**.

5.Auto Daylight

## Setting the LCD Contrast

---



You can adjust the LCD contrast for a sharper and more vivid display. If you are having difficulty reading the LCD from your position, try changing the contrast setting for improved viewing.

- 1** Press **Menu/Set**, **1**, **7**.
- 2** Press **▲** or **▼** to select `Light` or `Dark`.  
Press **Menu/Set**.
- 3** Press **Stop/Exit**.

7.LCD Contrast

# 3 Setup Send

## How to enter Fax mode

Before sending faxes, make sure  (**Fax**) is illuminated in green. If not, press  (**Fax**) to enter Fax mode. The default setting is Fax.

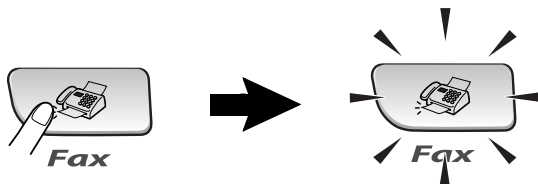

## How to dial

You can dial in any of the following ways.

### Manual dialing

---

Press all of the digits of the phone or fax number.



## One-Touch dialing

Press the One-Touch Key of the location you want to call. (See *Storing One-Touch Dial numbers* on page 5-1.)

To dial One-Touch numbers in the black square, hold down **Shift** as you press the One-Touch Key.

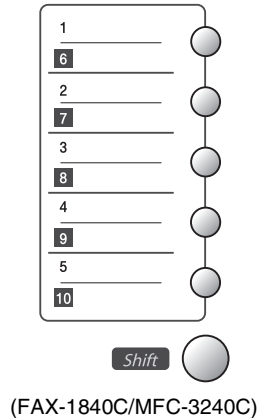
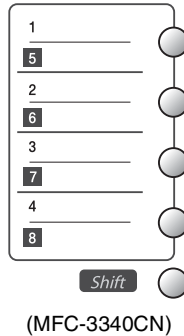
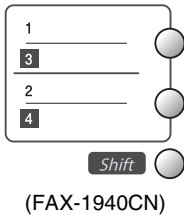

## Speed-Dialing

Press **Search/Speed Dial**, #, and then the two digit Speed-Dial number. (See *Storing Speed-Dial numbers* on page 5-2.)

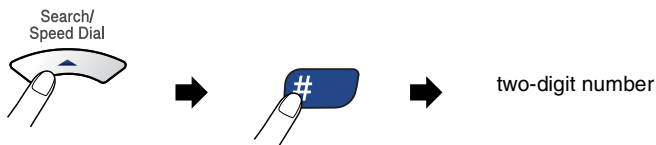

 If the LCD shows **Not Registered** when you enter the Speed-Dial number, a number has not been stored for it.

## Search

---

You can search for names you have stored in the One-Touch and Speed-Dial memories. Press **Search/Speed Dial** and the navigation keys to search. (See *Storing One-Touch Dial numbers* on page 5-1 and *Storing Speed-Dial numbers* on page 5-2.)

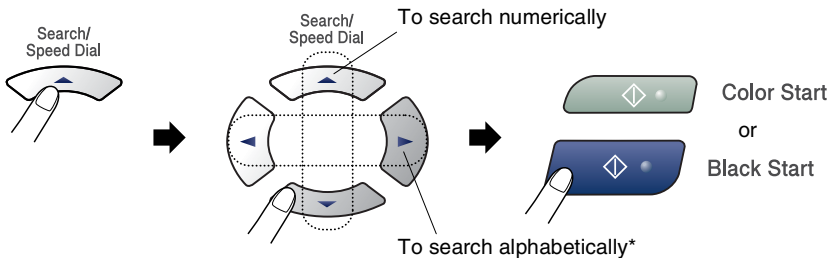

\* To search alphabetically, you can use the dial pad to enter the first letter of the name you are looking for.

## Fax Redial

---

If you are sending a fax manually and the line is busy, press **Redial/Pause**, and then press **Black Start** or **Color Start** to try again. If you want to make a second call to the last number dialed, you can save time by pressing **Redial/Pause** and **Black Start** or **Color Start**.

**Redial/Pause** only works if you dialed from the control panel. *If you are sending a fax automatically* and the line is busy, the machine will automatically redial one time after five minutes.

# How to Fax (B&W and Color)

## Color fax transmission

---

Your machine can send a color fax to machines that support this feature.

However, color faxes cannot be stored in the memory. When you send a color fax, the machine will send it in real time (even if `Real Time TX` is set to `Off`).

## Faxing from the ADF

---

Put the document face down in the ADF. To cancel, press **Stop/Exit**.

- 1 If it is not illuminated in green, press  (**Fax**).
- 2 Load your document.
- 3 Dial the fax number.
- 4 Press **Black Start** or **Color Start**.
  - The machine starts scanning the document.

 If the memory is full and you are faxing a single page, it will be sent in real time.



## Automatic transmission

---

This is the easiest way to send a fax.

- ⊘ Do not pick up the handset or press **Speaker Phone** (FAX-1940CN only) or **Hook** to listen for a dial tone.
- 1 If it is not illuminated in green, press  (**Fax**).
- 2 Load your document.
- 3 Dial the fax number you want to call. (See *How to dial* on page 3-1.)
- 4 Press **Black Start** or **Color Start**.

## Manual transmission

---

Manual transmission lets you hear the dialing, ringing and fax-receiving tones while sending a fax.

- 1 If it is not illuminated in green, press  (**Fax**).
  - 2 Load your document.
  - 3 Pick up the handset of the machine (FAX-1840C and FAX-1940CN)/external phone (MFC-3240C and MFC-3340CN) and listen for a dial tone.
- OR—
- Press **Speaker Phone** (FAX-1940CN only) or **Hook** and listen for a dial tone.
- 4 Dial the fax number you want to call.
  - 5 When you hear the fax tone, press **Black Start** or **Color Start**.
  - 6 If you picked up the handset replace it.

## Sending a fax at the end of a conversation

---

At the end of a conversation you can send a fax to the other party before you both hang up.

- 1 Ask the other party to wait for fax tones (beeps) and then to press Start or Send key before hanging up.
- 2 If it is not illuminated in green, press  (**Fax**).
- 3 Load your document.
- 4 Press **Black Start** or **Color Start**.

## Out of Memory message

---

If you get an **Out of Memory** message while scanning the first page of a fax, press **Stop/Exit** to cancel the fax. If you get an **Out of Memory** message while scanning a subsequent page, you will have the option to press **Black Start** to send the pages scanned so far, or to press **Stop/Exit** to cancel the operation.

 If the memory is full and you are faxing a single page, it will be sent in real time.

# Basic sending operations

## Sending faxes using multiple settings

---

When you send a fax you can choose any combination of these settings: contrast, resolution, overseas mode, delayed fax timer, polling transmission or real time transmission.

- 1 If it is not illuminated in green, press  (**Fax**).  
After each setting is accepted, the LCD will ask if you want to enter more settings:

- 2 Press **1** to select more settings. The LCD will return to the `Setup Send` menu.

Other Settings

1.Yes 2.No

—OR—

Press **2** if you have finished choosing settings and go to the next step.

## Contrast

---

If your document is very light or very dark, you may want to change the contrast.

Use `Light` to send a light document.

Use `Dark` to send a dark document.

- 1 If it is not illuminated in green, press  (**Fax**).

- 2 Load your document.

- 3 Press **Menu/Set**, **2**, **2**, **1**.

1.Contrast

- 4 Press **▲** or **▼** to select `Auto`, `Light` or `Dark`.

Press **Menu/Set**.

## Fax Resolution

---

You can use the **Fax Resolution** key to change the setting temporarily (for this fax only). In Fax mode , press **Fax Resolution** and ▲ or ▼ to select the setting you want, and then press **Menu/Set**.

—OR—

You can change the default setting:

- 1 If it is not illuminated in green, press  (**Fax**).
- 2 Load your document.
- 3 Press **Menu/Set, 2, 2, 2**. 2.Fax Resolution
- 4 Press ▲ or ▼ to select the resolution you want.

Press **Menu/Set**.

Standard	Suitable for most typed documents.
Fine	Good for small print and transmits a little slower than Standard resolution.
S.Fine	Good for small print or artwork and transmits slower than Fine resolution.
Photo	Use when the document has varying shades of gray or is a photograph. This has the slowest transmission time.

## Dual Access (Not available for color faxes)

---

You can dial a number, and begin scanning the fax into memory—even when the machine is sending from memory or receiving faxes. The LCD shows the new job number and available memory.



Your machine normally uses Dual Access. However, to send a color fax, the machine will send the document in real time (even if `Real Time TX is Off`).

The number of pages you can scan into the memory will vary depending on the data that is printed on them.



If you get an `Out of Memory` message while scanning the first page of a fax, press **Stop/Exit** to cancel scanning. If you get an `Out of Memory` message while scanning a subsequent page, you can press **Black Start** to send the pages scanned so far, or press **Stop/Exit** to cancel the operation.

## Real Time Transmission

---

When you are sending a fax, the machine will scan the documents into the memory before sending. Then, as soon as the phone line is free, the machine will start dialing and sending.

If the memory becomes full, the machine will send the document in real time (even if `Real Time TX` is set to `Off`).

Sometimes, you may want to send an important document immediately, without waiting for memory transmission. You can set `Real Time TX` to `On` for all documents or for the next fax only.

**1** If it is not illuminated in green, press  (**Fax**).

**2** Load your document.

**3** Press **Menu/Set**, **2**, **2**, **5**.

5.Real Time TX

**4** To change the default setting, press **▲** or **▼** to select `On` (or `Off`).

Press **Menu/Set**.

—OR—

For the next fax transmission only, press **▲** or **▼** to select `Next Fax Only`.

Press **Menu/Set** and go to Step 5.

**5** For the next fax only, press **▲** or **▼** to select `On` (or `Off`).

Press **Menu/Set**.

 In Real Time Transmission, the redial feature does not work.

 If you are sending a color Fax, the machine will send it in real time (even if `Real Time TX` is set to `Off`).

## Checking job status

---

Check which jobs are still waiting in the memory to be sent. (If there are no jobs, the LCD shows `No Jobs Waiting`.)

- 1 Press **Menu/Set**, **2**, **6**. 6.Remaining Jobs
- 2 If you have more than one job waiting, press **▲** or **▼** to scroll through the list.
- 3 Press **Stop/Exit**.

## Canceling a fax in progress

---

If you want to cancel a fax, while the machine is scanning, dialing or sending it, press **Stop/Exit**.

## Canceling a scheduled job

---

You can cancel a fax job that is stored and waiting in the memory.

- 1 Press **Menu/Set**, **2**, **6**. 6.Remaining Jobs  
Any jobs that are waiting will appear on the LCD.
- 2 If you have more than one job waiting, press **▲** or **▼** to select the job you want to cancel.  
Press **Menu/Set**.  
—OR—  
If you only have one job waiting, go to Step 3.
- 3 Press **1** to cancel.  
To cancel another job go to Step 2.  
—OR—  
Press **2** to exit without canceling.
- 4 Press **Stop/Exit**.

# Advanced sending operations

## Broadcasting (Not available for color faxes)

---

Broadcasting is when the same fax message is automatically sent to more than one fax number. You can include Groups, One-Touch, Speed-Dial numbers and up to 50 manually dialed numbers in the same broadcast.

Press **Menu/Set** between each of the numbers. Use **Search/Speed Dial** to help you choose the numbers easily. (To set up Group dial numbers, see *Setting up Groups for Broadcasting* on page 5-4.)

After the broadcast is finished, a Broadcast Report will be printed to let you know the results.

- 1** If it is not illuminated in green, press  (**Fax**).
- 2** Load your document.
- 3** Enter a number using One-Touch, Speed-Dial, a Group number, Search or manual dialing using the dial pad.  
(Example: Group number)
- 4** When the LCD displays the fax number or name of the other party, press **Menu/Set**.  
You will be asked to enter the next number.
- 5** Enter the next number.  
(Example: Speed-Dial number)
- 6** When the LCD displays the fax number or name of the other party, press **Menu/Set**.
- 7** After you have entered all the fax numbers, go to step 8 to start the broadcast.
- 8** Press **Black Start**.





- If you did not use up any of the numbers for Groups, access codes or credit card numbers, you can 'broadcast' faxes to as many as 100 (FAX-1840C and MFC-3240C), 154 (FAX-1940CN) or 158 (MFC-3340CN) different numbers.
- The available memory will vary depending on the types of jobs in the memory and the number of locations used for broadcasting. If you broadcast to the maximum numbers available, you will not be able to use Dual Access and Delayed fax.
- Enter the long dialing sequence numbers as you would normally, but remember that each One-Touch and Speed-Dial number counts as one number, so the number of locations you can store becomes limited.
- If the memory is full, press **Stop/Exit** to stop the job or if more than one page has been scanned, press **Black Start** to send the portion that is in the memory.

## Overseas Mode

---

If you are having difficulty sending a fax overseas due to possible interference on the phone line, we recommend that you turn on the Overseas Mode. After you send a fax using this feature, the feature will turn itself off.

- 1 If it is not illuminated in green, press  (**Fax**).
- 2 Load your document.
- 3 Press **Menu/Set**, **2**, **2**, **7**.
- 4 Press **▲** or **▼** to select **On** (or **Off**).  
Press **Menu/Set**.

7.Overseas Mode

## Delayed Fax (Not available for color faxes)

---

During the day you can store up to 50 faxes in the memory to be sent within 24 hours. These faxes will be sent at the time of day you enter in Step 4.

**1** If it is not illuminated in green, press  (**Fax**).

**2** Load your document.

**3** Press **Menu/Set**, **2**, **2**, **3**.

3.Delayed Fax

**4** Press **Menu/Set** to accept the displayed time.

—OR—

Enter the time you want the fax to be sent (in 24-hour format).

Press **Menu/Set**.

(For example, enter 19:45 for 7:45 PM.)

**5** Press **1** to leave the documents waiting in the ADF.

1.Doc 2.Memory

—OR—

Press **2** to scan the documents into the memory.



The number of pages you can scan into the memory depends on the amount of data that is printed on each page.

## Setting up Polled Transmit (Not available for color faxes)

---

Polled Transmit is when you set up your machine to wait with a document so another fax machine can call and retrieve it.

**1** If it is not illuminated in green, press  (**Fax**).

**2** Load your document.

**3** Press **Menu/Set, 2, 2, 6**.

6.Polled TX

**4** Press **▲** or **▼** to choose **On** (or **Off**).

Press **Menu/Set**.

**5** Press **1** to leave the paper document waiting in the ADF.

1.Doc 2.Memory

—OR—

Press **2** to scan the document into the memory.



If you press **1** in Step 5, the document remains in the ADF until your machine is polled. If you must use your machine before the polled transmit occurs, you must first cancel this job.



If you press **2** in Step 5, the document will be stored and can be retrieved from any other fax machine until you delete the fax in memory by using the Canceling a Job menu setting.  
(See *Canceling a scheduled job* on page 3-11.)

## Delayed Batch Transmission (Not available for color faxes)

---

Before sending the delayed faxes, your machine will help you economize by sorting all the faxes in the memory by destination and scheduled time. All delayed faxes that are scheduled to be sent at the same time to the same fax number will be sent as one fax to save transmission time.

**1** If it is not illuminated in green, press  (**Fax**).

**2** Press **Menu/Set, 2, 2, 4**.

4.Batch TX

**3** Press **▲** or **▼** to select **On** (or **Off**).

Press **Menu/Set**.

**4** Press **Stop/Exit**.

# 4 Setup Receive

## Basic receiving operations (FAX-1840C, MFC-3240C and MFC-3340CN only)

### Choosing the Receive Mode

---

There are four different Receive Modes for your machine. You can choose the mode that best suits your needs.

LCD	How it works	When to use it
Fax Only (automatic receive)	The machine automatically answers every call as a fax.	For dedicated fax lines.
Fax/Tel (fax and telephone)  (with an external or extension telephone)	The machine controls the line and automatically answers every call. If the call is a fax it will receive the fax. If the call is not a fax it will ring (pseudo/double ring) for you to pick up the call.	Use this mode if you expect to receive lots of fax messages and few telephone calls. You cannot have an answering machine on the same line, even if it is on a separate wall jack on the same line. You cannot use the telephone company's Voice Mail in this mode.
External TAD (with an external answering device only)	The external answering device (TAD) automatically answers every call. Voice messages are stored on the external TAD. Fax messages are printed.	Use this mode if you have connected an answering machine to your machine. The External TAD setting works only with an external answering machine. Ring Delay does not work in this setting.
Manual (manual receive) (with an external or extension telephone or with Distinctive Ring)	You control the phone line and must answer every call yourself.	Use this mode if you do not receive many fax messages, with Distinctive Ring, or if you are using a computer on the same line. If you answer and hear fax tones, wait until the machine takes over the call, then hang up. (See <i>Easy Receive (MFC-3240C and MFC-3340CN only)</i> on page 4-8.)

## To select or change your Receive Mode

- 1 If it is not illuminated in green, press  (**Fax**).
- 2 Press **Menu/Set, 0, 1**.
- 3 Press **▲** or **▼** to select **Fax Only, Fax/Tel, External TAD** or **Manual**.  
Press **Menu/Set**.
- 4 Press **Stop/Exit**.

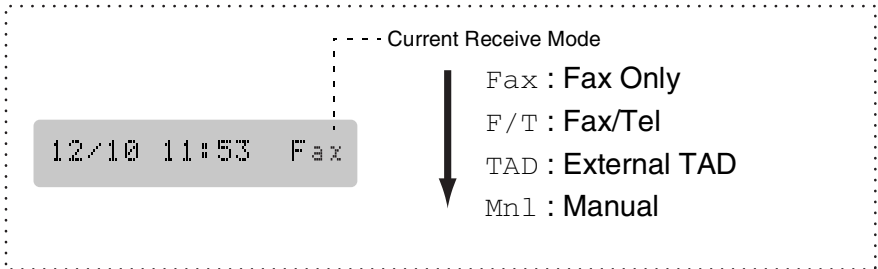

## Setting the Ring Delay

The Ring Delay sets the number of times the machine rings before it answers in **Fax Only** or **Fax/Tel** mode. If you have extension phones on the same line as the machine or subscribe to the telephone company's Distinctive Ring service, keep the Ring Delay setting of 4.

(See *Operation from extension telephones* on page A-7 and *Easy Receive (MFC-3240C and MFC-3340CN only)* on page 4-8 or *Easy Receive (FAX-1840C and FAX-1940CN only)* on page 4-9.)

- 1 If it is not illuminated in green, press  (**Fax**).
- 2 Press **Menu/Set, 2, 1, 1**.
- 3 Press **▲** or **▼** to select how many times the line rings before the machine answers (00, 01, 02, 03 or 04)(00 - 04 UK only)  
(00 - 05 Nordic countries only).  
Press **Menu/Set**.  
(If you select 00, the line won't ring at all.)
- 4 Press **Stop/Exit**.

# Basic receiving operations (FAX-1940CN only)

## Choosing the Receive Mode

There are four different Receive Modes for your machine. You can choose the mode that best suits your needs. (See *Message Center mode* on page 7-1 to set up the `MC:Msg. Ctr.` mode.)

LCD	How it works	When to use it
Fax Only (automatic receive)	The machine automatically answers every call as a fax.	For dedicated fax lines.
Fax/Tel (fax and telephone)	The machine controls the line and automatically answers every call. If the call is a fax it will receive the fax. If the call is not a fax it will ring (pseudo/double ring) for you to pick up the call.	Use this mode if you expect to receive lots of fax messages and few telephone calls. You cannot have an answering machine on the same line, even if it is on a separate wall jack on the same line. You cannot use the telephone company's Voice Mail in this mode.
Manual (manual receive)  (with Distinctive Ring)	You control the phone line and must answer every call yourself.	Use this mode if you do not receive many fax messages, have an external TAD connected to the machine, use Distinctive Ring, or if you are using a computer modem on the same phone line. If you answer and hear fax tones, wait until the machine takes over the call, then hang up. (See <i>Easy Receive (FAX-1840C and FAX-1940CN only)</i> on page 4-9.) —OR— Make sure Easy Receive is set to On. (See <i>Easy Receive (FAX-1840C and FAX-1940CN only)</i> on page 4-9.)
MC:Msg. Ctr.  	The built-in digital Message Center answers voice calls and automatically receives faxes.	Use this mode to record voice messages in the machine's memory. (For details, see <i>Message Center mode</i> on page 7-1.)

## To select or change your Receive Mode

- 1 If it is not illuminated in green, press  (**Fax**).
- 2 Press **Menu/Set, 0, 1**. 1.Receive Mode
- 3 Press **▲** or **▼** to select **Fax Only**,  
**Fax/Tel**, or **Manual**.  
Press **Menu/Set**.
- 4 Press **Stop/Exit**.

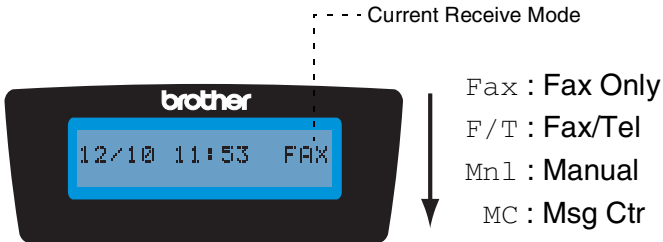

Press and hold until it  
lights.

If the Message Center Mode is On, it  
overrides your Receive Mode setting.  
The screen shows **MC:Msg. Ctr.**



OFF

If the Message Center Mode is Off, the  
Receive Mode returns to your own  
setting. (See *Message Center*  
(FAX-1940CN only) on page 7-1.)



## Setting the Ring Delay

---

The Ring Delay sets the number of times the machine rings before it answers in **Fax Only**, **Fax/Tel** and **MC:Msg. Ctr.** modes. If you have extension phones on the same line as the machine or subscribe to the telephone company's Distinctive Ring service, keep the Ring Delay setting of 4.

(See *Easy Receive (FAX-1840C and FAX-1940CN only)* on page 4-9 and *Operation from extension telephones* on page A-7.)

- 1** If it is not illuminated in green, press  (**Fax**).
- 2** Press **Menu/Set**, **2**, **1**, **1**.
- 3** Press **▲** or **▼** to select **Ring Delay**. Ring Delay  
Press **Menu/Set**.
- 4** Press **▲** or **▼** to select how many times the line rings before the machine answers (00-04).  
Press **Menu/Set**.  
(If you select 00, the line won't ring at all.)
- 5** Press **Stop/Exit**.



Toll Saver must be **Off** to use the Ring Delay setting.  
(See *Setting Toll Saver (Msg Ctr mode)* on page 4-6.)

## Setting Toll Saver (Msg Ctr mode)

---

When you set the toll saver feature, the machine answers after four rings if you do not have voice or fax messages and after two rings if you do have voice or fax messages. This way, when you call the machine for remote retrieval and let it ring three times, you know you have no messages and can hang up to avoid a toll charge.



- When Toll Saver is **On**, it overrides your Ring Delay setting. (See *Setting the Ring Delay* on page 4-5.)
- The Toll Saver feature is available only when the Message Center is set to **On**.
- If you are using Distinctive Ring, do **NOT** use the Toll Saver feature.

**1** If it is not illuminated in green, press  (**Fax**).

**2** Press **Menu/Set, 2, 1, 1**.

**3** Press **▲** or **▼** to select **Toll Saver**.

Toll Saver

Press **Menu/Set**.

**4** Press **▲** or **▼** to select **On** (or **Off**).

Press **Menu/Set**.

**5** Press **Stop/Exit**.

## Setting the F/T Ring Time (Fax/Tel mode only)

---

If you set the Receive Mode to Fax/Tel, you'll need to decide how long the machine will signal you with its special pseudo/double-ring when you have a *voice* call. (If it's a fax call, the machine prints the fax.)

This pseudo/double-ring happens after the initial ringing from the phone company. Only the machine rings and no other phones on the same line will ring with the special pseudo/double-ring. However, you can still answer the call on any telephone. (See *Fax/Tel mode when power key is On* on page A-8 and *Fax/Tel mode when power key is Off* on page A-8.)

- 1 If it is not illuminated in green, press  **(Fax)**.
- 2 Press **Menu/Set**, **2**, **1**, **2**. 2.F/T Ring Time
- 3 Press **▲** or **▼** to select how long the machine will ring to alert you that you have a voice call (20, 30, 40 or 70 seconds).  
Press **Menu/Set**.
- 4 Press **Stop/Exit**.



Even if the caller hangs up during the pseudo/double-ringing, the machine will continue to ring for the set time.

## Setting the Fax/Tel Announcement (FAX-1940CN only)

---

For the Fax/Tel receive mode, you can set up the machine to play an outgoing announcement for callers when no one is there to answer calls. (See *Record Fax/Tel Outgoing Announcement (F/T OGM)* on page 7-7.)

## Easy Receive (MFC-3240C and MFC-3340CN only)

When you use this feature, you don't have to press **Black Start**, **Color Start**, or the Fax Receive Code \*51 when you answer a fax call. Selecting **On** allows the machine to receive fax calls automatically, even if you lift the handset of an extension or external phone. When you see *Receiving* on the LCD or when you hear 'chirps' through the handset of an extension phone connected to another telephone wall jack, just replace the handset and your machine will do the rest.



- If this feature is set to **On**, but your machine does not connect a fax call when you lift a extension or external phone handset, press the Fax Receive Code \*51.
- If you send faxes from a computer on the same phone line and the machine intercepts them, set Easy Receive to **Off**.
- Selecting **Off** means you'll have to activate the machine yourself by lifting the handset of an external or extension phone, and then press **Black Start** or **Color Start** on the machine  
—OR—  
by pressing \*51 if you are not at your machine.  
(See *Operation from extension telephones* on page A-7.)

1 If it is not illuminated in green, press  (**Fax**).

2 Press **Menu/Set**, **2**, **1**, **3**.

3.Easy Receive

3 Use ▲ or ▼ to select **On** (or **Off**).

Press **Menu/Set**.

4 Press **Stop/Exit**.

## Easy Receive (FAX-1840C and FAX-1940CN only)

When you use this feature, you don't have to press **Black Start**, **Color Start**, or the Fax Receive Code \*51 when you answer a fax call and hear calling beeps. Just hold the handset and wait a few seconds. Selecting **Easy RX:On** allows the machine to receive fax calls automatically, even if you lift the machine's handset or the handset of an extension or external phone. When you see **Receiving** on the LCD or when you hear "chirps" through the handset of an extension phone connected to another wall jack, just replace the handset and your machine will do the rest. **Semi** lets the machine receive the fax only if you've answered it at the machine.



- If you've set the feature to **On**, but your machine does not automatically connect a fax call when you lift an external or extension phone handset, press the Fax Receive code \*51. At the machine, press **Black Start** or **Color Start**.
- If you send faxes from a computer on the same phone line and the machine intercepts them, set Easy Receive to **Off**.
- Selecting **Off** means you'll have to activate the machine yourself by pressing **Black Start** or **Color Start** on the machine.

—OR—

Press \*51 on the external or extension phone if you are not at your machine. (See *Operation from extension telephones* on page A-7.)

1 If it is not illuminated in green, press  (**Fax**).

2 Press **Menu/Set**, **2**, **1**, **3**.

3.Easy Receive

3 Use **▲** or **▼** to select **On** (**Semi** or **Off**).

Press **Menu/Set**.

4 Press **Stop/Exit**.

## Printing a reduced incoming fax (Auto Reduction)

---

If you choose **Reduction: On**, the machine automatically reduces an incoming fax to fit on one page of A4, letter or legal size paper. The machine calculates the reduction ratio by using the page size of the document and your Paper Size setting (**Menu/Set, 1, 3**).

**1** If it is not illuminated in green, press  (**Fax**).

**2** Press **Menu/Set, 2, 1, 5**.

5.Auto Reduction

**3** Use **▲** or **▼** to select **On** (or **Off**).

Press **Menu/Set**.

**4** Press **Stop/Exit**.



■ Turn on this setting if you receive faxes that are split on two pages. However, if the document is too long, the machine may print it on two pages.

■ If left and right margins are cut off, turn on this setting.

## Receiving a fax at the end of a conversation

---

At the end of a conversation you can ask the other party to fax you information before you both hang up.

**1** Ask the other party to place the document in their machine and to press **Start** or **Send** key.

**2** When you hear the other machine's CNG tones (beeps), press **Black Start** or **Color Start**.

**3** If you picked up the handset, replace it.

## Printing a fax from the memory

---

If you have selected **Fax Forwarding**, **Paging** or **Fax Storage** (**Menu/Set, 2, 5, 1**), you can still print a fax from the memory when you are at your machine. (See *Setting Fax Storage* on page 6-3.)

**1** Press **Menu/Set, 2, 5, 3**.

3.Print Fax

**2** Press **Black Start**.

## Polling

---

Polling is the process of retrieving faxes from another fax machine. You can use your machine to 'poll' other machines, or you can have someone poll your machine.

Everyone who is involved in Polling needs to set up their fax machines for Polling. When someone polls your machine to receive a fax, they pay for the call. If you poll someone's fax machine to receive a fax, you pay for the call.



Some fax machines do not respond to the Polling feature.

### Setting up Polling Receive

Polling Receive is when you call another fax machine to receive a fax from it.

**1** If it is not illuminated in green, press  **(Fax)**.

**2** Press **Menu/Set, 2, 1, 6**.

6.Polling RX

**3** Enter the fax number you are polling.

**4** Press **Black Start** or **Color Start**.

The LCD shows *Dialing*.

### Setting up Sequential Polling Receive

Your machine can ask for faxes from several fax units in a single operation (Sequential Polling Receive). Afterwards, a Sequential Polling Report will be printed.

**1** If it is not illuminated in green, press  **(Fax)**.

**2** Press **Menu/Set, 2, 1, 6**.

6.Polling RX

**3** Enter the fax machines you want to poll using One-Touch, Speed-Dial, a Group or the dial pad. You must press **Menu/Set** between each fax number.

**4** Press **Black Start** or **Color Start**. Your machine will poll each number or Group number in turn to receive a fax.

# 5

## Quick-Dial numbers and dialing options

### Storing numbers for easy dialing

You can set up your machine to do following types of easy dialing: One-Touch, Speed-Dial and Groups for Broadcasting faxes. When you dial a quick-dial number, the LCD shows the name, if you stored it, or the number.



*If you lose electrical power, the quick-dial numbers that are in the memory will not be lost.*

### Storing One-Touch Dial numbers

Your machine has One-Touch keys where you can store fax or phone numbers for automatic dialing. Two numbers can be stored on each One-Touch key. To access the second number, which is shown in a black square on the control panel, hold down **Shift** as you press the One-Touch key. (See *One-Touch dialing* on page 3-2.)

*One-Touch keys are located on the left side of the control panel.*

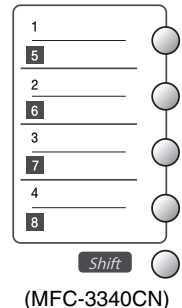

**1** Press **Menu/Set**, **2**, **3**, **1**.

Set Quick-Dial

**2** Press the One-Touch key where you want to store a number.

1.One-Touch Dial

**3** Enter the phone or fax number (up to 20 digits).

Press **Menu/Set**.

- If you want to enter a pause in the dialing sequence (for example, to access an outside line), press **Redial/Pause** as you are entering the digits.

Each key press of **Redial/Pause** enters a 3.5 second pause when the number is dialed, displayed by a dash on the screen.



- 4 Use the dial pad to enter the name (up to 15 characters).  
Press **Menu/Set**.  
(You can use the chart on page B-12 to help you enter letters.)  
—OR—  
Press **Menu/Set** to store the number without a name.
- 5 Go to Step 2 to store another One-Touch number.  
—OR—  
Press **Stop/Exit**.

## Storing Speed-Dial numbers

---

You can store Speed-Dial numbers, so that when you dial you will only have to press a few keys (**Search/Speed Dial**, #, the two-digit number, and **Black Start** or **Color Start**). The FAX-1840C and MFC-3240C can store 40 Speed-Dial numbers and the FAX-1940CN and MFC-3340CN can store 100 Speed-Dial numbers.

- 1 Press **Menu/Set**, **2, 3, 2**. 2.Speed Dial
- 2 Use the dial pad to enter a two-digit Speed-Dial location number (01-40 for FAX-1840C and MFC-3240C) (00-99 for FAX-1940CN and MFC-3340CN).  
(For example, press **05**.)  
Press **Menu/Set**.
- 3 Enter the phone or fax number (up to 20 digits).  
Press **Menu/Set**.
- 4 Use the dial pad to enter the name (up to 15 characters).  
Press **Menu/Set**.  
(You can use the chart on page B-12 to help you enter letters.)  
—OR—  
Press **Menu/Set** to store the number without a name.
- 5 Go to Step 2 to store another Speed-Dial number.  
—OR—  
Press **Stop/Exit**.

## Changing One-Touch and Speed-Dial numbers

---

If you try to store a One-Touch or Speed-Dial number where a number has already been stored, the LCD will show the name that has been stored there (or number) and will ask you to do one of the following:

- 1 Press **1** to change the stored number.

05:Mike

—OR—

1.Change 2.Exit

Press **2** to exit without making a change.

*How to change the stored number or name:*

- If you want to change a character, use ◀ or ▶ to position the cursor under the character you want to change, and then type over it.
- If you want to erase the whole number or whole name, press **Stop/Exit** when the cursor is under the first digit or letter. The characters above and to the right of the cursor will be deleted.

- 2 Enter a new number.

Press **Menu/Set**.

- 3 Follow the directions beginning at Step 4 in Storing One-Touch Dial numbers and Storing Speed-Dial numbers. (See page 5-1 and 5-2.)

## Setting up Groups for Broadcasting

---

Groups, which can be stored on a One-Touch key or a Speed-Dial location, allow you to send the same fax message to many fax numbers by pressing only a One-Touch key and **Black Start** or **Search/Speed Dial**, #, the two-digit location and **Black Start**.

First, you will need to store each fax number as a One-Touch or Speed-Dial number. Then, you can combine them into a Group, *Each Group uses up a One-Touch key or a Speed-Dial location.*

Finally, you can have up to six small Groups, or you can assign up to 103 numbers (FAX-1940CN), 107 numbers (MFC-3340CN) and 49 numbers (FAX-1840C and MFC-3240C) to one large Group.

(See *Storing Speed-Dial numbers* on page 5-2 and *Changing One-Touch and Speed-Dial numbers* on page 5-3.)

**1** Press **Menu/Set**, **2**, **3**, **3**.

3.Setup Groups

**2** Decide where you wish to store the Group.

—**AND**—

Press a One-Touch key.

—**OR**—

Press **Search/Speed Dial** and enter the two-digit location, and then press **Menu/Set**.

**3** Use the dial pad to enter the Group number (1 to 6).

Press **Menu/Set**.

(For example, press **1** for Group 1.)

**4** To include One-Touch or Speed-Dial numbers in the Group, enter them as follows.

For example, for One-Touch key **2**, press One-Touch key **2**. For a number in a black square, such as One-Touch key **6**, press **Shift** and One-Touch key **6**.

For Speed-Dial location 09, press **Search/Speed Dial**, and then press **09** on the dial pad. The LCD shows \* 04, #09 (or \* 06, #09).

- 5 Press **Menu/Set** to accept the numbers for this Group.
  - 6 Use the dial pad and the chart on page B-12 to enter a name for the Group.  
Press **Menu/Set**.  
(For example, NEW CLIENTS)
  - 7 Press **Stop/Exit**.
-  You can print a list of all One-Touch and Speed-Dial numbers. (See *Printing reports* on page 8-3.) Group numbers will be marked in the GROUP column.

# Dialing options

## Access codes and credit card numbers

---

Sometimes you may want to choose from several long distance carriers when you make a call. Rates may vary depending on the time and destination. To take advantage of low rates, you can store the access codes or long-distance carriers and credit card numbers as One-Touch and Speed-Dial numbers. You can store these long dialing sequences by dividing them and setting them up as separate One-Touch and Speed-Dial numbers in any combination. You can even include manual dialing using the dial pad. (See *Storing One-Touch Dial numbers* on page 5-1 and *Storing Speed-Dial numbers* on page 5-2.)

For example, perhaps you have stored '555' on One-Touch key **1** and '7000' on One-Touch key **2**. If you press One-Touch key **1**, One-Touch key **2**, and then **Black Start** or **Color Start**, you will dial '555-7000'.

To temporarily change a number, you can substitute part of the number with manual dialing using the dial pad.

For example, to change the number to 555-7001 you could press One-Touch key **1** and then press **7001** using the dialing pad.



If you must wait for another dial tone or signal at any point in the dialing sequence, store a pause there in the number by pressing **Redial/Pause**. Each key press adds a 3.5-second delay.

## Pause

---

Press **Redial/Pause** to insert a 3.5-second pause between numbers. If you are dialing overseas, you can press **Redial/Pause** as many times as needed to increase the length of the pause.

## Tone or Pulse

---

If you have a Pulse dialing service, but need to send Tone signals (for example, for telephone banking), follow the instructions below. If you have Touch Tone service, you will not need this feature to send tone signals.

**1** For Fax-1840C and FAX-1940CN, lift the handset.

—OR—

For MFC-3240C and MFC-3340CN, lift the handset of the external phone.

**2** Press # on the machine's control panel. Any digits dialed after this will send tone signals.

When you hang up, the machine will return to the Pulse dialing service.

# Telephone (voice) operations (FAX-1840C and FAX-1940CN only)

You can use the machine to make voice telephone calls by dialing manually or by using Search, One-Touch Dial or Speed-Dial memory. You can use the handset or **Speaker Phone** (FAX-1940CN only) to make and receive calls.

When you dial a Quick-Dial number, the LCD shows the name you've stored, or if you haven't stored a name, the fax number you've stored.

## How to dial

---

See *How to dial* on page 3-1.

## Making a telephone call

---

- 1 Pick up the handset.  
—OR—  
Press **Speaker Phone** (FAX-1940CN only).
- 2 When you hear a dial tone, dial the number using the dial pad, One-Touch, Speed-Dial and Search.
- 3 If you pressed **Speaker Phone** on FAX-1940CN, speak clearly toward the microphone .
- 4 To hang up, replace the handset.  
—OR—  
Press **Speaker Phone** (FAX-1940CN only).

## Answering calls with the Speaker Phone (FAX-1940CN only)

---

When the machine rings, instead of lifting the handset, press **Speaker Phone**. Speak clearly, toward the microphone . To end the call, press **Speaker Phone**.

If you have a bad telephone line connection, the other party might hear your voice echoed during the call. Hang up and try the call again—**OR**—Pick up the handset.

## Hold (FAX-1840C and FAX-1940CN only)

---

- 1** Press **Hold** to put a call on Hold.
- 2** You can replace the handset without disconnecting the call.
- 3** Pick up the machine handset to release the call from Hold.  
Picking up an extension handset will not release the call from Hold.



# 6

## Remote Fax Options (Not available for color faxes)



You can only use one remote fax option at a time:  
Fax Forwarding—**OR**—Paging—**OR**—Fax Storage—**OR**—  
PC FAX Receive (MFC-3340CN only)—**OR**—Off.

You can change your selection at any time (**Menu/Set, 2, 5, 1**).  
(See *Turning off Remote Fax Options* on page 6-4.)

### Setting up Fax Forwarding

---

When you select Fax Forward, your machine stores the received fax in the memory. The machine will then dial the fax number you've programmed and forwards the fax message.

**1** Press **Menu/Set, 2, 5, 1**.

1.Fwd/Page/Store

**2** Press **▲** or **▼** to select  
Fax Forward.

Press **Menu/Set**.

The LCD will ask you to enter the fax number to which faxes will be forwarded.

**3** Enter the forwarding number (up to 20 digits).

Press **Menu/Set**.

**4** Press **▲** or **▼** to select **On** or **Off**.

Backup Print:On

Press **Menu/Set**.



If you select **Backup Print:On**, the machine will also print the fax at your machine so you will have a copy if there is a power failure before it is forwarded.

**5** Press **Stop/Exit**.

## Programming your pager number

---

When Paging is selected, your machine dials the pager number you've programmed, and then dials your Personal Identification Number (PIN). This activates your pager so you will know that you have a voice (FAX-1940CN only) or fax message in the memory.

- 1 Press **Menu/Set**, **2**, **5**, **1**. 1.Fwd/Page/Store
- 2 Press **▲** or **▼** to select **Paging**.
- 3 Enter your pager phone number followed by **# #** (up to 20 digits). Press **Menu/Set**.

Do not include the area code if it is the same as that of your machine.

For example, press **1 8 0 0 5 5 5 1 2 3 4 # #**.

- 4 If your pager needs a PIN, enter the PIN, press **#**, press **Redial/Pause**, enter your fax number followed by **# #**. Press **Menu/Set**.

(For example, press **1 2 3 4 5 # Redial/Pause 1 8 0 0 5 5 5 1 2 1 2 # #**)

—OR—

If you do not need a PIN, press **Redial/Pause**, enter your fax number followed by **# #**.

Press **Menu/Set**.

(For example, press **Redial/Pause 1 8 0 0 5 5 5 3 4 3 4 # #**)

- 5 Press **Stop/Exit**.



- You cannot change a Paging number or PIN remotely.
- If you have set Paging, a backup copy of the received fax will automatically be printed at the machine.
- If you want to be paged for voice messages make sure you pressed the **MC On/Off** key to turn the Message Center on.

## Setting Fax Storage

---

If you select Fax Storage, your machine stores the received fax in the memory. You will be able to retrieve fax messages from another location using the Remote Retrieval commands.

**1** Press **Menu/Set, 2, 5, 1.**

1.Fwd/Page/Store

**2** Press **▲** or **▼** to select  
Fax Storage.

Press **Menu/Set.**

**3** Press **Stop/Exit.**



If you have set Fax Storage, a backup copy of the received fax will automatically be printed at the machine.

## Setting PC Fax Receive (MFC-3340CN only)

---

If you select PC Fax Receive, your machine will temporarily store your received faxes in its memory, and then automatically send the faxes to the PC. You can then use your PC to view and store these faxes.

**1** Press **Menu/Set, 2, 5, 1.**

1.Fwd/Page/Store

**2** Press **▲** or **▼** to select  
PC Fax Receive.

Press **Menu/Set.**

**3** Press **▲** or **▼** to select On or Off.

Backup Print:On

Press **Menu/Set.**

**4** Press **Stop/Exit.**



- Before you can set up PC Fax Receive you must install the MFL-Pro Suite software on your PC. Make sure your PC is connected and turned on. (For details see *Using Brother PC-FAX software* on page 5-1 in Software User's Guide on the CD-ROM.)
- If you select `Backup Print : On`, the machine will also print the fax at your machine so you will have a copy if there is a power failure before it is sent to the PC.
- If you get an error message and the machine cannot print the faxes in memory, you can use this setting to transfer your faxes to your PC. (For details, see *Error messages* on page 12-1.)

## Turning off Remote Fax Options

---

If you set the Remote Fax Options to `Off` and there are faxes in your machine's memory, the LCD will give you two options.

- If you press **1**, all unprinted faxes will be printed and erased before the setting turns off. If a backup copy has already been printed it will not be printed again.
- If you press **2**, the memory will not be erased and the setting will be unchanged.

(See *Printing a fax from the memory* on page 4-10.)

## Setting your Remote Access Code

---

The remote access code lets you access the Remote Retrieval features when you are away from your machine. Before you use the remote access and retrieval features, you have to set up your own code. The default code is inactive code (--- \*).

**1** Press **Menu/Set, 2, 5, 2**.

2.Remote Access

**2** Enter a three-digit code using numbers **0-9, \***.

Press **Menu/Set**. (The preset ‘\*’ cannot be changed.)

 Do not use the same code which is set in your Fax Receive Code (**\*51**) or Telephone Answer Code (**#51**).  
(See *Operation from extension telephones* on page A-7.)

**3** Press **Stop/Exit**.

 You can change your code at any time by entering a new one. If you want to make your code inactive, press **Stop/Exit** in Step 2 to restore the inactive setting (--- \*).

# Remote Retrieval

You can call your machine from any touch tone telephone or fax machine, then use the Remote Access Code and remote commands to retrieve fax messages. Be sure to cut out the Remote Retrieval Access Card on the last page and keep it with you at all times.

## Using your Remote Access Code

---

- 1** Dial your fax number from a telephone or another fax machine using touch tone.
- 2** When your machine answers, immediately enter your Remote Access Code (3 digits followed by \*).
- 3** The machine signals if it has received messages:
  - 1 long beep — Fax messages**
  - 2 long beeps — Voice messages (FAX-1940CN only)**
  - 3 long beeps — Fax & Voice messages (FAX-1940CN only)**
  - No beeps — No messages**
- 4** The machine gives two short beeps to tell you to enter a command. The machine will hang up if you wait longer than 30 seconds to enter a command. The machine will beep three times, if you enter an invalid command.
- 5** Press **90** to reset the machine when you've finished.
- 6** Hang up.



If your machine is set to **Manual mode** and you want to use the remote retrieval features, you can access your machine by waiting about 2 minutes after it starts ringing, and then entering the Remote Access Code within 30 seconds.

## Remote commands

Follow the commands below to access features when you are away from the machine. When you call the machine and enter your Remote Access Code (3 digits followed by \*), the system will give two short beeps and you must enter a remote command.

Remote commands		Operation details
<b>91 Playing Voice Messages (FAX-1940CN only)</b>	After one long beep, the machine plays the ICM.	
	1 Repeat or Skip Backward	Press <b>1</b> while listening to an ICM to repeat it. If you press <b>1</b> before a message, you will hear the previous message.
	2 Skip Forward	While playing the ICM, you can skip to the next message.
	9 STOP Playing	Stop playing the ICM.
<b>93 Erase all ICM (FAX-1940CN only)</b>		<p>If you hear one long beep, the erase is accepted. If you hear three short beeps, you cannot erase because all voice messages have not been played, or there are no voice message to erase.</p> <p>* This code erases all recorded messages, not one at a time.</p>
<b>94 Play and Record OGM in Memory (FAX-1940CN only)</b>		
1 Play	1 Msg Ctr OGM	The machine plays the selected OGM. You can stop playing OGMs by pressing <b>9</b> .
	2 F/T OGM	
2 Record	1 Msg Ctr OGM	After one long beep, you can record the selected OGM. You will hear the message played once. You can stop recording the message by pressing <b>9</b> .
	2 F/T OGM	

Remote commands	Operation details							
<b>95 Change the Fax Forwarding, Paging or Fax Storage settings</b> <table border="1" data-bbox="204 244 527 683"> <tr> <td data-bbox="204 244 527 316">1 OFF</td> <td data-bbox="527 244 1024 316">You can select <code>off</code> after you have retrieved or erased all your messages.</td> </tr> <tr> <td data-bbox="204 316 527 355">2 Fax Forwarding</td> <td data-bbox="527 316 1024 355" rowspan="4">If you hear one long beep, the change has been accepted. If you hear three short beeps, you cannot change it because something has not been set up (for example, perhaps a Fax Forwarding or paging number had not been registered). You can register your Fax Forwarding number by entering 4. (See <i>Changing your Fax Forwarding number</i> on page 6-10.) Once you have registered the number, Fax Forwarding will work. You can select <code>off</code> after you have retrieved or erased all your messages.</td> </tr> <tr> <td data-bbox="204 355 527 395">3 Paging</td> </tr> <tr> <td data-bbox="204 395 527 435">4 Fax Forwarding number</td> </tr> <tr> <td data-bbox="204 435 527 683">6 Fax Storage</td> </tr> </table>	1 OFF	You can select <code>off</code> after you have retrieved or erased all your messages.	2 Fax Forwarding	If you hear one long beep, the change has been accepted. If you hear three short beeps, you cannot change it because something has not been set up (for example, perhaps a Fax Forwarding or paging number had not been registered). You can register your Fax Forwarding number by entering 4. (See <i>Changing your Fax Forwarding number</i> on page 6-10.) Once you have registered the number, Fax Forwarding will work. You can select <code>off</code> after you have retrieved or erased all your messages.	3 Paging	4 Fax Forwarding number	6 Fax Storage	
1 OFF	You can select <code>off</code> after you have retrieved or erased all your messages.							
2 Fax Forwarding	If you hear one long beep, the change has been accepted. If you hear three short beeps, you cannot change it because something has not been set up (for example, perhaps a Fax Forwarding or paging number had not been registered). You can register your Fax Forwarding number by entering 4. (See <i>Changing your Fax Forwarding number</i> on page 6-10.) Once you have registered the number, Fax Forwarding will work. You can select <code>off</code> after you have retrieved or erased all your messages.							
3 Paging								
4 Fax Forwarding number								
6 Fax Storage								
<b>96 Retrieve a fax</b> <table border="1" data-bbox="204 722 527 895"> <tr> <td data-bbox="204 722 527 826">2 Retrieve all faxes</td> <td data-bbox="527 722 1024 826">Enter the number of a remote fax machine to receive stored fax message(s). (See page 6-10.)</td> </tr> <tr> <td data-bbox="204 826 527 895">3 Erase faxes from the memory</td> <td data-bbox="527 826 1024 895">If you hear one long beep, fax messages have been erased from the memory.</td> </tr> </table>	2 Retrieve all faxes	Enter the number of a remote fax machine to receive stored fax message(s). (See page 6-10.)	3 Erase faxes from the memory	If you hear one long beep, fax messages have been erased from the memory.				
2 Retrieve all faxes	Enter the number of a remote fax machine to receive stored fax message(s). (See page 6-10.)							
3 Erase faxes from the memory	If you hear one long beep, fax messages have been erased from the memory.							
<b>97 Check the receiving status (Except for FAX-1940CN)</b> <table border="1" data-bbox="204 962 527 1082"> <tr> <td data-bbox="204 962 527 1082">1 Fax</td> <td data-bbox="527 962 1024 1082">You can check whether your machine has received any faxes. If yes, you will hear one long beep. If no, you will hear three short beeps.</td> </tr> </table>	1 Fax	You can check whether your machine has received any faxes. If yes, you will hear one long beep. If no, you will hear three short beeps.						
1 Fax	You can check whether your machine has received any faxes. If yes, you will hear one long beep. If no, you will hear three short beeps.							
<b>97 Check the receiving status (FAX-1940CN only)</b> <table border="1" data-bbox="204 1153 527 1228"> <tr> <td data-bbox="204 1153 527 1193">1 Fax</td> <td data-bbox="527 1082 1024 1228" rowspan="2">You can check whether your machine has received any fax or voice messages. If yes, you will hear one long beep. If no, you will hear three short beeps.</td> </tr> <tr> <td data-bbox="204 1193 527 1228">2 Voice</td> </tr> </table>	1 Fax	You can check whether your machine has received any fax or voice messages. If yes, you will hear one long beep. If no, you will hear three short beeps.	2 Voice					
1 Fax	You can check whether your machine has received any fax or voice messages. If yes, you will hear one long beep. If no, you will hear three short beeps.							
2 Voice								



Remote commands	Operation details
<b>98 Change the Receive Mode (Except for FAX-1940CN)</b> 1 External TAD 2 Fax/Tel 3 Fax Only	If you hear one long beep, your change has been accepted.
<b>98 Change the Receive Mode (FAX-1940CN only)</b> 1 Msg Ctr 2 Fax/Tel 3 Fax Only	If you hear one long beep, your change has been accepted.
<b>90 Exit</b>	Pressing <b>90</b> will allow you to exit Remote Retrieval. Wait for the long beep, then replace the handset.

## Retrieving fax messages

---

You can call your machine from any touch tone phone and have your fax messages sent to a fax machine.

- 1** Dial your fax number.
  - 2** When your machine answers, immediately enter your Remote Access Code (3 digits followed by \* ). If you hear one long beep, you have messages.
  - 3** As soon as you hear two short beeps, use the dial pad to press **962**.
  - 4** Wait for the long beep, and then use the dial pad to enter the number of the remote fax machine where you want your fax messages sent to followed by ## (up to 20 digits).
-  You cannot use \* and # as dial numbers. However, press # if you want to store a pause.
- 5** Hang up after you hear your machine beep. Your machine will call the other machine, which will then print your fax messages.

## Changing your Fax Forwarding number

---

You can change the default setting of your fax forwarding number from another telephone or fax machine using touch tone.

- 1** Dial your fax number.
  - 2** When your machine answers, immediately enter your Remote Access Code (3 digits followed by \* ). If you hear one long beep, you have messages.
  - 3** When you hear two short beeps, use the dial pad to press **954**.
  - 4** Wait for the long beep, and then use the dial pad to enter the new number of the remote fax machine where you want your fax messages forwarded followed by ## (up to 20 digits).
-  You cannot use \* and # as dial numbers. However, press # if you want to store a pause.
- 5** Hang up after you hear your machine beep.

# 7

## Message Center

(FAX-1940CN only)

### Message Center mode

Message Center mode allows you to store up to 99 incoming voice messages that are a maximum of 3 minutes each in the memory. Voice messages are stored on a “first-come, first-served” basis. You can retrieve voice messages remotely. (See *Remote Retrieval* on page 6-6.)

You must record an outgoing message in order to use the Message Center mode. (See *Recording Message Center Outgoing Message* on page 7-2.)

### Setting up the Message Center

---

You must set up the Message Center in the following order:

- 1** Record Message Center Outgoing Message (Msg Ctr OGM). (See *Recording Message Center Outgoing Message* on page 7-2.)
- 2** Press and hold  until it lights to activate the Message Center mode. (See *Activating Message Center mode* on page 7-3 and *Message indicator* on page 7-4.)

## Recording Message Center Outgoing Message

---

Recording the Message Center Outgoing Message (Msg Ctr OGM) is the first step you need to follow before you can turn on the Message Center. Make sure your OGM is less than 20 seconds long.

**1** Press **Menu/Set, 2, 7, 1**.

The LCD prompts you to choose an OGM.

1. OGM

**2** Press **▲** or **▼** to select

Msg Ctr OGM (not F/T OGM).

Msg Ctr OGM

Press **Menu/Set**.



**This is the only setting you can select if you want to turn on the Message Center.**

**3** Press **▲** or **▼** to select Record OGM.

Press **Menu/Set**.

**4** Pick up the handset to record a message.

**For example:** Hello. We are unable to take your call at this time. Please leave a message after the signal. If you wish to send a fax, please press \* **5 1**, wait for fax tones, then press the Start button.

**5** Replace the handset.

The Message Center will play your OGM.

**6** Press **Stop/Exit**.

## Listening to Outgoing Message (OGM)

- 1 Press **Menu/Set**, **2**, **7**, **1**. 1. OGM
- 2 Press **▲** or **▼** to select  
Msg Ctr OGM (or F/T OGM).  
Press **Menu/Set**.
- 3 Press **▲** or **▼** to select Play OGM.  
Press **Menu/Set**.  
Adjust the volume by pressing Volume **◀** or **▶** .
- 4 Press **Stop/Exit**.

## Erasing Outgoing Message (OGM)

- 1 Press **Menu/Set**, **2**, **7**, **1**. 1. OGM
- 2 Press **▲** or **▼** to select  
Msg Ctr OGM (or F/T OGM).  
Press **Menu/Set**.
- 3 Press **▲** or **▼** to select Erase OGM.  
Press **Menu/Set**.
- 4 Press **1** to erase the OGM.  
—OR—  
Press **2** to exit without erasing.
- 5 Press **Stop/Exit**.

## Activating Message Center mode

---

Press and hold  until it lights and the LCD shows: MC:Msg. Ctr.

When  light is out, the Message Center is OFF.  
(See *Setting up the Message Center* on page 7-1.)

## Message indicator

---

The  light flashes when you have *new* voice messages waiting for your review.

The LCD displays the total number of voice and fax messages stored in the Message Center memory.

Voice:03

Fax:00





Fax messages will be stored only when Fax Storage is turned on (**Menu/Set, 2, 5, 1**).

## Playing voice messages

---

Follow the steps below to listen to voice messages:

### 1 Press **Play/Record**.

Adjust the Volume by pressing  or .

All messages are played in the order they were recorded. The LCD shows the number of the current message, and the total number of messages.

If Caller ID information was received, the machine beeps during the message and displays the Caller ID information for one second.

During playback, the LCD shows the time and date the message was recorded.

### 2 Press \* (RWD) at the end of the message to repeat a message. Press # (FWD) to skip to the next message. You can press \* and # repeatedly until you reach the message you want to play.

### 3 Press **Stop/Exit**.

## Printing a fax message

---

Once you print a new fax message stored in memory, it is erased from the memory automatically.

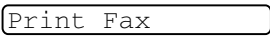
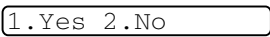
- 1 Press **Play/Record**. After two seconds, the fax machine begins to play voice messages.
- 2 If the Fax Storage is on and there are fax messages in memory, the LCD shows:  

- 3 To print the faxes, press **1**.  
—OR—  
Press **2** to exit without printing.  

## Erasing incoming messages

---

You can erase voice messages individually, or all at once.

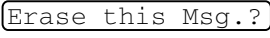
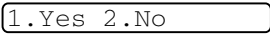
### To erase voice messages individually

- 1 Press **Play/Record**.  
The machine sounds a two-second beep and begins message playback. Each message is preceded by one long beep, and followed by two short beeps.
- 2 To erase a specific message, press **Erase** immediately after the two short beeps, or while the message is playing.  
  

- 3 Press **1** to erase the message.  
—OR—  
Press **2** to cancel.
- 4 Press **Stop/Exit**.

## To erase messages all at once

- 1 Press **Erase**. Erase All Voice?
- 2 Press **▲** or **▼** to select erasing all voice messages (**Voice:**), all document messages (**Fax**), or all voice and fax messages (**Erase All Msg.?**).  
Press **Menu/Set**. Select ▲▼ & Set
- 3 Press **1** to erase.  
—OR—  
Press **2** to cancel.
- 4 Press **Stop/Exit**.

## Setting Maximum Time for incoming messages

---

Your machine comes set to receive voice messages up to 30 seconds long. You can change this setting to 60, 120 or 180 seconds.

- 1 Press **Menu/Set, 2, 7, 2**. 2.ICM Max.Time
- 2 Press **▲** or **▼** to select the maximum time setting for incoming messages (30, 60, 120 or 180 seconds).  
Press **Menu/Set**.
- 3 Press **Stop/Exit**.

## Setting Toll Saver

---

See *Setting Toll Saver (Msg Ctr mode)* on page 4-6.



## ICM Recording Monitor

---

This feature lets you turn the speaker volume for voice messages **On** or **Off**. When you turn the monitor **Off**, you will not hear messages as they come in.

- 1 Press **Menu/Set**, **2**, **7**, **3**.
- 2 Use **▲** or **▼** to select **Off** (or **On**).  
Press **Menu/Set**.
- 3 Press **Stop/Exit**.

3.ICM Rec.Monitr

## Recording a conversation

---

If you are using the handset, you can record a telephone conversation by pressing **Play/Record** during the conversation. Your recording can be as long as the Incoming Message Maximum Time. The other party will hear an intermittent beep while recording. To stop recording, press **Stop/Exit**.

## Record Fax/Tel Outgoing Announcement (F/T OGM)

---

This is the announcement played by your Brother machine (not an external TAD) when someone calls and your machine is set to Fax/Tel receive mode. *Although callers hear your announcement, they cannot leave a message.* By choosing **F/T OGM** (not **Msg Ctr OGM**) you can record the announcement using the same steps as for the Message Center outgoing message. (See *Recording Message Center Outgoing Message* on page 7-2.) You can also listen to and erase the F/T OGM the same way, by choosing **F/T OGM** (not **Msg Ctr OGM**). (See *Listening to Outgoing Message (OGM)* on page 7-3 and *Erasing Outgoing Message (OGM)* on page 7-3.)

If you need to review the steps for setting up the Fax/Tel receive mode, see Chapter 4 *Setup Receive*.

# 8

# Printing reports

## Fax settings and activity

You need to set up the Transmission Verification Report and Journal Period in the menu table.

Press **Menu/Set, 2, 4, 1.**

1.Transmission

—OR—

Press **Menu/Set, 2, 4, 2.**

2.Journal Period

## Customizing the Transmission Verification Report

---

You can use the Transmission Report as proof that you sent a fax. This report lists the time and date of transmission and whether the transmission was successful (OK). If you select **On** or **On+Image**, the report will print for every fax you send.

If you send a lot of faxes to the same place, you may need more than the job numbers to know which faxes you must send again. Selecting **On+Image** or **Off+Image** will print a section of the fax's first page on the report to help you remember.



When the Verification Report is turned **Off** or **Off+Image**, the Report will only print if there is a transmission error, with **NG** in the **RESULT** column.

**1** Press **Menu/Set, 2, 4, 1.**

1.Transmission

**2** Press **▲** or **▼** to select **Off+Image, On, On+Image** or **Off.**

Press **Menu/Set.**

**3** Press **Stop/Exit.**

## Setting the Journal Period

---

You can set the machine to print a journal at specific intervals (every 50 faxes, 6, 12 or 24 hours, 2 or 7 days). If you set the interval to `Journal:Off`, you can print the report by following the steps on the next page.

The default setting is `Every 50 Faxes`.

**1** Press **Menu/Set, 2, 4, 2**.

`2.Journal Period`

**2** Press **▲** or **▼** to choose an interval.

Press **Menu/Set**.

(If you choose 7 days, the LCD will ask you to choose a day on which to begin the 7-day countdown.)

**3** Enter the time to begin printing in 24-hour format.

Press **Menu/Set**.

(For example: enter 19:45 for 7:45 PM.)

**4** Press **Stop/Exit**.



If you select 6, 12, 24 hours, 2 or 7 days, the machine will print the report at the selected time and then erase all jobs from its memory. If the machine's memory becomes full with 200 jobs before the time you selected has passed, the machine will print the Journal early and then erase all jobs from memory. If you want an extra report before it is due to print, you can print it without erasing the jobs from memory.



If you select `Every 50 Faxes`, the machine will print the Journal when the machine has stored 50 jobs.

# Printing reports

---

Following reports are available:

- |   |   |
|---|---|
| 1.Help List   | Prints the Help List so you can see at-a-glance how to quickly program your machine.                      |
| 2.Quick-Dial  | Lists names and numbers stored in the One-Touch and Speed-Dial memory, in numerical order.                |
| 3.Fax Journal   | Lists information about the last incoming and outgoing faxes.<br>(TX means Transmit.) (RX means Receive.) |
| 4.Transmission  | Prints a Transmission Verification Report for your last transmission.                                     |
| 5.User Settings<br>(FAX-1940CN and<br>MFC-3340CN only)  | Lists your settings.  |
| 6.Network Config<br>(FAX-1940CN and<br>MFC-3340CN only) | Lists your Network settings.  |

## How to print a report



- 1 For MFC-3240C, press **Menu/Set**, **4**.  
—OR—  
For MFC-3340CN, press **Menu/Set**, **6**.  
—OR—  
For FAX-1840C and FAX-1940CN, hold down **Shift** as you press **Ink/Reports**.
- 2 Press **▲** or **▼** to select the report you want.  
Press **Menu/Set**.  
—OR—  
Enter the number of the report you want to print.  
For example, press **1** to print the Help List.
- 3 Press **Black Start**.

# 9 Making copies

## Using the machine as a copier

You can use your machine as a copier, making up to 99 copies at a time.

### Enter Copy mode

Before making copies, make sure that  (**Copy**) is illuminated in green. If it is not, press  (**Copy**) to enter **Copy** mode. The default setting is Fax. You can change the number of seconds or minutes that the machine stays in Copy mode. (See *Setting the Mode Timer (FAX-1840C and FAX-1940CN)* on page 2-3 or *Setting the Mode Timer (MFC-3240C and MFC-3340CN)* on page 2-3.)

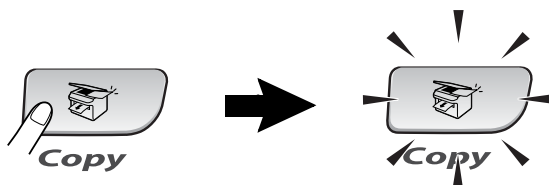

The LCD shows the default copy setting



The LCD display shows three columns of text: '100%', 'Normal', and '01'. Each column is connected by a vertical dashed line to a label below it.



Copy Ratio

Quality

No of Copies



## Making a single copy

---

- 1 Press  (**Copy**) to illuminate it in green.
  - 2 Load your document.  
(See *Load documents* on page 1-8.)
  - 3 Press **Black Start** or **Color Start**.
-  To stop copying, press **Stop/Exit**.

## Making multiple copies

---

- 1 Press  (**Copy**) to illuminate it in green.
  - 2 Load your document.
  - 3 Use the dial pad to enter the number of copies you want (up to 99).
  - 4 Press **Black Start** or **Color Start**.
-  (FAX-1940CN and MFC-3340CN only)  
To sort the copies, press the **Options** key. (See *Using the temporary Copy keys (Temporary settings)* on page 9-3.)

## Stop copying

---

To stop copying, press **Stop/Exit**.

# Using the temporary Copy keys (Temporary settings)

When you want to quickly change the copy settings temporarily for the next copy, use the temporary Copy keys. You can use different combinations.

Temporary Copy Keys

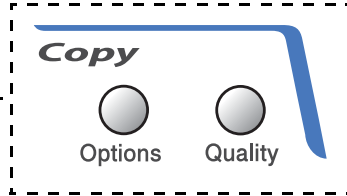

These settings are temporary, and the machine returns to its default settings 60 seconds after it finishes copying. However if you have set the Mode Timer to 0 or 30 seconds, the machine returns to the default settings after the number of seconds that has been set for mode timer. (See *Setting the Mode Timer (FAX-1840C and FAX-1940CN)* on page 2-3 or *Setting the Mode Timer (MFC-3240C and MFC-3340CN)* on page 2-3.)



You can save the copy settings you use most often by setting them as default. (See *Changing the default copy settings* on page 9-12.)

## Increasing copy speed or quality

You can select the copy quality. The default setting is **Normal**.



<p>Press <b>Quality</b></p>  <p>Quality</p> <p>and ▲ or ▼</p>	Normal	Recommended mode for ordinary printouts. Good copy quality with adequate copy speed.
	Fast	Fast copy speed and lowest ink consumption. Use <b>Fast</b> to save time (document to be proof-read, large documents or many copies).
	Best	Use this mode to copy precise images such as photographs. <b>Best</b> uses the highest resolution and slowest speed.

- 1 Press  (**Copy**) to illuminate it in green.
  - 2 Load your document.
  - 3 Use the dial pad to enter the number of copies you want (up to 99).
  - 4 Press **Quality**.
  - 5 Press ▲ or ▼ to choose the copy quality (**Fast**, **Normal** or **Best**).
- Press **Menu/Set**.
- 6 Press **Black Start** or **Color Start**.



## Changing the temporary copy settings

Use the **Options** key to quickly set the following copy settings temporarily for the next copy.

Press <b>Options</b> 	<b>Menu Selections</b>  select	<b>Options</b>  select	<b>Factory Setting</b>	<b>Page</b>
	Enlarge/Reduce	50%/69%/78%/83%/93%/97%/100%/104%/142%/186%/198%/200%/Custom (25-400%)	100%	9-6
	Paper Type	Plain/Inkjet/Glossy/Transparency	Plain	9-7
	Paper Size	Letter/Legal/A4/A5/4" (W) x 6" (H)	Letter	9-8
	Brightness	- □□□□ +	- □□□□ +	9-8
	Contrast	- □□□□ +	- □□□□ +	9-9
	Stack/Sort (FAX-1940CN and MFC-3340CN only)	Stack/Sort	Stack	9-9
	Page Layout	Off (1 in 1)/2 in 1 (P)/2 in 1 (L)/4 in 1 (P)/4 in 1 (L)	Off (1 in 1)	9-12
	No. of Copies	No. of Copies:01 (01-99)	01	

After you choose your settings by pressing **Menu/Set**, the LCD shows **Set** temporarily.

Press **Black Start** or **Color Start** if you're finished choosing settings.

—OR—

Press ▲ or ▼ to select more settings.

## Enlarging or reducing the image copied

You can select the following enlargement or reduction ratios.

Custom (25-400%) allows you to enter a ratio from 25% to 400%.

<b>Press Options</b>  Options and ▲ or ▼ to select Enlarge/Reduce	Custom (25-400%)
	200%
	198% 4"x6" →A4
	186% 4"x6" →LTR
	142% A5→A4
	104% EXE→LTR
	100%
	97% LTR→A4
	93% A4→LTR
	83% LGL→A4
	78% LGL→LTR
	69% A4→A5
	50%

- 1 Press  (**Copy**) to illuminate it in green.
- 2 Load your document.
- 3 Use the dial pad to enter the number of copies you want (up to 99).
- 4 Press **Options** and ▲ or ▼ to select Enlarge/Reduce.  
Press **Menu/Set**.

**5** Press ▲ or ▼ to select the enlargement or reduction ratio you want.

Press **Menu/Set**.

—OR—

You can select *Custom* (25–400%) and press **Menu/Set**.

Use the dial pad to enter an enlargement or reduction ratio from 25% to 400%.

Press **Menu/Set**.

(For example, press **5 3** to enter 53%.)

**6** Press **Black Start** or **Color Start**.



Special Copy Options 2 in 1 (P), 2 in 1 (L), 4 in 1 (P) or 4 in 1 (L) are not available with Enlarge/Reduce.

## Setting paper type

If you are copying on special paper, be sure to select the type of paper you are using so you will get the best print quality.

**1** Press  (**Copy**) to illuminate it in green.

**2** Load your document.

**3** Use the dial pad to enter the number of copies you want (up to 99).

**4** Press **Options** and ▲ or ▼ to select *Paper Type*.

Press **Menu/Set**.

**5** Press ▲ or ▼ to select the type of paper you are using (*Plain*, *Inkjet*, *Glossy* or *Transparency*).

Press **Menu/Set**.

**6** Press **Black Start** or **Color Start**.



You can change the default Paper Type setting at any time. (See *Setting the Paper Type* on page 2-4.)

## Setting paper size

If copying on paper other than Letter size, you will need to change the paper size setting.

 You can copy on Letter, Legal, A4, A5 or Photo Card (4"(W) x 6"(H)) paper.

- 1 Press  (**Copy**) to illuminate it in green.
- 2 Load your document.
- 3 Use the dial pad to enter the number of copies you want (up to 99).
- 4 Press **Options** and ▲ or ▼ to select `Paper Size`.  
Press **Menu/Set**.
- 5 Press ▲ or ▼ to select the size of paper you are using (`Letter, Legal, A4, A5 or 4 " (W) x 6 " (H)`).  
Press **Menu/Set**.
- 6 Press **Black Start** or **Color Start**.

## Adjusting brightness

You can adjust the copy brightness to make copies darker or lighter.

- 1 Press  (**Copy**) to illuminate it in green.
- 2 Load your document.
- 3 Use the dial pad to enter the number of copies you want (up to 99).
- 4 Press **Options** and ▲ or ▼ to select `Brightness`.  
Press **Menu/Set**.
- 5 Press ▲ to make a lighter copy.  
—OR—  
Press ▼ to make a darker copy.  
Press **Menu/Set**.
- 6 Press **Black Start** or **Color Start**.

## Adjusting contrast

You can adjust the copy contrast to help an image look sharper and more vivid.

- 1 Press  (**Copy**) to illuminate it in green.
- 2 Load your document.
- 3 Use the dial pad to enter the number of copies you want (up to 99).
- 4 Press **Options** and ▲ or ▼ to select *Contrast*.  
Press **Menu/Set**.
- 5 Press ▲ to increase the contrast.  
—OR—  
Press ▼ to decrease the contrast.  
Press **Menu/Set**.
- 6 Press **Black Start** or **Color Start**.

## Sorting copies (FAX-1940CN and MFC-3340CN only)

You can sort multiple copies. Pages will be stacked in the order 3-2-1, 3-2-1, 3-2-1, and so on.

- 1 Press  (**Copy**) to illuminate it in green.
- 2 Load your document.
- 3 Use the dial pad to enter the number of copies you want (up to 99).
- 4 Press **Options** and ▲ or ▼ to select *Stack/Sort*.  
Press **Menu/Set**.
- 5 Press ▲ or ▼ to select *Sort*.  
Press **Menu/Set**.
- 6 Press **Black Start** or **Color Start**.

## Making N in 1 copies (Page Layout)

You can reduce the amount of copies by using the N in 1 copy feature. This allows you to copy two or four pages on one page, which allows you to save paper.



- Please make sure Paper Size is set to Letter or A4.
- You can use N in 1 copy feature with 100% copy size only.
- (P) means Portrait and (L) means Landscape.

- 1 Press  (**Copy**) to illuminate it in green.
- 2 Load your document.
- 3 Use the dial pad to enter the number of copies you want (up to 99).
- 4 Press **Options** and ▲ or ▼ to select Page Layout.  
Press **Menu/Set**.
- 5 Press ▲ or ▼ to select 2 in 1 (P), 2 in 1 (L), 4 in 1 (P), 4 in 1 (L) or Off(1 in 1).  
Press **Menu/Set**.
- 6 Press **Black Start** or **Color Start** to scan the document.
- 7 The machine scans document and starts printing.



If Glossy has been selected in the Paper Type setting for N in 1 copies, the machine will print the images as if Plain paper had been selected.



- If you are producing multiple color copies, N in 1 copies are not available.
- N in 1 color copies are not available for FAX-1840C and MFC-3240C.

Place document *face down* in the direction shown below.

2 in 1 (P)



2 in 1 (L)



4 in 1 (P)

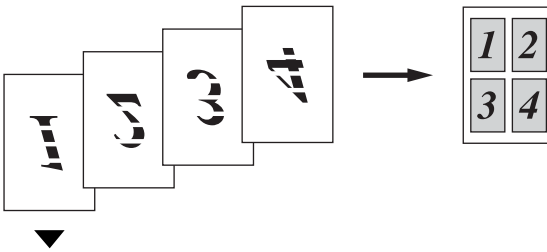

4 in 1 (L)

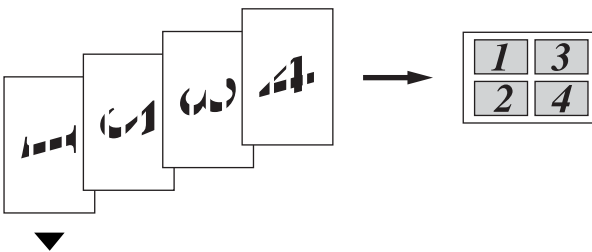

# Changing the default copy settings

You can save the copy settings you use most often by setting them as default. These settings will remain until you change them again.

## Increasing copy speed or quality

---

- 1 Press **Menu/Set**, **3**, **1**.
- 2 Press **▲** or **▼** to select **Normal**, **Best** or **Fast**.  
Press **Menu/Set**.
- 3 Press **Stop/Exit**.

1.Quality

## Adjusting brightness

---

- 1 Press **Menu/Set**, **3**, **2**.
- 2 Press **▲** to make a lighter copy.  
—OR—  
Press **▼** to make a darker copy.  
Press **Menu/Set**.
- 3 Press **Stop/Exit**.

2.Brightness

## Adjusting contrast

---

You can change the contrast to help an image look sharper and more vivid.

- 1 Press **Menu/Set**, **3**, **3**.
- 2 Press **▲** to increase the contrast.  
—OR—  
Press **▼** to decrease the contrast.  
Press **Menu/Set**.
- 3 Press **Stop/Exit**.

3.Contrast



## Adjusting color saturation

---

- 1 Press **Menu/Set**, **3**, **4**.
- 2 Press **▲** or **▼** to select Red, Green or Blue.  
Press **Menu/Set**.
- 3 Press **▲** to increase the color saturation.  
—OR—  
Press **▼** to decrease the color saturation.  
Press **Menu/Set**.
- 4 Return to Step 2 to select the next color.  
—OR—  
Press **Stop/Exit**.

4.Color Adjust

## Out of Memory message

---

If the memory becomes full while you are making copies, the LCD message will guide you through the next step.

If the `Out of Memory` message appears, press **Stop/Exit** to cancel or **Black Start** or **Color Start** to copy the scanned pages. You will need to clear some jobs from the memory before you can continue.



To gain extra memory, you can turn off Fax Storage.  
(See *Setting Fax Storage* on page 6-3.)

—OR—

Print the faxes that are in the memory.  
(See *Printing a fax from the memory* on page 4-10.)

When you get an `Out of Memory` message, you may be able to make copies if you first print incoming faxes in the memory to restore the memory to 100%.

# Legal limitations

Color reproductions of certain documents are illegal and may result in either criminal or civil liability. This memorandum is intended to be a guide rather than a complete listing of every possible prohibition. In case of doubt, we suggest that you check with counsel as to any particular questionable documents.

The following documents issued by the United States/Canadian Government or any of its Agencies may not be copied:

- Money
- Bonds or other certificates of indebtedness
- Certificates of Deposit
- Internal Revenue Stamps (canceled or uncanceled)
- Selective Service or draft papers
- Passports
- United States/Canadian Postage Stamps (canceled or uncanceled)
- Food Stamps
- Immigration Papers
- Checks or drafts drawn by Governmental agencies
- Identifying badges or insignias

Copyrighted works cannot be copied. Sections of a copyrighted work can be copied for 'fair use.' Multiple copies would indicate improper use.

Works of art should be considered the equivalent of copyrighted works.

Licenses and Certificates of Title to motor vehicles may not be copied under certain state/provincial laws.

# 10 Walk-Up PhotoCapture Center™

## (MFC-3340CN only)

## Introduction

Even if your machine is not connected to your computer, you can print photos directly from the digital camera media. Your Brother machine includes five media drives (slots) for use with popular digital camera media: CompactFlash®, SmartMedia®, Memory Stick®, SecureDigital™, and xD-Picture Card™.



CompactFlash®



SmartMedia®



Memory Stick®



SecureDigital™



xD-Picture Card™

The PhotoCapture Center™ feature lets you print digital photos from your digital camera at high resolution to get photo quality printing.



- miniSD™ can be used with miniSD™ adapter.
- Memory Stick Duo™ can be used with Memory Stick Duo™ adapter.
- Adapters are not included with the machine. Contact a third party supplier for adapters.

## PhotoCapture Center™ requirements

To avoid error conditions, please remember:

- The DPOF file on the media card must be in a valid format. (See *DPOF printing* on page 10-8.)
- The image file extension must be .JPG (Other image file extensions .JPEG, .TIF, .GIF and so on will not be recognized).
- Walk-up PhotoCapture Center™ printing must be performed separately from PhotoCapture Center™ operations using the PC. (Simultaneous operation is not available.)
- IBM Microdrive™ is not compatible with the machine.
- The machine can read up to 999 files in a media card.
- Use only Smart media cards with a 3.3v voltage rating.



When printing the INDEX or IMAGE, the PhotoCapture Center™ will print all the valid images, even if one or more images have been corrupted. A portion of the corrupted image may be printed.



Your machine is designed to read media cards that have been formatted by a digital camera.

When a digital camera formats a media card it creates a special folder into which it copies image data. If you need to modify the image data stored on a media card with your PC, we recommend that you do not modify the folder structure created by the digital camera. When saving new or modified image files to the media card we also recommend you use the same folder your digital camera uses. If the data is not saved to the same folder the machine may not be able to read the file or print the image.

# Getting started

Firmly insert the card into the appropriate slot.

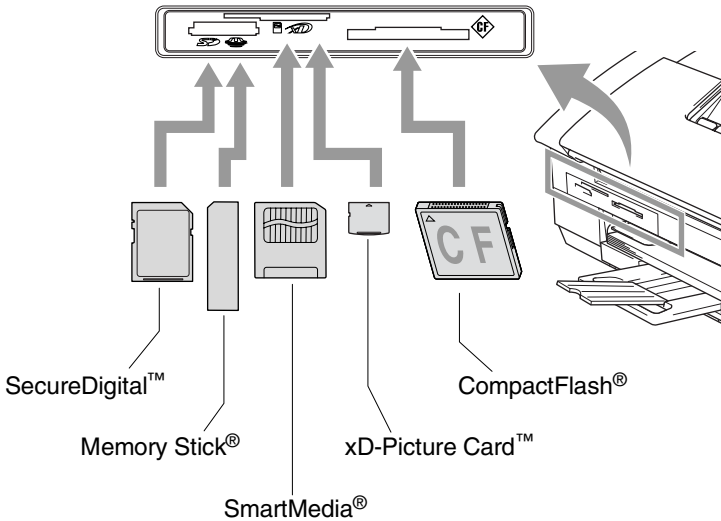

## PhotoCapture key lights:

- **PhotoCapture** light is ON, the media card is inserted properly.
- **PhotoCapture** light is OFF, the media card is not properly inserted.
- **PhotoCapture** light is BLINKING, the media card is being read or written to.

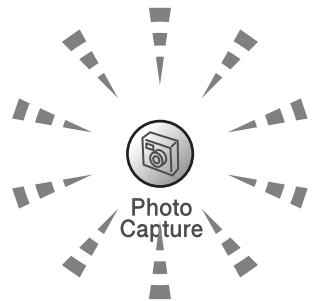

- ! Do NOT unplug the power cord or remove the media card from the media drive (slot) while the machine is reading or writing to the card (the **PhotoCapture** key is blinking). **You will lose your data or damage the card.**

The machine can only read one media card at a time so do not insert more than one card.

**The steps below give a brief outline of the Direct Printing feature. Please see the remaining pages of this chapter for more detailed instructions.**

- 1** Insert the media card firmly into the media drive (slot).

When you insert your media card into the proper slot, the LCD shows.

C.Flash Active

Press PhotoCapture key...



The media active message will be shown for 60 seconds and then disappear. Even in that case, you can enter the PhotoCapture mode by pressing **PhotoCapture**.

- 2** Press **PhotoCapture**.

If your digital camera supports DPOF printing, see *DPOF printing* on page 10-8.

- 3** Print the index which shows thumbnails views of images stored on your media card. Your machine will give an image number to each thumbnails.

Press **▲** or **▼** to select `Print Index` and then press **Menu/Set**.

Press **Color Start** to start printing the index sheet.

(See *Printing the Index (Thumbnails)* on page 10-5.)

- 4** To print images, press **▲** or **▼** to select `Print Images` and then press **Menu/Set**.

Enter the image number and press **Menu/Set**.

Press **Color Start** to start printing.

(See *Printing images* on page 10-6.)



You can change the settings for printing images, such as the Paper Type & Paper Size, Print Size and number of copies.

(See *Printing images* on page 10-6.)

# Printing the Index (Thumbnails)

The PhotoCapture Center™ assigns numbers for images (such as No.1, No.2, No.3, and so on).



→ No. 1  
DEI.JPG

01.01.2003  
100KB

It does not recognize any other numbers or file names that your digital camera or PC have used to identify the pictures. You can print a thumbnail page (Index page with 6 or 5 images per line). This will show all the pictures on the media card.

- 1 Make sure you have inserted the media card.  
Press **PhotoCapture**. (See page 10-3.)
- 2 Press **▲** or **▼** to select `Print Index`.  
Press **Menu/Set**.
- 3 Press **▲** or **▼** to select `6 Images/Line` or `5 Images/Line`.  
Press **Menu/Set**.

Index

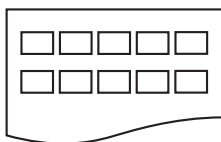

5 Images/Line

Index

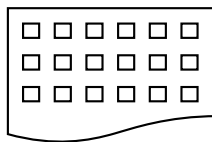

6 Images/Line

- 4 Press **Color Start** to start printing.
-  Print time for 5 Images/line will be slower than 6 Images/Line, but the quality is better. To print an image, see *Printing images* on page 10-6.

# Printing images

Before you can print an individual image, you have to know the image number.



Print the Index first.

(See *Printing the Index (Thumbnails)* on page 10-5.)

**1** Make sure you have inserted the media card.

Press **PhotoCapture**. (See page 10-3.)

**2** Press **▲** or **▼** to choose `Print Images`.

Press **Menu/Set**.



If your media card contains valid DPOF information, the LCD shows `DPOF Print:Yes, please go to DPOF printing` on page 10-8.

**3** Use the dial pad to enter the image number that you want to print from the Index page (Thumbnails).

Enter & Set Key

No.:1,3

Press **Menu/Set**.

Repeat this step until you have entered all the image numbers that you want to print.



You can enter all the numbers at one time by using the **\*** key for a comma or the **#** key for hyphen.

(For example, Enter **1\*3\*6** - to print images No.1, No.3 and No.6. Enter **1#5** to print images No.1 to No.5).

**4** After you have selected all the image numbers, press **Menu/Set** again, and go to Step 5.

—OR—

If you have finished choosing settings, press **Color Start**.



## Paper Type & Paper Size

- 5** Press **▲** or **▼** to select the type of paper you are using, Letter Glossy, 4"x 6" Glossy, 5"x 7" Glossy, A4 Glossy, Letter Plain, A4 Plain, Letter Inkjet, A4 Inkjet or 4"x 6" Inkjet.

Press **Menu/Set**.

If you selected Letter or A4, go to Step 6.

If you selected another size, go to Step 7.

—OR—

If you have finished choosing settings, press **Color Start**.

## Print Size





- 6** If you selected Letter or A4, press **▲** or **▼** to select the print size (4"x 3", 5"x 3.5", 6"x 4", 7"x 5", 8"x 6" or Max. Size).

Press **Menu/Set**, and go to Step 7.

—OR—

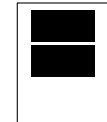
If you have finished choosing settings, press **Color Start**.

Printed Position for Letter paper

1 4"x 3"	2 5"x 3.5"	3 6"x 4"	4 7"x 5"	5 8"x 6"	6 Max. Size
					

## Number of Copies

- 7** Use the dial pad to enter the number of copies you want.

Press **Menu/Set**.

- 8** Press **Color Start** to print.



Your temporary settings will be kept until you take out the media card from the drive (slot), print images or press **Stop/Exit**.

# DPOF printing

---

DPOF stands for Digital Print Order Format.

Major Digital Camera manufacturers (Canon Inc., Eastman Kodak Company, Fuji Photo Film Co. Ltd., Matsushita Electric Industrial Co. Ltd. and Sony Corporation.) created this standard to make it easier to print images from a digital camera.

If your digital camera supports DPOF printing, you will be able to select on the Digital Camera display the images and number of copies you want to print.

When the memory card (CompactFlash<sup>®</sup>, SmartMedia<sup>®</sup>, Memory Stick<sup>®</sup>, SecureDigital<sup>™</sup> and xD-Picture Card<sup>™</sup>) with DPOF information is put into your machine, you can print the selected image easily.

- 1 Insert your media card into the proper drive (slot).

C.Flash Active

Press PhotoCapture key...



The media active message will be shown for 60 seconds and then disappear. Even in that case, you can enter the PhotoCapture mode by pressing **PhotoCapture**.

- 2 Press **PhotoCapture**.
- 3 Press **▲** or **▼** to select `Print Images`.  
Press **Menu/Set**.

- 4 If there is a DPOF file on the card, the LCD shows:

Select ▲▼ & Set

DPOF Print:Yes

- 5 Press **▲** or **▼** to select `Yes`.  
Press **Menu/Set**.

Select ▲▼ & Set

DPOF Print:No



If you want to choose the images and their print options now, select `No`.

- 6 Press **Color Start** to print.

## Changing the default settings

---

You can save the PhotoCapture Center™ settings you use most often by setting them as default. These settings will remain until you change them again.

### Increasing print speed or quality

**1** Press **Menu/Set, 4, 1.**

1.Print Quality

**2** Press **▲** or **▼** to select **Normal** or **Photo.**

Press **Menu/Set.**

**3** Press **Stop/Exit.**

### Setting the paper & size

**1** Press **Menu/Set, 4, 2.**

2.Paper & Size

**2** Press **▲** or **▼** to select

Letter Glossy, 4"x 6" Glossy, 5"x 7" Glossy, A4 Glossy, Letter Plain, A4 Plain, Letter Inkjet, A4 Inkjet or 4"x 6" Inkjet.

Press **Menu/Set.**

If you selected Letter or A4, press **▲** or **▼** to select the print size (4"x 3", 5"x 3.5", 6"x 4", 7"x 5", 8"x 6" or Max. Size).

Press **Menu/Set.**

**3** Press **Stop/Exit.**

## Adjusting brightness

- 1 Press **Menu/Set**, **4**, **3**.
- 2 Press **▲** to make a lighter print.  
—OR—  
Press **▼** to make a darker print.  
Press **Menu/Set**.
- 3 Press **Stop/Exit**.

3.Brightness

## Adjusting contrast

You can choose the contrast setting. More contrast will make an image look sharper and more vivid.

- 1 Press **Menu/Set**, **4**, **4**.
- 2 Press **▲** to increase the contrast.  
—OR—  
Press **▼** to decrease the contrast.  
Press **Menu/Set**.
- 3 Press **Stop/Exit**.

4.Contrast

## Color enhancement (True2Life®)

You can turn on the color enhancement (True2Life®) feature to print more vivid images. Printing time will be slower.

- 1 Press **Menu/Set**, **4**, **5**.
- 2 Press **▲** or **▼** to select **On**.  
Press **Menu/Set**.  
—OR—

5.True2Life

Select **Off** and press **Menu/Set**, then go to Step 5.



If you select **On**, you can customize the White Balance, Sharpness or Color Density.

**3** Press **▲** or **▼** to select **White Balance**, **Sharpness** or **Color Density**.

Press **Menu/Set**.

**4** Press **▲** or **▼** to adjust the degree of the setting.

Press **Menu/Set**.

**5** Press **Stop/Exit**.

### ■ **White Balance**

This setting adjusts the hue of the white areas of an image. Lighting, camera settings and other influences will effect the appearance of white. The white areas of a picture may be slightly pink, yellow or some other color. By using this adjustment you can correct this effect and bring the white areas back to pure white.

### ■ **Sharpness**

This setting enhances the detail of an image. It is similar to adjusting the fine focus on a camera. If the image is not in true focus and you cannot see the fine details of the picture, then adjust the sharpness.

### ■ **Color Density**

This setting adjusts the total amount of color in the image. You can increase or decrease the amount of color in an image to improve a washed out or weak picture.

## Cropping

If your photo is too long or wide to fit the available space on your selected layout, part of the image will be automatically cropped.

The default setting is **Cropping:On**. If you want to print the whole image, turn this setting to **Off**.

- 1 Press **Menu/Set**, **4**, **6**.
- 2 Press **▲** or **▼** to select **Off** (or **On**).  
Press **Menu/Set**.
- 3 Press **Stop/Exit**.

Cropping:On

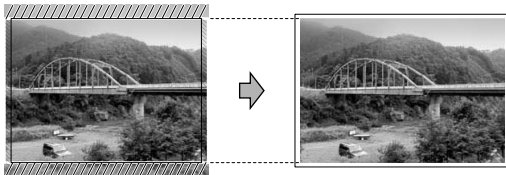

Cropping:Off

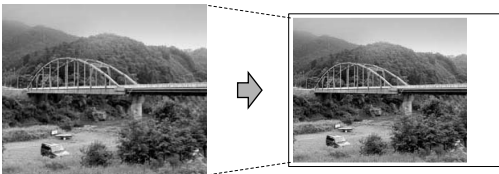

## Borderless

This feature expands the printable area to the edges of the paper. Printing time will be slightly slower.

- 1 Press **Menu/Set**, **4**, **7**.
- 2 Press **▲** or **▼** to select **Off** (or **On**).  
Press **Menu/Set**.
- 3 Press **Stop/Exit**.

## Understanding the Error Messages

---

Once you are familiar with the types of errors that can occur while you're using the PhotoCapture Center™, you can easily identify and troubleshoot any difficulties.

When an error message appears on the LCD, the machine will beep to get your attention.

**Media Error**—This message will appear if you insert a media card that is either bad or not formatted, or when there is a problem with the media drive. To clear this error, take out the media card.

**No File**—This message will appear if you try to access a media card in the drive (slot) that does not contain a .JPG file.

**Out of Memory**—This message will appear if you are working with images that are too large for the machine's memory.

# Using PhotoCapture Center™ from your PC

You can access the media card that is in the media drive (slot) of the machine from your PC.

(See *Using the PhotoCapture Center™ from your PC* on page 6-1 in Software User's Guide on the CD-ROM or *Using the PhotoCapture Center™ from a Macintosh®* (not available for MFC-3240C and MFC-5440CN) on page 8-45 in the Software User's Guide on the CD-ROM.)

# Using PhotoCapture Center™ for scanning documents

You can scan documents and save them on a media card to quickly and easily make documents portable. (See *Scan to Card* (not available for MFC-3240C, MFC-210C and MFC-5440CN) on page 2-23 in Software User's Guide on the CD-ROM.)



# 11 Important information

## Standard telephone and FCC Notices

**These notices are in effect on models sold and used in the United States only.**

---

**This equipment is hearing-aid compatible. (FAX-1840C and FAX-1940CN only)**

**When programming emergency numbers or making test calls to emergency numbers:**

- Remain on the line and briefly explain to the dispatcher the reason for the call before hanging up.
- Perform these activities in the off-peak hours, such as early morning or late evening.

This equipment complies with Part 68 of the FCC rules and the requirements adopted by the ACTA. On the backside of this equipment is a label that contains, among other information, a product identifier in the format US: AAAEQ##TXXXX. If requested, this number must be provided to the telephone company.

You may safely connect this equipment to the telephone line by means of a standard modular jack, USOC RJ11C.

A plug and jack used to connect this equipment to the premises wiring and telephone network must comply with the applicable FCC Part 68 rules and requirements adopted by the ACTA. A compliant telephone cord and modular plug is provided with this product. It is designed to be connected to a compatible modular jack that is also compliant. See installation instructions for details.

The REN is used to determine the number of devices that may be connected to a telephone line. Excessive RENs on a telephone line may result in the devices not ringing in response to an incoming call. In most but not all areas, the sum of RENs should not exceed five (5.0). To be certain of the number of devices that may be connected to a line, as determined by the total RENs, contact the local telephone company. For products approved after July 23, 2001, the REN for this product is part of the product identifier that has the format US:AAAEQ##TXXXX. The digits represented by ## are the REN without a decimal point (e.g., 06 is a REN of 0.6). For earlier products, the REN is separately shown on the label.

If this equipment causes harm to the telephone network, the telephone company will notify you in advance that temporary discontinuance of service may be required. But if advance notice isn't practical, the telephone company will notify the customer as soon as possible. Also, you will be advised of your right to file a complaint with the FCC if you believe it is necessary.

The telephone company may make changes in its facilities, equipment, operations or procedures that could affect the operation of the equipment. If this happens the telephone company will provide advance notice in order for you to make necessary modifications to maintain uninterrupted service.

If trouble is experienced with this equipment, for repair or warranty information, please contact Brother Customer Service. (See *Brother numbers* on page i.) If the equipment is causing harm to the telephone network, the telephone company may request that you disconnect the equipment until the problem is resolved.

Connection to party line service is subject to state tariffs. Contact the state public utility commission, public service commission or corporation commission for information.

If your home has specially wired alarm equipment connected to the telephone line, make sure the installation of this equipment does not disable your alarm equipment. If you have questions about what will disable alarm equipment, call your telephone company or a qualified installer.

If you are not able to solve a problem with your machine, call Brother Customer Service. (See *Brother numbers* on page i.)

### **WARNING**

For protection against the risk of electrical shock, always disconnect all cables from the wall outlet before servicing, modifying or installing the equipment.

This equipment may not be used on coin service lines provided by the telephone company or connected to party lines.

Brother cannot accept any financial or other responsibilities that may be the result of your use of this information, including direct, special or consequential damages. There are no warranties extended or granted by this document.

**⚠ WARNING**

This machine has been certified to comply with FCC standards, which are applied to the USA only. A grounded plug should be plugged into a grounded AC power outlet after checking the rating of the local power supply for the machine to operate properly and safely.

## **Federal Communications Commission (FCC) Declaration of Conformity (USA only)**

---

Responsible Party: Brother International Corporation  
100 Somerset Corporate Boulevard  
Bridgewater, NJ 08807-0911 USA  
TEL: (908) 704-1700

declares, that the products

Product Name: FAX-1840C, FAX-1940CN, MFC-3240C, MFC-3340CN  
comply with Part 15 of the FCC Rules. Operation is subject to the following two conditions: (1) This device may not cause harmful interference, and (2) this device must accept any interference received, including interference that may cause undesired operation.

This equipment has been tested and found to comply with the limits for a Class B digital device, pursuant to Part 15 of the FCC Rules. These limits are designed to provide reasonable protection against harmful interference in a residential installation. This equipment generates, uses, and can radiate radio frequency energy and, if not installed and used in accordance with the instructions, may cause harmful interference to radio communications. However, there is no guarantee that interference will not occur in a particular installation. If this equipment does cause harmful interference to radio or television reception, which can be determined by turning the equipment off and on, the user is encouraged to try to correct the interference by one or more of the following measures:

- Reorient or relocate the receiving antenna.
- Increase the separation between the equipment and receiver.
- Connect the equipment into an outlet on a circuit different from that to which the receiver is connected.
- Call the dealer or an experienced radio/TV technician for help.

## **Important**

Changes or modifications not expressly approved by Brother Industries, Ltd. could void the user's authority to operate the equipment.

## **Industry Canada Compliance Statement (Canada only)**

---

This Class B digital apparatus complies with Canadian ICES-003.  
Cet appareil numérique de la classe B est conforme à la norme NMB-003 du Canada.

## **For your safety**

---

To ensure safe operation the supplied three-pin plug must be inserted only into a standard three-pin AC power outlet that is effectively grounded through the normal household wiring.

The fact that the equipment operates satisfactorily does not imply that the power is grounded and that the installation is completely safe. For your safety, if in any doubt about the effective grounding of the power, call a qualified electrician.

## **LAN connection (FAX-1940CN and MFC-3340CN only)**

---



### **Caution**

Do not connect this product to a LAN connection that is subject to over-voltages.

# International ENERGY STAR® Compliance Statement

---

The purpose of the International ENERGY STAR® Program is to promote the development and popularization of energy-efficient office equipment.

As an ENERGY STAR® Partner, Brother Industries, Ltd. has determined that this product meets the ENERGY STAR® guidelines for energy efficiency.



## Important safety instructions

---

- 1** Read all of these instructions.
- 2** Save them for later reference.
- 3** Follow all warnings and instructions marked on the product.
- 4** Unplug this product from the wall outlet before cleaning. Do not use liquid or aerosol cleaners. Use a damp cloth for cleaning.
- 5** Do not use this product near water.
- 6** Do not place this product on an unstable cart, stand, or table. The product may fall, causing serious damage to the product.
- 7** Slots and openings in the cabinet and the back or bottom are provided for ventilation; to ensure reliable operation of the product and to protect it from overheating, these openings must not be blocked or covered. The openings should never be blocked by placing the product on a bed, sofa, rug, or other similar surface. This product should never be placed near or over a radiator or heater. This product should never be placed in a built-in installation unless proper ventilation is provided.
- 8** This product should be operated from the type of power source indicated on the label. If you are not sure of the type of power available, call your dealer or local power company.  
Use only the power cord supplied with this machine.
- 9** This product is equipped with a 3-wire grounded plug, a plug having a third (grounded) pin. This plug will only fit into a grounded power outlet. This is a safety feature. If you are unable to insert the plug into the outlet, call your electrician to replace your obsolete outlet. Do not defeat the purpose of the grounded plug.
- 10** Do not allow anything to rest on the power cord. Do not place this product where people can walk on the cord.
- 11** If an extension cord is used with this product, make sure that the total ampere ratings on the products plugged into the extension cord do not exceed the extension cord ampere rating. Also, make sure that the total of all products plugged into the AC power outlet does not exceed 15 amperes (USA only).

- 12** Do not place anything in front of the machine that will block received faxes. Do not place anything in the path of received faxes.
- 13** Wait until pages have exited the machine before picking them up.
- 14** Never push objects of any kind into this product through cabinet slots, since they may touch dangerous voltage points or short out parts resulting in the risk of fire or electric shock. Never spill liquid of any kind on the product. Do not attempt to service this product yourself because opening or removing covers may expose you to dangerous voltage points and other risks and may void your warranty. Refer all servicing to a Brother Authorized Service Center. For the location of your nearest Brother Authorized Service Center, please call  
**In USA:** 1-800-284-4357 or **In Canada:** 1-877-BROTHER.  
(See *Brother numbers* on page i.)
- 15** Unplug this product from the AC power outlet and refer servicing to Authorized Service Personnel under the following conditions:
- When the power cord is damaged or frayed.
  - If liquid has been spilled into the product.
  - If the product has been exposed to rain or water.
  - If the product does not operate normally when the operating instructions are followed. Adjust only those controls that are covered by the operating instructions. Improper adjustment of other controls may result in damage and will often require extensive work by a qualified technician to restore the product to normal operation.
  - If the product has been dropped or the cabinet has been damaged.
  - If the product exhibits a distinct change in performance, indicating a need for service.
- 16** To protect your product against power surges, we recommend the use of a power protection device (Surge Protector).

## Trademarks

---

The Brother logo is a registered trademark of Brother Industries, Ltd.

Brother is a registered trademark of Brother Industries, Ltd.

Multi-Function Link is a registered trademark of Brother International Corporation.

© 2004 Brother Industries, Ltd. All rights reserved.

Windows and Microsoft are registered trademarks of Microsoft in the U.S. and other countries.

Macintosh and TrueType are registered trademarks of Apple Computer, Inc.

PaperPort and OmniPage OCR are registered trademarks of ScanSoft, Inc.

Presto! PageManager is a registered trademark of NewSoft Technology Corporation.

Microdrive is a trademark of International Business Machine Corporation.

SmartMedia is a registered trademark of Toshiba Corporation.

CompactFlash is a registered trademark of SanDisk Corporation.

Memory Stick is a registered trademark of Sony Corporation.

SecureDigital is a trademark of Matsushita Electric Industrial Co.Ltd., SanDisk Corporation and Toshiba Corporation.

SanDisk is a licensee of the SD and miniSD trademarks.

xD-Picture Card is a trademark of Fujifilm Co.Ltd., Toshiba Corporation and Olympus Optical Co. Ltd.

Memory Stick Duo and MagicGate are trademarks of Sony Corporation.

Each company whose software title is mentioned in this manual has a Software License Agreement specific to its proprietary programs.

**All other brand and product names mentioned in this User's Guide, the Software User's Guide (MFC-3240C and MFC-3340CN only), and the Network User's Guide (FAX-1940CN and MFC-3340CN only) are registered trademarks of their respective companies.**



# 12 Troubleshooting and routine maintenance

## Troubleshooting

### IMPORTANT

For technical help, you must call the country where you bought the machine. Calls must be made **from within** that country.

### Error messages

As with any sophisticated office product, errors may occur. If this happens, your machine identifies the problem and displays an error message. The most common error messages are shown below.

You can correct most problems by yourself. If you need additional help, the Brother Solutions Center offers latest FAQs and troubleshooting tips.

Visit us at <http://solutions.brother.com>.

ERROR MESSAGES		
ERROR MESSAGE	CAUSE	ACTION
Comm. Error	Poor phone line quality caused a communication error.	Try the call again. If the problem continues, call the telephone company and ask them to check your phone line.
Connection Fail	You tried to poll a fax machine that is not in Polled Waiting mode.	Check the other fax machine's polling setup.
Cover is Open	Top cover is not closed completely.	Open, then close the top cover.
Data Remaining	Print data remains in the machine's memory.	Re-start printing from your computer.
	Print data remains in the machine's memory. The USB cable was unplugged while the computer was sending the data to the machine.	Press <b>Stop/Exit</b> . The machine will cancel the job and eject the page that is being printed.
Disconnected	The other person or other person's fax machine stopped the call.	Try to send or receive again.

ERROR MESSAGES		
ERROR MESSAGE	CAUSE	ACTION
Document Jam	The document scanned from ADF was longer than about 35.4 inches.	See <i>Using the automatic document feeder (ADF)</i> on page 1-8.
	The document is jammed in the machine.	See <i>Document Jam</i> on page 12-5
DR Mode in Use	The machine is set to Distinctive Ring mode. You can not change the Receive Mode from Manual to another mode.	Set Distinctive Ring to Off. (See <i>Turning off the Distinctive Ring</i> on page A-4.)
High Temperature	The print head is too warm.	Allow the machine to cool down.
Ink Empty	One or more of the ink cartridges is empty. The machine will stop all print operations. While memory is available, black and white faxes will be received into memory. If a sending machine has a color fax, the machine's 'handshake' will request that the fax be sent as black and white. If the sending machine has the ability to convert it, the color fax will be received into memory as a black and white fax.	Replace the ink cartridges. (See <i>Replacing the ink cartridges</i> on page 12-25.)
Low Temperature	The print head is too cold.	Allow the machine to warm up.
Media Error (MFC-3340CN only)	The media card is either corrupted, improperly formatted, or there is a problem with the media drive.	Re-insert the card firmly into the slot to make sure it is in the proper position. If the error remains, check the media drive by inserting another media card that you know is working.
Near Empty	One or more of the ink cartridges are running out of ink. If a sending machine has a color fax, the machine's 'handshake' will request that the fax be sent as black and white. If the sending machine has the ability to convert it, the color fax will be received into memory as a black and white fax.	Order a new ink cartridge. (See <i>Ordering accessories and supplies</i> on page ii.)
No Cartridge	An ink cartridge is not properly installed.	Take out the ink cartridge and put it in again seating it properly. (See <i>Replacing the ink cartridges</i> on page 12-25.)
No File (MFC-3340CN only)	The media card in the media drive does not contain a .JPG file.	Reinsert the correct media card.

ERROR MESSAGES		
ERROR MESSAGE	CAUSE	ACTION
No Paper Fed	The machine is out of paper.	Add paper, and then press <b>Black Start</b> or <b>Color Start</b> .
	The paper is jammed in the machine.	See <i>Printer jam or paper jam</i> on page 12-6.
No Response/Busy	The number you dialed does not answer or is busy.	Verify the number and try again.
Not Registered	You tried to access a One-Touch or Speed-Dial number that is not programmed.	Set up the One-Touch or Speed-Dial number. (See <i>Storing One-Touch Dial numbers</i> on page 5-1 and <i>Storing Speed-Dial numbers</i> on page 5-2.)
Out of Memory	The machine's memory is full.	(Fax sending or copy operation in process) Press <b>Stop/Exit</b> and wait until the other operations in progress finish and then try again. —OR— Clear the data in the memory. To gain extra memory, you can turn off Fax Storage. (See <i>Setting Fax Storage</i> on page 6-3.) —OR— Print the faxes that are in the memory. (See <i>Printing a fax from the memory</i> on page 4-10.) (Printing operation in process) Reduce print resolution.
Paper Jam	Paper is jammed in the machine.	(See <i>Printer jam or paper jam</i> on page 12-6.)
Wrong Paper Size	Paper is not the correct size.	Reload the correct size of paper (Letter, Legal or A4), and then press <b>Black Start</b> or <b>Color Start</b> .

ERROR MESSAGES		
ERROR MESSAGE	CAUSE	ACTION
Unable to Change	The machine has a mechanical problem.	<p>Close the document support and the document tray. Open the top cover and remove any foreign obstacles from inside the machine. If the error message continues, please follow the steps below before disconnecting the machine so you will not lose any important messages. Then, disconnect the machine from the power source for several minutes (which will erase all faxes), and then reconnect it.</p> <p><b>Check whether the machine has faxes in the memory</b></p> <ol style="list-style-type: none"> <li>1. Press <b>Menu/Set</b>, <b>9, 0, 1</b>.</li> <li>2. If the machine has no faxes, disconnect the machine from the power source for several minutes, and then reconnect it.</li> </ol> <p>—OR—</p> <p>If faxes are present, you can transfer them to another fax machine. Go to Step 3.</p> <p>—OR—</p> <p>For MFC-3340CN, you can forward the faxes to your PC. Please see <b>Transfer faxes to your PC</b>.</p> <p><b>Transfer faxes to another fax machine</b></p> <p>If you have not set up your Station ID, you cannot enter fax transfer mode.</p> <ol style="list-style-type: none"> <li>3. Enter the fax number to which faxes will be forwarded.</li> <li>4. Press <b>Black Start</b>.</li> <li>5. After the faxes are transferred, disconnect the machine from the power source for several minutes, and then reconnect it.</li> </ol> <p>You can transfer the Fax Journal report to another fax machine by pressing <b>Menu/Set</b>, <b>9, 0, 2</b> in Step1.</p> <p><b>Transfer faxes to your PC (MFC-3340CN only)</b></p> <p>You can move the faxes from your machine's memory to your PC.</p> <ol style="list-style-type: none"> <li>1. Press <b>Menu/Set</b>, <b>2, 5, 1</b>.</li> <li>2. Using <b>▲</b> or <b>▼</b>, select 1. <b>PC Fax Receive</b>, and then press <b>Menu/Set</b>. The LCD will ask if you want to transfer a fax to your PC.</li> <li>3. To transfer all faxes to your PC, press 1. —OR— To keep all faxes in the machine's memory, press 2.</li> <li>4. After the faxes are transferred, disconnect the machine from the power source for several minutes, and then reconnect it. (For details see <i>Using Brother PC-FAX software</i> on page 5-1 in Software User's Guide on the CD-ROM.)</li> </ol>
Unable to Clean	A foreign obstacle, such as a clip or ripped paper, is in the machine.	
Unable to Init.		
Unable to Print		
Unable to Scan		

## Document Jam

---

If the document is jammed, follow the steps below.

### Document is jammed inside the front of the machine.

- 1** Remove any paper from the ADF that is not jammed.
- 2** Pull the jammed document out toward the front of the machine.

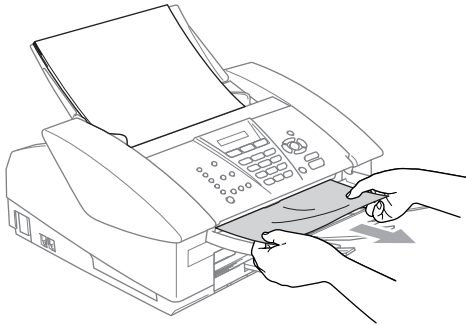

- 3** Press **Stop/Exit**.

## Printer jam or paper jam

---

Remove the jammed paper depending on where it is jammed in the machine.

### Paper is jammed inside the paper tray

- 1 Pull the paper tray out of the machine.

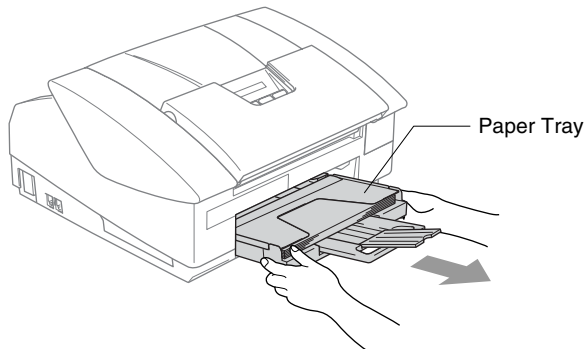

- 2 Slowly pull out the jammed paper to remove it.

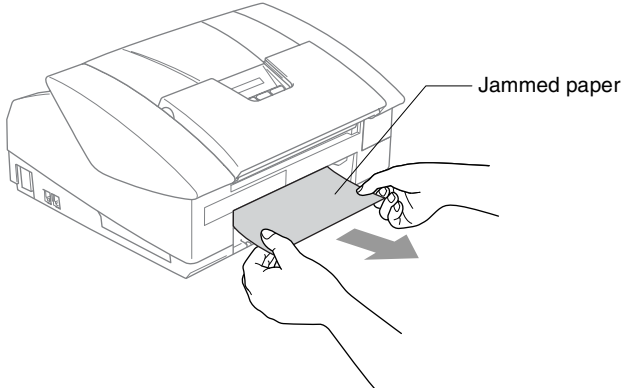

## Paper is jammed inside the machine

- 1 Remove the jam clear cover. Pull the jammed paper out of the machine.

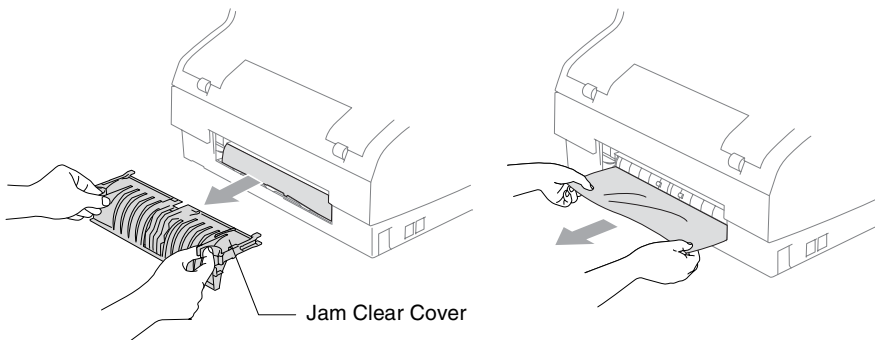

- 2 Re-insert the jam clear cover.
- 3 If you can not pull out the jammed paper, close the document support and the document tray and lift the open cover to the open position until it locks securely into place.
- 4 Remove the jammed paper.

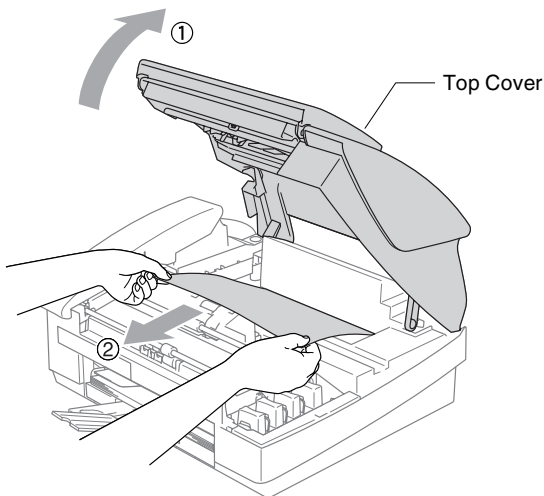

If the paper is jammed underneath the print head, disconnect the machine from the power source so you can move the print head to take out the paper.

**5** Close the top cover.

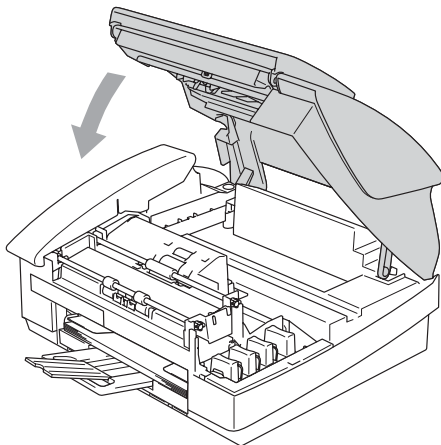



## If you are having difficulty with your machine

If you think there is a problem with your machine, check the chart below and follow the troubleshooting tips.

The Brother Solutions Center offers the latest FAQs and troubleshooting tips.

Visit us at <http://solutions.brother.com>.

DIFFICULTY	SUGGESTIONS
<b>Printing</b>	
No printout	Check the interface cable connection on both the machine and your computer.
	Check the machine is plugged in and <b>On/Off</b> key turned On.
	One or more ink cartridges are empty. (See <i>Replacing the ink cartridges</i> on page 12-25.)
	Check to see if the LCD is showing an error message. (See <i>Error messages</i> on page 12-1.)
Poor quality print.	Check the print quality. (See <i>Checking the print quality</i> on page 12-16.)
	Make sure the Printer Driver or Paper Type setting in the menu matches the type of paper you are using. (See <i>Media Type</i> on page 1-8 in Software User's Guide on the CD-ROM and <i>Setting the Paper Type</i> on page 2-4.)
	Make sure your ink cartridges are fresh. Cartridges remain fresh for up to two years if kept in their original packaging, after that the ink may become clogged. Cartridge expiration dates are printed on the package.
	Try using the recommended types of paper. (See <i>About paper</i> on page 1-10.)
	The recommended environment for your machine is between 68°F to 91°F.
White horizontal lines appear in text or graphics.	Clean the print head. (See <i>Cleaning the print head</i> on page 12-15.)
	Try using the recommended types of paper. (See <i>About paper</i> on page 1-10.)
	If horizontal bands appear when using plain paper, use the 'Enhanced Normal Printing' mode to help avoid banding on some types of plain paper. In the printer driver 'Basic' tab, click 'Settings', and check 'Enhanced Normal Printing'. If you continue to have horizontal bands, change the Media Type selection to 'Slow Drying Paper' in the printer driver 'Basic' tab to help enhance the print quality.
The machine prints blank pages.	Clean the print head. (See <i>Cleaning the print head</i> on page 12-15.)
Characters and lines are stacked.	Check the printing alignment. (See <i>Checking the printing alignment</i> on page 12-18.)
Printed text or images are skewed.	Make sure the paper is loaded properly in the paper tray and the paper side guide is adjusted correctly. (See <i>How to load paper, envelopes and post cards</i> on page 1-15.)

DIFFICULTY	SUGGESTIONS
<b>Printing</b> (Continued)	
Smudged stain at the top center of the printed page.	Make sure the paper is not too thick or not curled. (See <i>About paper</i> on page 1-10.)
Printing appears dirty or ink seems to run.	Make sure you are using the proper types of paper. (See <i>About paper</i> on page 1-10.) Don't handle the paper until the ink is dry.
Stains appear on the reverse side or at the bottom of the page.	Make sure the Printer Platen is not dirty with ink. (See <i>Cleaning the machine Printer Platen</i> on page 12-24.)
	Make sure you are using the paper support flap. (See <i>How to load paper, envelopes and post cards</i> on page 1-15.)
There are some dense lines.	Check 'Reverse Order' in the Basic tab of the printer driver.
The printouts are wrinkled.	In the printer driver 'Basic' tab, click the 'Settings', and uncheck the 'Bi-Directional Printing'.
Cannot perform '2 in 1 or 4 in 1' printing.	Check that the paper size setting in the application and in the printer driver are the same.
Print speed is too slow.	Changing the printer driver setting may improve the print speed. Highest resolution needs longer data processing, transfer and printing time. Try the other settings of quality in the printer driver 'Basic' tab. Also, click the 'Settings' tab, and make sure you uncheck the True2Life®.
	Borderless printing is slower than normal printing. If you want to print more quickly, set the Borderless feature off. (See <i>Media Type</i> on page 1-8 in Software User's Guide on the CD-ROM.)
True2Life® is not working properly.	If the image data is not full color in your application (Such as 256 color), True2Life® will not work. Please use at least 24 bit color data with the True2Life® feature.
Machine feeds multiple pages	Make sure the paper is loaded properly in the paper tray. (See <i>How to load paper, envelopes and post cards</i> on page 1-15.)
	Check that more than two types of paper are not loaded in the paper tray at any one time.
Printed pages are not stacked neatly.	Make sure you are using the paper support flap. (See <i>How to load paper, envelopes and post cards</i> on page 1-15.)
Machine does not print from Paint Brush.	Try setting the Display setting to '256 colors.'
Machine does not print from Adobe Illustrator.	Try to reduce the print resolution.
<b>Printing Received Faxes</b>	
Condensed print and white streaks across the page or the top and bottom of sentences are cut off.	This can be caused by static or interference on the telephone line. You can make a copy using the <b>Black Start</b> key to see if the same problem occurs. If the copy looks good then the problem is probably the phone line and not your machine.
Vertical black lines when receiving.	The sender's scanner may be dirty. Ask the sender to make a copy to see if the problem is with the sending machine. Try receiving from another fax machine.

DIFFICULTY	SUGGESTIONS
<b>Printing Received Faxes</b> (Continued)	
Received color fax prints only in black and white.	Replace the color ink cartridges that are empty or nearly empty, and then ask the other person to send the color fax again. (See <i>Replacing the ink cartridges</i> on page 12-25.) Check that Fax Storage is set to OFF. (See <i>Setting Fax Storage</i> on page 6-3.)
Left and Right margins are cut off or a single page is printed on two pages.	Turn on Auto Reduction. (See <i>Printing a reduced incoming fax (Auto Reduction)</i> on page 4-10.)
<b>Phone Line or Connections</b>	
Dialing does not work. (No dial tone)	Check the machine is plugged in.
	Check for a dial tone. If possible, call your machine to hear it answer. If there is still no answer, check the telephone line cord connection and make sure all telephone connections are secured. If there is no ringing when you call your machine, ask your telephone company to check the line.
	Change Tone/Pulse setting. (See <i>Setting Tone and Pulse dialing mode</i> on page 2-1.)
<b>Receiving Faxes</b>	
Cannot receive a fax	Make sure the machine is in the correct receiving mode for your setup. (See <i>Basic receiving operations (FAX-1840C, MFC-3240C and MFC-3340CN only)</i> on page 4-1 and <i>Basic receiving operations (FAX-1940CN only)</i> on page 4-3.)
	If you frequently encounter interference on the phone line, try changing the menu setting of Compatibility to <b>Basic</b> . (See <i>Compatibility</i> on page 12-14.)
<b>Sending Faxes</b>	
Cannot send a fax	Make sure that the Fax  key is illuminated. (See <i>How to enter Fax mode</i> on page 3-1.)
	Ask the other party to check that receiving machine has paper.
	Print the Transmission Verification Report and check for an error. (See <i>Printing reports</i> on page 8-3.)
Transmission Verification Report says 'Result:NG' or 'Result:ERROR'.	There is probably temporary noise or static on the line. Try sending the fax again. If you send a PC FAX message and get 'Result:NG' on the Transmission Verification Report, your machine may be out of memory.
	If you frequently get transmission error with possible interference on the phone line, try to change the menu setting of Compatibility to <b>Basic</b> . (See <i>Compatibility</i> on page 12-14.)
Poor sending quality.	Try changing your resolution to <b>Fine</b> or <b>S.Fine</b> . Make a copy to check your machine's scanner operation.
Vertical black lines when sending.	If the copy you made shows the same problem, your scanner is dirty. (See <i>Routine maintenance</i> on page 12-23.)

DIFFICULTY	SUGGESTIONS
<b>Handling Incoming Calls</b>	
The machine 'Hears' Voice as CNG Tone.	If your machine is set to Easy Receive ON, it is more sensitive to sounds. Your machine may mistakenly interpret certain voices or music on the line as a calling fax machine and respond with fax receiving tones. Deactivate the fax by pressing <b>Stop/Exit</b> . Try avoiding this problem by turning Easy Receive to Off. (See <i>Easy Receive (MFC-3240C and MFC-3340CN only)</i> on page 4-8.)
Transferring a Fax Call to the machine.	If you answered at the machine, press <b>Black Start</b> and hang up immediately. If you answered on an extension phone, press your Fax Receive Code (default setting is (✕)51). When your machine answers, hang up.
Custom features on a single line.	If you have Call Waiting, Call Waiting/Caller ID, Ring Master, Voice Mail, an alarm system or any other custom feature on a single phone line with your machine, it may create a problem sending or receiving faxes. For example: If you are sending or receiving a fax message while a custom feature signal comes through on the line, the signal can temporarily interrupt or disrupt the faxes. Brother's ECM feature should help overcome this problem. This condition is related to the telephone system industry and is common to all devices that send and receive data on a single, shared line with custom features. If avoiding a slight interruption is crucial to your business, we recommend a separate phone line with no custom features.
<b>Copying Difficulties</b>	
Cannot make a copy	Make sure that the Copy  key is illuminated. (See <i>Enter Copy mode</i> on page 9-1.)
Vertical streaks appear in copies	Sometimes you may see vertical streaks on copies. Clean the scanner. (See <i>Cleaning the Scanner</i> on page 12-23.)
<b>Scanning Difficulties (MFC-3240C and MFC-3340CN only)</b>	
TWAIN/WIA errors appear while scanning.	Make sure the Brother TWAIN/WIA driver is selected as the primary source. In PaperPort, click Scan in the File menu and select the Brother TWAIN/WIA driver.
<b>Software Difficulties (MFC-3240C and MFC-3340CN only)</b>	
Cannot install software or print	Run the <b>MFL-Pro Suite Repair and Install</b> program on the CD-ROM. This program will repair and reinstall the software.
'Device Busy'	Make sure the machine is not showing an error message on the LCD.

DIFFICULTY	SUGGESTIONS
<b>PhotoCapture Center™ Difficulties (MFC-3340CN only)</b>	
Removable Disk does not work properly.	<p>a) Have you installed the Windows® 2000 update? If not, do the following:</p> <ol style="list-style-type: none"> <li>1. Disconnect the USB cable.</li> <li>2. Install the Windows® 2000 update. Please see the Quick Setup Guide. After the installation the PC will be automatically restarted.</li> <li>3. Wait about 1 minute after you reboot the PC, and then connect the USB cable.</li> </ol> <p>b) Take out the media card and put it back in again.</p> <p>c) If you have tried "Eject" from within Windows®, you must take out the media card before you continue.</p> <p>d) If an error message appears when you try to eject the media card, it means the card is being accessed. Wait a while and then try again.</p> <p>e) If all of the above do not work, please turn off your PC and machine, and then turn them on again. (You will have to unplug the power cord of the machine to turn it off.)</p>
Cannot access Removable Disk from Desktop icon.	Make sure you have inserted the media card into the media slot.
<b>Network Difficulties (MFC-3340CN only)</b>	
I cannot print over the Network	<p>Make sure that your machine is powered on and is On Line and in Ready mode. Print Network Configuration list. (See <i>Printing reports</i> on page 8-1.) Then the current settings of the network are printed. Reconnect the LAN cable to the hub to verify that the cabling and network connections are good. If possible, try connecting the machine to a different port on your hub using a different cable. If the connections are good, the machine shows LAN Active for 2 seconds.</p>

# Compatibility

---

If you are having difficulty sending or receiving a fax due to possible interference on the phone line, we recommend that you adjust the Equalization for compatibility with your phone line. The machine adjusts the modem speed for fax operations.

**1** Press **Menu/Set**, **2**, **0**, **1**.

1.Compatibility

**2** Press **▲** or **▼** to select **Basic**,  
(or **Normal**).

 For FAX-1940CN, MFC-3240C and MFC-3340CN, you can select **High** to return to 33600 bps.

Press **Menu/Set**.

**3** Press **Stop/Exit**.

 ■ **Basic** reduces the modem speed to 9600 bps. Unless interference is a recurring problem on your phone line, you may prefer to use it only when needed.

■ **Normal** sets the modem speed at 14400 bps.

# How to improve print quality

## Cleaning the print head

---

To ensure good print quality, the machine will regularly clean the print head. You can start the cleaning process manually if needed.

Clean the print head and ink cartridges if you get a horizontal line in the text or graphics on your printed pages. You can clean Black only or three colors at a time (Cyan/Yellow/Magenta), or all four colors at once.

Cleaning the print head consumes ink. Cleaning too often uses ink unnecessarily.

### **Caution**

Do NOT touch the print head. Touching the print head may cause permanent damage and may void the print head's warranty.

- 1** Press **Ink**.
- 2** Press **▲** or **▼** to select **Cleaning**.  
Press **Menu/Set**.
- 3** Press **▲** or **▼** to select **Black, Color** or **All**.  
Press **Menu/Set**.

The machine will clean the print head. When cleaning is finished, the machine will go back to standby mode automatically.



If you clean the print head at least five times and the print has not improved, call Brother Customer Service (see *Brother numbers* on page i).

## Checking the print quality

---

If faded or streaked colors and text appears on your output, some of the nozzles may be clogged. You can check this by printing the Print Quality Check Sheet and looking at the nozzle check pattern.

- 1** Press **Ink**.
- 2** Press **▲** or **▼** to select `Test Print`.  
Press **Menu/Set**.
- 3** Press **▲** or **▼** to select `Print Quality`.  
Press **Menu/Set**.
- 4** Press **Color Start**.

The machine begins printing the Print Quality Check Sheet.

- 5** Check the sheet to see if the quality is OK by following these steps:

### Color block quality check

The LCD shows:

Is Quality OK?

1.Yes 2.No

- 6** Check the quality of the four color blocks on the sheet.
- 7** If all lines are clear and visible, press **1** (Yes), and go to Step 10.

—OR—

If you can see missing short lines as shown below, press **2** (No).

OK

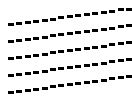

Poor

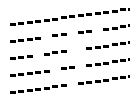

The LCD will ask you if the print quality is OK for black and three colors.

Black OK?

1.Yes 2.No



- 8** Press **2** (No) for black or three colors with a problem.

Start Cleaning?

The LCD shows:

1.Yes 2.No

Press **1** (Yes).

The machine will start cleaning the print head.

- 9** After cleaning is finished, press **Color Start**. The machine will start printing the Print Quality Check Sheet again and then return to step 5.

- 10** Press **Stop/Exit**.

If you still see missing ink in this Print Quality Check Sheet, repeat the cleaning and test print procedures at least five times. If ink is still missing after the fifth cleaning and test print, replace the ink cartridge for the clogged color. (Perhaps the ink cartridge was in your machine over six months or the expiration date written on the cartridge package has passed. Or, the ink may not have been stored properly before use.)

After replacing the ink cartridge, check it by printing another Print Quality Check Sheet. If the problem still exists, repeat the cleaning and test print procedures at least five times for the new ink cartridge. If ink is still missing, call Brother Customer Service (see *Brother numbers* on page i).

**! Caution**

Do NOT touch the print head. Touching the print head may cause permanent damage and may void the print head's warranty.



When a print head nozzle is clogged the printed sample looks like this.



After the print head nozzle is cleaned, the horizontal lines are gone.

## Checking the printing alignment

---

You should rarely need to adjust the printing alignment however, if after transporting the machine your printed text becomes blurred or images become faded then adjustment may need to be made.

- 1 Press **Ink**.
- 2 Press **▲** or **▼** to select `Test Print`.  
Press **Menu/Set**.
- 3 Press **▲** or **▼** to select `Alignment`.  
Press **Menu/Set**.
- 4 Press **Black Start** or **Color Start**.

The machine begins printing the Alignment Check Sheet.

The LCD shows:

`Is Alignment OK?`

`1.Yes 2.No`

- 5 Check the 600 dpi and 1200 dpi test prints to see if number 5 most closely matches number 0. If the number 5 sample of both the 600 dpi and 1200 dpi are the best matches, press **1** (Yes) to finish Alignment Check, and go to Step 8.

—OR—

If another test print number is a better match for either 600 dpi or 1200 dpi, press **2** (No) to select it.

- 6 For 600 dpi, press the number of the test print that most closely matches the number 0 sample (1-8).  
`600dpi Adjust`  
`Select Best # 5`
- 7 For 1200 dpi, press the number of the test print that most closely matches the number 0 sample (1-8).  
`1200dpi Adjust`  
`Select Best # 5`
- 8 Press **Stop/Exit**.

# Checking the ink volume

You can check the ink that is left in the cartridge.

- 1 Press **Ink**.
- 2 Press **▲** or **▼** to select **Ink Volume**.  
Press **Menu/Set**.

- 3 Press **▲** or **▼** to select the color you want to check.

Ink Volume

The LCD shows the ink volume.

Bk: -□□□■□□□+ ◆

- 4 Press **Stop/Exit**.



(MFC-3240C and MFC-3340CN only) You can check the ink volume from your computer. (See *MFC Remote Setup* (not available for MFC-210C) on page 4-1 in Software User's Guide on the CD-ROM or *MFC Remote Setup (Mac OS® X 10.2.4 or greater)* (not available for MFC-210C) on page 8-43 in Software User's Guide on the CD-ROM.)

## Packing and shipping the machine

---

Whenever you transport the machine, use the packing materials that came with your machine. If you do not pack the machine properly, you could void your warranty.

### ! Caution

It is important to allow the machine to 'park' the print head after a print job. Listen carefully to the machine before disconnecting it from the power source to ensure that all mechanical noise has stopped. Not allowing the machine to complete this parking process may lead to print problems and possible damage to the print head.

- 1 Close the document support and the document tray.
- 2 Lift the top cover to the open position until it locks securely into place.
- 3 Remove all the ink cartridges and attach the protective parts.  
(See *Replacing the ink cartridges* on page 12-25.)

When attaching the protective parts, make sure it clips into place as shown in the diagram.

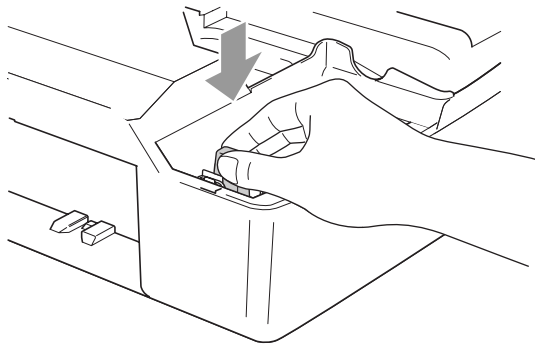

### ! Caution

If you are not able to find the protective parts, do NOT remove the ink cartridges before shipping. It is essential that the machine be shipped with either the protective parts or the ink cartridges in position. Shipping without them will cause damage to your machine and may void your warranty.

- 4** Close the top cover.
  - 5** Unplug the machine from the telephone wall jack and remove the telephone line cord from machine.
  - 6** Unplug the machine from the AC power outlet.
  - 7** Unplug the USB cable or LAN cable from the machine, if it is connected.
  - 8** If your machine has a handset, remove it and the handset curled cord.
-  If you are packing the machine for the Brother Exchange Service, keep these items and return only the machine.
- 9** Wrap the machine in the bag and place it in the original carton with the original packing material.

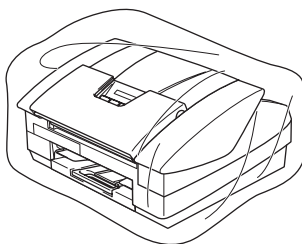

- 10** Pack the printed materials in the original carton as shown below.  
Do not pack the used ink cartridges in the carton.

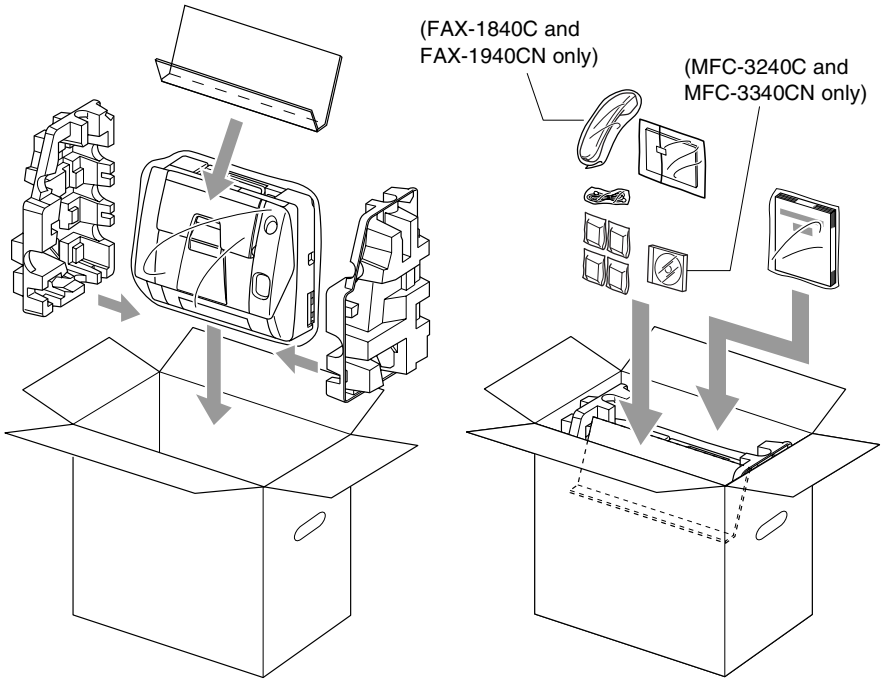

 If you are returning your machine to Brother as part of the Exchange Service, pack *only* the machine. Keep all separate parts and printed materials to use with your “Exchange” machine.

- 11** Close the carton.

# Routine maintenance

## Cleaning the Scanner

Unplug the machine, close the document support and the document tray and then open the top cover. Clean the flat white plate and the glass strip below the bar with isopropyl alcohol on a lint-free cloth.

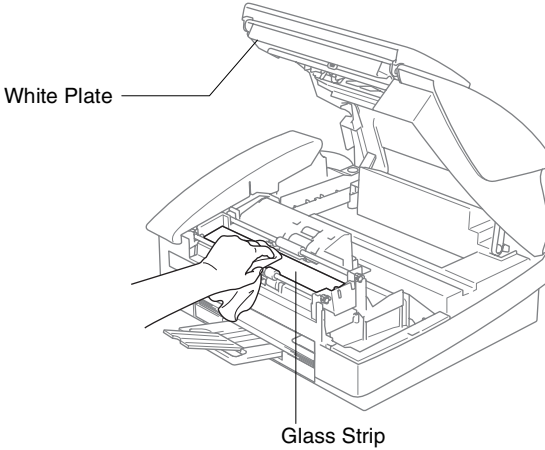

# Cleaning the machine Printer Platen

## WARNING

- Be sure to unplug the machine from the AC power outlet before cleaning the printer platen.
- Be careful not to touch the paper feed star wheels and encoder film.
- When you want to clean your machine printer platen, wipe it with a lint free cloth that is *dry*.
- If ink is scattered on or around the printer platen be sure to wipe it off with a soft, dry, lint-free cloth.

Encoder Film

**Do NOT Touch!**

Paper Feed Star Wheel

**Do NOT Touch!**

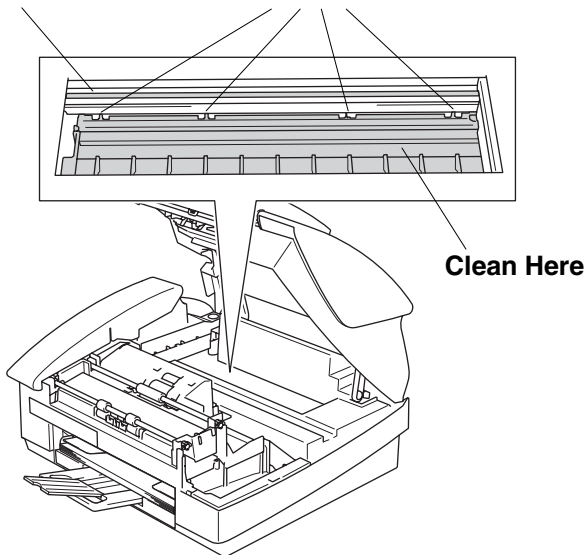

**Clean Here**



## Replacing the ink cartridges

---

Your machine is equipped with an ink dot counter that automatically monitors the ink level in each color cartridge. When the counter detects an ink cartridge is running out of ink, the machine will notify you with a message on the LCD.

The LCD shows you which color cartridges are low or empty. Be sure to follow the LCD prompts so you replace the color cartridges in the appropriate order.

- 1** Close the document support and the document tray.
- 2** Lift the top cover to the open position until it locks securely into place.

If one or more ink cartridges are empty, for example Black, the LCD shows **Ink Empty Black and Open Cover**.

- 3** Pull the ink cartridge hook toward you and remove the ink cartridge for the color shown on the LCD.

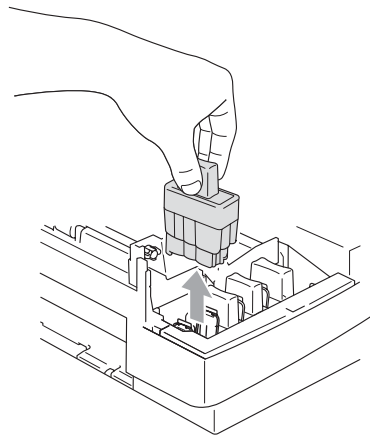
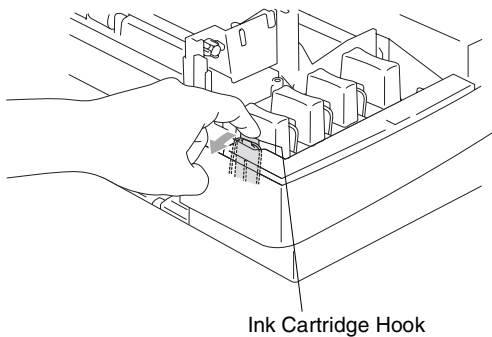

- 4** Open the new ink cartridge bag for the color shown on the LCD, and then take out the ink cartridge.

**5** Remove the cartridge covers.

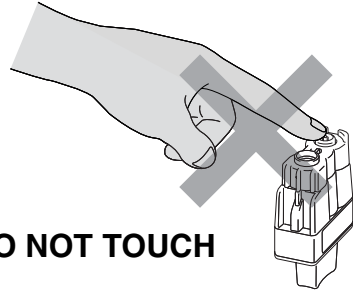
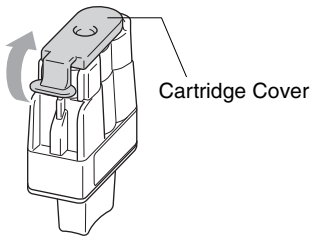

 Do not touch the area shown in the illustration above.

 If the cartridge cover comes off when you open the bag the cartridge will not be damaged.

**6** Each color has its own correct position. Keep the ink cartridge in an upright position when you insert it into slot. Press down on the ink cartridge until the hook snaps over it.

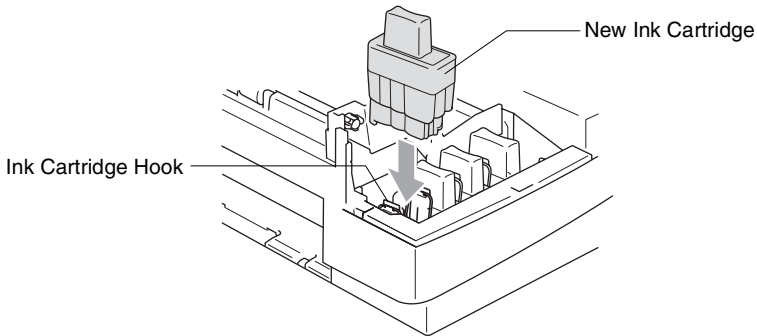

**7** If you replaced an ink cartridge while `Near Empty` was displayed on the LCD, the LCD may ask you to verify that it was a brand new one. Example: `Did You Change Blck? 1.Yes 2.No`. For each *new* cartridge you installed, press **1** on the dial pad to automatically reset the ink dot counter for that color. If the ink cartridge you installed is not a brand new one, please be sure to select **2**.



If you wait until `Ink Empty` message is displayed on the LCD, the machine will automatically reset the ink dot counter.



If the `Install` message is on the display after you have installed ink cartridges, check that the ink cartridges are installed properly.



### **WARNING**

If ink gets in your eyes, irrigate them with water immediately and call a doctor if you are concerned.



## **Caution**

- Do not remove ink cartridges if you do not need to replace them. If you do so, it may reduce the ink quantity and the machine will not know the quantity of ink left in the cartridge.
- Do not touch the cartridge insertion slots. If you do so, the ink may stain your skin.
- If ink stains your skin or clothing, wash with soap or detergent immediately.
- If you install an ink cartridge in the wrong color position, you must clean the print head several times before you start printing (after correcting the cartridge installation) because the colors were mixed.
- Once you open an ink cartridge, install it in the machine and use it up within six months of installation. Use unopened ink cartridges by the expiration date written on the cartridge package.
- Do not dismantle or tamper with the ink cartridge, this can cause the ink to leak out of the cartridge.
- Brother strongly recommends that you do not refill the ink cartridges provided with your machine. We also strongly recommend that you continue to use only Genuine Brother Brand replacement ink cartridges. Using or attempting to use potentially incompatible inks and/or cartridges in your machine may cause damage to the machine itself and/or it may result in unsatisfactory print quality. Our warranty coverage does not apply to any problem that was caused by the use of unauthorized third party ink and/or cartridges. To protect your investment and guarantee your print quality please continue to replace consumed ink cartridges with only Genuine Brother Branded Supplies.

# A Appendix A

## Setting up telephone services

Your machine supports the Caller ID and Distinctive Ring subscriber telephone services that some telephone companies offer.



If you have Voice Mail, Call Waiting, Call Waiting/Caller ID, RingMaster, an answering service, an alarm system or other custom features on your telephone line, it may affect the way your machine works. (See *Custom features* on page 1-19 and *Custom features on a single line.* on page 12-12.)

If you have Voice Mail on your phone line, please read the following carefully.

### Distinctive Ring

---

Brother uses the term 'Distinctive Ring' but different telephone companies have other names for this service such as SmartRing, RingMaster, Teen-Ring, Indent-a-Call or Indent-a-Ring.

#### What does your telephone company's 'Distinctive Ring' do?

Your telephone company's Distinctive Ring service allows you to have more than one number on the same phone line. **If you need more than one phone number, it is cheaper than paying for an extra line.** Each phone number has its own distinctive ring pattern, so you will know which phone number is ringing. This is one way you can have a separate phone number for your machine.



Please call your telephone company for availability and rates.

## What does Brother's 'Distinctive Ring' do?

The Brother machine has a Distinctive Ring feature that allows you to use your machine to take full advantage of the telephone company's Distinctive Ring service. The new phone number on your line can just receive faxes.



You must pay for your telephone company's Distinctive Ring service before you program the machine to work with it.

## Do you have Voice Mail?

If you have Voice Mail on the phone line that you will install your new machine on, *there is a strong possibility that Voice Mail and the machine will conflict with each other while receiving incoming calls.*

**However, the Distinctive Ring feature allows you to use more than one number on your line, so both Voice Mail and the machine can work together without any problems.** If each one has a separate phone number, neither will interfere with the other's operations.





If you decide to get the Distinctive Ring service from the telephone company, you will need to follow the directions below to 'register' the new Distinctive Ring pattern they give you. This is so your machine can recognize its incoming calls.



You can change or cancel the Distinctive Ring pattern at any time. You can switch it off temporarily, and turn it back on later. When you get a new fax number, make sure you reset this feature.

## Before you choose the ring pattern to register

You can only register one Distinctive Ring pattern with the machine. Some ring patterns cannot be registered. The ring patterns below are supported by your Brother machine. Register the one your telephone company gives you.

Ring Pattern	Rings	
1	long-long	
2	short-long-short	
3	short-short-long	
4	very long (normal pattern)	

 If the ring pattern you received is not on this chart, **please call your telephone company and ask for one that is shown.**

- The machine will only answer calls to its registered number.
- The first two rings are silent on the machine. This is because the fax must «listen» to the ring pattern (to compare it to the pattern that was 'registered'). (Other telephones on the same line will ring.)
- If you program the machine properly, it will recognize the registered ring pattern of the 'fax number' within 2 ring patterns and then answer with a fax tone. When the 'voice number' is called, the machine will not answer.

## Registering the Distinctive Ring pattern

---

### Very important!

After you have set the Distinctive Ring feature to ON, the receive mode is set to **Manual** automatically. Unless you have a TAD or Voice Mail set up on the Distinctive Ring number, **Manual** mode means you must answer all the voice calls yourself. You can not change the receive mode to another mode while the Distinctive Ring is set to on.

**1** Press **Menu/Set, 2, 0, 2.**

Miscellaneous

**2** Press **▲** or **▼** to select **Set.**

2.Distinctive

Press **Menu/Set.**

**3** Press **▲** or **▼** to select the stored ring pattern you want to use.

Press **Menu/Set.**

(You will hear each pattern as you scroll through the four patterns. Make sure you choose the pattern that the telephone company gave you.)

**4** Press **Stop/Exit.** Distinctive Ring is now set to on.

### Turning off the Distinctive Ring

**1** Press **Menu/Set, 2, 0, 2.**

Miscellaneous

**2** Press **▲** or **▼** to select **Off.**

2.Distinctive

Press **Menu/Set.**

**3** Press **Stop/Exit.**



If you turn off Distinctive Ring, the machine will stay in **Manual** receive mode. You will need to set the Receive Mode again. (See *To select or change your Receive Mode* on page 4-4.)



# Caller ID



The Caller ID feature lets you use the Caller ID subscriber service offered by many local telephone companies. This service displays the telephone number, or name if it is available, of your caller as the line rings.

After a few rings, the LCD shows the telephone number of your caller (and name, if available). Once you pick up the handset, the Caller ID information disappears from the LCD, but the call information remains stored in the Caller ID memory.

- You will see the first 16 characters of the number (or name).
- `Out of Area` display means call originated outside your Caller ID service area.
- `Private Call` display means the caller has intentionally blocked transmission of information.

You can print a list of Caller ID information received by your machine. (See *Printing Caller ID List* on page A-6.)

Caller ID service varies with different carriers. Call your local telephone company to determine the kind of service available in your area.

## Viewing Caller ID List

---

Caller ID memory stores information for up to thirty calls. When the thirty-first call comes in, information about the first call is erased. You can scroll through Caller ID information to review those calls made to your machine.

- 1 Press **Menu/Set, 2, 0, 3.**
- 2 Press **▲** or **▼** to select `Display#`.   
Press **Menu/Set**.  
If the name was not received, it will not be displayed.
- 3 Press **▲** or **▼** to scroll through the Caller ID memory to select the Caller ID you want to view, and then press **Menu/Set**. The LCD shows the caller's name or number and the date and time of the call.
- 4 Press **◀** to return to the Caller ID listing.  
—OR—  
Press **Stop/Exit**.

## Printing Caller ID List

---

- 1 Press **Menu/Set, 2, 0, 3.**
- 2 Press **▲** or **▼** to select `Print Report`.   
Press **Menu/Set**.
- 3 Press **Black Start** or **Color Start**.
- 4 After printing has finished, press **Stop/Exit**.

# Advanced receiving operations

## Operation from extension telephones

---

If you answer a fax call on an extension telephone, or an external telephone in the EXT. jack of the machine, you can make your machine take the call by using the Fax Receive Code. When you press the Fax Receive Code \***51**, the machine starts to receive a fax. (See *Easy Receive (MFC-3240C and MFC-3340CN only)* on page 4-8 or see *Easy Receive (FAX-1840C and FAX-1940CN only)* on page 4-9.)

If the machine answers a voice call and pseudo/double-rings for you to take over, use the Telephone Answer Code **#51** to take the call at an extension phone. (See *Setting the F/T Ring Time (Fax/Tel mode only)* on page 4-7.)

If you answer a call and no one is on the line, you should assume that you're receiving a manual fax.

- Press \***51** and wait for the chirp or until the machine's LCD displays *Receiving*, and then hang up.

Your caller will have to press **Start** to send the fax.

## Fax/Tel mode when power key is On

---

When the machine is in Fax/Tel mode, it will use the F/T Ring Time (pseudo/double-ringing) to alert you to pick up a voice call.

If you are at an extension phone, you'll need to lift the handset during the F/T Ring Time and then press **#51** between the pseudo/double rings. If no one is on the line, or if someone wants to send you a fax, send the call back to the machine by pressing **\*51**.

## Fax/Tel mode when power key is Off

---

You can change the default setting of the **On/Off** key to `Fax Receive:On` so that you can receive faxes when the power key is off. (See *On/Off Setting* on page 1-6.) Fax/Tel mode will work in the following ways.

*For FAX-1840C and FAX-1940CN:*

When the machine is in Fax/Tel mode and pseudo/double-rings to alert you to pick up a voice call, you can only answer by picking up the machine's handset.

If you answer *before* the machine answers with pseudo/double-ringing, you can pick up the call at an external or extension phone.

*For MFC-3240C and MFC-3340CN:*

Fax/Tel mode does not work when the power button is Off. The machine will not answer telephone or fax calls and will keep ringing. If you are at an external or extension phone, lift the handset of the extension phone and talk. If you hear fax tones, hold the handset until Easy Receive activates your machine. If the other party says they want to send you a fax, activate the machine by pressing **\*51**.

## Using a cordless external handset

---

If your cordless telephone is connected to the EXT. jack on the machine and you typically carry the cordless handset elsewhere, it is easier to answer calls during the Ring Delay.

## Changing the remote codes

---

Remote Codes might not work with some telephone systems. The preset Fax Receive Code is \*51. The preset Telephone Answer Code is #51.



If you are always disconnected when accessing your external TAD remotely, try changing the Fax Receive Code and Telephone Answer Code to another three-digit code (such as ### and 999).

**1** If it is not illuminated in green, press  (**Fax**).

**2** Press **Menu/Set, 2, 1, 4**.

4.Remote Code

**3** Press **▲** or **▼** to select **On** (or **Off**).

Press **Menu/Set**.

**4** Enter the new Fax Receive Code.

Press **Menu/Set**.

**5** Enter the new Telephone Answer Code.

Press **Menu/Set**.

**6** Press **Stop/Exit**.

# Connecting an external device to your machine

## Connecting an external telephone

---

You can connect a separate telephone (or telephone answering device) directly to your machine as shown in the diagram below.

Connect the telephone line cord to the jack labeled EXT. in the back of the machine.

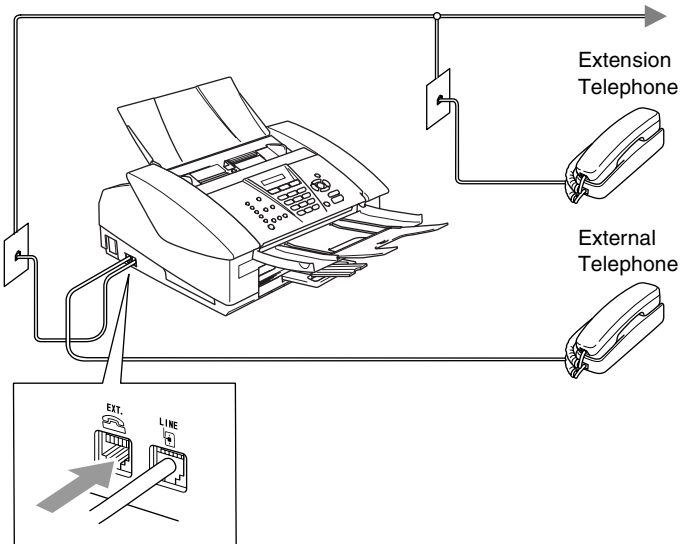

When you are using a TAD, the LCD shows Telephone (MFC-3240C and MFC-3340CN only) or Ext. Tel in Use (FAX-1840C and FAX-1940CN only).

# Connecting an external telephone answering device (TAD)

---

## Sequence

You may choose to connect an additional answering device. However, when you have an **external** TAD on the same telephone line as the machine, the TAD answers all calls and the machine “listens” for fax calling (CNG) tones. If it hears them, the machine takes over the call and receives the fax. If it does not hear CNG tones, the machine lets the TAD continue playing your outgoing message so your caller can leave you a voice message.

The TAD must answer within four rings (the recommended setting is two rings). The machine cannot hear CNG tones until the TAD has answered the call, and with four rings there are only 8 to 10 seconds of CNG tones left for the fax “handshake”. Make sure you carefully follow the instructions in this guide for recording your outgoing message. We do not recommend using the toll saver feature on your external answering machine if it exceeds five rings.



If you do not receive all your faxes, reduce the Ring Delay setting on your external TAD.



*If You Subscribe to your Telephone Company’s Distinctive Ring Service:*

You may connect an external TAD to a separate wall jack only if you subscribe to your telephone company’s Distinctive Ring service, have registered the distinctive ring pattern on your machine, and use that number as a fax number. The recommended setting is at least four rings on the external TAD when you have the telephone company’s Distinctive Ring Service. You cannot use the Toll Saver setting.



**If You Do Not Subscribe to Distinctive Ring Service:**

You must plug your TAD into the EXT. jack of your machine. If your TAD is plugged into a wall jack, both your machine and the TAD will try to control the phone line. (See illustration below.)



**Unless you are using Distinctive Ring, do not connect a TAD elsewhere on the same phone line.**

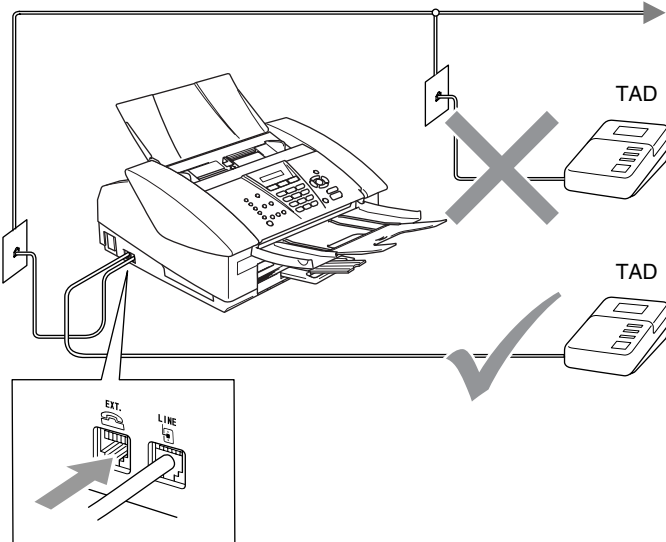

When you are using a TAD, the LCD shows `Telephone` (MFC-3240C and MFC-3340CN only) or `Ext. Tel in Use` (FAX-1840C and FAX-1940CN only).

## Connections

The external TAD must be plugged into the back of the machine, into the jack labeled EXT. Your machine cannot work properly if you plug the TAD into a wall jack (unless you are using Distinctive Ring).

- 1 Plug the telephone line cord from the telephone wall jack into the back of the machine, in the jack labeled LINE.
- 2 Plug the telephone line cord from your external TAD into the back of the machine, in the jack labeled EXT. (Make sure this cord is connected to the TAD at the TAD's telephone *line* jack, and not its telephone jack.)



- 3** Set your external TAD to four rings or less. (The machine's Ring Delay setting does not apply.)
- 4** Record the outgoing message on your external TAD.
- 5** Set the TAD to answer calls.
- 6** For FAX-1940CN, set the Receive Mode to `Manual`.  
(See *Choosing the Receive Mode* on page 4-3.)

—OR—

For FAX-1840C, MFC-3240C and MFC-3340CN, set the Receive Mode to `External TAD`.

(See *Choosing the Receive Mode* on page 4-1.)

## Recording outgoing message (OGM) on an external TAD

Timing is important in recording this message. The message sets up the ways to handle both manual and automatic fax reception.

- 1** Record 5 seconds of silence at the beginning of your message. (This allows your machine time to listen for the fax CNG tones of automatic transmissions before they stop.)
- 2** Limit your speaking to 20 seconds.
- 3** End your 20-second message by giving your Fax Receive Code for people sending manual faxes. For example:  
*"After the beep, leave a message or send a fax by pressing \* 51 and Start."*



We recommend beginning your OGM with an initial 5-second silence because the machine cannot hear fax tones over a resonant or loud voice. You may try omitting this pause, but if your machine has trouble receiving, then you must re-record the OGM to include it.

## Special line considerations

---

### Roll over phone lines

A roll over phone system is a group of two or more separate telephone lines that pass incoming calls to each other if they are busy. The calls are usually passed down or “rolled over” to the next available phone line in a preset order.

Your machine can work in a roll over system as long as it is the last number in the sequence, so the call cannot roll away. Do not put the machine on any of the other numbers; when the other lines are busy and a second fax call is received, the fax call would be transferred to a line that does not have a fax machine. **Your machine will work best on a dedicated line.**

### Two-line phone system

A two-line phone system is nothing more than two separate phone numbers on the same wall outlet. The two phone numbers can be on separate jacks (RJ11) or combined into one jack (RJ14). Your machine must be plugged into an RJ11 jack. RJ11 and RJ14 jacks may be equal in size and appearance and both may contain four wires (black, red, green, yellow). To test the type of jack, plug in a two-line phone and see if it can access both lines. If it can, you must separate the line for your machine. (See *Easy Receive (MFC-3240C and MFC-3340CN only)* on page 4-8.)

## Converting telephone wall outlets

There are three ways to convert to an RJ11 jack. The first two ways may require assistance from the telephone company. You can change the wall outlets from one RJ14 jack to two RJ11 jacks. Or, you can have an RJ11 wall outlet installed and slave or jump one of the phone numbers to it.

The third way is the easiest: Buy a triplex adapter. You can plug a triplex adapter into an RJ14 outlet. It separates the wires into two separate RJ11 jacks (Line 1, Line 2) and a third RJ14 jack (Lines 1 and 2). If your machine is on Line 1, plug the machine into L1 of the triplex adapter. If your machine is on Line 2, plug it into L2 of the triple adapter.

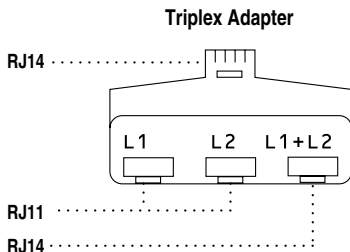

## Installing machine, external two-line TAD and two-line telephone

When you are installing an external two-line telephone answering device (TAD) and a two-line telephone, your machine must be isolated on one line at both the wall jack and at the TAD. The most common connection is to put the machine on Line 2, which is explained in the following steps. The back of the two-line TAD must have two telephone jacks: one labeled L1 or L1/L2, and the other labeled L2. You will need at least three telephone line cords, the one that came with your machine and two for your external two-line TAD. You will need a fourth line cord if you add a two-line telephone.

- 1 Place the two-line TAD and the two-line telephone next to your machine.
- 2 Plug one end of the telephone line cord for your machine into the L2 jack of the triplex adapter. Plug the other end into the LINE jack on the back of the machine.
- 3 Plug one end of the first telephone line cord for your TAD into the L1 jack of the triplex adapter. Plug the other end into the L1 or L1/L2 jack of the two-line TAD.
- 4 Plug one end of the second telephone line cord for your TAD into the L2 jack of the two-line TAD. Plug the other end into the EXT. jack on the left side of the machine.

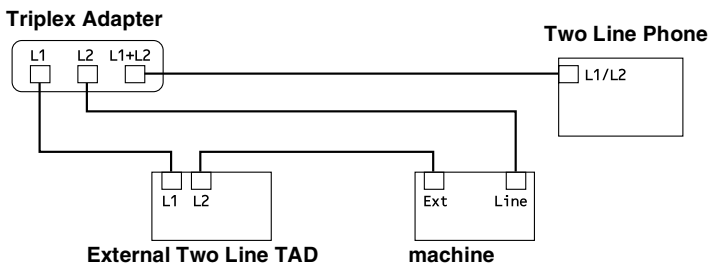

You can keep two-line telephones on other wall outlets as always. There are two ways to add a two-line telephone to the machine's wall outlet. You can plug the telephone line cord from the two-line telephone into the L1+L2 jack of the triplex adapter. Or, you can plug the two-line telephone into the TEL jack of the two-line TAD.

## Multi-line connections (PBX)

---

Most offices use a central telephone system. While it is often relatively simple to connect the machine to a key system or a PBX (Private Branch Exchange), we suggest that you contact the company that installed your telephone system and ask them to connect the machine for you. It is advisable to have a separate line for the machine.

If the machine is to be connected to a multi-line system, ask your installer to connect the unit to the last line on the system. This prevents the unit from being activated each time a telephone call is received.

### If you are installing the machine to work with a PBX

- 1** It is not guaranteed that the unit will operate properly under all circumstances with a PBX. Any cases of difficulty should be reported first to the company that handles your PBX.
- 2** If all incoming calls will be answered by a switchboard operator, it is recommended that the Receive Mode be set to *Manual*. All incoming calls should initially be regarded as telephone calls.

## Custom features on your phone line

---

If you have Voice Mail, Call Waiting, Call Waiting/Caller ID, RingMaster, an answering service, an alarm system or other custom feature on one phone line it may create a problem with the operation of your machine. (See *Custom features* on page 1-19 and *Custom features on a single line*. on page 12-12.)

# B Appendix B

## On-screen programming

Your machine is designed to be easy to use with LCD on-screen programming using the navigation keys. User-friendly programming helps you take full advantage of all the menu selections your machine has to offer.

Since your programming is done on the LCD, we have created step-by-step on-screen instructions to help you program your machine. All you need to do is follow the instructions as they guide you through the menu selections and programming options.

### Menu table

---

You can probably program your machine without the User's Guide if you use the Menu table that begins on page B-3. These pages will help you understand the menu selections and options that are found in the machine's programs.



You can program your machine by pressing **Menu/Set**, followed by the menu numbers.

For example to set `Fax Resolution` to `Fine`:

Press **Menu/Set**, **2**, **2**, **2** and **▲** or **▼** to select `Fine`.





Press **Menu/Set**.

### Memory storage

---

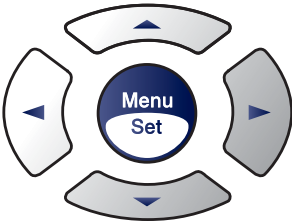
If there is a power failure, you will not lose your menu settings because they are stored permanently. Temporary settings (such as Contrast, Overseas Mode, and so on) will be lost. You may also have to reset the date and time.

# Navigation keys

		Access the menu Go to the next menu level Accept an option
		Scroll through the current menu level
		Go back to the previous menu level
	Stop/Exit 	Exit the menu

You can access the menu mode by pressing **Menu/Set**.

When you enter the menu, the LCD scrolls.

Press **1** for General Setup menu

1.General Setup

—OR—

Press **2** for Fax menu

2.Fax

—OR—

Press **3** for Copy menu

3.Copy

⋮

Press **0** for Initial Setup

0.Initial Setup

You can scroll more quickly through each menu level by pressing the arrow for the direction you want: ▲ or ▼.

Select an option by pressing **Menu/Set** when that option appears on the LCD.

The LCD will then show the next menu level.

Press ▲ or ▼ to scroll to your next menu selection.

Press **Menu/Set**.

When you finish setting an option, the LCD shows *Accepted*.

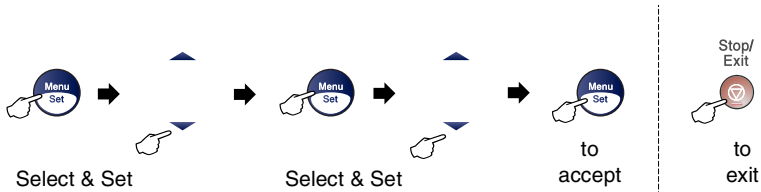

Main Menu	Submenu	Menu Selections	Options	Descriptions	Page	
1.General Setup	1.Mode Timer	—	5 Mins 2 Mins 1 Min <b>30 Secs</b> (Default for MFC-3240C, MFC-3340CN) 0 Sec (Default for FAX-1840C, MFC-1940CN) Off	Sets the time to return to Fax mode.	2-3	
	2.Paper Type	—	<b>Plain</b> Inkjet Glossy Transprncy	Sets the type of paper in the paper tray.	2-4	
	3.Paper Size	—	<b>Letter</b> Legal A4 A5 4 "x6"	Sets the size of the paper in the paper tray.	2-4	
	4.Volume	1.Ring		High <b>Med</b> Low Off	Adjusts the ring volume.	2-5
		2.Beeper		High Med <b>Low</b> Off	Adjusts the volume level of the beeper.	2-5
		3.Speaker		High <b>Med</b> Low Off	Adjusts the speaker volume.	2-6
		4.Handset (FAX-1840C, FAX-1940CN only)		High <b>Low</b>	Adjusts handset volume.	2-7



The factory settings are shown in Bold.



Main Menu	Submenu	Menu Selections	Options	Descriptions	Page
1.General Setup (Continued)	4.Volume (Continued)	5.Volume Amplify (FAX-1840C, FAX-1940CN only)	On (Permanent/ Temporary) <b>Off</b>	For the hearing-impaired, you can set the volume to the On setting on a permanent or temporary basis.	2-9
	5.Auto Daylight	—	On <b>Off</b>	Changes for Daylight Savings Time automatically.	2-10
	6.On/Off Setting	—	Fax Receive:On <b>Fax Receive:Off</b>	Customizes the On/Off key to receive faxes even in OFF mode.	2-10
	7.LCD Contrast	—	<b>Light</b> Dark	Adjust the contrast of the LCD.	2-10
2.Fax	1.Setup Receive (In Fax mode only)	1.Ring Delay (Excluding FAX-1940CN)	<b>04</b> 03 02 01 00	Sets the number of rings before the machine answers in Fax Only or Fax/Tel mode.	4-2
		1.Ring Delay (FAX-1940CN only)	<b>Ring Delay</b> <b>04</b> 03 02 01 00	Sets the number of rings before the machine answers in Fax Only, Fax/Tel or MC:Msg Ctr mode.	4-5
			<b>Toll Saver</b> On <b>Off</b>	Cost saving feature: the machine rings 2 times if there are messages and 4 times if there are no messages, so you can hang up and not pay for the call.	4-6
		2.F/T Ring Time	70 Sec 40 Sec 30 Sec <b>20 Sec</b>	Sets the pseudo/double-ring time in Fax/Tel mode.	4-7
		3.Easy Receive	<b>On</b> Semi (FAX-1840C, FAX-1940CN only) <b>Off</b>	Receives fax messages without pressing the <b>Black Start</b> or <b>Color Start</b> key.	4-8



The factory settings are shown in Bold.

Main Menu	Submenu	Menu Selections	Options	Descriptions	Page
2.Fax (Continued)	1.Setup Receive (In Fax mode only) (Continued)	4.Remote Code	<b>On</b> (*51, #51) Off	You can answer all calls at an extension or external phone and use codes to turn the machine on or off. You can personalize these codes.	A-9
		5.Auto Reduction	<b>On</b> Off	Reduces the size of incoming faxes.	4-10
		6.Polling RX	—	Sets up your machine to poll another fax machine.	4-11
	2.Setup Send (In Fax mode only)	1.Contrast	<b>Auto</b> Light Dark	Changes the lightness or darkness of faxes you send.	3-7
		2.Fax Resolution	<b>Standard</b> Fine S.Fine Photo	Sets the default resolution for outgoing faxes.	3-8
		3.Delayed Fax	—	Set the time of day in 24 hour format that the delayed faxes will be sent.	3-14
		4.Batch TX	<b>On</b> Off	Combines delayed faxes to the same fax number at the same time of day into one transmission.	3-16
		5.Real Time TX	<b>Off</b> On Next Fax Only	You can send a fax without using the memory.	3-10
		6.Polled TX	<b>On</b> Off	Sets up your machine with an document to be retrieved by another fax machine.	3-15
		7.Overseas Mode	<b>On</b> Off	If you are having difficulty sending faxes overseas, set this to On.	3-13



The factory settings are shown in Bold.

Main Menu	Submenu	Menu Selections	Options	Descriptions	Page
2.Fax (Continued)	3.Set Quick-Dial	1.One-Touch Dial		Stores One-Touch Dial numbers, so you can dial by pressing one key (and Start).	5-1
		2.Speed-Dial	—	Stores Speed-Dial numbers, so you can dial by pressing only a few keys (and Start).	5-2
		3.Setup Groups	—	Sets up a Group number for Broadcasting.	5-4
	4.Report Setting	1.Transmission	On On+Image <b>Off</b> Off+Image	Initial setup for Transmission Verification Report and Fax Journal Report.	8-1
		2.Journal Period	Every 7 Days Every 2 Days Every 24 Hours Every 12 Hours Every 6 Hours <b>Every 50 Faxes</b> Off		8-2
	5.Remote Fax Opt	1.Fwd/Page/ Store	<b>Off</b> Fax Forward Paging Fax Storage PC Fax Receive (MFC-3340CN only)	Sets the machine to forward fax messages, to call your pager, to store incoming faxes in the memory (so you can retrieve them while you are away from your machine), or to send faxes to your PC.	6-1 6-2
		2.Remote Access	--- *	You must set your own code for Remote Retrieval.	6-5
		3.Print Fax (Backup Print)	—	Prints incoming faxes stored in the memory.	4-10 6-3
	6.Remaining Jobs	—	—	Checks which jobs are in the memory and lets you cancel selected jobs.	3-11



The factory settings are shown in Bold.

Main Menu	Submenu	Menu Selections	Options	Descriptions	Page
2.Fax (Continued)	7.Setup Msg Ctr (FAX-1940CN only)	1. OGM	Msg Ctr OGM F/T OGM	Play/Record or erase the outgoing message.	7-2
		2. ICM Max. Time	180 120 60 30	Select the maximum length of incoming messages.	7-6
		3. ICM Rec. Monitr	On Off	Allows you to turn the speaker volume for voice messages as they come in On or Off.	7-7
	0. Miscellaneous	1. Compatibility	High (FAX-1940CN, MFC-3240C, MFC-3340CN only) Normal Basic	Adjust the transmission that are having problem.	12-14
		2. Distinctive	Off Set (On)	Uses the Telephone Company's Distinctive Ring subscriber service to register the ring pattern with the machine.	A-1
		3. Caller ID	Display# Print Report	View or print a list of the last 30 Caller IDs stored in the memory.	A-5
	3. Copy	1. Quality	—	Best <b>Normal</b> Fast	Selects the Copy resolution for your type of document.
2. Brightness		—	- □□□■ + - □□□■ + - □□□■ + - □■□□ + - ■□□□ +	Adjusts the brightness.	9-12
3. Contrast		—	- □□□■ + - □□□■ + - □□□■ + - □■□□ + - ■□□□ +	Adjusts the contrast for copies.	9-12



The factory settings are shown in Bold.

Main Menu	Submenu	Menu Selections	Options	Descriptions	Page
3.Copy (Continued)	4.Color Adjust	1.Red	R:- 0000■ + R:- 0000■ + R:- 0000■ + R:- 0■000 + R:- ■0000 +	Adjusts the amount of Red in copies.	9-13
		2.Green	G:- 0000■ + G:- 0000■ + G:- 0000■ + G:- 0■000 + G:- ■0000 +	Adjusts the amount of Green in copies.	
		3.Blue	B:- 0000■ + B:- 0000■ + B:- 0000■ + B:- 0■000 + B:- ■0000 +	Adjusts the amount of Blue in copies.	
4.PhotoCapture (MFC-3340CN only)	1.Print Quality	—	Normal <b>Photo</b>	Selects the print quality.	10-9
	2.Paper & Size	—	<b>Letter Glossy</b> 4"x 6" Glossy 5"x 7" Glossy A4 Glossy Letter Plain A4 Plain Letter Inkjet A4 Inkjet 4"x 6" Inkjet	Selects the paper and print size.	10-9
	3.Brightness	—	- 0000■ + - 0000■ + - 0000■ + - 0■000 + - ■0000 +	Adjusts the brightness.	10-10
	4.Contrast	—	- 0000■ + - 0000■ + - 0000■ + - 0■000 + - ■0000 +	Adjusts the contrast.	10-10



The factory settings are shown in Bold.

Main Menu	Submenu	Menu Selections	Options	Descriptions	Page
4.PhotoCapture (Continued)	5.True2Life	On Off	1.White Balance - o o o o ■ + - o o o ■ o + - o o ■ o o + - o ■ o o o + - ■ o o o o +	Adjusts the hue of the white areas.	10-10
			2.Sharpness - o o o o ■ + - o o o ■ o + - o o ■ o o + - o ■ o o o + - ■ o o o o +	Enhances the detail of the image.	
			3.Color Density - o o o o ■ + - o o o ■ o + - o o ■ o o + - o ■ o o o + - ■ o o o o +	Adjusts the total amount of color in the image.	
	6.Cropping	—	On Off	Crops the image around the margin to fit the paper size or print size. Turn this feature Off if you want to print whole images or prevent unwanted cropping.	10-12
	7.Borderless	—	On Off	Expands the printable area to fit the edges of the paper	10-12
	8.Scan to Card	1.Quality	B/W 200x100 dpi B/W 200 dpi <b>Color 150 dpi</b> Color 300 dpi Color 600 dpi	Selects the Scan resolution for your type of document.	2-25*1
		2.B/W File Type	<b>TIFF</b> PDF	Selects the default file format for black and white scanning.	2-25*1
3.ColorFile Type		<b>PDF</b> JPEG	Selects the default file format for color scanning.	2-25*1	



The factory settings are shown in Bold.

\*1 See the complete Software User's Guide on the CD-ROM.

Main Menu	Submenu	Menu Selections	Options	Descriptions	Page
5.LAN (MFC-3340CN only)	1.Setup TCP/IP	1.BOOT Method	<b>Auto</b> Static RARP BOOTP DHCP	You can choose the BOOT method that best suits you needs.	See Network User's Guide on the CD-ROM
		2.IP Address	[000-255]. [000-255]. [000-255]. [000-255]	Enter the IP address.	
		3.Subnet Mask	[000-255]. [000-255]. [000-255]. [000-255]	Enter the Subnet mask.	
		4.Gateway	[000-255]. [000-255]. [000-255]. [000-255]	Enter the Gateway address.	
		5.Host Name	BRN_XXXXXX	Enter the Host name.	
		6.WINS Config	<b>Auto</b> Static	You can choose the WINS configuration mode.	
		7.WINS Server	(Primary) 000.000.000.000	Specifies the IP address of the primary or secondary server.	
		8.DNS Server	(Primary) 000.000.000.000	Specifies the IP address of the primary or secondary server.	
		9.APIPA	<b>On</b> Off	Automatically allocates the IP address from the link-local address range.	
	2.Setup Misc.	1.Ethernet	<b>Auto</b> 100B-FD 100B-HD 10B-FD 10B-HD	Selects Ethernet link mode.	
		2.Time Zone	GMT-05:00	Sets the time zone for your country.	
	0.Factory Reset	—	—	Restore all network settings to factory default.	



The factory settings are shown in Bold.

Main Menu	Submenu	Menu Selections	Options	Descriptions	Page
4.Print Reports (MFC-3240C only) 6.Print Reports (MFC-3340CN only)	1.Help List	—	—	You can print these lists and reports.	8-3
	2.Quick-Dial	—	—		
	3.Fax Journal	—	—		
	4.Transmission	—	—		
	5.User Settings	—	—		
	6.Network Config (MFC-3340CN only)	—	—		
0.Initial Setup	1.Receive Mode (Excluding FAX-1940CN)	—	<b>Fax Only</b> Fax/Tel External TAD Manual	You can choose the receive mode that best suits your needs.	4-1 4-2
	1.Receive Mode (FAX-1940CN only)	—	<b>Fax Only</b> Fax/Tel Manual	You can choose the receive mode that best suits your needs.	4-3
	2.Date/Time	—	—	Puts the date and time on the LCD and in headings of faxes you send.	2-1
	3.Station ID	—	Fax: Name:	Program your name and fax number to appear on each page you fax.	2-2
	4.Tone/Pulse	—	<b>Tone</b> Pulse	Selects the dialing mode.	2-1
	0.Local Language (Canada only)	—	<b>English</b> French	Allows you to change the LCD Language for your country.	See Quick Setup Guide



The factory settings are shown in Bold.



## Entering Text

---

When you are setting certain menu selections, such as the Station ID, you may need to type text into the machine. Most number keys have three or four letters printed above them. The keys for **0**, **#** and **\*** do not have printed letters because they are used for special characters.

By pressing the appropriate number key repeatedly, you can access the character you want.

Press Key	one time	two times	three times	four times
2	A	B	C	2
3	D	E	F	3
4	G	H	I	4
5	J	K	L	5
6	M	N	O	6
7	P	Q	R	S
8	T	U	V	8
9	W	X	Y	Z

## Inserting spaces

To enter a space in the fax number, press ► once between numbers. To enter a space in the name, press ► twice between characters.

## Making corrections

If you entered a letter incorrectly and want to change it, press ◀ to move the cursor under the incorrect character. Then press **Stop/Exit**. All letters above and to the right of the cursor will be deleted. Re-enter the correct character. You can also back up and type over incorrect letters.

## Repeating letters

If you need to enter a character that is on the same key as the previous character, press ► to move the cursor to the right before you press the key again.

## Special characters and symbols

Press **\***, **#** or **0**, and then press **◀** or **▶** to move the cursor under the special character or symbol you want. Then press **Menu/Set** to select it.

Press **\*** for (space) ! " # \$ % & ' ( ) \* + , - . / €

Press **#** for : ; < = > ? @ [ ] ^ \_

Press **0** for É À È Ê Î Ç Ë Ö 0

# G Glossary

**ADF (automatic document feeder)** The document can be placed in the ADF and scanned one page at a time automatically.

**Auto Reduction** Reduces the size of incoming faxes.

**Automatic fax transmission** Sending a fax without picking up the handset or pressing **Speaker Phone** (FAX-1940CN), **Hook/Hold** (FAX-1840C), or **Hook** (FAX-1840C, MFC-3240C and MFC-3340CN).

**Automatic Redial** A feature that enables your machine to redial the last fax number after five minutes if the fax did not go through because the line was busy.

**Backup Print** Your machine prints a copy of every fax that is received and stored in memory. This is a safety feature so you will not lose messages during a power failure.

**Batch Transmission** (Black and white faxes only) As a cost saving feature, all delayed faxes to the same fax number will be sent as one transmission.

**Beeper Volume** Volume setting for the beep when you press a key or make an error.

**Brightness** Changing the Brightness makes the whole image lighter or darker.

**Broadcasting** The ability to send the same fax message to more than one location.

**Caller ID** A service purchased from the telephone company that lets you see the number (or name) of the party calling you.

**Cancel Job** Cancels a programmed job, like Delayed Fax or Polling.

**CNG tones** The special tones (beeps) sent by fax machines during automatic transmission to tell the receiving machine that a fax machine is calling.

**Coding method** Method of coding the information contained in the document. All fax machines must use a minimum standard of Modified Huffman (MH). Your machine is capable of greater compression methods, Modified Read (MR), Modified Modified Read (MMR) and JPEG, if the receiving machine has the same capability.

**Communication error (or Comm. Error)** An error during fax sending or receiving, usually caused by line noise or static.

**Compatibility group** The ability of one fax unit to communicate with another. Compatibility is assured between ITU-T Groups.

**Contrast** Setting to compensate for dark or light documents, by making faxes or copies of dark documents lighter and light documents darker.

**Delayed Fax** Sends your fax at a specified later time that day.

**Distinctive Ring** A subscriber service purchased from the telephone company that gives you another phone number on an existing phone line. The Brother machine uses the new number to simulate a dedicated fax line.

**Dual Access** Your machine can scan outgoing faxes or scheduled jobs into memory at the same time it is sending a fax or receiving or printing an incoming fax.

**Easy Receive** Enables your machine to respond to CNG tones if you interrupt a fax call by answering it.

**ECM (Error Correction Mode)** Detects errors during fax transmission and resends the pages of the fax that had an error.

**Extension phone** A telephone on the fax number that is plugged into a separate wall jack.

**External phone** A telephone that is plugged into the EXT jack of your machine.

**F/T Ring Time** The length of time that the Brother machine rings (when the Receive Mode setting is Fax/Tel) to notify you to pick up a voice call that it answered.

**Fax Forwarding** Sends a fax received into the memory to another pre-programmed fax number.

**Fax Receive Code** Press this code (\* 5 1) when you answer a fax call on an extension or external phone.

**Fax Storage** You can store faxes in memory.

**Fax tones** The signals sent by sending and receiving fax machines while communicating information.

**Fax/Tel** You can receive faxes and telephone calls. Do not use this mode if you are using a telephone answering device (TAD).

**Fine resolution** Resolution is 203 x 196 dpi. It is used for small print and graphs.

**Gray scale** The shades of gray available for copying and faxing photographs.

**Group number** A combination of One-Touch and Speed-Dial numbers that are stored on a One-Touch key or in a Speed-Dial location for Broadcasting.

**Help list** A printout of the complete Menu table that you can use to program your machine when you do not have the User's Guide with you.

**Fax Journal** Lists information about the last 200 incoming and outgoing faxes. TX means Transmit. RX means Receive.

**Journal Period** The pre-programmed time period between automatically printed Fax Journal Reports. You can print the Fax Journal on demand without interrupting the cycle.

**LCD (liquid crystal display)** The display screen on the machine that shows interactive messages during On-Screen Programming and shows the date and time when the machine is idle.

**Manual fax** When you lift the handset of the machine (FAX-1840C and FAX-1940CN only) or external telephone or press **Speaker Phone** (FAX-1940CN only) or **Hook** (Except FAX-1940CN) so you can hear the receiving fax machine answer before you press **Black Start** or **Color Start** to begin transmission.

**Menu mode** Programming mode for changing your machine's settings.

**OCR (optical character recognition) (MFC-3240C and MFC-3340CN only)** The bundled ScanSoft® OmniPage® software application converts an image of text to text you can edit.

**One-Touch** Keys on the machine's control panel where you can store numbers for easy dialing. You can store a second number on each key if you press **Shift** and the One-Touch Key together.

**Out of Paper Reception** Receives faxes into the machine's memory when the machine is out of paper.

**Overseas Mode** Makes temporary changes to the fax tones to accommodate noise and static on overseas phone lines.

**Paging** This feature enables your machine to call your pager when a fax is received into its memory. The FAX-1940CN will also page for voice messages.

**Pause** Allows you to place a 3.5 second delay in the dialing sequence stored on One-Touch keys and Speed-Dial numbers. Press **Redial/Pause** as many times as needed for longer pauses.

**PhotoCapture Center™ (MFC-3340CN only)** Allows you to print digital photos from your digital camera at high resolution for photo quality printing.

**Photo resolution** A resolution setting that uses varying shades of gray for the best representation of photographs.

**Polling** The process of a fax machine calling another fax machine to retrieve waiting fax messages.

**Pulse** A form of rotary dialing on a telephone line.

**Quick Dial List** A listing of names and numbers stored in One-Touch and Speed-Dial memory, in numerical order.

**Real Time Transmission** When memory is full, you can send faxes in real time.

**Remaining jobs** You can check which jobs are waiting in memory and cancel jobs individually.

**Remote Access Code** Your own four-digit code (---\*) that allows you to call and access your machine from a remote location.

**Remote Retrieval Access** The ability to access your machine remotely from a touch tone phone.

**Resolution** The number of vertical and horizontal lines per inch.  
See: Standard, Fine, Super Fine and Photo.

**Ring Delay** The number of rings before the machine answers in Fax Only, Fax/Tel and MC:Msg. Ctr. (FAX-1940CN only) mode.

**Ring Volume** Volume setting for the machine's ring.

**Scanning (MFC-3240C and MFC-3340CN only)** The process of sending an electronic image of a paper document into your computer.

**Scan to Card (MFC-3340CN only)** You can scan a black and white or color document into a Media Card. Black and white images will be in TIFF or PDF file format and color images may be in PDF or JPEG file format.

**Search** An electronic, alphabetical listing of stored One-Touch, Speed-Dial and Group numbers.

**Speed-Dial** A pre-programmed number for easy dialing. You must press the **Search/Speed Dial**, **#**, and the two digit code, and **Start** to start the dialing process.

**Standard resolution** 203 x 97 dpi. It is used for regular size text and quickest transmission.

**Station ID** The stored information that appears on the top of faxed pages. It includes the sender's name and fax number.

**Super Fine resolution** 392 x 203 dpi. Best for very small print and line art.

**TAD (telephone answering device)** You can connect an external device or answering machine to the EXT. jack of your machine.

**Telephone Answer Code (Fax/Tel mode only)** When the machine answers a voice call, it pseudo/double-rings. You can pick up at an extension phone by pressing this code (**# 5 1**).

**Temporary settings** You can select certain options for each fax transmission and copy without changing the default settings.

**Tone** A form of dialing on the telephone line used for Touch Tone telephones.

**Transmission** The process of sending faxes over the phone lines from your machine to the receiving fax machine.

**Transmission Verification Report** A listing for each transmission, that shows its date, time and number.

**True2Life® (MFC-3340CN only)** Adjusts the color in the image for better print quality by improving sharpness, white balance and color density.

**User Settings** A printed report that shows the current settings of the machine.



# S Specifications

## Product description

### General

<b>Memory Capacity</b>	8 MB (FAX-1840C and MFC-3240C) 16 MB (FAX-1940CN and MFC-3340CN)
<b>Automatic Document Feeder (ADF)</b>	Up to 20 pages Temperature: 68°F - 86°F (20°C - 30°C) Humidity: 50% - 70% Paper: 20 lb Letter (80 g/m <sup>2</sup> A4) size
<b>Paper Tray</b>	100 Sheets 20 lb (80 g/m <sup>2</sup> )
<b>Printer Type</b>	Ink Jet
<b>Print Method</b>	Piezo with 74 × 5 nozzles
<b>LCD (Liquid Crystal Display)</b>	16 characters × 1 line
<b>Power Source</b>	120V AC 50/60Hz (220 - 240V 50/60Hz)
<b>Power Consumption</b>	(FAX-1840C) Off Mode: Average 4 W Standby: Average 8 W Operating: Average 24 W (MFC-3240C) Off Mode: Average 3.5 W Standby: Average 8 W Operating: Average 24 W (MFC-1940CN and MFC-3340CN) Off Mode: Average 4 W Standby: Average 9 W Operating: Average 24 W

## Dimensions

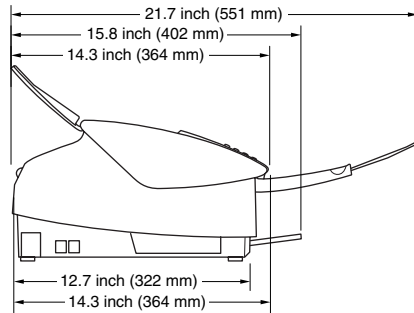
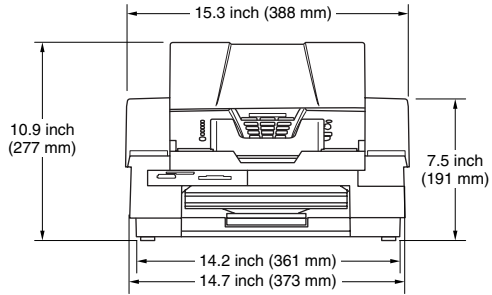

<b>Weight</b>	11 lb (5 kg)
<b>Noise</b>	Operating: 42.5 to 51 dB* * It depends on printing conditions
<b>Temperature</b>	Operating: 50°F - 95°F (5 - 35°C) Best Print Quality: 68°F - 91°F (20 - 33°C)
<b>Humidity</b>	Operating: 20 to 80% (without condensation) Best Print Quality: 20 to 80% (without condensation)

# Print media

## Paper Input

## Paper Tray

- Paper type:  
Plain paper, inkjet paper (coated paper), glossy paper\*<sup>2</sup>, transparencies\*<sup>1\*2</sup> and envelopes
- Paper size:  
Letter, Legal\*<sup>3</sup>, Executive, A4, A5, A6, JIS\_B5, envelopes (commercial No.10, DL, C5, Monarch, JE4), Photo card, Index card and Post card.  
For more details, see *Paper weight, thickness and capacity* on page 1-13.
- Maximum paper tray capacity: Approx. 100 sheets of 20 lb (80 g/m<sup>2</sup>) plain paper

## Paper Output

Up to 50 sheets of Letter (A4) plain paper (Face up print delivery to the output paper tray)\*<sup>2</sup>

\*<sup>1</sup> Use only transparencies recommended for inkjet printing.

\*<sup>2</sup> For glossy paper or transparencies, we recommend removing printed pages from the output paper tray immediately after they exit the machine to avoid smudging.

\*<sup>3</sup> Legal paper cannot be stacked on the output paper tray.

# Copy

## Color/Black

Color/Black

## Document Size

ADF Width: 3.5" to 8.5" (89 mm to 216 mm)

ADF Height: 5" to 14" (127 mm to 356 mm)

## Copy Speed

Mono

Up to 17 pages/minute (Letter paper)\*

Color

Up to 11 pages/minute (Letter paper)\*

\* Does not include the time it takes to feed the paper.

Based on Brother standard pattern. (Fast mode/Stack Copy)

Copy speeds vary with the complexity of the document.

## Multiple Copies

Stacks up to 99 pages

Sorts up to 99 pages (FAX-1940CN and MFC-3340CN only)

## Enlarge/Reduce

25% to 400% (in increments of 1%)

## Resolution

Up to 600 x 1200 dpi copy resolution for plain, inkjet or glossy paper and up to 1200 x 1200 dpi for OHP/transparency

# PhotoCapture Center™ (MFC-3340CN only)

## Available Media

CompactFlash® Version 1.0  
(Microdrive™ is not compatible)  
(Compact I/O card such as Compact LAN card  
and Compact Modem card are not supported.)  
SmartMedia® (3.3V)  
(Not available for use with ID)  
Memory Stick®  
(Not available for music data with MagicGate)  
SecureDigital™  
xD-Picture Card™

## File Extension

(Media Format)

DPOF, EXIF, DCF

(Image Format)

Photo Print: JPEG\*

Scan to Card: JPEG, PDF (Color)

TIFF, PDF (Black)

\* Progressive JPEG format is not supported.

## Color Enhancement

True2Life

## Number of Files

Up to 999 files in the media card

## Folder

File must be in the 3rd folder level of the Media Card.

## Borderless

Letter, A4, Photo Card

# Fax

<b>Compatibility</b>	ITU-T Group 3
<b>Coding System</b>	MH/MR/MMR/JPEG
<b>Modem Speed</b>	Automatic Fallback14400 bps (FAX-1840C) 33600 bps (FAX-1920CN, MFC-3240C and MFC-334CN)
<b>Document Size</b>	ADF Width: 3.5" to 8.5" ADF Height: 5" to 14"
<b>Scanning Width</b>	8.2 in.
<b>Printing Width</b>	8.03 in.
<b>Gray Scale</b>	256 levels
<b>Polling Types</b>	Standard, Sequential: (Black only)
<b>Contrast Control</b>	Automatic/Light/Dark (manual setting)
<b>Resolution</b>	<ul style="list-style-type: none"><li>• Horizontal 203 dot/inch (8 dot/mm)</li><li>• Vertical Standard -<ul style="list-style-type: none"><li>98 line/inch (3.85 line/mm) (Black)</li><li>196 line/inch (7.7 line/mm) (Color)</li><li>Fine - 196 line/inch (7.7 line/mm) (Black/Color)</li><li>Photo - 196 line/inch (7.7 line/mm) (Black)</li><li>Superfine - 392 line/inch (15.4 line/mm) (Black)</li></ul></li></ul>
<b>One-Touch Dial</b>	4 (2 x 2) (FAX-1940CN) 8 (4 x 2) (MFC-3340CN) 10 (5 x 2) (FAX-1840C, MFC-3240C)
<b>Speed-Dial</b>	40 stations (FAX-1840C, MFC-3240C) 100 stations (FAX-1940CN and MFC-3340CN)
<b>Broadcasting</b>	100 stations (FAX-1840C, MFC-3240C) 154 stations (FAX-1940CN) 158 stations (MFC-3340CN)
<b>Automatic Redial</b>	1 time after 5 minutes
<b>Auto Answer</b>	0, 1, 2, 3 or 4 rings
<b>Communication Source</b>	Public switched telephone network.

<b>Memory Transmission</b>	Up to 480* <sup>1</sup> /400* <sup>2</sup> pages (FAX-1940CN, MFC-3340CN) Up to 300* <sup>1</sup> /250* <sup>2</sup> pages (FAX-1840C) Up to 200* <sup>1</sup> /170* <sup>2</sup> pages (MFC-3240C)
<b>Out of Paper Reception</b>	Up to 480* <sup>1</sup> /400* <sup>2</sup> pages (FAX-1940CN, MFC-3340CN) Up to 300* <sup>1</sup> /250* <sup>2</sup> pages (FAX-1840C) Up to 200* <sup>1</sup> /170* <sup>2</sup> pages (MFC-3240C)

\*1 "Pages" refers to the "Brother Standard Chart No. 1" (a typical business letter, Standard resolution, MMR code). Specifications and printed materials are subject to change without prior notice.

\*2 "Pages" refers to the "ITU-T Test Chart #1" (a typical business letter, Standard resolution, MMR code). Specifications and printed materials are subject to change without prior notice.

## Scanner (MFC-3240C and MFC-3340CN only)

<b>Color/Monochrome</b>	Color/Monochrome
<b>TWAIN Compliant</b>	Yes (Windows <sup>®</sup> 98/98SE/Me/2000 Professional/XP) Mac OS <sup>®</sup> 8.6-9.2/Mac OS <sup>®</sup> X 10.2.4 or greater
<b>WIA Compliant</b>	Yes (Windows <sup>®</sup> XP)
<b>Color Depth</b>	36 bit color processing (Input) 24 bit color processing (Output)
<b>Resolution</b>	Up to 2400 × 2400 dpi (interpolated)* Up to 600 × 1200 dpi (optical)  * Maximum 1200 x 1200 dpi scanning with Windows <sup>®</sup> XP (resolution up to 2400 x 2400 dpi can be selected by using the Brother scanner utility)
<b>Scanning Speed</b>	Color: up to 8.37 sec. Mono: up to 3.75 sec. Letter size in 100 × 100 dpi
<b>Document Size</b>	ADF Width: 3.5" to 8.5" (89 mm to 216 mm) ADF Height: 5" to 14" (127 mm to 356 mm)
<b>Scanning Width</b>	8.26 in. (210 mm)
<b>Gray Scale</b>	256 levels



Mac OS<sup>®</sup> X scanning is supported in Mac OS<sup>®</sup> X 10.2.4 or greater.

# Printer



For FAX-1840C and FAX-1940CN, you can download the Brother Printer Driver from the Brother Solutions Center. Visit us at:

<http://solutions.brother.com>

## Printer Driver

Windows® 98/98SE/Me/2000 Professional and XP driver supporting Brother Native Compression mode and bi-directional capability

Apple® Macintosh® QuickDraw® Driver

For Mac OS® 8.6-9.2/Mac OS® X 10.2.4 or greater

## Resolution

Up to 1200 x 6000 dots per inch (dpi)\*

1200 x 1200 dots per inch (dpi)

600 x 600 dots per inch (dpi)

600 x 150 dots per inch (dpi)

\* Output image quality varies based upon many factors including but not limited to input image resolution and quality and print media.

## Print Speed

up to 20 pages/minute (Mono)\*

up to 15 pages/minute (Color)\*

\* Based on Brother standard pattern.  
Letter size in draft mode.

Does not include the time it takes to feed the paper.

## Printing Width

8.03 inches (8.5 inches\*) / 204 mm (216 mm\*)

\* When you set the Borderless feature to On.

## Disk-Based Fonts

35 TrueType

## Borderless

Letter, A4, A6, Photo Card, Index Card, Post Card

# Interfaces

## USB

A Full-Speed USB 2.0 cable that is not longer than 6 feet (2.0 m)\*

\* Your machine has a Full-Speed USB 2.0 interface. This interface is compatible with Hi-Speed USB 2.0; however, the maximum data transfer rate will be 12 Mbits/s. The machine can also be connected to a computer that has a USB 1.1 interface. Please make sure you use a Full-Speed USB 2.0 cable that is no longer than 6 feet (2.0 m).

## LAN cable (MFC-3340CN only)

Ethernet UTP cable category 5 or greater.

# Computer requirements

Minimum System Requirements					
Computer Platform & Operating System Version		Processor Minimum Speed	Minimum RAM	Recommended RAM	Available Hard Disk Space
					for Drivers
Windows® *1 Operating System	98, 98SE	Pentium II or equivalent	32 MB	64 MB	90 MB
	Me		64 MB	128 MB	
	2000 Professional				
	XP*2	128 MB	256 MB	150 MB	
Apple® Macintosh® Operating System	Mac OS® 8.6 (Printing and PC-FAX Send*4 Only)	All base models meet minimum Requirements	128 MB	64 MB	80 MB
	Mac OS® 9.X (Printing, Scanning*3, PhotoCapture Center™ and PC-FAX Send*4 Only)				
	Mac OS® X 10.2.4 or greater				
<b>NOTE:</b> All registered trademarks referenced herein are the property of their respective companies.					

\*1 Microsoft® Internet Explorer 5 or greater.

\*2 Maximum 1200 x 1200 dpi scanning with Windows® XP. (Resolutions up to 2400 x 2400 dpi can be selected using the Brother Utility.)

\*3 Dedicated "Scan" key and direct Network Scanning (MFC-3340CN only) supported in Mac® Operating Systems Mac OS® X 10.2.4 or greater.

\*4 PC Fax supports black and white faxing only.



# Consumable items

## Ink

The machine uses individual Black, Yellow, Cyan and Magenta ink cartridges that are separate from the print head assembly.

## Service Life of Ink Cartridge

Standard Black - Approximately 500 pages at 5% coverage

High Yield Black - Approximately 900 pages at 5% coverage

Yellow, Cyan and Magenta - Approximately 400 pages at 5% coverage

The above figures are based upon the following assumptions:

- Continuous printing at a resolution of 600 x 600 dpi in normal mode after installing new ink cartridge;
- The printing frequency;
- The number of pages printed;
- Periodic, automatic, print head assembly cleaning (Your machine will clean the print head assembly periodically. This process will use a small amount of ink) ; and,
- Ink remaining in cartridge identified as “empty” (It is necessary to leave a small amount of ink in the ink cartridge to prevent air from drying out and damaging the print head assembly).

# Network (LAN) (FAX-1940CN and MFC-3340CN only)

## LAN

You can connect your machine to a network for Network Printing, Network Scanning and PC Fax Send. Also included is Brother BRAdmin Professional Network Management software.

## Support for

Windows® 98/98SE/Me/2000/XP  
Mac OS® 8.6 - 9.2, Mac OS® X 10.2.4 or greater\*  
Ethernet 10/100 BASE-TX Auto Negotiation

## Protocols

TCP/IP  
RARP, BOOTP, DHCP, APIPA, NetBIOS, WINS,  
LPR/LPD, Port9100, SSDP, mDNS, FTP

- \* Network Printing and PC-FAX are available for Mac OS® 8.6-9.2, Mac OS® 10.2.4 or greater.
- \* Mac OS® 8.6-9.2 (Quick Draw over TCP/IP)
- \* Mac OS® X 10.2.4 or greater (mDNS)
- \* Network Scanning and Remote Setup are available for Mac OS® 10.2.4 or greater.
- \* Media drive is not available for Mac® OS 8.6

## Included Utilities:

BRAdmin Professional (Windows®)



BRAdmin Professional is not supported in Mac OS®.

# Optional External Wireless Print/Scan Server (NC-2200w) (MFC-3240C and MFC-3340CN only)

## NC-2200w External Wireless Print/Scan Server (Optional)

Connecting the optional External Wireless Print/Scan Server (NC-2200w) to your machine will allow you to print and scan over a wireless network.

### Network types

IEEE 802.11b wireless LAN

### Support for

Windows® 98/98SE/Me/2000/XP  
Mac OS® X 10.2.4 or greater

### Protocols

TCP/IP  
ARP, RARP, BOOTP, DHCP, APIPA (Auto IP),  
WINS/NetBIOS, DNS, LPR/LPD, Port9100,  
SMB Print, IPP, RawPort, mDNS, TELNET, SNMP,  
HTTP



You can assign the scan key to one networked computer only.

# Index

## A

- Access codes, storing and dialing ..... 5-6
- Accessories and supplies ..... ii
- ADF (automatic document feeder) ..... 1-8, 3-4
- Answering machine (TAD) ... A-11
  - connecting ..... A-12
- Automatic
  - fax receive ..... 4-1, 4-3
    - Easy Receive ..... 4-8, 4-9
  - fax redial ..... 3-3
  - transmission ..... 3-5

## B

- Broadcasting ..... 3-12
  - setting up Groups for ..... 5-4
- Brother
  - accessories and supplies ..... ii
  - Brother numbers ..... i
  - Customer Service ..... i
  - fax back system ..... ii
  - Frequently asked questions (FAQs) ..... i
  - product support ..... i
  - Warranties ..... iii, iv, vi

## C

- Caller ID ..... A-5
  - print list ..... A-6
  - view list ..... A-6
- Canceling
  - Fax Forwarding ..... 6-7
  - fax jobs in memory ..... 3-11
  - jobs awaiting redial ..... 3-11
  - Paging ..... 6-7

- Cleaning
  - print head ..... 12-15
  - printer platen ..... 12-24
  - scanner ..... 12-23
- CNG tones ..... 1-20
- Connecting
  - external TAD ..... A-11
  - external telephone ..... A-10
  - two-line external TAD or telephone ..... A-16
- Consumable items ..... S-9
- Control Center
  - See Software User's Guide on the CD-ROM.....
- Control panel overview ..... 1-2
- Copy
  - brightness ..... 9-8
  - color adjustment ..... 9-13
  - contrast ..... 9-12
  - default settings ..... 9-12
  - Enlarge/Reduce ..... 9-6
  - enter Copy mode ..... 9-1
  - keys ..... 9-3
  - multiple ..... 9-2
  - Out of Memory ..... 9-13
  - Page Layout ..... 9-10
  - paper ..... 9-7
  - Quality key ..... 9-4
  - quality setting ..... 9-12
  - single ..... 9-2
  - Sort (ADF only) ..... 9-9
  - temporary settings ..... 9-3
  - using ADF ..... 9-2
- Cordless phone ..... A-9
- Credit card numbers ..... 5-6
- Custom telephone features
  - on a single line .... 12-12, A-17

## D

- Date and Time ..... 2-1
- Delayed Batch
  - Transmission ..... 3-16
- Dialing
  - a pause ..... 5-6
  - access codes and credit
    - card numbers ..... 5-6
  - automatic fax redial ..... 3-3
  - automatic transmission .... 3-5
  - Groups ..... 3-12
  - manual transmission ..... 3-1
  - Speed-Dial ..... 3-2
- Distinctive Ring ..... A-1
  - setting ring pattern ..... A-4
  - turning off ..... A-4
- Document
  - jam ..... 12-5
- Dual Access ..... 3-9

## E

- Easy Receive ..... 4-8, 4-9
- ECM (Error Correction Mode) ..... 1-21
- Envelopes ..... 1-14
- Equalization ..... 12-14
- Error messages on LCD ... 12-1
  - Comm. Error ..... 12-1
  - Ink Empty ..... 12-2
  - Near Empty ..... 12-2
  - No Paper Fed ..... 12-3
  - Not Registered ..... 3-2, 12-3
  - Out of Memory ..... 12-3
    - while scanning
      - a document ..... 9-13
  - Unable to Change ..... 12-4
  - Unable to Clean ..... 12-4
  - Unable to Init. .... 12-4
  - Unable to Print ..... 12-4
  - Unable to Scan ..... 12-4

- Extension telephone,
  - using .....A-7
- External telephone,
  - connecting .....A-10

## F

- Fax codes
  - changing .....6-5, A-9
  - Fax Receive Code ....4-9, A-7
  - Remote Access Code ..... 6-5
  - Telephone Answer Code ...A-7
- Fax Forwarding
  - changing remotely ...6-7, 6-10
  - programming a number .... 6-1
- Fax Storage ..... 6-3
  - printing from memory ..... 4-10
  - turning on ..... 6-3
- Fax, from PC
  - See Software User's Guide on the CD-ROM. ....
- Fax, stand-alone
  - receiving ..... 4-1, 4-3
    - at end of conversation ... 4-10
    - compatibility ..... 12-14
    - difficulties ..... 12-10
  - Easy Receive ..... 4-9
  - Fax Forwarding ..... 6-7
  - from extension phone ....A-7
  - Paging ..... 6-2
  - Polling Receive ..... 4-11
  - reducing to fit on
    - paper ..... 4-10
  - retrieving from a remote site ..... 6-10
  - Ring Delay, setting ... 4-2, 4-5
  - Sequential Polling ..... 4-11
  - sending ..... 3-1
    - at end of conversation ... 3-6
    - automatic ..... 3-5
    - Broadcasting ..... 3-12

- canceling from
  - memory .....3-11
- color fax .....3-4
- compatibility ..... 12-14
- contrast .....3-7
- enter Fax mode .....3-1
- from memory
  - (Dual Access) .....3-3, 3-9
  - manual .....3-5
  - overseas .....3-13
  - Real Time
    - Transmission .....3-10
    - resolution .....3-8
- Fax/Tel mode .....4-3
  - Announcement .....7-2
  - answering at extension
    - phones .....A-7
  - double-ringing
    - (voice calls) .....4-7
  - F/T Ring Time .....4-7
  - Fax Receive Code .....A-7
  - receiving faxes .....A-8
  - Ring Delay .....4-2, 4-5
  - Telephone Answer Code ...A-7
  - telephone calls .....A-8
- FCC notices ..... 11-1

## G

- Gray scale ..... S-5, S-6
- Groups for Broadcasting .....5-4

## H

- Hearing aid compatible .....2-8
- HELP
  - LCD messages .....B-1
  - using navigation keys ...B-2
  - Menu Table .....B-1, B-3
- Hold .....5-9

## I

- Ink cartridges
  - checking ink volume .....12-19
  - replacing .....12-25
- Ink Dot Counter .....12-25

## J

- Jacks
  - convert to RJ11 jack
    - triplex adapter .....A-14
- EXT
  - external telephone .....A-11
  - TAD (answering
    - machine) .....A-11

## L

- LCD (liquid crystal
  - display) .....B-1, B-2
  - contrast .....2-10
  - Help List .....8-3

## M

- Maintenance, routine .....12-23
- Manual
  - dialing .....3-1, 5-8
  - receive .....4-1, 4-3
  - transmission .....3-5
- Memory Storage .....B-1
- Menu Selection Table .....B-1
- Message Center mode .....7-1
  - erasing messages .....7-5
  - playing voice messages ...7-4
  - printing faxes from
    - memory .....7-5
  - recording a conversation ...7-7
  - recording Fax/Tel
    - announcement
      - (F/T OGM) .....7-7
    - recording outgoing message
      - (Msg Ctr OGM) .....7-2
    - setting up .....7-1, 7-3

Mode, entering	
Copy .....	9-1
Fax .....	3-1
Scan .....	1-4
Multi-line connections	
(PBX) .....	A-17

## N

Network	
Printing	
See Software User's Guide	
on the CD-ROM. ....	
Scanning	
See Software User's Guide	
on the CD-ROM. ....	

## O

On/Off key .....	1-6
Fax Receive setting .....	1-6
One-Touch numbers	
storing .....	5-1
Options key (copying)	
Brightness .....	9-8
Paper Size .....	9-8
Paper Type .....	9-7
Out of Area (Caller ID) .....	A-5
Outgoing Message	
(Msg Ctr OGM) .....	7-2

## P

Paging .....	6-2
programming your pager	
number .....	6-1
Paper .....	1-10, S-3
document size .....	3-4
Size .....	2-4
size of document .....	1-8
Type .....	2-4

PaperPort®	
See Software User's Guide on	
the CD-ROM. ....	
Phone line	
connections .....	A-12
difficulties .....	12-11
multi-line (PBX) .....	A-17
roll over lines .....	A-14
two-line phone system ...	A-14
PhotoCapture Center™	
Borderless .....	10-12
CompactFlash® .....	10-1
Cropping .....	10-12
Default Settings .....	10-9
DPOF printing .....	10-8
from PC	
See Software User's Guide	
on the CD-ROM.....	
Memory Stick® .....	10-1
Printing images .....	10-6
Printing Index .....	10-5
SecureDigital™ .....	10-1
SmartMedia® .....	10-1
specifications .....	S-4
xD-Picture Card™ .....	10-1
Polling .....	4-11
Power failure .....	B-1
Print	
area .....	1-14
difficulties .....	12-9, 12-10
drivers .....	S-7
fax from memory .....	4-10
from PC	
See Software User's Guide	
on the CD-ROM.....	
improving quality .....	12-15
paper jams .....	12-6
report .....	8-3
resolution .....	S-7
specifications .....	S-7

Programming your machine ..... B-1, B-2

## Q

Quality key (copying) ..... 9-3  
Quick-Dial ..... 5-1  
    Access codes and credit card numbers  
        setting up ..... 5-6  
Broadcasting ..... 3-12  
    using Groups ..... 3-12  
Group dial  
    changing ..... 5-3  
    setting up Groups for Broadcasting ..... 5-4  
One-Touch dial  
    setting up ..... 5-1  
    using ..... 3-2  
Search ..... 3-3  
Speed-Dial  
    changing ..... 5-3  
    setting up ..... 5-2  
    using ..... 3-2

## R

Receive Mode ..... 4-2  
    External TAD ..... 4-1  
    Fax Only ..... 4-1  
    Fax/Tel ..... 4-1, 4-3  
    Manual ..... 4-1  
    MC Msg. Ctr ..... 4-3  
Redial/Pause ..... 3-3  
Reducing  
    copies ..... 9-6  
    incoming faxes ..... 4-10  
Remote Retrieval ..... 6-6  
    access code ..... 6-5, 6-6  
    commands ..... 6-7  
    getting your faxes ..... 6-10

## Remote Setup

    See Software User's Guide on the CD-ROM.....  
Reports ..... 8-1  
    Caller ID List ..... A-6  
    Fax Journal ..... 8-3  
        Journal Period ..... 8-2  
    Help List ..... 8-3  
    how to print ..... 8-3  
    Network Configuration ..... 8-3  
    Quick-Dial List ..... 8-3  
    Transmission  
        Verification ..... 8-1, 8-3  
    User Settings ..... 8-3  
Resolution  
    copy ..... S-3  
    fax (Standard, Fine, SuperFine, Photo) ..... S-5  
    print ..... S-7  
    scan ..... S-6  
    setting for next fax ..... 3-8  
Ring Delay, setting ..... 4-2, 4-5

## S

Safety Instructions ..... vii, 11-6  
Scanning  
    See Software User's Guide on the CD-ROM.....  
Setup  
    Date and Time ..... 2-1  
    Station ID (fax header)  
        entering text ..... 2-2  
Shipping the machine ..... 12-20  
Speed-Dial  
    changing ..... 5-3  
    dialing ..... 3-2  
    storing ..... 5-2



## T

- TAD (telephone answering device), external
  - ..... 4-1, 4-3, A-11, A-16
  - connecting ..... A-11, A-12
  - receive mode ..... 4-1, 4-3
  - recording OGM ..... A-13
  - with two-line jack ..... A-16
- Temporary copy settings .... 9-3
- Text, entering ..... B-12
  - special characters ..... B-13
- Tone signals on Pulse line ... 5-7
- Troubleshooting ..... 12-1
  - checking ink volume .... 12-19
  - error messages on LCD ... 12-1
  - if you are having difficulty
    - copying ..... 12-12
    - incoming calls ..... 12-12
    - Network ..... 12-13
    - phone line ..... 12-14
    - phone line
      - difficulties ..... 12-11
  - PhotoCapture Center™ ..... 12-13
  - printing ..... 12-9
  - printing or received
    - faxes ..... 12-10
  - printing or receiving
    - faxes ..... 12-10, 12-11
  - Printing Received
    - Faxes ..... 12-10, 12-11
    - receiving faxes ..... 12-11
    - scanning ..... 12-12
    - sending faxes ..... 12-11
    - software ..... 12-12
  - paper jam ..... 12-6
  - print quality ..... 12-15
- True2Life®
  - PhotoCapture Center™ ... 10-10
- Two-line phone system .... A-14

## V

- Volume, setting ..... 2-5
  - beeper ..... 2-5
  - handset ..... 2-8
  - Volume Amplify (for hearing-impaired) ..... 2-9
- ring ..... 2-5
- speaker ..... 2-6

## W

- Warranties ..... iii
  - Canada ..... vi
  - Notice-Disclaimer ..... iii
  - USA ..... iv
- World Wide Web ..... i

# Remote Retrieval Access card (FAX-1940CN only)

If you plan to retrieve voice or fax messages while away from your machine, carrying the Remote Retrieval Access Card printed below will serve as a convenient reminder of the retrieval procedures. Simply cut out the card and fold it to fit in your wallet or organizer. Keeping it handy will help you derive the full benefit of your machine's Paging, Fax Forwarding, and Remote Retrieval features.

<p><b>Changing Remote Access Code</b></p> <ol style="list-style-type: none"><li>1 Press <b>Menu/Set</b>.</li><li>2 Enter a three-digit number from 000 to 999. The * cannot be changed.</li><li>3 Press <b>Menu/Set</b>.</li><li>4 Press <b>Stop/Exit</b>.</li></ol>	<p><b>Erase All Voice Messages</b></p> <p>Press <b>9 3</b>. If you hear three beeps, all messages have not yet been played and the system will not erase them.</p>	<p><b>Change Paging/Fax Forwarding Setting</b></p> <p>Press <b>9 5</b> then to <b>Turn feature OFF</b>, press <b>1</b>, press <b>2</b>. <b>Switch On Fax Forwarding Number</b>, press <b>2</b>. <b>Enter Paging Number</b>, press <b>3</b>. <b>Program Fax Forward Number</b>, press <b>4</b>. Enter the new number of the remote fax machine where you want your fax messages forwarded followed by <b>#</b>. <b>Select Fax Storage</b>, press <b>6</b>.</p>
<p><b>Remote Commands</b></p> <p><b>Listen to Voice Messages</b></p> <p>Press <b>9 1</b> then to <b>Repeat a message</b>, press <b>1</b>. <b>Skip to next messages</b>, press <b>2</b>. <b>Stop playing the messages</b>, press <b>9</b>.</p>	<p><b>Play/Record Outgoing Message</b></p> <p>Press <b>9 4</b> then to <b>Play Message Center OGM</b>, press <b>1 1</b>. <b>Play Fax/Tel OGM</b>, press <b>1 2</b>. <b>Record new Message Center OGM</b>, press <b>2 1</b>, then speak after the beep. Press <b>9</b> to stop. <b>Record new Fax/Tel OGM</b>, press <b>2 2</b>, and then speak after the beep. Press <b>9</b> to stop.</p>	<p><b>Retrieve a Fax</b></p> <p>Press <b>9 6</b> then to <b>Retrieve all faxes</b>, press <b>2</b>, then enter the number of the remote fax machine followed by <b>#</b>. After the beep, hang up and wait. <b>Erase all fax messages</b>, press <b>3</b>.</p>

## Check Receiving Status

Press **9 7**  
*then for:* Fax messages, press **1**.  
Voice messages, press **2**.  
1 long beep — Received message  
3 short beeps — No messages

## Change Receive Mode

Press **9 8**  
*then for:* M.C.:Msg Ctr., press **1**.  
Fax/Tel, press **2**.  
Fax Only, press **3**.

## Exit Remote Retrieval

Press **9 0**.

## MESSAGE CENTER REMOTE RETRIEVAL ACCESS CARD

### Using Remote Access Code

- 1 Dial your fax number from a telephone or fax machine using touch tone.
- 2 When your machine answers, immediately enter your Remote Access Code (3 digits followed by \*).
- 3 Your fax machine signals the kinds of messages it received:
  - 1 long beep — Fax messages
  - 2 long beeps — Voice messages
  - 3 long beeps — Voice and Fax messages
  - No beeps — No messages
- 4 After 2 short beeps, enter a command.
- 5 Press **9 0** to reset the fax machine when you finish.
- 6 Hang up.

# Remote Retrieval Access card

(FAX-1840C, MFC-3240C and MFC-3340CN only)

If you plan to receive fax messages while away from your machine, carrying the Remote Retrieval Access Card printed below will serve as a convenient reminder of the retrieval procedures. Simply cut out the card and fold it to fit your wallet or organizer. Keeping it handy will help you derive the full benefit of your machine's Paging, Fax Forwarding, and Remote Retrieval features.

**REMOTE RETRIEVAL ACCESS CARD**

**CHECK RECEIVING STATUS**  
Press **9 7 1**  
1 long beep — Fax messages  
3 short beeps — No messages

**CHANGE RECEIVE MODE**  
Press **9 8**  
*then, for* External TAD, press **1**.  
Fax/Tel, press **2**.  
Fax Only, press **3**.

**EXIT REMOTE OPERATION**  
Press **9 0**.

**Using Remote Access Code**

- 1 Dial your fax number from a telephone or fax machine using touch tone.
- 2 When your machine answers, immediately enter your Remote Access Code (3 digits followed by \*).
- 3 Your machine signals the kinds of messages it received:  
1 long beep — Fax messages  
No beeps — No messages.
- 4 After 2 short beeps, enter a command.
- 5 Press **9 0** to reset your machine when you finish.
- 6 Hang up.

Fold →      ← Fold

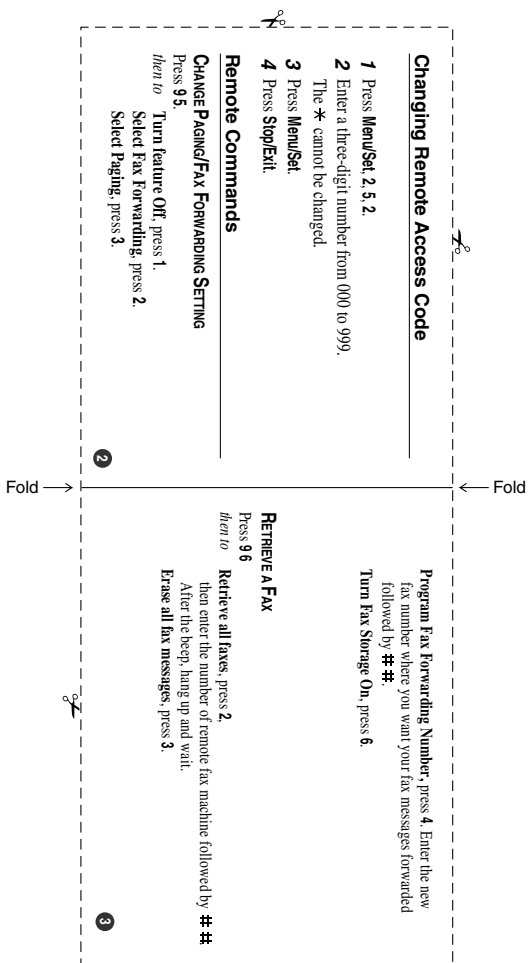

## **EQUIPMENT ATTACHMENT LIMITATIONS (Canada only)**

### **NOTICE**

This product meets the applicable Industry Canada technical specifications.

### **NOTICE**

The Ringer Equivalence Number is an indication of the maximum number of devices allowed to be connected to a telephone interface. The termination on an interface may consist of any combination of devices subject only to the requirement that the sum of the RENs of all the devices does not exceed five.

# brother®

Brother International Corporation  
100 Somerset Corporate Boulevard  
P.O. Box 6911  
Bridgewater, NJ 08807-0911 USA

Brother International Corporation (Canada) Ltd.  
1 rue Hôtel de Ville,  
Dollard-des-Ormeaux, QC, CANADA H9B 3H6

**Visit us on the World Wide Web**  
**<http://www.brother.com>**

These machines are made for use in the USA and Canada only. We cannot recommend using them overseas because it may violate the Telecommunications Regulations of that country and the power requirements of your multi-function center may not be compatible with the power available in foreign countries. **Using USA or Canada models overseas is at your own risk and may void your warranty.**



LF5686001①

## Free Manuals Download Website

<http://myh66.com>

<http://usermanuals.us>

<http://www.somanuals.com>

<http://www.4manuals.cc>

<http://www.manual-lib.com>

<http://www.404manual.com>

<http://www.luxmanual.com>

<http://aubethermostatmanual.com>

Golf course search by state

<http://golfingnear.com>

Email search by domain

<http://emailbydomain.com>

Auto manuals search

<http://auto.somanuals.com>

TV manuals search

<http://tv.somanuals.com>