

MANUALS  
LIBRARY

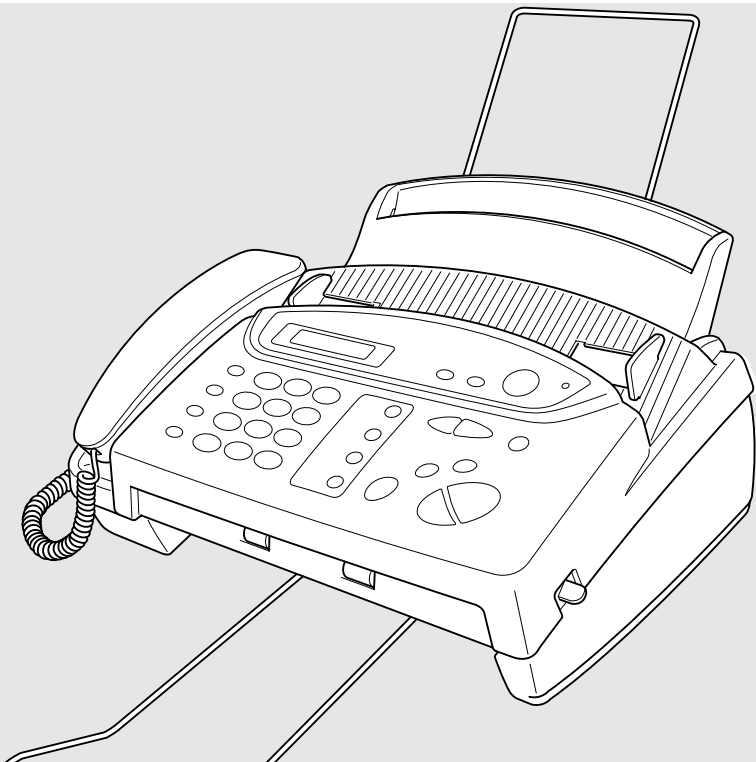

# FAX 580MC MFC 660MC

.....

**brother**

## If You Need to Call Customer Service

Please complete the following information for future reference:

**Model: FAX580MC MFC660MC**  
(Circle your model number)

**Serial Number:\*** \_\_\_\_\_

**Date of Purchase:** \_\_\_\_\_

**Place of Purchase:** \_\_\_\_\_

\* The serial number is on the underside of the unit. Retain this Quick-Start Manual with your sales receipt as a permanent record of your purchase, in the event of a theft, fire or warranty service.

## Year 2000 Compliant

Brother is addressing the Year 2000 related issues for all Brother FAX/MFC and multi-function centers. Our focus is to ensure that our bundled third party software will continue to properly process date/time data after January 1, 2000.

Brother FAX/MFC and multi-function centers will function properly after January 1, 2000, provided that all non-Brother hardware, software and firmware used by our customers in connection or combination with Brother FAX/MFC, and bundled software, accurately exchange date data with the Brother products.

Please continue to check our Web page for updates at **<http://www.brother.com>**. All remedies will be provided to individual customers via software patches through software download or from Brother Customer Service.

# Brother Numbers

---

## Brother fax-back system

Brother Customer Service has installed an easy-to-use fax-back system, so you can get instant answers to common technical questions and product information for all Brother products. This system is available 24 hours a day, 7 days a week. You can use the system to send faxes to any fax machine, not just the one from which you are calling.

If you can't resolve difficulty with your FAX/MFC using this manual, call our fax-back system, and follow the voice prompts to receive faxed instructions about using the system, and an index of fax-back subjects.

**USA:** 1-800-521-2846

**From within Canada:** 1-800-681-9838

The Brother fax-back system number (USA only) has been preprogrammed on One Touch key **1**.

## Frequently Asked Questions (FAQs)

You can find more information about Brother products on the World Wide Web. From product specification sheets to Frequently Asked Questions (FAQs), it is all there. Visit us at:

**<http://www.brother.com>**

## Brother Bulletin Board

Brother's Bulletin Board Numbers are

**USA:** 1-888-298-3616

**From within Canada:** 1-514-685-2040

## For Customer Service

**USA:** 1-800-284-4329 (voice)  
1-908-575-8790 (fax)

**From within Canada:** 1-800-853-6660 (voice)  
1-514-685-4898 (fax)

**From within Montreal:** 1-514-685-6464 (voice)

# Ordering Accessories and Supplies

For the best quality results use only genuine Brother accessories, available at most Brother retailers. If you cannot find the accessory you need and you have a Visa, Master Card, Discover or American Express credit card, you can order accessories directly from Brother.

**USA:** 1-888-879-3232 (voice)  
1-800-947-1445 (fax)

**From within Canada:** 1-800-668-2768 (voice)

DESCRIPTION	ITEM
Thermal Print Cartridge	PC401
2-PK Refill Ribbon Rolls	PC402RF
Telephone Line Cord	Tell the Brother Representative your Model number so you get the appropriate color.
Telephone Handset	Tell the Brother Representative your Model number so you get the appropriate color.
Handset Curled Cord	Tell the Brother Representative your Model number so you get the appropriate color.
Paper Wire Extension	UF9869001
Output Paper Support	LE4129001
Paper Tray	LE4126001
Owner's Manual	LE4171001
Surge Protection Device with Telephone Line Protection (2 outlets)	QPD 120
Surge Protection Device with Telephone Line Protection (8 outlets)	FX 120
Multi-function Link <sup>®</sup> option on Floppy Disks for Windows <sup>®</sup> 3.1, 3.11	MFL-2D31
Multi-function Link <sup>®</sup> option on Floppy Disks for Windows <sup>®</sup> 95	MFL-2D95

## **Notice – Disclaimer of Warranties (For USA and Canada)**

BROTHER'S LICENSOR(S), AND THEIR DIRECTORS, OFFICERS, EMPLOYEES OR AGENTS (COLLECTIVELY BROTHER'S LICENSOR) MAKES NO WARRANTIES, EXPRESS OR IMPLIED, INCLUDING WITHOUT LIMITATION THE IMPLIED WARRANTIES OF MERCHANTABILITY AND FITNESS FOR A PARTICULAR PURPOSE, REGARDING THE SOFTWARE. BROTHER'S LICENSOR(S) DOES NOT WARRANT, GUARANTEE OR MAKE ANY REPRESENTATIONS REGARDING THE USE OR THE RESULTS OF THE USE OF THE SOFTWARE IN TERMS OF ITS CORRECTNESS, ACCURACY, RELIABILITY, CURRENTNESS OR OTHERWISE. THE ENTIRE RISK AS TO THE RESULTS AND PERFORMANCE OF THE SOFTWARE IS ASSUMED BY YOU. THE EXCLUSION OF IMPLIED WARRANTIES IS NOT PERMITTED BY SOME STATES IN THE USA AND SOME PROVINCES IN CANADA. THE ABOVE EXCLUSION MAY NOT APPLY TO YOU.

IN NO EVENT WILL BROTHER'S LICENSOR(S) BE LIABLE TO YOU FOR ANY CONSEQUENTIAL, INCIDENTAL OR INDIRECT DAMAGES (INCLUDING DAMAGES FOR LOSS OF BUSINESS PROFITS, BUSINESS INTERRUPTION, LOSS OF BUSINESS INFORMATION, AND THE LIKE) ARISING OUT OF THE USE OR INABILITY TO USE THE SOFTWARE EVEN IF BROTHER'S LICENSOR HAS BEEN ADVISED OF THE POSSIBILITY OF SUCH DAMAGES. BECAUSE SOME STATES IN THE USA AND SOME PROVINCES IN CANADA DO NOT ALLOW THE EXCLUSION OR LIMITATION OF LIABILITY FOR CONSEQUENTIAL OR INCIDENTAL DAMAGES, THE ABOVE LIMITATIONS MAY NOT APPLY TO YOU. IN ANY EVENT BROTHER'S LICENSOR'S LIABILITY TO YOU FOR ACTUAL DAMAGES FROM ANY CAUSE WHATSOEVER, AND REGARDLESS OF THE FORM OF THE ACTION (WHETHER IN CONTRACT, TORT (INCLUDING NEGLIGENCE), PRODUCT LIABILITY OR OTHERWISE), WILL BE LIMITED TO \$50.

## **Compilation and Publication Notice**

Under the supervision of Brother Industries, Ltd., this manual has been compiled and published, covering the latest product descriptions and specifications.

The contents of this manual and the specifications of this product are subject to change without notice.

Brother reserves the right to make changes without notice in the specifications and materials contained herein and shall not be responsible for any damages (including consequential) caused by reliance on the materials presented, including but not limited to typographical and other errors relating to the publication.

## **Trademarks**

The Brother logo is a registered trademark of Brother Industries, Ltd.

Brother is a registered trademark of Brother Industries, Ltd.

IBM, IBM PC, MWAVE and IBM Aptiva are registered trademarks of International Business Machines Corporation.

ScanSoft PaperPort is a registered trademark of ScanSoft, Inc.

Microsoft and MS-DOS are registered trademarks of Microsoft Corporation.

Windows and Windows NT are registered trademarks of Microsoft in the U.S. and other countries.

**All other terms and brand and product names mentioned in this manual are registered trademarks of their respective companies.**

## **BROTHER 90 DAY LIMITED WARRANTY and EXCHANGE SERVICE** **(For FAX 580MC Only)** **(For USA Only)**

This warranty gives you certain rights and you may also have other rights that may vary from state to state.

This warranty is given only to the first end-use purchaser of the accompanying product (referred to in this warranty as "this Product").

**What is covered:** Brother warrants to you for the Warranty Period that there are no defects in the materials, workmanship or Year 2000 compliance of this Product. The "Warranty Period" is 90 days from the date you purchased this product. The "Warranty Period" for consumable items, such as Toner, Drums, Ribbons, etc. is 90 days from the date of purchase, or the rated life of the Consumable item, whichever is shorter.

**What is NOT covered:** This warranty is VOID -- that is, this Product has no warranty -- if: (1) you did not purchase this Product from an authorized Brother reseller within the United States, (2) this Product has been serviced, modified or tampered with by anyone other than an Authorized Service Representative of Brother, (3) the serial number has been modified, defaced or removed from this Product, (4) this Product has been abused or damaged, (5) non Brother<sup>®</sup>-brand or non Brother approved parts, supplies, power supplies or other accessories have been used with this Product, or (6) this Product has been transported without the proper preparation and packaging.

**What to do if you think your Product is defective:**

Call our Customer Service Hotline at 1-800-284-4329, or if you suspect a defect in materials or workmanship in this Product, you can report it to a Brother Authorized Service Center. During the Warranty Period, supply Brother's representative with a copy of your dated bill of sale showing that this Product was purchased within the United States. For the name of your Brother Authorized Service Center, call 1-800-521-2846. After contacting the Brother Authorized Service Center, you

may be required to deliver or send the Product properly packaged, freight prepaid, to the Authorized Service Center together with a photocopy of your bill of sale.

**What Brother will do:** Brother (or its Authorized Service Center) will evaluate your report of a possible defect to determine whether a defect exists, and if it does exist, Brother (or its Authorized Service Center) will repair or (at Brother's option) replace the Product with a product that performs the same functions and performs as well as the original Product. Brother reserves the right to supply refurbished or remanufactured replacement parts provided that the replacement parts conform to the manufacturer's specifications for new products. The repaired or replacement product will be returned to you at no cost.

### **Exchange Service:**

When an exchange is authorized, Brother will exchange your non-working product with a refurbished or remanufactured product that conforms to the manufacturer's specifications for new products. The refurbished or remanufactured Product you receive will be covered by the balance of the limited warranty period remaining on the original Product, plus an additional thirty (30) days. You will keep the replacement Product that is sent to you and must return (or be billed up to the cost of a new product) your original non-working product, which shall become the property of Brother. You must call Brother Customer Service and if the representative cannot correct the product's malfunction over the telephone and you elect the exchange service, you must provide information pertaining to this Product and you must also provide a valid major credit card number. Your credit card will be charged up to the cost of a new Product if: (i) you do not return your original Product to Brother within five (5) business days; (ii) the malfunctions of your original Product are not covered by the limited warranty; (iii) the proper

**BROTHER 90 DAY LIMITED WARRANTY and EXCHANGE SERVICE**  
**(For FAX 580MC Only)**  
**(For USA Only)**

packaging instructions are not followed and has caused damage to the product; or (iv) the warranty period on your original Product has expired or has not been sufficiently validated with a copy of the proof of purchase (bill of sale). The Brother Customer Service Representative will ship the exchange Product via next business day delivery courier service, with return instructions and prepaid return air bill. Follow the return instructions. You must return the original Product in the same shipping carton in which the exchanged Product was received and include a copy of proof of purchase (bill of sale). Retain your original accessory items and a copy of the return air bill, signed by the courier.

**Limitations:**

Repair or replacement as described above is your sole and exclusive (that is, your only) remedy if this Product is defective. Brother is not responsible for damage to or loss of any equipment, media, programs or data related to the use of this Product. Except for that repair or replacement, *Brother shall not be liable for any direct, indirect, incidental or consequential damages or specific relief. Because some states do not allow the exclusion or limitation of consequential or incidental damages, the above limitation may not apply to you.*

THIS WARRANTY IS GIVEN IN LIEU OF ALL OTHER WARRANTIES, WRITTEN OR ORAL, WHETHER EXPRESSED BY AFFIRMATION, PROMISE, DESCRIPTION, DRAWING, MODEL OR SAMPLE. ANY AND ALL WARRANTIES OTHER THAN THIS ONE, WHETHER EXPRESS OR IMPLIED, INCLUDING IMPLIED WARRANTIES OF MERCHANTABILITY AND FITNESS FOR A PARTICULAR PURPOSE, ARE HEREBY DISCLAIMED.

This Limited Warranty is the only warranty that Brother is giving for this Product. It is the *final expression and the exclusive and only statement of*

Brother's obligations to you. It replaces all other agreements and understandings that you may have with Brother or its representatives.

This Limited Warranty (and Brother's obligation to you) may not be changed in any way unless you and Brother sign the same piece of paper in which we (1) refer to this Product and your bill of sale date, (2) describe the change to this warranty and (3) agree to make that change.

**Product Support:** Toll-free customer service and technical support is available for hardware operational assistance at 1-800-284-4329. At any time, free technical support in the form of Frequently Asked Questions, troubleshooting tips and service center locator is available through our fax-back system at 1-800-521-2846 or Brother's Internet Web Site ([www.brother.com](http://www.brother.com)). Now you can visit us on-line ([www.brothermall.com](http://www.brothermall.com)), your complete source for genuine Brother Accessories and Supplies.

**BROTHER INTERNATIONAL CORPORATION**  
**100 SOMERSET CORPORATE BLVD.**  
**BRIDGEWATER, NEW JERSEY 08807-0911**

Please record your model and serial numbers and your date and location of Purchase below for your records. Keep this information with your proof of purchase (bill of sale) in case your Product is lost, stolen or requires service.

Model # \_\_\_\_\_

Serial # \_\_\_\_\_

Date of purchase: \_\_\_\_\_

Store where purchased: \_\_\_\_\_

Location of store: \_\_\_\_\_

**Important:** *We recommend that you keep all original packing materials, in the event that you ship this product.*

# **BROTHER ONE YEAR LIMITED WARRANTY and EXCHANGE SERVICE**

## **(For MFC 660MC Only)**

### **(For USA Only)**

This warranty gives you certain rights and you may also have other rights that may vary from state to state.

This warranty is given only to the first end-use purchaser of the accompanying product (referred to in this warranty as "this Product").

**What is covered:** Brother warrants to you for the Warranty Period that there are no defects in the materials, workmanship or Year 2000 compliance of this Product. The "Warranty Period" is 1 year from the date you purchased this product. The "Warranty Period" for consumable items, such as Toner, Drums, Ribbons, etc. is 90 days from the date of purchase, or the rated life of the Consumable item, whichever is shorter.

**What is NOT covered:** This warranty is VOID -- that is, this Product has no warranty -- if: (1) you did not purchase this Product from an authorized Brother reseller within the United States, (2) this Product has been serviced, modified or tampered with by anyone other than an Authorized Service Representative of Brother, (3) the serial number has been modified, defaced or removed from this Product, (4) this Product has been abused or damaged, (5) non Brother<sup>®</sup>-brand or non Brother approved parts, supplies, power supplies or other accessories have been used with this Product, or (6) this Product has been transported without the proper preparation and packaging.

**What to do if you think your Product is defective:**

Call our Customer Service Hotline at 1-800-284-4329, or if you suspect a defect in materials or workmanship in this Product, you can report it to a Brother Authorized Service Center. During the Warranty Period, supply Brother's representative with a copy of your dated bill of sale showing that this Product was purchased within the United States. For the name of your Brother Authorized Service Center, call 1-800-521-2846. After contacting the Brother Authorized Service Center, you

may be required to deliver or send the Product properly packaged, freight prepaid, to the Authorized Service Center together with a photocopy of your bill of sale.

**What Brother will do:** Brother (or its Authorized Service Center) will evaluate your report of a possible defect to determine whether a defect exists, and if it does exist, Brother (or its Authorized Service Center) will repair or (at Brother's option) replace the Product with a product that performs the same functions and performs as well as the original Product. Brother reserves the right to supply refurbished or remanufactured replacement parts provided that the replacement parts conform to the manufacturer's specifications for new products. The repaired or replacement product will be returned to you at no cost.

#### **Exchange Service:**

When an exchange is authorized, Brother will exchange your non-working product with a refurbished or remanufactured product that conforms to the manufacturer's specifications for new products. The refurbished or remanufactured Product you receive will be covered by the balance of the limited warranty period remaining on the original Product, plus an additional thirty (30) days. You will keep the replacement Product that is sent to you and must return (or be billed up to the cost of a new product) your original non-working product, which shall become the property of Brother. You must call Brother Customer Service and if the representative cannot correct the product's malfunction over the telephone and you elect the exchange service, you must provide information pertaining to this Product and you must also provide a valid major credit card number. Your credit card will be charged up to the cost of a new Product if: (i) you do not return your original Product to Brother within five (5) business days; (ii) the malfunctions of your original Product are not covered by the limited warranty; (iii) the proper



**BROTHER ONE YEAR LIMITED WARRANTY and EXCHANGE SERVICE**  
**(For MFC 660MC Only)**  
**(For USA Only)**

packaging instructions are not followed and has caused damage to the product; or (iv) the warranty period on your original Product has expired or has not been sufficiently validated with a copy of the proof of purchase (bill of sale). The Brother Customer Service Representative will ship the exchange Product via next business day delivery courier service, with return instructions and prepaid return air bill. Follow the return instructions. You must return the original Product in the same shipping carton in which the exchanged Product was received and include a copy of proof of purchase (bill of sale). Retain your original accessory items and a copy of the return air bill, signed by the courier.

**Limitations:**

Repair or replacement as described above is your sole and exclusive (that is, your only) remedy if this Product is defective. Brother is not responsible for damage to or loss of any equipment, media, programs or data related to the use of this Product. Except for that repair or replacement, *Brother shall not be liable for any direct, indirect, incidental or consequential damages or specific relief. Because some states do not allow the exclusion or limitation of consequential or incidental damages, the above limitation may not apply to you.*

THIS WARRANTY IS GIVEN IN LIEU OF ALL OTHER WARRANTIES, WRITTEN OR ORAL, WHETHER EXPRESSED BY AFFIRMATION, PROMISE, DESCRIPTION, DRAWING, MODEL OR SAMPLE. ANY AND ALL WARRANTIES OTHER THAN THIS ONE, WHETHER EXPRESS OR IMPLIED, INCLUDING IMPLIED WARRANTIES OF MERCHANTABILITY AND FITNESS FOR A PARTICULAR PURPOSE, ARE HEREBY DISCLAIMED.

This Limited Warranty is the only warranty that Brother is giving for this Product. It is the *final expression and the exclusive and only statement of*

Brother's obligations to you. It replaces all other agreements and understandings that you may have with Brother or its representatives.

This Limited Warranty (and Brother's obligation to you) may not be changed in any way unless you and Brother sign the same piece of paper in which we (1) refer to this Product and your bill of sale date, (2) describe the change to this warranty and (3) agree to make that change.

**Product Support:** Toll-free customer service and technical support is available for hardware operational assistance at 1-800-284-4329. At any time, free technical support in the form of Frequently Asked Questions, troubleshooting tips and service center locator is available through our fax-back system at 1-800-521-2846 or Brother's Internet Web Site ([www.brother.com](http://www.brother.com)). Now you can visit us on-line ([www.brothermall.com](http://www.brothermall.com)), your complete source for genuine Brother Accessories and Supplies.

**BROTHER INTERNATIONAL CORPORATION**  
**100 SOMERSET CORPORATE BLVD.**  
**BRIDGEWATER, NEW JERSEY 08807-0911**

Please record your model and serial numbers and your date and location of Purchase below for your records. Keep this information with your proof of purchase (bill of sale) in case your Product is lost, stolen or requires service.

Model # \_\_\_\_\_

Serial # \_\_\_\_\_

Date of purchase: \_\_\_\_\_

Store where purchased: \_\_\_\_\_

Location of store: \_\_\_\_\_

**Important:** *We recommend that you keep all original packing materials, in the event that you ship this product.*

**BROTHER MULTIFUNCTION CENTER/FACSIMILE MACHINE  
LIMITED WARRANTY  
(For Canada Only)**

Pursuant to this limited warranty of 1 year from the date of purchase for labour and parts, Brother International Corporation (Canada) Ltd. ("Brother"), or its Authorized Service Centers, will repair this MFC/Facsimile machine free of charge if defective in material or workmanship. This Limited Warranty does not include cleaning, consumables (including, without limitation, print cartridges, print head, toner and drum) or damage caused by accident, neglect, misuse or improper installation or operation, any damage caused from service, maintenance, modifications, or tampering by anyone other than a Brother Authorized Service Representative, or from the use of supplies or consumable items that are non-Brother products. Operation of the MFC/Facsimile machine in excess of the specifications or with the Serial Number or Rating Label removed shall be deemed abuse and all repairs thereafter shall be the sole liability of the end-user/purchaser. In order to obtain warranty service, the MFC/Facsimile machine must be delivered or shipped freight prepaid by the end user/purchaser to a "Brother" Authorized Service Center, together with your Proof of Purchase in the form of a Sales Receipt.

For laser products: Failure to remove the Toner Cartridge (and Toner Drum Unit on applicable models) during shipping will cause severe damage to the MFC/Facsimile and will VOID the Warranty. (Refer to your Operation Manual for proper packaging.)

For ink-jet products: Do not remove the ink cartridges during shipping. Damage to your print head resulting from packing without the ink cartridges will VOID your warranty. (Refer to your Operation Manual for proper packaging.)

BROTHER DISCLAIMS ALL OTHER WARRANTIES EXPRESSED OR IMPLIED INCLUDING, WITHOUT LIMITATION, ANY IMPLIED WARRANTIES OF MERCHANTABILITY OR FITNESS FOR A PARTICULAR PURPOSE, EXCEPT TO THE EXTENT THAT ANY WARRANTIES IMPLIED BY LAW CANNOT BE VALIDLY WAIVED.

No oral or written information, advice or representation provided by Brother, its Authorized Service Centers, Distributors, Dealers, Agents or employees, shall create another warranty or modify this warranty. This warranty states Brother's entire liability and your exclusive remedy against Brother for any failure of the MFC/Facsimile machine to operate properly.

Neither Brother nor anyone else involved in the development, production, or delivery of this MFC/Facsimile machine shall be liable for any indirect, incidental, special, consequential, exemplary, or punitive damages, including lost profits, arising from the use of or inability to use the product, even if advised by the end user/purchaser of the possibility of such damages. Since some Provinces do not allow the above limitation of liability, such limitation may not apply to you.

This Limited Warranty gives you specific legal rights and you may also have other rights which vary from Province to Province.

**Warranty Service is available at Brother Authorized Service Centers throughout Canada. For Technical Support or for the name and location of your nearest Authorized Service Center call 1-800-853-6660. Within Montreal, please call 685-6464. Internet support: [support@brother.ca](mailto:support@brother.ca) or browse Brother's Web Site: [www.brother.com](http://www.brother.com)**

Brother International Corporation (Canada) Ltd.  
1 Rue Hôtel de Ville  
Dollard-Des-Ormeaux, QC H9B 3H6

We're at your side.  
**brother**®

# Table of Contents

---

## 1

<b>Introduction .....</b>	<b>1-1</b>
Using This Manual .....	1-1
Finding Information.....	1-1
About FAX/MFC .....	1-1
Fax Tones and Handshake.....	1-2
ECM (Error Correction Mode).....	1-2
FAX 580MC and MFC 660MC Control Panel Overview .....	1-3

## 2

<b>Location and Connections .....</b>	<b>2-1</b>
Caution .....	2-1
Choosing a Location.....	2-1
Packing List.....	2-2
Assembly.....	2-2
Attach the paper wire extension .....	2-2
Attach the paper tray .....	2-3
Attach the output paper support .....	2-3
Loading the Paper.....	2-3
Acceptable Paper .....	2-4
Connections .....	2-4
Connecting the Machine.....	2-4
Special Line Considerations .....	2-5
Roll Over Phone Lines .....	2-5
Two-Line Phone System.....	2-5
Converting Telephone Wall Outlets .....	2-6
Installing Brother Machine, External Two-Line TAD, and Two-Line Telephone.....	2-6
Multi-Line Connections (PBX) .....	2-7
If you are installing the FAX/MFC to work with a PBX: .....	2-7
Custom Features on Your Phone Line.....	2-7
Connecting an External Telephone Answering Device (TAD).....	2-8
Sequence .....	2-8
Connections.....	2-9
Outgoing Message (OGM) .....	2-9
Connecting an External Telephone .....	2-9

# 3

<b>On-Screen Programming.....</b>	<b>3-1</b>
User-Friendly Programming.....	3-1
Function Mode.....	3-1
Alternating Displays.....	3-1
Function Selection Table.....	3-2

# 4

<b>Initial Setup.....</b>	<b>4-1</b>
Getting Started.....	4-1
Setting Date and Time.....	4-1
Setting Station ID.....	4-1
Setting Tone/Pulse Dialing Mode (For Canada Only)....	4-2
Details for Entering Text.....	4-2
Inserting spaces.....	4-2
Making corrections.....	4-2
Repeating letters.....	4-3
Special characters and symbols.....	4-3
Setting Up Your Area Code (For USA Only).....	4-3
Setting Beeper Volume.....	4-4
Choosing the Handset Volume.....	4-4
Setting Volume Amplify.....	4-5
Setting the Speaker Volume.....	4-5
Setting the Ring Volume.....	4-5
Memory Storage.....	4-5

# 5

<b>Setup Receive.....</b>	<b>5-1</b>
Basic Receiving Operations.....	5-1
Select Answer Mode.....	5-1
To select or change your Answer Mode.....	5-2
Setting Ring Delay.....	5-2
Setting F/T Ring Time.....	5-3
Record FAX/TEL Outgoing Announcement (F/T OGM)...	5-3
Easy Receive.....	5-4
Printing a Reduced Incoming original.....	5-5
Recommended Reductions.....	5-5
Setting Paper Size.....	5-5
Advanced Receiving Operations.....	5-6
Operation from External or Extension Telephone.....	5-6
For FAX/TEL Mode Only.....	5-6
Changing Remote Codes.....	5-6

Polling.....	5-7
Setting Multi-function Link <sup>®</sup> Mode (For MFC 660MC Only).....	5-7

## 6

<b>Setup Send .....</b>	<b>6-1</b>
Automatic Document Feeder (ADF).....	6-1
Manual Transmission .....	6-2
Automatic Transmission.....	6-2
Manual and Automatic Fax Redial.....	6-2
Memory Transmission.....	6-2
Basic Sending Operations .....	6-3
Contrast.....	6-3
Resolution.....	6-3
Advanced Sending Operations .....	6-4
Overseas Mode .....	6-4
Delayed Fax.....	6-4
Setting Up for Polled Transmit.....	6-4
Canceling a Scheduled Job.....	6-5
Interrupting Delayed Fax and Polled Transmit Jobs .....	6-5
More Advanced Features (Call Brother fax-back system) ..	6-6

## 7

<b>Auto Dial Numbers and Dialing Options .....</b>	<b>7-1</b>
Storing Numbers for Easy Dialing .....	7-1
Storing One Touch Dial Numbers .....	7-1
Storing Speed Dial Numbers .....	7-2
Changing One Touch and Speed Dial Numbers.....	7-3
Setting Up Groups for Broadcasting .....	7-3
Dialing Options .....	7-4
Manual Dialing .....	7-4
One Touch Dialing .....	7-4
Speed Dialing .....	7-5
Dialing Access Codes and Credit Card Numbers.....	7-5
Search .....	7-6
Redial.....	7-6
Answering Calls with the Speakerphone.....	7-6
Broadcasting .....	7-6
Pause.....	7-7
Hold .....	7-7
Tone/Pulse (For Canada Only).....	7-7

<b>Telephone Services .....</b>	<b>8-1</b>
Custom Features .....	8-1
Distinctive Ring .....	8-1
Registering the Distinctive Ring Pattern.....	8-1
Caller ID .....	8-2
Caller ID Log .....	8-2
Printing the Caller ID Log .....	8-3
Viewing the Caller ID Log.....	8-3
Returning a Call from the Log .....	8-3
Registering a Caller ID Number .....	8-4
Clearing a Caller ID Stored in Memory.....	8-4
Call Waiting Caller ID.....	8-5
CallManage (For USA Only) .....	8-5
Registration with CallManage .....	8-5
Sending a Fax Using CallManage .....	8-6
Placing a Telephone Call Using CallManage.....	8-6
Customer Support .....	8-6

<b>Message Center.....</b>	<b>9-1</b>
Message Center Mode .....	9-1
Flexible Memory Settings (Message Storage).....	9-1
Setting Up the Message Center .....	9-2
Setting Message Storage.....	9-2
Recording Message Center Outgoing Message.....	9-2
Listening to Outgoing Message (OGM) .....	9-3
Erasing Outgoing Message (OGM) .....	9-3
Activating Message Center Mode .....	9-3
Message Indicator.....	9-3
Playing Voice Messages .....	9-4
Printing a Fax Message .....	9-4
Backup Printing Option.....	9-4
Erasing Messages .....	9-5
To erase voice messages individually .....	9-5
To erase messages all at once .....	9-5
Setting Maximum Time for Incoming Messages .....	9-5
Setting Toll Saver .....	9-6
ICM Recording Monitor .....	9-6
Recording a Conversation .....	9-6
Fax Forwarding/Paging .....	9-6
Programming a Fax Forwarding Number .....	9-7

Programming Paging Number .....	9-7
Remote Retrieval.....	9-8
Using Remote Access Code .....	9-8
Changing Remote Retrieval Access Code.....	9-8
Remote Commands .....	9-9
Retrieving Memory Status List .....	9-10
Retrieving Fax Messages.....	9-11
Changing Fax Forwarding Number.....	9-11

## 10

<b>Making Copies.....</b>	<b>10-1</b>
Copy Functions .....	10-1
Making a Single Copy .....	10-1
Copy Options: Single or Multiple Copies, Reduce/Enlarge, Sort/Stack.....	10-1

## 11

<b>Printing Reports.....</b>	<b>11-1</b>
FAX/MFC Settings and Activity.....	11-1
To Print a Report .....	11-1
Transmission Verification (Xmit) Report .....	11-2
Activity Report Interval.....	11-2

## 12

<b>Important Information.....</b>	<b>12-1</b>
Standard Telephone and FCC Notices .....	12-1
These notices are in effect on models sold and used in the United States only. ....	12-1
International Energy Star Compliance Statement.....	12-2
Industry Canada Compliance Statement (For Canada Only) .....	12-2
Federal Communications Commission Compliance Notice (For USA Only) .....	12-2
Important Safety Instructions.....	12-3

## 13

<b>Troubleshooting and Routine Maintenance .....</b>	<b>13-1</b>
Troubleshooting .....	13-1
Error Messages .....	13-1
If You Are Having Difficulty with Your FAX/MFC .....	13-4
Printing or Receiving Faxes .....	13-4
Phone Line or Connections .....	13-4
Sending Faxes .....	13-5
Handling Incoming Calls .....	13-6

Routine Maintenance.....	13-7
Cleaning the Scanner .....	13-7
Cleaning the Print Head.....	13-7
Replacing the Print Cartridge .....	13-8

## 14

### Setting Up the MFC 660MC

<b>and Computer to Work Together.....</b>	<b>14-1</b>
Before You Install Multi-Function Link® .....	14-1
Package Contents.....	14-1
PC Configuration Requirements.....	14-1
Connecting the MFC 660MC to Your PC .....	14-2
Choosing the Software to Install .....	14-3
Install Multi-Function Link® Software.....	14-3
On-Line Documentation .....	14-3
Product Support.....	14-3
Brother Web Link .....	14-3
Installing the Multi-Function Link® Software .....	14-4
Overview of Basic Steps .....	14-4
Installing the Brother Software .....	14-4
Viewing On-Line Documentation .....	14-6

## 15

### Using the Multi-Function Link® Software

<b>(For MFC 660MC Only) .....</b>	<b>15-1</b>
Introduction .....	15-1
Running the Brother Software.....	15-1
Multi-Function Link® .....	15-2
ScanSoft™ PaperPort® .....	15-2
Sending a Fax from Your PC .....	15-2
Sending a Quick Fax .....	15-2
Sending a Fax from the Main Menu .....	15-3
Sending a Fax from a Windows® Application .....	15-4
Receiving Faxes into the PC .....	15-5
Before You Begin.....	15-5
Checklist for the MFC: .....	15-5
On your PC: .....	15-6
Viewing Received Faxes .....	15-6
Scanning a Document.....	15-7
Scanning Options.....	15-7
Resolution .....	15-7
Contrast .....	15-8



Image Type ..... 15-8  
Scanning into the PaperPort® Viewer ..... 15-8

**16**

**Multi-Function Link® (option)**  
**(For FAX 580MC Only) ..... 16-1**

**Specifications ..... S-1**

**Index ..... I-1**

**Remote Retrieval Access Card..... R-1**

# 1 Introduction

## Using This Manual

---

Thank you for purchasing a Brother FAX/MFC. This FAX/MFC has been designed to be simple to use, with LCD screen prompts to guide you through functions. However, you can use your FAX/MFC to its fullest potential by taking a few minutes to read this manual.



Additionally, your FAX/MFC has a Help Key. Press **Copy/Help** and then press **Start** to print a list of basic operational steps and functions.

## Finding Information

All chapter headings and subheadings are listed in the Table of Contents. You will be able to find information about a specific feature or function by checking the Index at the back of this manual. Also, throughout this manual, you'll see special symbols alerting you to important information, cross-references, and warnings. Illustrations of some screen displays also help you choose the correct key-presses.

## About FAX/MFC

---

If you're a first-time FAX/MFC user, fax operation might seem a little mysterious. You'll soon get used to the unusual fax tones on your phone line, and be able to send and receive faxes easily.

## Fax Tones and Handshake

When someone is sending a fax, the FAX/MFC sends fax calling tones (CNG tones)—soft, intermittent beeps at 4-second intervals. You'll hear them when you dial and press **Start**, and they continue for about 40 seconds after dialing. During that time, the sending machine must begin the "handshake" with the receiving machine. Each time you use automatic procedures to send a fax, you are sending CNG tones over the phone line. You'll soon learn to listen for these soft beeps each time you answer a phone on your fax line, so you know if you are receiving a fax message.

The receiving fax responds with fax receiving tones—loud, chirping sounds. A receiving fax chirps for about 40 seconds over the phone line, and the screen displays **RECEIVE**. If your FAX/MFC is set to the **FAX ONLY Mode**, it will answer every call automatically with fax receiving tones. Even if the other party hangs up, your FAX/MFC continues to send the "chirps" for about 40 seconds, and the screen continues to display "RECEIVE". To cancel the receiving mode, press **Stop**.

When your FAX/MFC answers in **FAX/TEL Mode**, the FAX/MFC listens for CNG tones and then responds with receiving tones.

The fax "handshake" is the time in which the sending machine's CNG tones and the receiving machines "chirps" overlap. This must be for at least 2 to 4 seconds, so the machines can understand how each is sending and receiving the fax. The handshake cannot begin until the call is answered, and the CNG tones only last for about 40 seconds after the number is dialed. Therefore, it's important for the receiving machine to answer the call in as few rings as possible.



When you have an external telephone answering device (TAD) on your fax line, your TAD will determine the number of rings before the call is answered. Pay special attention to the directions in the **Installation** chapter for connecting a TAD to your FAX/MFC.

## ECM (Error Correction Mode)

The Error Correction Mode (ECM) is a way for the FAX/MFC to check the integrity of a fax transmission while it is in progress. ECM transmissions are possible only between machines that both have the ECM feature. If they do, you may send and receive fax messages that are continuously checked for their integrity.

Sufficient memory must be available in your FAX/MFC for this feature to work.

# FAX 580MC and MFC 660MC

## Control Panel Overview

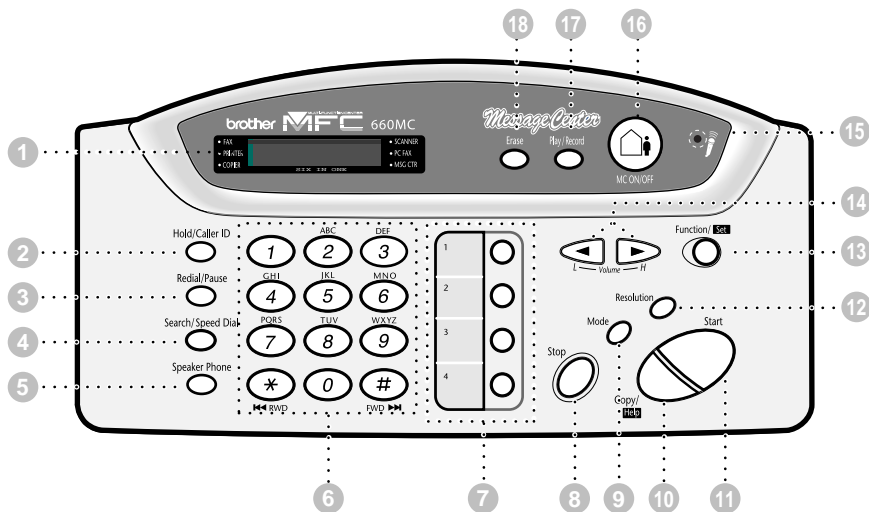

### 1 LCD (Liquid Crystal Display)

Displays messages to help you set up and operate your fax machine.

### 2 Hold/Caller ID

Lets you put calls on hold. Also, lets you view or print the Caller ID list.

### 3 Redial/Pause

Re-dials the last number called. Also inserts a pause in autodial numbers.

### 4 Search/Speed Dial

Lets you dial stored phone numbers by pressing # and a two-digit number. Also lets you look up numbers stored in the dialing memory.

### 5 Speaker Phone

Lets you speak to the person at the other end and dial telephone numbers without lifting the handset.

### 6 Dial Pad

Dials phone and fax numbers, and can be used as a keyboard for entering information into the fax machine.

### 7 One Touch Dial Keys

These four keys give you instant access to previously stored phone numbers.

### 8 Stop

Stops a fax, cancels an operation or exits from Function mode.

### 9 Mode

Use to select how fax machine will handle incoming calls.

### 10 Copy/Help

Makes a copy. If no originals are in the ADF, it prints a quick reference Help List.

### 11 Start

Starts an operation, such as sending a fax.

### 12 Resolution

Sets the resolution when you send a fax or make a copy.

### 13 Function/Set

Lets you access the function and programming mode. Also, stores a function setting into the fax machine.

### 14 ◀ (Left Arrow) ▶ (Right Arrow) Volume

Moves the LCD cursor to the left or right. Adjusts speaker, ring and handset volume.

### 15 Microphone

Picks up your voice when you speak to another party using speakerphone.

### 16 MC ON/OFF

Lets you activate the Message Center. Also, notifies you that you have voice or fax messages in the memory.

### 17 Play/Record

Lets you listen to voice messages and print fax messages stored in memory. Also, lets you record telephone calls.

### 18 Erase

Lets you delete voice messages, fax messages or all messages.

# 2

## Location and Connections

### Caution

---

- 1 Never install telephone wiring during a lightning storm.
- 2 We recommend that this product be used with a surge protection device to protect the product against lightning storms.
- 3 Never install a telephone jack in a wet location unless the jack is specifically designed for a wet location.
- 4 Never touch telephone wires or terminals that are not insulated unless the telephone line has been disconnected at the network interface.
- 5 Use caution when installing or modifying telephone lines.
- 6 Avoid using a telephone (other than a cordless type) during an electrical storm. There may be a remote risk of electric shock from lightning.
- 7 Do not use the telephone to report a gas leak in the vicinity of the leak.
- 8 For PLUGGABLE EQUIPMENT, the electrical outlet should be installed near the equipment and should be easily accessible.

### Choosing a Location

---

Place your FAX/MFC on a flat, stable surface, such as a desk. Select a place that is free of vibration and shocks. Locate the FAX/MFC near a telephone jack and a standard, grounded power outlet.

- ⊘ Avoid placing your machine in a high-traffic area. Do not place near heaters, air conditioners, water, chemicals or refrigerators. Do not expose the FAX/MFC to direct sunlight, excessive heat, moisture or dust. Do not connect your machine to electrical outlets controlled by wall switches or automatic timers. Disruption of power can wipe out information in the unit's memory. Do not connect your machine to electrical outlets on the same circuit as large appliances or other equipment that might disrupt the power supply. Avoid interference sources, such as speakers or the base units of cordless phones.

# Packing List

Make sure you have the following items:

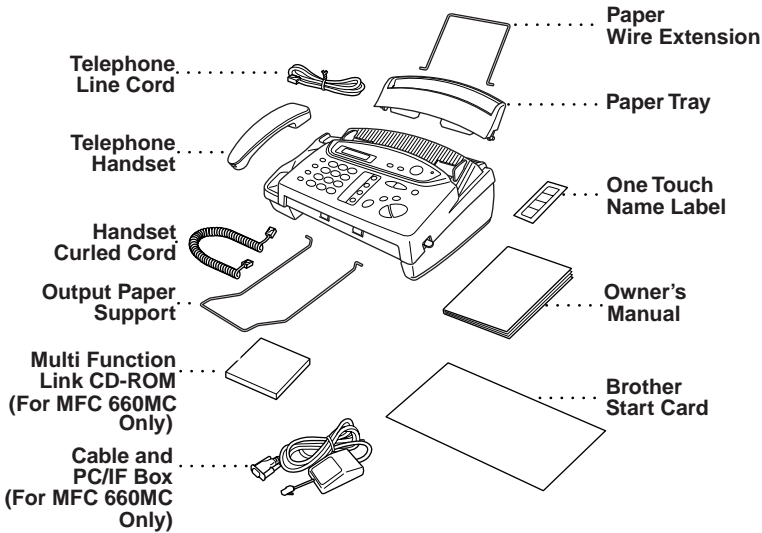

If an item is missing, call Brother Customer Service at 1-800-284-4329 (USA), 1-800-853-6660 (from within Canada) or 1-514-685-6464 (from within Montreal). See Ordering Accessories and Supplies on page ii for the correct item numbers.



Whenever you transport the FAX/MFC, use the packing materials that came with your machine. If you do not pack the FAX/MFC correctly, you may void your warranty.

# Assembly

## Attach the paper wire extension

Attach the paper wire extension to the paper tray and slide it up or down to fit letter or legal size paper.

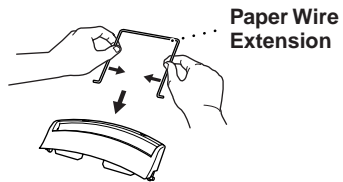

## Attach the paper tray

Attach the paper tray. Make sure the wide pins on the paper tray are inserted firmly into the pockets on the top edge of the machine.

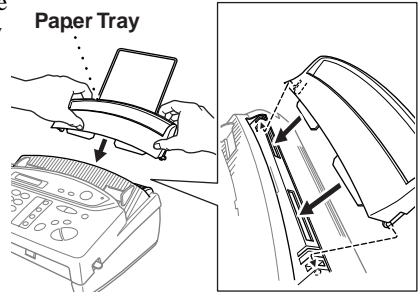

## Attach the output paper support

Attach the output paper support.

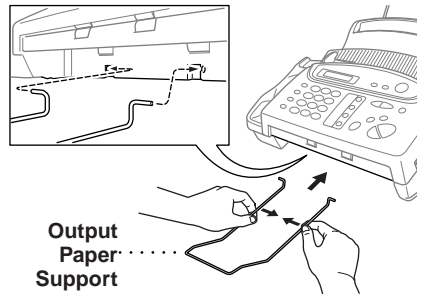

## Loading the Paper

The maximum number of 20 lb. sheets you can load depends on the paper size, either 50 Letter or 30 Legal.

Temperature: 68°F (20°C)

Humidity: 60%

- 1 Place paper in the paper tray.

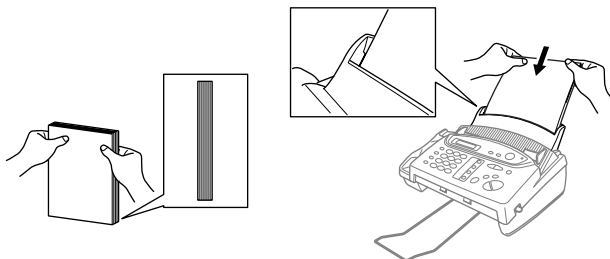

**Tap the stack of paper  
so the edges are even.**

## Acceptable Paper

- Size:** Letter and Legal  
**Weight:** 17 lb. – 24 lb.  
**Thickness:** .0031 inches – .0039 inches

⊘ **DO NOT** use curled, wrinkled, folded or ripped paper, or paper with staples, paper clips, paste or tape attached. **DO NOT** use cardboard, newspaper or fabric.

## Connections

---

### Connecting the Machine

Connect the handset, power cord, and telephone line.

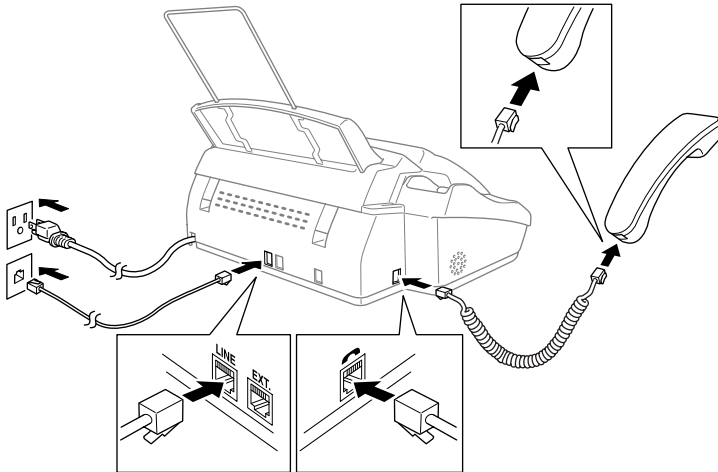

#### 1 Connect the Handset.

Connect the curled handset cord to the bottom of the handset and the back of the machine.

#### 2 Connect the power cord.

#### 3 Connect the telephone line.

Connect one end of the telephone line cord to the jack labeled **LINE** on the back of the machine. Connect the other end to a modular wall jack.





## **WARNING**

- This machine must be grounded using a three-prong plug.
- Since the machine is grounded through the power outlet, you can protect yourself from potentially hazardous electrical conditions on the telephone line by keeping the power to your machine on when you connect it to a telephone line. When you want to move your machine, protect yourself by disconnecting the telephone line first, and then the power cord.
- Lightning and power surges can damage this product! We recommend that you use a quality surge protection device on the AC power line as well as on the telephone line, or unplug the lines during a lightning storm.

## **Special Line Considerations**

### **Roll Over Phone Lines**

A roll over phone system is a group of two or more separate telephone lines that pass incoming calls to each other if they are busy. The calls are usually passed down or “rolled over” to the next available phone line in a preset order.

Your FAX/MFC can work in a roll over system as long as it is the last number in the sequence, so the call cannot roll away. Do not put the FAX/MFC on any of the other numbers; when the other lines are busy and a second fax call is received, the fax call is transferred to a line that does not have a fax machine. Your FAX/MFC will work best on a dedicated line.

### **Two-Line Phone System**

A two-line phone system is nothing more than two separate phone numbers on the same wall outlet. The two phone numbers can be on separate jacks (RJ11) or combined into one jack (RJ14). Your machine must be plugged into an RJ11 jack. RJ11 and RJ14 jacks may be equal in size and appearance and both may contain four wires (black, red, green, yellow). To test the type of jack, plug in a two-line phone and see if it can access both lines. If it can, you must separate the line for your machine.

## Converting Telephone Wall Outlets

There are three ways to convert to an RJ11 receptacle. The first two ways may require assistance from the telephone company. You can change the wall outlets from one RJ14 jack to two RJ11 jacks. Or, you can have an RJ11 wall outlet installed and slave or jump one of the phone numbers to it.

The third way is the easiest: Buy a triplex adapter. You can plug a triplex adapter into an RJ14 outlet. It separates the wires into two separate RJ11 jacks (Line 1, Line 2) and a third RJ14 jack (Lines 1 and 2). If your Brother machine is on Line 1, plug the machine into L1 of the triplex adapter. If your machine is on Line 2, plug it into L2 of the triplex adapter.

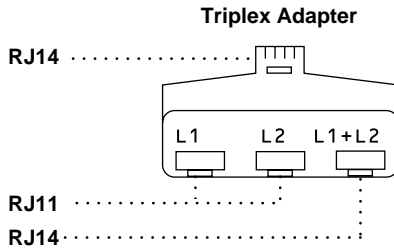

## Installing Brother Machine, External Two-Line TAD, and Two-Line Telephone

When you are installing an **external** two-line telephone answering device (TAD) and a two-line telephone, your machine must be isolated on one line at both the wall jack and at the TAD. *The most common connection is to put the Brother machine on Line 2, which is our assumption in the following steps.* The back of the two-line TAD must have two telephone jacks: one labeled L1 or L1/L2, and the other labeled L2. You will need at least three telephone line cords, the one that came with your machine and two for your external two-line TAD. You will need a fourth line cord if you add a two-line telephone.

- 1 Place the two-line TAD and two-line telephone next to your Brother machine.
- 2 Plug one end of the telephone line cord for your machine into the L2 jack of the triplex adapter. Plug the other end into the **LINE** jack on the back of the machine.
- 3 Plug one end of the first telephone line cord for your TAD into the L1 jack of the triplex adapter. Plug the other end into the L1 or L1/L2 jack of the two-line TAD.

- 4 Plug one end of the second telephone line cord for your TAD into the L2 jack of the two-line TAD. Plug the other end into the **EXT.** jack on the back of the machine.

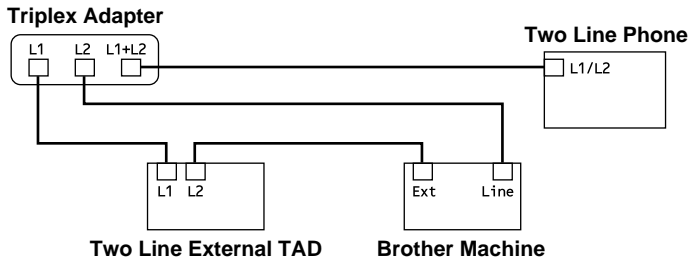

You can keep two-line telephones on other wall outlets as always. There are two ways to add a two-line telephone to the FAX/MFC's wall outlet. You can plug the telephone line cord from the two-line telephone into the L1+L2 jack of the triplex adapter. Or, you can plug the two-line telephone into the TEL jack of the two-line TAD.

## Multi-Line Connections (PBX)

Most offices use a central telephone system. While it is often relatively simple to connect the FAX/MFC to a key system or a PBX (Private Branch Exchange), we suggest that you contact the company that installed your telephone system and ask them to connect the FAX/MFC for you. It is advisable to have a separate line for the FAX/MFC. You can then leave the FAX/MFC in FAX ONLY Mode to receive faxes any time, day or night.

If the FAX/MFC is to be connected to a multi-line system, ask your installer to connect the unit to the last line on the system. This prevents the unit from being activated each time a telephone call is received. (See *Easy Receive*, page 5-4.)

- ⊘ As with all fax units, this machine must be connected to a two wire system. If your line has more than two wires, proper connection of the FAX/MFC cannot be made.

### If you are installing the FAX/MFC to work with a PBX:

- 1 It is not guaranteed that the unit will operate correctly under all circumstances with a PBX. Any cases of difficulty should be reported first to the company that handles your PBX.
- 2 If all incoming calls will be answered by a switchboard operator, it is recommended that the Answer Mode be set to MANUAL. All incoming calls should initially be regarded as telephone calls.
- 3 The unit may be used with either pulse or tone dialing telephone service.

## Custom Features on Your Phone Line

To learn how custom features may affect your faxing operations, please see *Troubleshooting and Routine Maintenance*, Chapter 13.

# Connecting an External Telephone Answering Device (TAD)

## Sequence

You might choose to connect an additional answering system. When you have an external TAD on the same telephone line as the FAX/MFC, the TAD answers all calls. The FAX/MFC “listens” for fax calling (CNG) tones. If it hears them, the FAX/MFC takes over the call and receives the fax. If it doesn’t hear CNG tones, the FAX/MFC lets the TAD continue playing your outgoing message so your caller can leave you a voice message.

The TAD must answer within four rings (the recommended setting is two rings). The FAX/MFC cannot hear CNG tones until the TAD has answered the call, and with four rings there are only 8–10 seconds of CNG tones left for the fax “handshake.” Make sure you carefully follow instructions in this manual for recording your outgoing message. We do not recommend using the toll saver feature on your external answering machine if it exceeds 4 rings.

- ⊘ Do not connect a TAD elsewhere on the same phone line—your FAX/MFC and TAD will both try to control the line.

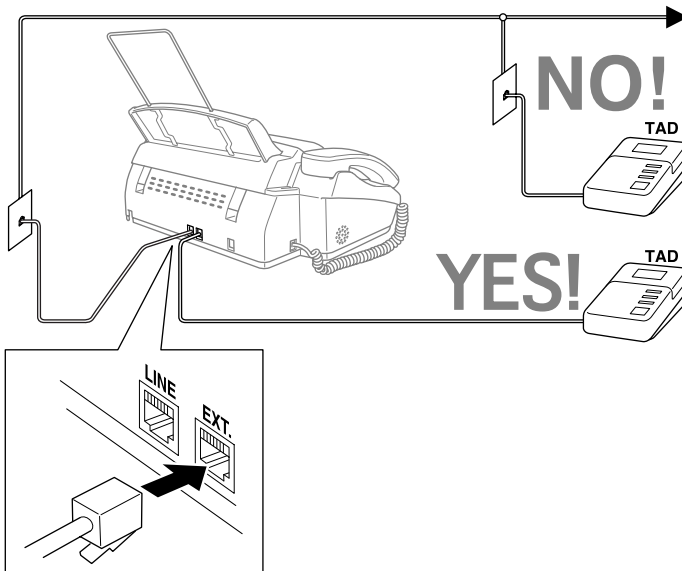

## Connections

The external TAD must be plugged into the back of the FAX/MFC, into the jack labeled EXT. Your FAX/MFC cannot work properly if you plug the TAD into a wall jack.

- 1** Plug the telephone line cord from the wall jack into the back of the FAX/MFC, in the jack labeled LINE.
- 2** Plug the telephone line cord from your TAD into the back of the FAX/MFC, in the jack labeled EXT. (Make sure this cord is connected to the TAD at the TAD's telephone line jack (not to telephone set jack).)
- 3** Set your external TAD to four rings or less. (The FAX/MFC's Ring Delay setting does not apply.)
- 4** Record the outgoing message (see below).
- 5** Set the TAD to answer calls.
- 6** See Message Storage (**Function/Set, 8, 1**) to VOICE:EXT.
- 7** Set the Answer Mode to MC:MSG CTR.

## Outgoing Message (OGM)

Timing is important in recording this message. The message sets up the ways to handle both manual and automatic fax reception.

- 1** Record 5 seconds of silence at the beginning of your message. (This allows your FAX/MFC time to listen for the fax CNG tones of automatic transmissions before they stop.)
- 2** Limit your speaking to 20 seconds.
- 3** End your 20-second message by giving your Fax Receive Code for people sending manual faxes. For example:  
"After the beep, leave a message or send a fax by pressing ✖ 5 1 and Start."

## Connecting an External Telephone

Your FAX/MFC is equipped with a handset that you can use as a regular phone. However, you can also connect a separate telephone (or telephone answering device) directly to your FAX/MFC.

Connect the modular plug on the telephone's line cord to the jack labeled EXT. on the back of the FAX/MFC.

Whenever this phone (or TAD) is in use, the screen displays EXT. TEL IN USE, and, if the FAX/MFC handset is lifted, an alarm sounds. To disconnect the call and switch to the FAX/MFC, press **Speaker Phone**.

# 3 On-Screen Programming

## User-Friendly Programming



---

We have designed your FAX/MFC with on-screen programming and a Help key. User-friendly programming helps you take full advantage of all the functions your FAX/MFC has to offer. (See *Using This Manual*, page 1-1.)

Since your fax programming is done on the LCD, we created step-by-step on-screen prompts to help you program your FAX/MFC. All you need to do is follow the prompts as they guide you through the function menu selections and programming options and settings.

### Function Mode

You can access the function mode by pressing **Function/Set**. When you enter the function mode, your FAX/MFC displays a list of main menu options from which you can choose. These options appear one after the other on the display. Select an option by pressing **Function/Set** when the option appears on the screen.

You can “scroll” more quickly through options by pressing . When the screen displays your selection, press **Function/Set**. (Press  to scroll backward if you passed your choice or to save key strokes. Both arrow keys show all options, in the opposite order.)

Before you press **Function/Set** after entering information in a field using the dial pad, you can correct a mistake. Use  to back up and then type over the incorrect characters.



When you finish a function, the screen displays ACCEPTED.  
If you want to exit the Function mode, press **Stop**.

### Alternating Displays

When you see alternating displays, the LCD sometimes alternates between the currently selected option, and a help message giving brief instructions about how to proceed. The display you’ll probably see most often is shown below, showing you, when you place an original in the ADF, that you can dial a number and send a fax, or you can make a copy.



## Function Selection Table

If you have a basic understanding of how to program your FAX/MFC, you can perform most of the programming settings without the Owner's Manual. To help you understand the function selections, options, and settings that are found in your fax programs, use the Function Selection Table below.

1. INITIAL SETUP			
Function	Description	Factory Set	More Info
<b>1. DATE/TIME</b>	Enter date and time for LCD display and to print on transmissions.	—	4-1
<b>2. STATION ID</b>	Program name, fax number and telephone number to appear on each transmitted page.	—	4-1
<b>3. BEEPER</b>	Adjust volume level of beeper.	LOW	4-4
<b>4. VOLUME AMPLIFY</b>	For the hearing-impaired, you can set the volume to the VOL AMPLIFY:ON setting on a permanent or temporary basis.	OFF	4-5
<b>5. TONE/PULSE</b> (For Canada Only)	Selects dialing mode.	TONE	4-2
<b>6. LOCAL LANGUAGE</b> (For Canada Only)	Allows you to change the LCD Language to French.	ENGLISH	See French manual

## 2. SETUP RECEIVE

Function	Description	Factory Set	More Info
<b>1. RING DELAY</b>	Number of rings before FAX/MFC answers in FAX/TEL, FAX, or MC mode.	RING DELAY:04 TOLL SAVER:OFF	5-2
<b>2. F/T RING TIME</b>	Sets the time for “double ring” in FAX/TEL mode.	20	5-3
<b>3. EASY RECEIVE</b>	Receive fax messages without pressing the Start key.	ON	5-4
<b>4. REMOTE CODE</b>	Enter code to activate or deactivate machine from a remote location.	ON ( * 51, #51)	5-6
<b>5. REDUCTION</b>	Reduces size of image.	AUTO	5-5
<b>6. PAPER</b>	Selects size of paper for fax receiving.	LETTER	5-5
<b>7. POLLING RX</b>	Sets up your FAX/MFC to poll another fax machine.	OFF	5-7
<b>8. MF LINK</b> (For MFC 660MC Only)	Fax Receive Only/PC Primary/PC Receive Only.	PC Primary	5-7

## 3. SETUP SEND

Function	Description	Factory Set	More Info
<b>1. COVERPG SETUP</b>	Automatically sends a cover page you program.	OFF	6-6
<b>2. COVERPAGE MSG</b>	Program customized message for fax cover page.	—	6-6
<b>3. CONTRAST</b>	Change lightness or darkness of a fax you are sending.	AUTO	6-3
<b>4. RESOLUTION</b>	Allows you to change resolutions page by page.	STANDARD	6-6
<b>5. OVERSEAS MODE</b>	Adjusts for sometimes difficult overseas transmissions	OFF	6-4
<b>6. CALL RESERVE</b>	You can send a fax, then speak.	OFF	6-6
<b>7. DELAYED FAX</b>	Send originals later.	—	6-4
<b>8. POLLED TX</b>	Sets up your FAX/MFC with an original to be retrieved by another fax machine.	OFF	6-4
<b>9. MEMORY TX</b>	You can send faxes from memory.	OFF	6-2



4. CANCEL JOB			
Function	Description	Factory Set	More Info
	Cancel a delayed fax or polling job.		6-5

5. INTERRUPT			
Function	Description	Factory Set	More Info
	Send a fax now, even if you have the machine set to send a fax later, or if you have it set for Polling.		6-5

6. SET AUTO DIAL			
Function	Description	Factory Set	More Info
<b>1. ONE-TOUCH DIAL</b>	Dial numbers stored in memory by pressing only one key.	—	7-1
<b>2. SPEED-DIAL</b>	Dial numbers stored in memory by pressing only four keys.	—	7-2
<b>3. SETUP GROUPS</b>	Set up a Group number for broadcasting.	—	7-3

7. PRINT REPORTS			
Function	Description	Factory Set	More Info
<b>1. XMIT REPORT</b>	Print lists and reports of activity. (Details in Chapter 11)	OFF	11-1
<b>2. ACT.REPORT</b>		INTERVAL: OFF	11-1
<b>3. AUTO DIAL</b>		—	11-1
<b>4. TEL. INDEX</b>		—	11-1
<b>5. USER SETTINGS</b>		—	11-1
<b>6. MEMORY STATUS</b>		—	11-1

## 8. SETUP MSG CTR

Function	Description	Factory Set	More Info
<b>1. MSG STORAGE</b>	Select if memory will store fax, voice or both.	FAX:OFF VOICE:ON	9-2
<b>2. BACKUP PRINT</b>	Prints copy of faxes received into memory.	ON	9-4
<b>3. OGM</b>	Select/Record outgoing message.	MSG CTR OGM	5-3, 9-2, 9-3
<b>4. ICM MAX. TIME</b>	Select maximum length of incoming messages.	30 seconds	9-5
<b>5. ICM REC. MONITR</b>	Adjust speaker volume for voice messages as they come in.	ON	9-6
<b>6. FAX FWD/PAGING</b>	Set FAX/MFC to forward fax/ message— <b>OR</b> —to call your pager.	OFF	9-7
<b>7. REMOTE ACCESS</b>	Set code for retrieving messages.	159✳	9-9

## 0. TEL SERVICE

Function	Description	Factory Set	More Info
<b>1. DISTINCTIVE</b>	Use with phone company Distinctive Ring service to register the ring pattern with FAX/MFC.	OFF	8-1
<b>2. CALLER ID</b> (For USA only)	Register your AREA CODE to dial from the Caller ID Log.	—	4-3

# 4 Initial Setup

## Getting Started

---

After you have assembled your machine using the Brother StartCard, continue the initial setup by programming the rest of the initial settings.

### Setting Date and Time

Your FAX/MFC displays the date and time, and prints it on every fax you send.

In the event of a power failure, the FAX/MFC maintains date and time information for up to two hours. All other settings remain unaffected.

- 1 Press **Function/Set, 1, 1.**
- 2 Enter the last two digits of the year and press **Function/Set.**
- 3 Enter two digits for the month and press **Function/Set.** (For example, enter 09 for September, or 10 for October)
- 4 Enter two digits for the day and press **Function/Set.** (For example, 06)
- 5 Enter the time in 24-hour format and press **Function/Set.** (For example, enter 15:25 for 3:25 PM)
- 6 Press **Stop.** The screen now displays the date and time you set, and displays it whenever the FAX/MFC is in Standby mode.

### Setting Station ID

You can store your name, fax number, and telephone number to be printed on all fax pages.



- 1 Press **Function/Set, 1, 2.**
- 2 Enter your fax number (up to 20 digits) and press **Function/Set.**
- 3 Enter your telephone number (up to 20 digits) and press **Function/Set.** If your telephone number and fax number are the same, enter the same number again. The screen displays your entry.
- 4 Use the dial pad to enter your name (up to 20 characters) and press **Function/Set.** (You can use the chart on next page to help you enter letters.)
- 5 Press **Stop.** The screen returns to the date and time.

## Setting Tone/Pulse Dialing Mode (For Canada Only)

Your FAX/MFC comes set to accommodate tone (multi-frequency) dialing service. If you have pulse (rotary) dialing service, you need to change the dialing mode.

- 1** Press **Function/Set, 1, 5.**

DIALING:TONE?

- 2** Press  or  to select TONE or PULSE and press **Function/Set.**

DIALING:PULSE?

- 3** Press **Stop** to exit.

## Details for Entering Text

When you are setting certain functions, such as the Station ID, you may need to enter text into the FAX/MFC. Most keys on the dial pad have three or four letters printed above them. The keys for 0, # and \* don't have printed letters because they are used for special characters or operations.

By pressing the appropriate number on the dial pad the correct number of times, you can access the character you want.

Press Key	one time	two times	three times	four times
<b>2</b>	A	B	C	2
<b>3</b>	D	E	F	3
<b>4</b>	G	H	I	4
<b>5</b>	J	K	L	5
<b>6</b>	M	N	O	6
<b>7</b>	P	Q	R	S
<b>8</b>	T	U	V	8
<b>9</b>	W	X	Y	Z

## Inserting spaces

If you want to enter a blank space, press  twice.

## Making corrections

If you entered a letter incorrectly and want to change it, press  to move the cursor after the last correct letter. Then press **Stop**; the letters above and to the right of the cursor are deleted. Re-enter the correct text and/or digits. You can also back up and type over incorrect letters.

## Repeating letters

If you need to enter a character assigned to the same key as the previous character, press  to move the cursor to the right.

## Special characters and symbols

Press \*, # or Ø repeatedly to move the cursor under the special character or symbol you want, then press  to select it.

Press \* for (space) ! “ # \$ % & ’ ( ) \* + , - . /

Press # for : ; < = > ? @ [ ] ^ \_

Press Ø for É À È Ê Î Ç Ë Ö 0

## NOTICE

The Telephone Consumer Protection Act of 1991 makes it unlawful for any person to use a computer or electronic device to send any message via a telephone fax machine unless such messages clearly contain, in a margin at the top or bottom of each transmitted page, or on the first page of the transmission, the date and time it is sent and an identification of the business or other entity or other individual sending the message and the telephone number of the sending machines or such business, other entity or individual.

In order to program this information into your FAX/MFC, you should complete the steps described on page 4-1.



- The telephone number you enter is used only for Call Back Message and Cover Page features.
- If you do not enter a fax number, no additional information can be entered.
- To enter a space, press  once between numbers and twice between characters.
- If your Station ID has already been programmed, the screen prompts “1” to make a change, or “2” to exit without changing.

## Setting Up Your Area Code (For USA Only)

You must set up your area code in Caller ID.

**1** Press **Function/Set, 0, 2**.

AREA CODE:000

**2** Use the dial pad to enter your area code and press **Function/Set**.

AREA CODE:908

**3** Press **Stop** to exit.

## Setting Beeper Volume

You can set the beeper to LOW, HIGH or OFF. The default setting is **LOW**. When the beeper is set to LOW or HIGH, the FAX/MFC beeps every time you press a key or make an error, and at the end of fax sending or receiving.

- 1 Press **Function/Set**, **1**, **3**.
- 2 Press  $L \langle \rangle$  or  $\triangleright H$  to select your setting and press **Function/Set**.
- 3 Press **Stop** to exit.

## Choosing the Handset Volume

Before you begin to use the FAX/MFC, you must decide if you need to set the handset volume to AMPLIFY:ON for a user who is hearing-impaired. The AMPLIFY volume level complies with FCC standards.

VOLUME AMPLIFY: OFF

This default setting is appropriate if none of the users are hearing-impaired. During a conversation, users can press  $L \langle \rangle$  or  $\triangleright H$  on the control panel to adjust the volume. When the handset is replaced, the handset volume remain until you change it again.

VOLUME AMPLIFY: ON-TEMPORARY

This setting is appropriate if some of the users are hearing-impaired. During a conversation, users can press  $L \langle \rangle$  or  $\triangleright H$  on the control panel to adjust the volume to LOW, HIGH or AMPLIFY. When the handset is replaced, the handset volume will return to the default setting of LOW.

VOL AMPLIFY:ON-PERMANENT

Choose VOL AMPLIFY:ON-PERMANENT if all of the users are hearing-impaired. During a conversation, users can press  $L \langle \rangle$  or  $\triangleright H$  on the control panel to adjust the volume to LOW, HIGH or AMPLIFY. When the handset is replaced, the handset volume returns to the default setting of AMPLIFY.



When you press  $L \langle \rangle$  or  $\triangleright H$  on the control panel to adjust the volume, the display shows the setting you are choosing. Each key press changes the volume to the next setting.

### **WARNING**

**It is important that you do not choose PERMANENT unless all users are hearing-impaired.** Otherwise, the default setting of AMPLIFY may damage the hearing of some users.

## Setting Volume Amplify

Please carefully read “Setting the Handset Volume” before you do the following steps:

- 1 Press **Function/Set, 1, 4.**
- 2 Press  $L \leftarrow$  or  $\rightarrow H$  to select **VOL AMPLIFY:OFF?** if none of the users are hearing-impaired and go to Step 4—**OR**—If some or all of the users are hearing-impaired, select **VOL AMPLIFY:ON?**
- 3 Press  $L \leftarrow$  or  $\rightarrow H$  to select **PERMANENT?** if all the users are hearing-impaired—**OR**—Select **TEMPORARY?** if only some of the users are hearing-impaired.
- 4 Press **Function/Set.**
- 5 Press **Stop** to exit.

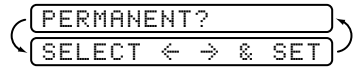

## Setting the Speaker Volume

You can adjust the speaker volume when your FAX/MFC is onhook (after you pressed **Speaker Phone**), by selecting a speaker volume level.

Press  $L \leftarrow$  or  $\rightarrow H$  to adjust the volume level. The display shows the setting you are choosing. Each key press changes the volume to the next setting. The new setting will remain until you change it again.



You can adjust the speaker volume while you are listening to your OGM(Outgoing Message) and ICMs (incoming messages).



If you turn Incoming Recording Monitor to OFF (**Function/Set, 8, 5**), the Speaker for screening calls will be disabled and you won't hear callers leaving messages. The volume for other operations can still be controlled using  $L \leftarrow$  and  $\rightarrow H$ .

## Setting the Ring Volume

You can adjust the ring volume when your FAX/MFC is idle. You can select a ring volume level or press until the ring is off.

Press  $L \leftarrow$  or  $\rightarrow H$  to adjust the volume level. With each key press, the FAX/MFC rings so you can hear the current setting and the display shows the setting you are choosing. Each key press changes the volume to the next setting. The new setting will remain until you change it again.

## Memory Storage

In the event of a power failure, all settings in the INITIAL SETUP, SETUP RECEIVE, SET AUTO DIAL and SETUP MSG CTR plus the COVERPG SETUP and COVERPAGE MSG (from SETUP SEND) functions are stored permanently. You may have to reset the date and time.

# 5 Setup Receive

## Basic Receiving Operations

### Select Answer Mode

**MANUAL**—You must answer all calls yourself. If you hear fax tones, press **Start** to begin receiving the fax, then hang up. You can use this mode with Distinctive Ringing. (See *Distinctive Ring*, page 8-1.)

**FAX ONLY**—The FAX/MFC automatically answers every call as a fax call. You cannot receive a voice call, but you can dial out and make a voice call.

**FAX/TEL**—The FAX/MFC automatically answers every call. If the call is a fax, it prints the fax. If the call is not a fax, it signals you with a double ring (ring-ring), different from the phone company ringing, to alert you to pick up the call. If you select this setting, you'll need to set the Ring Delay and F/T Ring Time features (on the following pages). If you have extension phones on the same line as the FAX/MFC, set Ring Delay to 4. (See *For FAX/TEL Mode Only*, page 5-6.)

**MSG CTR**—The FAX/MFC provides you with a built-in digital Message Center for fax and voice. When you set the machine to answer calls, it will record up to 15 minutes of messages. For more information about Message Center (MSG CTR) operation, please see Chapter 9.

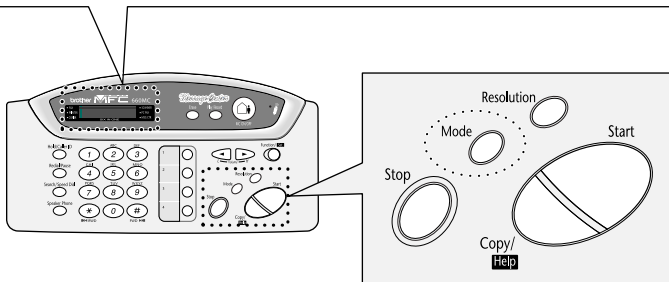
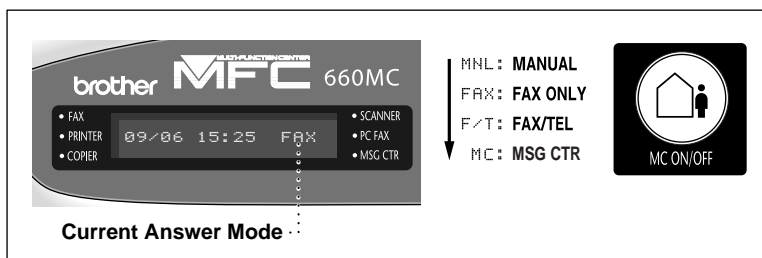



## To select or change your Answer Mode

- 1 Press **Mode**. The screen displays your current selection.

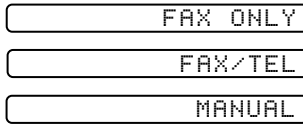





Or, if Message Center Mode is ON, it overrides your Answer Mode Setting, so the display shows:



- 2 Continue to press **Mode** until your new selection appears. After 2 seconds, the screen returns to the date and time display, along with your new Answer Mode setting.
-  If you're changing Answer Mode while in another operation, the screen returns to the current operation display.



## Setting Ring Delay

The Ring Delay setting determines the number of times the FAX/MFC rings before it answers. If you have extension phones on the same line as the FAX/MFC, keep the Ring Delay default setting of **4**. (See *Easy Receive*, page 5-4 and *Operation from External or Extension Telephone*, page 5-6 and *For FAX/TEL Mode Only*, page 5-6.)

- 1 Press **Function/Set, 2, 1**.
- 2 Press  or  to select Ring Delay and press **Function/Set**.
- 3 Press  or  to select how many times the line rings before the FAX/MFC answers (00 – 04) and press **Function/Set**. If you select 00, the line doesn't ring at all.
- 4 Press **Stop** to exit.

## Setting F/T Ring Time

You need to determine how long the FAX/MFC will notify you with its special double ring when you have a voice call. It will ring happens after the initial ringing from the phone company. Only the FAX/MFC rings for 20, 30, 40 or 70 seconds; no other phones on the same line ring the special double ring. However, you can answer the call on any phone on the same line as the FAX/MFC.

- 1 Press **Function/Set, 2, 2.**
- 2 Press  or  to select how long the FAX/MFC will ring to alert you that you have a voice call and press **Function/Set.**
- 3 Press **Stop** to exit.

RING TIME:20 SEC

Now, when a call comes in and the machine is set to FAX/TEL Mode, all phones on this line will ring the number of times you selected in Ring Delay.





You can let the FAX/MFC pick up and detect if it's a fax or voice call. If it's a fax call, the machine prints the fax. If it's a voice call, the machine signals you with a double ring for the length of time you selected in F/T Ring Time.



Even if the caller hangs up during the double ringing, the FAX/MFC continues for the set time.

## Record FAX/TEL Outgoing Announcement (F/T OGM)

This is the announcement played by your FAX/MFC (not an external TAD) when someone calls and your machine is set to FAX/TEL mode. *Although callers hear your announcement, they cannot leave a message.* To erase the announcement, follow the directions on *Erasing Outgoing Message (OGM)*, page 9-3.

- 1 Press **Function/Set, 8, 3.** The screen prompts you to choose F/T OGM or MSG CTR OGM.
- 2 Press  or  to select F/T OGM (not MSG CTR OGM) and press **Function/Set.**
- 3 Press  or  to select RECORD OGM? and press **Function/Set.**  
Then pick up the handset to record a message.
- 4 Replace the handset. Your OGM is played.
- 5 Press **Stop** to exit.

## Easy Receive



When you use this feature, you don't have to press **Start** when you answer a fax call and hear calling beeps. Just hold the handset and wait a few seconds. When you see **RECEIVE** on the fax screen or when you hear "chirps" through the handset of an extension phone connected to another wall jack, just replace the handset, and your machine does the rest. Selecting **ON** allows the FAX/MFC to receive fax calls automatically, even if you lift the handset of an extension or external phone. Selecting **SEMI** lets the machine receive the call only if you've answered it at the FAX/MFC. Selecting **OFF** means you'll have to activate the FAX/MFC yourself, by pressing **Start** or by pressing **\* 5 1** if you are not at your machine. (See *Operation from External or Extension Telephone*, and *For FAX/TEL Mode Only*, page 5-6.)

If you've set the feature to **ON**, but your FAX/MFC doesn't automatically connect a fax call when you lift an external or extension phone handset, press the Fax Receive code **\* 5 1**. At the FAX/MFC, lift the handset and press **Start**.

- 1** Press **Function/Set, 2, 3**.
- 2** Press **<** or **>** to select **ON, SEMI** or **OFF** and press **Function/Set**.
- 3** Press **Stop** to exit.

## Printing a Reduced Incoming original

You can always reduce the size of an incoming fax to a fixed percentage, regardless of the size of the paper (up to legal) in your FAX/MFC. If you choose AUTO, your machine chooses the level of reduction for you.

- 1 Press **Function/Set, 2, 5.** 
- 2 Press  or  to select the reduction ratio you want (AUTO, 93%, 87% or 75%) and press **Function/Set**. Choose 100% if you don't want a reduction.
- 3 Press **Stop** to exit.

### Recommended Reductions







If your paper is letter size (8.5" x 11"), and the incoming fax is  
letter size, select 93%  
A4, select 87%  
legal size, select 75%.

If your paper is A4 (8.2" x 11.6"), and the incoming fax is  
letter size, select 100%  
A4, select 93%

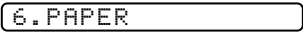
If your paper is legal size (8.5" x 14"), and the incoming fax is  
letter size, select 100%  
A4, select 100%  
legal size, select 93%.

### Setting Paper Size

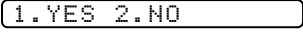
You can use three sizes of paper for printing your faxes—letter, legal and A4. When you change the kind of paper you have loaded in the FAX/MFC, you will need to change the setting for paper size, so your machine will know how to fit the incoming fax on the page. You can also select the level of page reduction to fit on the paper in your machine.

- 1 Press **Function/Set, 2, 6.** 
- 2 Press  or  to select LETTER, LEGAL or A4 and press **Function/Set**.  
- 3 Press **1** if you want to change the reduction setting—**OR**—Press **2** to go to Step 5.
- 4 Press  or  to select **AUTO, 100%, 93%, 87%** or **75%** and press **Function/Set**.
- 5 Press **Stop** to exit.

# Advanced Receiving Operations

## Operation from External or Extension Telephone

If you answer a fax call on an extension phone or on an external phone in the EXT. jack, you can make your FAX/MFC take over by using the Fax Receive Code. When you press the Fax Receive Code **\* 5 1**, the FAX/MFC starts to receive a fax. (See *Easy Receive*, page 5-4.)

If the FAX/MFC answers a voice call and double-rings for you to take over, use the Telephone Answer Code **# 5 1** to take the call at an extension phone. (See *Setting F/T Ring Time*, page 5-3.)

If you answer a call, and no one is on the line, assume you're receiving a fax. At the FAX/MFC phone, press **Start**, then hang up. At an extension phone, press **\* 5 1**, wait for fax receiving tones (chirps), then hang up. At an external phone, press **\* 5 1** and wait for the phone to be disconnected (the screen displays RECEIVE) before you hang up. (Your caller will have to press **Start** to send the fax.)

## For FAX/TEL Mode Only

When the FAX/MFC is in FAX/TEL mode, it will use the F/T Ring Time (double ringing) to alert you to a voice call. If you're at the FAX/MFC, you can lift the handset to answer.

If you're at an extension phone, you'll need to lift the handset during the F/T Ring Time and press **# 5 1** between the double rings. If no one is on the line, or if someone wants to send you a fax, send the call back to the FAX/MFC by pressing **\* 5 1**.



## Changing Remote Codes

Remote Codes might not work with some telephone systems. The preset Fax Receive Code is **\* 5 1**. The preset Telephone Answer Code is **# 5 1**.



If you are always disconnected when accessing your external TAD remotely, try changing the Fax Receive Code from **\* 5 1** to **###** and the Telephone Answer Code from **# 5 1** to **9 9 9**.

**1** Press **Function/Set, 2, 4**.

**2** Press  or  to select ON (or OFF) and press **Function/Set**.

REMOTE ACT.: ON?

**3** If you want to, enter a new Fax Receive Code, then press **Function/Set**.

FAX RECEIVE:\*51

**4** If you want to, enter a new Telephone Answer Code, then press **Function/Set**.

TEL ANSWER:#51

**5** Press **Stop** to exit.

## Polling



Polling is the process of retrieving faxes from another fax machine. You can use your FAX/MFC to “poll” other machines, or you can have someone poll your machine. All parties involved in polling need to set up their fax machines to accommodate polling. When someone polls your machine to receive a fax, they pay for the call; if you poll someone’s fax machine to receive a fax, you pay for the call.

(See *Canceling a Scheduled Job*, page 6-5.)

For details about the Polling function, our fax-back system 1-800-521-2846 (USA), 1-800-681-9838 (From within Canada) and request Document #: 20918.





Some fax machines do not respond to the polling function.

## Setting Multi-function Link<sup>®</sup> Mode (For MFC 660MC Only)

If you connect your FAX/MFC to your PC, you can receive faxes into your PC. (See *Multi-Function Link<sup>®</sup> option for FAX 580MC*, page 16-1.) See Chapter 14 to set up for Multi-function Link<sup>®</sup> (for MFC 660MC only). After completing all setup for Multi-function Link<sup>®</sup>, you can select Multi-function Link<sup>®</sup> Mode (PC Primary/PC Receive Only/Fax Receive Only) for routing incoming faxes.

- 1 Press **Function**, **2**, **8**.

8.MF LINK

- 2 Press  or  to select PC PRIMARY, PC RECEIVE ONLY or FAX RECEIVE ONLY.
- 3 Press **Set** when the screen displays your selection.
- 4 Press **Stop** to exit.

# 6 Setup Send

## Automatic Document Feeder (ADF)

- Originals must be between 5.8 and 8.5 inches wide, and 5.9 and 23.7 inches long. Your FAX/MFC can only scan an image 8.2 inches wide, regardless the paper width.
- Make sure you place the original **face down, top edge first**.
- Adjust the paper guides to fit the width of your original.

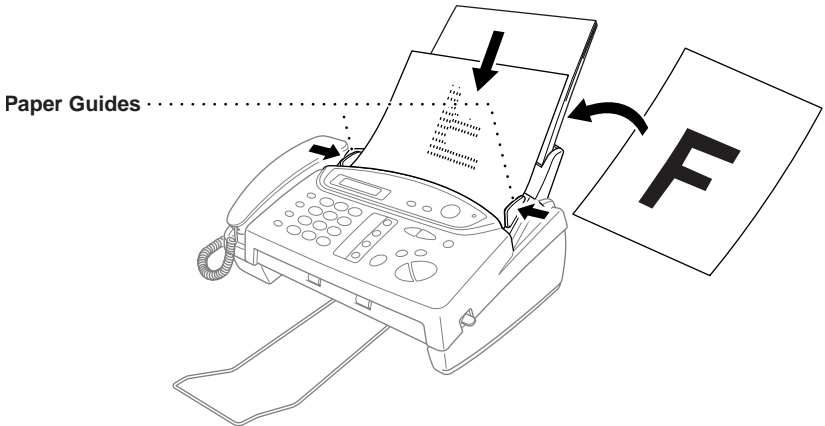

- The automatic document feeder (ADF) can hold up to 10 pages, feeding each one individually through the FAX/MFC. Use standard (17 lb–24 lb) paper when using the ADF; if you're using heavier paper, feed each sheet individually to prevent paper jams.
- ⊘ **DO NOT** use curled, wrinkled, folded or ripped paper, or paper with staples, paper clips, paste or tape attached. **DO NOT** use cardboard, newspaper or fabric.
- Make sure originals written with ink are completely dry.
- 🔍 You must press **Resolution** (before you send the fax) to select the resolution for the type of original you're sending. (See *Resolution*, page 6-3.)

## Manual Transmission

Manual transmission lets you hear the dial tone, ringing and fax receiving tones before sending the fax.

- 1 Place the original face down in the ADF.
- 2 Pick up the handset and listen for a dial tone  
—OR—press **Speaker Phone** and listen for a dial tone.
- 3 Enter the fax number you want to call. (You can enter the digits using the dial pad, or you can enter a One Touch or Speed Dial number or you can call using **Search/Speed Dial**.) (See *One Touch Dialing*, page 7-4 and *Search*, page 7-6.)
- 4 When you hear the fax tone, press **Start**.
- 5 If you're using the handset, hang up.

## Automatic Transmission

This is the easiest way to send a fax.

**IMPORTANT:** Do **not** pick up the handset, or press **Speaker Phone**.

- 1 Place the original face down in the ADF.
- 2 Enter the fax number using One Touch, Speed Dial, Search or the dial pad. (See *One Touch Dialing*, *Speed Dialing* and *Search*, page 7-4 to 7-6.)
- 3 Press **Start**.

## Manual and Automatic Fax Redial

*If you're sending a fax manually* and the line is busy, press **Redial/Pause** to retry the number.

*If you're sending a fax automatically* and the line is busy, the FAX/MFC will redial automatically up to three times at 5 minute intervals.

## Memory Transmission

This feature allows your machine to scan a fax into its memory and send it as soon as the scan is complete. This way, you don't have to wait for the entire fax to be transmitted before you retrieve your original.

- 1 Place the original face down in the ADF.
- 2 Press **Function/Set**, **3**, **9**.
- 3 To change the default setting, press ◀ or ▶ to select ON (or OFF) and press **Function/Set**. Go to Step 5—OR—For the next fax transmission only, press ◀ or ▶ to select NEXT FAX ONLY and press **Function/Set**.
- 4 For the next fax only, press ◀ or ▶ to select ON (or OFF) and press **Function/Set**.

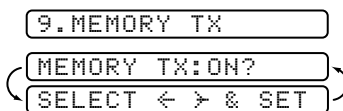



**5** Press **1** to select additional settings. The display returns to the SETUP SEND menu—**OR**—Press **2** if you are finished choosing settings and go to Step 6.

**6** Enter fax number and press **Start**.



If you get a MEMORY FULL message while scanning the first page of a fax, press **Stop** to cancel the scan. If you get a MEMORY FULL message while scanning in a subsequent page, you'll have the option to press **Start** to transmit the pages scanned so far, or to press **Stop** to cancel the operation. In this case, send the fax by the Manual Transmission.



Depending on your typical faxes, MEMORY FULL errors can occur frequently. If this happens, change the Memory Transmission setting back to OFF.

## **Basic Sending Operations**

---

### **Contrast**

If your original is very light or very dark, you might want to set the contrast accordingly. Use S.LIGHT to send a very light original. Use S.DARK to send a very dark original.

**1** Place the original face down in the ADF.

**2** Press **Function/Set, 3, 3**.

**3** Press **<** or **>** to select AUTO, S.LIGHT or S.DARK and press **Function/Set**.

**4** Press **2** if you are finished choosing settings, and go to Step 5—**OR**—Press **1** if you want to select additional settings. The display returns to the Setup Send menu.

**5** Enter a fax number and press **Start** to send a fax—**OR**—Press **Copy/Help** to make a copy.

### **Resolution**

When you have an original in the ADF, you can use the **Resolution** key. Press **Resolution** continuously until you see your selection on the screen.

**Standard**—suitable for most typed originals.

**Fine**—good for small print; transmits a little slower than standard resolution.

**Super Fine**—good for small print or artwork; transmits slower than fine resolution.



**Photo**—use when original has varying shades of gray; slowest transmission time.

# Advanced Sending Operations

## Overseas Mode



If you have difficulty sending a fax overseas, use the Overseas mode.

After you send a fax using this feature, the feature turns itself off.

- 1 Place the original face down in the ADF.
- 2 Press **Function/Set, 3, 5.** 
- 3 Press  or  to select ON (or OFF) and press **Function/Set.**
- 4 Press **1** if you want to select additional settings. The display returns to the Setup Send menu—**OR**—Press **2** if you are finished choosing settings and go to Step 5.
- 5 Enter the fax number you're calling.
- 6 Press **Start.**

## Delayed Fax

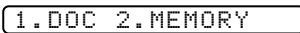
You can use this function to send a fax up to 24 hours later.

- 1 Place the original face down in the ADF.
- 2 Press **Function/Set, 3, 7.**
- 3 Enter the time, in 24-hour format, that you want the fax to be sent and press **Function/Set.** (For example, enter 19:45 for 7:45 PM)
- 4 Press **1** to leave the originals waiting in the ADF—**OR**—Press **2** to scan the original into memory.   
(See *Interrupting Delayed Fax and Polled Transmit Jobs*, page 6-5.)
- 5 Press **1** to select additional settings.  
The display returns to the SETUP SEND menu—**OR**—Press **2** if you are finished choosing settings and go to Step 6.
- 6 Enter the fax number. 
- 7 Press **Start.** The machine will wait to send the fax at the time you set up. 



## Setting Up for Polled Transmit

Polled Transmit is when you set up your FAX/MFC to wait with an original so another fax machine can retrieve it.

For more information call our fax-back system at 1-800-521-2846 (USA), 1-800-681-9838 (from within Canada) and request Document #: 21707.



## Canceling a Scheduled Job

You can cancel tasks you've scheduled, such as Delayed Fax or Polling Transmit.

- 1 Press **Function/Set, 4**. Any waiting jobs appear on the display. If there are no jobs waiting, the screen displays NO JOB WAITING. 
- 2 If you have more than two jobs waiting, press  or  to select the job you want to cancel and press **Function/Set**.  
—OR—  
If you have only one job waiting, go to Step 3.
- 3 Press **1** to cancel—OR—Press **2** to exit without canceling.
- 4 Press **Stop** to exit.

## Interrupting Delayed Fax and Polled Transmit Jobs

You can send a fax or make a copy now, even if you have the FAX/MFC set to send a fax later, or if you have it set to be polled. However, you cannot use automatic redial or the function mode.

- 1 Press **Function/Set, 5**.
  - 2 Wait 2 seconds, then remove the original that is waiting in the ADF. 
  - 3 Place the original you want to send now in the ADF.
  - 4 Enter the number for the fax you want to send now.
  - 5 Press **Start**.
  - 6 After the transmission is finished, return the first original to the ADF.
  - 7 Press **Function/Set, 5** to restore the Delayed Fax and/or Polling.
-  If you have set up a Delayed Fax or Polled Transmit job in memory, you don't have to interrupt it to send a fax or make a copy.
-  If you have set up a Delayed Fax or Polled Transmit job, the machine will send an original without storing it in memory.

## **More Advanced Features (Call Brother fax-back system)**

Your machine has additional advanced features and functions that are not included in this manual. To receive faxed instructions, please call our automated Brother fax-back system at 1-800-521-2846 and enter the Document Numbers for the following scripts:

- Polling (Doc #: 21707)
- Cover Page (Doc #: 20918)
- Call Reservation (Doc #: 21708)
- Print Sample Call Back Message (Doc #: 21709)
- Next Fax Reservation (Doc #: 21710)
- Multiple Resolution Transmission (Doc #: 21711)
- Glossary (Doc #: 21712)

# 7 Auto Dial Numbers and Dialing Options

## Storing Numbers for Easy Dialing

You can set up your FAX/MFC to do three types of easy dialing:

One Touch, Speed Dial, and Groups for Broadcasting of faxes.



*If you lose electrical power, auto dial numbers in memory will not be lost.*

### Storing One Touch Dial Numbers

You can store four fax/phone numbers that you can dial by pressing one key (and **Start**). You also can store names with these numbers. When you press a One Touch dial location, the screen displays the name or number as the call is dialed. (See *One Touch Dialing*, page 7-4.)

*One Touch keys are not the dial pad keys. They are the four keys (numbers 1–4) located in the middle of the control panel.*

**1** Press **Function/Set, 6, 1**.

**2** Press the One Touch key where you want to store a number.



(One Touch key **1** is pre-programmed for Brother fax-back system, USA only. You can override it if you wish.) The screen displays the location you selected.



**3** Enter a number (up to 20 digits) and press **Function/Set**.

NAME:



If you want to enter a pause in the dialing sequence (to wait for an “outside line,” for example), press **Redial/Pause** as you’re entering digits. Pressing **Redial/Pause** enters a 3.5-second pause when the number is dialed, and a dash appears on the screen.

**4** Use the dial pad to enter the name or company (up to 15 characters) and press **Function/Set**. You can use the chart on page 17 to help you enter letters—**OR**—To store the number without a name, press **Function/Set**. (See *Details for Entering Text*, page 4-2.)

**5** Press  or  to select the type of number and press **Function/Set**.

**FAX** a fax only number

**TEL** a telephone (voice) number

**FAX/TEL** both a fax and telephone (voice) number

**CHAIN** a number (usually an access code) for chain dialing.

**6** Return to Step 2 to store another One Touch number—**OR**—Press **Stop** to exit.

When you dial an AUTO DIAL number, the screen displays the name you've stored, or, if you haven't stored a name, the number you've stored.



If you must wait for another dial tone at any point in the dialing sequence, store a pause at that place in the number by pressing **Redial/Pause**. Each key press adds a 3.5 second pause.

You can use chain dialing to store long dialing sequences. For example, to store **9 1 201 555 1234 987 65 4321**, divide the number into two parts. Store the first part as a Chain type number (this tells the system that the dialing sequence is not complete).

**CHAIN—9 1 201 555 1234**



The last part of the One Touch number must be stored as any of the other following three types.

**FAX or FAX/TEL or TEL—987 65 4321**

Now, when you dial, just press the two keys (one after the other, in order) where you've stored the two parts of the number.

## Storing Speed Dial Numbers

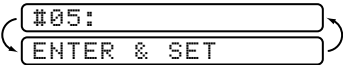
You can store Speed Dial numbers, when you dial by pressing only four keys. There are 50 Speed Dial locations.

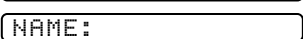

- 1 Press **Function/Set**, **6**, **2**.  

- 2 Use the dial pad to enter a two-digit location (01–50) and press **Function/Set**.  

- 3 Enter the number (up to 20 digits) and press **Function/Set**.  
  

- 4 Use the dial pad to enter the name or company (up to 15 characters) and press **Function/Set—OR—**Press **Function/Set** to store the number without a name. (See *Details for Entering Text*, page 4-2.)
- 5 Press **Left Arrow** or **Right Arrow** to select the type of number and press **Function/Set**.  

<b>FAX</b>	a fax only number
<b>TEL</b>	a telephone (voice) number
<b>FAX/TEL</b>	both a fax and telephone (voice) number
<b>CHAIN</b>	a number (usually an access code) for chain dialing.
- 6 Return to Step 2 to store another Speed Dial number—**OR**—Press **Stop** to exit.

## Changing One Touch and Speed Dial Numbers



If you try to store a One Touch or Speed Dial number in a location where a number is already stored, the screen displays the current name stored there, then prompts you to either

### 1. CHANGE—OR—2. EXIT.

- 1 Press **1** to change the number stored, or press **2** to exit without making a change.
- 2 Enter a new number.
  - If you want to erase the entire number, press **Stop** when the cursor is to the left of the digits. The letters above and to the right of the cursor are deleted.
  - If you want to change a digit, use  or  to position the cursor under the digit you want to change, then type over it.
- 3 Follow the directions from Step 3 in Storing One Touch Numbers or Storing Speed Dial Numbers.

## Setting Up Groups for Broadcasting

Groups allow you to send the same fax message to many fax numbers by pressing only one One Touch key (Broadcasting). **First**, you'll need to store each fax number as a One Touch or Speed Dial number. **Then**, you can combine them into a Group. **Each Group uses up a One Touch key**. **Finally**, you can have up to four small Groups, or you can assign up to 53 numbers to one large Group. (See *Storing One Touch Dial Numbers*, page 7-1, *Storing Speed Dial Numbers*, page 7-2 and *Broadcasting*, page 7-6.)

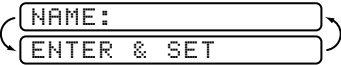
- 1 Press **Function/Set, 6, 3**.  

- 2 Select a One Touch key where you wish to store the number. (For example, press One Touch key **2** to store a Group.)
- 3 Use the dial pad to identify the Group with a number and press **Function/Set**. (For example, press **1** for Group 1.)  

- 4 To include One Touch or Speed Dial numbers in the Group, enter them as if you were dialing. For example, for One Touch key 3, press One Touch key **3**. For Speed Dial location 09, press **Search/Speed Dial**, then press **0, 9** on the dial pad. The LCD shows **\*03, #09**.  

- 5 Press **Function/Set** to accept the numbers for this group.  

- 6 Use the dial pad to enter a name for the group and press **Function/Set**. (For example, NEW CLIENTS) (See *Details for Entering Text*, page 4-2.)
- 7 Press **Stop** to exit.



You can print a list of all One Touch and Speed Dial numbers. See *Printing Reports*, Chapter 11.

# Dialing Options

---

You can use your FAX/MFC to make voice telephone calls by dialing manually, or by using Search, One Touch or Speed Dial memory. You can use the handset or you can use the **Speaker Phone** to make and receive calls.

The Speakerphone allows you to operate the phone hands free, or allows more than one person in the room to participate in a two-way phone conversation. When using the Speakerphone, make sure to speak clearly and close to the microphone .



When you dial an auto dial number, the screen displays the name you've stored, or, if you haven't stored a name, the fax number you've stored.

## Manual Dialing

Manual dialing is simply pressing all of the digits of the phone number.

- 1 Pick up the handset—**OR**—Press **Speaker Phone**.
- 2 When you hear a dial tone, dial the number using the dial pad.
- 3 You can switch from handset to Speakerphone by pressing **Speaker Phone**, then replacing the handset. You can switch from Speakerphone to handset by lifting the handset.
- 4 To hang up, replace the handset—**OR**—Press **Speaker Phone**.

## One Touch Dialing

- 1 Pick up the handset—**OR**—Press **Speaker Phone**. (See *Storing One Touch Dial Numbers*, page 7-1.)
  - 2 When you hear a dial tone, press the One Touch key of the location you want to call.
  - 3 To hang up a voice call, replace the handset—**OR**—Press **Speaker Phone**.
-  If you try to use a One Touch location with no number stored in it, you hear a warning sound, and screen displays NOT REGISTERED. The display returns to normal after 2 seconds.
-  If you are sending a fax, press **Start** after pressing the One Touch key. If you picked up the handset, press **Start** when the receiving fax machine answers with fax tones.



## Speed Dialing

- 1 Pick up the handset—**OR**—Press **Speaker Phone**. (See *Storing Speed Dial Numbers*, page 7-2.)
  - 2 When you hear a dial tone, press **Search/Speed Dial**, press **#**, then press the two-digit Speed Dial number.
  - 3 To hang up a voice call, replace the handset—**OR**—Press **Speaker Phone**.
-  If you are sending a fax, press **Start** after entering the Speed Dial number. If you picked up the handset, press **Start** when the receiving fax machine answers with fax tones.

## Dialing Access Codes and Credit Card Numbers

Sometimes you may want to choose from among several long distance carriers when you make a call. Rates may vary depending upon the time and destination. To take advantage of low rates, you can store the access codes or long-distance carriers as One Touch and Speed Dial numbers. You can store these long dialing sequences by dividing them and setting them up separately in any combination. You can even include manual dialing using the dial pad. The combined number will be dialed in the order you entered it, as soon as you press **Start**. Make sure you selected CHAIN as the type of the number when you store it into the One Touch or Speed Dial. (See *Storing One Touch Dial Numbers* and *Storing Speed Dial Numbers*, page 7-1 to 7-2.)

-  The CallManage access code can save you money on long distance calls (for details, see *CallManage*, page 8-5). (*For USA Only*)



For example:

You store “555” on One Touch key **03** and “7000” on One Touch key **02**. If you press One Touch **03**, **02** and **Start** you will dial “555-7000”. To temporarily change a number, you can substitute part of the number with manual dialing using the dial pad. For example, to change the number to 555-7001 you can press One Touch **03** and press **7**, **0**, **0**, **1** using the dial pad.

-  Pause after dialing Speed Dial numbers for the name to be displayed before you enter the next portion of the dialing sequence.

## Search

You can search for names you have stored in One Touch and Speed Dial memories. Names are shown alphabetically. (See *Storing One Touch Dial Numbers*, page 7-1 and *Storing Speed Dial Numbers*, page 7-2.)

- 1 Press **Search/Speed Dial**, then enter the first letter of the name you're looking for.
- 2 Press  or  to search the memory.
- 3 When the screen displays the name you want to call, pick up the handset or press **Speaker Phone** for a voice call.
- 4 Press **Start** to begin dialing.
- 5 When the call is over, hang up—**OR**—Press **Speaker Phone** to cancel the call.

## Redial

If the last number you dialed was busy, press **Redial/Pause** for easy dialing.

## Answering Calls with the Speakerphone

When the FAX/MFC rings, instead of lifting the handset, press **Speaker Phone**. Speak clearly, toward the microphone . To end the call, press **Speaker Phone**.

If you have a bad telephone line connection, the other party might hear your voice echoed during the call. Hang up and try the call again—**OR**—Pick up the handset.

## Broadcasting

Using the numbers you have stored in Groups, One Touch and Speed Dial memory, you can “broadcast” faxes automatically to a maximum of 54 different locations in a few simple steps. (See *Setting Up Groups for Broadcasting*, page 7-3.) To Broadcast, you must set MEMORY TX to either ON or NEXT FAX ONLY.

After the Broadcast is completed, a Broadcast Report will be printed automatically to let you know the results.

- 1 Place the original face down in the ADF.
- 2 Press **Function/Set, 3, 9** to select ON or NEXT FAX ONLY and press **Function/Set**.
- 3 Enter the One Touch and Speed Dial numbers (one after the other) or a Group Number you have stored.
- 4 Press **Start**. The FAX/MFC stores the original in memory, then transmits it to all the numbers you entered. If the line is busy, your machine will redial automatically up to three times at 5 minutes intervals.



Press **Stop** during transmission to cancel the current fax broadcast.

## Pause

Press **Redial/Pause** to insert a pause between numbers. Each key press adds a 3.5 second delay.

## Hold

- 1** Press **Hold/Caller ID** to put a call on Hold.
- 2** You can put down the handset without disconnecting the call.
- 3** Pick up the FAX/MFC handset—**OR**—Press **Speaker Phone** to release the call from Hold. Picking up an extension handset will not release the call from Hold.

## Tone/Pulse (For Canada Only)

If you have pulse dialing service, but need to send tone signals (for telephone banking, for example), follow the directions below. If you have touch tone service, you do not need this feature to send tone signals.

- 1** Lift the handset.
- 2** Press **#**. Any digits dialed after this send tone signals.
- 3** When you hang up, the FAX/MFC returns to pulse dialing mode.

## Custom Features

---

Your FAX/MFC supports the Distinctive Ring and Caller ID telephone services offered by some telephone companies.



If you have Call Waiting, Ring Master, Voice Mail, an answering service or an alarm system or other custom feature on your telephone line, it may create a problem in the operation of your FAX/MFC.

### Distinctive Ring

This FAX/MFC feature lets you use the Distinctive Ring subscriber service offered by some telephone companies, which allows you to have several telephone numbers on one phone line. Each phone number has its own Distinctive Ring pattern, so you know which phone number is ringing. This is one way you can have a separate phone number for your FAX/MFC.

Your FAX/MFC has a Distinctive Ring function, allowing you to dedicate one phone number just for receiving faxes. You'll need to follow the directions below to "register" the new Distinctive Ring pattern, that was assigned by the Telephone Company, so your FAX/MFC can recognize its incoming calls.





You can change or cancel the Distinctive Ring pattern at any time. You can switch it off temporarily, then turn it back on. When you get a new fax number, make sure you reset this function.









You can register only one Distinctive Ring pattern with the FAX/MFC. Some ringing patterns cannot be registered.

- The FAX/MFC will answer only calls to its registered number.
- To have your TAD answer only the main number, the FAX/MFC must be in Manual Mode.
- In FAX/TEL or FAX ONLY mode, the FAX/MFC will answer all numbers on the phone line.

### Registering the Distinctive Ring Pattern

- 1 Set the FAX/MFC to MANUAL mode.
- 2 Press **Function/Set, 0, 1**.
- 3 Press  or  to select **DISTINCTIVE:SET?** and press **Function/Set**.

- 4 Press  or  to select the prestored ring pattern you want to assign and press **Function/Set**. (You will hear each pattern as you scroll through the four patterns.) Be sure to choose the pattern assigned by the Telephone Company.

Ring Pattern	Rings	
1	long - long	
2	short - long - short	
3	short - short - long	
4	very long (normal pattern)	

- 5 Press **Stop** to exit.

## Caller ID

The Caller ID feature of this FAX/MFC lets you use the Caller ID subscriber service offered by many local telephone companies. After at least two rings, the screen displays the telephone number of your caller (or up to 16 characters of the name, if available). Once you pick up the handset, the Caller ID information disappears from the screen, but the call information remains stored in the Caller ID memory.

- CALL PICKUP display remains on the screen when no Caller ID information was transmitted.
- OUT-OF-AREA display means the call originates outside your Caller ID service area.
- PRIVATE CALL display means the caller has intentionally blocked transmission of information.

Caller ID service varies with different carriers. Call your local telephone company to determine the kind of service available in your area.

## Caller ID Log





Your FAX/MFC stores up to 30 of the last Caller IDs received into the FAX/MFC's memory in the Caller ID Log. When the thirty-first call comes in, information about the first call is erased. You can print the report or scroll through Caller ID information to review those calls made to your FAX/MFC.

## Printing the Caller ID Log

- 1 Press **Hold/Caller ID**.
- 2 To print the Caller ID Log, press **Start**.

CALLER ID LOG  
PRINTING

## Viewing the Caller ID Log



- 1 Press **Hold/Caller ID**.
- 2 After 2 seconds, press  or  to scroll through the Caller ID Log.
- 3 When you want to see more detailed information for a displayed ID (phone number and date and time call was received) press **Function/Set**.
- 4 To continue viewing the Caller ID Log (Step 2), press  or  .  
—OR—  
To exit the Caller ID Log, press **Stop**.

CALLER ID LOG  
PRESS START KEY  
SELECT ← → & SET  
01>MARY HENDERSON  
02>TOM HENDERSON  
03>ABC COMPANY  
03>ABC COMPANY  
03>9087772837  
03>02/01 12:00  
DIAL:PRESS START

## Returning a Call from the Log

You can scroll through the Caller ID Log and select a call to return automatically. (See page 8-2)

You must set up your AREA CODE in advance. (USA only)

- 1 Press **Hold/Caller ID**.
- 2 Press  or  to scroll through the Caller ID Log and when you see a call you want to return immediately, press **Function/Set**.
- 3 To begin dialing, press **Start**.
- 4 Begin speaking when the other party answers.

CALLER ID LOG  
PRESS START KEY  
SELECT ← → & SET  
01>MARY HENDERSON  
01>9082438436  
01>02/01 12:00  
DIAL:PRESS START



This feature may not be available in certain area of USA and Canada.

If your dialing plan does not follow the standard 1 + area code + 7-digit number dialing system for calling outside your area code, you may experience problems returning calls automatically from the Caller ID Log. Your FAX/MFC will automatically dial "1" plus the area code for any number that does not originate in your area code. If this is not the procedure followed by your dialing plan you will not be able to return calls automatically.

## Registering a Caller ID Number

You can set up a caller in the Caller ID Log as a One Touch or Speed Dial number.

- 1 Press **Hold/Caller ID**.

CALLER ID LOG

PRESS START KEY

SELECT ← → & SET

- 2 After 2 seconds, press ◀ or ▶ to scroll through the Log and when you see a caller you want to register, press **Function/Set**.

03>ABC COMPANY

03>9087772837

03>02/01 12:00

- 3 To register the caller as a One Touch number, press the One Touch key where you want the number to be stored.

DIAL:PRESS START

—OR—

To register the caller as a Speed Dial number, press **Search/Speed Dial** and use the dial pad to press the two-digit location code (01–50), and press **Function/Set**.

NAME:

ENTER & SET



If the LCD shows REGISTERED, the auto dial location already has a number.

- 4 Enter the caller's name and press **Function/Set**.
- 5 Press ◀ or ▶ to select the type of number and press **Function/Set**:

**FAX** A fax number

**TEL** A telephone (voice) number

**FAX/TEL** Both a fax and telephone number

**CHAIN** A number, usually an access code, for chain dialing

- 6 Return to Step 2 to store another auto dial number—OR—Press **Stop** to exit.

## Clearing a Caller ID Stored in Memory

For effective use of the memory, it is recommended that you clear the Caller IDs stored in memory by pressing **Erase** when the display shows the number or name.

## Call Waiting Caller ID

The Call Waiting Caller ID feature lets you use the Call Waiting Caller ID service offered by many local telephone companies. This feature displays the telephone number (or name, if available) of Call Waiting callers on your FAX/MFC's screen.

- 1** To answer a Call Waiting signal while you're talking on the phone, ask the other party if you can put them on Hold to catch the other call. The screen displays the Caller ID.
- 2** Press **Search/Speed Dial** to switch to the second call.
- 3** To switch back to the first call, press **Search/Speed Dial** again.



Either caller can hang up at any time. However, if you hang up you will disconnect both callers.

## CallManage (For USA Only)

This Brother fax machine provides convenient, "One-Touch" access to a long distance plan that provides best average long distance rates\*. Once registered, fax or phone calls made using the CallManage feature will access a long distance carrier selected by CallManage, Inc., that offers a plan with best average domestic rates based on standard long distance plans of major carriers within the United States. This may result in significant savings, depending on your current long distance carrier and calling patterns.

Trying the CallManage feature requires no commitment on your part. Just follow the steps below to register with CallManage, Inc. Once registered, your One-Touch key **4** can be used to access the CallManage feature for any calls you choose. Calls made without using the CallManage feature will be processed through your normal long distance carrier.

If you prefer not to activate the CallManage feature you can use One Touch key **4** to store a number of your own choosing.

## Registration with CallManage

Before using the CallManage feature, you must register for this service with CallManage Inc.:

- 1** Pick up the handset of your FAX/MFC.
- 2** Press One Touch **4**.  
(Your machine will automatically dial the pre-stored toll free registration number for CallManage, Inc. or you may directly dial **1-888-387-9680**.)
- 3** A CallManage Customer Service Representative will ask you a number of simple questions required to set up your account (such as name, address, phone number, etc. for billing purposes). There are no sign-up fees, monthly service charges or connection fees for the CallManage feature. You will receive a separate itemized bill each month from CallManage, Inc. for only those calls made using the CallManage feature\*.
- 4** After registering, the Representative will explain how to reprogram your One Touch key **4** for CallManage dialing.



## Sending a Fax Using CallManage

- 1 Place the original face down in the ADF.
- 2 Press One Touch 4.
- 3 Dial the complete long distance or international fax number as usual, using One Touch, Speed Dial, Search or the dial pad. (See *One Touch Dialing*, *Speed Dialing* and *Search*, page 7-4 to 7-6.)
- 4 Press **Start**.

## Placing a Telephone Call Using CallManage

 You must dial the number and wait to hear the other party answer *before* you pick up the handset to speak.

- 1 Press One Touch 4.
- 2 Dial the complete long distance or international number as usual, using One Touch, Speed Dial, Search or the dial pad. (See *One Touch Dialing*, *Speed Dialing* and *Search*, page 7-4 to 7-6.)
- 3 Press **Start**.
- 4 Pick up the handset when you hear the other party through the fax machine's one-way speaker.

## Customer Support

If you have questions or want more information, call CallManage at **1-877-622-5457**.



Percent savings and comparisons based on standard rate plans of major carriers with tariffs in effect as of January 2000. Long distance savings will depend upon the customer's current carrier for long distance service and his or her calling patterns. Rates updated periodically. Call 1-877-622-5457 for latest rate and underlying carrier information. In order to use the CallManage feature you must register for service through CallManage, Inc (toll free) at 1-888-387-9680. Once registered, the One Touch 4 button will access a long distance provider selected by CallManage, Inc. that offers a plan with best average domestic rates based on standard long distance plans of major carriers within the United States. Using the CallManage feature after registering will result in your receiving a long distance telephone bill from CallManage, Inc. Without proper registration, calls made using the One Touch 4 button may not be connected or may default to a standard rate plan offered by the underlying carrier and charges for such calls will appear either on the customer's local telephone bill as the underlying carrier's service or on a direct bill from the underlying carrier. The One Touch 4 button should not be used if the customer wishes to use his or her existing primary or dial around carrier for long distance service. Brother International, Corp. is not responsible for long distance service or customer billing. Subject to service availability. All applications are subject to credit approvals. **DO NOT USE THE ONE TOUCH 4 BUTTON TO DIAL 911 – IT WILL NOT ACCESS EMERGENCY SERVICES.** CallManage is a trademark of CallManage, Inc.

## Message Center Mode

Message Center Mode allows you to store incoming fax and voice messages in a flexible memory. The memory stores 15 minutes of voice messages, or up to 20 pages of fax memory. Any voice or fax message can be retrieved remotely. Memory is shared between fax and voice messages, which are stored on a “first-come, first-served” basis.

You must record an outgoing message in order to use the Message Center Mode. (See *Recording Message Center Outgoing Message*, page 9-2.)

### Flexible Memory Settings (Message Storage)

Message Center Mode offers you six flexible memory settings, so you can decide the kinds of messages you want to receive.

- |                            |   |
|----------------------------|---|
| <b>1.FAX:ON VOICE:ON</b>   | Both voice and fax messages are stored. You can use the Fax Forwarding or Paging features and retrieve voice and fax messages remotely.   |
| <b>2.FAX:ON VOICE:EXT</b>  | You need an external answering machine connected to the EXT jack for this setting. Fax messages are stored in the message center memory, but voice messages are stored in your external answering machine. Retrieve messages from the external answering machine. You cannot use the Paging feature for voice messages with this setting. |
| <b>3.FAX:ON VOICE:OFF</b>  | All memory is used to store fax messages— no voice messages will be stored.   |
| <b>4.FAX:OFF VOICE:ON</b>  | All memory is used to store voice messages—no fax messages will be stored. Incoming faxes will print on paper. You can use the Paging feature, and retrieve voice messages remotely.  |
| <b>5.FAX:OFF VOICE:EXT</b> | You need an external answering machine connected to the EXT jack for this setting. Incoming faxes are not stored in memory, but will print on paper. Voice messages are stored in the external answering machine.   |
| <b>6.FAX:OFF VOICE:OFF</b> | Incoming faxes are not stored in memory, but will print on paper. Voice calls are not stored in memory.   |





## Setting Up the Message Center

You must set up the Message Center in the following order:

- 1 Setting Message Storage.  
(See *Setting Message Storage*, page 9-2.)
- 2 Record Message Center Outgoing Message (MSG CTR OGM).  
(See *Recording Message Center Outgoing Message*, page 9-2.)
- 3 Activate Message Center Mode.  
(See *Activating Message Center Mode*, page 9-3.)

## Setting Message Storage

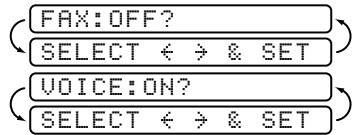

Read the Flexible Memory Setting descriptions on page 9-1 before you select the FAX and VOICE settings below.

- 1 Press **Function/Set, 8, 1.**
- 2 Press  or  to select ON (or OFF) and press **Function/Set.**
- 3 Press  or  to select your setting from the list on pages *Flexible Memory Settings (Message Storage)*, page 9-1 (ON, OFF, EXT) and press **Function/Set.**
- 4 Press **Stop** to exit.





## Recording Message Center Outgoing Message

Recording the Message Center Outgoing Message (MSG CTR OGM) is the second step you need to follow before you can turn on the Message Center. Make sure your OGM is less than 20 seconds long.

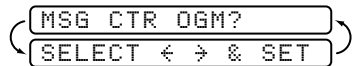
- 1 Press **Function/Set, 8, 3.**  
The screen prompts you to choose an OGM.
- 2 Press  or  to select MSG CTR OGM? (not F/T OGM) and press **Function/Set.**









**This is the only setting you can select if you want to turn the Message Center on.**

- 3 Press  or  to select RECORD OGM? and press **Function/Set.**
- 4 Pick up the handset to record a message.





**For example:** *Hello. We are unable to take your call at this time. Please leave a message after the signal. If you wish to send a fax, please press \*5 1, wait for fax tones, then press the Start button.*

- 5 Replace the handset. The Message Center will play your OGM.
- 6 Press **Stop** to exit.

## Listening to Outgoing Message (OGM)

- 1 Press **Function/Set, 8, 3**.
- 2 Press  or  to select MSG CTR OGM? (or F/T OGM) and press **Function/Set**.
- 3 Press  or  to select PLAY OGM? and press **Function/Set**. Adjust the volume by pressing Volume  or .
- 4 Press **Stop** to exit.

## Erasing Outgoing Message (OGM)

- 1 Press **Function/Set, 8, 3**.
- 2 Press  or  to select MSG CTR OGM? (or F/T OGM) and press **Function/Set**.
- 3 Press  or  to select ERASE OGM? and press **Function/Set**.
- 4 Press **1** to erase the OGM—**OR**—Press **2** to exit without erasing.
- 5 Press **Stop** to exit.

## Activating Message Center Mode

Press and hold  until it lights and the LCD displays:

MC:MSG CTR

When  light is out, the Message Center is off. (See *Setting Up the Message Center*, page 9-2.)

## Message Indicator

The  light flashes when you have *new* messages or faxes waiting for your review.

The LCD displays the total number of voice and fax messages stored in the Message Center memory.

VOICE:03 FAX:02

If you press the flashing  to turn off the Message Center before getting your new messages, they won't be lost. The new messages will be played automatically and the LCD will ask you to acknowledge the new faxes:

PRINT FAX?

1.YES 2.NO

Press **1** to print (and automatically delete) the faxes from memory—**OR**—Press **2** to save the faxes in memory until printing is convenient.

## Playing Voice Messages

Follow the steps below to listen to voice messages.

- 1 Press **Play/Record**. Adjust the Volume by pressing **L** or **H**.

All messages are played in the order they were recorded. The display shows the number of the current message, and the total number of messages.

If Caller ID information was received, the FAX/MFC beeps during the message and displays the Caller ID information for one second.

During playback, the screen displays the time and date the message was recorded.

- 2 Press **\* (RWD)** at the end of the message to repeat a message. Press **# (FWD)** to skip to the next message. You can press **\*** and **#** repeatedly until you reach the message you want to play.
- 3 Press **Stop** to exit.

## Printing a Fax Message

Once you print a new fax message stored in memory, it is erased from the memory automatically.

- 1 Press **Play/Record**. After two seconds, the FAX/MFC begins to play voice messages.
- 2 If there are fax messages in memory, the LCD displays:
- 3 To print the faxes, press **1**

The LCD display shows two lines of text: "PRINT FAX?" on the top line and "1.YES 2.NO" on the bottom line. The text is enclosed in a rounded rectangular border with small curved ends on the left and right sides.

—OR—

Press **2** to exit without printing.

## Backup Printing Option

When you choose FAX: ON in the Message Center mode, all incoming fax messages are stored in the available memory for retrieval. To print a backup copy automatically, turn this option on.

- 1 Press **Function/Set. 8, 2**.
- 2 Press **Left Arrow** or **Right Arrow** to display **ON** (or **OFF**) and press **Function/Set**.
- 3 Press **Stop** to exit.

The LCD display shows two lines of text: "BACKUP PRINT:ON" on the top line and "SELECT ← → & SET" on the bottom line. The text is enclosed in a rounded rectangular border with small curved ends on the left and right sides.

## Erasing Messages



If you choose to erase all *fax* messages, the FAX/MFC will print any previously unprinted faxes before erasing them from memory. Fax messages cannot be erased individually.

You can erase *voice* messages individually, or all at once.

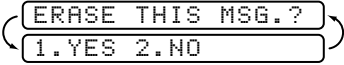
### To erase voice messages individually

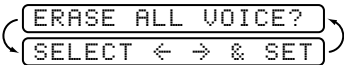

- 1 Press **Play/Record**. The FAX/MFC sounds a two-second beep and begins message playback. Each message is preceded by one long beep, and followed by two short beeps.
- 2 To erase a specific message, press **Erase** immediately after the two short beeps, or while the message is playing. The screen prompts 
- 3 Press **1** to erase the message—**OR**—Press **2** to cancel.
- 4 Press **Stop** to exit.

### To erase messages all at once

- 1 Press **Erase**.
- 2 Press  or  to select erasing all voice messages (**VOICE**), all document messages (**FAX**), or all messages—both voice and fax—(**MSG**) and press **Function/Set**. 
- 3 Press **1** to erase—**OR**—Press **2** to cancel.
- 4 Press **Stop** to exit.

## Setting Maximum Time for Incoming Messages

Your FAX/MFC comes set to receive voice messages up to 30 seconds long. You can change this setting to any length from 20 seconds to 60 seconds, in 5-second increments.

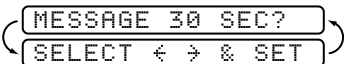
- 1 Press **Function/Set**, **8**, **4**.
- 2 Press  or  to select the maximum time setting for incoming messages and press **Function/Set**. 
- 3 Press **Stop** to exit.

## Setting Toll Saver

When you set the toll saver feature, the FAX/MFC answers after four rings if you *don't* have messages, and after two rings if you *do* have messages. This way, when you call the FAX/MFC, if it rings three times, you know you have no messages, and can hang up, to avoid a toll charge.



When Toll Saver is ON, it overrides your Ring Delay setting. Toll Saver must be off for the FAX/MFC to operate using your Ring Delay setting. (See *Setting Ring Delay*, page 5-2.)

- 1 Press **Function/Set, 2, 1**.
- 2 Press or to select the TOLL SAVER (or RING DELAY) and press **Function/Set**.
- 3 Press or to select ON and press **Function/Set**.
- 4 Press **Stop** to exit.

## ICM Recording Monitor

This feature lets you turn the speaker volume for voice messages ON or OFF. When you turn the monitor OFF, you will not hear messages as they come in.

- 1 Press **Function/Set, 8, 5**.
- 2 Use or to select OFF (or ON) and press **Function/Set**.
- 3 Press **Stop** to exit.

## Recording a Conversation

You can record a telephone conversation by pressing **Play/Record** during the conversation. Your recording can be as long as the Incoming Message Maximum Time. You and the other party will hear a beep every 15 seconds while recording. To stop recording, press **Stop**. You cannot record a conversation using Speaker Phone.

## Fax Forwarding/Paging



When Paging is set to ON, your FAX/MFC dials the pager number you've programmed, and dials your Personal Identification Number (PIN) when connected, to activate your pager and let you know you have a fax or voice message in the Message Center memory.

When Fax Forwarding is set to ON, your FAX/MFC dials the fax machine phone number you've programmed, and forwards any faxes you've received.





You can *not* use Paging and Fax Forwarding at the same time.

## Programming a Fax Forwarding Number

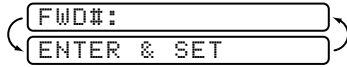

- 1 Press **Function/Set, 8, 6.**
- 2 Press  or  until the LCD displays **FAX FORWARD?** and press **Function/Set.**
- 3 Enter the number of the fax machine where faxes will be forwarded (up to 20 digits) and press **Function/Set.**
- 4 Press **Stop** to exit.



 You can change a Fax Forwarding number remotely. (See page 9-11.)

 You can *not* use Paging and Fax Forwarding at the same time.

## Programming Paging Number

- 1 Press **Function/Set, 8, 6.**
- 2 Press  or  until the LCD displays **PAGING?** and press **Function/Set.**
- 3 Enter your pager phone number (up to 20 digits) followed by **# #** and press **Function/Set.** Do not include the area code if it is the same as that of your FAX/MFC. *For example, 1 8 0 0 5 5 5 1 2 3 4 # #.*
- 4 If your pager requires a PIN, enter the PIN, press **#**, press **Redial/Pause**, enter your FAX/MFC telephone number, then press **# #** and press **Function /Set.** *For example, 1 2 3 4 5 # Redial/Pause 1 8 0 0 5 2 1 2 8 4 6 # #.*

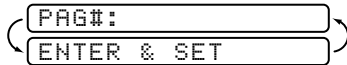

—OR—

If you do not need a PIN, press **Redial/Pause**, enter the telephone number of your FAX/MFC, then press **# #** and press **Function/Set.** *For example, Redial/Pause 1 8 0 0 5 2 1 2 8 4 6 # #.*

- 5 Press **Stop** to exit.

 You can *not* change a Paging number or PIN remotely.



# Remote Retrieval

---

## Using Remote Access Code

- 1 Dial your fax number from a touch tone phone.
- 2 When your FAX/MFC answers, immediately enter your Remote Retrieval Access Code.
- 3 The FAX/MFC signals the kinds of messages received:
  - 1 long beep—**Fax message(s)**
  - 2 long beeps—**Voice message(s)**
  - 3 long beeps—**Fax and Voice message(s)**
  - No beeps—**No messages**
- 4 The FAX/MFC then prompts you with two short beeps to enter a command. If you wait longer than 30 seconds to enter a command, the MFC hangs up. If you enter an invalid command, the FAX/MFC beeps three times.
- 5 Press **9 0** to reset the FAX/MFC when you finish.
- 6 Hang up.



If your FAX/MFC is set to MANUAL mode, you can access the Message Center by waiting about 2 minutes, then entering the Remote Access Code within 30 seconds.



## Changing Remote Retrieval Access Code

Enter your Remote Retrieval Access Code when the FAX/MFC picks up your call, so you can access features remotely. The access code is preset to 159✳, but you can change it.

- 1 Press **Function/Set, 8, 7**.
- 2 Enter a three-digit number from 000 to 999 and press **Function/Set**. The “✳” cannot be changed.
-  Do not use the same digits that appear in your Fax Receive Code or Telephone Answer Code.
- 3 Press **Stop** to exit.

## Remote Commands

Follow the commands below to access features remotely. When you call the FAX/MFC and enter your Remote Retrieval Access Code (159\*), the system will signal you with two short beeps to enter a remote command.

Remote Commands		Operation Details
<b>91 Playing voice messages</b>	1  (Skip back)	After one long beep, the FAX/MFC plays the ICM.  Press <b>1</b> while listening to an ICM to repeat it. If you press <b>1</b> before a message, you will hear the previous message.
	2  (Skip next)	While playing the ICM, you can skip to the next message.
	9 STOP Playing	Stop playing the ICM.
	<b>92 Record Memo</b>	
<b>93 Erase all ICM</b>		If you hear one long beep, the erase is accepted. If you hear three short beeps, you cannot erase because all voice messages have not been played, or there is no voice message to erase. *This code erases all recorded messages, not one at a time.
<b>94 Play and Record OGM in memory</b>		
1 Play	1 MSG CTR OGM	The FAX/MFC plays the selected OGM. You can stop playing OGMs by pressing <b>9</b> .
	2 F/T OGM	
2 Record	1 MSG CTR OGM	After one long beep, you can record the selected OGM. You will hear the message played once. You can stop recording the message by pressing <b>9</b> .
	2 F/T OGM	
<b>95 Changing Fax Forwarding/Paging setting</b>		If you hear one long beep, the change is accepted. If you hear three short beeps, you cannot change it because the conditions have not been met. (Example: registering paging number.) You can register your fax forwarding number by using 4. FAX FWD NO. (See page 9-11.) Once you have registered the number, the FAX/MFC automatically will change to FAXFWD:ON mode. Then retrieve a Memory Status List by entering <b>9 6 1</b> (See page 9-10.) to make sure that the Fax Forwarding number you registered is correct in the List.
1 OFF		
2 Fax Forwarding		
3 Paging		
4 FAX FWD NO.		

Remote Commands		Operation Details
<b>96 Retrieve a fax</b>	1 Memory Status List	Enter the number of a remote fax machine to receive a report or stored fax messages. (See page 9-10.)
	2 Retrieve all faxes	
	3 Erase fax in the memory	If you hear one long beep, you can erase the fax message from the memory.
<b>97 Check the receiving status</b>	1 FAX	You can check whether your FAX/MFC has received any FAX or VOICE messages. If yes, you will hear one long beep. If no, you will hear three short beeps.
	2 VOICE	
<b>98 Change Answer Mode</b>	1 MSG CTR	If you hear one long beep, you can change the answer mode. If you hear three short beeps, you cannot change it. (Example: There is no MSG CTR OGM when you want to change to MSG CTR mode.)
	2 FAX/TEL	
	3 FAX	
<b>90 Exit</b>		After a long beep, you can exit remote control.

## Retrieving Memory Status List

You can retrieve the Memory Status List from a remote fax machine to see if you have any fax messages.

- 1** Dial your fax number.
  - 2** When you hear the beep, immediately enter your Remote Retrieval Access Code (**1 5 9 ✕**).
  - 3** When you hear two short beeps, use the dial pad to press **9 6 1**.
  - 4** Using the dial pad, enter the number of the remote fax machine (up to 20 digits) where you want the Memory Status List forwarded, and then press **#**.
-  You can *not* use **✕** or **#** as dial numbers. However, if you want to store a pause, press **#**.
- 5** After you hear your FAX/MFC beep, hang up and wait.

Your FAX/MFC calls the remote fax machine. The remote fax machine prints the Memory Status List.

## Retrieving Fax Messages

- 1 Dial your fax number.
- 2 When you hear the beep, immediately enter your Remote Retrieval Access Code (1 5 9 ✕).
- 3 As soon as you hear two short beeps, use the dial pad to press **9 6 2**.
- 4 Using the dial pad, enter the number of the remote fax machine (up to 20 digits) where you want your fax messages forwarded, and then press **# #**.



You can *not* use ✕ or # as dial numbers. However, if you want to store a pause, press #.

- 5 After you hear your FAX/MFC beep, hang up and wait.

Your FAX/MFC calls the remote fax machine. The remote fax machine prints your fax messages.

## Changing Fax Forwarding Number

You can change the default setting of your fax forwarding number from a remote fax machine.

- 1 Dial your fax number.
- 2 When you hear the beep, immediately enter your Remote Retrieval Access Code (1 5 9 ✕).
- 3 When you hear two short beeps, use the dial pad to press **9 5 4**.
- 4 Enter the new number of the remote fax machine where you want your fax messages forwarded, then press **# #**.



You can *not* use ✕ or # as dial numbers. However, if you want to store a pause, press #.

- 5 To retrieve the Memory Status List, when you hear two short beeps, use the dial pad to press **9 6 1**.
- 6 Use the dial pad to enter the number of the remote fax machine (up to 20 digits), then press **# #**.
- 7 After you hear your FAX/MFC beep, hang up and wait.

Your FAX/MFC calls the remote fax machine. The remote fax machine prints the Memory Status List showing the new forwarding number.

- 8 Check the forwarding number.

If the forwarding number is not correct, return to Step 1 to reset it.

# 10 Making Copies

## Copy Functions

To make a single copy that is not reduced, enlarged or sorted, you only have to press one key. The default resolution for a single copy is Super Fine. Set the resolution to PHOTO for photographs. Remember, your machine cannot scan anything closer than one-eighth inch from the edge of the paper.

### Making a Single Copy

1 Place the original face down in the ADF.

2 Press **Copy/Help** twice.

To cancel, press **Stop**.

Do NOT pull on the paper while copying is in progress.

### Copy Options: Single or Multiple Copies, Reduce/Enlarge, Sort/Stack

You can choose additional copy options. First, you can select the number of copies. Next, you can choose whether multiple copies will be STACKED (all copies of page 1, then all copies of page 2, etc.) or SORTED (collated). Finally, you can choose an enlargement or reduction ratio. To automatically reduce the copy to the paper size you have set for the paper tray, select **AUTO**. To reduce the copy by a fixed percentage, choose **93%**, **87%**, **75%** or **50%**. Or, to enlarge the copy, select **150%**, **125%** or **120%**. To copy a document at its original size, select **100%**.

1 Place the original face down in the ADF.

2 Press **Copy/Help**.

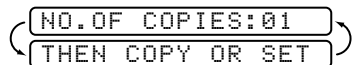

NO. OF COPIES: 01  
THEN COPY OR SET

3 Enter the number of copies you want (1-99) and press **Function/Set**.

For example, press 9 for nine copies.



NO. OF COPIES: 09

*To start copying now*, press **Copy/Help**.



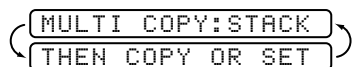

STACK P. 01 FNE

*If you would like to select additional copy options*, like **SORT**, **ENLARGE** or **REDUCE**, press **Function/Set**.





MULTI COPY: STACK  
THEN COPY OR SET

- 4 Press  or  to select **SORT**.  
For example, select **SORT**.

*To start copying now without enlarging or reducing, press **Copy/Help**.*

*To reduce or enlarge the image, press **Function/Set**.*

- 5 Press  or  to select an enlargement or reduction ratio.

For example, **75 %**.

- 6 Press **Copy/Help**.

MULTI COPY: SORT

SORT P.01 FNE

ELG/RDC: 100% ?

THEN COPY OR SET

ELG/RDC: 100% ?

ELG/RDC: 120% ?

.

ELG/RDC: 93% ?

ELG/RDC: 75% ?

SORT P.01 FNE



If you are making multiple copies and get a **MEMORY FULL** message while you are scanning the first page, press **Stop** to cancel the job. Then make a single copy. If you selected **SORT** and the **MEMORY FULL** message appears while scanning subsequent pages, you can press **Copy/Help** to copy the portion that is in memory, or press **Stop** to cancel. To restart the copy job using less memory, press **Copy/Help** for stacked copies.

# 11 Printing Reports

## FAX/MFC Settings and Activity

---

You can print the following lists and reports:

1. XMIT REPORT

Choose to print a Transmission Verification Report after each fax you send.

2. ACT. REPORT

Activity Report lists information about the last 30 incoming and outgoing faxes. TX means Transmit; RX means Receive.

3. AUTO DIAL

Lists names and numbers stored in One Touch and Speed Dial memory, in numerical order.

4. TEL. INDEX

AUTO DIAL LIST (above), alphabetically.



5. USER SETTINGS

Lists settings for INITIAL SETUP, SETUP RECEIVE, SETUP SEND, PRINT REPORTS, TEL SERVICE and SETUP MSG CTR.

6. MEMORY STATUS

Lists summary information and amount of memory in use.

### To Print a Report



- 1 Press **Function/Set, 7**.
- 2 Enter the number of the report you want to print. For example, press **4** to print the TEL-INDEX.
-  For the Activity Report, also press  or  to select PRINT REPORT?.
- 3 Press **Start**.
- 4 Press **Stop** to exit.

## Transmission Verification (Xmit) Report

You can use the Xmit Report as proof that you sent a fax. This report lists the name or fax number of the receiving party, the time and date of transmission, and whether the transmission was successful.





When the feature is OFF, the report is printed automatically only if there's an error during transmission. If the report indicates NG, send the original again. If the report indicates you should check the readability of certain pages, resend those pages.

When the feature is ON, the report is printed with every fax you send.

- 1 Press **Function/Set, 7, 1.**
- 2 Press  or  to select ON (or OFF) and press **Function/Set.**
- 3 Press **Stop** to exit.

## Activity Report Interval

You can set the FAX/MFC to print activity reports at specific intervals (6, 12, 24 hours, 2, 4 or 7 days). If you set the interval to OFF, you can print the report by following the steps in the previous section.

- 1 Press **Function/Set, 7, 2.**
- 2 Press  or  to display:  and press **Function/Set.**
- 3 Press  or  to choose your setting and press **Function/Set.** If you choose 7 days, the screen prompts you to choose a day at which to begin the 7-day countdown.
- 4 Enter the time, in 24-hour format, that printing will begin and press **Function/Set.** (For example, enter 19:45 for 7:45 PM)
- 5 Press **Stop** to exit.



# 12 Important Information

## Standard Telephone and FCC Notices

---

**These notices are in effect on models sold and used in the United States only.**

**This equipment is hearing aid and volume control compatible.**

**When programming emergency numbers and/or making test calls to emergency numbers:**

- Before you hang up, briefly explain to the dispatcher the reason for the call.
- Perform such activities in the off-peak hours, such as early morning or late evening.

This equipment complies with Part 68 of FCC Rules. On the rear panel of this equipment is a label that contains, among other information, the FCC Registration Number and Ringer Equivalence Number (REN) for this equipment. You must, upon request, provide this information to your telephone company.

You may safely connect this equipment to the telephone line by means of a standard modular jack, USOC RJ11C.

An FCC compliant telephone cord with a modular plug is provided with this equipment. This equipment is designed to be connected to the telephone line or premise's wiring using a compatible modular jack that is Part 68 compliant. See the Installation section of this manual for details.

The REN is useful to determine the quantity of devices you may connect to your telephone line and still have those devices ring when your telephone number is called. In most, but not all areas, the sum of the RENs of all devices connected to one line should not exceed five (5). To be certain of the number of devices you may connect to your line, as determined by the REN, you should contact your local telephone company to determine the maximum REN for your calling area. If your fax damages the telephone line, the telephone company may discontinue your service temporarily. If possible, they will notify you in advance. But if advance notice is not practical, you will be notified as soon as possible. You will be informed of your right to file a complaint with the FCC.

Your telephone company may make changes to its facilities, equipment, operations or procedures that could affect the proper functioning of your equipment. If they do, you will be notified in advance to give you an opportunity to maintain uninterrupted telephone service.

If you experience trouble with this product, please contact a Brother Authorized Service Center for information on obtaining service or repair. The telephone company may ask that you disconnect this equipment from the line until the problem has been corrected or until you are sure that the equipment is not malfunctioning.

If you are not able to solve a problem with your machine, contact Brother Customer Service. (See *Brother Numbers*, page i.)

## **International Energy Star Compliance Statement**

The purpose of the International Energy Star Program is to promote the development and popularization of energy-efficient office equipment, which includes computers, monitors, printers, facsimile receivers and copy machines world-wide. As an International Energy Star partner, Brother Industries, Ltd. has decided that this product meets the guideline of the program.



## **Industry Canada Compliance Statement (For Canada Only)**

This Class B digital apparatus meets all requirements of the Canadian Interference-Causing Equipment Regulations.

Cet appareil numérique de la classe B respecte toutes les exigences du Règlement sur la matériel brouilleur du Canada.

## **Federal Communications Commission Compliance Notice (For USA Only)**

This equipment has been tested and found to comply with the limits for a Class B digital device, pursuant to Part 15 of the FCC Rules. These limits are designed to provide reasonable protection against harmful interference in a residential installation. This equipment generates, uses, and can radiate radio frequency energy and, if not installed and used in accordance with the instructions, may cause harmful interference to radio communications. However, there is no guarantee that interference will not occur in a particular installation. If this equipment does cause harmful interference to radio or television reception, which can be determined by turning the equipment off and on, the user is encouraged to try to correct the interference by one or more of the following measures:

- Reorient or relocate the receiving antenna.
- Increase the separation between the fax equipment and the receiver.
- Connect the fax equipment on a separate circuit.
- Consult the dealer or an experienced radio/TV technician for help.



## **WARNING**

For protection against the risk of electrical shock, always disconnect all cables from the wall outlet before servicing, modifying or installing the equipment.

This equipment may not be used on coin service lines provided by the telephone company or connected to party lines.

Brother cannot accept any financial or other responsibilities that may be the result of your use of this information, including direct, special or consequential damages. There are no warranties extended or granted by this document.

### **Important Safety Instructions**

- 1** Read all of these instructions and save them for future use.
- 2** Follow all warnings and instructions marked on the product.
- 3** Unplug this product from the wall outlet before cleaning. Do not use liquid or aerosol cleaners. Use a damp cloth for cleaning.
- 4** Do not use this product near water.
- 5** Do not place this product on an unstable cart, stand, or table. The product may fall, causing serious damage to the product.
- 6** Slots and openings in the cabinet and the back or bottom of the machine are provided for ventilation; to ensure reliable operation of the product and to protect it from overheating, these openings must not be blocked or covered. The openings should never be blocked by placing the product on a bed, sofa, rug, or other similar surface. This product should never be placed near or over a radiator or heater. This product should never be placed in a built-in installation unless proper ventilation is provided.
- 7** This product should be operated from the type of power source indicated on the label. If you are not sure of the type of power available, consult with your dealer or local power company.
- 8** This product is equipped with a 3-wire grounding type plug. This plug will fit into only a grounding-type power outlet. This is a safety feature. If you are unable to insert the plug into the outlet, contact your electrician to replace your obsolete outlet. Do not defeat the purpose of the grounding-type plug.
- 9** Do not allow anything to rest on the power cord. Do not place this product where people can walk on the cord.
- 10** If an extension cord is used with this product, make sure that the total ampere ratings on the products plugged into the extension cord do not exceed ampere rating of the extension cord ampere rating. Also, make sure that the total of all products plugged into the wall outlet does not exceed 15 amperes (USA only).
- 11** Do not place anything in front of the fax machine that will block the exit-path of sent documents, originals and received faxes.
- 12** Do not touch an original during printing.

- 13** Never push objects of any kind into this product through cabinet slots, because they may touch dangerous voltage points or short out parts resulting in a risk of fire or electric shock. Never spill liquid of any kind on the product.
- 14** Do not attempt to service this product yourself, as opening or removing covers may expose you to dangerous voltage points and/or other risks, and may void your warranty. Refer all servicing to a Brother Authorized Service Center. A list of Brother Authorized Service Centers has been included for your convenience, or you may contact the Brother Customer Service for your nearest Brother Authorized Service Center. (See *Brother Numbers*, page i.)
- 15** Unplug this product from the wall outlet and refer servicing to a Brother Authorized Service Center under the following conditions:
- A** When the power cord is damaged or frayed.
  - B** If liquid has been spilled into the product.
  - C** If the product has been exposed to rain or water.
  - D** If the product does not operate normally when the operating instructions are followed. Adjust only those controls that are covered by the operating instructions. Improper adjustment of other controls may result in damage and will often require extensive work by a qualified technician to restore the product to normal operation.
  - E** If the product has been dropped or the cabinet has been damaged.
  - F** If the product exhibits a distinct change in performance, indicating a need for service.
- 16** To protect your product against power surges, we recommend the use of a power protection device (Surge Protector).

# 13 Troubleshooting and Routine Maintenance

## Troubleshooting

---

If you can't resolve a difficulty with your FAX/MFC using this manual, please see page i for *Brother Numbers* to call for assistance.

### Error Messages

You may occasionally encounter a difficulty with your FAX/MFC or telephone line. If this happens, your FAX/MFC often identifies the problem and displays an error message. The list below explains the most common error messages.

If you need additional help, call the Brother fax-back system. (See *Brother Numbers*, page i.)

CHANGE CARTRIDGE

The ribbon is used up and printing is not possible. Replace the ribbon or the ribbon cartridge with a new one. (See *Replacing the Print Cartridge*, page 13-8.)

CHECK PAPER

PRESS START KEY

The FAX/MFC is out of paper, or the paper is not properly loaded. After you load paper, press **Start** key.

CHECK PAPER

The paper is jammed in the fax machine.

- 1 Remove any paper that is not jammed.

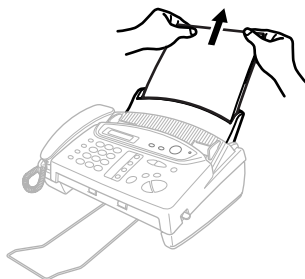

- 2** Open the top cover by lifting the gray lever on the right side of the top cover.

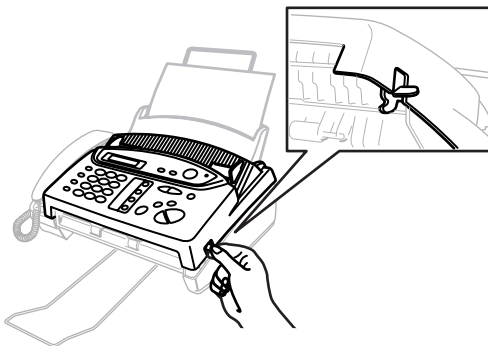

Top Cover

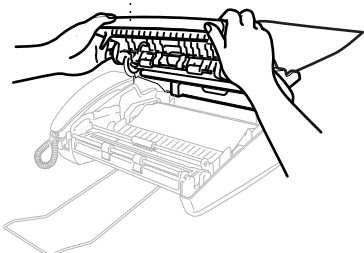

- 3** Pull the jammed printout gently from the paper tray toward the *front* of the machine. If the printout is jammed, then pull it toward the *back* of the machine.

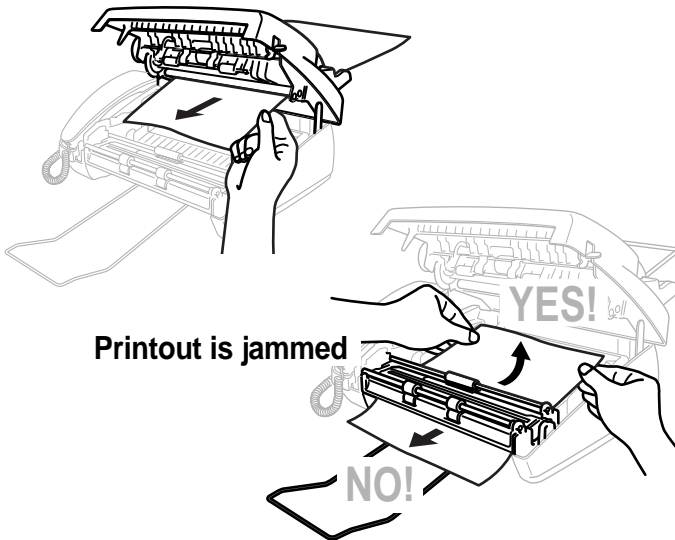

- 4 Remove the print cartridge and turn the spool to tighten the ribbon.
- 5 Install the cartridge. (See page 13-8.)
- 6 Close the top cover.
- 7 Load the paper.

COMM.ERROR

A poor quality phone line resulted in a communications error. Try the call again.

CONNECTION FAIL

You have requested a polling call from another party, but the other fax machine is not in Poll Waiting mode.

DISCONNECTED

The other party has disconnected during a fax. Try calling the other party.

DOCUMENT JAM

The documents were not inserted or fed properly, or were too long or too short.

- 1 Remove any paper that is not jammed from the ADF.
- 2 Open the top cover.
- 3 Pull the original toward the *front* of the machine.
- 4 Close the cover.

**Original is jammed**

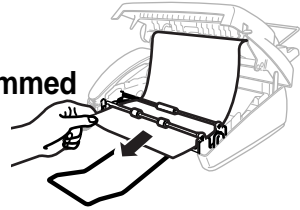

MACHINE ERROR XX  
PRESS STOP KEY

Contact Brother Customer Service at:

**USA:** 1-800-284-4329 (voice)  
**From within Canada:** 1-800-853-6660 (voice)  
**From within Montreal:** 1-514-685-6464 (voice)

NO RESPONSE/BUSY

The number you called does not answer or is busy. You may also have reached a number not connected to a fax. Check the number and call again.

NOT REGISTERED

You've tried accessing a One Touch or Speed Dial location with no number assigned to it. See pages 7-1 to 7-2 for information about storing One Touch or Speed Dial numbers.

PRINTER FAULT

The print head has overheated. Unplug the FAX/MFC and wait 30 minutes for it to cool.

TOP COVER OPEN

The top cover is not closed completely.

## If You Are Having Difficulty with Your FAX/MFC

If you think there is a problem with your FAX/MFC, make a *copy* first. If the copy looks good, the problem is probably not your FAX/MFC. Check the difficulties below and follow the troubleshooting tips.

### Printing or Receiving Faxes

#### **Condensed Print and Horizontal Streaks; Top and Bottom of Sentences Cut Off**

If your copy looks good, you probably had a bad connection, with static or interference on the phone line. If the copy looks bad, call Brother Customer Service at 1-800-284-4329 (USA), 1-800-853-6660 (from within Canada) or 1-514-685-6464 (from within Montreal).

#### **Vertical Black Lines When Receiving**

The sender's scanner may be dirty. Ask the sender to make a copy to see if the problem is with the sending machine. Try receiving from another fax machine. If the problem continues, call Brother Customer Service at 1-800-284-4329 (USA), 1-800-853-6660 (from within Canada) or 1-514-685-6464 (from within Montreal).

### Phone Line or Connections

#### **FAX/MFC Does Not Answer When Called**

Make sure the FAX/MFC is in the correct receiving mode for your setup (either FAX, FAX/TEL or TAD). Check for dial tone. If possible, call your FAX/MFC to hear it answer. If there is still no answer, check the telephone line cord connection. (See *Connecting the Machine*, page 2-4 and *Connect the telephone line*.) Connect a *standard* telephone handset to the FAX/MFC telephone jack. If there is no ringing when you call your FAX/MFC, call your Telephone Company to check the line.



### **Telephone Answering Device (TAD) Does Not Answer When Called**

Connect the telephone line cord from your TAD to the back of the FAX/MFC, in the jack labeled EXT. Make sure the TAD is set to answer calls. (See *Connecting an External Telephone Answering Device (TAD)*, page 2-8.)

### **No Dial Tone on the Handset**

Press **Speaker Phone**—**OR**—Lift the handset. If you don't hear a dial tone, check telephone line cord connections at the FAX/MFC and wall jack. Check that the handset is connected to the FAX/MFC's handset jack. Test the wall jack with another single line telephone. If there is no dial tone at the wall outlet, call your Telephone Company.

### **The Caller ID does not display after the Call Waiting Signal**

The Caller ID signal is sent ten seconds after the Call Waiting Signal and speaking may interfere with it. When you hear the Call Waiting signal, ask the other party to hold while you answer the call. Then stop speaking until you see the Caller ID on the LCD.

## **Sending Faxes**

### **Poor Transmitting Quality**

Try changing your resolution to FINE or SUPERFINE. (See *Resolution*, page 6-3.) Make a copy to verify the FAX/MFC's scanner operation.

### **Dialing Does Not Work**

Check all line cord connections, and make sure the curled handset cord is not in the **EXT** jack.

Check power cord connection.

Send a manual fax by pressing **Speaker Phone**—**OR**—Lifting the handset, and dialing the number. Wait to hear fax receiving tones before pressing **Start**.

### **Vertical Black Lines When Sending**

Use your FAX/MFC to make a copy. If the copy shows the same problem, the scanner area is dirty. Lift the top cover and check the original path. Clean the scanner's white tape and the glass strip under the tape using isopropyl alcohol and a lint-free cloth. (See page 13-7.)

## Handling Incoming Calls

### Double Ring in FAX/TEL Mode

The FAX/MFC knows the incoming call is not a fax so it is signaling you to answer the telephone call. Pick up the FAX/MFC handset or answer from an extension phone and press your FAX/MFC's Telephone Answer Code (default setting is #51). (See *For FAX/TEL Mode Only*, page 5-6.)

### Transferring a Call to the FAX/MFC

If you have answered the FAX/MFC handset, press **Start**, and hang up immediately.

If you answered at an extension phone, press your three-digit Fax Receive Code (the factory setting is ✕51). When your FAX/MFC answers, hang up.

### FAX/MFC "Hears" Voice as CNG Tone

If your FAX/MFC is set to Easy Receive ON, and it answers voice calls by trying to receive a fax, try turning Easy Receive to OFF. (See *Easy Receive*, page 5-4.)

### Transmission Verification Report Prints "Result: NG"

There is probably temporary noise or static on the phone line. Try sending the fax again. If the problem continues, call the Telephone Company to check your phone line.

### Custom Features on a Single Line

If you have Call Waiting, Caller ID, Call Waiting/Caller ID, Ring Master, Voice Mail, an answering machine, alarm system or any other custom feature on a single phone line with your FAX/MFC, it may create a problem sending or receiving fax data.

#### Example #1:

If you are having a telephone conversation and a fax communication signal comes through on your Call Waiting Caller ID feature, you can verify that the second call is a fax by switching to it. You have the option to receive the fax call, by asking the first caller to hang up to clear the line.

#### Example #2:

If you are sending or receiving a fax message while a Call Waiting Caller ID (or other custom feature) signal comes through on the line, the signal can temporarily interrupt or disrupt the fax data. Brother's ECM feature should help overcome this problem. This condition is related to the telephone system industry, and is common to all devices that send and receive information on a single, shared line with custom features. If avoiding a slight interruption is crucial to your business, a separate line with no custom features is recommended.

# Routine Maintenance

---

## Cleaning the Scanner

Before cleaning, unplug the power cord for safety. Clean the white bar and the glass strip under the bar with isopropyl alcohol on a lint-free cloth. Be careful not to bend the spring plate or drop anything into the FAX/MFC.

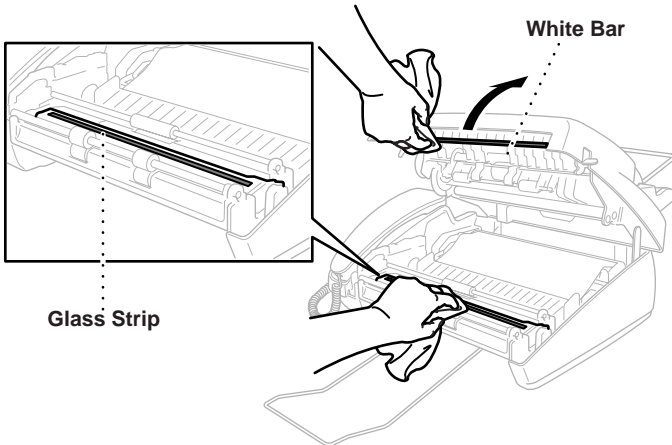

## Cleaning the Print Head

Before cleaning, unplug the power cord for safety. To clean the FAX/MFC print head, wipe the print head with a lint-free cloth that is dry or lightly moistened with isopropyl alcohol.

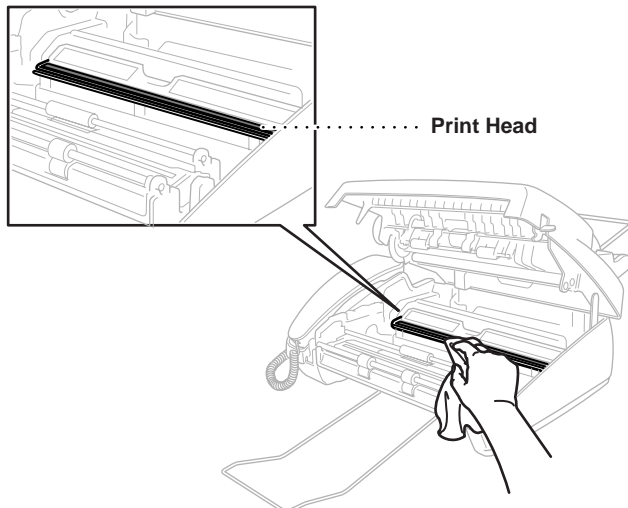



## **WARNING**

Just after you have used the machine, the print head is extremely **HOT!**

### **Replacing the Print Cartridge**

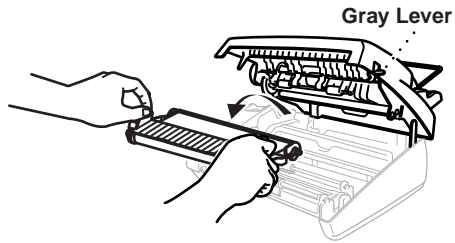
- 1** Open the top cover by lifting the gray lever on the right side of the top cover. (See page 13-2.)
- 2** Remove the print cartridge containing the used ribbon and set it down.



- 3** Install the new print cartridge, by first inserting the recessed  and placing the cartridge into its four holders.

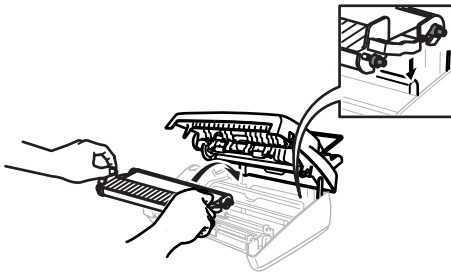
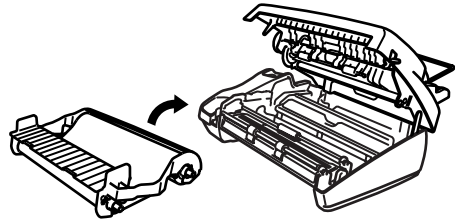

- 4** Press down on both sides of the top cover to close it securely.



You can save money by purchasing the 2-PK Refill Ribbon Rolls (PC402RF). (Installation instructions will be included.) If you handle the print cartridge (frame) carefully, you can reuse it until it breaks.

# 14 Setting Up the MFC 660MC and Computer to Work Together

## Before You Install Multi-Function Link<sup>®</sup>

---

This chapter takes you through each step of the installation process. Read it carefully to ensure a problem-free installation.

### Package Contents

Before you begin the Multi-Function Link<sup>®</sup> installation, please check the contents of your package:

- Brother CD-ROM
- Multi-Function Link<sup>®</sup> Cable and PC I/F Box
- Warranty, Upgrade and Licensing Materials

### PC Configuration Requirements

Your PC must meet or exceed the following minimum system configuration requirements for you to install and use Multi-Function Link<sup>®</sup>:

CPU	80486/66 or higher
RAM	8MB or greater for Windows <sup>®</sup> 3.1 x 8MB or greater for Windows <sup>®</sup> 95 (16MB recommended) 16MB or greater for Windows NT <sup>®</sup> Workstation Version 4.0 (32MB recommended) 24MB or greater for windows <sup>®</sup> 98 Second Edition (32MB recommended)
Hard Disk Drive	50MB
Operating System Port	Windows <sup>®</sup> 3.1x, 95, 98, 98 Second Edition or NT <sup>®</sup> Workstation Version 4.0 Available Serial port
CD-ROM Drive	

## Connecting the MFC 660MC to Your PC

Follow the instructions below to hook up the Multi-Function Link<sup>®</sup> Cable:

- 1** Position your Brother MFC near your personal computer CPU (maximum distance of approximately 5–6 feet).
- 2** Make sure to unplug the machine's power cord from the electrical outlet before connecting the Multi-Function Link<sup>®</sup> cable. Also, make sure the computer is turned off and unplugged from the electrical power before you connect the Multi-Function Link<sup>®</sup> cable.
- 3** Connect the RJ-8 connector of the Multi-Function Link<sup>®</sup> Cable to the back of your Brother MFC in the jack labeled *PC I/F*.
- 4** Connect the 25-pin *male* RS-232 connector of the Multi-Function Link<sup>®</sup> Cable to your PC in the available *female* serial communications port. Use the 9-pin adapter if your PC requires it. (See your PC owner's manual for the correct interface port for connection.) **NOTE: If your PC is an IBM Aptiva, an MWAVE card is using COM1. You must connect the Multi-Function Link<sup>®</sup> Cable to another COM serial port that is available.**

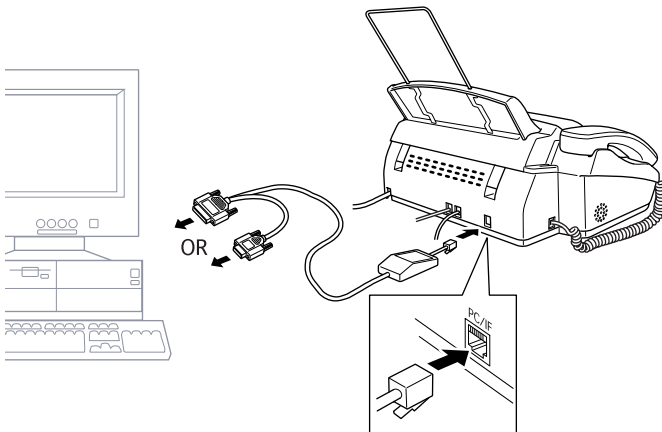

## Choosing the Software to Install



### Install Multi-Function Link<sup>®</sup> Software

Click on Install Multi-function Link<sup>®</sup> Software to access the Software Installation window.

### On-Line Documentation

On-Line Documentation includes all the software instructions. To view the On-Line Documentation, you must first install the Acrobat Reader software from the CD-ROM, by clicking on the Install Acrobat Reader button.

### Product Support

This is a page of all Brother support numbers.

### Brother Web Link

Brother WEB Link connects you to the Internet Brother Home Page on the World Wide Web. You can find more information about Brother products, from product specifications sheets to Frequently Asked Questions (FAQ's). You must have service with an Internet service provider.

Click **Exit** to exit the CD-ROM window, or click **Return** to return to the previous window.

# Installing the Multi-Function Link<sup>®</sup> Software

## IMPORTANT

To install the software using Windows NT<sup>®</sup> Workstation Version 4.0, you must be logged on as the Administrator.

Make sure your MFC 660MC is connected to your PC as described earlier and that both machines are plugged in and switched on.

## Overview of Basic Steps

- 1 Insert the Brother CD-ROM into your CD-ROM drive and access the Installation Window.
- 2 Enter the command for your version of Windows<sup>®</sup>, if needed.
- 3 Select the option *Install Multi-Function Link<sup>®</sup> Software*.
- 4 Follow the installation instructions.

## Installing the Brother Software

- 1 Insert the Brother CD-ROM into your CD-ROM drive.
- 2 After you insert the Brother CD-ROM, you must type the appropriate command for your version of Windows<sup>®</sup>, if needed:
  - If you are using Windows<sup>®</sup> 3.1x, from the Program Manager: Click *File*, then *Run*, then type *x:SETUP.EXE*. (“x” is the drive letter for your CD-ROM drive.) This will start the Software Installation program.
  - If you are using Windows<sup>®</sup> 95/98 or Windows NT<sup>®</sup> Workstation Version 4.0, the Software Installation program appears automatically when you insert the Brother CD-ROM.
  - For Windows<sup>®</sup> 95/98 and Windows NT<sup>®</sup> Workstation Version 4.0, you can also click *Start* at the Desktop, select *Run* and then enter *x:\SETUP.EXE*. (“x” is the drive letter for your CD-ROM drive.)

The Brother LOGO will be displayed on the screen.



🔍 If you are using Windows NT® 3.51 or earlier, the following error message will appear on the screen:

*You are running Windows NT® 3.51 or earlier. Brother Multi-Function Link® Software does not support this version of Windows NT®. YOU MUST UPGRADE TO WINDOWS NT 4.0 AND REINSTALL Multi-Function Link® Software!!*

🔍 If you are using Windows NT® Workstation 4.0 and you are not logged-in as the Administrator, an error message will appear explaining the problem.

A window appears listing the options:



- If you are using Windows® 98, the OS detected is shown as “Windows® 95”.

**3** Click on “Install Multi-Function Link® Software” and follow the prompts on the screen.

The last step will be to restart Windows®.

## Viewing On-Line Documentation

---



Make sure you have installed the Acrobat Reader software. (Click on the Install Acrobat Reader button and follow the instructions on the screen.)

After the Acrobat Reader is installed, click on the View Multi-Function Link<sup>®</sup> Documentation button. When the Table of Contents appears, select a chapter by clicking on it.



Since the Multi-Function Link<sup>®</sup> manual is in On-line Documentation only, you may wish to print a copy by selecting Print from the File pull-down menu.

# 15 Using the Multi-Function Link<sup>®</sup> Software

(For MFC 660MC Only)

## Introduction

This chapter outlines the basics of the Brother software, so you can get started using the Multi-function Link<sup>®</sup> software. Detailed installation and setup instructions are in the On-Line Documentation section of the Brother CD-ROM that is included with your MFC. Be sure to check the online ReadMe file for last-minute, important information that was not included in the On-Line Documentation.

## Running the Brother Software

The software included with your MFC consists of two parts, the Multi-function Link<sup>®</sup> and ScanSoft<sup>™</sup> PaperPort<sup>®</sup> for Brother.

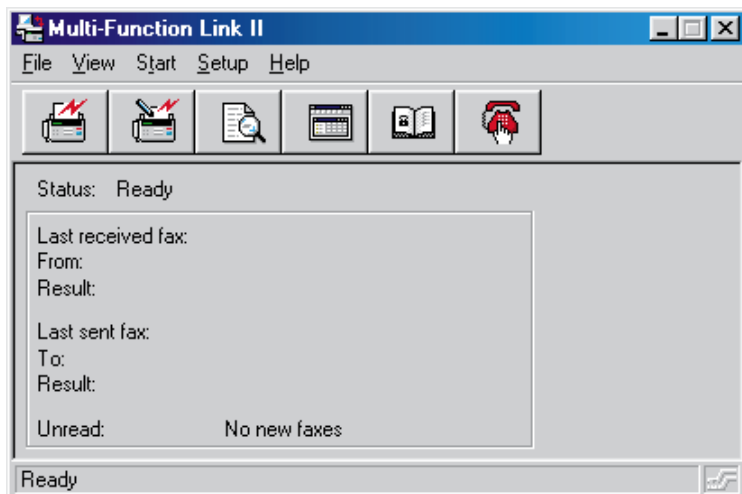

## Multi-Function Link®

The Multi-Function Link® Main Menu is the application used for all fax sending and receiving operations. It also contains an electronic Phone Book program and a Log Manager that maintains a record of all PC fax transactions. The Main Menu can be accessed through the Brother Multi-Function Link® program group.

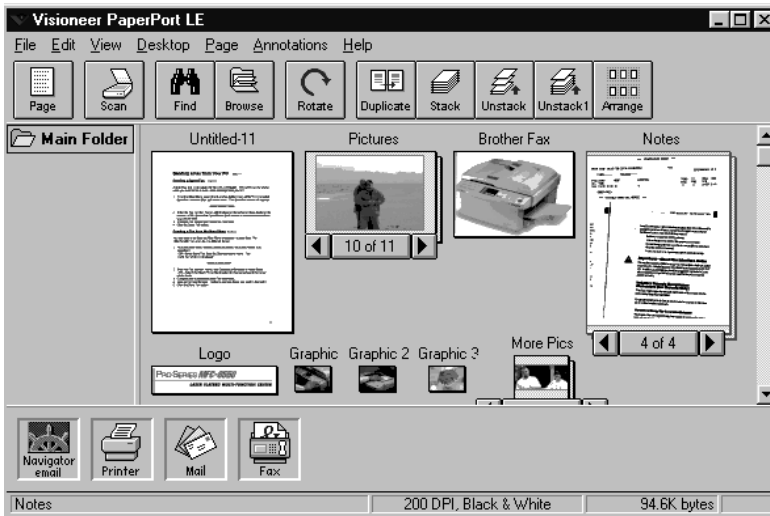

## ScanSoft™ PaperPort®

ScanSoft™ PaperPort® for Brother is a document management application. You will use PaperPort® to view incoming faxes and scanned documents. PaperPort® has a sophisticated, yet easy to use filing system that will help you organize your documents. It allows you to combine or “stack” documents of different formats for printing, faxing, or filing. PaperPort® can be accessed through the PaperPort® program group.

# ***Sending a Fax from Your PC***

---

## **Sending a Quick Fax**

A QuickFax is a cover page only fax with a message. This option is very useful when you want to fax a quick, short message from your PC.

- 1 From the Main Menu, select the QuickFax button  or select QuickFax from the Start pull-down menu. The QuickFax screen will appear:

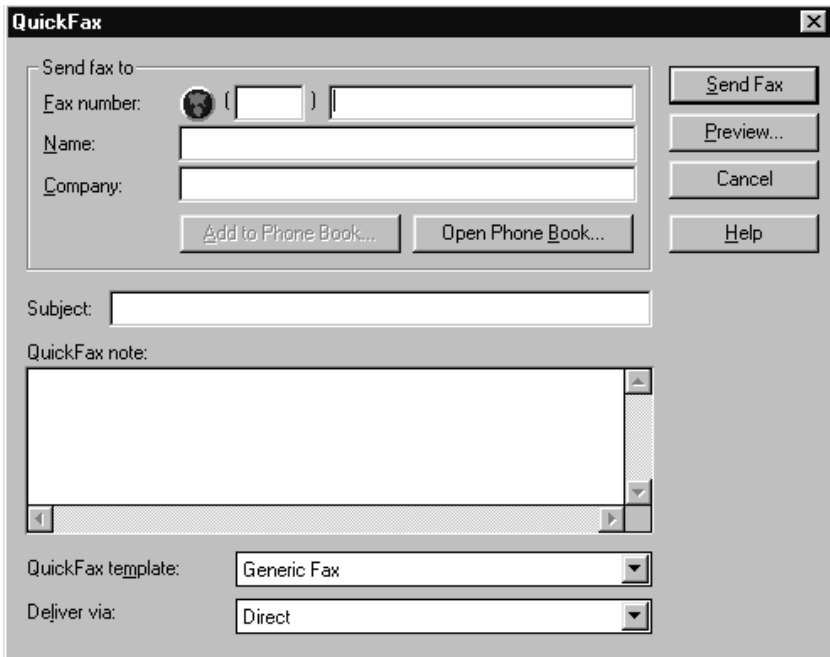

QuickFax

Send fax to:

Fax number:  (  )

Name:

Company:

Subject:

QuickFax note:

QuickFax template:

Deliver via:

- 2 Enter the Fax number, Name, and Company information in these fields on the screen—**OR**—Select the Open Phone Book... button to choose someone from your phone book.
- 3 Complete the Subject and QuickFax note fields.
- 4 Click the Send Fax button.

## Sending a Fax from the Main Menu

You can send a fax from the Main Menu and attach multiple files. The “attachments” can even be in a different formats.

- 1 From the Main Menu window, select the Send Fax —OR—Select Send Fax from the Start pull-down menu. The Send Fax window will appear:

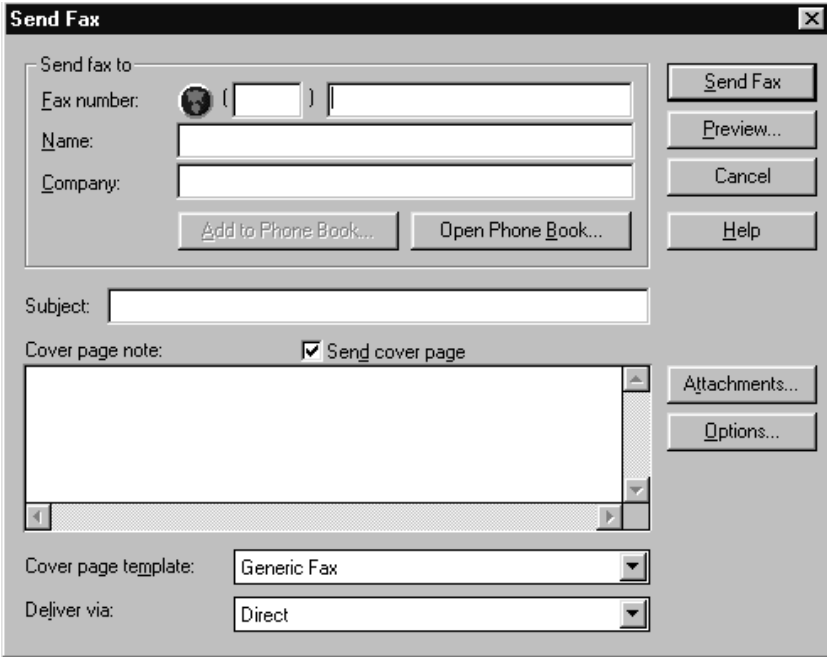

The image shows a 'Send Fax' dialog box with the following fields and buttons:

- Send fax to:** A group box containing:
  - Fax number:** A text field with a globe icon and a small empty box before the main input field.
  - Name:** A text field.
  - Company:** A text field.
  - Buttons:** 'Add to Phone Book...' and 'Open Phone Book...'.
- Subject:** A text field.
- Cover page note:** A text area with a checked checkbox labeled 'Send cover page'.
- Attachments:** A button labeled 'Attachments...'.
- Options:** A button labeled 'Options...'.
- Send Fax:** A button.
- Preview...:** A button.
- Cancel:** A button.
- Help:** A button.
- Cover page template:** A dropdown menu with 'Generic Fax' selected.
- Deliver via:** A dropdown menu with 'Direct' selected.

- 2 Enter the Fax number, Name, and Company information in these fields  
—OR—Select the Open Phone Book button to choose someone from your phone book.
- 3 Complete the Subject and Cover page note fields.
- 4 Click on the Attachments... button to add any file(s) you want to send with it.
- 5 Click the Send Fax button.

## Sending a Fax from a Windows® Application

You can send a fax directly from any Windows® application using the following steps:

- 1 Create the document in a Windows® application.
- 2 Select Brother MFL Fax as your printer.

- 3 Select the Print command to begin the fax transmission.

The Fax Sending dialog box will appear:

Send Fax

Send fax to:

Fax number: ( )

Name:

Company:

Add to Phone Book... Open Phone Book...

Send Fax Preview... Cancel Help

Subject:

Cover page note:  Send cover page

Attachments... Options...

Cover page template: Generic Fax

Deliver via: Direct

- 4 Enter the name and fax number of the recipient or select the Open Phone Book... button and choose a name. Select Close to return to the Send Fax dialog box.
- 5 Select the Send cover page check box to include a cover page.
- 6 Select the Send Fax button.

## Receiving Faxes into the PC



To receive faxes into your PC through the MFC, you must first connect your MFC to your computer. Then, you can load the software.

### Before You Begin

Use the following checklists for the MFC and PC, to make sure you have properly set up the MFC and PC to work together.

#### Checklist for the MFC:

The default setting for MF Link mode is PC PRIMARY. In this setting all faxes will be routed into the PC unless it is not turned on. If the PC is turned off, incoming faxes will be printed on the MFC.

- 1 To make sure the MF Link mode is set to PC PRIMARY, press **Function/Set, 2, 8**.
- 2 Use  or  to select PC PRIMARY (or PC RECEIVE ONLY or FAX RECEIVE ONLY).
- 3 Press **Function/Set**.
- 4 Press **Stop** to exit.

### On your PC:

- 1 In the Main Menu, select the Setup pull-down menu.
- 2 Select Preferences...
- 3 Under Answer Mode, select Fax only.
- 4 Click the OK button.
- 5 Make sure the MFC is connected to the PC.
- 6 Keep the PC and the Multi-function Link<sup>®</sup> Main Menu running at all times.

## Viewing Received Faxes

Faxes that are received into the PC will appear in the InBox of the Log Manager. To access the Log Manager, from the Main Menu click the Log Manager button .

—OR—From the Start pull-down menu, select Mail/Log.

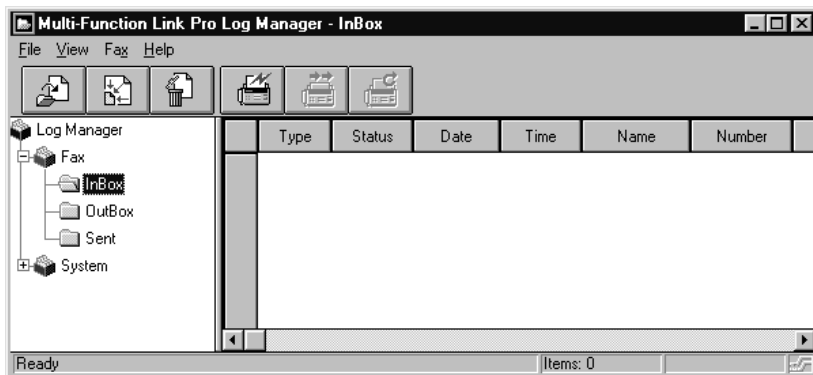

- 1 In the Log Manager, select the Fax folder.
- 2 Then select the InBox folder. A listing of your incoming messages will appear on the right side of the window.
- 3 Double-click on the fax you wish to view.

The ScanSoft PaperPort Viewer will run automatically and the fax you selected from the list will be displayed.



# Scanning a Document

The Brother Multi-function Link<sup>®</sup> software includes a TWAIN compliant scanner driver. TWAIN drivers meet the standard universal protocol for communicating between scanners and software applications. This means that not only can you scan images directly into the PaperPort viewer that Brother included with your MFC, but you can also scan images directly into hundreds of other software applications that support TWAIN scanning. These applications include popular programs like Adobe Photoshop, Adobe Pagemaker, Corel Draw and many more.

To choose the Brother Multi-function Link<sup>®</sup> as your scanner driver, select it under the “Select scanner” or “Select source” option in your software.

## Scanning Options

When you scan using the Brother Multi-function Link<sup>®</sup> Scanner driver, a scanning options dialog box will appear:

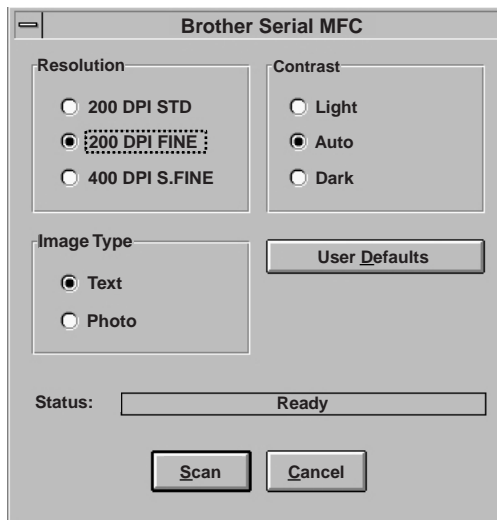

Set the following options based on each document to be scanned, then click the SCAN button to start scanning.

### Resolution

You can choose one of three resolutions, 200 DPI STD, 200 DPI FINE, or 400 DPI S.FINE. The higher the number of dpi (dots per inch), the clearer the image will appear on your PC. However, the size of the image file increases with the dpi. Try scanning at different resolutions to determine the best resolution for your needs.

## Contrast

To have the scanner adjust the contrast automatically, choose Auto. If your original is too light, set the contrast to Light. If the original is too dark, set the contrast to Dark.

## Image Type

If you are scanning text or black and white line art, choose Text as the image type. If you're scanning a photo or detailed picture with many different colors, choose Photo as the image type.

## Scanning into the PaperPort® Viewer

To scan into the PaperPort® viewer that was provided with your MFC, run the PaperPort® viewer program and then select the SCAN button on the top of the screen



or select ACQUIRE from the File pull-down menu.

# **16** Multi-Function Link<sup>®</sup> (option)

**(For FAX 580MC Only)**

If you have a FAX 580MC, you can purchase the optional Multi-function Link<sup>®</sup> package (also called “Missing Link”). Multi-Function Link turns your fax machine into a multifunction center, by enabling you to use your fax machine as a printer and a scanner and to use it to fax messages from Windows applications in your computer.

Multi-function Link<sup>®</sup> is available at most Brother retailers. If you cannot find it, you can order Multi-function Link<sup>®</sup> directly from Brother. The item number is PCI-1.

Installation instructions will be included with PCI-1. However, it is important that you hook up your fax machine to your computer before you install the software.

# Specifications

<b>Type</b>	Desktop facsimile transceiver
<b>Compatibility</b>	ITU-T Group 3
<b>Coding System</b>	Modified Huffman (MH)
<b>Modem Speed</b>	14400/12000/9600/7200/4800/2400; Automatic Fallback
<b>Original Input Width</b>	5.8 inches to 8.5 inches (148 mm to 216 mm)
<b>Scanning/Printing Width</b>	8.2 inches (208 mm)
<b>Paper Tray</b>	Letter: 50 Sheets; Legal: 30 Sheets
<b>Printer Type</b>	Line Thermal with Ribbon
<b>Gray Scale</b>	64 levels (Dithered)
<b>Display</b>	LCD, 16 characters
<b>Polling Types</b>	Standard, Sequential
<b>Contrast Control</b>	Automatic/Super Light/Super Dark (manual setting)
<b>Resolution</b>	<ul style="list-style-type: none"><li>• Horizontal 203 dot/inch (8 dot/mm)</li><li>• Vertical Standard—98 line/inch (3.85 line/mm) Fine, Photo—196 line/inch (7.7 line/mm) Superfine, Photo (copy)—392 line/inch (15.4 line/mm)</li></ul>
<b>Memory Capacity</b>	512 KB (up to 25 pages*)
<b>One Touch Dial</b>	4
<b>Speed Dial</b>	50 stations
<b>Automatic Redial</b>	3 times at 5 minute intervals
<b>Speaker Type</b>	Full Duplex, Digital
<b>Auto Answer</b>	0, 1, 2, 3 or 4 rings
<b>Communication Source</b>	Public switched telephone network
<b>Operating Environment</b>	41 - 95° F
<b>Power Source</b>	120V AC 50/60Hz (U.S.A., Canadian Version Only)
<b>Power Consumption</b>	Standby: under 5 watts — Peak: under 170 watts
<b>Dimensions</b>	13.1 x 11.9 x 11.1 (inches)/ 334 x 301 x 281 (mm)
<b>Weight</b>	7.5 lb / 3.4 kg

\* "Pages" refers to the ITU-T #1 chart (in Out of Paper Reception in ECM mode).  
Specifications are subject to change without prior notice.

# Index

## A

Accessories .....	ii
Activity Report .....	11-2
Alternating Displays .....	3-1
Answer Mode .....	5-1, 5-2
Answering Machine .....	2-8
AUTO DIAL LIST .....	11-1
Automatic Transmission .....	6-2

## B

Beeper Volume .....	4-4
Broadcasting .....	7-6
Broadcasting (Set Up Groups) .....	7-3
Brother Numbers .....	i

## C

CALL PICKUP .....	8-2
Call Waiting Caller ID .....	8-5
Caller ID .....	8-2
Caller ID (Printing Log) .....	8-3
Caller ID (Viewing Log) .....	8-3
CallManage .....	8-5
Canceling Job .....	6-5
Chain Dialing .....	7-2
CHECK PAPER .....	13-1
COMM. ERROR .....	13-3
Connect (External Telephone Answering Machine) .....	2-8
Connect (External Telephone) .....	2-9
Connect (Power Cord) .....	2-4
Connect (Telephone Line) .....	2-4
CONNECTION FAIL .....	13-3
Contrast .....	6-3
Control Panel .....	1-3
COPY (Enlarging) .....	10-1

COPY (Multiple) .....	10-1
COPY (Reducing) .....	10-1
COPY (Sorted) .....	10-1
COPY (Stacked) .....	10-1
Corrections (Entering Text) .....	4-2
Customer Service .....	i

## D

Date and Time .....	4-1
Delayed Fax .....	6-4
Dialing Mode .....	4-2
Dialing Options .....	7-4
Disclaimer & Warranties .....	iii
DISCONNECTED .....	13-3
Distinctive Ring .....	8-1
DOCUMENT JAM .....	13-3
Documents (Size) .....	6-1

## E

Easy Receive .....	5-4
ECM (Error Correction Mode) .....	1-2
Entering Text .....	4-2
External Telephone .....	2-9
External Telephone Answering Device .....	2-8

## F

F/T (FAX/TEL) Mode .....	5-1
F/T Ring Time .....	5-3
FAX ONLY Mode .....	5-1
Fax Receive Code .....	5-6
Fax Tones and Handshake .....	1-2
fax-back system .....	i
Fine (Resolution) .....	6-3
Frequently Asked Questions (FAQs) .....	i
Function Mode .....	3-1
Function Selection Table .....	3-2

## G

Gray Scale .....S-1

## H

Handset Volume .....4-4

Help .....1-1

Hold .....1-3, 7-7

## I

Inserting Spaces .....4-2

International Calls .....6-4

Interrupting .....6-5

## M

Maintenance .....13-7

Manual Dialing .....7-4

MANUAL Mode .....5-1

Manual Transmission .....6-2

MEMORY STATUS LIST .....11-1

Memory Storage .....4-5

Memory Transmission .....6-2

Multi-Line Connections .....2-7

## O

One Touch Dial (Changing) .....7-3

One Touch Dial (Storing) .....7-1

One Touch Dialing .....7-4

On-Line Documentation .....14-5

On-Screen Programming .....3-1

Outgoing Message (External TAD) .....2-9

Overseas Mode .....6-4

## P

Paper Size .....5-5

Pause .....7-7

PBX .....2-7

Photo (Resolution) .....6-3

Polled Transmit .....6-5

Polling (Receive) .....5-7

Power Consumption .....S-1

Print (a fax in memory) .....9-4

Print (Caller ID Log) .....8-3

Print (Report) .....11-1

Print Head (Cleaning) .....13-7

PRINTER FAULT .....13-4

Pulse (For Canada Only) .....4-2

## R

Redial (Automatic) .....6-2

Redial (Manual) .....6-2

Reduction (Printing) .....5-5

Reduction (Recommended Size) .....5-5

Resolution .....6-3

Ring Delay .....5-2

Ring Volume .....4-5

Roll Over Phone Lines .....2-5

## S

Safety Instructions .....12-3

Scanner (Cleaning) .....13-7

Scroll .....3-1

Search .....7-6

Speaker Volume .....4-5

Special characters .....4-3

Speed Dial (Changing) .....7-3

Speed Dial (Storing) .....7-2

Speed Dialing .....7-5

Standard (Resolution) .....6-3

Station ID .....4-1

Storing Telephone Numbers .....7-1

Super Fine (Resolution) .....6-3

## T

TAD .....2-8

TEL.INDEX LIST .....11-1

Telephone Answer Code .....5-6

Telephone Numbers .....7-1

Tone .....	4-2
Tone (Send Signals) .....	7-7
TOP COVER OPEN .....	13-4
Transmission Verification (Xmit) Report .....	11-2
Troubleshooting .....	13-1
Two-Line Phone System .....	2-5

## U

USER SETTINGS REPORT .....	11-1
----------------------------	------

## V

Verification (Xmit) Report .....	11-1
Volume Amplify .....	4-5





# Remote Retrieval Access Card

If you plan to retrieve voice or fax messages while away from your FAX/MFC, carrying the Remote Retrieval Access Card printed below will serve as a convenient reminder of the retrieval procedures. Simply cut out the card and fold it to fit in your wallet or organizer. Keeping it handy will help you derive the full benefit of your fax machine's forwarding, paging and remote retrieval features.

<p><b>Changing Remote Retrieval Access Code</b></p> <ol style="list-style-type: none"><li>1 Press <b>[Function]</b> <b>[3]</b> <b>[7]</b>.</li><li>2 Enter a three-digit number from 000 to 999. The * cannot be changed.</li><li>3 Press <b>[Function]</b>.</li><li>4 Press <b>[Stop]</b> to exit.</li></ol> <p><b>Remote Commands</b></p> <p><b>Listen to Voice Messages</b></p> <p>Press <b>[3]</b> <b>[1]</b>.</p> <p><i>then to</i> Repeat a message, press <b>[1]</b>.</p> <p>Skip to next message, press <b>[2]</b>.</p> <p>Stop playing the message, press <b>[3]</b>.</p> <p><b>Record a Memo</b></p> <p>Press <b>[3]</b> <b>[2]</b>.</p> <p>Wait for the beep, then speak.</p> <p><i>then to</i> Stop recording — Press <b>[3]</b>.</p>	<p><b>Erase All Messages</b></p> <p>Press <b>[3]</b> <b>[3]</b>. If you hear three beeps, all messages have not yet been played, and the system will not erase.</p> <p><b>Play/Record Outgoing Message</b></p> <p>Press <b>[3]</b> <b>[1]</b>.</p> <p><i>then to</i> Play Message Center OGM, press <b>[1]</b> <b>[1]</b>.</p> <p>Play F/T OGM, press <b>[1]</b> <b>[2]</b>.</p> <p>Record new Message Center OGM, press <b>[2]</b> <b>[1]</b>, then speak after beep. Press <b>[3]</b> to stop.</p> <p>Record new F/T OGM, press <b>[2]</b> <b>[2]</b>, then speak after beep. Press <b>[3]</b> to stop.</p>	<p><b>Change Paging/Fax Forwarding Setting</b></p> <p>Press <b>[3]</b> <b>[5]</b>.</p> <p><i>then to</i> Turn feature off, press <b>[1]</b>.</p> <p>Enter Fax Forwarding Number, press <b>[2]</b>.</p> <p>Enter Paging Number, press <b>[3]</b>.</p> <p>Program Fax Forward Number, press <b>[2]</b>. Enter the new number of the remote fax machine where you want your fax messages forwarded and then press <b>[3]</b> <b>[3]</b> <b>[1]</b>. To retrieve a Memory Status List, enter the number of the remote fax machine, and press <b>[F]</b> <b>[F]</b>.</p> <p><b>Retrieve a Fax</b></p> <p>Press <b>[3]</b> <b>[6]</b>.</p> <p><i>then to</i> Print a Memory Status List, press <b>[1]</b>, enter the number of remote fax machine, and then press <b>[F]</b> <b>[F]</b>. After the beep, hang up and wait.</p>
---	---	--

## Exit Remote Retrieval

Press **[9]** **[0]**.

**MESSAGE CENTER  
REMOTE RETRIEVAL ACCESS CARD**

## Using Remote Access Code

- 1 Dial your fax number from a fax machine using touch tone.
- 2 When your fax machine answers, immediately enter your Remote Retrieval Access Code (159 \*).
- 3 Your FAX/MFC signals the kinds of messages received:
  - 1 long beep — Fax message(s)
  - 2 long beeps — Voice message(s)
  - 3 long beeps — Fax and Voice
- 4 No beeps — No messages
- 4 After 2 short beeps, enter a command.
- 5 Press **[0]** to reset the FAX/MFC when you finish.
- 6 Hang up.

Retrieve all faxes, press **[2]**, then enter the number of remote fax machine, and then **[0]**. After the beep, hang up and wait.  
Erase all fax messages, press **[3]**.

## Check Receiving Status

- Press **[9]** **[7]**.  
*then for* Fax message, press **[1]**.  
Voice message, press **[2]**.  
1 long beep — Received message  
3 short beeps — No messages

## Change Answer Mode

- Press **[9]** **[8]**.  
*then for* Message Center, press **[1]**.  
Fax/Telephone (FTD), press **[2]**.  
Fax Only, press **[3]**.

5

6

7

# brother®

Brother International Corporation  
100 Somerset Corporate Boulevard  
P.O. Box 6911  
Bridgewater, NJ 08807-0911 USA

Brother International Corporation (Canada) Ltd.  
1 rue Hôtel de Ville,  
Dollard-des-Ormeaux, QC, CANADA H9B 3H6

**Visit us on the World Wide Web**  
**<http://www.brother.com>**

These machines are made for use in the USA or CANADA only. We can not recommend using them overseas because it may violate the Telecommunications Regulations of that country and the power requirements of your fax machine may not be compatible with the power available in foreign countries. **Using USA or CANADA models overseas is at your own risk and will void your warranty.**

LE4171001  
Printed in Malaysia

## Free Manuals Download Website

<http://myh66.com>

<http://usermanuals.us>

<http://www.somanuals.com>

<http://www.4manuals.cc>

<http://www.manual-lib.com>

<http://www.404manual.com>

<http://www.luxmanual.com>

<http://aubethermostatmanual.com>

Golf course search by state

<http://golfingnear.com>

Email search by domain

<http://emailbydomain.com>

Auto manuals search

<http://auto.somanuals.com>

TV manuals search

<http://tv.somanuals.com>