

Computerized Embroidery and Sewing Machine

Operation Manual

Product Code 885-V95/V96/V97/V98

brother

1 GETTING READY

2 SEWING BASICS

3 UTILITY STITCHES

4 EMBROIDERY

5 APPENDIX

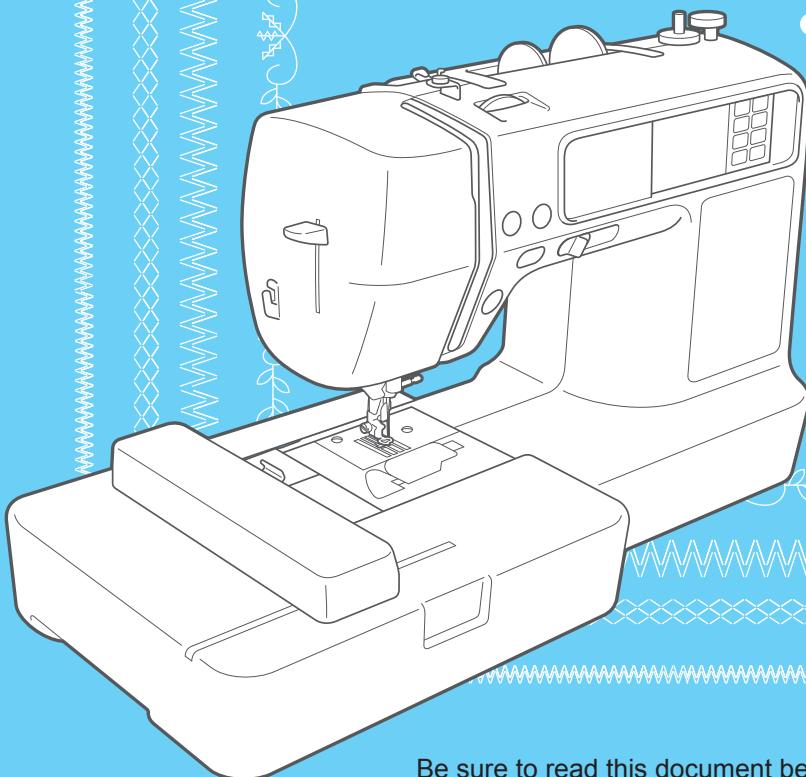

Be sure to read this document before using the machine.
We recommend that you keep this document nearby for future reference.

Introduction

Thank you for purchasing this embroidery and sewing machine. Before using this machine, carefully read the "IMPORTANT SAFETY INSTRUCTIONS", and then study this manual for the correct operation of the various functions.

In addition, after you have finished reading this manual, store it where it can quickly be accessed for future reference.

IMPORTANT SAFETY INSTRUCTIONS

Please read these safety instructions before attempting to use the machine.

⚠ DANGER - To reduce the risk of electric shock

1 **Always** unplug the machine from the electrical outlet immediately after using, when cleaning, when making any user servicing adjustments mentioned in this manual, or if you are leaving the machine unattended.

⚠ WARNING - To reduce the risk of burns, fire, electric shock, or injury to persons.

2 **Always** unplug the machine from the electrical outlet when making any adjustments mentioned in the instruction manual.

- To unplug the machine, switch the machine to the symbol "O" position to turn it off, then grasp the plug and pull it out of the electrical outlet. **Do not** pull on the cord.
- Plug the machine directly into the electrical outlet. Do not use an extension cord.
- **Always** unplug your machine if the power is cut.

3 Electrical Hazards:

- This machine should be connected to an AC power source within the range indicated on the rating label. Do not connect it to a DC power source or inverter. If you are not sure what kind of power source you have, contact a qualified electrician.
- This machine is approved for use in the country of purchase only.

4 **Never** operate this machine if it has a damaged cord or plug, if it is not working properly, if it has been dropped or damaged, or water is spilled on the unit. Return the machine to the nearest authorized dealer or service center for examination, repair, electrical or mechanical adjustment.

- While the machine is stored or in use if you notice anything unusual, such as an odor, heat, discoloration or deformation, stop using the machine immediately and unplug the power cord.
- When transporting the sewing machine, be sure to carry it by its handle. Lifting the sewing machine by any other part may damage the machine or result in the machine falling, which could cause injuries.

- When lifting the sewing machine, be careful not to make any sudden or careless movements, otherwise you may injure your back or knees.

5 Always keep your work area clear:

- **Never** operate the machine with any air openings blocked. Keep ventilation openings of the sewing machine and foot control free from the build up of lint, dust, and loose cloth.
- **Do not** store objects on the foot controller.
- **Do not** use extension cords. Plug the machine directly into the electrical outlet.
- **Never** drop or insert **any** object into **any** opening.
- **Do not** operate where aerosol (spray) products are being used or where oxygen is being administered.
- **Do not** use the machine near a heat source, such as a stove or iron; otherwise, the machine, power cord or garment being sewn may ignite, resulting in fire or an electric shock.
- **Do not** place this sewing machine on an unstable surface, such as an unsteady or slanted table, otherwise the sewing machine may fall, resulting in injuries.

6 Special care is required when sewing:

- **Always** pay close attention to the needle. Do not use bent or damaged needles.
- Keep fingers away from **all** moving parts. Special care is required around the machine needle.
- Switch the sewing machine to the symbol "O" position to turn it off when making any adjustments in the needle area.
- **Do not** use a damaged or incorrect needle plate, as it could cause the needle to break.
- **Do not** push or pull the fabric when sewing, and follow careful instruction when freehand stitching so that you do not deflect the needle and cause it to break.

7 This machine is **not** a toy:

- Your close attention is necessary when the machine is used by or near children.
- The plastic bag that this sewing machine was supplied in should be kept out of the reach of children or disposed of. Never allow children to play with the bag due to the danger of suffocation.
- Do not use outdoors.

8 For a longer service life:

- When storing this machine, avoid direct sunlight and high humidity locations. Do not use or store the machine near a space heater, iron, halogen lamp, or other hot objects.
- Use only neutral soaps or detergents to clean the case. Benzene, thinner, and scouring powders can damage the case and machine, and should never be used.
- Always consult the operation manual when replacing or installing any assemblies, the presser feet, needle, or other parts to assure correct installation.

9 For repair or adjustment:

- If the light unit is damaged, it must be replaced by an authorized dealer.
- In the event a malfunction occurs or adjustment is required, first follow the troubleshooting table in the back of the operation manual to inspect and adjust the machine yourself. If the problem persists, please consult your local authorized Brother dealer.

Use this machine only for its intended use as described in the manual.
Use accessories recommended by the manufacturer as contained in this manual.
The contents of this manual and specifications of this product are subject to change without notice.
For additional product information and updates, visit our web site at www.brother.com

SAVE THESE INSTRUCTIONS

This machine is intended for household use.

This appliance is not intended for use by persons (including children) with reduced physical, sensory or mental capabilities, or lack of experience and knowledge, unless they have been given supervision or instruction concerning use of the appliance by a person responsible for their safety. Children should be supervised to ensure that they do not play with the appliance.

This appliance can be used by children aged from 8 years and above and persons with reduced physical, sensory or mental capabilities or lack of experience and knowledge if they have been given supervision or instruction concerning use of the appliance in a safe way and understand the hazards involved. Children shall not play with the appliance. Cleaning and user maintenance shall not be made by children without supervision.

FOR USERS IN THE UK, EIRE, MALTA AND CYPRUS ONLY

IMPORTANT

- In the event of replacing the plug fuse, use a fuse approved by ASTA to BS 1362, i.e. carrying the  mark, rating as marked on plug.
- Always replace the fuse cover. Never use plugs with the fuse cover omitted.
- If the available electrical outlet is not suitable for the plug supplied with this equipment, you should contact your authorized dealer to obtain the correct lead.

Contents

Introduction	1
IMPORTANT SAFETY INSTRUCTIONS	1
Machine Features	8
Accessories	9
Included accessories	9
Optional accessories	10
Names of Machine Parts and Their Functions	11
Front view	11
Needle and presser foot section	12
Right-side/rear view	12
Operation buttons	13
Operation panel	14
GETTING READY	15
Turning the Machine On/Off	16
Power supply precautions	16
Turning on the machine	17
Turning off the machine	17
LCD (Liquid Crystal Display) Operation	18
Viewing the LCD	18
Changing the machine settings	18
Checking machine operating procedures	21
Winding/Installing the Bobbin	22
Bobbin precautions	22
Winding the bobbin	22
Installing the bobbin	27
Upper Threading	31
About the spool of thread	31
Threading the upper thread	32
Using the twin needle	36
Replacing the Needle	39
Needle precautions	39
Selecting the needle depending on the thread and fabric types	39
Checking the needle	40
Replacing the needle	41
Replacing the Presser Foot	43
Presser foot precautions	43
Replacing the presser foot	43
Removing and attaching the presser foot holder	45
Sewing Cylindrical Pieces and Large Pieces	46
Free-arm sewing	46
Using extension table	46
SEWING BASICS	49
Sewing	50
General sewing procedure	50
Stitch types	51
Selecting stitching	51
Positioning the fabric	54
Starting to sew	55
Securing the stitching	57
Cutting the thread	59
Setting the Stitch	61
Adjusting the stitch width	61
Adjusting the stitch length	62
Adjusting the thread tension	62

Useful Functions	64
Automatic sewing reverse/reinforcement stitches	64
Automatically cutting the thread	65
Mirroring stitches	66
Saving stitch settings	67
Useful Sewing Tips	68
Trial sewing	68
Changing the sewing direction	68
Sewing curves	68
Sewing thick fabrics	68
Sewing hook-and-loop fastener	69
Sewing thin fabrics	70
Sewing stretch fabrics	70
Sewing an even seam allowance	70

UTILITY STITCHES **71**

Stitch Setting Chart	72
Utility stitches	72
Other stitches	76
Overcasting Stitches	78
Sewing overcasting stitches using overcasting foot "C"	78
Sewing overcasting stitches using zigzag foot "J"	79
Sewing overcasting stitches using the optional side cutter	80
Basic Stitching	82
Basting	82
Basic stitching	82
Blind Hem Stitching	84
Buttonhole Stitching/Button Sewing	87
Buttonhole sewing	88
Button sewing	92
Zipper Insertion	94
Inserting a centered zipper	94
Inserting a side zipper	96
Sewing Stretch Fabrics and Elastic Tape	99
Stretch stitching	99
Elastic attaching	100
Appliqué, Patchwork and Quilt Stitching	101
Appliqué stitching	102
Patchwork (crazy quilt) stitching	103
Piecing	103
Quilting	104
Free-motion quilting	106
Satin stitching using the sewing speed controller	107
Reinforcement Stitching	108
Triple stretch stitching	108
Bar tack stitching	108
Darning	111
Eyelet Stitching	113
Decorative Stitching	114
Fagoting	115
Scallop stitching	116
Smocking	117
Shell tuck stitching	118
Joining	119
Heirloom stitching	119
Sewing the Various Built-in Decorative Patterns	122
Sewing beautiful patterns	122
Sewing patterns	122
Changing the stitch density	123
Changing the pattern size	123
Changing the length for satin stitches	124

Adjusting the character spacing	124
Realigning the pattern	125
Combining patterns	126
Saving patterns	129
Designing a Pattern (My Custom Stitch)	131
Drawing a sketch of the pattern	131
Entering the pattern data	132
Editing the pattern data	133
Examples of designs	134

EMBROIDERY

135

Embroidering Neatly	136
What to prepare	136
Embroidery step by step	137
Attaching the Embroidery Foot	138
Attaching the embroidery foot	138
Removing the embroidery foot	140
Attaching the Embroidery Unit	141
Embroidery unit precautions	141
Attaching the embroidery unit	141
Removing the embroidery unit	143
Preparing the Fabric	144
Attaching a stabilizer material to the fabric	144
Setting the fabric in the embroidery frame	145
Attaching the Embroidery Frame	148
Attaching the embroidery frame	148
Removing the embroidery frame	149
Selecting Embroidery Patterns	150
Copyright information	150
Embroidery pattern types	150
LCD (liquid crystal display) operation	151
Selecting alphanumeric characters	154
Selecting an embroidery pattern	155
Selecting a frame pattern	155
Using an embroidery card	156
Embroidering	157
Checking the pattern before embroidering	157
Embroidering a pattern	158
Appliquéing	160
Editing and Saving Patterns	162
Adjusting the layout and the size	162
Adjusting the thread tension	164
Connecting character patterns	165
Resewing	166
Thread runs out partway through a design	167
Stopping while embroidering	167
Using the Memory Function	169
Embroidery data precautions	169
Transferring embroidery patterns from the computer to machine	171
Saving patterns	174

APPENDIX

175

Care and Maintenance	176
Restrictions on oiling.....	176
Cleaning the machine surface	176
Precautions on storing the machine.....	176
Cleaning the race	176
Troubleshooting	178
Frequent troubleshooting topics	178
Upper thread tightened up	178
Tangled thread on wrong side of fabric	179

Incorrect thread tension	182
Fabric is caught in the machine and cannot be removed	183
When the thread became tangled under the bobbin winder seat	186
List of symptoms	188
Error messages	193
Adjusting the LCD	197
Operation beep	197
Upgrading Your Machine's Software Using USB Media	198
Index	199

Machine Features

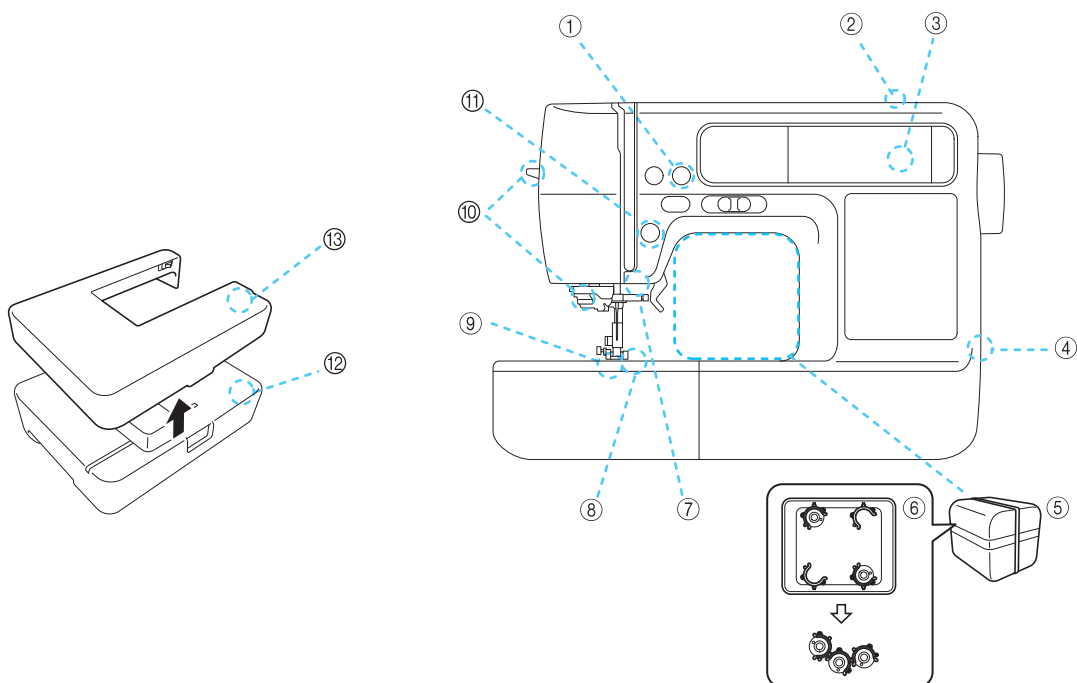

- ① **Automatic thread cutting**
The thread can be cut automatically after sewing (page 59, 65).
- ② **Fast bobbin winding system**
With the fast and simple bobbin winder, you can wind bobbins with one press of a button (page 22).
- ③ **Built-in stitches**
You can select from the built-in stitches available, including utility stitches and decorative stitches (page 72).
- ④ **USB port**
Embroidery patterns saved in a USB flash drive (USB flash memory) can be imported to the machine by plugging the USB flash drive directly into the USB port (page 172).
- ⑤ **Accessory case**
You can store the accessory case inside the arm of the machine as shown in the figure. Presser foot, bobbins, a seam ripper, etc. can be stored in this case.
- ⑥ **Bobbin clip**
You can use the bobbin clip to prevent the end of the thread wound onto the bobbin from loosening. Bobbin clips can be stored inside of the accessory case cover.
- ⑦ **Bright light**
The convenient LED lamp makes it easy to work on dark fabrics.
- ⑧ **Seven-point feed dogs**
Ensure smooth, even feeding of multiple fabric layers and a variety of fabric weights (page 12).
- ⑨ **Quick-set bobbin**
You can start sewing without pulling up the bobbin thread (page 27).
- ⑩ **Easy-to-use needle threader**
You can thread the needle easily by one press of a lever (page 32).
- ⑪ **Lighting Start/Stop button**
When the green light is on, the machine is ready to sew. A red or orange light indicates an error or that the machine is warming up (page 13).
- ⑫ **Embroidery**
You can embroider built-in embroidery patterns, alphanumeric characters, framed decorations, and designs from optional embroidery cards (page 135).
- ⑬ **Extension table (Cover of the embroidery unit)**
You can use the cover of the embroidery unit as the extension table when you sew a large material (page 46).

Accessories

After opening the box, check that the following accessories are included. If any item is missing or damaged, contact your dealer.

Included accessories



Note

- Foot controller: Model T
This foot controller can be used on the machine with product code 885-V95/V96/V97/V98. The product code is mentioned on the machine rating plate.
- The securing screw on the side of the presser foot holder is available through your authorized dealer. (Part code: 132730-122)

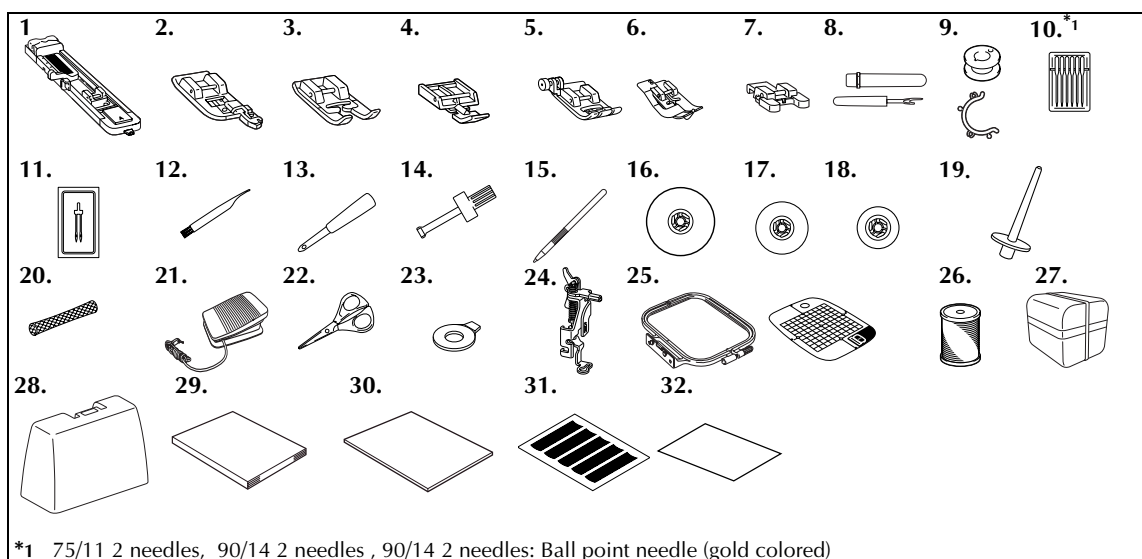

No.	Part Name	Part Code		No.	Part Name	Part Code	
		Americas	Others			Americas	Others
1	Buttonhole foot "A"	XC2691-023		17	Spool cap (medium) (on machine)	XE1372-001	
2	Overcasting foot "C"	XE6305-101		18	Spool cap (small)	130013-124	
3	Monogramming foot "N"	XD0810-031		19	Extra spool pin	XE2241-001	
4	Zipper foot "I"	X59370-021		20	Spool net	XA5523-020	
5	Zigzag foot "J" (on machine)	XZ5134-001		21	Foot controller	XD0501-021 (EU area) XC8816-071 (other areas)	
6	Blind stitch foot "R"	XE2650-001		22	Scissors	XC1807-121	
7	Button fitting foot "M"	XE2137-001		23	Disc-shaped screwdriver	XC1074-051	
8	Seam ripper	XZ5082-001		24	Embroidery foot "Q"	XD0474-151	
9	Bobbin (4)	SA156	SFB	25	Embroidery set (medium) H 10 cm X W 10 cm (H 4 inches X W 4 inches)	SA432	EF62
	Bobbin clip (4)	SABOBCLIP (U.S.A.) SABOBCLIPC (Canada)	BCL	26	Embroidery bobbin thread (white)	SAEBT	EBT-CEN
10	Needle set	X58358-021		27	Accessory case	XE3062-003	
11	Twin needle	X59296-121				28	Hard case
12	Cleaning brush	X59476-021		29	Operation manual		
13	Eyelet punch	XZ5051-001		30	Quick reference guide	XE7930-001	
14	Screwdriver	XC4237-021		31	Grid sheet set	SA527	GS4
15	Touch pen	XE3069-001		32	Felt with stabilizer	182986-024	
16	Spool cap (large)	130012-024					

Optional accessories

The following are available as optional accessories.

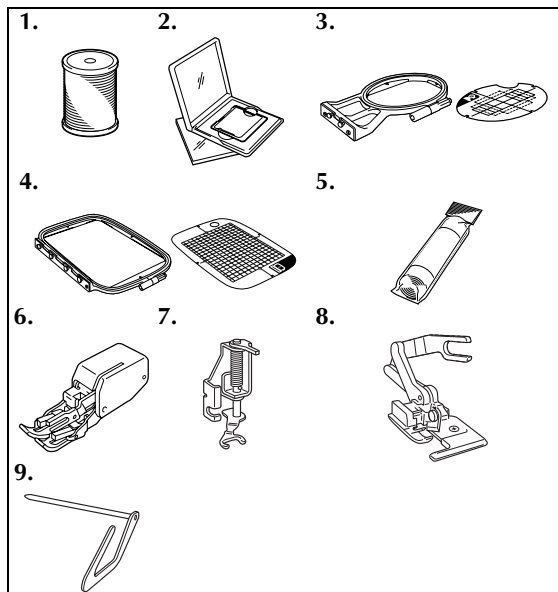

No.	Part Name	Part Code	
		Americas	Others
1	Embroidery bobbin thread (black)	SAEBT999	EBT-CEBN
2	Embroidery card		
3	Embroidery set (small) H 2 cm x W 6 cm (H 1 inch x W 2-1/2 inches)	SA431	EF61
4	Embroidery set (large) H 17 cm x W 10 cm (H 6-7/10 inches x W 4 inches)	SA434	EF71
5	Water soluble stabilizer	SA520	BM5
	Stabilizer material for embroidery	SA519	BM3
6	Walking foot	SA140	F033N
7	Open toe quilting foot	SA187	F061
8	Side cutter "S"	SA177	F054
9	Quilting guide	SA132	F016N



Memo

- To obtain optional accessories or parts, contact your sales representative, the nearest authorized service center or visit the website at "<http://www.brother.com/>".
- All specifications are correct at the time of printing. The part codes are subject to change without notice.
- Visit your nearest authorized dealer for a complete listing of optional accessories available for your machine.

Names of Machine Parts and Their Functions

The names of the various parts of the sewing machine and their functions are described below. Before using the sewing machine, carefully read these descriptions to learn the names of the machine parts.

Front view

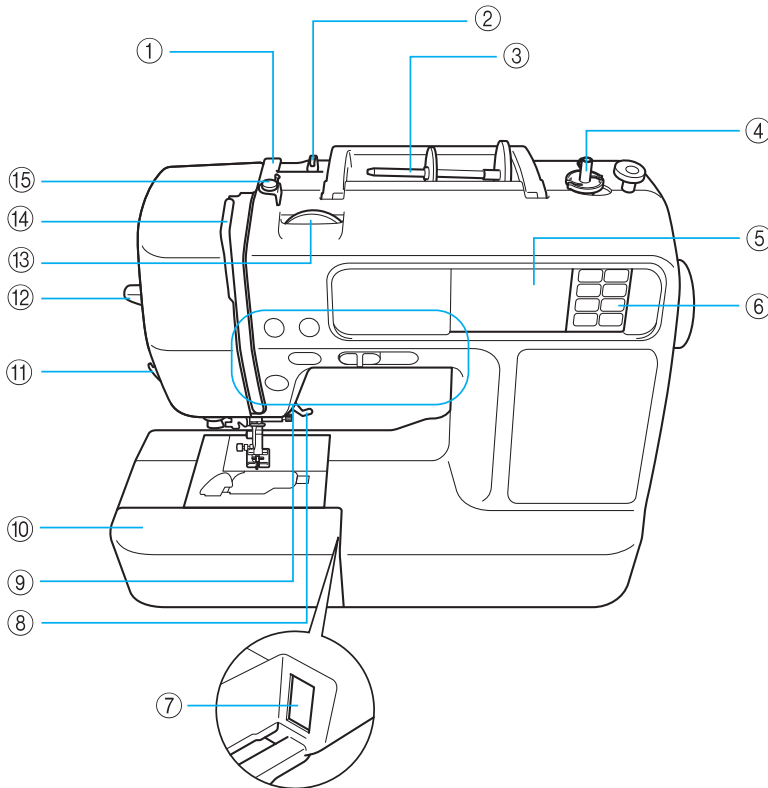

- ① **Thread guide cover (page 24, 33)**
Pass the thread under this thread guide cover when winding the bobbin thread and threading the machine.
- ② **Thread guide (page 24, 33)**
Pass the thread under this thread guide when winding the bobbin thread and threading the machine.
- ③ **Spool pin (page 23, 32)**
Place a spool of thread on the spool pin.
- ④ **Bobbin winder (page 22)**
Use the bobbin winder when winding the bobbin.
- ⑤ **LCD (liquid crystal display) (touch panel) (page 18)**
Setting for the selected stitch or pattern and error messages appear in the LCD.
- ⑥ **Operation panel (page 14)**
Use the keys on this panel to select stitches or embroidery patterns, or check how to use the sewing machine, etc.
- ⑦ **Embroidery unit connector slot (page 141)**
Plug in the connector for the embroidery unit.
- ⑧ **Presser foot lever (page 54)**
Raise and lower the presser foot lever to raise and lower the presser foot.
- ⑨ **Operation buttons (page 13)**
Use these buttons to operate the machine.
- ⑩ **Flat bed attachment (page 46)**
Remove the flat bed attachment when sewing cylindrical pieces such as sleeve cuffs.
- ⑪ **Thread cutter (page 60)**
Pass the threads through the thread cutter to cut them.
- ⑫ **Needle threader lever (page 35)**
Use the needle threader lever to thread the needle.
- ⑬ **Thread tension dial (page 62, 164)**
Adjust the upper thread tension with this dial.
- ⑭ **Thread take-up lever (page 34)**
- ⑮ **Bobbin-winding thread guide and pretension disc (page 24)**
Pass the thread under this thread guide and around the pretension disc when winding the bobbin thread.

Needle and presser foot section

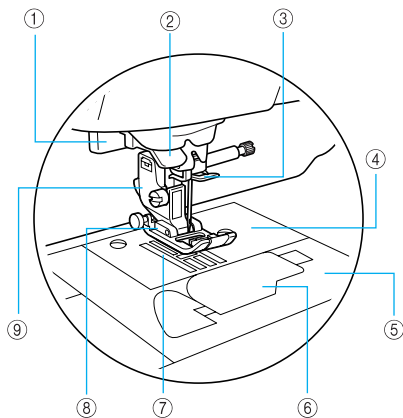

- ① **Buttonhole lever (page 90)**
Lower the buttonhole lever when sewing buttonholes and bar tacks.
- ② **Thread guide disk (page 34)**
Pass the thread through the thread guide disk when using the needle threader to thread the needle.
- ③ **Needle bar thread guide (page 34)**
Pass the upper thread through the needle bar thread guide.
- ④ **Needle plate (page 70)**
The needle plate is marked with guides for sewing straight seams.
- ⑤ **Needle plate cover (page 177)**
Remove the needle plate cover to clean the bobbin case and race.
- ⑥ **Bobbin cover/bobbin case (page 28)**
Remove the bobbin cover, and then insert the bobbin into the bobbin case.
- ⑦ **Feed dogs (page 92)**
The feed dogs feed the fabric in the sewing direction.
- ⑧ **Presser foot (page 43, 54)**
The presser foot applies pressure consistently on the fabric as the sewing takes place. Attach the appropriate presser foot for the selected stitching.
- ⑨ **Presser foot holder (page 45)**
The presser foot is installed onto the presser foot holder.

Right-side/rear view

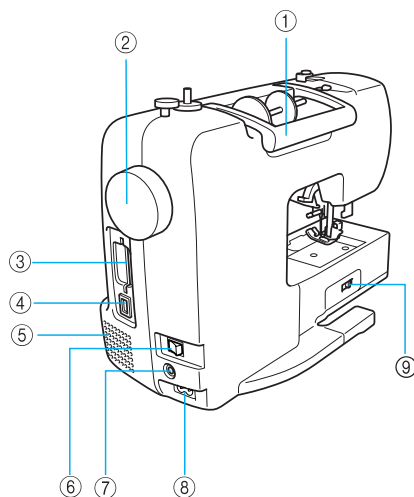

- ① **Handle**
Carry the sewing machine by its handle when transporting the machine.
- ② **Handwheel (page 54)**
Turn the handwheel toward you (counterclockwise) to raise and lower the needle to sew one stitch.
- ③ **Embroidery card slot (page 156)**
Insert the embroidery card.
- ④ **USB port (for a USB flash drive (USB flash memory))**
In order to import patterns from a USB flash drive (USB flash memory), plug the USB media directly into the USB port.
- ⑤ **Air vent**
The air vent allows the air surrounding the motor to be exchanged. Do not cover the air vent while the sewing machine is being used.
- ⑥ **Main power switch (page 17)**
Use the main power switch to turn the sewing machine on and off.
- ⑦ **Foot controller jack (page 56)**
Insert the plug on the end of the foot controller cable into the foot controller jack.
- ⑧ **Power supply jack (page 17)**
Insert the plug on the power supply cord into the power supply jack.
- ⑨ **Drop feed lever (page 92)**
Use the drop feed lever to lower the feed dogs.



Memo

- Refer to pages 11 through 14 while you are learning to use your machine.

Operation buttons

The operation buttons help you to easily perform various basic sewing machine operations.

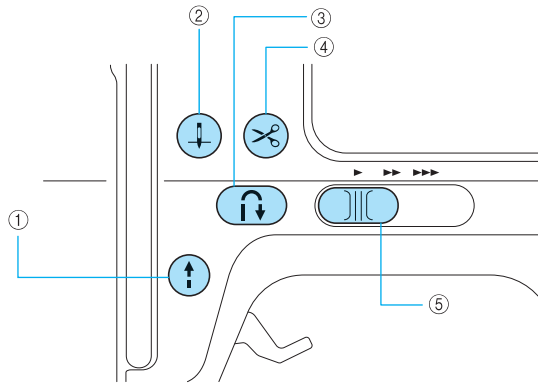

① Start/stop button

Press the start/stop button to start or stop sewing. The machine sews at a slow speed at the beginning of sewing while the button is pressed. When sewing is stopped, the needle is lowered in the fabric. For details, refer to "Starting to sew" (page 55). The button changes color according to the machine's operation mode.

Green: The machine is ready to sew or is sewing.

Red: The machine can not sew.

Orange: The machine is winding the bobbin thread, or the bobbin winder shaft is moved to the right side.



Memo

- When the foot controller is plugged in, (Start/stop button) cannot be used to start sewing.

② Needle position button

Press the needle position button to raise or lower the needle. Be sure to raise the needle before threading the needle. Use this button to change the sewing direction or for detailed sewing in small areas. Pressing the button twice sews one stitch.

③ Reverse/reinforcement stitch button

Press the reverse/reinforcement stitch button to sew reverse stitches or reinforcement stitches. Reverse stitches are sewn by keeping the button pressed down to sew in the opposite direction. Reinforcement stitches are sewn by sewing 3 to 5 stitches on top of each other. For details, refer to "Securing the stitching" (page 57).

④ Thread cutter button

Press the thread cutter button after sewing is stopped to cut both the upper thread and the bobbin threads. For details, refer to "Cutting the thread" (page 59).

CAUTION

- Do not press the thread cutter button after the threads have already been cut, otherwise the needle may break, the threads may become tangled or damage to the machine may occur.









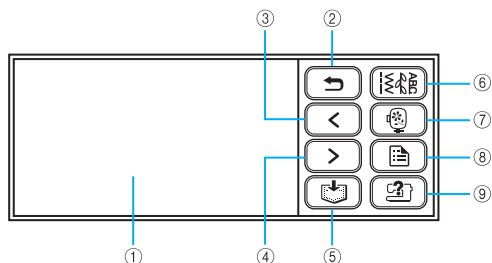

Note

- Do not press the thread cutter button if there is no fabric under the presser foot or while the machine is sewing, otherwise damage to the machine may occur.
 - When cutting nylon thread or other special threads, use the thread cutter on the side of the machine. For details, refer to "Using the thread cutter" (page 60).
- ### ⑤ Sewing speed controller
- Slide the sewing speed controller to adjust the sewing speed.

Operation panel

The front operation panel has an LCD (liquid crystal display) and operation keys.



- ① **LCD (liquid crystal display) (touch panel)**
Setting for the selected stitch or pattern and error messages appear in the LCD.
Touch the keys displayed on the LCD with your finger or the touch pen to perform operations.
For details, refer to "LCD (Liquid Crystal Display) Operation" (page 18).
- ② **Back key** 
Press to return to the previous screen.
- ③ **Previous page key** 
Displays the previous page when there are items that are not displayed on the LCD.
- ④ **Next page key** 
Displays the next page when there are items that are not displayed on the LCD.
- ⑤ **Memory key** 
Press to save character embroidery, combined stitch patterns, My Custom Stitch patterns, etc. in the sewing machine's memory.
- ⑥ **Utility stitch key** 
Press this key to select a utility stitch or decorative stitch or to design a stitch pattern using the My Custom Stitch function.
- ⑦ **Embroidery key** 
Press this key to sew embroidery.
- ⑧ **Settings key** 
Press to set the needle stop position, the buzzer sound, and more.
- ⑨ **Sewing machine help key** 
Press to get help on using the sewing machine. Displays simple explanations of setting upper thread / bobbin winding / setting bobbin thread / needle replacement / embroidery unit attachment / embroidery frame attachment / embroidery foot attachment / presser foot replacement.

1

GETTING READY

The various preparations required before starting to sew are described in this chapter.

Turning the Machine On/Off	16
LCD (Liquid Crystal Display) Operation.....	18
Winding/Installing the Bobbin.....	22
Upper Threading	31
Replacing the Needle	39
Replacing the Presser Foot	43
Sewing Cylindrical Pieces and Large Pieces.....	46

Turning the Machine On/Off

This section explains how to turn the sewing machine on and off.

Power supply precautions

Be sure to observe the following precautions concerning the power supply.

WARNING

- Use only regular household electricity for the power source. Using other power sources may result in fire, electric shock, or damage to the machine.
- Make sure that the plugs on the power cord are firmly inserted into the electrical outlet and the power supply jack on the machine. Otherwise, a fire or electric shock may result.
- Do not insert the plug on the power cord into an electrical outlet that is in poor condition.
- Turn off the main power and remove the plug in the following circumstances:
 - When you are away from the machine
 - After using the machine
 - When the power fails during use
 - When the machine does not operate correctly due to a bad connection or a disconnection
 - During electrical storms

CAUTION

- Use only the power cord included with this machine.
- Do not use extension cords or multi-plug adapters with many other appliances plugged in to them. Fire or electric shock may result.
- Do not touch the plug with wet hands. Electric shock may result.
- When unplugging the machine, always turn off the main power first. Always grasp the plug to remove it from the outlet. Pulling on the cord may damage the cord, or lead to fire or electric shock.
- Do not allow the power cord to be cut, damaged, modified, forcefully bent, pulled, twisted, or bundled. Do not place heavy objects on the cord. Do not subject the cord to heat. These things may damage the cord and cause fire or electric shock. If the cord or plug is damaged, take the machine to your authorized dealer for repairs before continuing use.
- Unplug the power cord if the machine is not to be used for a long period of time. Otherwise a fire may result.

Turning on the machine

Prepare the included power cord.

- 1 Make sure that the sewing machine is turned off (the main power switch is set to "O"), and then plug the power supply cord into the power supply jack on the right side of the machine.
- 2 Insert the plug of the power supply cord into a household electrical outlet.

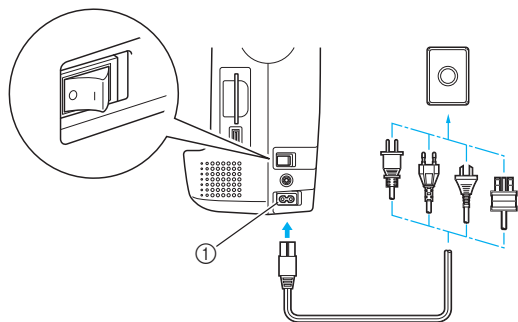

① Power supply jack

- 3 Press the right side of the main power switch on the right side of the machine to turn the machine on (set it to "I").

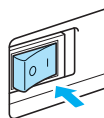

▶ The light, LCD and ⏻ (Start/stop button) light up when the machine is turned on.



Memo

- When the machine is turned on, the needle and the feed dogs will make sound when they move; this is not a malfunction.

Turning off the machine

When you have finished using the sewing machine, turn it off. In addition, before transporting the sewing machine to another location, be sure to turn it off.

- 1 Make sure that the machine is not sewing.
- 2 Press the left side of the main power switch on the right side of the machine to turn the machine off (set it to "O").



▶ The light, LCD and ⏻ (Start/stop button) go off when the machine is turned off.

- 3 Unplug the power supply cord from the electrical outlet.
Grasp the plug when unplugging the power supply cord.
- 4 Unplug the power cord from the power supply jack.

Note

- If a power outage occurs while the sewing machine is being operated, turn off the sewing machine and unplug the power supply cord. When restarting the sewing machine, follow the necessary procedure to correctly operate the machine.
(For U.S.A. only)
- This appliance has a polarized plug (one blade wider than the other). To reduce the risk of electrical shock, this plug is intended to fit in a polarized outlet only one way. If the plug does not fit fully in the outlet, reverse the plug. If it still does not fit, contact a qualified electrician to install the proper outlet. Do not modify the plug in any way.

LCD (Liquid Crystal Display) Operation

Selected stitch, pattern settings and messages are displayed on the LCD (liquid crystal display) on the front of the sewing machine. Change the screen on the LCD using the keys on the right side of the LCD, and make operations by directly touching the icons with your finger or a touch pen. For details, refer to "Operation panel" (page 14).

Viewing the LCD

When the power is turned on, the LCD comes on. When you touch the LCD screen according to the message displayed on the screen with your finger or a touch pen, the following utility stitch selection screen is displayed.

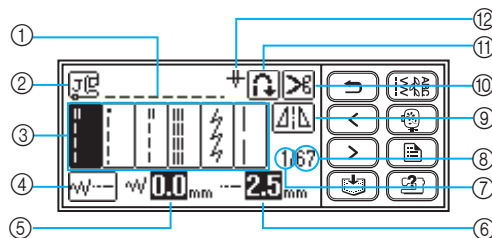

- | | |
|--|--|
| ① Selected stitch | ⑨ Horizontal mirror image |
| ② Presser foot to be used | ⑩ Automatic thread cutting |
| ③ Stitches | ⑪ Automatic reverse/reinforcement |
| ④ Stitch settings and twin needle sewing | ⑫ Single/twin needle sewing and needle stop position |
| ⑤ Stitch width | |
| ⑥ Stitch length | |
| ⑦ Number of the selected stitch | |
| ⑧ Number of stitches contained | |







Memo

- Press  (Utility stitch key) to display the screen for selecting the stitch type. The details are explained in "Stitch types" (page 51).
- A different screen is displayed when the embroidery unit is attached. The details are explained in "Selecting an embroidery pattern" (page 155).
- Refer to "Error messages" (page 193) for messages displayed on the LCD.
- Depending on the model of sewing machine, an animation may be displayed when the power is turned on. When an animation is displayed, the screen above will be displayed if you touch the LCD with your finger.

Changing the machine settings

Various sewing machine operations and sewing settings can be changed. The stitch or machine attributes that can be set are listed below. For details on operation, refer to page 20.

Attribute	Icon	Details	Settings
Needle position		Specifies where the needle is positioned when the sewing machine is stopped.	Down  Up
Stitch width control		Allows the stitch width to be adjusted with the sewing speed controller (page 107).	
Vertical pattern adjustment		Adjusts the up and down position of the pattern (page 125).	-9 to +9

Attribute	Icon	Details	Settings
Character spacing		Adjusts the space between characters when sewing alphanumeric characters. (page 124)	0 to 10
Thread color display		Changes the thread color display on the embroidery screen (page 151).	Thread color/Time to embroider/Needle count/Thread number (#123)
		(When "Thread No.#123" is selected)	Embroidery/Country/Madeira poly/Madeira rayon/Sulky/Robison Anton
Display unit		Selects the measurement units that are displayed (only for embroidering) (page 152).	mm/INCH
Buzzer		Specifies whether or not a beep is sounded with each operation (page 197).	
Opening screen		Sets whether or not to display the opening screen when the power is turned on. (There are models where this cannot be changed.)	
Initial needle position		Selects whether "1	
Language		Allows the language used in the screens to be changed.	English/German/French/Italian/Dutch/Spanish/Japanese/Danish/Norwegian/Finnish/Swedish/Portuguese/Russian/Korean/Thai/others
LCD brightness		Adjust the brightness of the LCD (page 197).	Lighter Darker
Stitch counter		Displays the service count and the total number of embroidery stitches. The service count is a reminder to take your machine in for regular servicing. (Contact your authorized dealer for details.)	-
Product number	NO.:	The "NO." is the number for the embroidery and sewing machine.	-
Program version	Version:	Displays the program version.	-



Memo

- The item shown in reverse highlighting are the settings at the time of purchase.

1 Turn on the sewing machine.

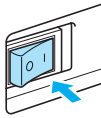

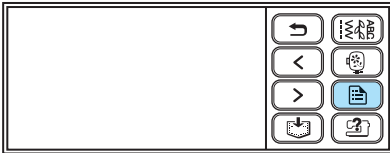

▶ The LCD comes on.

2 Press  (Settings key) on the display panel.



▶ The setting screen appears.

3 Press the item to be set.

Switch the screen using  (Previous page key) and  (Next page key).

- The following screens show their default settings.

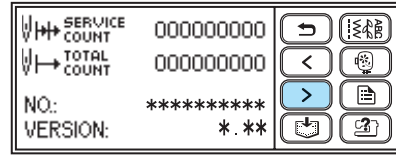
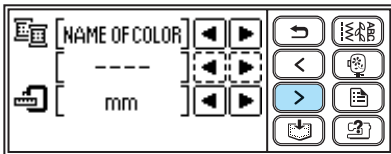
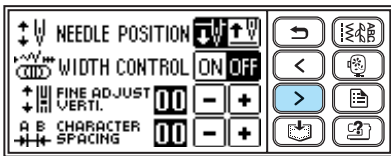

Example: Changing the needle stop position

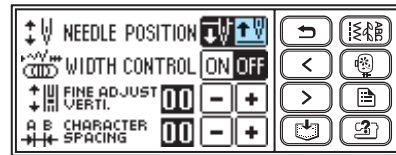

4 When settings are complete, press  (Back key).

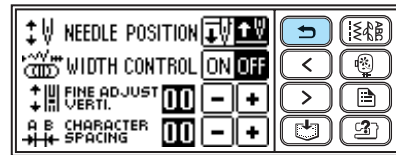

▶ The initial stitch screen appears again.

Memo

- "NO." is the individual number for the sewing machine.
- "VERSION" is the program version which is installed in the sewing machine.
- Settings that are changed are saved even if the power is turned off.

Checking machine operating procedures

Simple explanations can be referred on the LCD display for the following items.
Displays simple explanations of setting upper thread / bobbin winding / setting bobbin thread / needle replacement / embroidery unit attachment / embroidery frame attachment / embroidery foot attachment / presser foot replacement on the LCD.

1 Turn on the sewing machine.

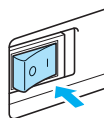

▶ The LCD comes on.

2 Press (Sewing machine help key) on the display panel.

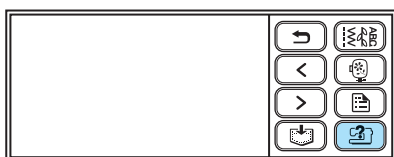

▶ The sewing machine help screen appears.

3 Press the item to be displayed.

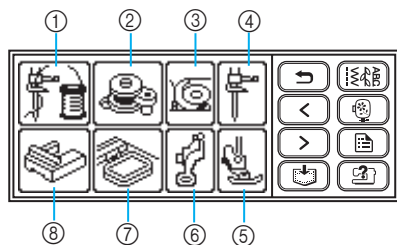

- ① Upper threading
- ② Bobbin winding
- ③ Bobbin installation
- ④ Needle replacement
- ⑤ Presser foot replacement
- ⑥ Embroidery foot attachment
- ⑦ Embroidery frame attachment
- ⑧ Embroidery unit attachment

▶ The first screen describing the procedure for the selected topic appears.

4 Press (Next page key) to switch to the next page.

If you press  (Previous page key), you return to the previous page.

Press  (Back key) to return to the item selection screen.

Example: Upper threading

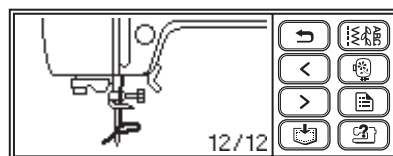
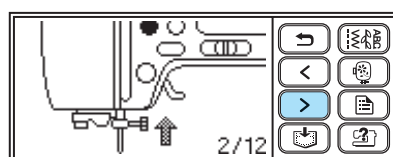
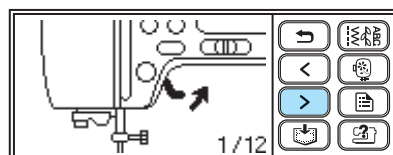

5 After you finish viewing, press (Back key) two times.

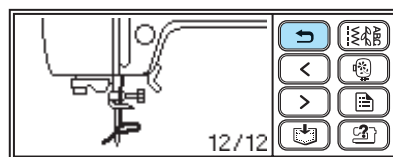

▶ The initial stitch screen appears again.



Memo

- For details on each topic, refer to the corresponding page in this Operation Manual.

Winding/Installing the Bobbin

This section describes how to wind the thread onto the bobbin, and then insert the bobbin thread.

Bobbin precautions

Be sure to observe the following precautions concerning the bobbin.

! CAUTION

- Only use the Bobbin (part code: SA156, SFB) designed specifically for this sewing machine. Use of any other bobbin may result in injuries or damage to the machine.
- The included bobbin was designed specifically for this sewing machine. If bobbins from other models are used, the machine will not operate correctly. Use only the included bobbin or bobbins of the same type (part code: SA156, SFB).

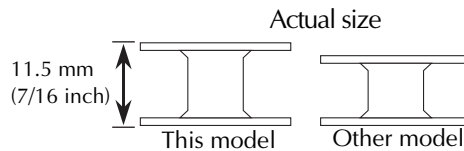

Winding the bobbin

Wind the thread around the bobbin to prepare the bobbin thread.

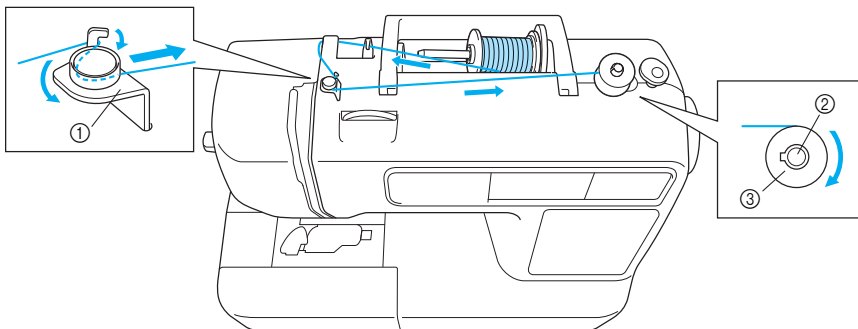

- ① Bobbin-winding thread guide
- ② Bobbin winder shaft
- ③ Bobbin

- 1 Turn on the sewing machine.

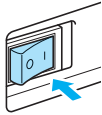

- 2 Place the bobbin on the bobbin winder shaft so that the spring on the shaft fits into the notch in the bobbin. Press down on the bobbin until it snaps into place.

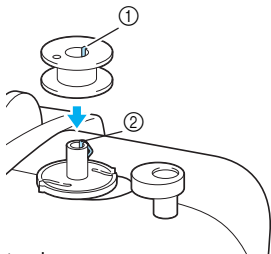

- ① Notch
② Bobbin winder shaft spring

- 3 Slide the bobbin winder in the direction of the arrow until it snaps into place.

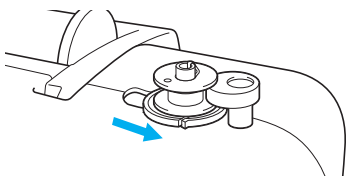

- ▶ Ⓢ (Start/stop button) lights up in orange.

- 4 Pick up the spool pin and remove the spool cap that is inserted onto the spool pin.

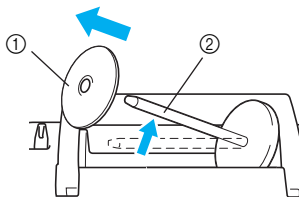

- ① Spool cap
② Spool pin

- 5 Place the spool of thread for the bobbin onto the spool pin.

Slide the spool onto the pin so that the spool is horizontal and the thread unwinds to the front at the bottom.

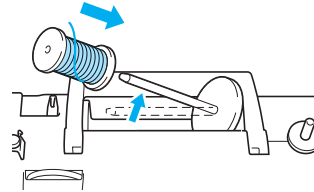

Memo

- For embroidering, use the embroidery bobbin thread.



Note

- If the spool is not positioned so that the thread unwinds correctly, the thread may become tangled around the spool pin.

- 6 Slide the spool cap onto the spool pin and return the spool pin to its original position. Slide the spool cap as far as possible to the right as shown, with the rounded side on the left.

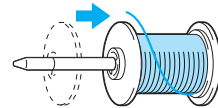

CAUTION

- If the spool or the spool cap is not positioned correctly, the thread may become tangled around the spool pin or the machine may be damaged.
- Three spool cap sizes are available, allowing you to choose a spool cap that best fits the size of spool being used. If the spool cap is too small for the spool being used, the thread may catch on the slit in the spool or the machine may be damaged.

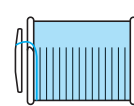
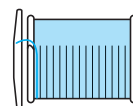

**Note**

- When sewing with fine, cross-wound thread, use the small spool cap, and leave a small space between the cap and the spool.

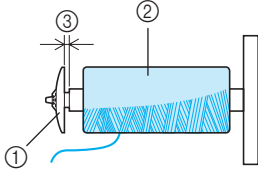

- ① Spool cap (small)
- ② Spool (cross-wound thread)
- ③ Space

- When using thread that winds off quickly, such as transparent nylon thread or metallic thread, place the spool net over the spool before placing the spool of thread onto the spool pin. If the spool net is too long, fold it to fit the size of the spool. When the spool net is used, the upper thread tension may become tighter. Before sewing, refer to "Adjusting the thread tension" (page 62).

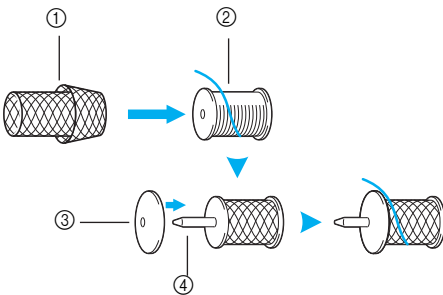

- ① Spool net
- ② Spool
- ③ Spool cap
- ④ Spool pin

7 Pull the thread from the spool and pass the thread under the hook of thread guide.

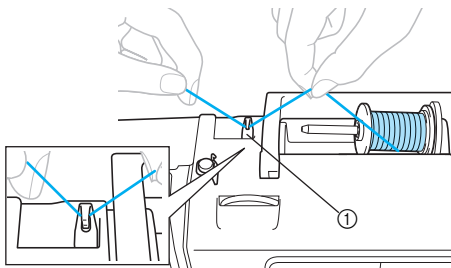

- ① Thread guide

8 Pass the thread behind the thread guide cover and to the front.

While holding the thread near the spool with your right hand, pull the thread with your left hand as shown below.

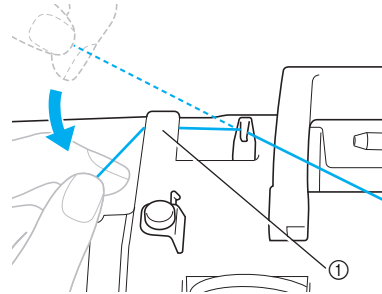

- ① Thread guide cover

9 Pull the thread to the right, pass it under the hook of the bobbin-winding thread guide, and then wind the thread counterclockwise under the pretension disc, pulling it in as far as possible.

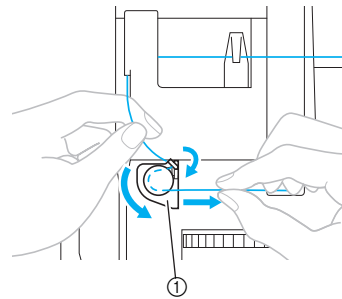

- ① Bobbin-winding thread guide

Make sure that the thread passes under the pretension disk.

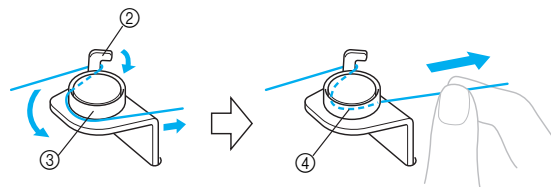

- ② Hook
- ③ Pretension disk
- ④ Pull it in as far as possible.

10 Wind the end of the thread clockwise around the bobbin five or six times.

While using your left hand to hold the thread that was passed through the bobbin-winding thread guide, use your right hand to wind the end of the thread.

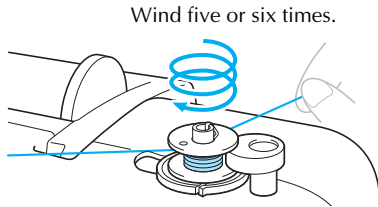

CAUTION

- Be sure to pull the thread tightly and wind it clockwise. If the thread is wound counterclockwise, the thread may wind around the bobbin winder shaft.

11 Pass the end of the thread through the guide slit in the bobbin winder seat, and then pull the thread to the right to cut it.

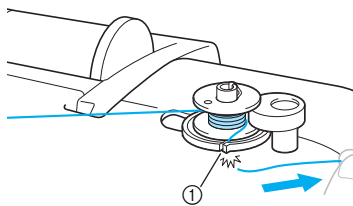

① Guide slit in bobbin winder seat (with built-in cutter)

CAUTION

- Be sure to cut the thread as described. If the bobbin is wound without cutting the thread using the cutter built into the slit in the bobbin winder seat, the thread may become tangled in the bobbin or the needle may bend or break when the bobbin thread starts to run out.



Memo

- Make sure that the thread is correctly set before starting the bobbin winding. Otherwise the thread may become tangled and fail to wind the thread.

12 Slide the sewing speed controller to the right.

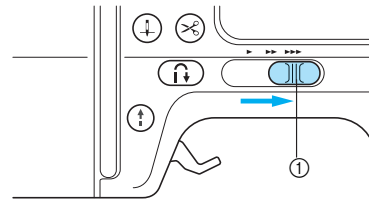

① Speed controller

13 Press **⏻** (Start/stop button) once. When the foot controller is plugged in, press down on the foot controller.

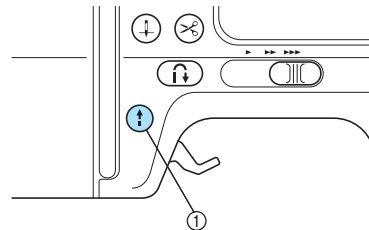

① Start/stop button

- ▶ The bobbin starts winding and "Winding bobbin thread..." is displayed on the LCD screen.

Note

- Do not get away from the machine while winding the bobbin. Make sure the bobbin thread is being wound correctly. If the bobbin thread is wound incorrectly, press **⏻** (Start/stop button) or operate the foot controller immediately to stop the bobbin winding.

14 When the bobbin winding stops or becomes slow, press **⏻** (Start/stop button) once to stop the machine.

When the foot controller is plugged in, remove your foot from the foot controller.

- ▶ The bobbin winding will stop.

CAUTION

- When the bobbin winding stops or becomes slow, stop the machine. Otherwise, the sewing machine may be damaged.

- 15 Cut the thread with scissors, slide the bobbin winder shaft to the left, and then remove the bobbin from the shaft.

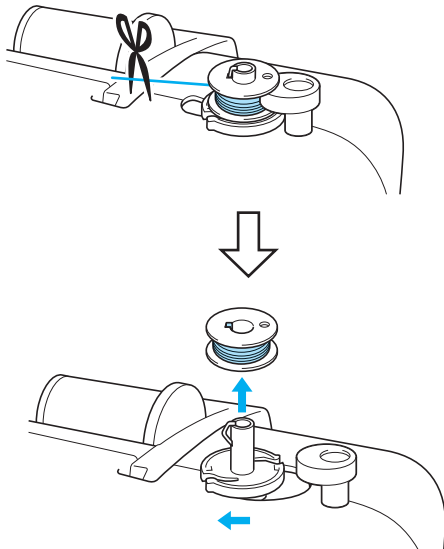

Memo

- If the bobbin winder shaft is set to the right side, the needle will not move. (Sewing is impossible.)

- 16 Slide the sewing speed controller back to its original position.



Memo

- When the sewing machine is started or the handwheel is turned after winding the bobbin, the machine will make a clicking sound; this is not a malfunction.

- When the thread became tangled under the bobbin winder seat.

If the bobbin winding starts when the thread is not passed under the pretension disk of the bobbin-winding thread guide correctly, the thread may become tangled under the bobbin winder seat. In such a case, wind off the thread according to the following procedure.

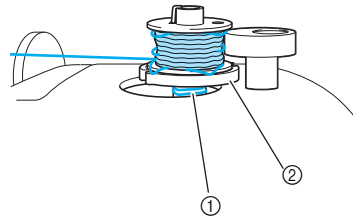

- ① Thread
- ② Bobbin winder seat

CAUTION

- Do not remove the bobbin winder seat even if the thread become tangled under the bobbin winder seat. It may result in injuries.
- Do not remove the screw of the bobbin winder presser, otherwise the machine may be damaged; you cannot wind off the thread by removing the screw.

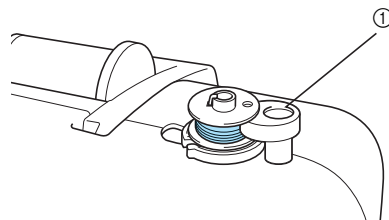

- ① Screw of the bobbin winder presser

- 1 If the thread become tangled under the bobbin winder seat, press  (Start/stop button) once to stop the bobbin winding.

When the foot controller is plugged in, remove your foot from the foot controller.

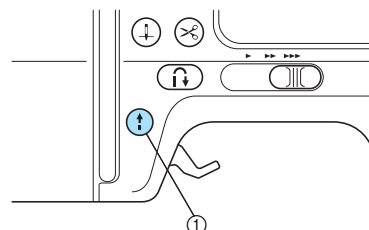

- ① Start/stop button

- 2 Cut the thread with scissors beside the bobbin-winding thread guide.

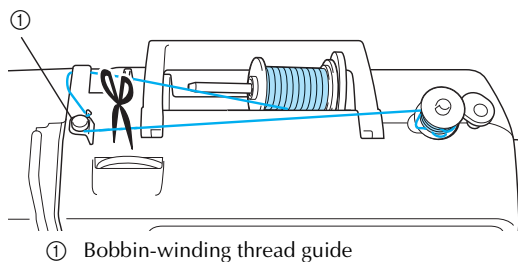

- 3 Slide the bobbin winder shaft to the left, and then remove the bobbin from the shaft.

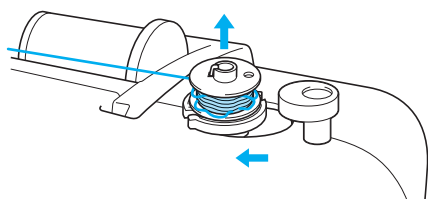

- 4 Hold the thread end with your left hand, and wind off the thread clockwise near the bobbin with your right hand as shown below.

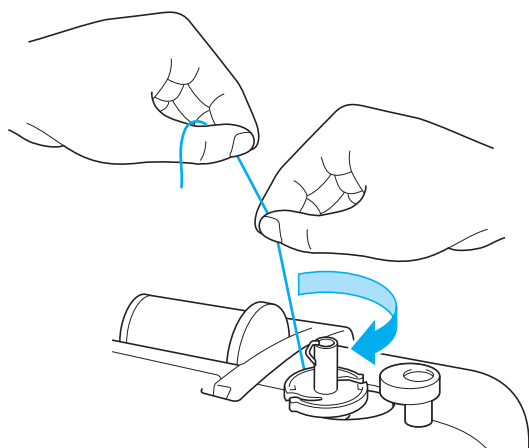

- 5 Wind the bobbin again.



Note

- Make sure that the thread passes under the pretension disk of the bobbin-winding thread guide correctly (page 24).

Installing the bobbin

Install the bobbin wound with thread.

CAUTION

- Use a bobbin that has been correctly wound with thread, otherwise the needle may break or the thread tension will be incorrect.

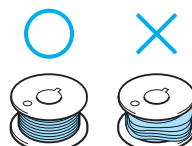

- The included bobbin was designed specifically for this sewing machine. If bobbins from other models are used, the machine will not operate correctly. Use only the included bobbin or bobbins of the same type (part code: SA156, SFB).

Actual size

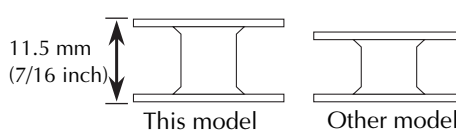

Memo

- The order that the bobbin thread should be passed through the bobbin case is indicated by marks that surround the bobbin case.

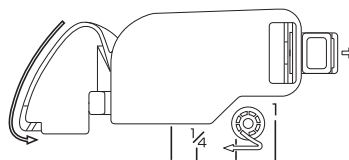

- 1 Press  (Needle position button) once or twice to raise the needle, and then raise the presser foot lever.

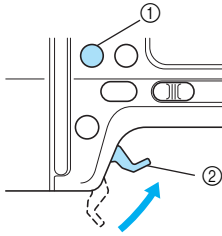

- ① Needle position button
② Presser foot lever

- 2 Turn off the sewing machine.

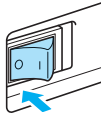

- 3 Slide the bobbin cover latch to the right.

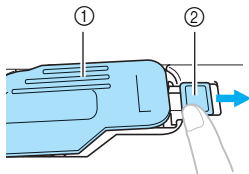

- ① Bobbin cover
② Latch

▶ The bobbin cover opens.

- 4 Remove the bobbin cover.

- 5 Hold the bobbin with your right hand and hold the end of the thread with your left hand.

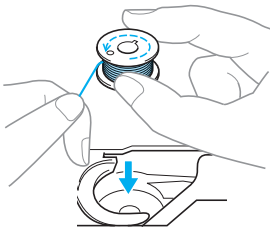

• Be careful not to drop the bobbin.

- 6 Insert the bobbin into the bobbin case with your right hand.

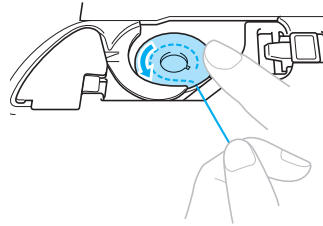

• Be sure to insert the bobbin correctly.

! CAUTION

- Be sure to insert the bobbin and depress it to the bottom with your finger. Otherwise, the thread may break or the thread tension will be incorrect.
- Be sure to thread the machine as indicated. Otherwise, the thread may break or the thread tension will be incorrect.

- 7 Lightly hold down the bobbin with your right hand, and then guide the thread as shown with your left hand.

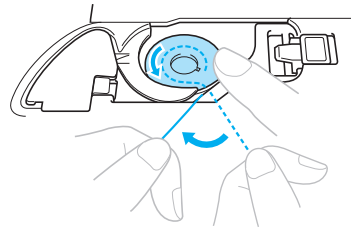

- 8 Pass the thread through the slot as shown, and then pull the thread out toward the front.

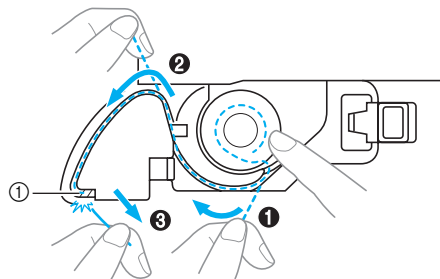

- ① Cutter

▶ The cutter cuts the thread.



Note

- If the thread is not correctly inserted through the tension-adjusting spring of the bobbin case, it may cause incorrect thread tension (page 62).

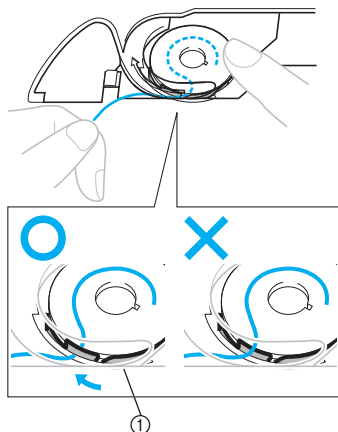

① Tension-adjusting spring

9

Reattach the bobbin cover.

Insert the tab in the lower-left corner of the bobbin cover, and then lightly press down on the right side.

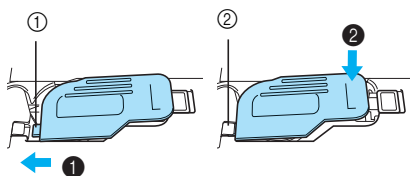

- ① Tab
- ② Lower-left corner

▶ The bobbin threading is finished. You can begin sewing without pulling up the bobbin thread.

Next, thread the upper thread. Continue with the procedure in "Upper Threading" (page 31).



Memo

- When making gathers or before free-motion quilting, pull up the bobbin thread by following the procedure in "When pulling up the bobbin thread may be necessary".

■ When pulling up the bobbin thread may be necessary

When making gathers or before free-motion quilting, first pull up the bobbin thread as described below.

①

Thread the upper thread.

- Refer to "Upper Threading" (page 31).

②

Insert the bobbin into the bobbin case.

- Refer to steps ③ through ⑥ of "Installing the bobbin" (page 28).

③

Pass the bobbin thread through the slot.

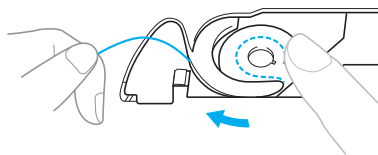

Note

- Do not cut the thread with the cutter.
- Remove the bobbin cover.

④

While lightly holding the upper thread with your left hand, press \updownarrow (Needle position button) once or twice to raise the needle.

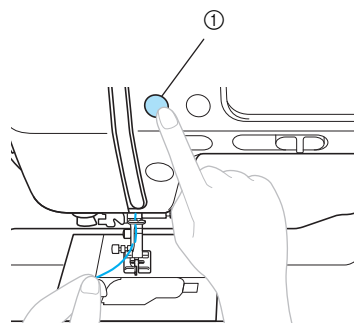

- ① Needle position button

▶ The bobbin thread is looped around the upper thread and can be pulled up.

- 5** Carefully pull the upper thread upward to pull out the end of the bobbin thread.

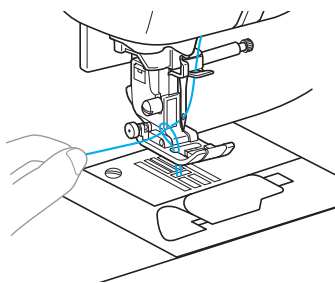

- 6** Pull out about 10-15 cm (4-5 inches) of the bobbin thread under the presser foot toward the rear of the machine.

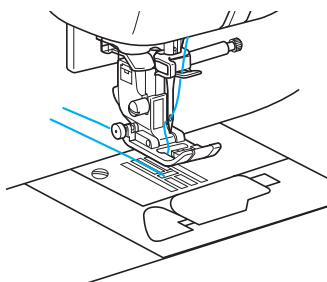

- 7** Reattach the bobbin cover. Insert the tab in the lower-left corner of the bobbin cover, and then lightly press down on the right side.

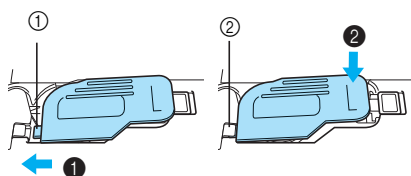

- ① Tab
② Lower-left corner

Upper Threading

This section describes how to position the spool for the upper thread, and then thread the needle.

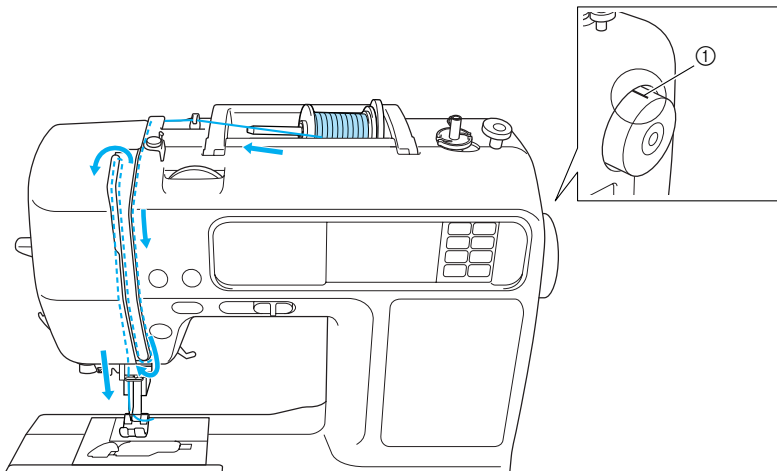

① Mark on handwheel

CAUTION

- When threading the upper thread, carefully follow the instructions. If the upper threading is not correct, the thread may become tangled or the needle may bend or break.
- The needle threader can be used with a 75/11 through 100/16 home sewing machine needle. When using special thread such as transparent nylon thread or metallic thread, the needle threader cannot be used.
- Thread with a thickness of 130/20 or thicker cannot be used with the needle threader.
- The needle threader cannot be used with the wing needle or the twin needle.
- If the needle threader cannot be used, refer to "Threading the needle manually (without using the needle threader)" (page 36).
- Never use a thread weight of 130/20 or lower.
- Use the needle and the thread in the correct combination. For details on the correct combination of needles and threads, refer to "Selecting the needle depending on the thread and fabric types" (page 39).

About the spool of thread

Information about the spools of thread is described below.

CAUTION

- If the spool or the spool cap is not positioned correctly, the thread may become tangled around the spool pin or the needle may break.
- Three spool cap sizes are available, allowing you to choose a spool cap that best fits the size of spool being used. If the spool cap is too small for the spool being used, the thread may catch on the slit in the spool or the needle may break.

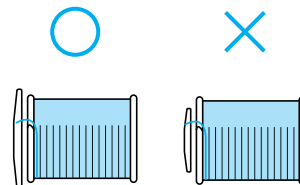

Threading the upper thread

Set the spool of thread on the spool pin, and then thread the machine.

CAUTION

- When threading the upper thread, carefully follow the instructions. If the upper threading is not correct, the thread may become tangled or the needle may bend or break.

1 Turn on the machine.

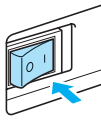

2 Raise the presser foot lever.

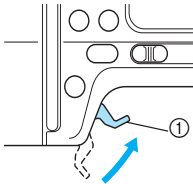

① Presser foot lever

- ▶ The presser foot is raised.



Memo

- If the presser foot is not raised, the sewing machine cannot be threaded.

3 Press \oplus (Needle position button) once or twice to raise the needle.

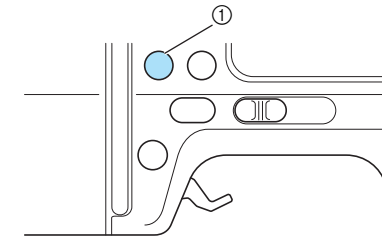

① Needle position button

Note

- The needle is correctly raised when the mark on the handwheel is at the top, as shown below. Check the handwheel and, if this mark is not at this position, press \oplus (Needle position button) until it is.

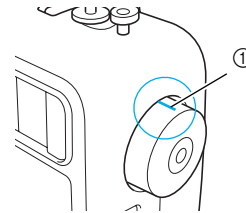

① Mark on handwheel

4 Pick up the spool pin and remove the spool cap that is inserted onto the spool pin.

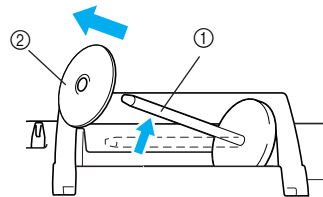

① Spool pin
② Spool cap

5 Place the spool of thread onto the spool pin. Slide the spool onto the pin so that the spool is horizontal and the thread unwinds to the front at the bottom.

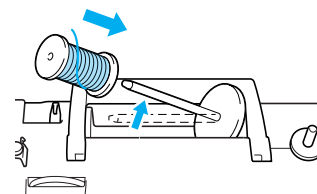

- 6 Slide the spool cap onto the spool pin and return the spool pin to its original position. Slide the spool cap as far as possible to the right as shown, with the rounded side on the left.

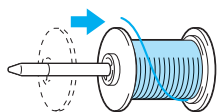

CAUTION

- If the spool or the spool cap is not positioned correctly, the thread may become tangled around the spool pin or the needle may break.

- 7 Pull the thread from the spool and pass the thread under the hook of the thread guide.

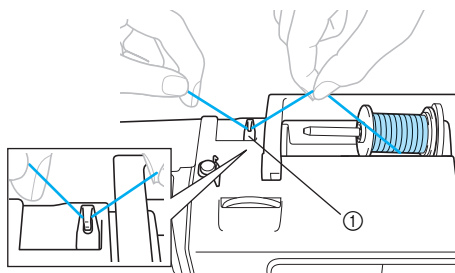

① Thread guide

- 8 Pass the thread behind the thread guide cover and to the front.

While holding the thread near the spool with your right hand, pull the thread with your left hand as shown below.

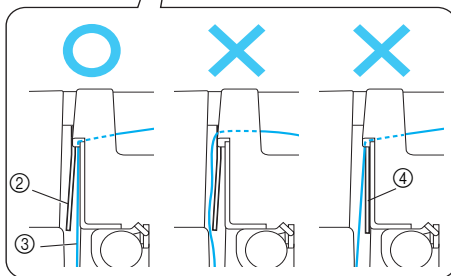
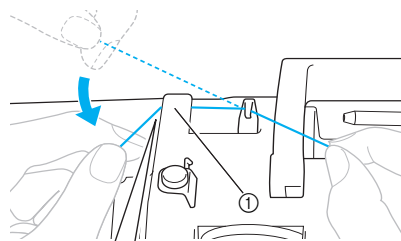

- ① Thread guide cover
- ② Thread guide spring
- ③ Thread
- ④ When the presser foot lever is lowered

Note

- When passing the thread behind the thread guide cover, be sure to use both hands. If you do not hold the thread with your right hand, the thread will be loose and you will not be able to secure the thread in the thread spring guide. It may cause incorrect thread tension.
- Make sure that the presser foot lever is raised before passing the thread behind the thread guide cover. If the presser foot lever is lowered, the thread guide spring is shut and you cannot hang the thread on the thread guide spring correctly.

- 9 Pass the thread through the guides in the order shown below.

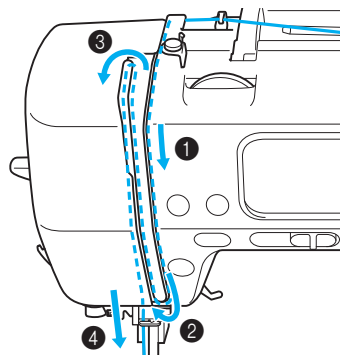

- 10** Make sure that the thread is passed into the thread take-up lever as shown below.

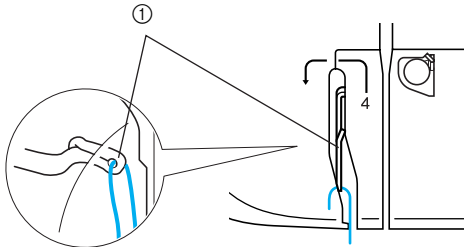

① Thread take-up lever



Memo

- If the needle is not raised, you cannot pass the thread into the thread take-up lever. Be sure to press the needle position button to raise the needle before passing the thread into the thread take-up lever.

- 11** Pass the thread behind the needle bar thread guide.

The thread can easily be passed behind the needle bar thread guide by holding the thread in your left hand, then feeding the thread with your right hand, as shown.

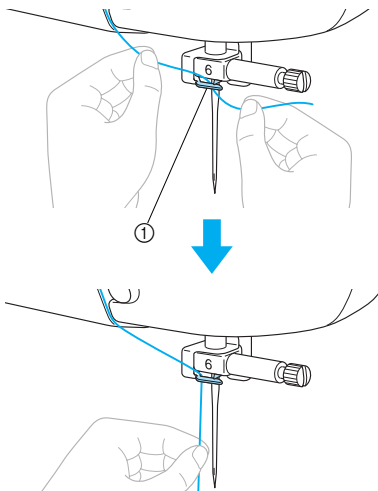

① Needle bar thread guide

- 12** Lower the presser foot lever to lower the presser foot.

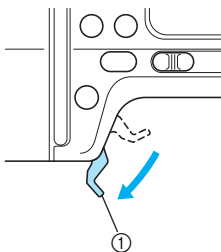

① Presser foot lever

- 13** Turn off the machine.

- 14** Pull the end of the thread, which has been passed through the needle bar thread guide, to the left, then pass the thread through the notch of the thread guide (①), and then firmly pull the thread from the front and insert it into the slit of the thread guide disk marked "7" all the way (②).

Make sure that the thread passes the notch of the thread guide.

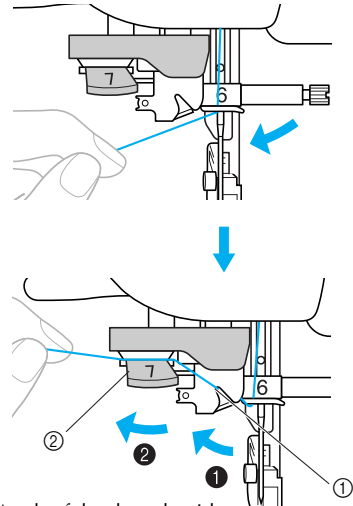

① Notch of the thread guide
② Thread guide disk

- 15** Cut the thread with the cutter on the left side of the machine.

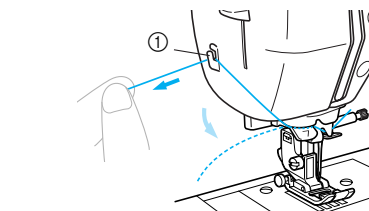

① Thread cutter

- 16** Lower the needle threader lever on the left side of the machine as much as possible to make the hook turn.

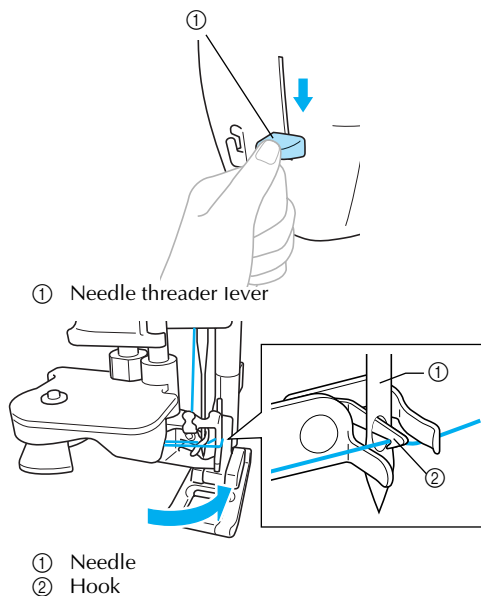

Note

- If the needle threader lever is not lowered as much as possible, the hook will not turn fully as shown below and the thread will not pass through the eye of the needle. In such a case, start from **14** again.

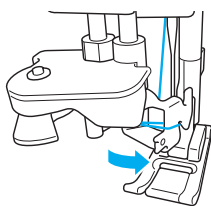

- If the needle is not raised, the needle threader cannot thread the needle. Be sure to press **+** (Needle position button) to raise the needle before using the needle threader. For details, refer to step **3** of "Threading the upper thread" (page 32).

- 17** Raise the needle threader lever slowly.

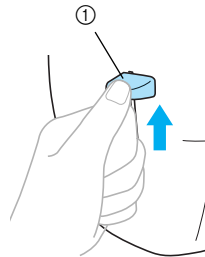

- ① Needle threader lever

- 18** Raise the presser foot lever, and carefully pull the loop of the thread through the eye of the needle to pull out the end of the thread.

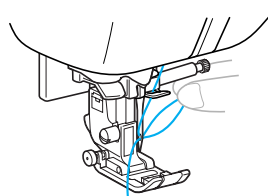

CAUTION

- Do not touch a button. Do not touch the start/stop button, needle position button or reverse/reinforcement stitch button. If one of the buttons is accidentally pressed, the machine will begin sewing and your finger may be pricked with the needle or the needle may break.
- When pulling out the thread, do not pull it with extreme force, otherwise the needle may bend or break.

- 19** Pass the end of the thread through the presser foot, and then pull out about 5 cm (2 inches) of thread toward the rear of the machine.

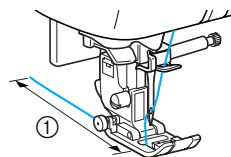

- ① 5 cm (2 inches)

- ▶ The upper threading is finished.

■ Threading the needle manually (without using the needle threader)

When using specialty thread, such as transparent nylon thread or metallic thread, a wing needle or a twin needle which cannot be used with the needle threader, thread the needle as described below.

① Thread the machine to the needle bar thread guide according to steps ① through ⑪ on "Threading the upper thread" (page 32).

② Lower the presser foot lever.

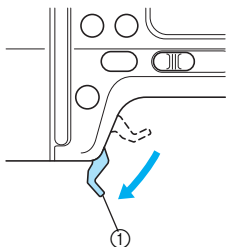

① Presser foot lever

③ Pass the thread through the eye of the needle from front to back.

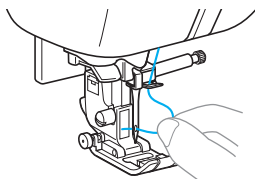

! CAUTION

- Do not touch the start/stop button, needle position button or reverse/reinforcement stitch button. If one of the buttons is accidentally pressed, the machine will begin sewing and your finger may be pricked with the needle or the needle may break.

④ Raise the presser foot lever, pass the end of the thread through the opening in the presser foot, and pull out about 5 cm (2 inches) of thread toward the rear of the machine.

Using the twin needle

With the twin needle, you can sew two parallel lines of the same stitch with two different threads. Both upper threads should have the same thickness and quality. Be sure to use the twin needle and the extra spool pin.

For details on the stitches that can be sewn with the twin needle, refer to "Stitch Setting Chart" (page 72).

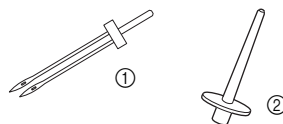

- ① Twin needle
- ② Extra spool pin

! CAUTION

- The twin needle (part code: X59296-121) is recommended. Use of any other needle may bend the needle or damage the machine.
- Never use bent needles. Bent needles can easily break, possibly resulting in injuries.

① Install the twin needle.

- For details on installing a needle, refer to "Replacing the needle" (page 41).

② Thread the upper thread for the left needle eye.

For details, refer to steps ① through ⑪ of "Threading the upper thread" (page 32).

③ Manually thread the left needle with the upper thread.

Pass the thread through the eye of the needle from the front.

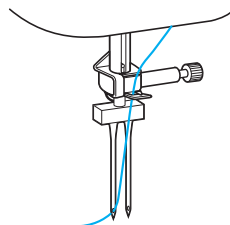

! CAUTION

- The needle threader cannot be used with the twin needle. If the needle threader is used with the twin needle, the sewing machine may be damaged.

- 4 Insert the extra spool pin into the end of the bobbin winder shaft, and install the thread spool on it. Then, thread the upper thread.

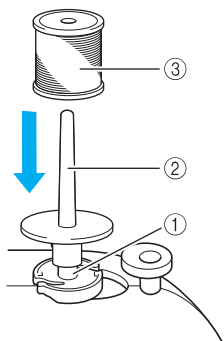

- ① Bobbin winder shaft
- ② Extra spool pin
- ③ Thread spool



Memo

- When setting the thread spool, set it so that the thread winds off from the front of the spool.

- 5 Thread the upper thread for the right side in the same way that the upper thread for the left side was threaded.

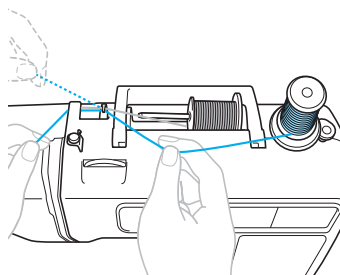

- For details, refer to steps 7 through 10 of "Threading the upper thread" (page 32).

- 6 Without passing the thread through the needle bar thread guide, manually thread the right needle.

Pass the thread through the eye of the needle from the front.

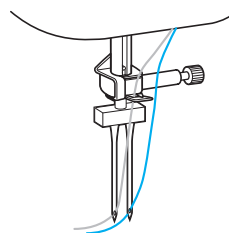

CAUTION

- The needle threader cannot be used with the twin needle. If the needle threader is used with the twin needle, the sewing machine may be damaged.

- 7 Attach zigzag foot "J".
For details on changing the presser foot, refer to "Replacing the Presser Foot" (page 43).

CAUTION

- When using the twin needle, be sure to attach zigzag foot "J". If bunched stitches occur, use presser foot "N" or use a lightweight tear-away stabilizer.

- 8 Turn on the sewing machine and select a stitch.

- For stitch selection see "Selecting stitching" (page 51).
- See "Stitch Setting Chart" (page 72) for stitches that use a twin needle.

CAUTION

- When using the twin needle, be sure to select an appropriate stitch, otherwise the needle may break or the machine may be damaged.

- 9 Press  .

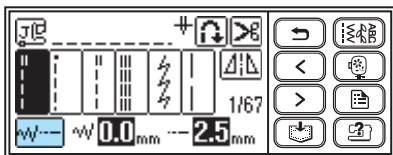

- ▶ The screen for setting the twin needle appears.

- 10 Press  .

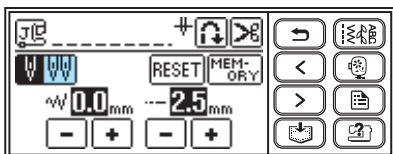



- ▶  displays in reverse highlight.

The twin needle can now be used.



Memo

- If  is pressed again, it returns to  .

- 11 Press  (Back key).

- ▶ The initial screen appears again, and  appears.

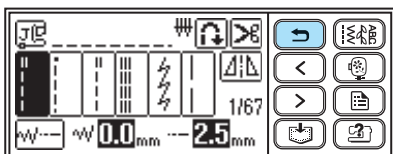

! CAUTION

- When using the twin needle, be sure to select the twin needle setting, otherwise the needle may break or the machine may be damaged.

- 12 Start sewing.

- For details on starting to sew, refer to "Starting to sew" (page 55).
- ▶ Two lines of stitching are sewn parallel to each other.

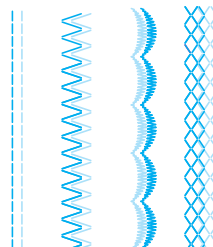

Note

- When changing the sewing direction, press  (Needle position button) to raise the needle from the fabric, and then raise the presser foot lever and turn the fabric.

! CAUTION

- Do not try turning the fabric with twin needle in the down position, otherwise the needle may break or the machine may be damaged.

Replacing the Needle

This section describes how to replace the needle.

Needle precautions

CAUTION

- Only use home sewing machine needles. Use of any other needle may bend the needle or damage the machine.
- Never use bent needles. Bent needles can easily break, possibly resulting in injuries.

Selecting the needle depending on the thread and fabric types

The sewing machine needle that should be used depends on the fabric and thread thickness. Refer to the following table when choosing the thread and needle appropriate for the fabric that you wish to sew.

Fabric Type/Application		Thread		Size of Needle
		Type	Size	
Medium weight fabrics	Broadcloth	Cotton thread	60–90	75/11–90/14
	Taffeta	Synthetic thread		
	Flannel, Gabardine	Silk thread	50	
Thin fabrics	Lawn	Cotton thread	60–90	65/9–75/11
	Georgette	Synthetic thread		
	Challis, Satin	Silk thread	50	
Thick fabrics	Denim	Cotton thread	30	100/16
			50	90/14–100/16
	Corduroy	Synthetic thread	50–60	
Tweed	Silk thread			
Stretch fabrics	Jersey	Thread for knits	50–60	Ball point needle (gold colored) 75/11–90/14
	Tricot			
Easily frayed fabrics		Cotton thread	50–90	65/9–90/14
		Synthetic thread		
		Silk thread	50	
For top-stitching		Synthetic thread	30	100/16
		Silk thread	50–60	75/11–90/14



Note

- Never use a thread of weight 130/20 or lower. It may cause malfunctions.

**Memo**

- The lower the thread number is, the thicker the thread, and the higher the needle number, the thicker the needle.
- A 75/11 needle is already installed when the sewing machine is purchased.

Ball point needle (gold colored)

To avoid skipped stitches use ball point needles with stretch fabrics.

Transparent nylon thread

Use a 90/14 to 100/16 needle, regardless of the fabric or thread.

Embroidery needles

Use a 75/11 home sewing machine needle. When embroidering on thick fabrics such as denim, use a 90/14 or 100/16 home sewing machine needle.

**CAUTION**

- **The appropriate fabric, thread and needle combinations are shown in the table (page 39). If the combination of the fabric, thread and needle is not correct, particularly when sewing thick fabrics (such as denim) with thin needles (such as 65/9 to 75/11), the needle may bend or break. In addition, the stitching may be uneven or puckered or there may be skipped stitches.**

Checking the needle

Sewing with a bent needle is extremely dangerous since the needle may break while the machine is being operated.

Before using the needle, place the flat side of the needle on a flat surface and check that the distance between the needle and the flat surface is even.

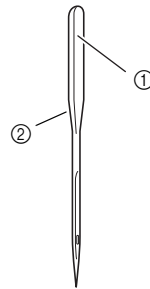

- ① Flat side
- ② Needle type marking

**CAUTION**

- **If the distance between the needle and the flat surface is not even, the needle is bent. Do not use a bent needle.**

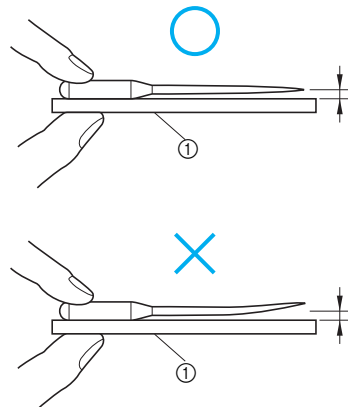

- ① Flat surface

Replacing the needle

Use the screwdriver and a needle that has been determined to be straight according to the instructions in "Checking the needle" (page 40).

- 1 Press  (Needle position button) once or twice to raise the needle.

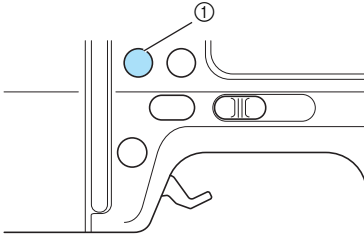

① Needle position button

- 2 Turn off the sewing machine.

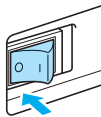

CAUTION

- Before replacing the needle, be sure to turn off the sewing machine. Otherwise, injuries may occur if one of the operation buttons is accidentally pressed and the machine starts sewing.

- 3 Place fabric or paper under the presser foot and cover the holes on the needle plate.



Note

- Before replacing the needle, place fabric or paper under the presser foot to prevent the needle from falling into the holes in the needle plate.

- 4 Lower the presser foot lever.

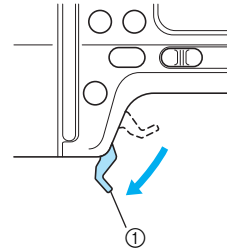

① Presser foot lever

- 5 Hold the needle with your left hand, and then use a screwdriver to turn the needle clamp screw toward you (counterclockwise) to remove the needle.

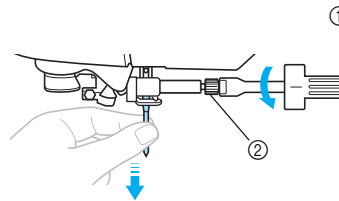

① Screwdriver
② Needle clamp screw

- Do not apply a strong force when loosening or tightening the needle clamp screw, otherwise certain parts of the sewing machine may be damaged.

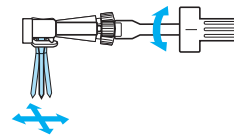

- 6 With the flat side of the needle toward the rear of the machine, insert the needle until it touches the needle stopper.

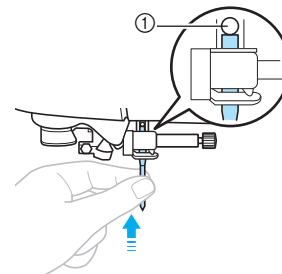

① Needle stopper

- 7** While holding the needle with your left hand, use the screwdriver to tighten the needle clamp screw.

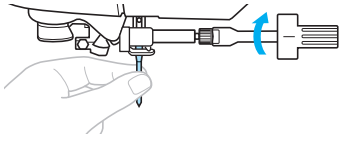

Install the twin needle in the same way.

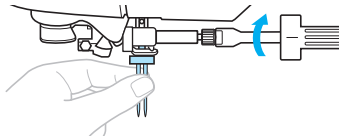

! CAUTION

- Be sure to insert the needle until it touches the needle stopper and securely tighten the needle clamp screw with the screwdriver. Otherwise, the needle may break or damage may result.

Replacing the Presser Foot

This section describes how to replace the presser foot.

Presser foot precautions

Be sure to observe the following precautions concerning the presser foot.

CAUTION

- Use the presser foot appropriate for the type of stitch that you wish to sew, otherwise the needle may hit the presser foot, causing the needle to bend or break.
- Only use presser feet designed specifically for this sewing machine. Use of any other presser foot may result in injuries or damage to the machine.

Replacing the presser foot

Replace the presser foot as described below.



Memo

- For details on attaching the embroidery foot "Q", refer to "Attaching the Embroidery Foot" (page 138).
- Zigzag foot "J" is already installed when the sewing machine is purchased.

- 1 Press  (Needle position button) once or twice to raise the needle.

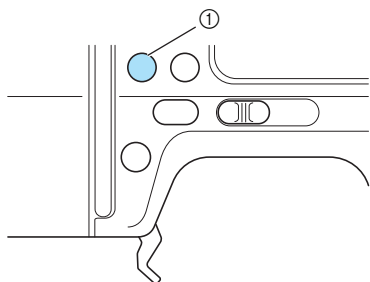

① Needle position button

- 2 Turn off the sewing machine.

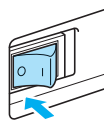

CAUTION

- Before replacing the presser foot, be sure to turn off the sewing machine. Otherwise, injuries may occur if one of the operation buttons is accidentally pressed and the machine starts sewing.

- 3 Raise the presser foot lever.

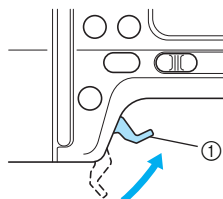

① Presser foot lever

▶ The presser foot is raised.

- 4 Press the black button at the back of the presser foot holder.

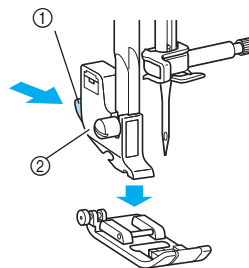

① Black button

② Presser foot holder

▶ The presser foot holder releases the presser foot.

- 5 Place a different presser foot below the holder so that the presser foot pin is aligned with the notch in the holder.**

Position the presser foot so the letter indicating the presser foot type (A, G, I, J, M, N or R) is positioned to be read.

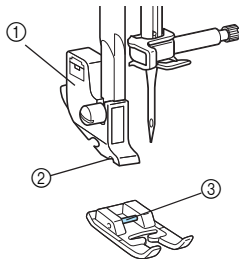

- ① Presser foot holder
- ② Notch
- ③ Pin

- 6 Slowly lower the presser foot lever so that the presser foot pin snaps into the notch in the presser foot holder.**

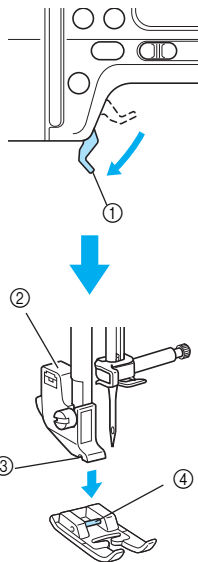

- ① Presser foot lever
- ② Presser foot holder
- ③ Notch
- ④ Pin

▶ The presser foot is attached.

- 7 Raise the presser foot lever to check that the presser foot is securely attached.**

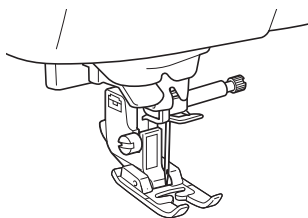

Note

- When a stitch is selected, the icon for the presser foot that should be used appears in the screen. Check that the correct presser foot is attached before starting to sew. If the wrong presser foot is installed, turn off the sewing machine, attach the correct presser foot, and then select the desired stitch again.

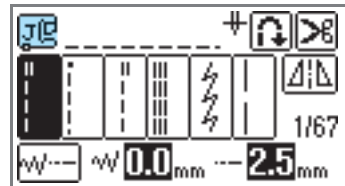

 Buttonhole foot "A"

 Overcasting foot "G"

 Zigzag foot "J"

 Button fitting foot "M"

 Monogramming foot "N"

 Blind stitch foot "R"

 Side cutter "S" (option)

- For details on the presser foot that should be used with the selected stitch, refer to "Stitch Setting Chart" (page 72).

Removing and attaching the presser foot holder

Remove the presser foot holder when cleaning the sewing machine or when installing a presser foot that does not use the presser foot holder, such as the embroidery foot, optional free-motion open toe quilting foot "O" and optional walking foot. Use the screwdriver to remove the presser foot holder.

CAUTION

- Before attaching/removing the presser foot, be sure to turn off the sewing machine. Otherwise, injuries may occur if one of the operation buttons is accidentally pressed and the machine starts sewing.

1 Remove the presser foot.

- For details, refer to "Replacing the presser foot" (page 43).

2 Use the screwdriver to loosen the presser foot holder screw.

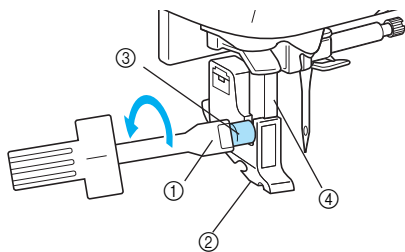

- ① Screwdriver
- ② Presser foot holder
- ③ Presser foot holder screw
- ④ Presser bar

- ▶ The presser foot is removed from the presser bar.

■ Attaching the presser foot holder

1 Raise the presser foot lever.

- ▶ The presser foot is raised.

2 Align the presser foot holder with the lower-left side of the presser bar.

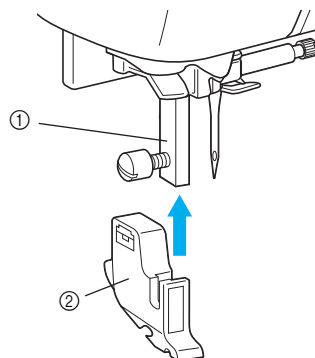

- ① Presser bar
- ② Presser foot holder

3 Hold the presser foot holder in place with your right hand, and then tighten the screw using the screwdriver in your left hand.

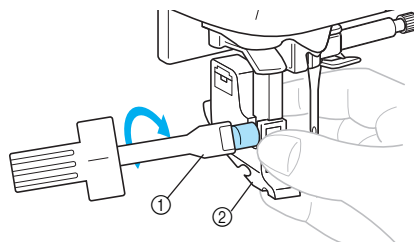

- ① Screwdriver
- ② Presser foot holder

CAUTION

- Do not hit the needle with your finger or the presser foot when attaching/removing it. The needle may break or cause injury.
- Be sure to tighten the screw with the included screwdriver. If the screw is loose, the needle may hit the presser foot and break or bend.

Sewing Cylindrical Pieces and Large Pieces

Free-arm sewing and using an extension table make sewing cylindrical pieces or large pieces easy.

Free-arm sewing

Removing the flat bed attachment allows for free-arm sewing, making it easier to sew cylindrical pieces such as sleeve cuffs and pant legs.

1 Remove the flat bed attachment.

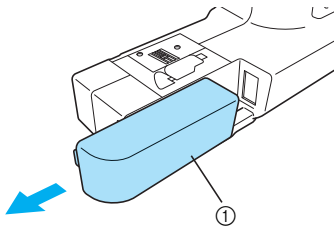

① Flat bed attachment

▶ With the flat bed attachment removed, free-arm sewing is possible.

2 Slide the part that you wish to sew onto the arm, and then sew from the top.

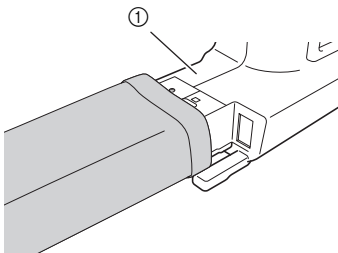

① Arm

3 When you have finished free-arm sewing, reconnect the flat bed attachment.

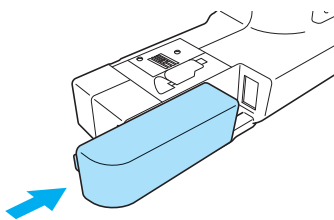

Using extension table

The cover of the embroidery unit can be used as the extension table. This is useful for sewing large pieces.

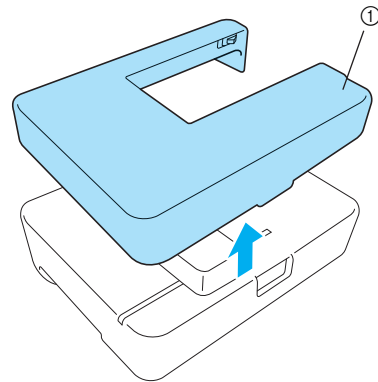

① Cover of embroidery unit (extension table)

! CAUTION

- Do not move the sewing machine with the extension table attached.
- Do not use the extension table in any other way than how it is intended.

1 Remove the flat bed attachment.

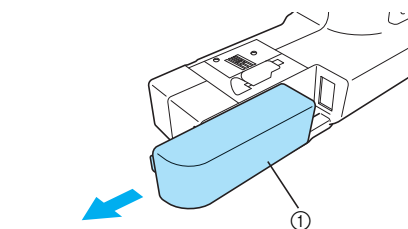

① Flat bed attachment

- 2 Raise up the two legs on the reverse side of the extension table until they click.

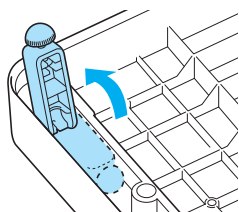

- 3 Attach the extension table to the sewing machine arm.

Keep the extension table horizontal and push it in slowly until it stops.

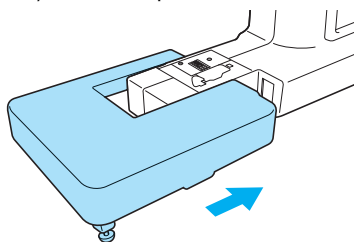

Memo

- If the extension table is not stable or its height is improper, adjust its height by turning the rubber ends of legs.

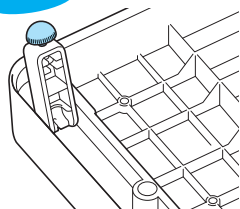

- 4 When you have finished sewing, remove the extension table by pulling it to the left. Then reinstall the flat bed attachment to its original position.

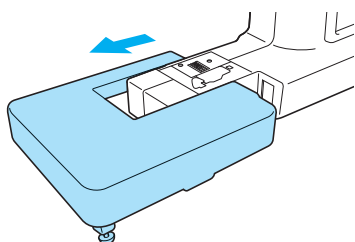

- 5 Turn back the extension table, and then store the two legs in their original positions.

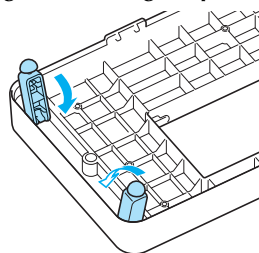

Memo

- When you do not use the extension table, use it as the cover of the embroidery unit.

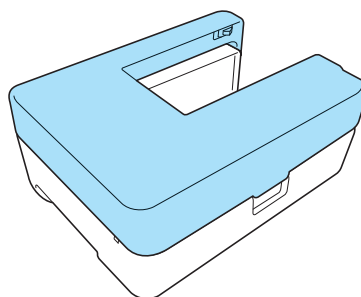



SEWING BASICS

The necessary preparations for sewing are described in this chapter.

Sewing.....	50
Setting the Stitch	61
Useful Functions.....	64
Useful Sewing Tips	68

Sewing

Basic sewing operations are described below.

Before operating the sewing machine, read the following precautions.



CAUTION

- While the machine is in operation, pay special attention to the needle location. In addition, keep your hands away from all moving parts such as the needle and handwheel, otherwise injuries may occur.
- Do not pull or push the fabric too hard while sewing, otherwise injuries may occur or the needle may break.
- Never use bent needles. Bent needles can easily break, possibly resulting in injuries.
- Make sure that the needle does not strike basting pins, otherwise the needle may break or bend.

General sewing procedure

Follow the basic procedures below to sew.

1	Attach the presser foot.	Attach the presser foot that is appropriate for the type of stitch that you wish to sew. Be sure to turn off the main power before replacing the presser foot. For details on replacing the presser foot, refer to "Replacing the presser foot" (page 43).
↓		
2	Turn on the machine.	Turn on the sewing machine. For details on turning on the machine, refer to "Turning on the machine" (page 17).
↓		
3	Select the stitch.	Select the stitch appropriate for the area to be sewn. For details on selecting a stitch, refer to "Selecting stitching" (page 51).
↓		
4	Position the fabric.	Place the area to be sewn under the presser foot. Be sure that the fabric pieces are sewn in the correct order and that the right and wrong sides of the fabric are aligned correctly. For details on positioning the fabric, refer to "Positioning the fabric" (page 54).
↓		
5	Start sewing.	Start sewing. For details on starting to sew, refer to "Starting to sew" (page 55).
↓		
6	Cut the thread.	Cut the thread at the end of sewing. Automatic thread cutting is also possible. For details on cutting the thread, refer to "Cutting the thread" (page 59).

Stitch types

A stitch can be selected from the following types available.

For details on the various stitches, refer to "Stitch Setting Chart" (page 72).

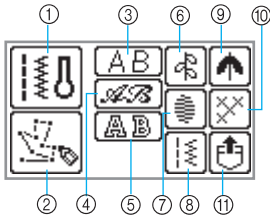



- ① **Utility stitches** 

You can select from 67 utility stitches, including straight line stitching, overcasting, button holes and basic decorative stitches. If this is selected, the utility stitch selection appears right after the power is turned on.
- ② **My Custom Stitch** 

You can design original stitches. (For details, refer to "Designing a Pattern (My Custom Stitch)" (page 131).)
- ③ **Character stitches-Gothic font** 

(Can be combined)
There are 55 characters, including letters, symbols and numbers, in the Gothic font.
- ④ **Character stitches-Script font** 

(Can be combined)
There are 55 characters, including letters, symbols and numbers, in the Script font.
- ⑤ **Character stitches-Outline style** 

(Can be combined)
There are 55 characters, including letters, symbols and numbers, in the outline style.
- ⑥ **Decorative stitches** 

(Can be combined)
You can select from 30 decorative stitches, including leaves, flowers and hearts. You can sew combinations of multiple decorative stitches.
- ⑦ **Satin stitches** 

(Can be combined)
You can select from 16 satin stitches. You can sew combinations of multiple decorative stitches.
- ⑧ **Combined utility stitches** 

(Can be combined)
You can sew with combinations from 39 utility stitches.
- ⑨ **Decorative satin stitches** 

(Can be combined)
There are 9 decorative satin stitches.
- ⑩ **Cross stitches** 

(Can be combined)
You can select from 7 cross stitches. You can sew combinations of multiple decorative stitches.

- ⑪ **Patterns saved in the machine's memory** 

You can retrieve a saved pattern. (For details, refer to "Saving patterns" (page 129).)

Selecting stitching

Stitches are selected using LCD operations. Turn the power on, the utility stitch selecting screen appears. Depending on the setting, either the straight stitch (left needle position) or the straight stitch (center needle position) is automatically selected.

- 1 **Determine the stitch to be used, and select the recommended presser foot.**
 - Refer to "Stitch Setting Chart" (page 72).
- 2 **Attach the presser foot.**

The machine comes with zigzag foot "J" attached.

 - For details, refer to "Replacing the presser foot" (page 43).

CAUTION

- Use the presser foot appropriate for selected stitch. If the wrong presser foot is used, the needle may hit the presser foot and bend or break.

- 3 **Turn on the sewing machine.**

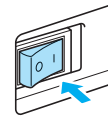

- When an animation is displayed on the screen, touch the LCD with your finger.
- ▶ The straight stitch (left needle position) or the straight stitch (center needle position) is shown selected on the screen.

- 4 **Press  (Utility stitch key) on the operation panel.**

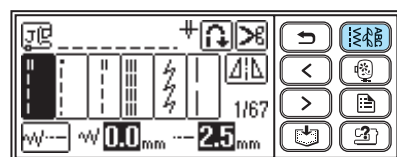

5 Select the stitch type.

- When selecting a decorative stitch



▶ The screen containing the various stitches in the selected stitch type appears.

- To select a different stitch type, press (Back key).

6 Select a stitch.

(Previous page key) displays the previous page, and (Next page key) displays the next page.

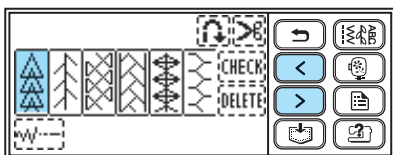

Memo

- When touching the screen with your finger is difficult, use the included touch pen.

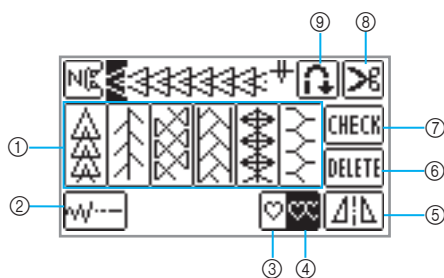

- ① Selects decorative stitch
- ② Sets width and length
- ③ Selects single stitch sewing
- ④ Selects repeat sewing
- ⑤ Makes horizontal mirror image
- ⑥ Deletes a selected pattern
- ⑦ Used for checking combined pattern
- ⑧ Activates automatic thread cutting
- ⑨ Activates automatic reverse/reinforcement stitch

- To select a different stitch, press to remove the selected pattern.

7 If necessary, specify the settings for automatic reverse/reinforcement stitching and adjust the stitch length, etc.

- For details on sewing with each of the utility stitches, refer to Chapter3, "UTILITY STITCHES" which begins from page 72.



Note

- When a stitch is selected, the icon for the presser foot that should be used appears on the screen. Check that the correct presser foot is attached before starting to sew. If the wrong presser foot is installed, turn off the sewing machine, attach the correct presser foot, and then select the desired stitch again.



Memo

- For details on setting automatic reverse/reinforcement stitching etc., refer to "Useful Functions" (page 64).
- For details on adjusting the stitch width, stitch length and thread tension, refer to "Setting the Stitch" (page 61).

■ Selecting utility stitches

1 Follow steps 1 to 3 in "Selecting stitching" (page 51).

2 Select a stitch.

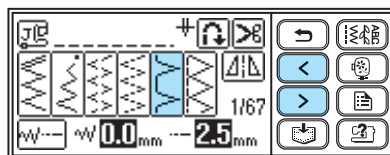

Memo

- The utility stitch selection screen appears when you turn on the machine.

Example: When is selected:

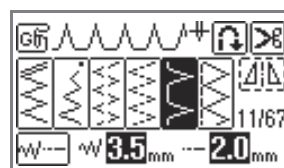

■ Selecting characters

Three styles of character stitches are available. The procedure for selecting a character is the same with all styles.

1 Follow steps 1 to 4 in "Selecting stitching" (page 51) to display the screen where a stitch type can be selected.

2 Select the character style.

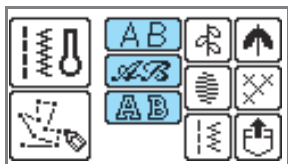

3 Select the characters.



- If a wrong character was selected, press **DELETE** to erase the character, and then select the correct character
- To select a different character style, press **↵**, and then select the desired character style.
- Press **CHECK** to view a sample of the selected pattern.

□ Example: BUS



Positioning the fabric

Be sure that the fabric pieces are sewn in the correct order and that the right and wrong sides of the fabric are aligned correctly.

- 1 Turn on the machine.

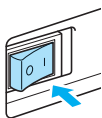

- 2 Press \oplus (Needle position button) once or twice to raise the needle.

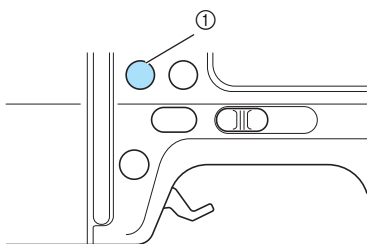

① Needle position button

- 3 Place the fabric under the presser foot.



Memo

- If the seam allowance is positioned on the right side, sewing in a straight line is easier and the extra fabric does not get in the way.

- 4 While holding the end of the thread and the fabric with your left hand, turn the handwheel toward you (counterclockwise) with your right hand to lower the needle to the starting point of the stitching.

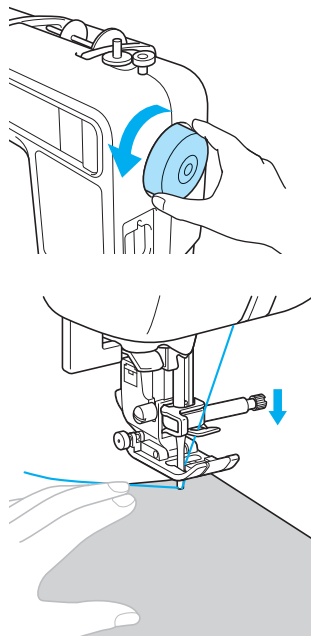

- 5 Lower the presser foot lever.

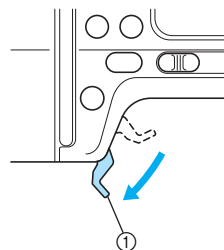

① Presser foot lever

- The fabric is now positioned to be sewn.

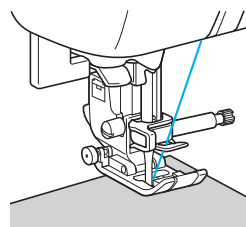

Starting to sew

Once you are ready to start sewing, you can start the sewing machine. Sewing can be started and stopped using the operation button (⏻) (Start/stop button) or the foot controller. For details on the foot controller, refer to next page.



Memo

- When the foot controller is plugged in, (⏻) (Start/stop button) cannot be used to start sewing.

■ Using the operation button

Sewing can be started and stopped using the operation button (⏻) (Start/stop button).

- 1 Slide the sewing speed controller to the left or right to select the desired sewing speed. Slide the sewing speed controller to the left to sew at a slower speed, or slide the speed controller to the right to sew at a faster speed.

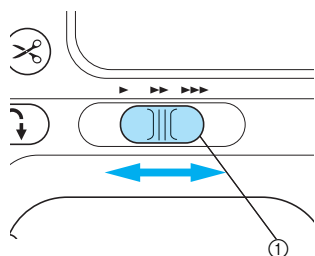

① Sewing speed controller

- 2 Press (⏻) (Start/stop button) once.

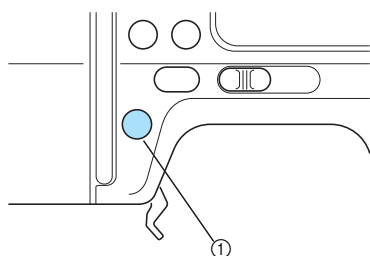

① Start/stop button

- ▶ The machine starts sewing.

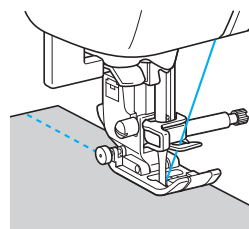

Memo

- The machine will sew at a slow speed at the beginning of sewing.
- If you press and hold the (⏻) (Start/stop button) while sewing, the machine will sew at a slow speed. If you use this function at the point just before the position where you want to stop the machine, you can stop the machine with more precision.

- 3 When the end of the stitching is reached, press (⏻) (Start/stop button) once.
 - ▶ The machine stops sewing with the needle lowered (in the fabric).

- 4 Cut the threads.

- For details, refer to "Cutting the thread" (page 59).



Note

- This machine will automatically stop when the bobbin becomes almost empty. When the machine stops, replace the bobbin thread, and then press (⏻) (Start/stop button) to begin sewing again.

■ Using the foot controller

Sewing can be started and stopped using the foot controller.

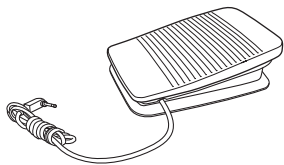

1 Turn off the sewing machine.

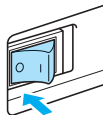

Note

- When connecting the foot controller, be sure to turn off the sewing machine in order to prevent the machine from accidentally being started.

2 Insert the foot controller plug into its jack on the right side of the sewing machine.

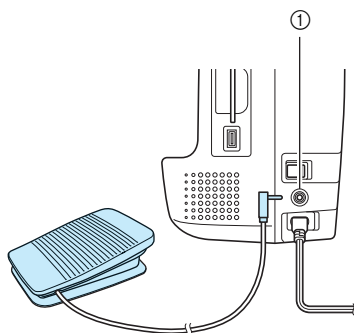

① Foot controller jack

3 Turn on the machine.

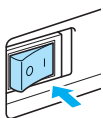

4 Slide the sewing speed controller to the left or right to select the desired sewing speed.

Slide the sewing speed controller to the left to sew at a slower speed, or slide the speed controller to the right to sew at a faster speed.

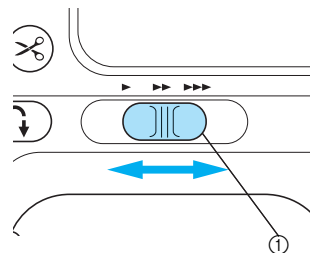

① Sewing speed controller

- ▶ The speed set using the sewing speed controller is the foot controller's maximum sewing speed.

5 Once you are ready to start sewing, slowly press down on the foot controller.

Pressing down on the foot controller increases the sewing speed; releasing the pressure on the foot controller decreases the sewing speed.

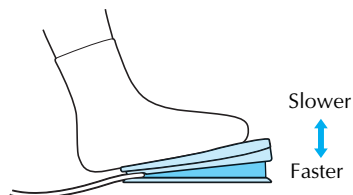

- Slowly press down on the foot controller. Pressing it down hard starts sewing too quickly.
- ▶ The machine starts sewing.

6 When the end of the stitching is reached, completely release the foot controller.

- ▶ The machine stops sewing with the needle lowered (in the fabric).

7 Cut the threads.

- For details, refer to "Cutting the thread" (page 59).



Memo

- When the foot controller is plugged in, ① (Start/stop button) cannot be used to start sewing.
- When sewing is stopped, the needle remains lowered (in the fabric). The machine can be set so that the needle will stay up when sewing is stopped. For details on setting the machine so that the needle stays up when sewing is stopped, refer to "Changing the machine settings" (page 18).



CAUTION

- Do not allow thread or dust to accumulate in the foot controller, otherwise a fire or an electric shock may occur.
- Do not place objects on the foot controller, otherwise damage to the machine or injuries may occur.
- If the machine is not to be used for a long period of time, unplug the foot controller, otherwise a fire or an electric shock may occur.

Securing the stitching

When sewing with the straight stitch, for example, at the end of an opening or where seams do not overlap, use reverse stitching or reinforcement stitching to secure the end of the thread.

- 1 Lower the needle into the fabric at the beginning of the stitching, then lower the presser foot.

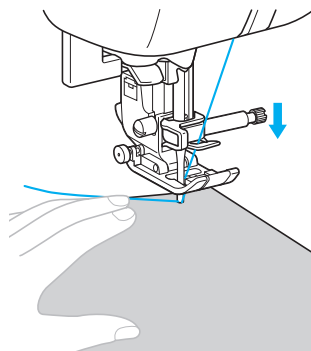



- 2 Press ① (Start/stop button), or press down on the foot controller.

At this time, if ① (Start/stop button) is held down, the machine sews at a slow speed.

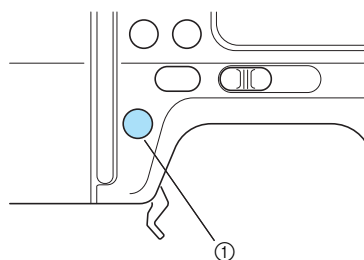
- For details, refer to "Starting to sew" (page 55).



- ① Start/stop button
- ▶ The machine starts sewing.

- 3** After sewing 3 to 5 stitches, press  (Reverse/reinforcement stitch button). Keep  (Reverse/reinforcement stitch button) held down until you reach the beginning of the stitching.

- The machine sews at a slow speed when  (Reverse/reinforcement stitch button) is held down.

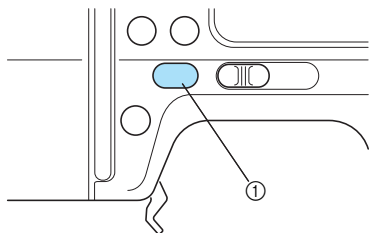

① Reverse/reinforcement stitch button

- ▶ While  (Reverse/reinforcement stitch button) is held down, reverse stitches are sewn.



- 4** After sewing back to the beginning of the stitching, release  (Reverse/reinforcement stitch button).

- ▶ The machine stops sewing.

- 5** Press  (Start/stop button), or press down on the foot controller.

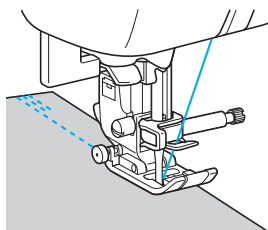
- ▶ The machine starts sewing in the normal sewing direction.



- 6** When the end of the stitching is reached, press  (Reverse/reinforcement stitch button). Keep  (Reverse/reinforcement stitch button) held down until 3 to 5 reverse stitches are sewn.

- ▶ While  (Reverse/reinforcement stitch button) is held down, reverse stitches are sewn.

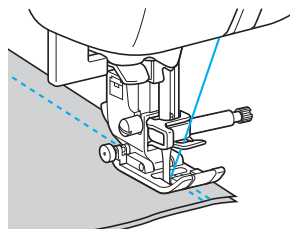

- 7** After 3 to 5 reverse stitches have been sewn, release  (Reverse/reinforcement stitch button).

- ▶ The machine stops sewing.

- 8** Press  (Start/stop button), or press down on the foot controller.

At this time, if  (Start/stop button) is held down, the machine sews at a slow speed.

- ▶ The machine starts sewing in the normal sewing direction.



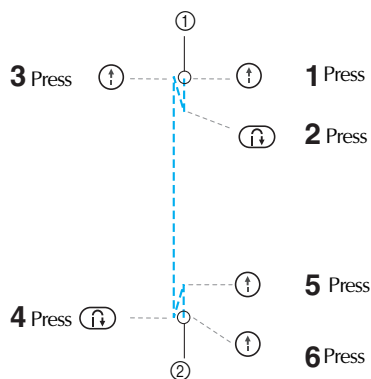

- 9** After sewing to the end of the stitching, the sewing machine stops.

Release  (Start/stop button) or foot controller.



① Beginning of stitching
② End of stitching

■ Sewing stitches

When  (Reverse/reinforcement stitch button) is pressed with stitches other than 1 , 3  and 7  stitches, reinforcement stitches are used.

Reinforcement stitches are 3 to 5 stitches sewn on top of each other in one place.

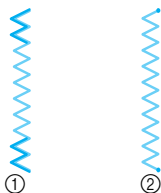

- ① Reverse stitching
- ② Reinforcement stitching



Memo

- The sewing machine can be set to automatically sew reverse or reinforcement stitches at the beginning and end of the stitching. For details, refer to "Automatic sewing reverse/reinforcement stitches" (page 64).

Cutting the thread

When you have finished sewing, cut the thread.

■ Using the thread cutter button

- ① When you wish to finish the stitching, press  (Thread cutter button) once.

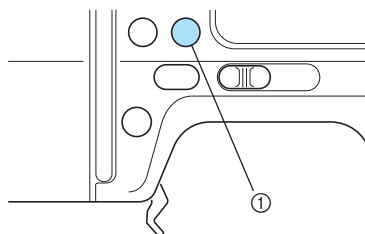

- ① Thread cutter button
- ▶ The threads are cut and the needle is raised.



Note

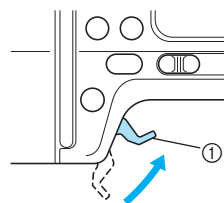

- The thread cutter button cannot be used when the presser foot lever is raised.

- ② Raise the presser foot lever, then remove the fabric.



- ① Presser foot lever

! CAUTION

- Do not press  (Thread cutter button) after threads have already been cut, otherwise the needle may break, the threads may become tangled or damage to the machine may occur.
- Do not press  (Thread cutter button) if there is no fabric under the presser foot or while the machine is sewing, otherwise damage to the machine may occur.



Memo

- The machine can be set so that the thread will be cut automatically when sewing is finished. For details, refer to "Automatically cutting the thread" (page 65).

■ Using the thread cutter

When sewing with nylon or metallic threads, or other special threads, use the thread cutter on the side of the machine to cut the threads.

- ① When you wish to finish the stitching and the sewing machine is stopped, press  (Needle position button) once to raise the needle.

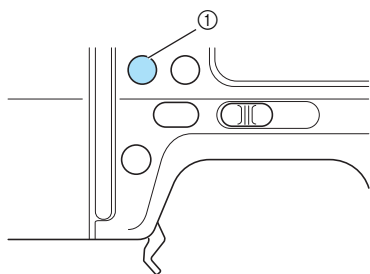

① Needle position button

- ② Raise the presser foot lever.

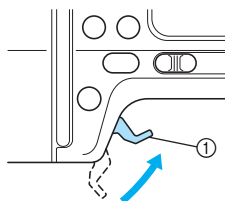

① Presser foot lever

- ③ Pull the fabric to the left side of the machine, and then pass the threads through the thread cutter to cut them.

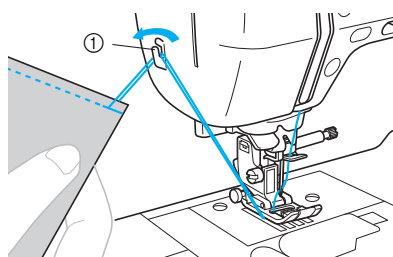

① Thread cutter

Setting the Stitch

This machine is preset with the default settings for the stitch width and stitch length for each stitch. However, you can change any of the settings by pressing  in the screen, then follow the procedure described in this section.

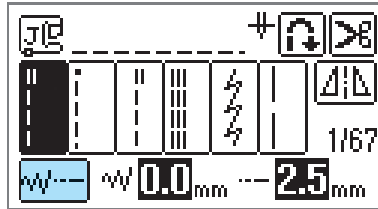



Note

- Settings for some stitches cannot be changed. For details, refer to "Stitch Setting Chart" (page 72).
- Stitch settings return to their defaults if they are changed, when the machine is turned off or a different stitch is selected before the stitch setting is saved. If you want to save settings, refer to "Saving stitch settings" (page 67).

Adjusting the stitch width

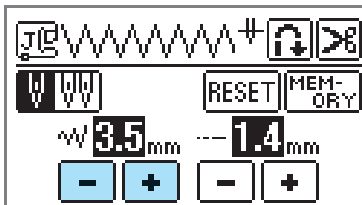
The stitch width (zigzag width) can be adjusted to make the stitch wider or narrower.





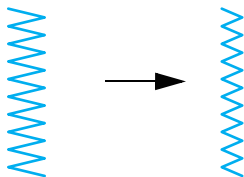

Each press of  makes the zigzag stitch narrower.

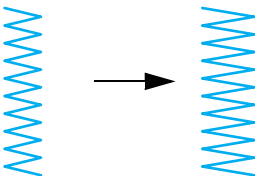

Each press of  makes the zigzag stitch wider.



Memo

-  means the setting cannot be adjusted.
- If the straight stitch (left needle position or triple stretch stitch) was selected, changing the stitch width changes the needle position. Increasing the width  moves the needle to the right; reducing the width  moves the needle to the left. For details, refer to "Changing the needle position" (page 83).
- Press  to return the setting to its default.
- If the foot controller is connected, the sewing speed controller can be used to adjust the zigzag width. For details, refer to "Satin stitching using the sewing speed controller" (page 107).

CAUTION

- After adjusting the stitch width, slowly turn the handwheel toward you (counterclockwise) and check that the needle does not touch the presser foot. If the needle hits the presser foot, the needle may bend or break.

Adjusting the stitch length

The stitch length can be adjusted to make the stitch coarser or finer.

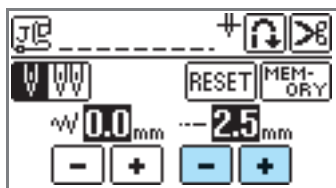

Each press of  makes the stitch finer (shorter).

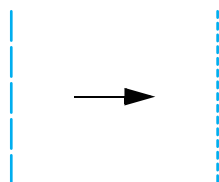

Each press of  makes the stitch coarser (longer).

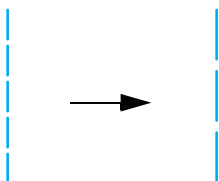

Memo

-  means the setting cannot be adjusted.
- Press **RESET** to return the setting to its default.

CAUTION

- **If the stitches are bunched together, increase the stitch length. Continuing to sew with the stitches bunched together may result in the needle bending or breaking.**

Adjusting the thread tension

You may need to change the thread tension, depending on the fabric and thread being used.

Correct thread tension

The upper thread and the bobbin thread should cross near the center of the fabric. Only the upper thread should be visible from the right side of the fabric, and only the bobbin thread should be visible from the wrong side of the fabric.

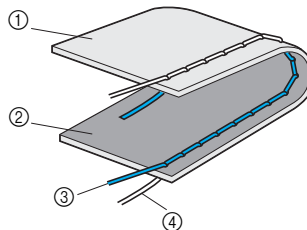

- ① Wrong side of fabric
- ② Right side of fabric
- ③ Upper thread
- ④ Bobbin thread

Upper thread is too tight

If the bobbin thread is visible from the right side of the fabric, the upper thread is too tight.



Note

- If the bobbin thread was incorrectly threaded, the upper thread may be too tight. In this case, refer to "Installing the bobbin" (page 27) and rethread the bobbin thread.

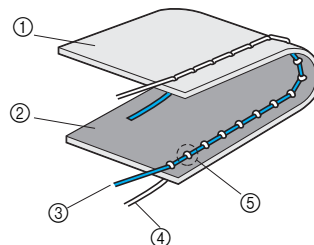

- ① Wrong side of fabric
- ② Right side of fabric
- ③ Upper thread
- ④ Bobbin thread
- ⑤ The bobbin thread is visible from the right side of the fabric.

Turn the thread tension dial to the left to loosen the upper thread.





Memo

- When you finish sewing, remove the bobbin cover and then make sure that the thread is shown as below. If the thread is not shown as below, the thread is not inserted through the tension-adjusting spring of the bobbin case correctly. Reinsert the thread correctly. For details, refer to page 29.

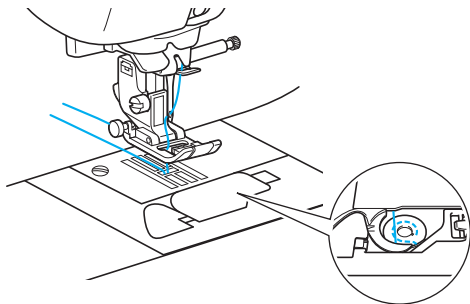

■ Upper thread is too loose

If the upper thread is visible from the wrong side of the fabric, the upper thread is too loose.



Note

- If the upper thread was incorrectly threaded, the upper thread may be too loose. In this case, refer to "Threading the upper thread" (page 32) and rethread the upper thread.

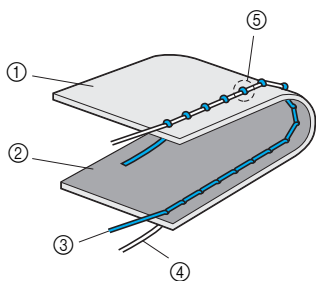

- ① Wrong side of fabric
- ② Right side of fabric
- ③ Upper thread
- ④ Bobbin thread
- ⑤ The upper thread is visible from the wrong side of the fabric.

Turn the thread tension dial to the right to tighten the upper thread.



Memo

- If the upper thread is not threaded correctly or the bobbin is not installed correctly, it may not be possible to set the correct thread tension. If the correct thread tension cannot be achieved, rethread the upper thread and insert the bobbin correctly.
- The level "4" on the tension dial is a guide for working normal fabrics (medium weight). However, the actual stitch tension you'll want to use will vary according to the fabric and thread you are using, so you should always sew a stitch sample and adjust stitch tension before beginning on the actual piece to be worked.
- The machine may stop sewing if tension is set extremely low. This is not a sign that there is anything wrong with your machine. Simply adjust to the correct stitch tension and begin again.

Useful Functions

Functions useful in improving sewing efficiency are described below.

Automatic sewing reverse/reinforcement stitches

The sewing machine can be set to automatically sew reverse or reinforcement stitches at the beginning and end of the stitching. Depending on the selected stitch, reverse stitches or reinforcement stitches are automatically set. For details on reverse/reinforcement stitching, refer to "Stitch Setting Chart" (page 72).

1 Turn on the machine.

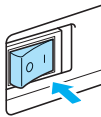



- ▶ The LCD comes on.

2 Select a stitch.

- For details on selecting a stitch, refer to "Selecting stitching" (page 51).

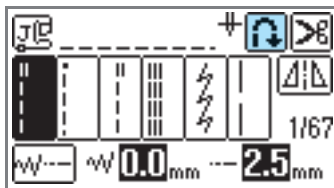
3 Press on the LCD.



- ▶ It turns to , and the sewing machine is set for automatic reverse/reinforcement stitching.

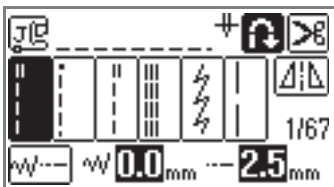

Memo

- To turn automatic reverse/reinforcement stitching off, press .
- When the sewing machine is turned off, the automatic reverse/reinforcement stitching setting is cancelled.
- When the stitch such as those for sewing buttonholes and bar tacks is selected, reinforcement stitches are automatically sewn.

4 Position the fabric under the presser foot, and then press (Start/stop button) once.

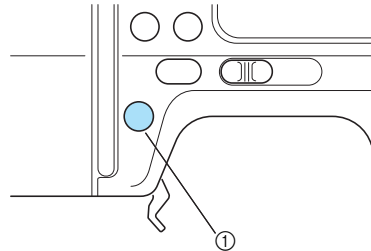

- ① Start/stop button

- ▶ Stitching starts after reverse stitching or reinforcement stitching.

5 After reaching the end of the stitching, press (Reverse/reinforcement stitch button) once.

Buttonholes or bar tacking require reinforcement stitching making this operation unnecessary.

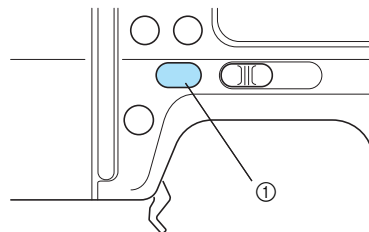

- ① Reverse/reinforcement stitch button

- ▶ After reverse/reinforcement stitches are sewn, the sewing machine stops.

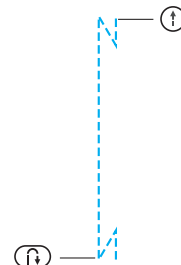



Memo

- Press (Start/stop button) when you want to stop the sewing machine in the middle of sewing without reverse stitching or reinforcement stitching (for example, when you want to change the sewing direction). The sewing machine stops without reverse stitching or reinforcement stitching. Press (Reverse/reinforcement stitch button) at the end of the stitching.

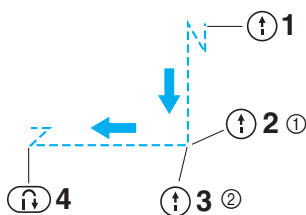

- ① Stop the machine and change the sewing direction.
- ② Start the machine again.

Automatically cutting the thread

The sewing machine can be set to automatically cut the threads at the end of the stitching. This is called "programmed thread-cutting". If programmed thread-cutting is set, automatic reverse/reinforcement stitching is also set.

1 Turn on the machine.

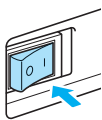

- ▶ The LCD comes on.

2 Press the stitch selection.

- For details on selecting a stitch, refer to "Selecting stitching" (page 51).

3 Press on the screen.

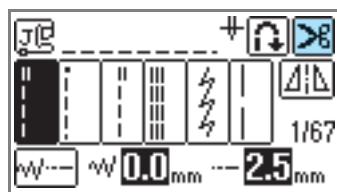

- ▶ You get , and the sewing machine is set for programmed thread-cutting and automatic reverse/reinforcement stitching.

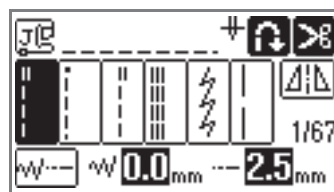

Memo

- To turn programmed thread cutting off, press .

4 Position the fabric under the presser foot, and then press (Start/stop button) once.

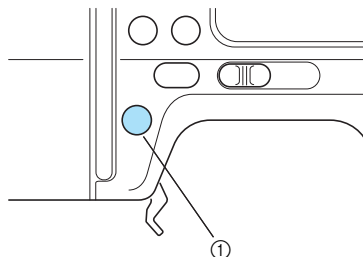

- ① Start/stop button
- ▶ Stitching starts after reverse stitching or reinforcement stitching.



5 After reaching the end of the stitching, press (Reverse/reinforcement stitch button) once.

Buttonholes or bar tacking require reinforcement stitching making this operation unnecessary.

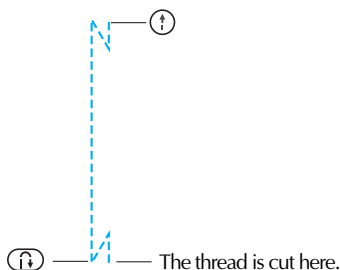
- ▶ After the reverse stitching or reinforcement stitching has been done, the sewing machine stops, and the thread is cut.



Memo

- Press  (Start/stop button) when you want to stop the sewing machine in the middle of sewing without programmed thread-cutting (for example, when you want to change the sewing direction). The sewing machine stops without programmed thread cutting. Press  (Reverse/reinforcement stitch button) at the end of the stitching.

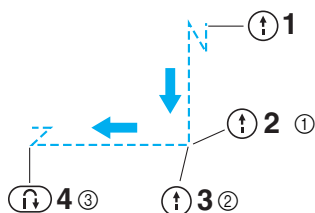

- ① Stop the machine and change the sewing direction.
 - ② Start the machine again.
 - ③ The thread is cut here.
- If the power is turned off, programmed thread-cutting will be turned off.

Mirroring stitches

You can sew the mirror image of a stitch horizontally (left and right).

1 Turn on the machine.

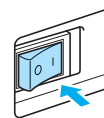



- ▶ The LCD comes on.

2 Select a stitch.

- For details on selecting a stitch, refer to "Selecting stitching" (page 51).

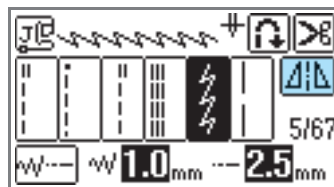

3 Press on the screen.

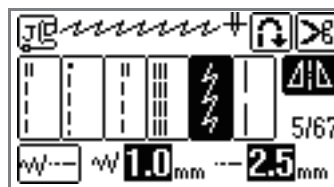

- ▶ It turns to , and the pattern displayed at the top of the screen is mirrored.



Memo

- To cancel the mirror image setting, press .
- Mirror image is not possible for buttonholes and other stitches where  shows.
- When the sewing machine is turned off, the mirror image setting is cancelled.

Saving stitch settings

This machine is preset with the default settings for the stitch width (zigzag width), stitch length, programmed thread-cutting, and automatic reverse/reinforcement stitching for each stitch. However, if you wish to save specific settings for a stitch so that they can be used later, press **MEM-ORY** after changing the settings to save the new settings with the selected stitch. This feature can be used only with utility stitches. The settings you saved will not be cleared if the machine is turned off.

■ To use a stitch length of 2.0 mm for the straight stitch

① Select a straight stitch.

② Press **WV---**.



Memo

- The default stitch length is 2.5 mm.

③ Set the stitch length to 2.0 mm.

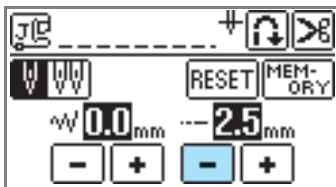

④ Press **MEM-ORY**.

- To reset the selected stitch patterns to its default settings, press **RESET**, and then press **MEM-ORY**.

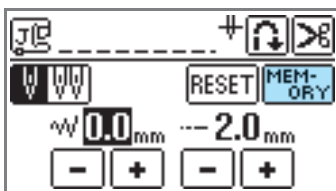

- ▶ The confirmation message is displayed.

⑤ Press **OK**.

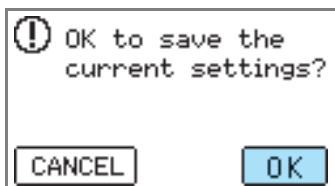

- ▶ The next time that the same straight stitch is selected, the stitch length is set to 2.0 mm.



Note

- All stitch settings (stitch width (zigzag width), stitch length, programmed thread-cutting, and automatic reverse/reinforcement stitching, etc.) are saved, not just the setting that was changed. When the same stitch pattern is selected, the last settings saved are displayed even if the machine was turned off. If the settings are changed again and **MEM-ORY** is pressed, or if **RESET** is pressed to reset the setting to its default, the new settings are not saved unless **MEM-ORY** is pressed another time. Even if **RESET** is pressed, the settings for programmed thread-cutting and automatic reverse/reinforcement stitching are saved in the machine.

Useful Sewing Tips

Various ways to achieve better results for your sewing projects are described below. Refer to these tips when sewing your project.

Trial sewing

After you have set up the machine with the thread and needle appropriate for the type of fabric being sewn, the machine automatically sets the stitch length and width for the stitch that is selected. However, a trial piece of fabric should be sewn. Depending on the type of fabric and stitching being sewn, the desired results may vary. For trial sewing, use a piece of fabric and thread that are the same as those used for your project, and check the thread tension and stitch length and width. Since the results may vary depending on the type of stitching and the number of layers of fabric sewn, perform the trial sewing under the same conditions that will be used with your project.

Changing the sewing direction

- 1 **When the stitching reaches a corner, stop the sewing machine.**

Leave the needle lowered (in the fabric). If the needle remained up when the machine stopped sewing, press \oplus (Needle position button) to lower the needle.

- 2 **Raise the presser foot lever, and then turn the fabric.**

Turn the fabric using the needle as a pivot.

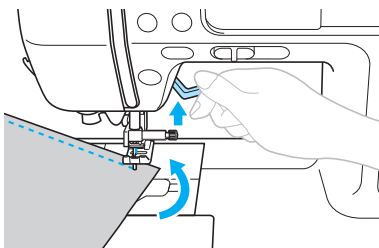

- 3 **Lower the presser foot lever and continue sewing.**

Sewing curves

Stop sewing, and then slightly change the sewing direction to sew around the curve. For details on sewing with an even seam allowance, refer to "Sewing an even seam allowance" (page 70).

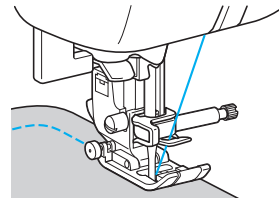

When sewing along a curve while using a zigzag stitch, select a shorter stitch length in order to obtain a finer stitch.

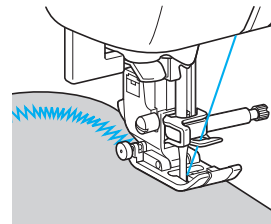

Sewing thick fabrics

- **If the fabric does not fit under the presser foot**

Raise the presser foot lever even higher to bring the presser foot to its highest position.

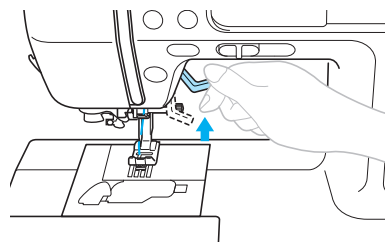

■ If thick seams are being sewn and the fabric does not feed at the beginning of stitching

The fabric may not feed when thick seams are being sewn and the presser foot is not level, as shown below. In this case, use the presser foot locking pin (black button on the left side of zigzag foot "J") so that the presser foot remains level while sewing, allowing the fabric to be fed smoothly.

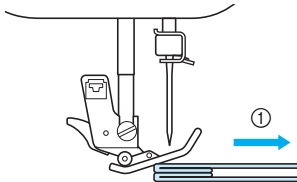

① Sewing direction

- ① **Raise the presser foot lever.**
- ② **Align the beginning of stitching, and then position the fabric.**
- ③ **While holding zigzag foot "J" level, hold the presser foot locking pin (black button on the left side) pressed in, and lower the presser foot lever.**

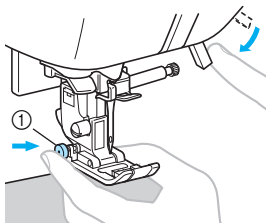

① Presser foot locking pin (black button)

- ④ **Release the presser foot locking pin (black button).**
 - ▶ The presser foot remains level, allowing the fabric to be fed.

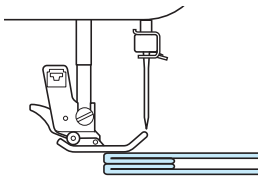

- After the seam is sewn, the presser foot will return to its original angle.

! CAUTION

- If fabric more than 6 mm (15/64 inch) thick is sewn or if the fabric is pushed with too much force, the needle may bend or break.

Sewing hook-and-loop fastener

! CAUTION

- Use only the unglued hook-and-loop fastener designed for sewing. If the glue adheres to the needle or the bobbin hook race, it may cause malfunction.
- If the hook-and-loop fastener is sewn with a fine needle (65/9-75/11), the needle may bend or break.

Note

- Before starting to sew, baste the fabric and hook-and-loop together.

Make sure that the needle passes through the hook-and-loop fastener by turning the handwheel and lower the needle into the hook-and-loop fastener before sewing. And then, sew the edge of the hook-and-loop fastener at a slow speed.

If the needle does not pass through the hook-and-loop fastener, replace the needle with the needle for thick fabrics (page 39).

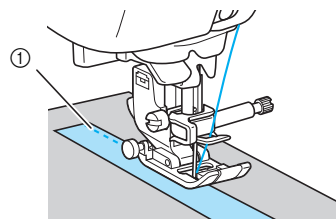

① Edge of the hook-and-loop fastener

Sewing thin fabrics

When sewing thin fabrics, the stitching may become misaligned or the fabric may not feed correctly. If this occurs, place thin paper or stabilizer material under the fabric and sew it together with the fabric. When you have finished sewing, tear off any excess paper.

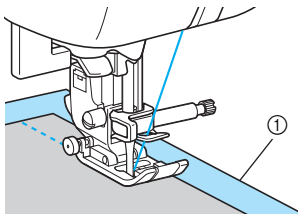

① Stabilizer material or paper

Sewing stretch fabrics

First, baste the pieces of fabric together, and then sew without stretching the fabric.

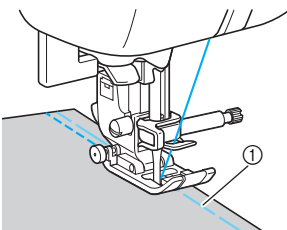

① Basting

Using the stretch stitches or the thread for knits gives an attractive finish.

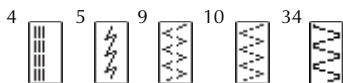

Sewing an even seam allowance

To sew an even seam, start sewing so that the seam allowance is to the right of the presser foot, and the edge of the fabric is aligned with either the right edge of the presser foot or a marking on the needle plate.

■ Aligning the fabric with the presser foot

Sew while keeping the right edge of the presser foot aligned with a fixed distance from the edge of the fabric.

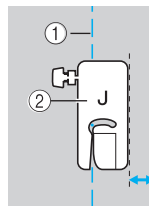

- ① Seam
- ② Presser foot



Memo

- If the straight stitch (left needle position, triple stretch stitch, basting stitch etc.) is selected, you can change the distance between the seam and the right edge of the presser foot by changing the stitch width. For details, refer to "Changing the needle position" (page 83).

■ Aligning the fabric with a needle plate marking

The markings on the needle plate show the distance from the needle position of a seam sewn with the straight stitch (left needle position). Sew while keeping the edge of the fabric aligned with a marking in the needle plate. The distance between the markings in the upper scale is 1/8 inch (3 mm) and the distance between the markings in the grid is 5 mm (3/16 inch).

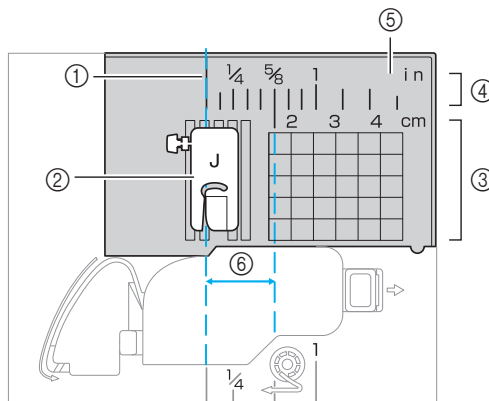

- ① Seam
- ② Presser foot
- ③ Centimeters
- ④ Inches
- ⑤ Needle plate
- ⑥ 1.6 cm (5/8 inch)

3

UTILITY STITCHES

















The various stitches and their applications are described in this chapter.



















Stitch Setting Chart	72
Overcasting Stitches.....	78
Basic Stitching.....	82
Blind Hem Stitching	84
Buttonhole Stitching/Button Sewing.....	87
Zipper Insertion.....	94
Sewing Stretch Fabrics and Elastic Tape.....	99
Appliqué, Patchwork and Quilt Stitching	101
Reinforcement Stitching.....	108
Eyelet Stitching.....	113
Decorative Stitching.....	114
Sewing the Various Built-in Decorative Patterns.....	122
Designing a Pattern (My Custom Stitch).....	131













Stitch Setting Chart





















Applications, stitch lengths and widths and whether the twin needle can be used are listed for utility stitches in the following table.

Utility stitches

Stitch Name	Pattern	Presser Foot	Application	Stitch Width [mm (inch)]		Stitch Length [mm (inch)]		Twin Needle	Reverse/ Reinforcement Stitching	Walking Foot	
				Auto	Manual	Auto	Manual				
Straight stitch	Left		J	Basic stitching, sewing gathers or pintucks, etc.	0.0 (0)	0.0–7.0 (0–1/4)	2.5 (3/32)	0.2–5.0 (1/64–3/16)	Yes (J)	Reverse	No
			J	Basic stitching and sewing gathers or pintucks	0.0 (0)	0.0–7.0 (0–1/4)	2.5 (3/32)	0.2–5.0 (1/64–3/16)	Yes (J)	Reinforcement	Yes
	Center		J/I	Attaching zippers, basic stitching, sewing gathers or pintucks, etc.	3.5 (1/8)	0.0–7.0 (0–1/4)	2.5 (3/32)	0.2–5.0 (1/64–3/16)	Yes (J)	Reverse	No
Triple stretch stitch		J	Attaching sleeves, sewing inseams, sewing stretch fabrics and decorative stitching	0.0 (0)	0.0–7.0 (0–1/4)	2.5 (3/32)	1.5–4.0 (1/16–3/16)	Yes (J)	Reinforcement	No	
Stretch stitch		J	Sewing stretch fabrics and decorative stitching	1.0 (1/16)	1.0–3.0 (1/16–1/8)	2.5 (3/32)	1.0–4.0 (1/16–3/16)	Yes (J)	Reinforcement	No	
Basting stitch		J	Temporarily securing	0.0 (0)	0.0–7.0 (0–1/4)	–	–	No	Reinforcement	No	
Zigzag stitch	Center		J	Overcasting and attaching appliqués	3.5 (1/8)	0.0–7.0 (0–1/4)	1.4 (1/16)	0.0–4.0 (0–3/16)	Yes (J)	Reverse	No
	Right		J	Beginning sewing from the right needle position	3.5 (1/8)	2.5–5.0 (3/32–3/16)	1.4 (1/16)	0.3–4.0 (1/64–3/16)	Yes (J)	Reinforcement	Yes
2-point zigzag stitch		J	Overcasting on mediumweight or stretch fabrics, attaching elastic, darning, etc.	5.0 (3/16)	1.5–7.0 (1/16–1/4)	1.0 (1/16)	0.2–4.0 (1/64–3/16)	Yes (J)	Reinforcement	Yes	
3-point zigzag stitch		J	Overcasting on mediumweight or stretch fabrics, attaching elastic, darning, etc.	5.0 (3/16)	1.5–7.0 (1/16–1/4)	1.0 (1/16)	0.2–4.0 (1/64–3/16)	Yes (J)	Reinforcement	No	
Overcasting stitch		G	Overcasting on thin or mediumweight fabrics	3.5 (1/8)	2.5–5.0 (3/32–3/16)	2.0 (1/16)	1.0–4.0 (1/16–3/16)	No	Reinforcement	No	
		G	Overcasting on thick fabrics	5.0 (3/16)	2.5–5.0 (3/32–3/16)	2.5 (3/32)	1.0–4.0 (1/16–3/16)	No	Reinforcement	No	
		G	Overcasting on thick fabrics and decorative stitching	5.0 (3/16)	3.5–5.0 (1/8–3/16)	2.5 (3/32)	1.0–4.0 (1/16–3/16)	No	Reinforcement	No	
		J	Overcasting on stretch fabrics	5.0 (3/16)	0.0–7.0 (0–1/4)	2.5 (3/32)	0.5–4.0 (1/32–3/16)	Yes (J)	Reinforcement	No	
		J	Overcasting on thick or stretch fabrics	5.0 (3/16)	0.0–7.0 (0–1/4)	2.5 (3/32)	0.5–4.0 (1/32–3/16)	Yes (J)	Reinforcement	No	
		J	Overcasting on stretch fabrics and decorative stitching	5.0 (3/16)	0.0–7.0 (0–1/4)	4.0 (3/16)	1.0–4.0 (1/16–3/16)	Yes (J)	Reinforcement	No	

Stitch Name	Pattern	Presser Foot	Application	Stitch Width [mm (inch)]		Stitch Length [mm (inch)]		Twin Needle	Reverse/Reinforcement Stitching	Walking Foot
				Auto	Manual	Auto	Manual			
Blind hem stitch		R	Blind hem stitching on mediumweight fabrics	00	3← →3	2.0 (1/16)	1.0–3.5 (1/16–1/8)	No	Reinforcement	No
		R	Blind hem stitching on stretch fabrics	00	3← →3	2.0 (1/16)	1.0–3.5 (1/16–1/8)	No	Reinforcement	No
Appliqué stitch		J	Appliqué stitching	3.5 (1/8)	2.5–7.0 (3/32–1/4)	2.5 (3/32)	1.6–4.0 (1/16–3/16)	Yes (J)	Reinforcement	No
Shell tuck stitch		J	Shell tuck stitching	4.0 (3/16)	0.0–7.0 (0–1/4)	2.5 (3/32)	0.2–4.0 (1/64–3/16)	Yes (J)	Reinforcement	No
Piecing straight stitch		J	Piecing straight stitching (with a seam allowance of 6.5 mm (1/4 inch) from the right edge of the presser foot)	5.5 (7/32)	0.0–7.0 (0–1/4)	2.0 (1/16)	0.2–5.0 (1/64–3/16)	No	Reinforcement	No
		J	Piecing straight stitching (with a seam allowance of 6.5 mm (1/4 inch) from the left edge of the presser foot)	1.5 (1/16)	0.0–7.0 (0–1/4)	2.0 (1/16)	0.2–5.0 (1/64–3/16)	No	Reinforcement	Yes
Mock hand-quilting stitch		J	Straight stitch quilting that looks hand-sewn	0.0 (0)	0.0–7.0 (0–1/4)	2.5 (3/32)	1.0–4.0 (1/16–3/16)	No	Reinforcement	No
Zigzag stitch (for quilting)		J	Appliqué quilting, free-motion quilting, satin stitching	3.5 (1/8)	0.0–7.0 (0–1/4)	1.4 (1/16)	0.0–4.0 (0–3/16)	No	Reinforcement	Yes
Appliqué stitch (for quilting)		J	Attaching appliques and binding	1.5 (1/16)	0.5–3.5 (1/32–1/8)	1.8 (1/16)	1.0–4.0 (1/16–3/16)	No	Reinforcement	No
Quilting stitch (for stippling)		J	Quilting background stitching (stippling)	7.0 (1/4)	1.0–7.0 (1/16–1/4)	1.6 (1/16)	1.0–4.0 (1/16–3/16)	No	Reinforcement	No
Satin scallop stitch		N	Scallop stitching	5.0 (3/16)	2.5–7.0 (3/32–1/4)	0.5 (1/32)	0.1–1.0 (1/64–1/16)	Yes (J)	Reinforcement	No
Joining stitch		J	Patchwork stitching and decorative stitching	4.0 (3/16)	0.0–7.0 (0–1/4)	1.2 (1/16)	0.2–4.0 (1/64–3/16)	Yes (J)	Reinforcement	No
		J	Patchwork stitching, decorative stitching and sewing overcasting on both pieces of fabric, such as with tricot	5.0 (3/16)	2.5–7.0 (3/32–1/4)	2.5 (3/32)	1.0–4.0 (1/16–3/16)	Yes (J)	Reinforcement	No
		J	Patchwork stitching and decorative stitching	5.0 (3/16)	0.0–7.0 (0–1/4)	1.2 (1/16)	0.2–4.0 (1/64–3/16)	Yes (J)	Reinforcement	No
Smocking stitch		J	Smocking stitching and decorative stitching	5.0 (3/16)	0.0–7.0 (0–1/4)	1.6 (1/16)	1.0–4.0 (1/16–3/16)	Yes (J)	Reinforcement	No
Fagoting stitch		J	Fagoting and decorative stitching	5.0 (3/16)	0.0–7.0 (0–1/4)	2.5 (3/32)	1.0–4.0 (1/16–3/16)	Yes (J)	Reinforcement	No
		J	Fagoting and decorative stitching	5.0 (3/16)	2.5–7.0 (3/32–1/4)	2.5 (3/32)	1.0–4.0 (1/16–3/16)	Yes (J)	Reinforcement	No
Elastic-attaching stitch		J	Attaching elastic to stretch fabrics	4.0 (3/16)	0.0–7.0 (0–1/4)	1.0 (1/16)	0.2–4.0 (1/64–3/16)	Yes (J)	Reinforcement	No

Stitch Name	Pattern	Presser Foot	Application	Stitch Width [mm (inch)]		Stitch Length [mm (inch)]		Twin Needle	Reverse/ Reinforcement Stitching	Walking Foot
				Auto	Manual	Auto	Manual			
Decorative stitch		J	Decorative stitching	4.0 (3/16)	0.0–7.0 (0–1/4)	3.0 (1/8)	2.0–4.0 (1/16–3/16)	No	Reinforcement	No
		J	Decorative stitching	4.0 (3/16)	0.0–7.0 (0–1/4)	2.5 (3/32)	1.0–4.0 (1/16–3/16)	Yes (J)	Reinforcement	No
		J	Decorative stitching	5.5 (7/32)	0.0–7.0 (0–1/4)	1.6 (1/16)	1.0–4.0 (1/16–3/16)	Yes (J)	Reinforcement	No
		N	Decorative stitching and elastic-attaching	5.0 (3/16)	1.5–7.0 (1/16–1/4)	1.0 (1/16)	0.2–4.0 (1/64–3/16)	Yes (J)	Reinforcement	No
		N	Lace sewing, decorative hemming, heirloom stitching, etc.	3.5 (1/8)	1.5–7.0 (1/16–1/4)	2.5 (3/32)	1.6–4.0 (1/16–3/16)	No	Reinforcement	No
		N	Decorative hemming, heirloom stitching, etc.	6.0 (15/64)	1.5–7.0 (1/16–1/4)	3.0 (1/8)	1.5–4.0 (1/16–3/16)	No	Reinforcement	No
		N	Decorative hemming on thin, mediumweight and plain weave fabrics, heirloom stitching, etc.	5.0 (3/16)	1.5–7.0 (1/16–1/4)	3.5 (1/8)	1.5–4.0 (1/16–3/16)	No	Reinforcement	No
		N	Decorative hemming on thin, mediumweight and plain weave fabrics, heirloom stitching, etc.	5.0 (3/16)	1.5–7.0 (1/16–1/4)	4.0 (3/16)	1.5–4.0 (1/16–3/16)	Yes (J)	Reinforcement	No
		N	Decorative hemming on thin, mediumweight and plain weave fabrics, heirloom stitching, etc.	5.0 (3/16)	1.5–7.0 (1/16–1/4)	2.5 (3/32)	1.5–4.0 (1/16–3/16)	Yes (J)	Reinforcement	No
		N	Decorative hemming on thin, mediumweight and plain weave fabrics, heirloom stitching, etc.	5.0 (3/16)	1.5–7.0 (1/16–1/4)	2.0 (1/16)	1.5–4.0 (1/16–3/16)	Yes (J)	Reinforcement	No
		N	Decorative hemming, ribbon threading, heirloom stitching, etc.	5.0 (3/16)	1.5–7.0 (1/16–1/4)	3.0 (1/8)	1.5–4.0 (1/16–3/16)	Yes (J)	Reinforcement	No
		N	Decorative stitching, smocking stitching, heirloom stitching, etc.	6.0 (15/64)	1.5–7.0 (1/16–1/4)	1.6 (1/16)	1.0–4.0 (1/16–3/16)	No	Reinforcement	No
		N	Decorative stitching, smocking stitching, heirloom stitching, etc.	5.0 (3/16)	1.5–7.0 (1/16–1/4)	1.6 (1/16)	1.0–4.0 (1/16–3/16)	No	Reinforcement	No

Stitch Name	Pattern	Presser Foot	Application	Stitch Width [mm (inch)]		Stitch Length [mm (inch)]		Twin Needle	Reverse/ Reinforcement Stitching	Walking Foot
				Auto	Manual	Auto	Manual			
Buttonhole stitch		A	Horizontal buttonholes on thin and mediumweight fabrics	5.0 (3/16)	3.0–5.0 (1/8–3/16)	0.5 (1/32)	0.2–1.0 (1/64–1/16)	No	Automatic reinforcement	No
		A	Horizontal buttonholes on areas that are subject to strain	5.0 (3/16)	3.0–5.0 (1/8–3/16)	0.5 (1/32)	0.2–1.0 (1/64–1/16)	No	Automatic reinforcement	No
		A	Horizontal buttonholes on thick fabrics	5.0 (3/16)	3.0–5.0 (1/8–3/16)	0.5 (1/32)	0.2–1.0 (1/64–1/16)	No	Automatic reinforcement	No
		A	Secured buttonholes for fabrics that have backings	5.0 (3/16)	3.0–5.0 (1/8–3/16)	0.5 (1/32)	0.2–1.0 (1/64–1/16)	No	Automatic reinforcement	No
		A	Buttonholes for stretch or knit fabrics	6.0 (15/64)	3.0–6.0 (1/8–15/64)	1.0 (1/16)	0.5–2.0 (1/32–1/16)	No	Automatic reinforcement	No
		A	Buttonholes for stretch fabrics	6.0 (15/64)	3.0–6.0 (1/8–15/64)	1.5 (1/16)	1.0–3.0 (1/16–1/8)	No	Automatic reinforcement	No
		A	Bound buttonholes	5.0 (3/16)	0.0–6.0 (0–15/64)	2.0 (1/16)	0.2–4.0 (1/64–3/16)	No	Automatic reinforcement	No
		A	Keyhole buttonholes for thick or furry fabrics	7.0 (1/4)	3.0–7.0 (1/8–1/4)	0.5 (1/32)	0.3–1.0 (1/64–1/16)	No	Automatic reinforcement	No
		A	Keyhole buttonholes for mediumweight and thick fabrics	7.0 (1/4)	3.0–7.0 (1/8–1/4)	0.5 (1/32)	0.3–1.0 (1/64–1/16)	No	Automatic reinforcement	No
	A	Horizontal buttonholes for thick or furry fabrics	7.0 (1/4)	3.0–7.0 (1/8–1/4)	0.5 (1/32)	0.3–1.0 (1/64–1/16)	No	Automatic reinforcement	No	
Darning stitch		A	Darning mediumweight fabrics	7.0 (1/4)	2.5–7.0 (3/32–1/4)	2.0 (1/16)	0.4–2.5 (1/64–3/32)	No	Automatic reinforcement	No
		A	Darning thick fabrics	7.0 (1/4)	2.5–7.0 (3/32–1/4)	2.0 (1/16)	0.4–2.5 (1/64–3/32)	No	Automatic reinforcement	No
Bar tack stitch		A	Reinforcing openings and areas where the seam easily comes loose	2.0 (1/16)	1.0–3.0 (1/16–1/8)	0.4 (1/64)	0.3–1.0 (1/64–1/16)	No	Automatic reinforcement	No
Button-sewing stitch		M	Button sewing	3.5 (1/8)	2.5–4.5 (3/32–3/16)	–	–	No	Automatic reinforcement	No
Eyelet stitch		N	Sewing eyelets, for example, on belts	7.0 (1/4)	7.0, 6.0, 5.0 (1/4, 15/64, 3/16)	7.0 (1/4)	7.0, 6.0, 5.0 (1/4, 15/64, 3/16)	No	Automatic reinforcement	No
Side cutter ^{*1}		S	Sewing straight stitches while cutting the fabric	0.0 (0)	0.0–2.5 (0–3/32)	2.5 (3/32)	0.2–5.0 (1/64–3/16)	No	Reinforcement	No
		S	Sewing zigzag stitches while cutting the fabric	3.5 (1/8)	3.5–5.0 (1/8–3/16)	1.4 (1/16)	0.0–4.0 (0–3/16)	No	Reinforcement	No
		S	Overcasting on thin and mediumweight fabrics while cutting the fabric	3.5 (1/8)	3.5–5.0 (1/8–3/16)	2.0 (1/16)	1.0–4.0 (1/16–3/16)	No	Reinforcement	No
		S	Overcasting on thick fabrics while cutting the fabric	5.0 (3/16)	3.5–5.0 (1/8–3/16)	2.5 (3/32)	1.0–4.0 (1/16–3/16)	No	Reinforcement	No
		S	Overcasting on mediumweight and thick fabrics while cutting the fabric	5.0 (3/16)	3.5–5.0 (1/8–3/16)	2.5 (3/32)	1.0–4.0 (1/16–3/16)	No	Reinforcement	No

*1: Side cutter is optional.

Other stitches

Stitch Type	Pattern										Presser Foot	Twin Needle	Pattern Size	Adjustable Stitching Density	Adjustable Pattern Length/width	Left/Right Flipping
Decorative stitches	1	2	3	4	5	6	7	8	9	10	N	No	-	No	Yes	Yes
	11	12	13	14	15	16	17	18	19	20						
	21	22	23	24	25	26	27	28	29	30*						
Satin stitches	1	2	3	4	5	6	7	8	9	10	N	Yes	-	No	Yes	Yes
	11	12	13	14	15	16										
Cross-stitches	1	2	3	4**	5**	6**	7**				N	No	-	No	Yes (**Not possible)	Yes
Decorative satin stitches	1	2	3	4	5	6	7	8	9		N	No	-	Yes	Yes (length only)	Yes
Combined utility stitches	1	2	3	4	5	6***	7	8	9	10	N	No	-	No	Yes (***)length only)	Yes
	11	12	13	14	15	16	17	18	19	20						
	21	22	23	24	25	26	27	28	29	30						
	31	32	33	34	35	36	37	38	39							

*Pattern for making adjustment



Stitch Type	Pattern										Presser Foot	Twin Needle	Pattern Size	Adjustable Stitching Density	Adjustable Pattern Length/width	Left/Right Flipping
Character stitches (Gothic font)	1	2	3	4	5	6	7	8	9	10	N	No	Large, Small	No	No	Yes
	A	B	C	D	E	F	G	H	I	J						
	11	12	13	14	15	16	17	18	19	20						
	K	L	M	N	O	P	Q	R	S	T						
	21	22	23	24	25	26	27	28	29	30						
	U	V	W	X	Y	Z	0	1	2	3						
31	32	33	34	35	36	37	38	39	40							
4	5	6	7	8	9	&	?	!	-							
41	42	43	44	45	46	47	48	49	50							
-	()	'	,	.	Ä	Å	Æ	Ñ							
51	52	53	54	55												
Ö	Ø	Ç	Ü	ß												
Character stitches (Script font)	1	2	3	4	5	6	7	8	9	10	N	No	Large	No	No	Yes
	A	B	C	D	E	F	G	H	I	J						
	11	12	13	14	15	16	17	18	19	20						
	K	L	M	N	O	P	Q	R	S	T						
	21	22	23	24	25	26	27	28	29	30						
	U	V	W	X	Y	Z	0	1	2	3						
31	32	33	34	35	36	37	38	39	40							
4	5	6	7	8	9	&	?	!	-							
41	42	43	44	45	46	47	48	49	50							
-	()	'	,	.	Ä	Å	Æ	Ñ							
51	52	53	54	55												
Ö	Ø	Ç	Ü	ß												
Character stitches (Outline style)	1	2	3	4	5	6	7	8	9	10	N	No	Large, Small	No	No	Yes
	A	B	C	D	E	F	G	H	I	J						
	11	12	13	14	15	16	17	18	19	20						
	K	L	M	N	O	P	Q	R	S	T						
	21	22	23	24	25	26	27	28	29	30						
	U	V	W	X	Y	Z	0	1	2	3						
31	32	33	34	35	36	37	38	39	40							
4	5	6	7	8	9	&	?	!	-							
41	42	43	44	45	46	47	48	49	50							
-	()	'	,	.	Ä	Å	Æ	Ñ							
51	52	53	54	55												
Ö	Ø	Ç	Ü	ß												

Overcasting Stitches

Sew overcasting stitches along the edges of cut fabric to prevent them from fraying. 15 stitches are available for overcasting. The procedure for sewing overcasting stitches is explained according to the presser foot that is used.

Sewing overcasting stitches using overcasting foot "G"

Three stitches can be used to sew overcasting with overcasting foot "G".

Stitch Name	Pattern	Application	Stitch Width [mm (inch)]		Stitch Length [mm (inch)]		Presser Foot
			Auto	Manual	Auto	Manual	
Overcasting stitch	11 	Preventing fraying in medium weight and thin fabrics	3.5 (1/8)	2.5-5.0 (3/32-3/16)	2.0 (1/16)	1.0-4.0 (1/16-3/16)	G
	12 	Preventing fraying in thick fabrics and fabrics that fray easily	5.0 (3/16)		2.5 (3/32)		
	13 		3.5-5.0 (1/8-3/16)				

CAUTION

- Be sure to turn off the main power before replacing the presser foot. Otherwise, injuries may occur if  (Start/stop button) is accidentally pressed and the machine starts sewing.

1 Attach overcasting foot "G".



- For details, refer to "Replacing the presser foot" (page 43).

2 Select a stitch.

- For details, refer to "Selecting stitching" (page 51).

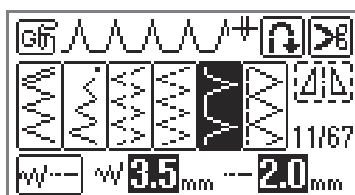

3 Position the fabric with the edge of the fabric against the guide of the presser foot, and then lower the presser foot lever.

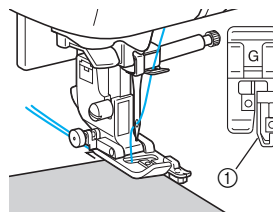

① Guide

4 Sew with the edge of the fabric against the presser foot guide.

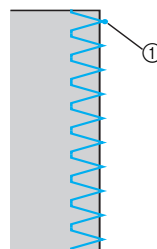

① Needle drop point

Sewing overcasting stitches using zigzag foot "J"

Seven stitches can be used to sew overcasting stitches with zigzag foot "J".

Stitch Name	Pattern	Application	Stitch Width [mm (inch)]		Stitch Length [mm (inch)]		Presser Foot
			Auto	Manual	Auto	Manual	
Zigzag stitch (center needle position)		Preventing fraying (center baseline/reverse stitching)	3.5 (1/8)	0.0-7.0 (0-1/4)	1.4 (1/16)	0.0-4.0 (0-3/16)	J
Zigzag stitch (right needle position)		Preventing fraying (right baseline/reinforcement stitching)		2.5-5.0 (3/32-3/16)		0.3-4.0 (1/64-3/16)	
2-point zigzag stitch		Preventing fraying in thick fabrics and stretch fabrics	5.0 (3/16)	1.5-7.0 (1/16-1/4)	1.0 (1/16)	0.2-4.0 (1/64-3/16)	
3-point zigzag stitch							
Overcasting stitch		Preventing fraying in stretch fabrics	0.0-7.0 (0-1/4)	2.5 (3/32)	0.5-4.0 (1/32-3/16)		
		Preventing fraying in thick fabrics and stretch fabrics					
		Preventing fraying in stretch fabrics	4.0 (3/16)	4.0 (3/16)	1.0-4.0 (1/16-3/16)		

3

CAUTION

- Be sure to turn off the main power before replacing the presser foot. Otherwise, injuries may occur if (Start/stop button) is accidentally pressed and the machine starts sewing.

1 Attach zigzag foot "J".

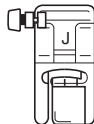

- For details on replacing the presser foot, refer to "Replacing the presser foot" (page 43).

2 Select a stitch.

- For details, refer to "Selecting stitching" (page 51).

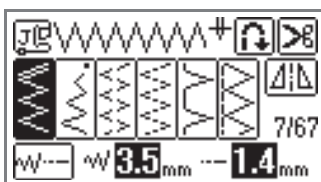



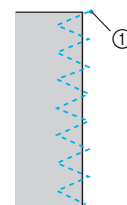
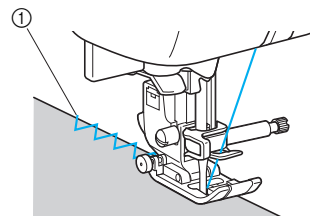

3 Sew along the edge of the fabric with the needle dropping off the edge at the right.



① Needle drop point

Sewing overcasting stitches using the optional side cutter

Using the optional side cutter, seam allowances can be finished while the edge of the fabric is cut off. Five stitches can be used to sew overcasting stitches with the side cutter.

Stitch Name	Pattern	Application	Stitch Width [mm (inch)]		Stitch Length [mm (inch)]		Presser Foot
			Auto	Manual	Auto	Manual	
Side cutter	63 	Sewing straight stitches while cutting the fabric	0.0 (0)	0.0-2.5 (0-3/32)	2.5 (3/32)	0.2-5.0 (1/64-3/16)	S
	64 	Sewing zigzag stitches while cutting the fabric	3.5 (1/8)	3.5-5.0 (1/8-3/16)	1.4 (1/16)	0.0-4.0 (0-3/16)	
	65 	Preventing fraying in thin and mediumweight fabrics while cutting the fabric			2.0 (1/16)	1.0-4.0 (1/16-3/16)	
	66 	Preventing fraying in thick fabrics while cutting the fabric	5.0 (3/16)	2.5 (3/32)			
	67 	Preventing fraying in thick fabrics while cutting the fabric					

CAUTION

- Be sure to turn off the main power before replacing the presser foot. Otherwise, injuries may occur if ⚠ (Start/stop button) is accidentally pressed and the machine starts sewing.

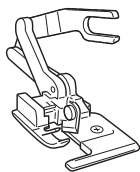

Note

- Thread the needle manually when using the side cutter, or only attach the side cutter after threading the needle using the needle threader.

1 Remove the presser foot.

- For details on replacing the presser foot, refer to "Replacing the presser foot" (page 43).

2 Hook the connecting fork of the side cutter onto the needle clamp screw.

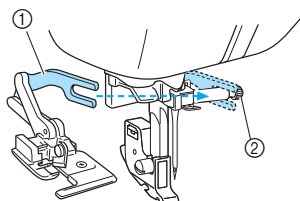

- ① Connecting fork
- ② Needle clamp screw

- 3 Position the side cutter so that side cutter pin is aligned with the notch in the presser foot holder, and then slowly lower the presser foot lever.

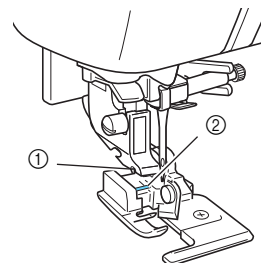

- ① Notch in presser foot holder
- ② Pin

▶ The side cutter is attached.

- 4 Raise the presser foot lever to check that the side cutter is securely attached.

- 5 Pass the upper thread under the side cutter, and then pull it out toward the rear of the sewing machine.

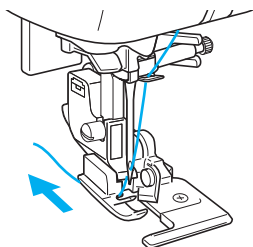

- 6 Select a stitch.

- For details, refer to "Selecting stitching" (page 51).

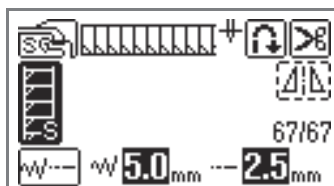
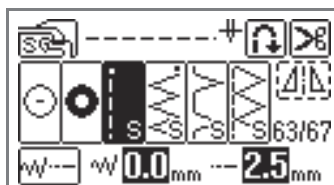

- 7 Make a cut of about 2 cm (3/4 inch) long in the fabric at the beginning of the stitching.

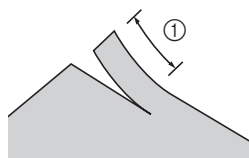

- ① 2 cm (3/4 inch)

- 8 Position the fabric in the side cutter. The cut in the fabric should be positioned over the guide plate of the side cutter.

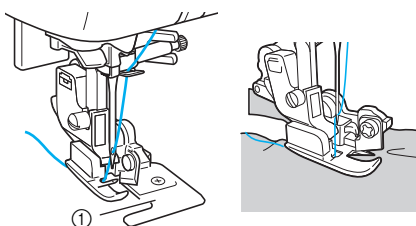

- ① Guide plate



Memo

- If the fabric is not positioned correctly, the fabric will not be cut.

- 9 Lower the presser foot lever, and then start sewing.

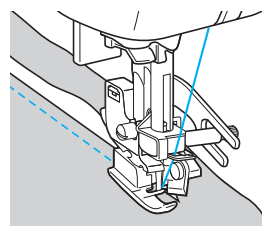

- ▶ A seam allowance is cut while the stitching is sewn.



Memo

- If the stitching is sewn in a straight line ⁶³ , the seam allowance will be about 5 mm (3/16 inch).

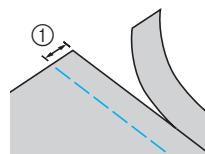





- ① 5 mm (3/16 inch)

- The side cutter can cut as much as one layer of 13-oz. denim.
- After using the side cutter, clean to remove any lint or dust.
- If the side cutter can no longer cut fabric, use a rag to apply a small amount of oil to the cutting edge of the cutter.

Basic Stitching

Straight stitches are used for sewing plain seams. Five stitches are available for basic stitching.

Stitch Name	Pattern	Application	Stitch Width [mm (inch)]		Stitch Length [mm (inch)]		Presser Foot
			Auto	Manual	Auto	Manual	
Basting stitch		Temporarily securing			-	-	J
Straight stitch (left needle position)		Basic stitching and sewing gathers or pintucks (left baseline/reverse stitching)	0.0 (0)	0.0-7.0 (0-1/4)	2.5 (3/32)	0.2-5.0 (1/64-3/16)	
		Basic stitching and sewing gathers or pintucks (left baseline/reinforcement stitching)					
Straight stitch (center needle position)		Basic stitching and sewing gathers or pintucks (center baseline/reverse stitching)	3.5 (1/8)				
Triple stretch stitch		Reinforcing seams and sewing stretch fabrics	0.0 (0)			1.5-4.0 (1/16-3/16)	

CAUTION

- Be sure to turn off the main power before replacing the presser foot. Otherwise, injuries may occur if ⚠ (Start/stop button) is accidentally pressed and the machine starts sewing.

Basting

- 1 Attach zigzag foot "J".
 - For details on replacing the presser foot, refer to "Replacing the presser foot" (page 43).

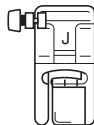

- 2 Select stitch .
 - For details, refer to "Selecting stitching" (page 51).

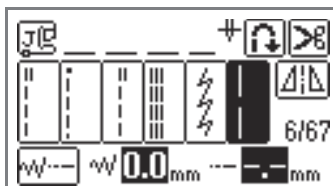

- 3 Start sewing.
 - For details, refer to "Starting to sew" (page 55).

Basic stitching

- 1 Baste or pin together the fabric pieces.
- 2 Attach zigzag foot "J".

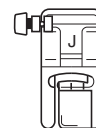

- For details on replacing the presser foot, refer to "Replacing the presser foot" (page 43).

- 3 Select a stitch.
 - For details, refer to "Selecting stitching" (page 51).

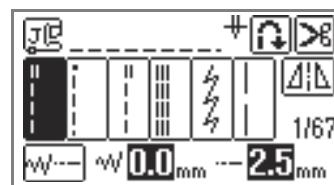

4 Lower the needle into the fabric at the beginning of the stitching.

5 Start sewing.

- For details, refer to "Starting to sew" (page 55).
- For details on sewing reverse/reinforcement stitches, refer to "Securing the stitching" (page 57).

6 When sewing is finished, cut the thread.

- For details, refer to "Cutting the thread" (page 59).



■ Changing the needle position

The needle position used as the baseline is different for the straight stitch (left needle position) and the straight stitch (center needle position).

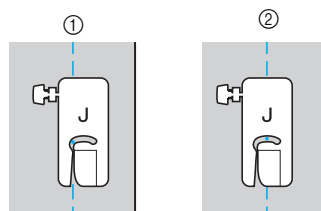

- ① Straight stitch (left needle position)
- ② Straight stitch (center needle position)

When the stitch width of the straight stitch (left needle position) is set to its standard setting (0.0 mm), the distance from the needle position to the right side of the presser foot is 12 mm (1/2 inch). If the stitch width is changed (between 0 and 7.0 mm (1/4 inch)), the needle position will also change. By changing the stitch width and sewing with the right side of the presser foot aligned with the edge of the fabric, a seam allowance can be sewn with a fixed width.

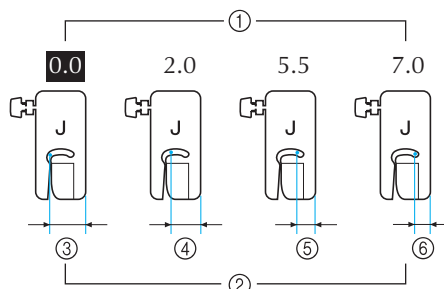

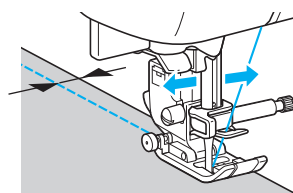

- ① Stitch width setting
- ② Distance from the needle position to the right side of the presser foot
- ③ 12.0 mm (1/2 inch)
- ④ 10.0 mm (3/8 inch)
- ⑤ 6.5 mm (1/4 inch)
- ⑥ 5.0 mm (3/16 inch)



- For details, refer to "Adjusting the stitch width" (page 61).

Blind Hem Stitching

Secure the bottoms of skirts and pants with a blind hem. Two stitches are available for blind hem stitching.

Stitch Name	Pattern	Application	Stitch Width [mm (inch)]		Stitch Length [mm (inch)]		Presser Foot
			Auto	Manual	Auto	Manual	
Blind hem stitch	17 	Blind hem stitching on mediumweight fabrics	00	3 ← -- → 3	2.0 (1/16)	1.0-3.5 (1/16-1/8)	R
	18 	Blind hem stitching on stretch fabrics					

CAUTION

● Be sure to turn off the main power before replacing the presser foot. Otherwise, injuries may occur if (Start/stop button) is accidentally pressed and the machine starts sewing.

Sew a blind hem according to the following procedure.



Memo

- When the size of cylindrical pieces is too small to slide onto the arm or the length is too short, the fabric will not feed and desired results may not be achieved.

1 Reverse the skirt or pants.



- ① Right side of fabric
- ② Bottom side

2 Fold the fabric along the desired edge of the hem, and press.

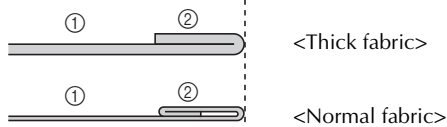
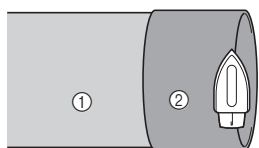

<Seen from the side>

- ① Wrong side of fabric
- ② Right side of fabric

3 Use a chalk to mark on the fabric about 5 mm (3/16 inch) from the edge of the fabric, and then baste it .

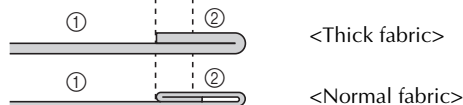
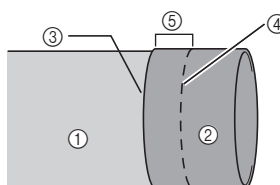

<Seen from the side>

- ① Wrong side of fabric
- ② Right side of fabric
- ③ Edge of fabric
- ④ Basting stitching
- ⑤ 5 mm (3/16 inch)

4 Fold back the fabric inside along the basting.

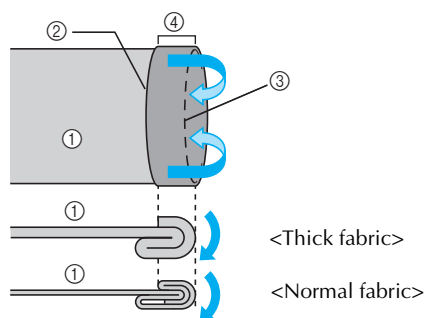

<Seen from the side>

- ① Wrong side of fabric
- ② Edge of fabric
- ③ Basting
- ④ 5 mm (3/16 inch)

5 Unfold the edge of fabric, and position the fabric with the wrong side facing up.

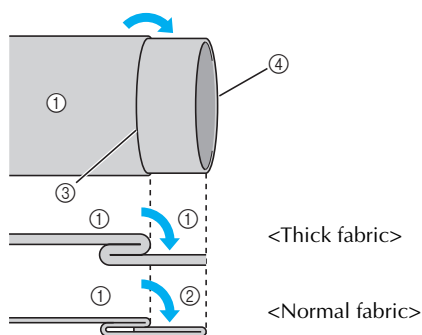

<Seen from the side>

- ① Wrong side of fabric
- ② Right side of fabric
- ③ Basting
- ④ Edge of fabric

6 Attach blind hem foot "R".

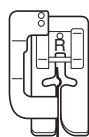

- For details on replacing the presser foot, refer to "Replacing the presser foot" (page 43).

7 Select a stitch.

- For details, refer to "Selecting stitching" (page 51).

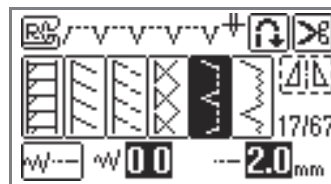

8 Remove the flat bed attachment and make free-arm sewing possible.

- For details on free-arm sewing, refer to "Free-arm sewing" (page 46).

9 Slide the item that you wish to sew onto the arm, make sure that the fabric feeds correctly, and then start sewing.

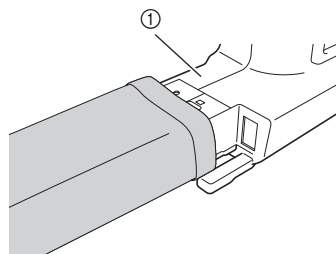

- ① Arm

10 Position the fabric with the edge of the folded hem against the guide of the presser foot, and then lower the presser foot lever.

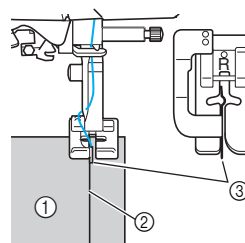

- ① Wrong side of fabric
- ② Fold of hem
- ③ Guide

11 Adjust the stitch width until the needle slightly catches the fold of the hem.

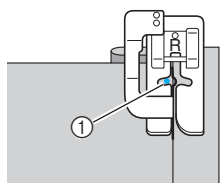

① Needle drop point

When you change the needle drop point, raise the needle, and then change the stitch width.

Stitch width

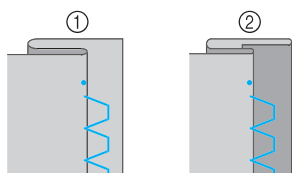
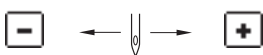

① Thick fabric
② Normal fabric

■ If the needle catches too much of the hem fold

If the needle catches too much of the hem fold, press **+** to adjust the stitch width so that the needle slightly catches the fold.

<Thick fabric>

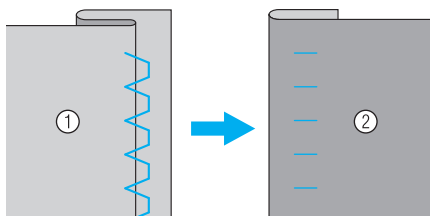

<Normal fabric>

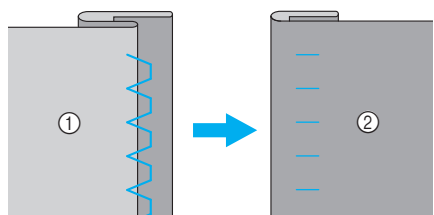

① Wrong side of fabric ② Right side of fabric

■ If the needle does not catch the hem fold

If the needle does not catch the hem fold, press **-** to adjust the stitch width so that the needle slightly catches the fold.

<Thick fabric>

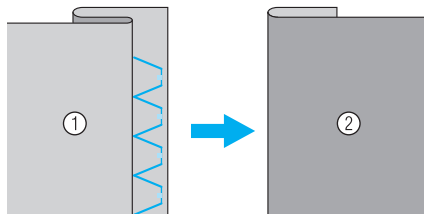

<Normal fabric>

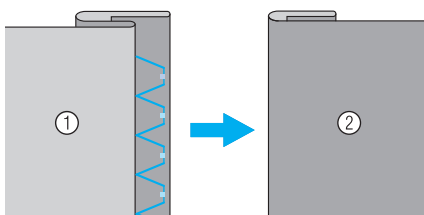

① Wrong side of fabric ② Right side of fabric



Memo

● For details, refer to "Adjusting the stitch width" (page 61).

12 Sew with the fold of the hem against the presser foot guide.



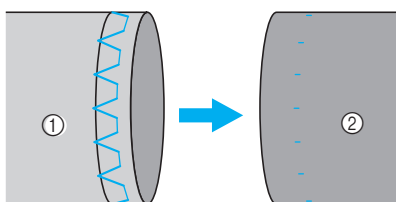







13 Remove the basting stitching and reverse the fabric.



① Wrong side of fabric
② Right side of fabric

Buttonhole Stitching/Button Sewing

Buttonholes can be sewn and buttons can be sewn on. 10 stitches are available for sewing one-step buttonholes, and one stitch is available for attaching the button.

Stitch Name	Pattern	Application	Stitch Width [mm (inch)]		Stitch Length [mm (inch)]		Presser Foot
			Auto	Manual	Auto	Manual	
Buttonhole stitch	48 	Horizontal buttonholes on thin and mediumweight fabrics	5.0 (3/16)	3.0-5.0 (1/8-3/16)	0.5 (1/32)	0.2-1.0 (1/64-1/16)	A
	49 	Horizontal buttonholes on areas that are subject to strain					
	50 	Horizontal buttonholes on thick fabrics					
	51 	Buttonholes with bar tacks on both ends for stabilized fabrics					
	52 	Buttonholes for stretch or knit fabrics	6.0 (15/64)	3.0-6.0 (1/8-15/64)	1.0 (1/16)	0.5-2.0 (1/32-1/16)	
	53 	Buttonholes for stretch fabrics			1.5 (1/16)	1.0-3.0 (1/16-1/8)	
	54 	Bound buttonholes	5.0 (3/16)	0.0-6.0 (0-15/64)	2.0 (1/16)	0.2-4.0 (1/64-3/16)	
	55 	Keyhole buttonholes for thick or plush fabrics	7.0 (1/4)	3.0-7.0 (1/8-1/4)	0.5 (1/32)	0.3-1.0 (1/64-1/16)	
	56 	Keyhole buttonholes for mediumweight and thick fabrics					
	57 	Horizontal buttonhole for thick or plush fabrics					
Button-sewing stitch	61 	Button sewing	3.5 (1/8)	2.5-4.5 (3/32-3/16)	-	-	M

Buttonhole sewing

The maximum buttonhole length is about 28 mm (1-1/8 inches) (diameter + thickness of the button). Buttonholes are sewn from the front of the presser foot to the back, as shown below.

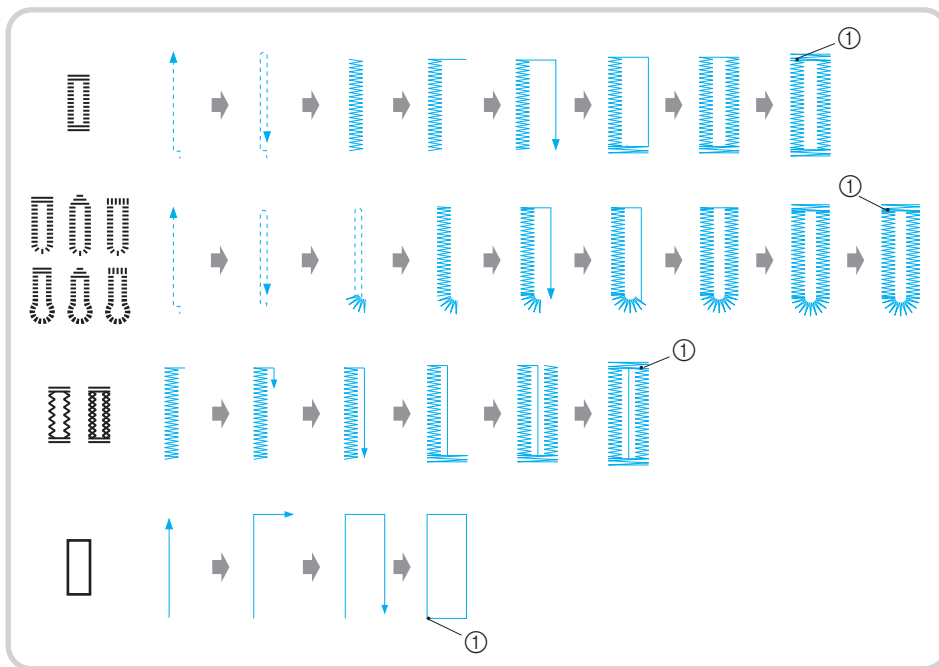

① Reinforcement stitching

CAUTION

● Be sure to turn off the main power before replacing the presser foot. Otherwise, injuries may occur if Ⓡ (Start/stop button) is accidentally pressed and the machine starts sewing.

The names of parts of buttonhole foot "A", which is used for sewing buttonholes, are indicated below.

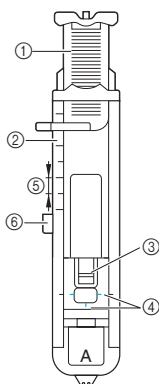

- ① Button guide plate
- ② Presser foot scale
- ③ Pin
- ④ Reference marks
- ⑤ 5 mm (3/16 inch)
- ⑥ Bracket

1 Use chalk to mark on the fabric the position and length of the buttonhole.

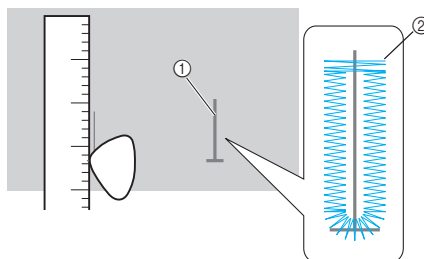

- ① Marks on fabric
- ② Buttonhole sewing

2 Pull out the button guide plate of buttonhole foot "A", and then insert the button that will be put through the buttonhole.

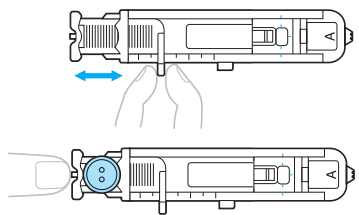

■ If the button does not fit in the button guide plate

Add together the diameter and thickness of the button, and then set the button guide plate to the calculated length. (The distance between the markings on the presser foot scale is 5 mm (3/16 inch).)

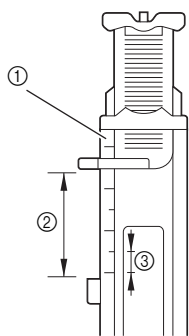

- ① Presser foot scale
- ② Length of buttonhole (diameter + thickness of button)
- ③ 5 mm (3/16 inch)

Example:

For a button with a diameter of 15 mm (9/16 inch) and a thickness of 10 mm (3/8 inch), the button guide plate should be set to 25 mm (1 inch) on the scale.

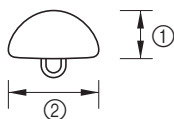

- ① 10 mm (3/8 inch)
- ② 15 mm (9/16 inch)

▶ The size of the buttonhole is set.

3 Attach buttonhole foot "A".

- For details on replacing the presser foot, refer to "Replacing the presser foot" (page 43).

4 Select a stitch.

- For details, refer to "Selecting stitching" (page 51).

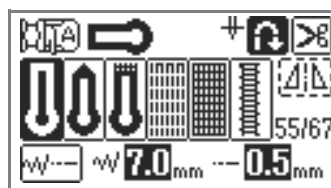
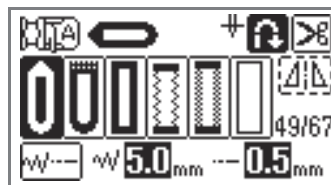
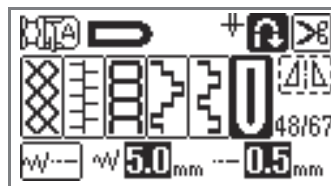

5 Position the fabric with the front end of the buttonhole mark aligned with the red marks on the sides of the buttonhole foot, and then lower the presser foot lever.

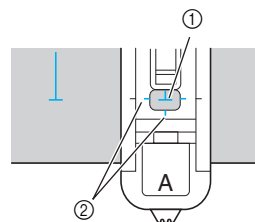

- ① Mark on fabric (front)
- ② Red marks on buttonhole foot

- Pass the upper thread down through the hole in the presser foot.

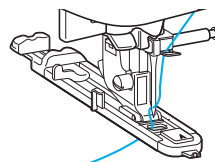



Note

- Do not lower the needle into fabric when aligning the marks. Desired results may not be achieved.
- When lowering the presser foot, do not push in the front of the presser foot.

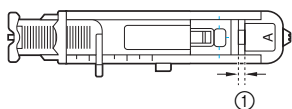
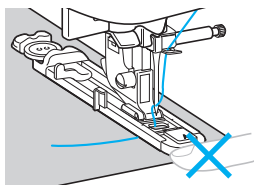

① Do not reduce the gap.

6 Pull down the buttonhole lever as far as possible.

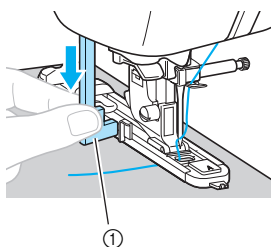

① Buttonhole lever

The buttonhole lever is positioned behind the bracket on the buttonhole foot.

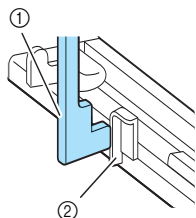

① Buttonhole lever
② Bracket

7 Gently hold the end of the upper thread in your left hand, and then start sewing.

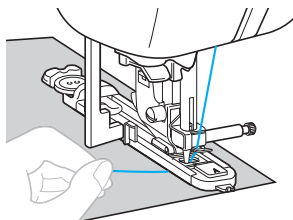

▶ Once sewing is completed, the machine automatically sews reinforcement stitches, then stops.

8 Press  (Thread cutter button) once.

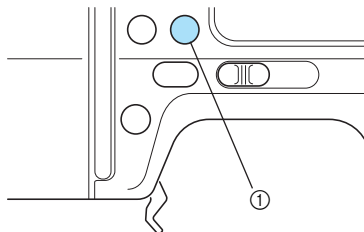

① Thread cutter button

▶ The threads are cut and the needle is raised.

9 Raise the presser foot lever, and then remove the fabric.



Memo

- If programmed thread-cutting is set, the sewing machine will sew reinforcement stitching, and then cut the thread automatically at the end of the stitching. Refer to "Automatically cutting the thread" (page 65).
- When you cut the threads by using the thread cutter on the side of the machine or scissors, first press  (Needle position button) once to raise the needle, then raise the presser foot lever and pull the fabric to the left side of the machine, and then cut the threads. Refer to "Using the thread cutter" (page 60).

10 Raise the buttonhole lever to its original position.

11 Insert a pin along the inside of one bar tack at the end of the buttonhole stitching to prevent the stitching from being cut.

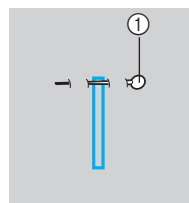

① Pin

12 Use the seam ripper to cut towards the pin and open the buttonhole.

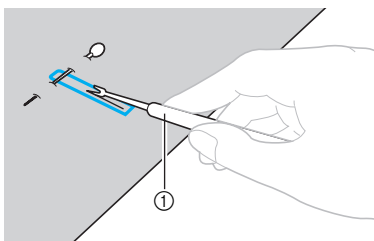

① Seam ripper

For keyhole buttonholes, use the eyelet punch to make a hole in the rounded end of the buttonhole, and then use the seam ripper to cut open the buttonhole.

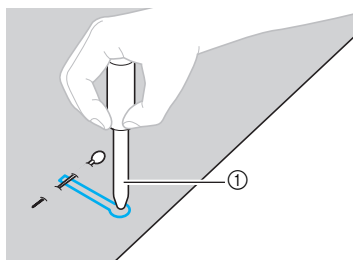

① Eyelet punch



Note

- When using the eyelet punch, place thick paper or some other protective sheet under the fabric before punching the hole in the fabric.



CAUTION

- When opening the buttonhole with the seam ripper, do not place your hands in the cutting path, otherwise injuries may result if the seam ripper slips.
- Do not use the seam ripper in any other way than how it is intended.

■ **Changing the density of the stitching**

Adjust the stitch length.

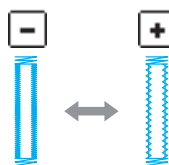

Memo

- For details, refer to "Adjusting the stitch length" (page 62).
- If the fabric does not feed (for example, if it is too thick), decrease the density of the stitching.

■ **Changing the stitch width**

Adjust the stitch width.

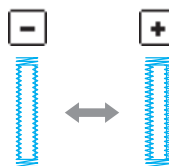

Memo

- For details, refer to "Adjusting the stitch width" (page 61).
- Before sewing buttonholes, check the stitch length and width by sewing a trial buttonhole on a scrap piece of fabric.

■ Sewing buttonholes on stretch fabrics

When sewing buttonholes on stretch or loosely woven fabrics, use a gimp thread.

- 1 Hook the gimp thread onto the part of buttonhole foot "A" shown in the illustration.

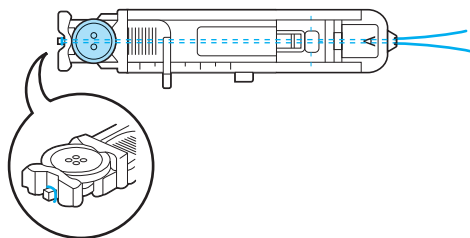

- 2 It fits into the grooves, and then loosely tie it.

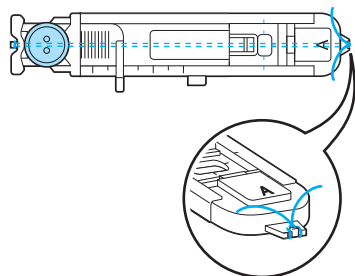

- 3 Attach buttonhole foot "A".

- For details on replacing the presser foot, refer to "Replacing the presser foot" (page 43).

- 4 Select stitch 52 or 53.

- 5 Adjust the stitch width to the thickness of the gimp thread.

- 6 Lower the presser foot lever and the buttonhole lever, and then start sewing.

- 7 When sewing is finished, gently pull the gimp thread to remove any slack.

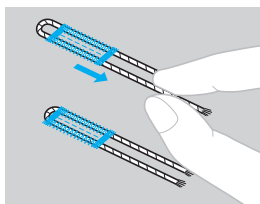

- 8 Use a handsewing needle to pull the gimp thread to the wrong side of the fabric, and then tie it.

Button sewing

Buttons can be sewn on with the sewing machine. Buttons with two or with four holes can be attached.

- 1 Measure the distance between the holes in the button to be attached.

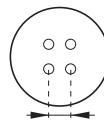

- 2 Raise the presser foot lever, and then slide the drop feed lever, located at the rear of the machine on the base, to the left (to the left as seen from the rear of the machine).

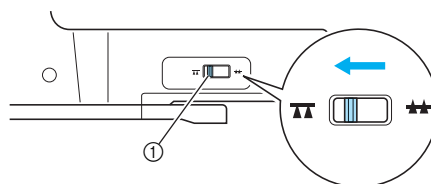

- 1 Drop feed lever (as seen from the rear of the machine)

► The feed dogs are lowered.

- 3 Attach button-fitting foot "M".



- For details on replacing the presser foot, refer to "Replacing the presser foot" (page 43).

- 4 Select stitch 61.

- For details, refer to "Selecting stitching" (page 51).

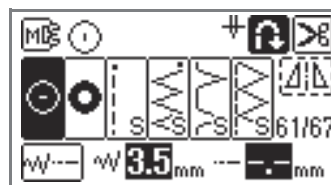

Note

- Since the end of the thread will be tied off later, do not set the sewing machine for programmed-thread cutting.

5 Adjust the stitch width so that it is the same as the distance between the holes in the button.

6 Place the button in the position where it will be sewn, and lower the presser foot lever.

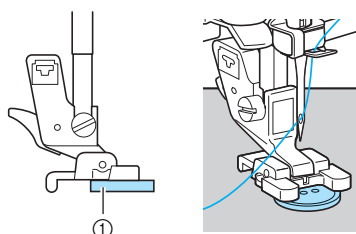

① Button

▶ The button is held in place.



Memo

- When attaching four-hole buttons, first sew the two holes closest to you. Then, slide the button so that the needle goes into the two holes toward the rear of the sewing machine, and then sew them in the same way.

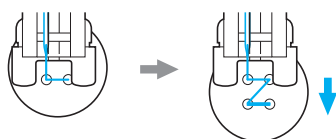

7 Turn the handwheel toward you (counterclockwise) to check that the needle correctly goes into the two holes of the button. Adjust the stitch width to the distance between the button holes.

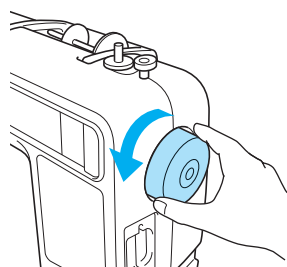

CAUTION

- When sewing, be sure that the needle does not touch the button, otherwise the needle may bend or break.

8 Start sewing.

Set the sewing speed controller to the left (so that the speed will be slow).

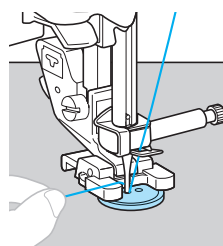

▶ The sewing machine automatically stops after sewing reinforcement stitches.





Note

- Do not press  (Thread cutter button).

9 Pull the upper thread at the end of the stitching to the wrong side of the fabric, and then tie it with the bobbin thread.

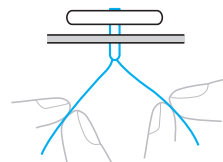
Use scissors to cut the upper thread and the bobbin thread at the beginning of the stitching.



10 When you have finished attaching the button, slide the drop feed lever to  (to the right as seen from the rear of the machine) and turn the handwheel to raise the feed dogs.



Memo

- The drop feed lever is normally set to the right side.

Zipper Insertion

A zipper can be inserted.

Stitch Name	Pattern	Application	Stitch Width [mm (inch)]		Stitch Length [mm (inch)]		Presser Foot
			Auto	Manual	Auto	Manual	
Straight stitch (center needle position)		Attaching zippers Sewing concealed seams and pintucks	3.5 (1/8)	0.0-7.0 (0-1/4)	2.5 (3/32)	0.2-5.0 (1/64-3/16)	I

CAUTION

- Be sure to turn off the main power before replacing the presser foot. Otherwise, injuries may occur if  (Start/stop button) is accidentally pressed and the machine starts sewing.

There are many methods for inserting zippers. The procedures for inserting a centered zipper and a side zipper are described below.

Inserting a centered zipper

Stitching is sewn on both pieces of fabric butted against each other.

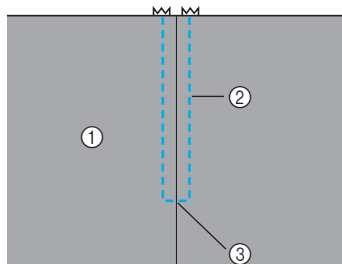

- ① Right side of fabric
- ② Stitching
- ③ End of zipper opening

1 Attach zigzag foot "J".

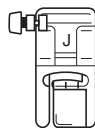

- For details on replacing the presser foot, refer to "Replacing the presser foot" (page 43).

2 Sew straight stitches up to the zipper opening.

- With the right sides of the fabric facing each other, sew reverse stitches after reaching the zipper opening.
- For details, refer to "Basic stitching" (page 82).

3 Using a basting stitch, continue sewing to the edge of the fabric.

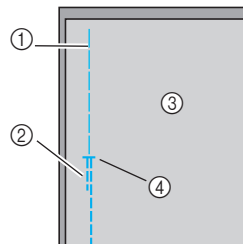

- ① Basting stitching
- ② Reverse stitches
- ③ Wrong side of fabric
- ④ End of zipper opening

4 Press open the seam allowance from the wrong side of the fabric.

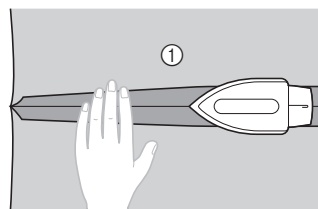

- ① Wrong side of fabric

- 5** Align the seam with the center of the zipper, and then baste the zipper in place.

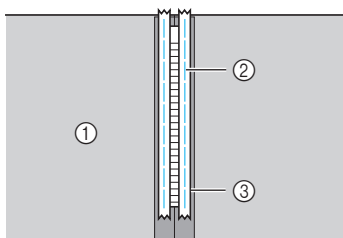

- ① Wrong side of fabric
- ② Basting stitching
- ③ Zipper

- 6** Remove about 5 cm (2 inches) from the end of the basting on the outside.

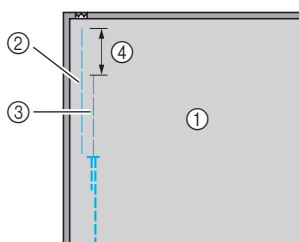

- ① Wrong side of fabric
- ② Zipper basting
- ③ Outside basting
- ④ 5 cm (2 inches)

- 7** Attach the presser foot holder to the right pin of zipper foot "I".

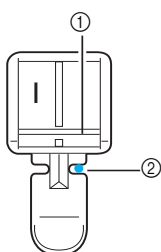

- ① Pin on the right side
- ② Needle drop point

- For details on replacing the presser foot, refer to "Replacing the presser foot" (page 43).

- 8** Select stitch 3 .

- For details, refer to "Selecting stitching" (page 51).

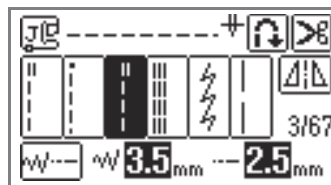

! CAUTION

- When using zipper foot "I", be sure to select the straight stitch (center needle position), and slowly turn the handwheel toward you (counterclockwise) to check that the needle does not touch the presser foot. If a different stitch is selected or the needle hits the presser foot, the needle may bend or break.

- 9** Topstitch around the zipper.

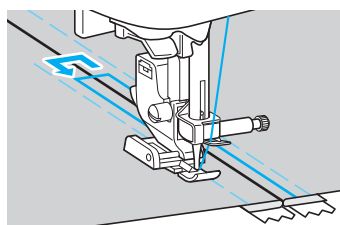
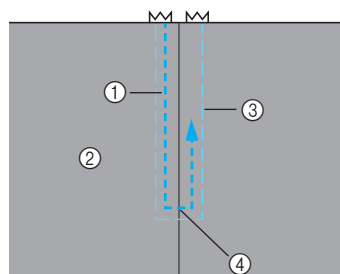

- ① Stitching
- ② Right side of fabric
- ③ Basting stitching
- ④ End of zipper opening

! CAUTION

- When sewing, be sure that the needle does not touch the zipper, otherwise the needle may bend or break.

- 10** Remove the basting stitching.

Inserting a side zipper

Stitching is visible on only one piece of fabric. Use this type of zipper application for side openings and back openings.

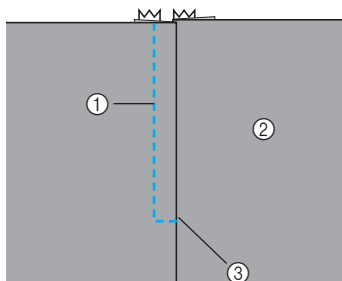

- ① Stitching
- ② Right side of fabric
- ③ End of zipper opening

The following procedure will describe how to stitch on the left side, as shown in the illustration.

1 Attach zigzag foot "J".

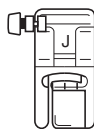

- For details on replacing the presser foot, refer to "Replacing the presser foot" (page 43).

2 Sew straight stitches up to the zipper opening.

With the right sides of the fabric facing each other, sew reverse stitches after reaching the zipper opening.

- For details, refer to "Basic stitching" (page 82).

3 Using a basting stitch, continue sewing to the edge of the fabric.

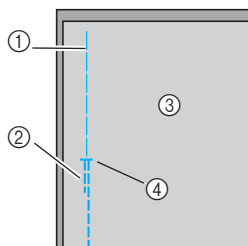

- ① Basting stitching
- ② Reverse stitches
- ③ Wrong side of fabric
- ④ End of zipper opening

4 Press open the seam allowance from the wrong side of the fabric.

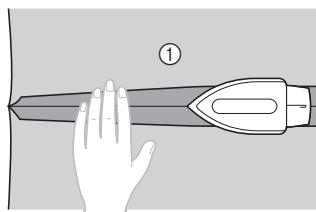

- ① Wrong side of fabric

5 Press the seam allowance so that the right side (the side that will not be stitched) has an extra 3 mm (1/8 inch).

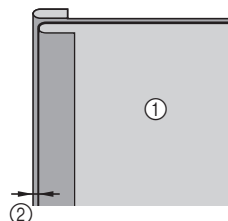

- ① Wrong side of fabric
- ② 3 mm (1/8 inch)

6 Align the zipper teeth with the pressed edge of the fabric having the extra 3 mm (1/8 inch), and then baste or pin the zipper in place.

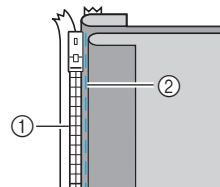

- ① Zipper teeth
- ② Basting stitching

7 Attach the presser foot holder to the right pin of zipper foot "I".

If the stitching will be sewn on the right side, attach the presser foot holder to the left pin of the zipper foot.

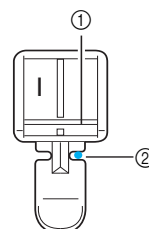

- ① Pin on the right side
- ② Needle drop point

- For details on replacing the presser foot, refer to "Replacing the presser foot" (page 43).

8 Select stitch  .

- For details, refer to "Selecting stitching" (page 51).

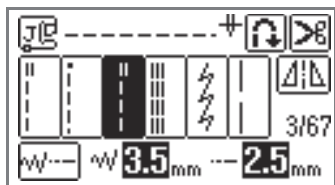

CAUTION

- When using zipper foot "I", be sure to select the straight stitch (center needle position), and slowly turn the handwheel toward you (counterclockwise) to check that the needle does not touch the presser foot. If a different stitch is selected or the needle hits the presser foot, the needle may bend or break.

9 Sew the zipper to the piece of fabric with the extra 3 mm (1/8 inch), starting from the base of the zipper.

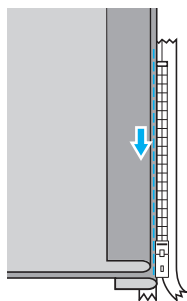

CAUTION

- When sewing, be sure that the needle does not touch the zipper, otherwise the needle may bend or break.

10 When you are about 5 cm (2 inches) from the end of the zipper, stop the sewing machine with the needle lowered (in the fabric), and then raise the presser foot lever.

11 Open the zipper and continue sewing.

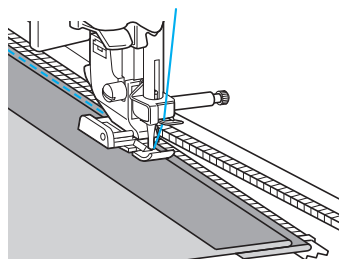

12 Close the zipper, turn over the fabric, and then baste the other side of the zipper to the fabric.

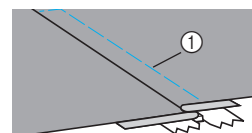
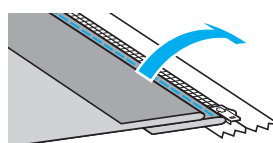

① Basting stitching

13 Attach the presser foot holder to the left pin of zipper foot "I".

If the presser foot holder was attached to the left pin in step 7, change it to the right pin.

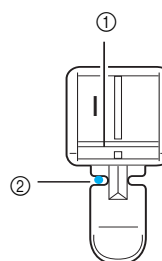

① Pin on the left side
② Needle drop point

- 14 Topstitch around the zipper.**
Sew reverse stitches at the end of the zipper opening and align the zipper teeth with the side of the presser foot.

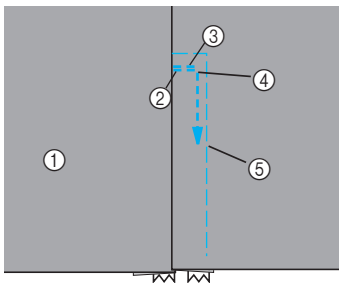

- ① Right side of fabric
- ② End of zipper opening
- ③ Reverse stitches
- ④ Beginning of stitching
- ⑤ Basting stitching





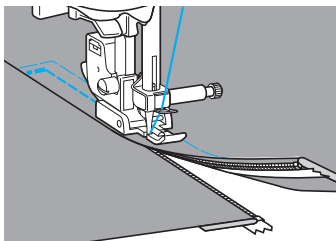

CAUTION

- **When sewing, be sure that the needle does not touch the zipper, otherwise the needle may bend or break.**
- 15** When you are about 5 cm (2 inches) from the end of the zipper, stop the sewing machine with the needle lowered (in the fabric), and then raise the presser foot lever.
- 16** Remove the basting stitching, open the zipper, and then continue sewing.



Sewing Stretch Fabrics and Elastic Tape

Stretch fabrics can be sewn and elastic tape can be attached.

Stitch Name	Pattern	Application	Stitch Width [mm (inch)]		Stitch Length [mm (inch)]		Presser Foot
			Auto	Manual	Auto	Manual	
Triple stretch stitch	4 	Stretch fabrics	0.0 (0)	0.0-7.0 (0-1/4)	2.5 (3/32)	1.5-4.0 (1/16-3/16)	J
Stretch stitch	5 	Stretch fabrics	1.0 (1/16)	1.0-3.0 (1/16-1/8)	2.5 (3/32)	1.0-4.0 (1/16-3/16)	
2-point zigzag stitch	9 	Attaching elastic	5.0 (3/16)	1.5-7.0 (1/16-1/4)	1.0 (1/16)	0.2-4.0 (1/64-3/16)	
3-point zigzag stitch	10 						
Elastic-attaching stitch	34 	Attaching elastic to stretch fabrics	4.0 (3/16)	0.0-7.0 (0-1/4)			

Observe the corresponding precautions when performing each of the following stitching operations.

CAUTION

- Be sure to turn off the main power before replacing the presser foot. Otherwise, injuries may occur if ⏻ (Start/stop button) is accidentally pressed and the machine starts sewing.

Stretch stitching

- 1 Attach zigzag foot "J".

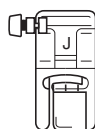

- For details on replacing the presser foot, refer to "Replacing the presser foot" (page 43).

- 2 Select stitch 4  or 5 .

- For details, refer to "Selecting stitching" (page 51).

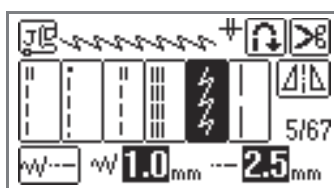

- 3 Sew the fabric without stretching it.

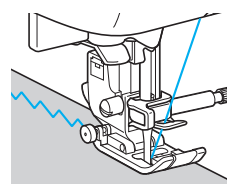

Elastic attaching

When elastic tape is attached to the cuff or waist of a piece of clothing, the finished dimensions will be that of the stretched elastic tape. Therefore, it is necessary that a suitable length of the elastic tape be used.

1 Pin the elastic tape to the wrong side of the fabric.

Pin the elastic tape to the fabric at a few points to make sure that the tape is uniformly positioned on the fabric.

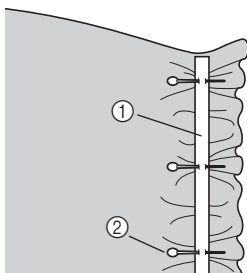

- ① Elastic tape
- ② Pin

2 Attach zigzag foot "J".

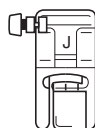

- For details on replacing the presser foot, refer to "Replacing the presser foot" (page 43).

3 Select a stitch.

- For details, refer to "Selecting stitching" (page 51).

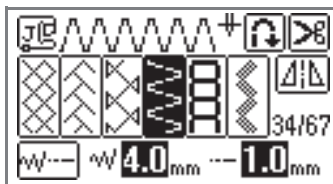
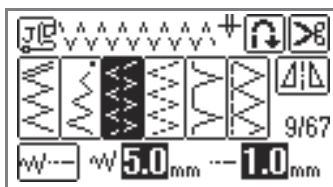

4 Sew the elastic tape to the fabric while stretching the tape so that it is the same length as the fabric.

While pulling the fabric behind the presser foot with your left hand, pull the fabric at the pin nearest the front of the presser foot with your right hand.

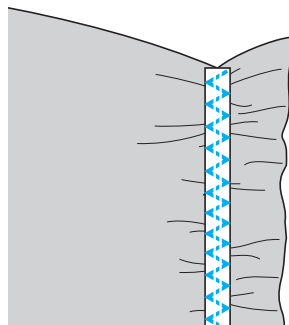
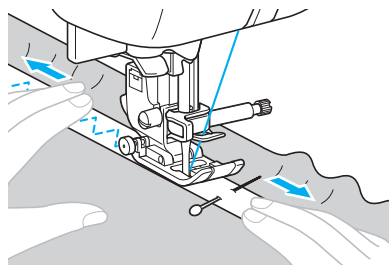











CAUTION

- When sewing, be sure that the needle does not touch any pins, otherwise the needle may bend or break.

Appliqué, Patchwork and Quilt Stitching

The stitches that can be used for sewing appliqués, patchwork and quilts are described below.

Stitch Name	Pattern	Application	Stitch Width [mm (inch)]		Stitch Length [mm (inch)]		Presser Foot		
			Auto	Manual	Auto	Manual			
Zigzag stitch	7 	Attaching appliqués (center baseline/reverse stitching)	3.5 (1/8)	0.0-7.0 (0-1/4)	1.4 (1/16)	0.0-4.0 (0-3/16)	J		
	24 	Appliqué quilting, free-motion quilting, satin stitching							
Appliqué stitch	19 	Attaching appliqués	1.5 (1/16)	0.5-3.5 (1/32-1/8)	1.8 (1/16)	1.6-4.0 (1/16-3/16)			
	25 	Attaching appliqués and binding							
Piecing straight stitch	21 	Piecing straight stitching (with a seam allowance of 6.5 mm (1/4 inch) from the right edge of the presser foot)	5.5 (3/16)	0.0-7.0 (0-1/4)	2.0 (1/16)	0.2-5.0 (1/64-3/16)			
	22 	Piecing straight stitching (with a seam allowance of 6.5 mm (1/4 inch) from the left edge of the presser foot)	1.5 (1/16)						
Joining stitch	28 	Patchwork stitching	4.0 (3/16)	0.0-7.0 (0-1/4)	1.2 (1/16)	0.2-4.0 (1/64-3/16)			
	29 		5.0 (3/16)					2.5-7.0 (3/32-1/4)	2.5 (3/32)
	30 		0.0-7.0 (0-1/4)				1.2 (1/16)	0.2-4.0 (1/64-3/16)	
Mock hand quilting	23 	Straight stitch quilting that looks hand quilted	0.0 (0)	0.0-7.0 (0-1/4)	2.5 (3/32)	1.0-4.0 (1/16-3/16)			
Quilting stippling	26 	Stippling	7.0 (1/4)				1.6 (1/16)		



Memo

- Patterns showing a "Q" on the LCD are for quilting and those showing a "P" are for piecing.



CAUTION

- Be sure to turn off the main power before replacing the presser foot. Otherwise, injuries may occur if ⓘ (Start/stop button) is accidentally pressed and the machine starts sewing.

Appliqué stitching

- 1 Cut out the appliqué, leaving a seam allowance of between 3 and 5 mm (1/8 and 3/16 inch).

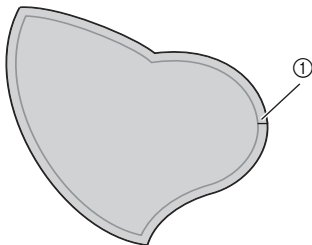

① Seam allowance

- 2 Place a pattern made of thick paper or stabilizer on the back of the appliqué, and then fold over the seam allowance using an iron.

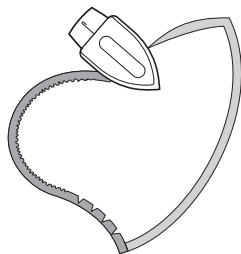

- 3 Turn the fabric over, and then baste or fuse it onto the fabric that it will be attached to.

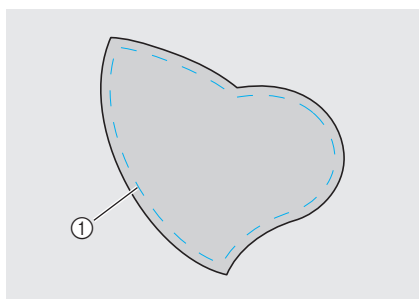

① Basting stitching

- 4 Attach zigzag foot "J".

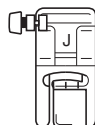

- For details on replacing the presser foot, refer to "Replacing the presser foot" (page 43).

- 5 Select a stitch.

- For details, refer to "Selecting stitching" (page 51).

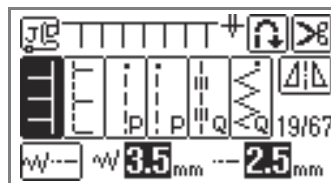
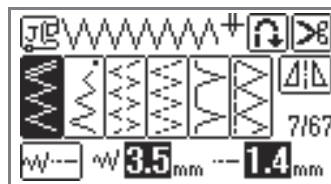

- 6 Turn the handwheel toward you (counterclockwise), and then begin sewing around the edge of the appliqué, making sure that the needle drops just outside of the appliqué.

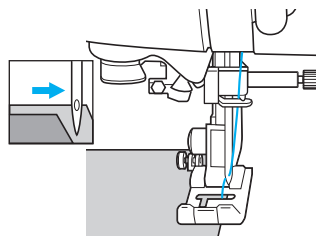

When sewing around corners, stop the machine with the needle in the fabric just outside of the appliqué, raise the presser foot lever, and then turn the fabric as needed to change the sewing direction.

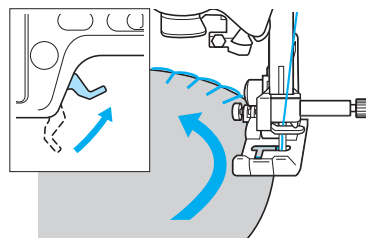

Patchwork (crazy quilt) stitching

- 1 Fold the edge of the top piece of fabric and place it over the lower piece.
- 2 Sew the two pieces of fabric together so the pattern spans over both pieces.

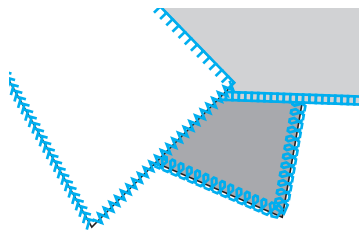
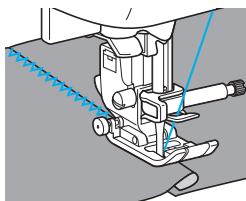

Piecing

Sewing together two pieces of fabric is called "piecing". The fabric pieces should be cut with a 6.5 mm (1/4 inch) seam allowance. Sew a piecing straight stitch 6.5 mm (1/4 inch) from either the right side or the left side of the presser foot.

- 1 Baste or pin along the seam allowance of the fabric that you wish to piece together.
- 2 Attach zigzag foot "J".

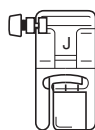

- For details on replacing the presser foot, refer to "Replacing the presser foot" (page 43).

- 3 Select stitch 21  or 22 .

- For details, refer to "Selecting stitching" (page 51).

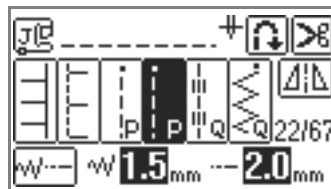

Memo

- The piecing straight stitch shows a "P" on the LCD.

- 4 Sew with the side of the presser foot aligned with the edge of the fabric.

■ For a seam allowance on the right side

Align the right side of the presser foot with the edge of the fabric, and sew using stitch 21 .

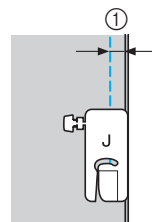

- ① 6.5 mm (1/4 inch)

■ For a seam allowance on the left side

Align the left side of the presser foot with the edge of the fabric, and sew using stitch 22 .

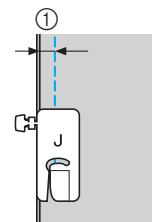

- ① 6.5 mm (1/4 inch)



Memo

- To change the width of the seam allowance (needle position), refer to "Changing the needle position" (page 83).

Quilting

Sandwiching batting between the top and bottom layers of fabric is called "quilting". Quilts can easily be sewn using the optional walking foot and the quilting guide.

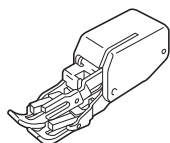

Walking foot

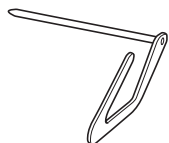

Quilting guide



Note

- Thread the needle manually when using the walking foot, or only attach the walking foot after threading the needle using the needle threader.
- When sewing with the walking foot, sew at a speed between slow and medium.
- When quilting, use a 90/14 home sewing machine needle.
- The walking foot can only be used with straight or zigzag stitch patterns. Reverse stitches cannot be sewn with the walking foot. Only select straight or zigzag stitch patterns with reinforcement stitches. For details, refer to "Stitch Setting Chart" (page 72).

1 Baste the fabric to be quilted.

2 Remove the presser foot and the presser foot holder.

- For details, refer to "Removing and attaching the presser foot holder" (page 45).

3 Hook the connecting fork of the walking foot onto the needle clamp screw.

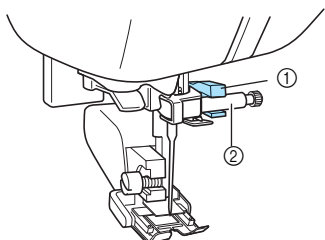

- ① Connecting fork
- ② Needle clamp screw

4 Lower the presser foot lever, insert the presser foot holder screw, and then tighten the screw with the screwdriver.

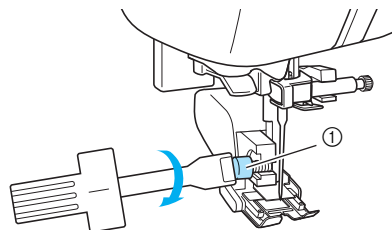

- ① Presser foot holder screw

▶ The walking foot is attached.

CAUTION

- Be sure to securely tighten the screw with the screwdriver, otherwise the needle may touch the presser foot, causing it to bend or break.
- Before starting to sew, slowly turn the handwheel toward you (counterclockwise) and check that the needle does not touch the presser foot. If the needle hits the presser foot, the needle may bend or break.

5 Select a stitch.

- For details, refer to "Selecting stitching" (page 51).

6 Place one hand on each side of the presser foot, and then evenly guide the fabric while sewing.

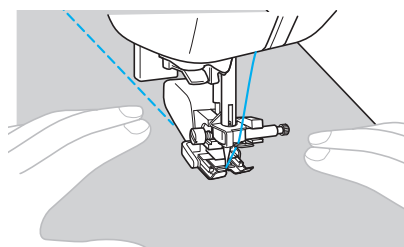

■ Using the optional quilting guide

Use the quilting guide to sew parallel stitches that are equally spaced.

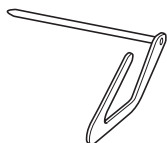

- 1** Insert the stem of the quilting guide into the hole at the rear of the walking foot or presser foot holder.

- Walking foot

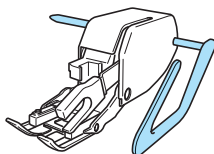

- Presser foot holder

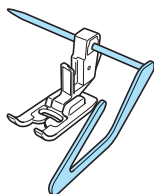

- 2** Adjust the stem of the quilting guide so that the guide aligns with the seam that has already been sewn.

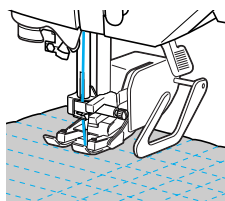

Free-motion quilting

With free-motion quilting, lower the feed dogs (using the drop feed lever) so that the fabric can be moved freely in any direction.

When free-motion quilting, use the following instructions with the optional free-motion open toe quilting foot "O" (SA187, F061).

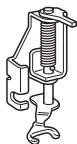

CAUTION

- Be sure to use the optional free-motion open toe quilting foot "O" when making free-motion quilting. If the quilting foot (SA129, F005N) is used, the needle threader may be damaged.

1 Remove the presser foot and the presser foot holder.

- Refer to "Removing and attaching the presser foot holder" (page 45).

2 Attach free-motion quilting foot "O" by positioning the pin of the quilting foot above the needle clamp screw and aligning the lower-left of the quilting foot and the presser bar.

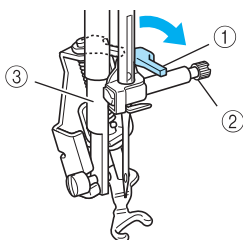

- ① Pin
- ② Needle clamp screw
- ③ Presser bar



Note

- Make sure that the quilting foot is not slanted.

3 Hold the quilting foot "O" in place with your right hand, and then tighten the presser foot holder screw using the screwdriver in your left hand.

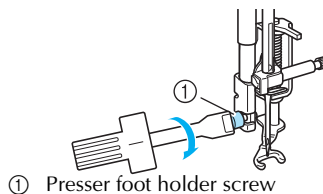

- ① Presser foot holder screw

CAUTION

- Be sure to securely tighten the screw with the screwdriver. Otherwise the needle may touch the presser foot, causing it to bend or break.

4 Slide the drop feed lever, located at the rear of the machine on the base, to (to the left as seen from the rear of the machine).

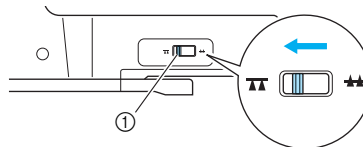

- ① Drop feed lever (as seen from the rear of the machine)

► The feed dogs are lowered.

5 Turn on the sewing machine, and then select a stitch or .

- For details, refer to "Selecting stitching" (page 51).

6 Use both hands to stretch the fabric taut, and then move the fabric at a consistent pace in order to sew uniform stitches roughly 2.0-2.5mm (approx. 1/16 - 3/32 inch) in length. Reinforcement stitches are sewn at the beginning and end of sewing.

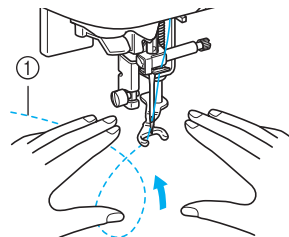

- ① Stitch

7 After sewing is finished, slide the drop feed lever to (to the right as seen from the rear of the machine) and turn the handwheel to raise the feed dogs.



Memo

- The drop feed lever is normally set to the right side.

Satin stitching using the sewing speed controller

A decorative stitch can be sewn by changing the stitch width of a satin stitch. If the sewing machine is set so that the stitch width can be adjusted using the sewing speed controller, the stitch width can quickly and easily be adjusted. In this case, the sewing speed is adjusted with the foot controller.

1 Connect the foot controller.

- For details, refer to "Using the foot controller" (page 56).

2 Attach zigzag foot "J".

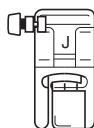

- For details on replacing the presser foot, refer to "Replacing the presser foot" (page 43).

3 Turn on the sewing machine, and then press (Settings key) on the operation panel.

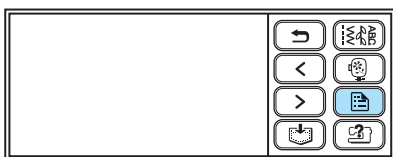

- ▶ The setting screen appears.



4 Press "ON" for stitch width control setting.



- ▶ The machine is now set so that the stitch width can be controlled with the sewing speed controller.



Memo

- If the stitch width control setting is set to "ON",   for stitch width will change to sewing speed controller icon .

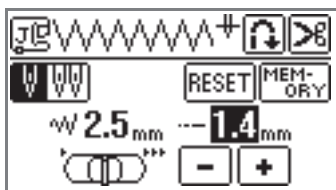

5 Press (Back key).

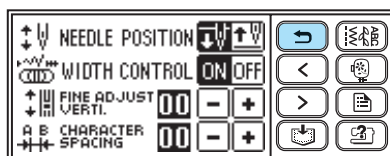

- ▶ The initial screen appears again.

6 Select a stitch.

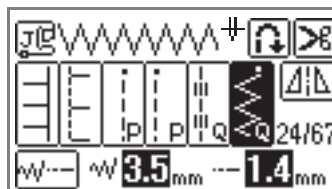

- For details, refer to "Selecting stitching" (page 51).

7 While sewing, slide the sewing speed controller to adjust the stitch width.

Slide the controller to the left to make the width narrower. Slide the controller to the right to make the width wider.

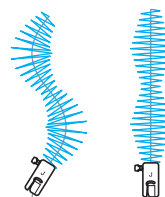
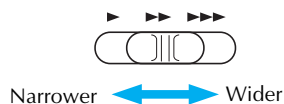

- Adjust the sewing speed with the foot controller.



Memo

- When the foot controller is plugged in,  (Start/stop button) cannot be used to start sewing.

8 When you have finished sewing, set the stitch width control setting back to "OFF".







Memo

- Although the stitching result differs depending on the type of fabric being sewn and the thickness of the thread being used, for best results, adjust the stitch length to between 0.3 and 0.5 mm (1/64 and 1/32 inch).

Reinforcement Stitching

Reinforce points that will be subject to strain, such as sleeve holes, inseams and pocket corners.

Stitch Name	Pattern	Application	Stitch Width [mm (inch)]		Stitch Length [mm (inch)]		Presser Foot
			Auto	Manual	Auto	Manual	
Triple stretch stitch	4 	Reinforcing the seams of sleeves and inseams	0.0 (0)	0.0-7.0 (0-1/4)	2.5 (3/32)	1.5-4.0 (1/16-3/16)	J
Bar tack stitch	60 	Reinforcing the ends of openings, such as the corners of pockets	2.0 (1/16)	1.0-3.0 (1/16-1/8)	0.4 (1/64)	0.3-1.0 (1/64-1/16)	A
Darning stitch	58 	Darning mediumweight fabrics	7.0 (1/4)	2.5-7.0 (3/32-1/4)	2.0 (1/16)	0.4-2.5 (1/64-3/32)	
	59 	Darning thick fabrics					

CAUTION

● Be sure to turn off the main power before replacing the presser foot. Otherwise, injuries may occur if ⏻ (Start/stop button) is accidentally pressed and the machine starts sewing.

Triple stretch stitching

Use triple stretch stitching to reinforce sleeve holes and inseams.

1 Attach zigzag foot "J".

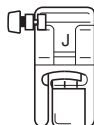

- For details on replacing the presser foot, refer to "Replacing the presser foot" (page 43).

2 Select stitch 4 .

- For details, refer to "Selecting stitching" (page 51).

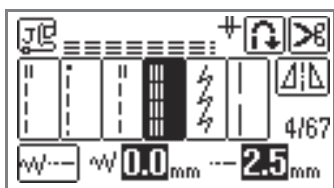

3 Start sewing.

- For details, refer to "Starting to sew" (page 55).

Bar tack stitching

Bar tacks are used to reinforce points subject to strain, such as pocket corners and openings. As an example, the procedure for sewing bar tacks at pocket corners is described below.

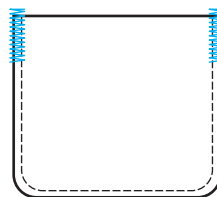

- 1 Determine the desired length of the bar tack.**
Set the button guide plate on buttonhole foot "A" to the desired length. (The distance between the markings on the presser foot scale is 5 mm (3/16 inch).)

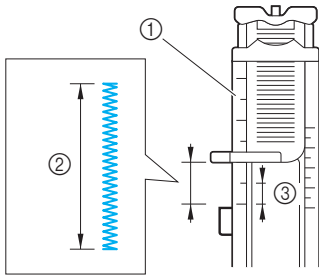

- ① Presser foot scale
② Length of bar tack
③ 5 mm (3/16 inch)



Memo

- A bar tack with a maximum length of about 28 mm (1-1/8 inches) can be sewn.

- 2 Attach buttonhole foot "A".**

- For details on replacing the presser foot, refer to "Replacing the presser foot" (page 43).

- 3 Select stitch 60.**

- For details, refer to "Selecting stitching" (page 51).

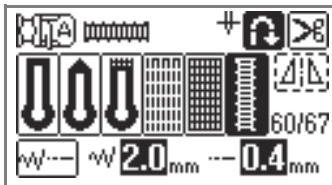

- 4 Position the fabric so that the opening of the pocket faces toward you, and then lower the presser foot lever so that the needle drops 2 mm (1/16 inch) in front of the pocket opening.**

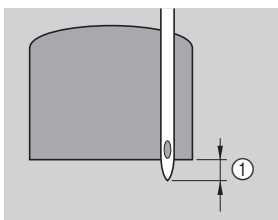

- ① 2mm (1/16 inch)

- Pass the upper thread down through the hole in the presser foot.

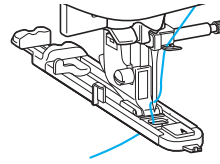

Note

- When lowering the presser foot, do not push in the front of the presser foot, otherwise the bar tack will not be sewn with the correct size.

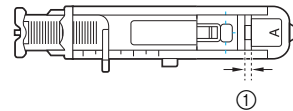
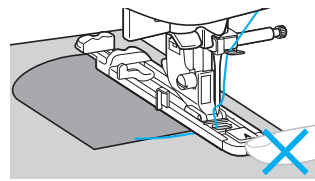

- ① Do not reduce the gap.

- 5 Pull down the buttonhole lever as far as possible.**

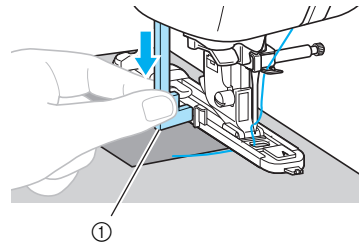

- ① Buttonhole lever

The buttonhole lever is positioned behind the bracket on the buttonhole foot.

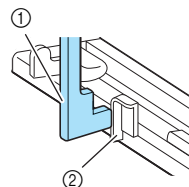

- ① Buttonhole lever
② Bracket

- 6 Gently hold the end of the upper thread in your left hand, and then start sewing.**

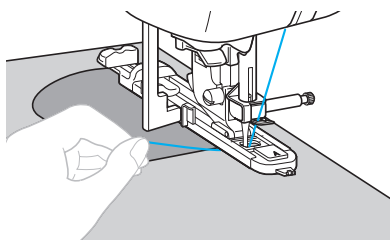

- ▶ Once sewing is completed, the sewing machine automatically sews reinforcement stitches, then stops.

- 7 Press  (Thread cutter button) once.**

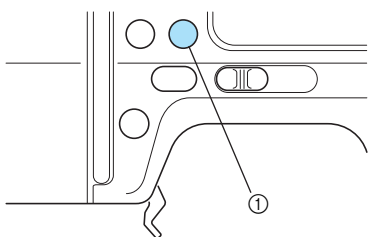

- ① Thread cutter button

- ▶ The threads are cut and the needle is raised.

- 8 Raise the presser foot lever, and then remove the fabric.**



Memo

- If programmed thread-cutting is set, the sewing machine will sew reinforcement stitching, and then cut the thread automatically at the end of the stitching. Refer to "Automatically cutting the thread" (page 65).
- When you cut the threads by using the thread cutter on the side of the machine or scissors, first press  (Needle position button) once to raise the needle, then raise the presser foot lever and pull the fabric to the left side of the machine, and then cut the threads. Refer to "Using the thread cutter" (page 60).

- 9 Raise the buttonhole lever to its original position.**



Memo

- If the fabric does not feed, for example, because it is too thick, increase the stitch length. For details, refer to "Adjusting the stitch length" (page 62).

Darning

Fabric that has been torn can be darned.
Darning is sewn as shown below.

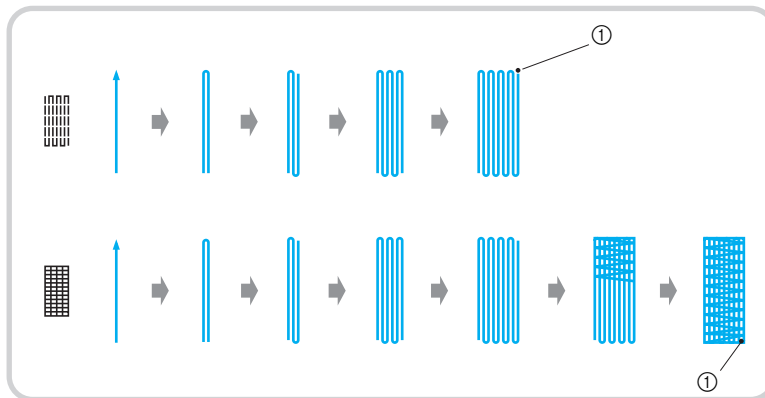

① Reinforcement stitching

- Determine the desired length of the darning.**
Set the button guide plate on buttonhole foot "A" to the desired length. (The distance between the markings on the presser foot scale is 5 mm (3/16 inch).)

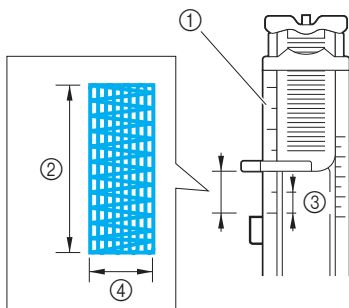

- Presser foot scale
- Length of darning
- 5 mm (3/16 inch)
- 7 mm (1/4 inch)



Memo

- A bar tack with a maximum length of about 28 mm (1-1/8 inches) can be sewn.

- Attach buttonhole foot "A".**

- For details on replacing the presser foot, refer to "Replacing the presser foot" (page 43).

- Select stitch 58 or 59.**

- For details, refer to "Selecting stitching" (page 51).

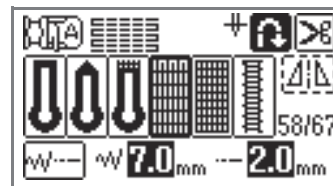

- Position the fabric so that the needle is 2 mm (1/16 inch) in front of the area to be darned, and then lower the presser foot lever.**

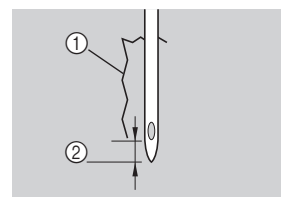

- Tear
- 2 mm (1/16 inch)

- Pass the upper thread down through the hole in the presser foot.

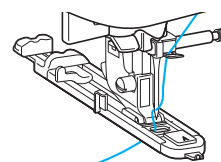



Memo

- When lowering the presser foot, do not push in the front of the presser foot, otherwise the darning will not be sewn with the correct size.

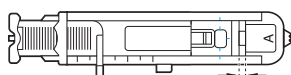
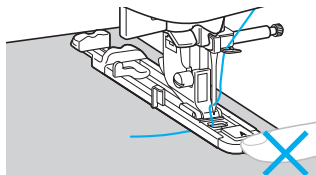

- ① Do not reduce the gap.

5

Pull down the buttonhole lever as far as possible.

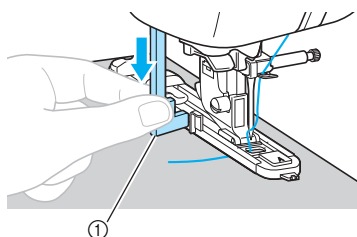

- ① Buttonhole lever

The buttonhole lever is positioned behind the bracket on the buttonhole foot.

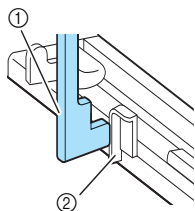

- ① Buttonhole lever
- ② Bracket

6

Gently hold the end of the upper thread in your left hand, and then start sewing.

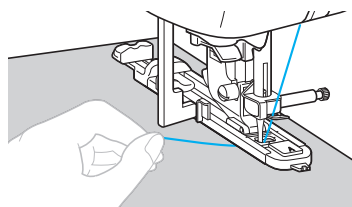

- ▶ Once sewing is completed, the sewing machine automatically sews reinforcement stitches, then stops.

7

Press  (Thread cutter button) once.

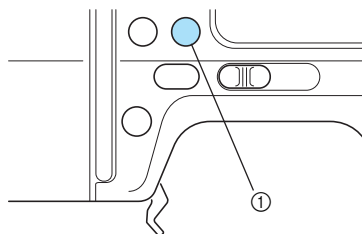

- ① Thread cutter button

- ▶ The threads are cut and the needle is raised.

8

Raise the presser foot lever, and then remove the fabric.



Memo

- If programmed thread-cutting is set, the sewing machine will sew reinforcement stitching, and then cut the thread automatically at the end of the stitching. Refer to "Automatically cutting the thread" (page 65).
- When you cut the threads by using the thread cutter on the side of the machine or scissors, first press  (Needle position button) once to raise the needle, then raise the presser foot lever and pull the fabric to the left side of the machine, and then cut the threads. Refer to "Using the thread cutter" (page 60).

9

Raise the buttonhole lever to its original position.



Memo

- If the fabric does not feed, for example, because it is too thick, increase the stitch length. For details, refer to "Adjusting the stitch length" (page 62).

Eyelet Stitching

Eyelets, such as those on belts, can be sewn. Three sizes of eyelets are possible: 7 mm, 6 mm and 5 mm (1/4, 15/64 and 3/16 inch).

Stitch Name	Pattern	Application	Stitch Width [mm (inch)]		Stitch Length [mm (inch)]		Presser Foot
			Auto	Manual	Auto	Manual	
Eyelet stitch	62 	Sewing eyelets, for example, on belts	7.0 (1/4)	7.0, 6.0 or 5.0 (1/4, 15/64 or 3/16)	7.0 (1/4)	7.0, 6.0 or 5.0 (1/4, 15/64 or 3/16)	N

CAUTION

- Be sure to turn off the main power before replacing the presser foot. Otherwise, injuries may occur if  (Start/stop button) is accidentally pressed and the machine starts sewing.

- 1 Attach monogramming foot "N".

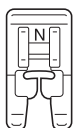

- For details on replacing the presser foot, refer to "Replacing the presser foot" (page 43).

- 2 Select stitch 62 .

- For details, refer to "Selecting stitching" (page 51).

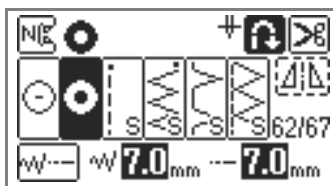

- 3 Adjust either the stitch width or the stitch length to select the desired eyelet size.

- For details, refer to "Adjusting the stitch width" (page 61) and "Adjusting the stitch length" (page 62).



7mm



6mm



5mm

- 4 Lower the needle into the fabric at the beginning of the stitching, and then lower the presser foot lever.

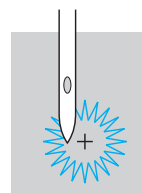

- 5 Start sewing.

- ▶ Once sewing is completed, the sewing machine automatically sews reinforcement stitches, then stops.

- 6 Use the eyelet punch to cut a hole in the center of the eyelet.

When using the eyelet punch, place thick paper or some other protective sheet under the fabric before punching the hole in the fabric.

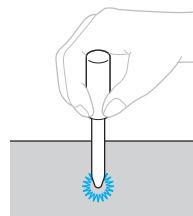























Memo

- If thin thread is used, the stitching may be too open. If this occurs, sew the eyelet twice before removing the fabric, one on top of the other.

Decorative Stitching

The utility stitches contain the following decorative stitches.

Stitch Name	Pattern	Application	Stitch Width [mm (inch)]		Stitch Length [mm (inch)]		Presser Foot
			Auto	Manual	Auto	Manual	
Fagoting stitch	32 	Sewing two pieces of fabric together across an open seam	5.0 (3/16)	0.0-7.0 (0-1/4)	2.5 (3/32)	1.0-4.0 (1/16-3/16)	J
	33 			2.5-7.0 (3/25-1/4)			
Joining stitch	28 	Decorative bridging stitches	4.0 (3/16)	0.0-7.0 (0-1/4)	1.2 (1/16)	0.2-4.0 (1/64-3/16)	
	29 		5.0 (3/16)	2.5-7.0 (3/32-1/4)	2.5 (3/32)	1.0-4.0 (1/16-3/16)	
	30 			1.2 (1/16)	0.2-4.0 (1/64-3/16)		
Shell tuck stitch	20 	Shell tuck stitching on collars and curves	4.0 (3/16)	0.0-7.0 (0-1/4)	2.5 (3/32)	1.0-4.0 (1/16-3/16)	
Smocking stitch	31 	Smocking fabrics to add texture and elasticity	5.0 (3/16)		1.6 (1/16)		
	32 			2.5-7.0 (3/25-1/4)	0.1-1.0 (1/64-3/16)		
	33 						
Satin scallop stitch	27 	Scallop stitching			0.5 (1/32)	0.1-1.0 (1/64-3/16)	
Decorative stitch	39 	Lace sewing, decorative hemming, heirloom stitching, etc.	3.5 (1/8)	1.5-7.0 (1/16-1/4)	2.5 (3/32)	1.6-4.0 (1/16-3/16)	
	40 		6.0 (15/64)		3.0 (1/8)		
	41 	Decorative hemming and heirloom stitching, etc. on thin, mediumweight and plain weave fabrics	5.0 (3/16)		3.5 (1/8)	2.5 (3/32)	1.5-4.0 (1/16-3/16)
	42 				4.0 (3/16)		
	43 				2.0 (1/16)		
	44 				3.0 (1/8)		
	45 	Decorative hemming, ribbon threading, heirloom stitching, etc.					

Stitch Name	Pattern	Application	Stitch Width [mm (inch)]		Stitch Length [mm (inch)]		Presser Foot
			Auto	Manual	Auto	Manual	
Decorative stitch	46 	Heirloom stitching, etc.	6.0 (15/64)	1.5-7.0 (1/16-1/4)	1.6 (1/16)	1.0-4.0 (1/16-3/16)	N
	47 		5.0 (3/16)				
	35 	Decorative stitching	4.0 (3/16)	0.0-7.0 (0-1/4)	3.0 (1/8)	2.0-4.0 (1/16-3/16)	J
	36 				2.5 (3/32)		
	37 				1.6 (1/16)	1.0-4.0 (1/16-3/16)	
	38 				5.5 (7/32)		
		5.0 (3/16)	1.5-7.0 (1/16-1/4)	1.0 (1/16)	0.2-4.0 (1/64-3/16)	N	

CAUTION

- Be sure to turn off the main power before replacing the presser foot. Otherwise, injuries may occur if  (Start/stop button) is accidentally pressed and the machine starts sewing.

Fagoting

Stitching across an open seam is called "fagoting". It is used on blouses and children's clothing. This stitch is more decorative when thicker thread is used.

- 1 Use an iron to fold the two pieces of fabric along their seams.
- 2 Baste the two pieces of fabric, separated by about 4 mm (3/16 inch), onto thin paper or a sheet of water-soluble stabilizer.
 - If you draw a line down the middle of the thin paper or water-soluble stabilizer, sewing is easier.

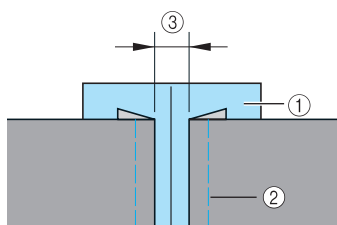

- ① Thin paper or water soluble stabilizer
- ② Basting stitching
- ③ 4 mm (3/16 inch)

- 3 Attach zigzag foot "J".

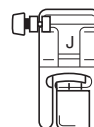

- For details on replacing the presser foot, refer to "Replacing the presser foot" (page 43).

- 4 Select stitch  or .

- For details, refer to "Selecting stitching" (page 51).



- 5 Set the stitch width to 7.0 mm (1/4 inch).

- For details, refer to "Adjusting the stitch width" (page 61).

- 6** Sew with the center of the presser foot aligned along the center of the two pieces of fabric.

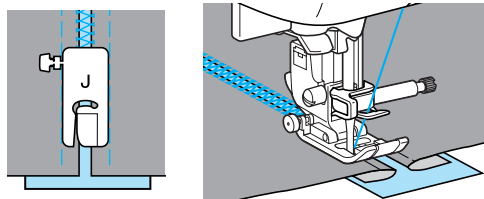

- 7** After sewing is finished, remove the paper.

Scallop stitching

The wave-shaped repeating pattern that looks like shells is called "scalloping". It is used on the collars of blouses and to decorate the edges of projects.

- 1** Attach monogramming foot "N".

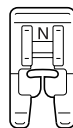

- For details on replacing the presser foot, refer to "Replacing the presser foot" (page 43).

- 2** Select stitch $27 \left. \begin{array}{l} \text{J} \\ \text{Q} \end{array} \right\}$.

- For details, refer to "Selecting stitching" (page 51).

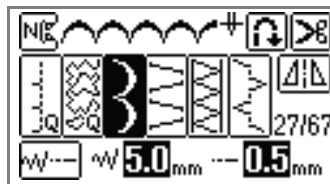

- 3** Stitch along the edge of the fabric, making sure not to sew directly on the edge of the fabric.

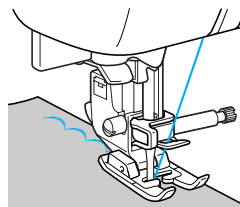

Memo

- For better results, apply spray starch onto the fabric and press with a hot iron before it is sewn.

- 4** Trim along the stitches.

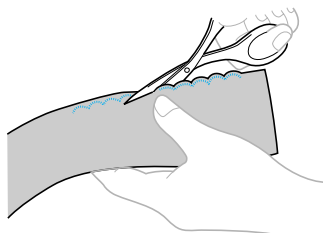

Be careful not to cut the stitches.

Smocking

The decorative stitch created by stitching or embroidering over gathers is called "smocking". It is used to decorate the front of blouses or cuffs. The smocking stitch adds texture and elasticity to fabric.

1 Attach zigzag foot "J".

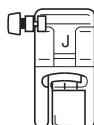

- For details on replacing the presser foot, refer to "Replacing the presser foot" (page 43).

2 Select the straight stitch, and then adjust the stitch length to 4.0 mm (3/16 inch) and loosen the thread tension.

- Pull up the bobbin thread. For details, refer to "When pulling up the bobbin thread may be necessary" (page 29).
- For details, refer to "Adjusting the stitch length" (page 62) and "Adjusting the thread tension" (page 62).

3 Sew parallel stitching at intervals of 1 cm (3/8 inch).

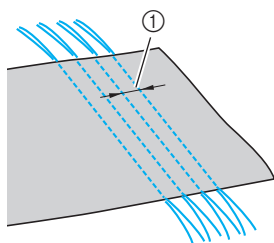

① 1 cm (3/8 inch)

At the end of the stitching, the thread is pulled out about 5 cm (2 inches).



Note

- Do not use reverse/reinforcement stitching or thread cutting.

4 Pull the bobbin threads to create gathers. Smooth the gathers by ironing them.

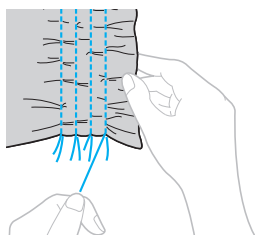

5 Select stitch 31, 32, or 33.

- For details, refer to "Selecting stitching" (page 51).

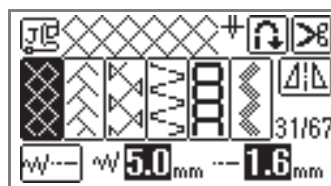

6 Stitch between the straight stitches.

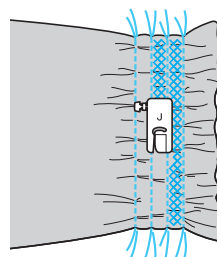

7 Pull out the threads for the straight stitches.

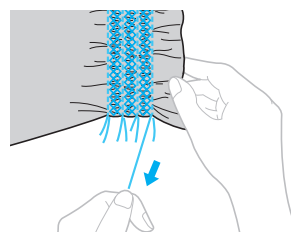

Shell tuck stitching

The gathers that look like shells are called "shell tucks". They are used to decorate trims, the front of blouses or cuffs made of thin fabrics.

1 Fold the fabric along the bias.

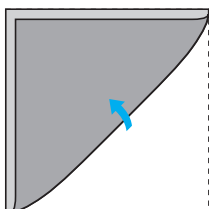

2 Attach zigzag foot "J".

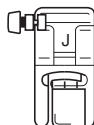

- For details, refer to "Replacing the presser foot" (page 43).

3 Select stitch ²⁰ [] , and then increase the thread tension.

- For details, refer to "Selecting stitching" (page 51) and "Adjusting the thread tension" (page 62).

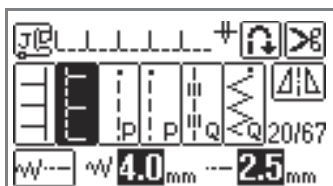

4 Sew while making sure that the needle drops slightly off the edge of the fabric.

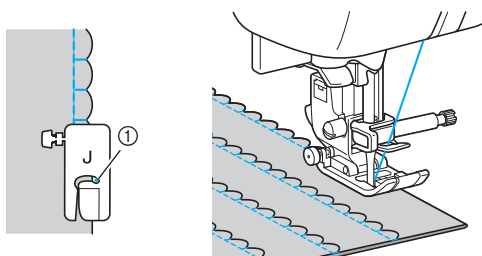

- ① Needle drop point

5 Unfold the fabric, and then iron the tucks down to one side.

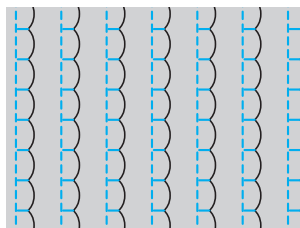

Joining

Decorative bridging stitches can be sewn over the seam allowance of joined fabrics. This is used when making a crazy quilt.

1 Attach zigzag foot "J".

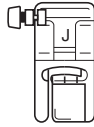

- For details, refer to "Replacing the presser foot" (page 43).

2 Sew together the right sides of the two pieces of fabric, and then open up the seam allowances.

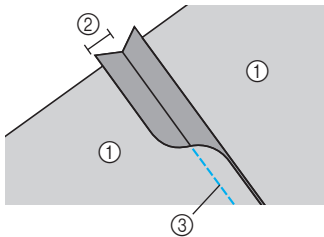

- ① Wrong side of fabric
- ② 7 mm (1/4 inch) seam allowance
- ③ Straight stitch

3 Select stitch 28, 29, or 30.

- For details, refer to "Selecting stitching" (page 51).

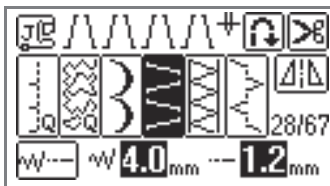

4 Turn the fabric over so that the right side faces up, and then sew over the seam with the center of the presser foot aligned with the seam.

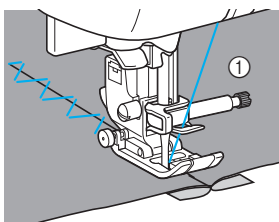

- ① Right side of fabric

Heirloom stitching

When sewing with the wing needle, the needle holes are enlarged, creating a lace-like decorative stitch. This is used to decorate hems and tablecloths on thin or medium weight fabrics in addition to plain weave fabrics.

1 Install the wing needle.



- For details on installing a needle, refer to "Replacing the needle" (page 41).









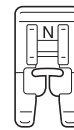

Memo

- Use a 130/705H 100/16 wing needle.
- The needle threader cannot be used with the wing needle, otherwise the sewing machine may be damaged. Manually pass the thread through the eye of the needle from the front to the back. For details, refer to "Threading the needle manually (without using the needle threader)" (page 36).

2 Attach monogramming foot "N".



- For details on replacing the presser foot, refer to "Replacing the presser foot" (page 43).

3 Select a stitch.
 The stitches that can be used are ³⁹, ⁴⁰,
⁴¹, ⁴², ⁴³, ⁴⁴, ⁴⁵, ⁴⁶ or ⁴⁷.

- For details, refer to "Selecting stitching" (page 51).

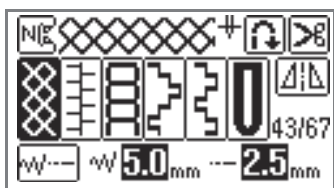
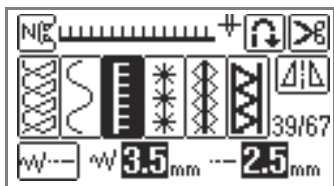

Note

- When sewing with the wing needle, select a stitch width of 6.0 mm (15/64 inch) or less.

4 Start sewing.

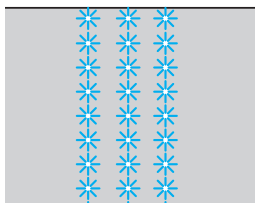

CAUTION

- When sewing with the wing needle, select a stitch width of 6.0 mm (15/64 inch) or less, otherwise the needle may bend or break.
- After adjusting the stitch width, slowly turn the handwheel toward you (counterclockwise) and check that the needle does not touch the presser foot. If the needle hits the presser foot, the needle may bend or break.

Partially removing threads is called "drawnwork". This gives a beautiful result with fabrics that have a loose weave. Two ways to create drawnwork are described below.

■ Drawnwork (Example 1)

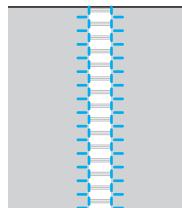

1 Pull out several threads from the fabric.

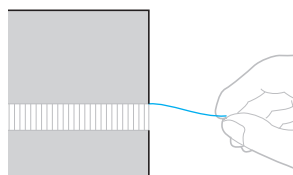

2 Attach monogramming foot "N".

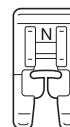

- For details on replacing the presser foot, refer to "Replacing the presser foot" (page 43).

3 Select stitch ³⁹.

- For details, refer to "Selecting stitching" (page 51).

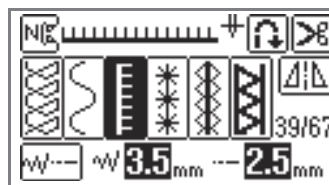

4 With the right side of the fabric facing up, sew along the right edge of the frayed section.

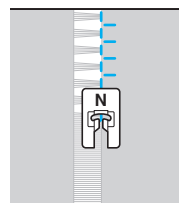

- 5 Press  on the LCD.

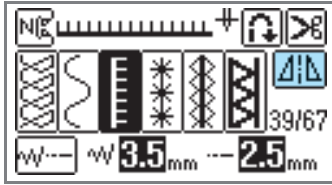

- ▶ The pattern displayed at the top of the screen is mirrored.

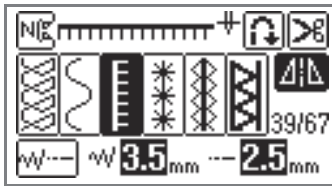

- 6 Sew along the other edge of the frayed section so that it looks like the previous stitching.

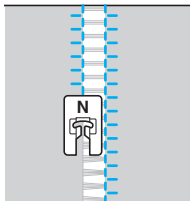

- 7 Press , and set the horizontal mirror image key back to OFF.

■ Drawnwork (Example 2)

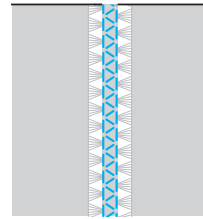

- 1 Pull out several threads from two sections of the fabric, separated by an unfrayed section of about 4 mm (3/16 inch).

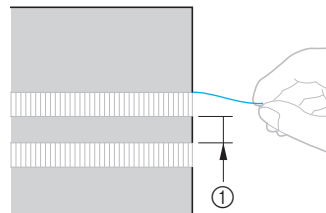

- ① 4 mm (3/16 inch)

- 2 Attach monogramming foot "N".

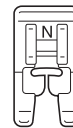

- For details on replacing the presser foot, refer to "Replacing the presser foot" (page 43).

- 3 Select stitch .

- For details, refer to "Selecting stitching" (page 51).



- 4 Sew along the center of the unfrayed section.

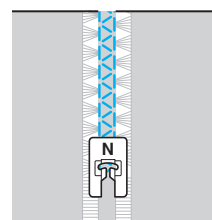

Sewing the Various Built-in Decorative Patterns

Besides utility stitches, you can sew decorative stitches, satin stitches and cross stitches. All are sewn with monogramming foot "N".

Sewing beautiful patterns

In order to sew the patterns correctly, the following must be considered.

■ Fabric

Before sewing stretch or thin fabrics or fabrics with a coarse weave, affix stabilizer material to the wrong side of the fabric or place a thin sheet of paper, such as tracing paper, under the fabric. Since material puckering or bunched stitches may occur when satin stitches are sewn, be sure to affix stabilizer material to the fabric.

■ Needles and threads

When sewing thin, mediumweight or stretch fabrics, use the ball point needle. When sewing thick fabrics, use a 90/14 home sewing machine needle. In addition, #50 to #60 thread should be used.

■ Trial sewing

Depending on the type and thickness of the fabric being sewn and whether or not stabilizer material is used, the desired result may not be achieved. Be sure to sew a trial piece of fabric before sewing your project. In addition, while sewing, be sure to guide the fabric with your hands in order to prevent the fabric from slipping.

Sewing patterns

1 Attach monogramming foot "N".

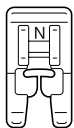

- For details, refer to "Replacing the presser foot" (page 43).

2 Select a stitch.

- For details, refer to steps 1 through 7 of "Selecting stitching" (page 51).

3 Start sewing.

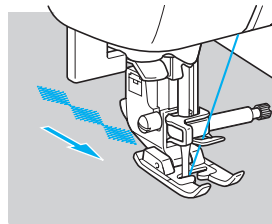

- ▶ The stitching is sewn in the direction indicated by the arrow.

4 Sew reinforcement stitches.



Memo

- When sewing a pattern, it is useful to first set the automatic reverse/reinforcement stitching setting. For details, refer to "Automatic sewing reverse/reinforcement stitches" (page 64).
- When sewing alphanumeric characters, the machine automatically sews reinforcement stitches for each character.

5 When you are finished sewing, use scissors to trim off any excess threads at the beginning of the stitching and between the patterns.





Memo

- For details on adjusting the stitch width and length, refer to "Adjusting the stitch width" (page 61) and "Adjusting the stitch length" (page 62).

Changing the stitch density

If a decorative satin stitch has been selected, the stitch density can be changed.

- 1 Press  (Utility stitch key) on the operation panel, and select  (Decorative satin stitch).





- 2 Select a decorative satin stitch pattern.

- For details on selecting a stitch, refer to "Selecting stitching" (page 51).



- 3 Press  until the desired stitch density is selected.

Select  for sparse stitching, or select  for compact stitching.

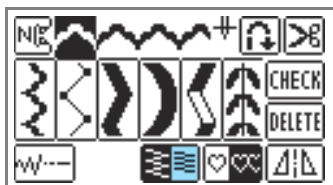

CAUTION

- If the stitching density is too compacted, depending on the needle, the stitches may be bunched together, causing the needle to break.

Changing the pattern size

The size of character stitches in the Gothic font and outline style can be switched between large and small. However, the size of other patterns cannot be changed.

- 1 Select a stitch.

- For details on selecting a stitch, refer to "Selecting stitching" (page 51).

- 2 Press  until the desired size is selected.



- 3 Repeat steps 1 and 2.

LEAFLEAF





Memo

- The large pattern size is the default. If the small pattern size is selected, small patterns can be combined and connected.
- If multiple patterns have been combined, the size of each selected pattern can be specified.

Changing the length for satin stitches

The length for one satin stitch can be changed in five gradations.

- 1 Press  (Utility stitch key) on the operation panel, and then select  (Satin stitch).



- 2 Select a satin stitch pattern.

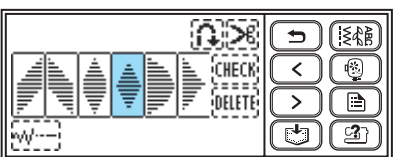
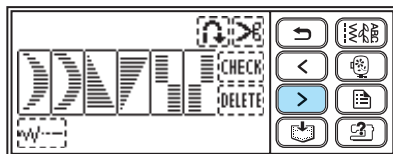



- 3 Press .



- ▶ It turns to  and the pattern becomes longer.



Each time you press it, the number changes. You can select from  - .



Adjusting the character spacing

The space between alphanumeric characters can be adjusted.

- 1 Press  (Utility stitch key) on the operation panel, and then select characters.





- 2 Press  (Setting key).



- 3 Press   for character spacing.



Press  to increase the character spacing.

Press  to decrease the character spacing.

Memo

- The default setting is "00". The number less than "00" cannot be set.
- The result of adjusting the character spacing is valid for all characters. The result is valid not only while entering characters, but also before and after entering characters.

Realigning the pattern

The pattern may not be sewn correctly, depending on the type of fabric being sewn or the sewing speed. If this occurs, adjust the pattern while sewing on a piece of scrap fabric that is the same as that used for your project.



Memo

- Only the eyelet stitch in the utility stitches, cross-stitches, and character stitches can be adjusted using the pattern alignment stitch.

1 Attach monogramming foot "N".

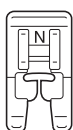

- For details, refer to "Replacing the presser foot" (page 43).

2 Press (Utility stitch key) on the operation panel, and select (Decorative stitch).



- The screen containing the various decorative stitches appears.

3 Select .

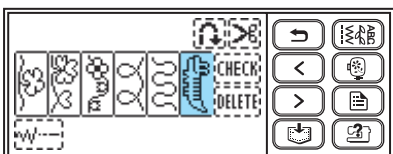

- The pattern alignment stitch is selected.

4 Start sewing.

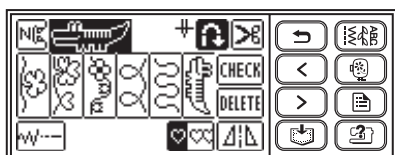

- The pattern for making the adjustment is sewn.
- The sewing machine stops after sewing the pattern has finished.

5 Check the sewn pattern.

If the part of the pattern indicated in the illustration is sewn uniformly, the pattern is correctly aligned.

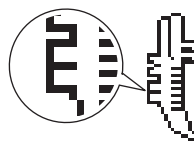

If the pattern is not sewn correctly, follow the steps below to adjust the sewing.

6 Press (Settings key) on the operation panel.

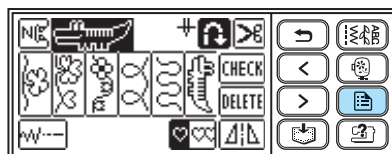

- The settings screen appears.

7 Press for vertical pattern adjustment.

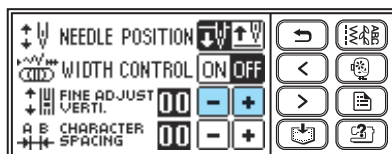

- Make the necessary adjustments according to how the pattern is sewn.

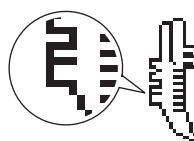

Press to increase the vertical space in the design.



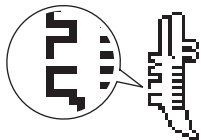

Press to decrease the vertical space in the design.

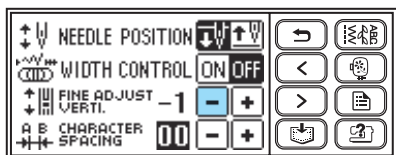

8 Press (Back key).

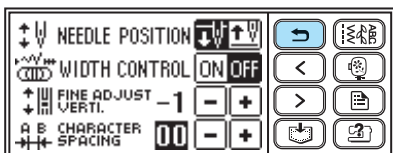

▶ It returns to the screen for adjusting the pattern.

9 Select once again, start the sewing machine and check the stitching.

▶ Continue adjusting the pattern until it is sewn correctly.

Combining patterns

You can sew with combinations of stitches from the decorative stitches, satin stitches, cross-stitches, decorative satin stitches, character stitches and combined utility stitches. Up to 70 patterns can be combined.

1 Touch (Utility stitch key) on the operation panel, and select the stitch type.

Select any one of the decorative stitch, satin stitch, cross stitch, decorative satin stitch, characters or combined utility stitch types.



2 Select the first pattern.

▶ The first pattern is selected and appears on the screen.



- When the sewing is started, the selected pattern is sewn repeatedly until the sewing machine is stopped.

3 Select the next pattern.

▶ The combined pattern appears on the screen.

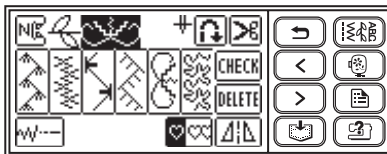

- To remove a selected pattern, press **DELETE** on the screen. The pattern that was selected last is removed.
- To combine patterns from different types, press (Back key), and after selecting the type, select the next pattern.

- 4 After all of the desired patterns are selected, start sewing.

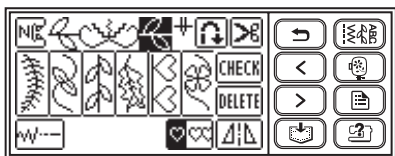

- ▶ The order that the patterns appear on the screen is the order that they will be sewn.



Memo

- Up to 70 patterns can be combined.
- If multiple patterns have been combined, the sewing machine stops once all the selected patterns displayed in the LCD have been sewn. To repeatedly sew the combined pattern, refer to "Repeating patterns".
- The combined pattern can be saved for later use. For details, refer to "Saving patterns" (page 129).

Repeating patterns

When multiple stitches are combined, the sewing machine stops when the pattern displayed on the screen has been completed. Use the following operations to sew a combined pattern repeatedly.



- 1 After the patterns have been combined, press .

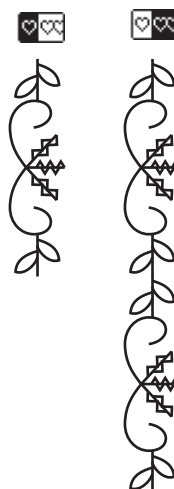

- ▶  turns to , and you can now sew the specified pattern repeatedly.



Memo

- If repeated sewing  is set, the pattern is repeatedly sewn until the sewing machine is stopped.
- If the sewing machine is turned off, the repeated/single sewing setting returns to its default setting.
- If pressed again, it turns to  (single sewing).

■ Mirroring a pattern image

- 1 After a single pattern has been selected, press  to mirror the pattern image horizontally.





■ Checking the pattern

When the specified pattern is not displayed on the screen, check the pattern using the following steps.

- 1 Press .



- ▶ The screen for checking the pattern is displayed.

- 2 Press  , and confirm the pattern.



- 3 Press  (Back key).

- ▶ The initial screen appears again.

 **Memo**

- The combined pattern can be saved for later use. For details, refer to "Saving patterns" (page 129).

Saving patterns

Combined patterns can be saved for later use. Since saved patterns are not lost after the sewing machine is turned off, they can be retrieved at any time. Up to 10 patterns can be saved.

■ Saving a pattern

1 Create the combined pattern that you wish to save.

- For details, refer to "Combining patterns" (page 126).

2 Press (Memory key) on the operation panel.



- ▶ "Saving..." appears while the pattern is being saved. After the pattern is saved, the initial screen appears again.

- Do not turn off the sewing machine while the pattern is being saved, otherwise the pattern data may be lost.

■ Retrieving a pattern

1 Press . Recall the saved pattern.

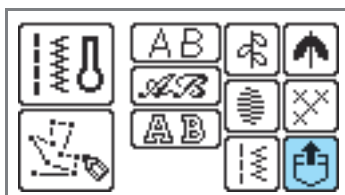

- ▶ The screen for selecting a pocket appears.

2 Select the pocket where the combined pattern you wish to retrieve is saved.

 indicates pockets where patterns are already saved.



- ▶ The selected pocket is shown in reverse highlighting, and the saved pattern is displayed.

3 Check the contents, and then press . Press to check a pattern that is not displayed completely.

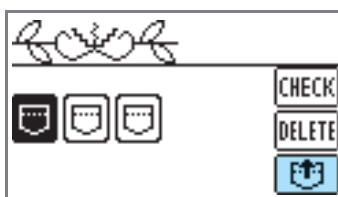

- ▶ The saved pattern is retrieved.
- ▶ The pattern selection screen appears, and you can sew the pattern you have retrieved.

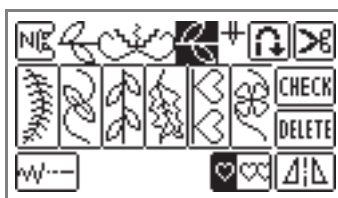

■ **Deleting a saved pattern**

A saved pattern in a pocket can be deleted.

1 Press .

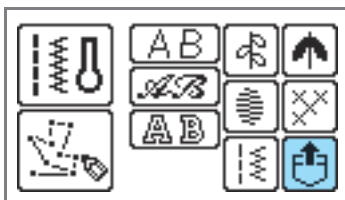

2 Select the pocket where the pattern you wish to delete is saved.

 indicates pockets where patterns are already saved.

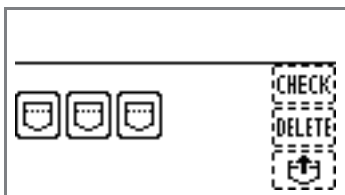

▶ The selected pocket is shown in reverse highlighting, and the saved pattern is displayed.

3 Check the contents, and then press .

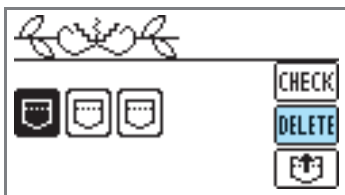

▶ The confirmation message is displayed.

4 Press .

▶ The saved pattern and the pocket are deleted.

Designing a Pattern (My Custom Stitch)

With the My Custom Stitch function, you can sew stitch patterns that you design yourself.

Drawing a sketch of the pattern

Prepare a grid sheet set.

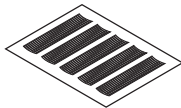

1 Draw a sketch of the pattern on the grid sheet set.

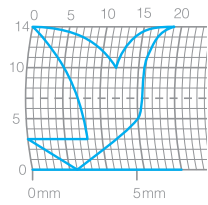

Draw the pattern as one continuous line and with the start point and the end point of the design at the same height.

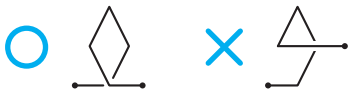

2 If the pattern will be repeated, determine the space between the repeating patterns.

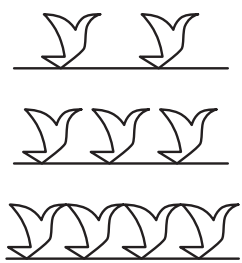
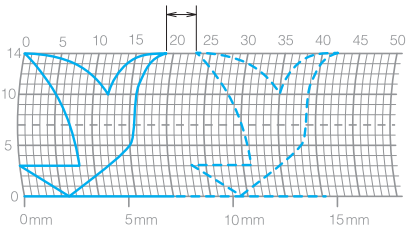

3 Mark the points in the pattern that are positioned at intersections in the grid, and then link those points with a continuous straight line.

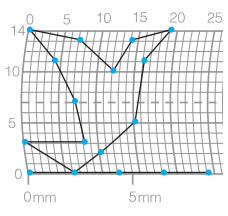

4 Determine the sewing order.

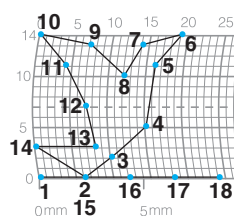

For a more attractive stitch, close the pattern by intersecting the line.

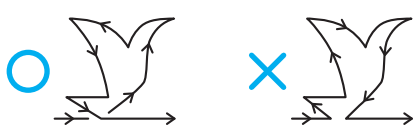

Entering the pattern data

Follow the pattern drawn on the grid sheet and program the pattern into the sewing machine.

1 Attach monogramming foot "N".

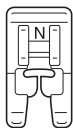



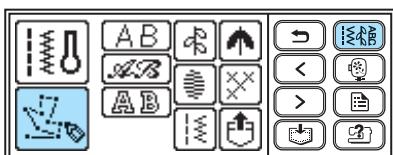

- For details, refer to "Replacing the presser foot" (page 43).

2 Press (Utility stitch key) on the operation panel, and select .



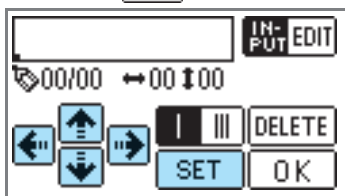

3 Check the grid sheet set, and specify the coordinates of the first point.

Specify the coordinates using   , and then press .



4 Specify whether single stitching or triple stitching will be sewn between the points.

 is single stitching, and  gives triple stitching.

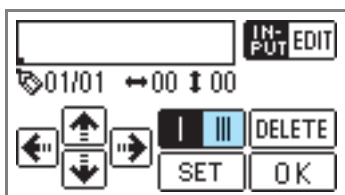

5 Specify the coordinates of the second point, and then press .

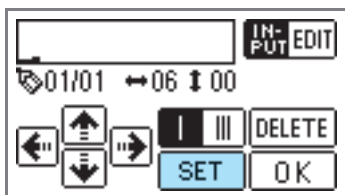

6 Repeat steps 4 through 5 to specify each point.

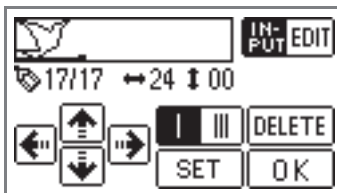

- If you make a mistake entering a point, press , and the previous point is erased.



Memo

- If you want to edit the pattern, press . You can insert, delete and move points if you have entered at least two points. For details, refer to "Editing the pattern data" (page 133).

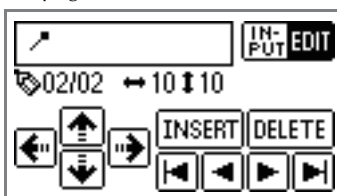

7 After all points have been entered, press .

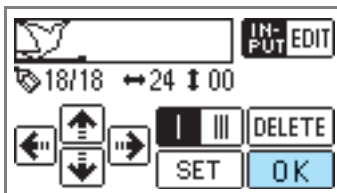

▶ The embroidery screen appears.

8 Specify the various stitching settings, such as reverse/reinforcement stitching, in the same way as with other stitches.

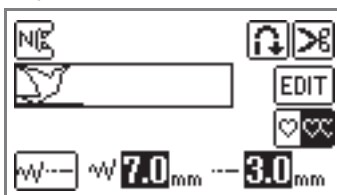

- To revise the pattern, press .



Memo

- The pattern you entered can be saved for later use. For details, refer to "Saving patterns" (page 129).

Editing the pattern data

To edit the pattern you entered, press **IN-PUT EDIT**. The screen for editing the pattern appears. You can move, insert and delete points.

When you have finished editing the pattern, press **IN-PUT EDIT** to go back to the screen for entering the pattern, and then follow steps 6 through 8 on "Entering the pattern data" (page 132).

■ Moving a point

1 Press **←** or **→** to select the point you want to move.

- Press **↶** to jump to the first point.
Press **↷** to jump to the last point.

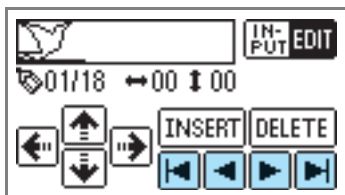

2 Use **←**, **→**, **↑**, or **↓** to move the point.

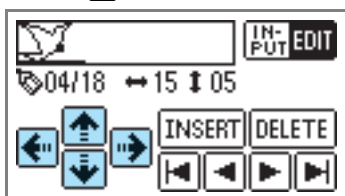

■ Inserting a new point

You can add a new point halfway between the selected point and the next point.

1 Select the point just before the position you want to insert a new point using **←** or **→**.

- Press **↶** to jump to the first point.
Press **↷** to jump to the last point.

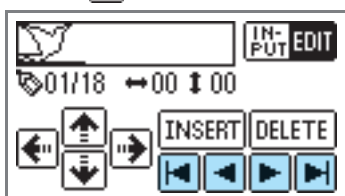

2 Press **INSERT**.

- ▶ A new point is inserted halfway between the selected point and the next point.

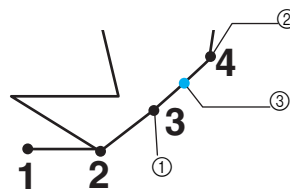

- ① Selected point
- ② Next point
- ③ New point



Memo

- If you press **INSERT** when the last point is selected, new point will not be inserted.

3 If necessary, adjust the position of the new point using **←**, **→**, **↑**, or **↓**.



■ Deleting a point

1 Press **←** or **→** to select the point you want to delete.

- Press **↶** to jump to the first point.
Press **↷** to jump to the last point.

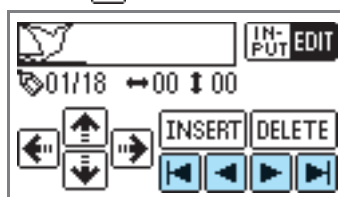

2 Press **DELETE** to delete the point.

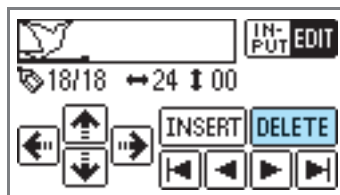



Examples of designs

Enter each of the points indicated in the table to sew the sample stitch.

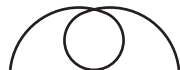
					
Point	↔	↑↓	Point	↔	↑↓
1	0	0	21	38	13
2	12	0	22	35	14
3	18	3	23	32	13
4	22	6	24	30	10
5	23	10	25	32	6
6	21	13	26	35	3
7	17	14	27	41	0
8	14	13	28	45	0
9	12	11	29	47	4
10	9	13	30	44	7
11	6	14	31	45	11
12	3	13	32	47	13
13	1	10	33	50	14
14	3	6	34	54	13
15	6	3	35	56	10
16	12	0	36	55	6
17	41	0	37	51	3
18	43	4	38	45	0
19	40	7	39	70	0
20	41	11			

					
Point	↔	↑↓	Point	↔	↑↓
1	0	0	21	16	10
2	3	5	22	18	12
3	5	8	23	21	13
4	8	11	24	25	14
5	12	13	25	28	14
6	17	14	26	33	13
7	20	14	27	37	11
8	24	13	28	41	8
9	27	12	29	43	5
10	29	11	30	44	0
11	31	9			
12	32	6			
13	30	3			
14	27	1			
15	24	0			
16	21	0			
17	18	1			
18	16	3			
19	15	5			
20	15	8			

					
Point	↔	↑↓	Point	↔	↑↓
1	0	0	21	10	11
2	30	0	22	12	10
3	32	1	23	8	9
4	32	7	24	12	8
5	32	10	25	7	6
6	33	12	26	12	6
7	35	11	27	6	3
8	35	8	28	10	2
9	37	12	29	5	0
10	35	14	30	10	2
11	32	14	31	16	1
12	30	11	32	19	0
13	30	5	33	23	0
14	29	3	34	22	6
15	26	8	35	17	10
16	24	10	36	22	6
17	18	13	37	23	0
18	13	14	38	19	0
19	12	14	39	42	0
20	13	12			

					
Point	↔	↑↓	Point	↔	↑↓
1	0	7	21	20	11
2	5	7	22	21	7
3	4	3	23	24	7
4	5	7	24	23	14
5	8	7	25	24	7
6	7	0	26	27	7
7	8	7	27	27	11
8	11	7	28	27	7
9	11	3	29	32	7
10	11	7	30	27	11
11	16	7	31	23	14
12	11	3	32	20	11
13	7	0	33	16	7
14	4	3	34	20	3
15	0	7	35	23	0
16	4	11	36	27	3
17	7	14	37	32	7
18	11	11			
19	16	7			
20	21	7			



4

EMBROIDERY

The steps for embroidering are described in this chapter.

Embroidering Neatly	136
Attaching the Embroidery Foot.....	138
Attaching the Embroidery Unit.....	141
Preparing the Fabric	144
Attaching the Embroidery Frame.....	148
Selecting Embroidery Patterns.....	150
Embroidering.....	157
Editing and Saving Patterns	162
Using the Memory Function.....	169

Embroidering Neatly

This section describes the preparations and basic procedures for embroidering.

What to prepare

The following is necessary for embroidering.

■ Fabric

Prepare the fabric for embroidery. Prepare a piece of fabric a little larger than the embroidery frame that matches the size of the pattern you want to sew.



Note

- Always use stabilizer when sewing embroidery projects, especially when embroidering on lightweight or stretch fabrics.
- When embroidering on large pieces of fabric, arrange the fabric so that it does not hang off the table where the sewing machine is placed. If embroidery is done with the fabric hanging off, the embroidery unit movement may be impaired, this could cause the pattern to sew incorrectly.



CAUTION

- **Do not embroider fabrics that are too thick. To check the fabric thickness, attach the embroidery frame to the embroidery unit, and use ⊕ (Needle position button) to raise the needle. If there is space between the presser foot and the fabric, the fabric can be embroidered. If there is not space, do not embroider the fabric. Otherwise, the needle may break, resulting in injury.**
- **Be careful when sewing overlapping patterns. The needle may not easily pierce the fabric, causing the needle to break.**

■ Stabilizer material (option)

Attach a stabilizer material for embroidery to the fabric to prevent poor quality embroidery designs.

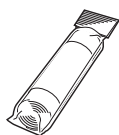

Use a water soluble sheet on thin materials like organdy and fabrics with a nap like towels. For details, refer to "Attaching a stabilizer material to the fabric" (page 144).

■ Embroidery thread (option)

For the upper thread, use the embroidery thread or country thread.

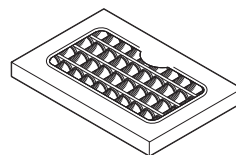

For the bobbin thread, use the embroidery bobbin thread. For details, refer to "Optional accessories" (page 10).



Memo

- For good quality embroidery designs be sure to use embroidery thread designed for embroidery machines.
- Before starting to sew, be sure there is enough bobbin thread. If you continue embroidering when the bobbin thread is low, the thread may become tangled.

■ Needle

Use a 75/11 home sewing machine needle. When embroidering on thick fabrics such as denim, use a 90/14 home sewing machine needle.



Memo

- A 75/11 needle is already installed when the sewing machine is purchased.
- When replacing the needle, refer to "Replacing the needle" (page 41).



CAUTION

- **Since ball point needles (gold colored) are needles for fabrics where stitches are easily skipped, such as pattern stitching and stretch fabrics, be absolutely sure not to use them for embroidery. The needle may break or bend.**

■ Other

Embroidery frames "small" and "large" are optional. For details, refer to "Setting the fabric in the embroidery frame" (page 145).

Embroidery step by step

The basic steps for embroidery are as follows.

1	Presser foot attachment	Attach the embroidery foot "Q". For details on attaching the embroidery foot, refer to "Attaching the embroidery foot" (page 138).
↓		
2	Checking the needle	Use a needle matched to the fabric. For details on replacing the needle, refer to "Replacing the needle" (page 41).
↓		
3	Embroidery unit attachment	Attach the embroidery unit. For details on attaching the embroidery unit, refer to "Attaching the embroidery unit" (page 141).
↓		
4	Bobbin thread setup	For the bobbin thread, wind embroidery bobbin thread and set it in place. For details on setting up the bobbin thread, refer to "Winding/Installing the Bobbin" (page 22).
↓		
5	Fabric preparation	Attach a stabilizer material to the fabric, and hoop it in an embroidery frame. For details on preparing the fabric, refer to "Preparing the Fabric" (page 144).
↓		
6	Embroidery frame attachment	Attach the embroidery frame to the embroidery unit. For details on attaching the embroidery frame, refer to "Attaching the Embroidery Frame" (page 148).
↓		
7	Pattern selection	Turn the power on, and select an embroidery pattern. For details on selecting embroidery patterns, refer to "Selecting Embroidery Patterns" (page 150).
↓		
8	Checking the layout	Check and adjust the size and position of the embroidery. For details on adjusting the layout and the size, refer to "Adjusting the layout and the size" (page 162).
↓		
9	Embroidery thread setup	Set up embroidery thread according to the pattern. For details on setting up the thread, refer to "Upper Threading" (page 31).

Attaching the Embroidery Foot

This section describes how to attach the embroidery foot "Q".

Attaching the embroidery foot

Attach the embroidery foot "Q" when embroidering. Have the included embroidery foot "Q" and a screwdriver ready.

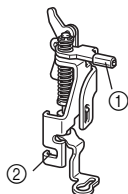

- ① Embroidery foot bar
- ② Caught by the presser foot holder screw

CAUTION

- Always use the embroidery foot "Q" when embroidering. If the wrong presser foot is used, the needle may hit the presser foot and bend or break.

- 1 Press  (Needle position button) once or twice to raise the needle.

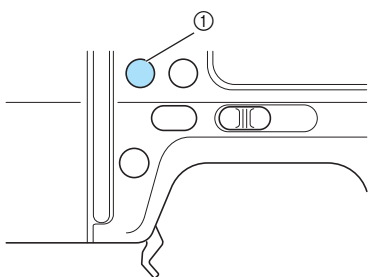

- ① Needle position button



Note

- The needle is correctly raised when the mark on the handwheel is at the top. Check the handwheel mark is at the top position.

- 2 Turn off the sewing machine.

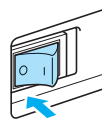

CAUTION

- Before attaching the embroidery foot, be sure to turn off the sewing machine. Otherwise, injuries may occur if one of the operation buttons is accidentally pressed and the machine starts sewing.

- 3 Raise the presser foot lever.

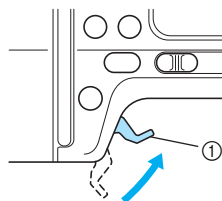

- ① Presser foot lever
- ▶ The presser foot is raised.

- 4 Press and hold the black button on the back of the presser foot holder to detach the presser foot.

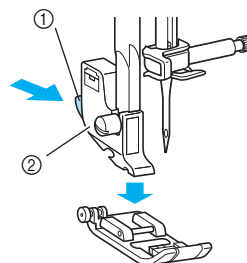

- ① Black button
- ② Presser foot holder
- ▶ The presser foot holder releases the presser foot.

5 Loosen the presser foot holder screw and remove the presser foot holder.

Turn the screwdriver toward the back.

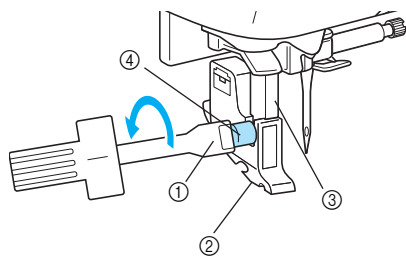

- ① Screwdriver
- ② Presser foot holder
- ③ Presser bar
- ④ Presser foot holder screw

6 Hold the embroidery foot "Q" with your right hand, as shown.

Hold the embroidery foot with your index finger wrapped around the lever at the back of the foot.

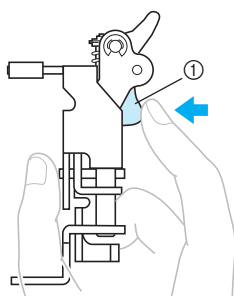

- ① Lever

7 While pressing in the lever with your finger, fit the embroidery foot bar over the needle clamp screw to attach the embroidery foot to the presser foot bar.

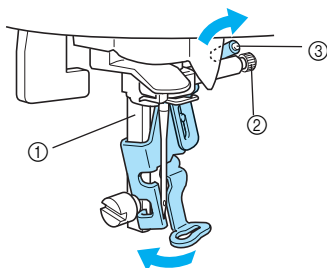

- ① Presser bar
- ② Needle clamp screw
- ③ Embroidery foot bar

8 Secure the embroidery foot with the presser foot holder screw.

Set the embroidery foot perpendicular.

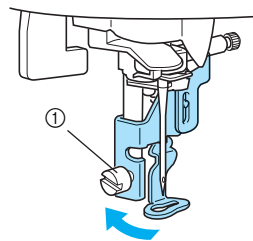

- ① Presser foot holder screw

9 Tighten the presser foot holder screw.

Turn the screwdriver toward the front.

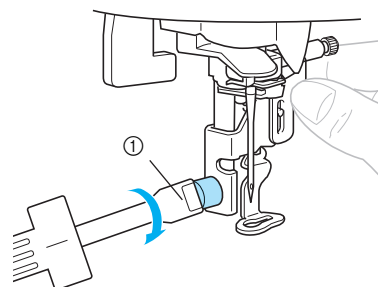

- ① Screwdriver

! CAUTION

- Do not hit the needle with your finger or the embroidery foot "Q" when attaching it. The needle may break or cause injury.
- Be sure to tighten the screw with the included screwdriver. If the screw is loose, the needle may hit the presser foot and break or bend.
- Before sewing, always turn the handwheel toward you (counterclockwise) slowly to make sure that the needle does not hit the presser foot. The needle may break or bend.

Removing the embroidery foot

- 1 Press  (Needle position button) once or twice to raise the needle.

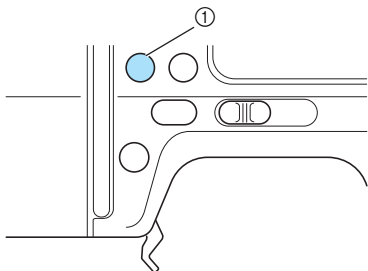

① Needle position button

- 2 Turn off the sewing machine.

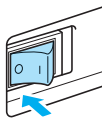

CAUTION

- Before removing the embroidery foot, be sure to turn off the sewing machine. Otherwise, injuries may occur if one of the operation buttons is accidentally pressed and the machine starts sewing.

- 3 Raise the presser foot lever.

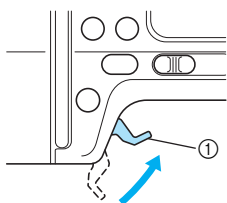

① Presser foot lever

- ▶ The presser foot is raised.

- 4 While pressing in the lever at the back of the embroidery foot with your finger, loosen the presser foot holder screw, and then remove embroidery foot "Q".

Turn the screwdriver toward the back.

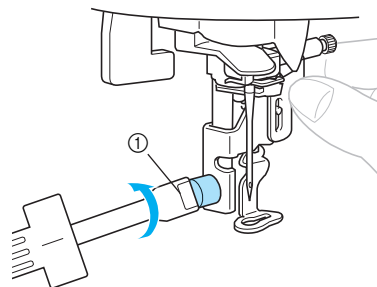

① Screwdriver

- 5 Attach the presser foot holder.

- For details, refer to "Removing and attaching the presser foot holder" (page 45).

Attaching the Embroidery Unit

This section describes how to attach the embroidery unit.

Embroidery unit precautions

CAUTION

- Do not move the sewing machine with the embroidery unit in place. The embroidery unit may be dropped and cause injury.
- Keep your hands and other objects away from the embroidery carriage and frame. Otherwise injury may result.



Note

- Do not touch the connector in the embroidery unit connector slot. The connector could be damaged, and it may cause malfunctions.
- Do not lift up on the embroidery carriage, and do not forcefully move it. It may cause malfunctions.

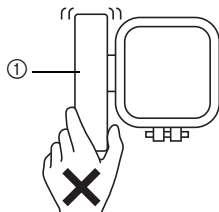

① Carriage

Attaching the embroidery unit

Remove the cover of the embroidery unit and get the embroidery unit ready.

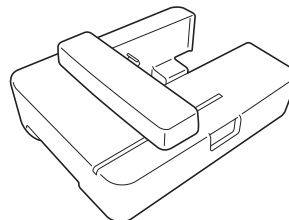

1 Turn off the sewing machine.

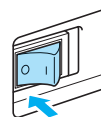

Note

- Always turn off the sewing machine before attaching the embroidery unit. It may cause malfunctions.

2 Pull the flat bed attachment off to the left.

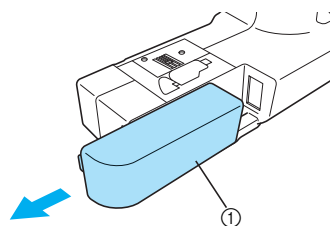

① Flat bed attachment

3 Slide the embroidery unit onto the sewing machine arm.

Push it in until it clicks and stops.

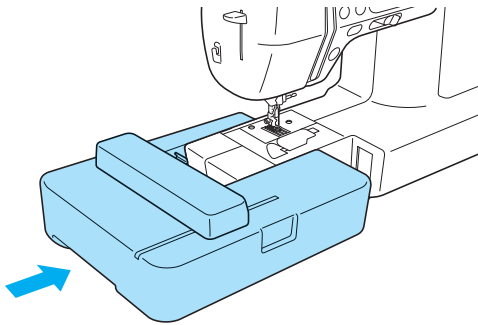

- ▶ The embroidery unit is attached.



Note

- Make sure that there is no gap between the embroidery unit and the sewing machine, otherwise the embroidery pattern may not be sewn correctly.
Be sure to fully insert the connector into the connection port.
- Do not push on the carriage when attaching the embroidery unit to the machine, otherwise damage to the embroidery unit may result.

4 Turn on the sewing machine.

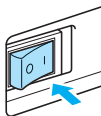

- ▶ The confirmation message is displayed.

5 Be sure that no objects or hands are near the embroidery unit and press **OK**.

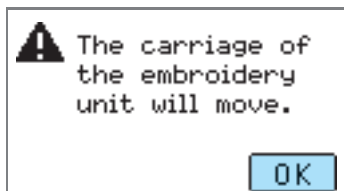

- ▶ The carriage moves to its initial position.

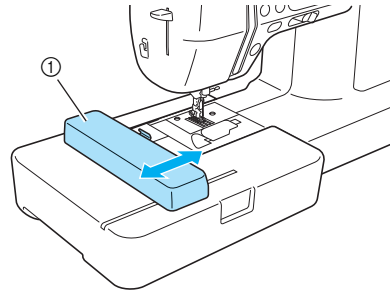

① Carriage



CAUTION

- Do not put your hands or other objects near the carriage. It may cause injury.



Note

- If the machine is initialized with hands or objects near the carriage, the screen may return to the initial display. After removing whatever is near the carriage, turn the power on again.

- ▶ The screen for selecting the embroidery pattern type is displayed.

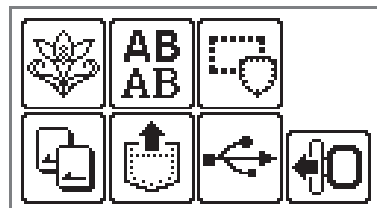

Memo

- Utility stitches cannot be selected when the embroidery unit is attached.
- For details on the embroidery patterns, refer to "Selecting Embroidery Patterns" (page 150).

Removing the embroidery unit

Make sure that the sewing machine is completely stopped and follow the instructions below.

1 Remove the embroidery frame.

- For details on removing the embroidery frame, refer to "Removing the embroidery frame" (page 149).

2 Press , and then press .

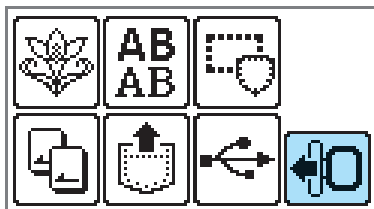

- ▶ The embroidery carriage moves into a position where it can be saved.



Note

- If this step is skipped, the carriage will not move into a correct position; you cannot put the embroidery cover on the embroidery unit.

3 Turn off the sewing machine.

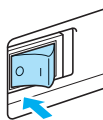

CAUTION

- Always turn off the sewing machine before removing the embroidery unit. It may cause malfunctions if removed when the machine is turned on.

4 Hold the release button on the bottom left of the embroidery unit, and slowly pull the embroidery unit to the left.

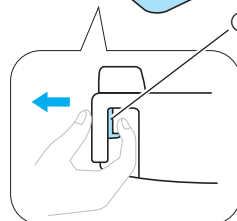
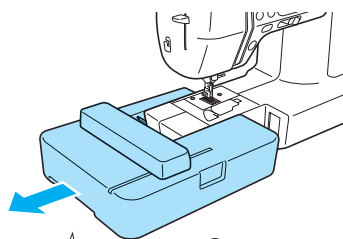

- ① Release button
- ▶ The embroidery unit separates from the sewing machine.



CAUTION

- Do not carry the embroidery unit by holding the carriage. It may cause malfunctions.

Preparing the Fabric

After attaching a stabilizer material to the embroidery fabric, it is stretched on an embroidery frame.

Attaching a stabilizer material to the fabric

Attach a stabilizer material for embroidery to the fabric to prevent poor quality embroidery designs.

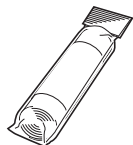

Memo

- We recommend the optional stabilizer material for embroidery. Use a water soluble sheet on thin materials like organdy and fabrics with a nap like towels. To obtain optional accessories or parts, visit [<http://www.brother.com/>], or [<http://www.brothermall.com>] (in USA).



CAUTION

- Always use stabilizer material when sewing embroidery projects. The needle may break or bend if you embroider without using a stabilizer material for thin fabrics or stretch fabrics. Furthermore, the pattern may be sewn incorrectly.

- 1 Prepare stabilizer material that is larger than the embroidery frame being used.

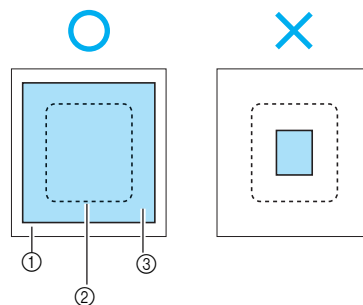

- ① Fabric
- ② Size of embroidery frame
- ③ Stabilizer material

- 2 If you are using stabilizers with adhesive, place the adhesive surface of the stabilizer material against the wrong side of the fabric, and iron it with a steam iron.

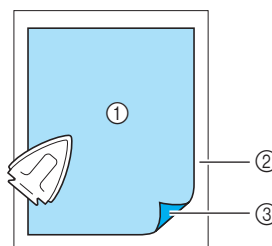

- ① Stabilizer material
- ② Fabric (wrong side)
- ③ Attached surface

- When it cannot be ironed or placed in the hoop

For fabrics, such as towels, which cannot be ironed or for embroidering in places where ironing is difficult, place the stabilizer material under the fabric, and stretch the fabric in the embroidery frame without attaching the stabilizer.

Setting the fabric in the embroidery frame

The fabric is stretched in the embroidery frame. If the fabric is loose, the quality of the embroidery pattern may be poor. Put the fabric in the frame without slack following the steps below. Have a fabric with a stabilizer material attached and the embroidery frame (medium, small or large) ready.

■ Embroidery frame (medium)

Patterns with a height of up to 10 cm (4 inches) and a width of up to 10 cm (4 inches) can be sewn.

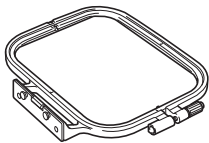

■ Embroidery frame (small) [option]

Patterns with a height of up to 2 cm (1 inch) and a width of up to 6 cm (2-1/2 inches) can be sewn. This is used for letters and other small embroidery.

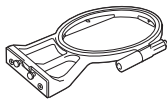

Memo

- There are patterns for which embroidery frame (small) cannot be used.

■ Embroidery frame (large) [option]

Embroidery can be done in an area with a height of up to 17 cm (6-7/10 inch) and a width of up to 10 cm (4 inch). This is used to embroider multiple patterns without changing the fabric position in the frame.

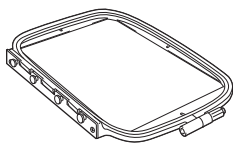

CAUTION

- Use the embroidery frame that matches the size of the pattern being embroidered. Otherwise, the embroidery frame may be hit by the presser foot and cause injury or needle breakage.

- 1 Loosen the embroidery frame adjustment screw and remove the inner and outer frames, placing the outer frame on a flat surface. Separate the inner and outer frame by removing inner frame upward.

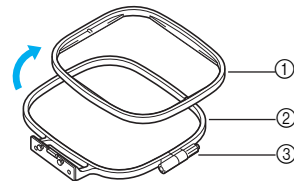

- ① Inner frame
- ② Outer frame
- ③ Adjustment screw

- 2 Place the fabric with the stabilizer material on top of the outer frame. Have the right side of the cloth up.

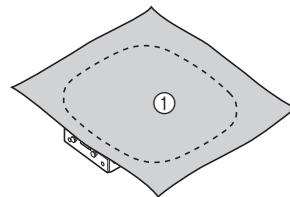

- ① Right side

- 3 Press the inner frame in from the top of the fabric.

Line up \triangle on the inner frame and ∇ on outer frame.

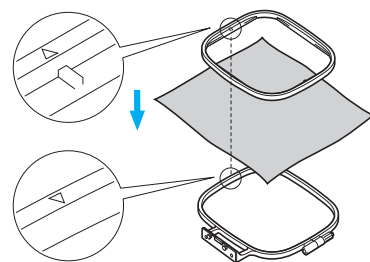

- 4 Tighten the adjustment screw by hand just enough to secure the fabric.

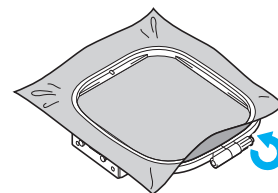

- 5** Gently remove the fabric from the frame without loosening the adjustment screw.

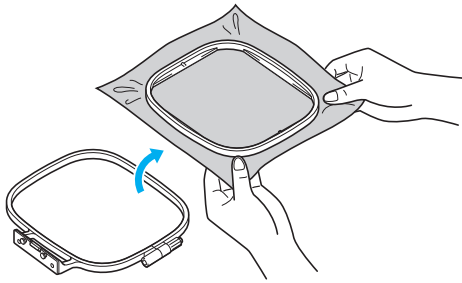

Memo

- This precautionary step will help reduce pattern distortion while embroidering.

- 6** Press the inner frame in from the top of the fabric again, lining up \triangle on the inner frame and ∇ on outer frame.

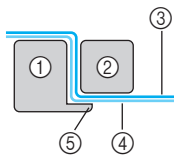
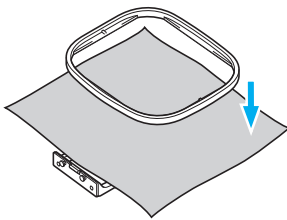

- ① Outer frame
- ② Inner frame
- ③ Fabric (right side)
- ④ Stabilizer material
- ⑤ Ledge of outer frame

- Press down firmly until the inner frame is securely pressed against the ledge of the outer frame.

- 7** Tighten the adjustment screw while removing any slack in the fabric by hand. The goal is to have a drum-like sound when the stretched fabric is struck lightly.

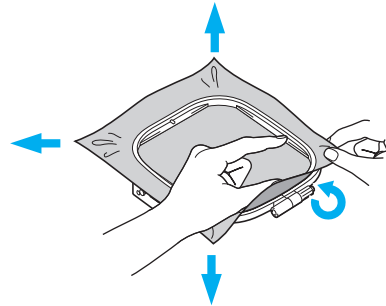

Using embroidery sheets

If the embroidery sheet attached to the embroidery frame is used, the embroidery can be sewn in exactly the right position on the fabric.

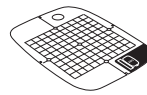

Embroidery sheet (medium)



Embroidery sheet (small) [option]

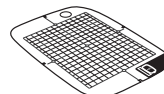

Embroidery sheet (large) [option]

- 1** Make a mark with a chalk pen at the center of the position for the pattern to be embroidered.

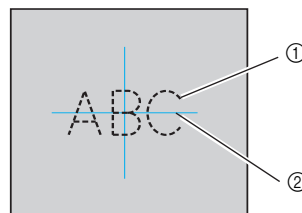

- ① Embroidery pattern
- ② Mark

2 Place the embroidery sheet on the inner frame.

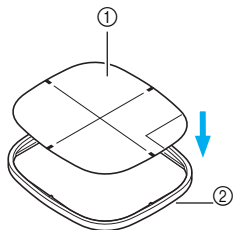

- ① Embroidery sheet
- ② Inner frame

3 Line the mark on the fabric up with the base line on the embroidery sheet.

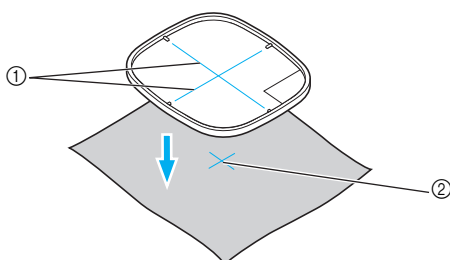

- ① Base line
- ② Mark

4 Place the inner frame with the fabric on the outer frame and stretch the fabric.

- For details, refer to page 145.

5 Remove the embroidery sheet.

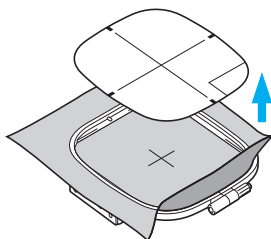

Embroidery on fabrics that cannot be stretched on an embroidery frame

When small pieces of fabric that cannot be stretched on an embroidery frame or thin pieces like ribbon are being embroidered, use stabilizer material as a base to stretch on the frame. We recommend stabilizer material for all embroidery.

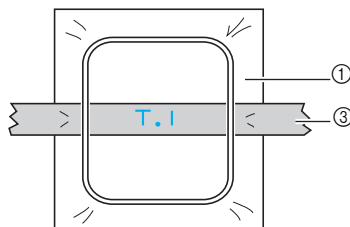
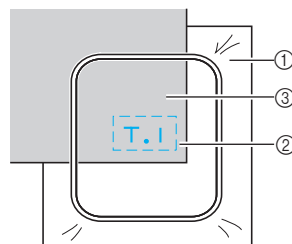
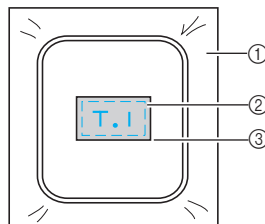

- ① Stabilizer material
- ② Tack or spray glue
- ③ Fabric

After completing the embroidery, remove the stabilizer material carefully.

Attaching the Embroidery Frame

This section describes how to attach the embroidery frame.

Attaching the embroidery frame

- 1 Wind the embroidery bobbin thread onto the bobbin and set it into the bobbin case.
 - For details, refer to "Winding/Installing the Bobbin" (page 22).

- 2 Raise the presser foot lever.
 

① Presser foot lever

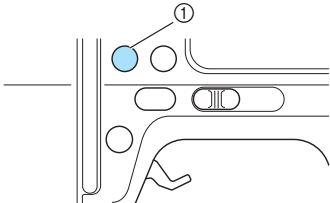
- 3 Press  (Needle position button) once or twice to raise the needle.
 

① Needle position button

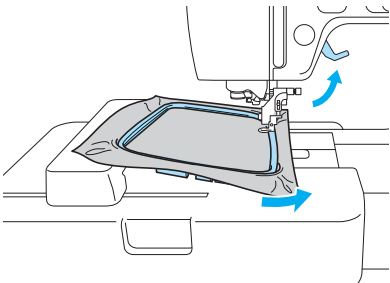
- 4 Pass the embroidery frame under the presser foot while raising the presser foot lever even further.
 

CAUTION

- Do not touch the start/stop button, needle position button or reverse/reinforcement stitch button. If one of the buttons is accidentally pressed, the machine will begin sewing and your finger may be pricked with the needle or the needle may break.

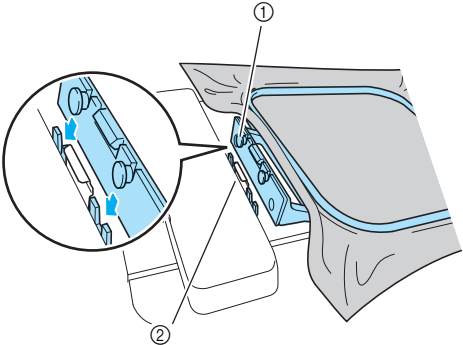
- 5 Firmly insert the embroidery frame guide into the embroidery carriage frame holder from the top.
 

Line up the embroidery frame guide tabs and the embroidery carriage frame holder slots and push in until it clicks and stops.

- ① Embroidery frame guide tabs
- ② Embroidery carriage frame holder slots

► The embroidery unit is attached.

Note

- Be sure to insert both pins. If only the forward or the back pin is inserted, the pattern may not turn out correctly.

CAUTION

- Correctly set the embroidery frame into the embroidery frame holder. Otherwise, the presser foot may hit the embroidery frame, resulting in injury.

Removing the embroidery frame

Make sure that the sewing machine is completely stopped and follow the instructions below.

1 Raise the presser foot lever.

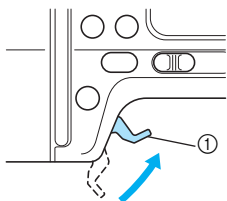

① Presser foot lever

2 Press \oplus (Needle position button) once or twice to raise the needle.

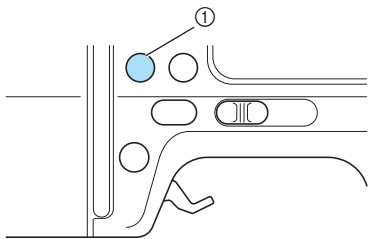

① Needle position button

3 Press the part of the embroidery frame holder in the figure to the left side, and raise the embroidery frame.

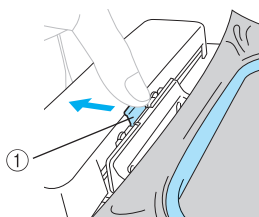

① Press here to remove.

- ▶ The embroidery frame will separate from the embroidery frame holder.

4 Pass the embroidery frame under the presser foot while raising the presser foot lever even further.

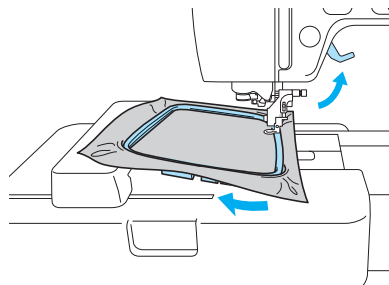

5 Remove the embroidery frame.

! CAUTION

- Do not touch the start/stop button, needle position button or reverse/reinforcement stitch button. If one of the buttons is accidentally pressed, the machine will begin sewing and your finger may be pricked with the needle or the needle may break.

Selecting Embroidery Patterns

This section provides details on the various types of embroidery patterns available and the procedure for selecting a pattern.

Copyright information

The patterns saved in the sewing machine and embroidery cards are intended for private use only. Any public or commercial use of copyrighted patterns is an infringement of copyright law and is strictly prohibited.

Embroidery pattern types

An embroidery pattern can be selected from the following types available.

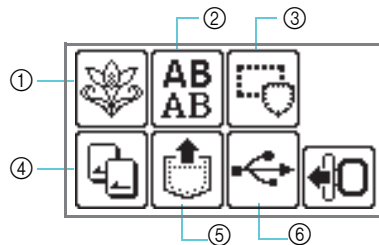

- ① **Embroidery patterns**
There are total 70 patterns. The patterns are completed by changing the upper thread according to the instructions displayed on the screen.
For details, refer to "Selecting an embroidery pattern" (page 155).
- ② **Alphanumeric character patterns**
There are 6 types of characters: upper case/lower case/numbers/symbols/European characters.
For details, refer to "Selecting alphanumeric characters" (page 154).
- ③ **Frame patterns**
10 shapes, such as squares and circles, can be combined with 12 stitch types.
For details, refer to "Selecting a frame pattern" (page 155).
- ④ **Embroidery card**
Press when selecting patterns from an embroidery card.
For details, refer to "Using an embroidery card" (page 156).
- ⑤ **Patterns saved in the machine's memory**
Press when retrieving patterns from the machine's memory.
For details, refer to "Saving patterns" (page 174).
- ⑥ **Patterns retrieved from a USB flash drive (USB flash memory)**
Patterns retrieved from USB media can be embroidered.

Note

- Only a USB flash drive (USB flash memory) can be connected to the USB port on this machine.

For details, refer to "Transferring embroidery patterns from the computer to machine" (page 171).

LCD (liquid crystal display) operation

The LCD (liquid crystal display) is operated using the operation keys on the display panel. The use of the keys for embroidery will be explained below.

■ Operation keys

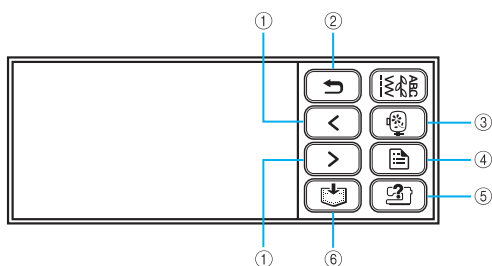

- ① When there are patterns that are not displayed on the screen (when or is displayed), the previous patterns/subsequent patterns are displayed.
- ② Returns to the previous screen.
- ③ Returns to the type selection screen. The selected pattern is cancelled.
- ④ Press this key to adjust language or change the thread color display or other settings.
- ⑤ Press to get help on embroidery unit attachment, embroidery frame attachment, etc.
- ⑥ Press this key to save embroidery patterns and the alphanumeric characters in the machine's memory.

□ Setting the display while embroidering

Press (Settings key) and then (Next page key). Then, select the item by pressing .

NAME OF COLOR: Typical color name

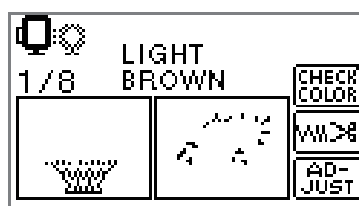
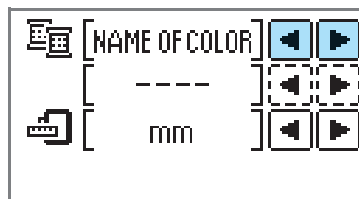

TIME: Time required for embroidering

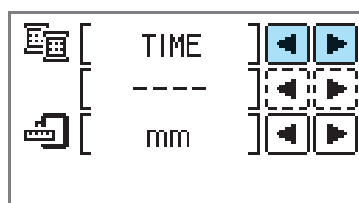

NEEDLE COUNT: Needle progress number

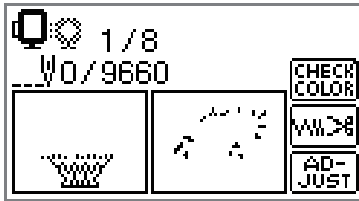
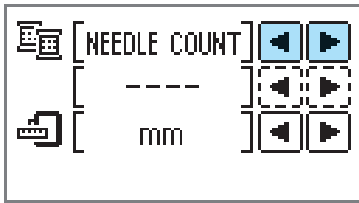

#123: Thread color number

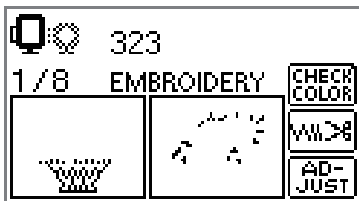
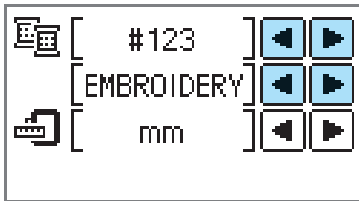

Select from the following thread color number sets (The display above is an example when EMBROIDERY (POLYESTER) THREAD# is selected.)

- EMBROIDERY (POLYESTER) THREAD#
- COUNTRY (COTTON) THREAD#
- MADEIRA POLY THREAD#
- MADEIRA RAYON THREAD#
- SULKY THREAD#
- ROBISON-ANTON POLY THREAD#

DISPLAY UNIT

The measurement units that are displayed can be selected. [mm/inch]

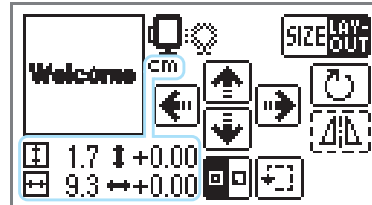
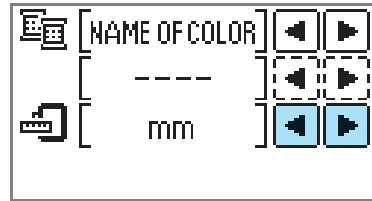

■ LCD button

Example: Selecting alphanumeric characters



CHECK When a specific pattern is selected, press this key and then, press to switch the display. The sewing settings such as the specified alphanumeric character string and color are confirmed.





Press this key to change the thread settings.



Press this key to select or cancel programmed thread cutting.



Press **+** or **-** to change the thread density (characters and frame patterns only).



Press this key to adjust the pattern.

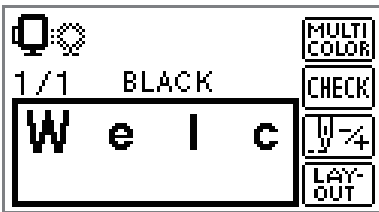

Press this key when you want to change the color, character by character in character embroidery. Since the sewing machine stops at the end of each character, the upper thread is changed as you sew. Press this key again to cancel multi-color.

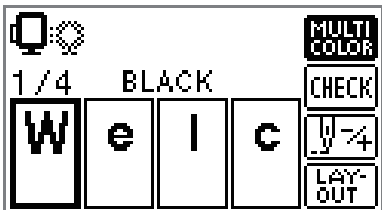

The needle progresses one color or one stitch (if pressed continuously, 9 stitches to 30 stitches) at a time and changes the position for starting the embroidery. This is used when a specific color is not sewn or when restarting the sewing machine after power has been turned off in the middle of the operation.

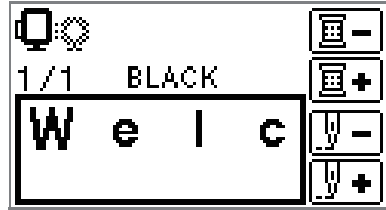

Back one color



Forward one color



Back one stitch



Forward one stitch

- For details, refer to "Resewing" (page 166).



The position of the pattern within the embroidery frame can be checked, and the size and angle can be changed.

For details, refer to "Adjusting the layout and the size" (page 162).

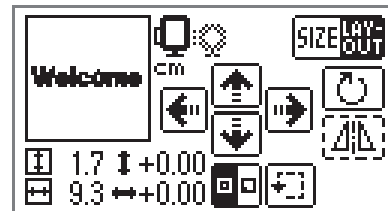

Memo

- Keys that appear surrounded with a dotted line (ex.) cannot be used.

Example: Selecting an embroidery pattern

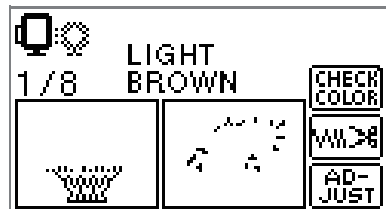

Press this key to check the order of multi color. Press to switch the display.

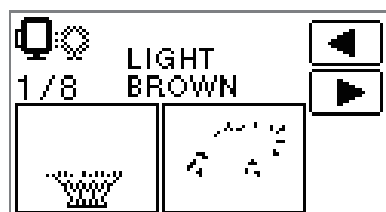

Selecting alphanumeric characters

Specify the characters for embroidery.



Memo

- When "The pattern is too large for the embroidery frame" is displayed, no more characters can be input.
- Characters from different fonts (sans serif and serif, etc.) cannot be combined.

1 Select the alphanumeric characters.

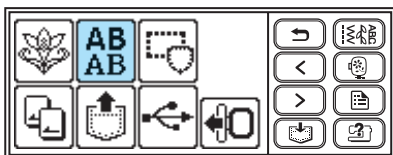

2 Select the font.

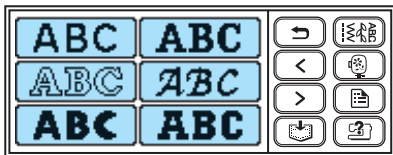

3 Enter the characters.



Memo

- If a character is pressed by mistake, press **DELETE**.
- To enter a space, press " _".

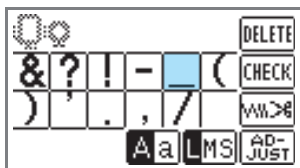

□ Example: Come on

- Aa** Switch between uppercase/ lowercase
- LMS** Switch among large/medium/small sizes

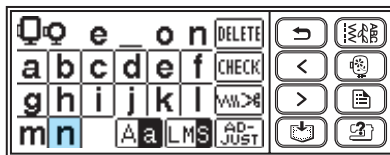
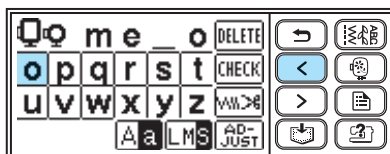
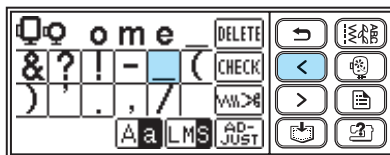
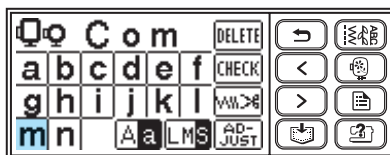
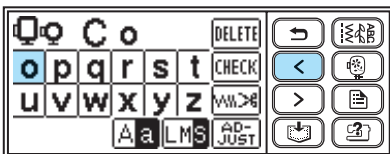
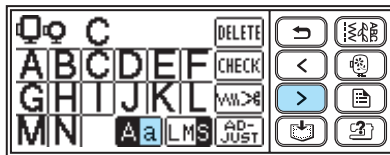
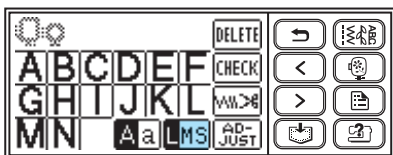

Memo

- The characters you entered can be saved for later use. For details, refer to "Saving patterns" (page 174).

Selecting an embroidery pattern

There are 70 embroidery patterns, such as flowers and animals, saved in the machine's memory.



70 Embroidery patterns



Memo

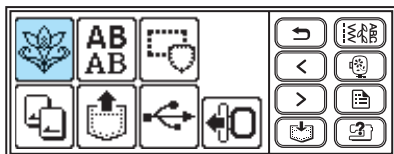

- Refer to "Embroidery Pattern Color Change Table" in the Quick reference guide for samples of completed patterns and the thread used.

1 Press .





▶ The pattern selection screen is displayed.

2 Select the pattern.

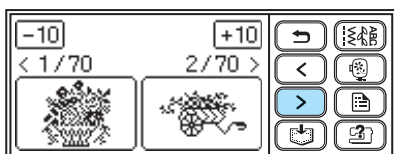
Switch the screen using  (Previous page key) and  (Next page key).



When / is pressed, the display of patterns moves backward/forward 10 patterns.

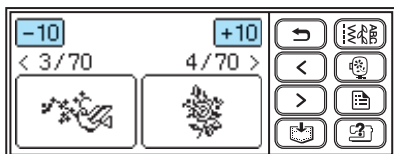

▶ When a pattern is selected, it can be embroidered.

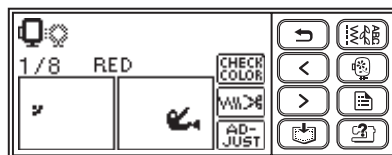

Selecting a frame pattern

10 shapes, such as squares and circles, can be combined with 12 stitch types.



Memo

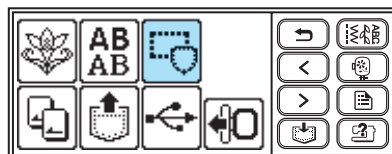

- Refer to "Frame patterns" in the Quick reference guide for frame pattern shapes and stitches.

1 Press .





▶ The frame shape selection screen is displayed.

2 Select the frame shape.

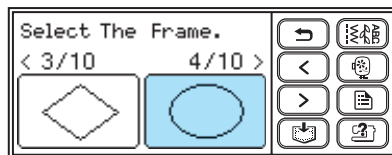
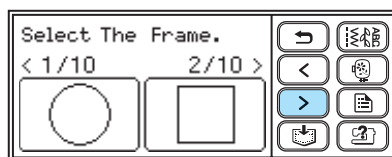
Switch the screen using  (Previous page key) and  (Next page key), and select from the 10 types.



▶ The stitch selection screen is displayed.

- 3 Select the stitch.**
Switch the screen using  (Previous page key) and  (Next page key), and select from the 12 stitches.

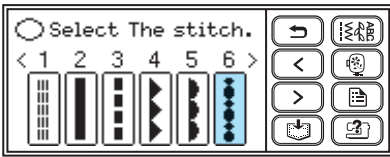

- ▶ When a stitch is selected, it can be embroidered.

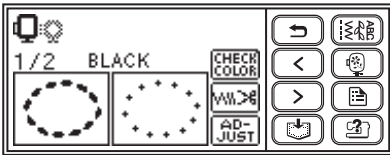

Using an embroidery card

If an embroidery card is used, you can embroider patterns other than the patterns saved in the sewing machine. There are various cards with different themes.



Note

- Always turn off the sewing machine to insert and remove embroidery cards.
- Insert the embroidery card into the embroidery card slot, facing it in the right direction.
- Do not put anything other than an embroidery card in the embroidery card slot.
- When embroidery cards are not in use, keep them in their storage cases.
- Use only embroidery cards manufactured for this machine. Using unauthorized cards may cause your machine to operate incorrectly.
- Embroidery cards purchased in foreign countries may not work with your machine.

- 1 Turn off the sewing machine.**

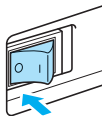

- 2 Insert the embroidery card in the embroidery card slot on the right side of the sewing machine.**

Face the arrow on the embroidery card toward you, and insert it in the direction of the arrow.

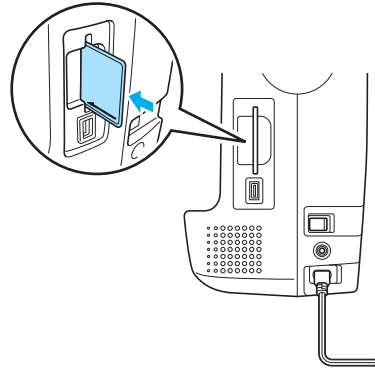

- 3 Turn on the sewing machine.**

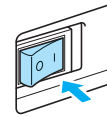

- 4 Press  on the screen.**

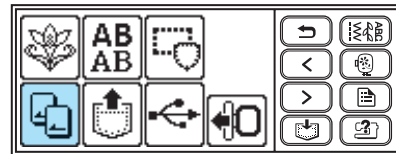

- ▶ This selection screen for the patterns saved in the card is displayed.

- 5 Select a pattern.**
The operation is the same as in "Selecting an embroidery pattern" (page 155).



Embroidering

After the preparations are done, you can try embroidering. This section describes the steps for embroidering and appliquéing.

Checking the pattern before embroidering

The embroidery frame is moved to indicate the embroidering position. Closely watch the frame to check that the pattern will be sewn at the correct place.

- 1 After selecting the embroidery pattern, press



▶ The embroidery screen is displayed.



- 2 Press



▶ The layout screen is displayed.



- 3 Press

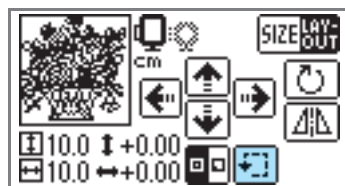

- ▶ The frame moves to indicate the entire embroidering area.

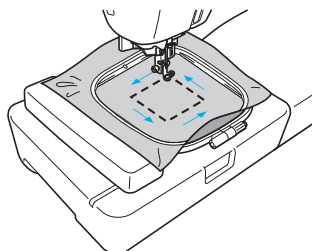

CAUTION

- Make sure the needle is up when the embroidery frame is moving. If the needle is down, it could break and result in injury.

Embroidering a pattern

Embroidery patterns are embroidered with a change of thread after each color.

1 Prepare embroidery thread of the color shown on the screen.

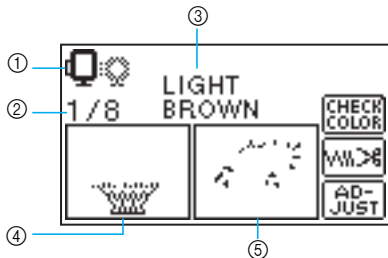

- ① Embroidery frames that can be used for embroidering
 - ② Current color step/Number of colors in design
 - ③ Current name of color
 - ④ Current color part
 - ⑤ Next color part
- The thread color number set displayed for the thread colors can be changed. Press  (Setting key), and then change the setting in the setting screen. For details, refer to "LCD (liquid crystal display) operation" (page 151).

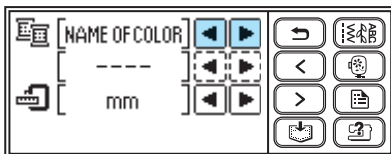

Example: Embroidery thread number selected

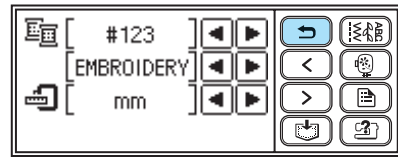

2 Set the embroidery thread, and thread the needle.

- Refer to "Threading the upper thread" (page 32).

Note

- Before using the needle threader, be sure to lower the presser foot.

3 Pass the thread through the embroidery foot hole, and hold it lightly in your left hand.

Give the thread a little slack.

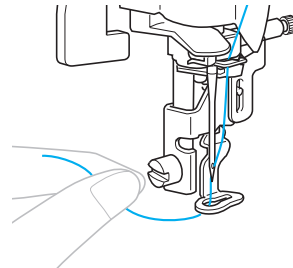

CAUTION

- If the thread is pulled too tight, the needle may break or bend.
- Do not let hands or objects hit the carriage while sewing. The pattern may misalign.

- 4 Lower the presser foot lever.

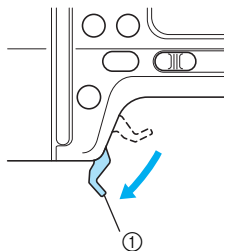

① Presser foot lever

- 5 Press \uparrow (Start/stop button).

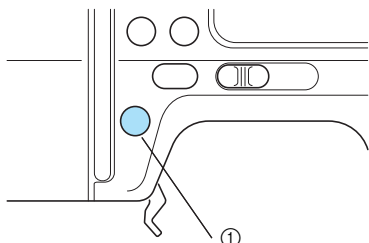

① Start/stop button

CAUTION

- Use the embroidery frame that matches the size of the pattern being embroidered. Otherwise, the embroidery frame may be hit by the presser foot and cause injury or needle breakage.

- 6 After progressing 5-6 stitches, press \uparrow (Start/stop button) to stop the machine.

- 7 Use scissors to cut the thread at the beginning of the stitching.
Cut the thread at the edge of the stitching.

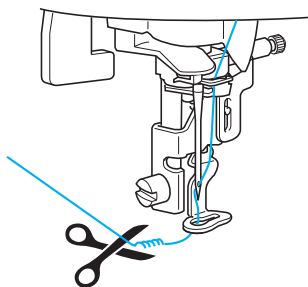

Note

- If the thread is left at the beginning of the stitching, it may be sewn over as you continue embroidering the pattern, making it very difficult to deal with the thread after the pattern is finished. Trim the thread at the beginning.

- 8 Press \uparrow (Start/stop button) again.

- ▶ The embroidery begins again.
- ▶ Stitching stops automatically with reinforcement after one color has been completed. When automatic thread cutting is set, the thread is cut.

- 9 Set up embroidery thread for the next color, and repeat steps 2 through 8.

- ▶ When the last color is sewn, "Finished sewing." will appear on the display. Press \square OK \square , and the display will return to the initial screen.

- 10 Cut the excess thread.



Memo

- For the automatic cutting setting, refer to "LCD (liquid crystal display) operation" (page 153).

Appliquéing

Prepare the base fabric and the appliqué fabric (appliqué piece). Press  (Settings key), and set the thread color display to NAME OF COLOR, so "APPLIQUE MATERIAL", "APPLIQUE POSITION" and "APPLIQUE" are displayed on the screen.

1 Select an appliqué pattern.

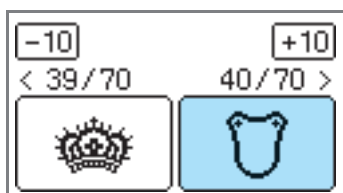

▶ "APPLIQUE MATERIAL" is displayed on the screen.

2 Apply iron-on stabilizer to the back of the appliqué piece fabric, and stretch it on the embroidery frame.

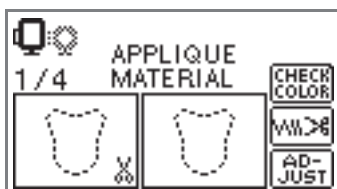

3 Lower the presser foot lever, and press (Start/stop button).

▶ The cut-out for the appliqué piece is sewn, and the sewing machine stops.

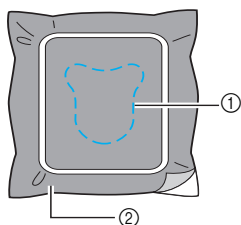

- ① Cut-out line
- ② Appliqué piece fabric

▶ "APPLIQUE POSITION" will be displayed on the screen.

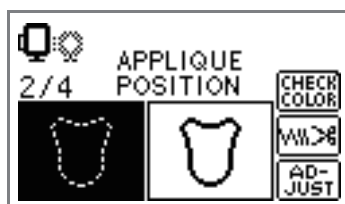

4 Remove the fabric from the embroidery frame, and cut it out along the cut-out line.

Cut carefully along the stitching and remove the thread.

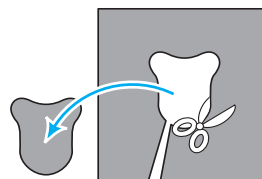

- If it is not cut right on the stitching, it will not be finished neatly.

5 Stretch the base fabric on the embroidery frame.

6 Set up the thread for appliquéing.

7 Lower the presser foot lever, and press (Start/stop button).

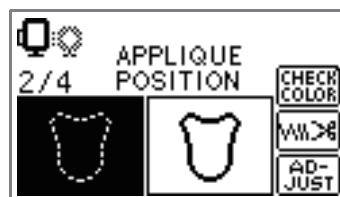

▶ The position for the appliqué is stitched, and the sewing machine stops. "APPLIQUE" will be displayed on the screen.

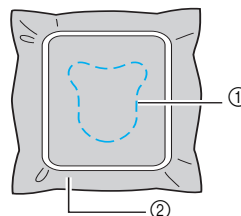

- ① Appliqué position
- ② Base fabric

8 Apply a thin layer of fabric glue or spray adhesive to the back of the appliqué piece, and attach it in the appliqué position.

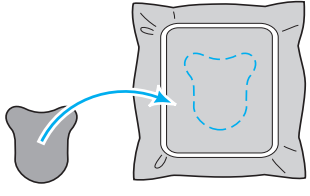

9 Lower the presser foot lever, and press (Start/stop button).

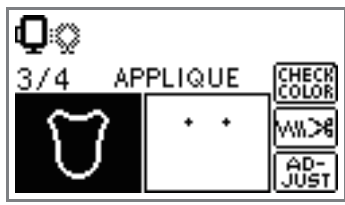

▶ The position for the appliqué is stitched, and the sewing machine stops.

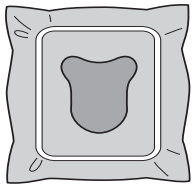

Memo

● When "APPLIQUE MATERIAL", "APPLIQUE POSITION" and "APPLIQUE" are displayed, a specific color thread does not appear. Use a proper color thread to match the appliqué piece.

10 Follow the instructions on the screen, and change thread colors as you sew.

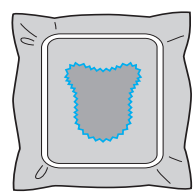
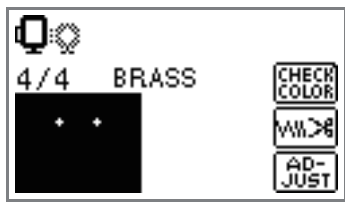

Editing and Saving Patterns

This section describes ways to edit, adjust, reposition and memorize patterns.

Adjusting the layout and the size

The pattern is normally positioned in the center of the embroidery frame. You can check the layout before starting embroidery and change the position and the size.



Memo

- Keys that appear surrounded with a dotted line (ex. ) cannot be used.

1 After selecting the embroidery pattern, press .

- ▶ The embroidery screen is displayed.



2 Press .



- ▶ The layout screen is displayed.

3 Check and adjust the layout.

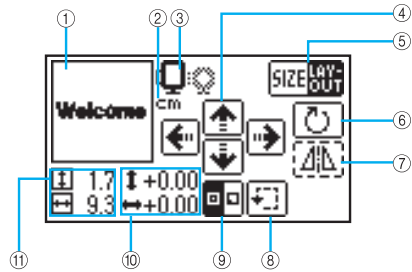

- ① Layout within the frame
- ② Display unit (cm/INCH)
- ③ Available embroidery frames
- ④ Change position keys
- ⑤ Size key/Layout key
- ⑥ Rotation key
- ⑦ Horizontal mirror image key
- ⑧ Trial key
- ⑨ Starting point key
- ⑩ Distance from the center
- ⑪ Embroidery size



Embroidery frame size

The size of embroidery frame that can be used is displayed. When the smaller mark is grayed out in the display, embroidery frame (small) cannot be used. These icons flash if the pattern was resized, the layout was adjusted, or the recommended embroidery frame size was changed.

! CAUTION

- Use the embroidery frame that matches the size of the pattern being embroidered. Otherwise, the presser foot may hit the embroidery frame and cause needle breakage or injury.



Size key

Increases/decreases the size of the pattern. Press to return to the previous screen.

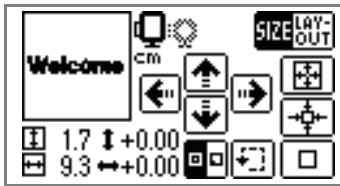

Decreases size



Returns to original size. When the pattern was moved with the change position keys, it returns to its original position.



Increases size



Change position keys

Moves the embroidery position up, down, left and right.



Memo

- If you change the size of the pattern or reverse it, the embroidery which have been moved will return to its initial position. Use the Change position keys after you have changed the size of the pattern or reversed it.
- The embroidery patterns you have edited or adjusted can be saved in the sewing machine's memory. For details, refer to "Saving patterns" (page 174).



Layout key

Press this key to move to rotation screen.

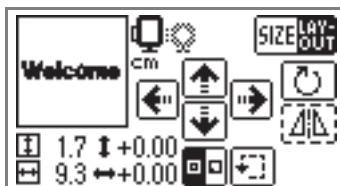

Rotation key

Rotates the pattern 1 degree, 10 degrees or 90 degrees at a time.

Press (Back key) to return to the previous screen.

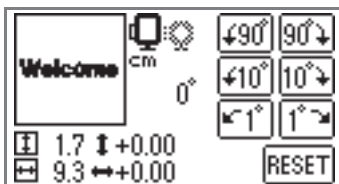

Rotates the pattern 90 degrees to the left



Rotates the pattern 90 degrees to the right



Rotates the pattern 10 degrees to the left



Rotates the pattern 10 degrees to the right



Rotates the pattern 1 degree to the left



Rotates the pattern 1 degree to the right



Returns the pattern to its original position



Memo

- When the pattern is larger than 10cm (4 inches) x 10cm (4 inches), there may be a case that the pattern cannot be rotated.



Horizontal mirror image key

Mirrors the pattern left and right.



Memo

- Mirroring patterns is possible only for a embroidery pattern or a frame pattern.



Starting point stitching key

Switches the stitching starting point between center and lower left of the design.

- Press to return to the previous screen.



Trial key

Moves the frame to check the pattern position.

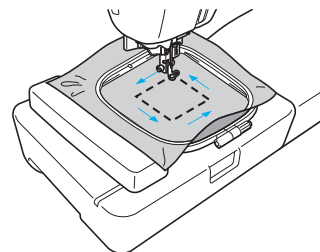

CAUTION

- Never lower the needle when the embroidery frame is moving. The needle may break or bend.
- When you have revised the pattern, check the display of available embroidery frames and use an appropriate frame. If you use an embroidery frame not displayed as available for use, the presser foot may strike the frame and possibly cause injury.

- 4 Press  (Back key) to return to the previous screen.

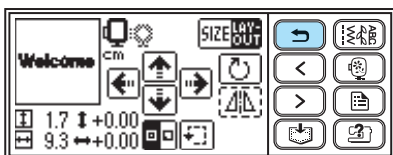

Memo

- When the power is turned off, the layout returns to the original setting.
- You can also check the pattern size and distance from the center by pressing  after beginning embroidering.
- The embroidery patterns you have edited or adjusted can be saved in the sewing machine's memory. For details, refer to "Saving patterns" (page 174).

Adjusting the thread tension

It is very difficult to rip out embroidery designs if the thread tension is incorrect. To prevent damage to the project fabric, it is a good idea to use a scrap of the same fabric to check the adjustment of the thread tension, etc.

The upper thread tension is changed using the thread tension dial.

When doing machine embroidery, the tension dial should be set somewhere between 2 to 6.

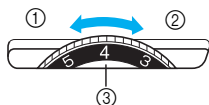

- ① Loose (Decrease thread tension)
- ② Tight (Increase thread tension)
- ③ Upper thread tension dial



Memo

- If the stitches appear loose, turn the tension up one notch and resew.

Correct thread tension

The thread tension is correct when upper thread is just visible on back of the fabric.



- ① Right side of fabric
- ② Wrong side of fabric

Upper thread is too tight

The lower thread will be visible on the front of the fabric. In this instance, decrease the upper thread tension.



- ① Right side of fabric
- ② Wrong side of fabric

Upper thread is too loose

The upper thread has slack. In this instance, increase the upper thread tension.



- ① Right side of fabric
- ② Wrong side of fabric



Note

- If the upper thread is not threaded correctly or the bobbin is not installed correctly, it may not be possible to set the correct thread tension. If the correct thread tension cannot be achieved, rethread the upper thread and insert the bobbin correctly.
- If the tension dial is set extremely low, the machine may stop stitching during sewing. This is not a sign that anything's broken. Simply increase the tension slightly to continue sewing.



Connecting character patterns

If the character pattern is too long to fit in the embroidery frame, follow the steps below.

Example: Connecting "ABC" with "DEF"

1 Enter "ABC" and press .



2 Press  to turn off the automatic thread cutting ().



3 Press  (Back key).



4 Press .



5 Press .

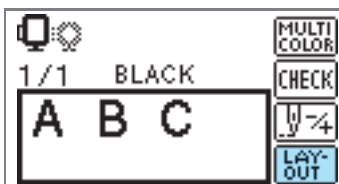

6 Press  to turn it to .

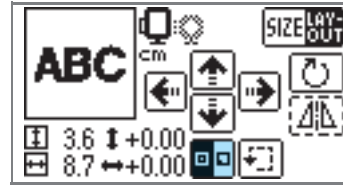

▶ The stitching starting point is set to lower left of the design.

7 Lower the presser foot, and then press  (Start/stop switch) to begin sewing.

8 When embroidering is finished, trim the thread leaving the end of the thread longer than usual. Then reset the fabric in the embroidery frame, in a position where you can sew "DEF".

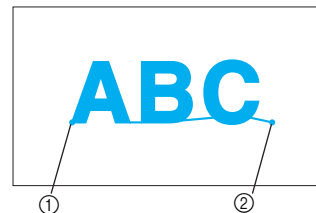

① Embroidery start position
② Embroidery end position

9 Enter "DEF" and press .



10 Press .



11 Press  to turn it to .

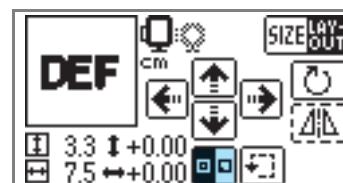

▶ The stitching starting point is set to lower left of the design.

- 12 Use  (change position keys) to move the needle to the embroidery end position of "ABC".

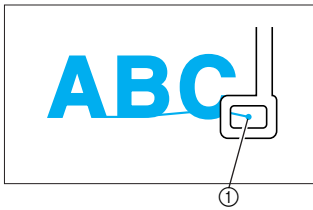

① Embroidery end position

- 13 Lower the presser foot, and then press  (Start/Stop button) to embroider "DEF".



- 14 When you have finished embroidering, cut the thread.

Resewing

When the wrong upper thread color has been sewn, it can be re sewn with the correct color.

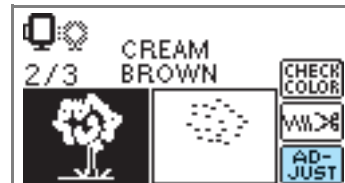

- 1 Press  (Start/stop button) to stop the sewing machine.

- 2 Press  .

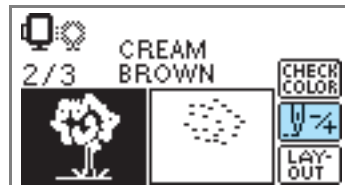

- 3 Press  .



- 4 Press  (Back one color) to return to the beginning of the mistaken color. Press  one more time to go to previous color.



- 5 Set up the correct color for the upper thread.

- 6 Press  (Start/stop button) to continue the design.

Thread runs out partway through a design

When the upper thread or the bobbin thread runs out while sewing, the sewing machine stops. Move the needle back about 10 stitches and resume sewing.



Memo

- When the bobbin thread runs out, cut the threads and remove the embroidery frame before replacing the bobbin thread.

1 Set the upper thread or bobbin thread.

- 2 Press .



Memo

- If the needle count is not displayed, display the needle count on the screen. For details, refer to "Stopping while embroidering" (page 167).

- 3 Press .



- 4 Press (Back one stitch) to move the needle back about 10 stitches.

(Forward one stitch) increases the stitch number.



- 5 Restart the embroidery.



Stopping while embroidering

If the embroidery is stopped before it is complete, check the current needle count and layout before turning off the sewing machine.



Memo

- When the sewing machine is turned off, the embroidery size and layout return to the original setting. If you have changed the layout, you need to adjust it again.

- 1 Press (Start/stop button) to stop the sewing machine.

- 2 Check the current needle count on the screen and make a note of it.



If the needle count is not displayed, press (Settings key), and then use to display the following screen.

Press to return to the previous screen.

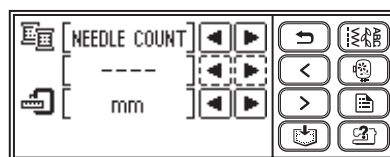

- 3 Press (Embroidery key).

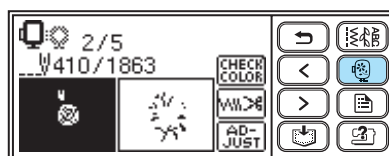

▶ The confirmation message is displayed.

4 Press **OK**.



▶ The selected pattern is turned off, and it returns to the initial embroidery screen.

5 Turn off the sewing machine.

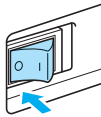

Note

- Always detach the embroidery unit when you move the sewing machine.

6 Turn on the sewing machine, and then select the pattern.



Memo

- If you have changed the embroidery size and/or layout before turning off the machine, make the same setting changes again before restarting embroidering. For details, refer to "Adjusting the layout and the size" (page 162).

7 Press **AD-JUST**.



8 Press **1/4**.

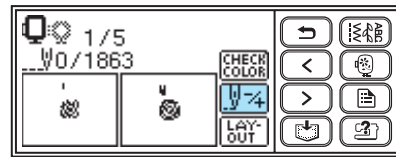

9 Press **+** (Forward one color) to move to the beginning of the color you want to embroider.



10 Press **+** (Forward one stitch) to increase the needle count.

If **+** is pressed continuously, it moves forward 1 → 9 → 30 stitches.



Move forward to about 10 stitches before the total number of stitches confirmed in **e**.



11 Restart the embroidery.

Using the Memory Function

Embroidery data precautions

Observe the following precautions when using embroidery data other than that created and saved in this machine.

CAUTION

- **When using embroidery data other than our original patterns, the thread or needle may break when sewing with a stitch density that is too fine or when sewing three or more overlapping stitches. In that case, use one of our embroidery software programs to edit the embroidery data.**

■ Types of Embroidery Data That Can Be Used

- Only .pes and .dst embroidery data files can be used with this machine. Using data other than that saved using one of our embroidery software programs or sewing machines may cause the embroidery machine to malfunction.

■ Types of USB Media That Can Be Used

Embroidery data can be retrieved from a USB flash drive (USB flash memory) of any size.



Note

- Only a USB flash drive (USB flash memory) can be connected to the USB port on this machine.
- Some USB media may not be compatible with this machine. Visit our website for more details.
- When using USB media equipped with an access indicator, the access indicator will begin flashing after the media is inserted into your computer or machine, and may take about 5 to 6 seconds before the media is recognized. (The length of time differs depending on the USB media.)
- For additional information, refer to the instruction manual included with the USB media that you have purchased.



Memo

- Letters and numerals can be used in folder names and file names. In addition, if the folder or file name contains no more than eight characters, the entire name will appear on the screen. If the name is more than eight characters long, only the first six characters followed by “~” and a number appear as the name.
This applies to folders and .dst embroidery data files only.

■ Precautions on Using the Computer To Create and Save Data

- If a folder or file name for embroidery data cannot be identified, for example, because the name contains special characters, the folder or file will not be displayed. If this occurs, change its name. We recommend using the 26 letters of the alphabet (uppercase and lowercase), the numbers 0 through 9, “-”, and “_”.
- .pes files saved with the number of stitches, the number of colors and the number of combined patterns exceeding the specified limits cannot be displayed. Use one of our embroidery software programs to edit the embroidery pattern so that it meets the required specifications.
- Even if the embroidery unit is not attached, the machine will recognize embroidery data.

- Save embroidery data files in the root directory or folders on the root directory of the USB media. If an embroidery data file is saved in a folder on a sub-directory, that file cannot be retrieved by the machine. Save embroidery data files in the USB media as in the diagram below.

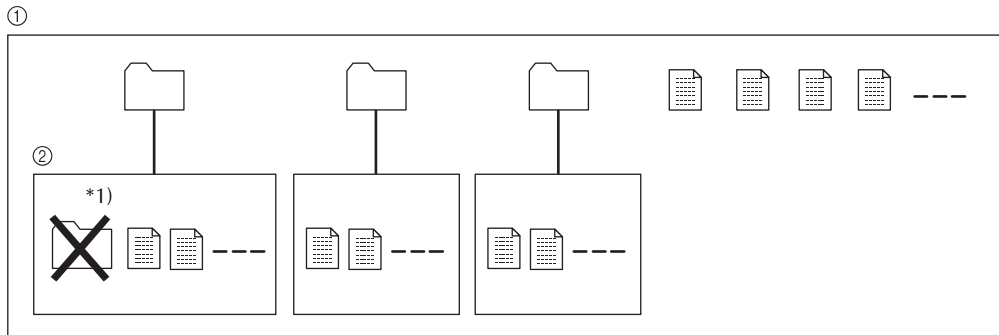

- ① Root directory of the USB media
 ② Sub-directory

 : Folder

 : Embroidery data file

*1) Do not create a folder on a sub-directory.

- The maximum total number of embroidery data files and folders you can save in a USB media is 200. (For example, you can save 5 folders and 195 embroidery data files in a USB media.) If you save more than 200 files including folders, embroidery patterns cannot be transferred to the machine because the machine cannot recognize the contents of the USB media. In this case, reduce the number of files (including folders) saved in the USB media.
- In addition, if the embroidery designs contain too many colors (this number may vary within the designs themselves), it may not be possible to transfer an embroidery pattern to the machine, even if there are less than 200 files (including folders) in the USB media. If this occurs, you will also need to reduce the number of files (including folders) in the USB media.

■ Tajima (.dst) Embroidery Data

- When a .dst file is imported, the only way that you can view the design is by selecting the pattern (file name). Then press  to display the design on the screen.

Transferring embroidery patterns from the computer to machine

Embroidery patterns can be transferred from a computer to the machine by using a USB media. Follow the procedure below.

- 1 Prepare embroidery data on the computer by observing the precautions of "Embroidery data precautions" (page 169 to 170).



Note

- Be sure to read the all precautions of "Embroidery data precautions" (page 169 to 170) and observe them. Otherwise, the pattern files may not be retrieved into the machine correctly.

- 2 Insert the USB media into the USB port on the computer.

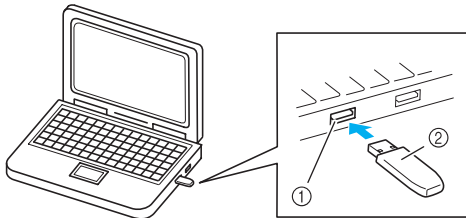

- ① USB port on the computer
- ② USB media

- 3 The "Removable Disk" icon appears in "Computer (My computer)" on the computer.

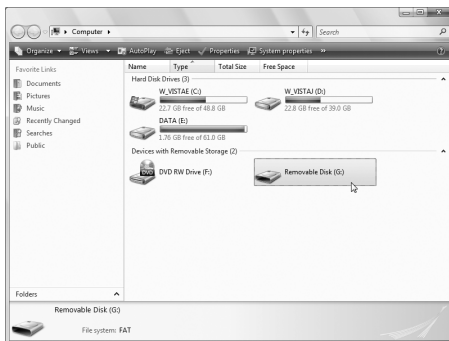

- 4 Copy the embroidery data (folders and/or pattern files).

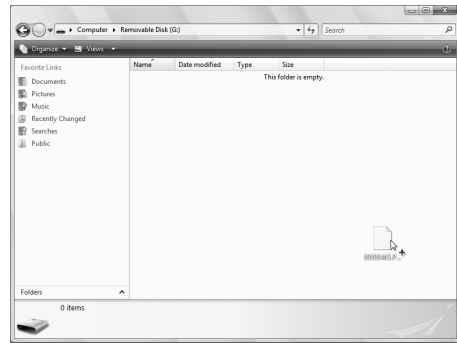

- 5 Safely remove the USB media from the USB port on the computer. (Refer to "Caution" below.)

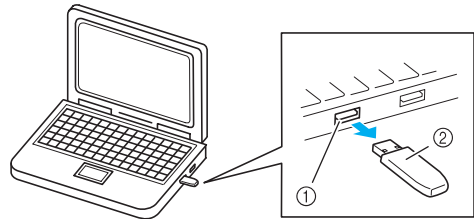

- ① USB port on the computer
- ② USB media

CAUTION

- Before disconnecting the USB media, click the "Safely Remove Hardware" icon in the taskbar of Windows® XP/Windows Vista®/Windows® 7/Windows® 8. Then, when the removable disk can safely be removed, disconnect the USB media from the computer.

In case of Windows Vista®



6 Insert the USB media into the USB port on the machine.

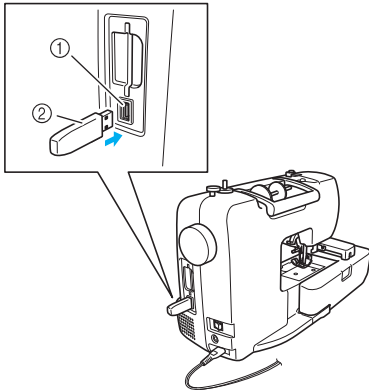

- ① USB port
(for a USB flash drive (USB flash memory))
- ② USB media

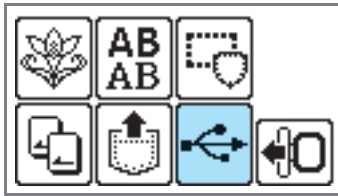

7 Press .



- ▶ Folders and/or pattern files in the root directory of the USB media are displayed.



Memo

- Names of folders are displayed first in the shape of  in the alphabetical order, then .pes files and then .dst files are displayed in the shape of  in the alphabetical order.



- .pes files are displayed in thumbnail-size image, and .dst files are displayed by its name, file format and file size.



Note



- If the message "Reduce the number of patterns." appears, the USB media may contain either more than 200 patterns (including folders) or the embroidery designs may contain too many colors (although there may be no more than 200 patterns). In this case, unplug the USB media from the machine, plug it back into the computer, and then delete a few patterns at a time from the USB media. Close the error message on the machine, and then repeat procedures starting from step 6.

8 Select the desired folder or the pattern you wish to retrieve.

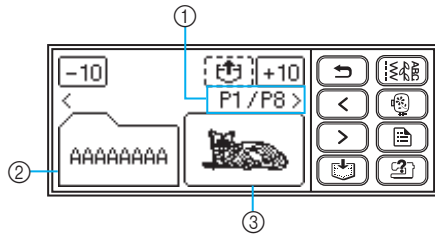
Switch screens using  (Previous page key) and  (Next page key).



- ① Number of the currently displayed page from the total number of pages
- ② Folder (folder name)
- ③ Pattern file (thumbnail-size image or file name)

• When  /  is pressed, the display of folders and/or patterns moves forward or backward in increments of 10.

■ When you have selected a folder

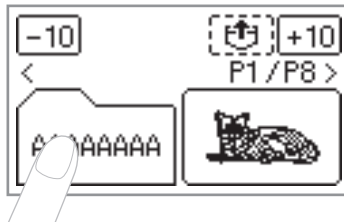

- ▶ Pattern files in the folder are displayed. Go to step 9.

■ When you have selected a pattern

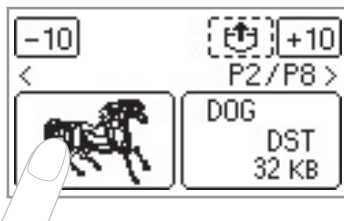

- ▶ The pattern is shown in reverse highlighting. Skip to step 10.

9 Select the pattern you wish to retrieve.

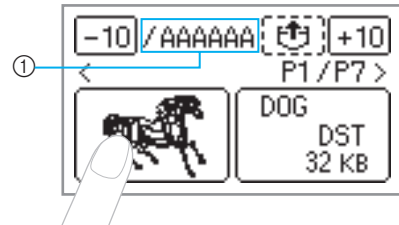

- ① Folder name (Displayed in up to 6 characters only when a folder is selected.)

• To return to the root directory, press .

10 Press



*1) The display of this part differs depending on the operation in step 8.

- ▶ The saved pattern is retrieved.
- ▶ The embroidery screen appears, and you can embroider the retrieved pattern.

11 Adjust the pattern as desired, and then begin embroidering.

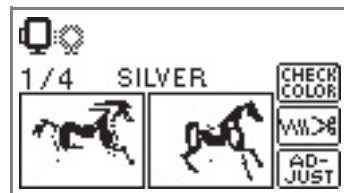

Saving patterns

The embroidery patterns and the alphanumeric characters you have customized can be saved in the sewing machine's memory.

Since the saved patterns will not be erased when the power is turned off, you can always retrieve them for embroidery. This is convenient for saving names and the like. You can save up to 12 patterns or 512KB of data.

■ Saving a pattern

- ① After selecting the pattern to be saved, press  (Memory key).



- ▶ "Saving..." appears while the pattern is being saved. After the pattern is saved, the initial screen appears again.



Note



- Do not turn off the sewing machine while the pattern is being saved, otherwise the pattern data may be lost.

■ Retrieving a pattern

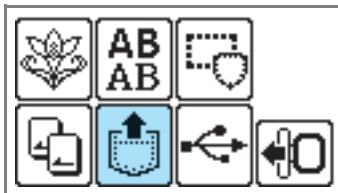
- ① Press  (Retrieve key).



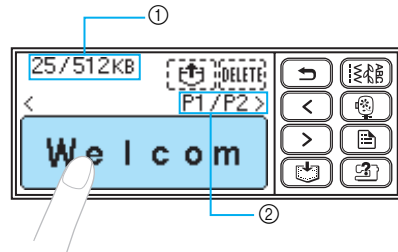

- ▶ The saved patterns are displayed.

- ② Select the pattern you wish to retrieve.
Switch screens using  (Previous page key) and  (Next page key).



- ① Total amount of memory used/Total amount of memory space
② Number of the currently displayed page from the total number of pages

- ▶ The selected pattern is shown in reverse highlighting.

- ③ Press .
To delete the saved pattern, press .



- ▶ The saved pattern is retrieved.
▶ The sewing screen appears, and you can embroider the retrieved pattern.





APPENDIX

The various maintenance and troubleshooting procedures are described in this chapter.

Care and Maintenance	176
Troubleshooting	178
Upgrading Your Machine's Software Using USB Media	198
Index.....	199

Care and Maintenance

Simple sewing machine maintenance operations are described below.

Restrictions on oiling

In order to prevent damaging this machine, it must not be oiled by the user.

This machine was manufactured with the necessary amount of oil applied to ensure correct operation, making periodic oiling unnecessary.

If problems occur, such as difficulty turning the handwheel or an unusual noise, immediately stop using the machine, and contact your authorized dealer or the nearest authorized service center.

Cleaning the machine surface

If the surface of the machine is dirty, lightly soak a cloth in neutral detergent, squeeze it out firmly, and then wipe the surface of the machine. After cleaning it once with a damp cloth, wipe it again with a dry cloth.

CAUTION

- **Unplug the power supply cord before cleaning the machine. Otherwise, injuries or an electric shock may occur.**

Precautions on storing the machine

Do not store the machine in any of the locations described below, otherwise damage to the machine may result, for example, rust caused by condensation.

- Exposed to extremely high temperatures
- Exposed to extremely low temperatures
- Exposed to extreme temperature changes
- Exposed to high humidity or steam
- Near a flame, heater or air conditioner
- Outdoor or exposed to direct sunlight
- Exposed to extremely dusty or oily environments



Note

- In order to extend the life of this machine, periodically turn it on and use it. Storing this machine for an extended period of time without using it may reduce its efficiency.

Cleaning the race

Sewing performance will suffer if dust collects in the bobbin case. Therefore, it should be cleaned periodically.

- 1 Turn off the sewing machine.

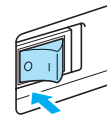

- 2 Unplug the power supply cord from the power supply jack on the right side of the sewing machine.

CAUTION

- **Unplug the power supply cord before cleaning the machine. Otherwise, injuries or an electric shock may occur.**

- 3 Remove the flat bed attachment or the embroidery unit if either is attached.

- 4 Loosen the presser foot holder screw and remove the presser foot holder (page 45), and then loosen the needle clamp screw and remove the needle (page 41).

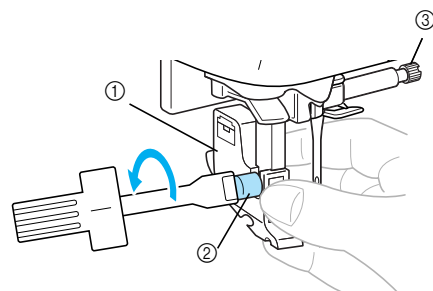

- ① Presser foot holder
- ② Presser foot holder screw
- ③ Needle clamp screw

- 5** Grasp both sides of the needle plate cover, and then slide it toward you.

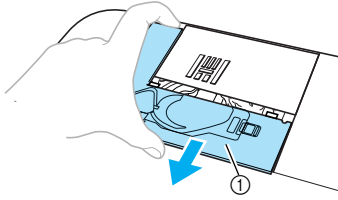

① Needle plate cover

▶ The needle plate cover is removed.

- 6** Remove the bobbin case. Grasp the bobbin case, and then pull it out.

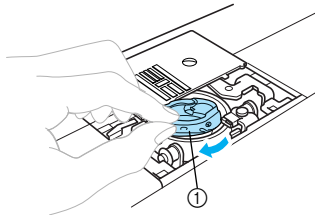

① Bobbin case

- 7** Use the cleaning brush or a vacuum cleaner to remove any lint and dust from the race and bobbin thread sensor and their surrounding area.

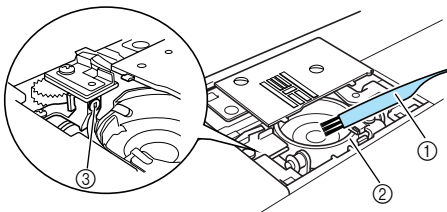

① Cleaning brush

② Race

③ Bobbin thread sensor



Note

- Do not apply oil to the bobbin case.
- If lint or dust collects on the bobbin thread sensor, the sensor may not operate correctly.

- 8** Insert the bobbin case so that the Δ mark on the bobbin case aligns with the \circ mark on the race.

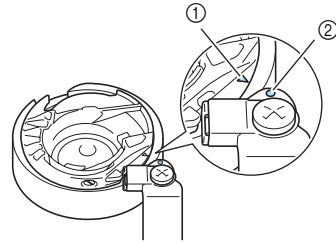
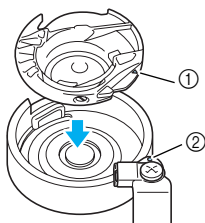

- Align the Δ and \circ marks.

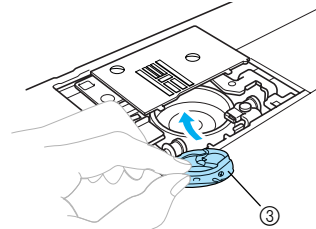

① Δ mark

② \circ mark

③ Bobbin case

- Make sure that the indicated points are aligned before installing the bobbin case.

- 9** Insert the tabs on the needle plate cover into the needle plate, and then slide the cover back on.

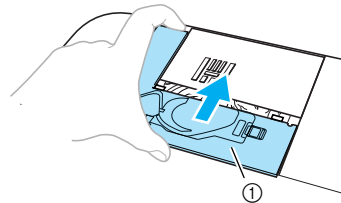

① Needle plate cover

CAUTION

- Never use a bobbin case that is scratched. Otherwise, the upper thread may become tangled, the needle may break or sewing performance may suffer. For a new bobbin case (part code: XE7560-001 (green marking)), contact your nearest authorized service center.
- Be sure that the bobbin case is correctly installed, otherwise the needle may break.

Troubleshooting

If the machine stops operating correctly, check the following possible problems before requesting service. You can solve most problems by yourself. If you need additional help, the Brother Solutions Center offers the latest FAQs and troubleshooting tips. Visit us at “ <http://solutions.brother.com> “. If the problem persists, contact your dealer or the nearest authorized service center.

Frequent troubleshooting topics

Detailed causes and remedies for common troubleshooting topics are described below. Be sure to refer to this before contacting us.

■ Upper thread tightened up	page 178
■ Tangled thread on wrong side of fabric	page 179
■ Incorrect thread tension	page 182
■ Fabric is caught in the machine and cannot be removed	page 183
■ When the thread became tangled under the bobbin winder seat	page 186

Upper thread tightened up

■ Symptom

- The upper thread appears as a single continuous line.
- The lower thread is visible from the upper side of the fabric. (Refer to the illustration below.)
- The upper thread has tightened up, and comes out when pulled.
- The upper thread has tightened up, and wrinkles appear in the fabric.
- The upper thread tension is tight, and the results do not change even after the thread tension is adjusted.

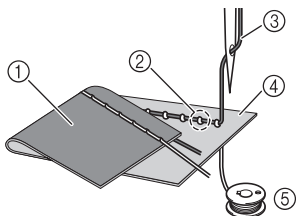

- ① Lower side of fabric
- ② Lower thread visible from upper side of fabric
- ③ Upper thread
- ④ Upper side of fabric
- ⑤ Lower thread

■ Cause

Incorrect lower threading

If the lower thread is incorrectly threaded, instead of the appropriate tension being applied to the lower thread, it is pulled through the fabric when the upper thread is pulled up. For this reason, the thread is visible from the upper side of the fabric.

■ Remedy/check details

Correctly install the lower thread.

- 1 Turn off the sewing machine.
- 2 Remove the bobbin from the bobbin case.
- 3 Place the bobbin in the bobbin case so that the thread unwinds in the correct direction.

- Hold the bobbin with your right hand with the thread unwinding to the left, and hold the end of the thread with your left hand. Then, with your right hand, place the bobbin in the bobbin case.

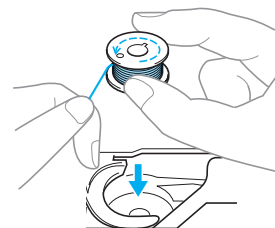

If the bobbin is inserted with the thread unwinding in the wrong direction, sewing will be done with an incorrect thread tension.

4 While holding the bobbin in place with your finger, pass the thread through the slit in the needle plate.

- Hold down the bobbin with your right hand, and then pull the end of the thread around the tab with your left hand.

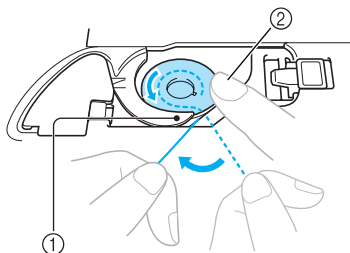

- ① Tab
- ② Hold down the bobbin with your right hand.

Pull the thread to pass it through the slit in the needle plate, then cut it with the cutter.

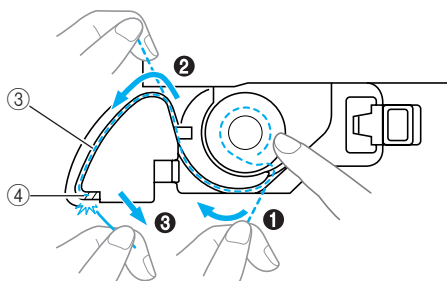

- ③ Slit
- ④ Cutter

Sewing with the correct thread tension is possible after the bobbin has been correctly installed in the bobbin case.

Tangled thread on wrong side of fabric

■ Symptom

- The thread becomes tangled on the lower side of the fabric.

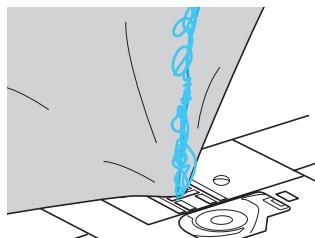

- After starting sewing, a rattling noise is made and sewing cannot continue.
- Looking under the fabric, there is tangled thread in the bobbin case.

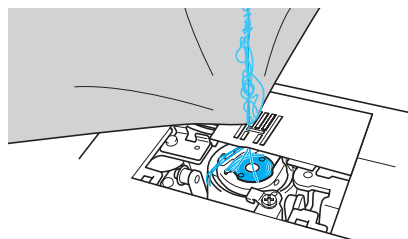

■ Cause

Incorrect upper threading

If the upper thread is incorrectly threaded, the upper thread passed through the fabric cannot be firmly pulled up and the upper thread becomes firmly pulled up and the upper thread becomes tangled in the bobbin case, causing a rattling noise.

■ Remedy/check details

Remove the tangled thread, and then correct the upper threading.

1 Remove the tangled thread. If it cannot be removed, cut the thread with scissors.

- For details, refer to "Cleaning the race" on page 176.

2 Remove the upper thread from the machine.

3 Refer to the following steps to correct the upper threading.

- If the bobbin was removed from the bobbin case, refer to "Installing the bobbin" (page 27) and "Remedy/check details" in the section "Upper thread tightened up" (page 178) to correctly install the bobbin.

- 4** Raise the presser foot using the presser foot lever.

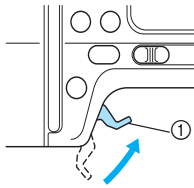

① Presser foot lever

- If the presser foot is not raised, the sewing machine cannot be threaded correctly.

- 5** Press  (Needle position button) once or twice to raise the needle.

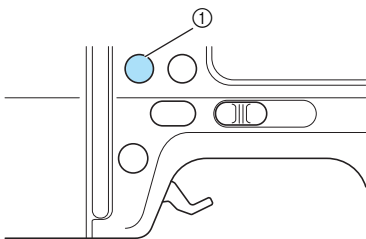

① Needle position button

- ▶ The needle is correctly raised when the mark on the handwheel is at the top, as shown below. Check the handwheel and, if this mark is not at this position, press  (“Needle Position” button) until it is.

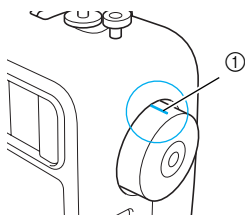

① Mark on handwheel

- 6** Pass the thread behind the thread guide cover and to the front.

While holding the thread near the spool with your right hand, pull the thread with your left hand as shown below.

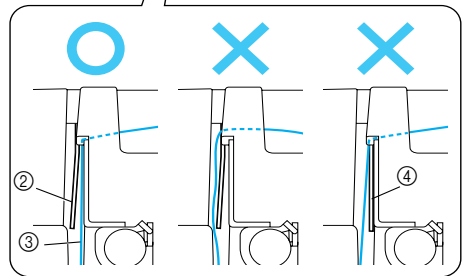
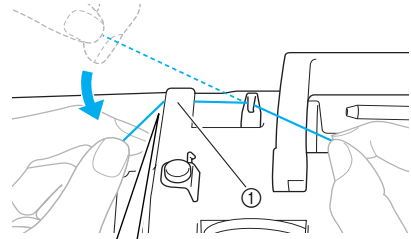

- ① Thread guide cover
 ② Thread guide spring
 ③ Thread
 ④ When the presser foot lever is lowered

- 7** Pass the thread through the guides in the order shown below.

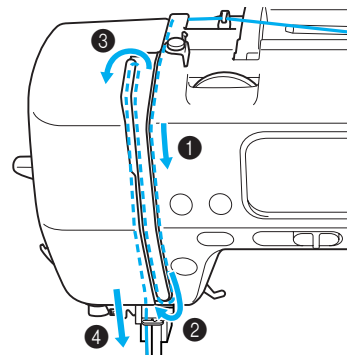

- 8** Make sure that the thread is passed into the thread take-up lever as shown below.

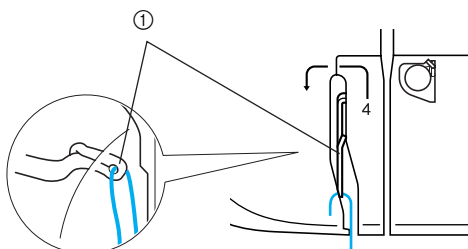

① Thread take-up lever

- 9** Pass the thread behind the needle bar thread guide.

The thread can easily be passed behind the needle bar thread guide by holding the thread in your left hand, then feeding the thread with your right hand, as shown.

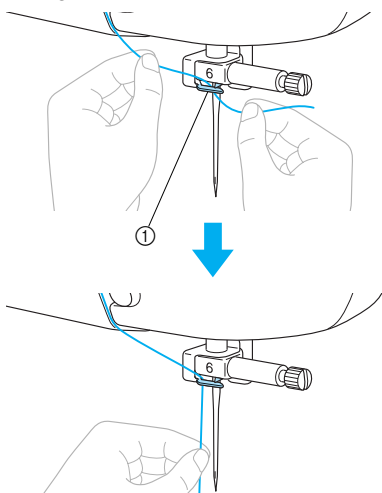

① Needle bar thread guide

- 10** Next, use the needle threader to thread the needle. Continue with the procedure in "Threading the upper thread" (page 34).

Incorrect thread tension

■ Symptoms

- Symptom 1: The lower thread is visible from the upper side of the fabric.
- Symptom 2: The upper thread appears as a straight line on the upper side of the fabric.
- Symptom 3: The upper thread is visible from the lower side of the fabric.
- Symptom 4: The lower thread appears as a straight line on the lower side of the fabric.
- Symptom 5: The stitching on the lower side of the fabric is loose or has slack.

□ Symptom 1

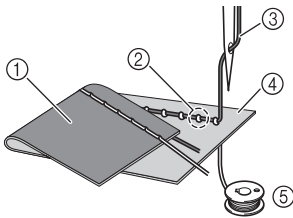

□ Symptom 3

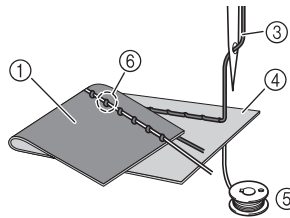

- ① Lower side of fabric
- ② Lower thread visible from upper side of fabric
- ③ Upper thread
- ④ Upper side of fabric
- ⑤ Lower thread
- ⑥ Upper thread visible from lower side of fabric

■ Cause/remedy/check details

□ Cause 1

The machine is not correctly threaded.

<With symptoms 1 and 2 described above>

The bobbin threading is incorrect.

Return the upper thread tension to the standard setting, and then refer to "Upper thread tightened up" (page 178) to correct the threading.

<With symptoms 3 through 5 described above>

The upper threading is incorrect.

Return the upper thread tension to the standard setting, and then refer to "Tangled thread on wrong side of fabric" (page 179) to correct the upper threading.

□ Cause 2

A needle and thread appropriate for the fabric are not being used.

The sewing machine needle that should be used depends on the type of fabric sewn and the thread thickness.

If a needle and thread appropriate for the fabric are not being used, the thread tension will not be adjusted correctly, causing wrinkles in the fabric or skipped stitches.

- Refer to "Selecting the needle depending on the thread and fabric types" (page 39) to check that a needle and thread appropriate for the fabric are being used.

□ Cause 3

The setting selected for the upper thread tension is not appropriate.

Refer to "Adjusting the stitch length" (page 62) to select an appropriate thread tension.

The appropriate thread tension differs depending on the type of fabric and thread being used.

- * Adjust the thread tension while test sewing on a piece of scrap fabric that is the same as that used in your project.



Note

- If the upper threading and bobbin threading are incorrect, the thread tension cannot be adjusted correctly. Check the upper threading and bobbin threading first, and then adjust the thread tension.

- If the bobbin thread is visible from the right side of the fabric

Turn the thread tension dial to the left to loosen the upper thread.



- If the upper thread is visible from the wrong side of the fabric

Turn the thread tension dial to the right to tighten the upper thread.



Fabric is caught in the machine and cannot be removed

If the fabric is caught in the sewing machine and cannot be removed, the thread may have become tangled under the needle plate. Follow the procedure described below to remove the fabric from the machine. If the operation could not be completed according to the procedure, instead of attempting to complete it forcefully, contact your nearest authorized service center.

■ Removing the fabric from the machine

1 Immediately stop the sewing machine.

2 Turn off the sewing machine.

3 Remove the needle.

If the needle is lowered into the fabric, turn the handwheel away from you (clockwise) to raise the needle out of the fabric, and then remove the needle.

- Refer to "Checking the needle" (page 40).

4 Remove the presser foot and presser foot holder.

- Refer to "Replacing the Presser Foot" (page 43) and "Removing and attaching the presser foot holder" (page 45).

5 Lift up the fabric and cut the threads below it. If the fabric can be removed, remove it. Continue with the following steps to clean the race.

6 Remove the needle plate cover.

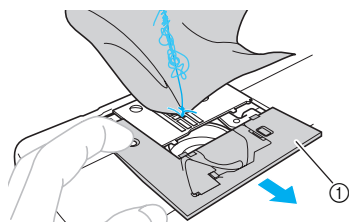

① Needle plate cover

- Refer to "Cleaning the race" (page 176).

7 Cut out the tangled threads, and then remove the bobbin.

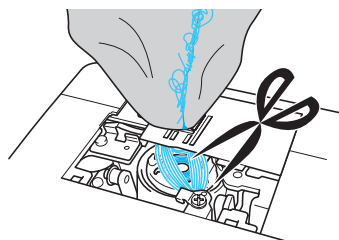

8 Remove the bobbin case.

If threads remain in the bobbin case, remove them.

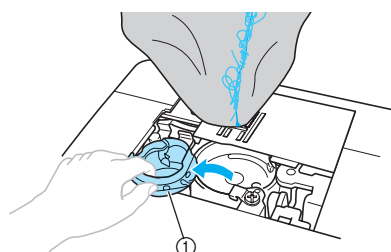

① Bobbin case

9 Use the cleaning brush or a vacuum cleaner to remove any dust from the race and its surrounding area.

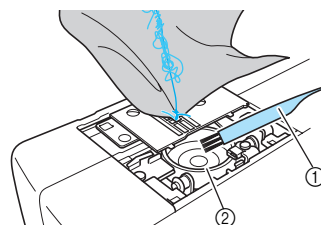

① Cleaning brush
② Race

If the fabric could be removed.	Continue with step 16 .
If the fabric could not be removed.	Continue with step 10 .

- 10** Use the enclosed disc-shaped screwdriver to loosen the two screws on the needle plate.

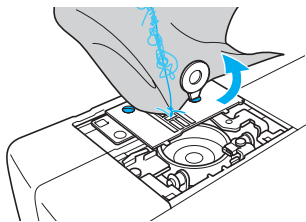
**Note**

- Be careful not to drop the removed screws in the machine.

- 11** Slightly lift up the needle plate, cut any tangled threads, and then remove the needle plate.

Remove the fabric and threads from the needle plate.

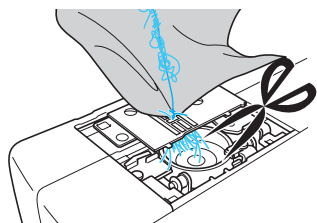

If the fabric cannot be removed, even after completing these steps, contact your nearest authorized service center.

- 12** Remove any threads in the race and around the feed dogs.

- 13** Turn the handwheel to raise the feed dogs.

- 14** Align the two screw holes in the needle plate with the two holes at the needle plate mounting base, and then fit the needle plate onto the machine.

- 15** Lightly finger-tighten the screw on the right side of the needle plate. Then, use the disc-shaped screwdriver to firmly tighten the screw on the left side. Finally, firmly tighten the screw on the right side.

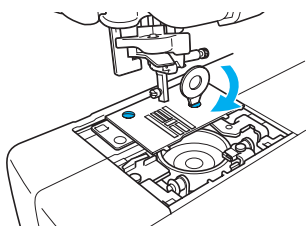

Turn the handwheel to check that the feed dogs move smoothly and do not contact the edges of the slots in the needle plate.

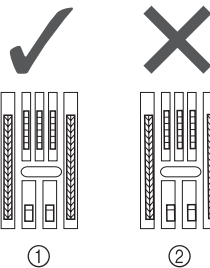

- ① Correct position of feed dogs
② Incorrect position of feed dogs

**Note**

- Be careful not to drop the removed screws in the machine.

- 16** Insert the bobbin case so that the ▲ mark on the bobbin case aligns with the ● mark on the machine.

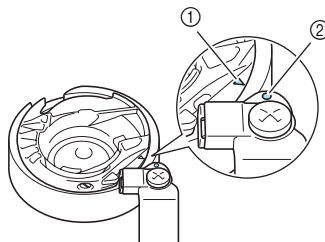
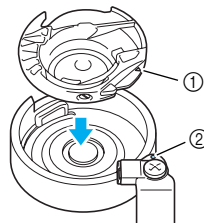

- Align the ▲ and ● marks.

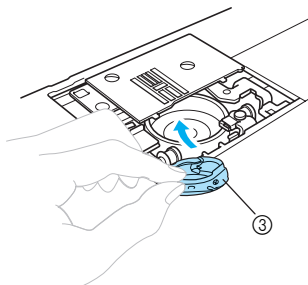

- ① ▲ mark
② ● mark
③ Bobbin case

- Make sure that the indicated points are aligned before installing the bobbin case.

CAUTION

- Never use a bobbin case that is scratched, otherwise the upper thread may become tangled, the needle may break or sewing performance may suffer. For a new bobbin case (part code: XC3153-321 (green marking)), contact your nearest authorized service center.
- Make sure that you fit the bobbin case properly, otherwise the needle may break.

17 Attach the needle plate cover according to steps 8 in "Cleaning the race" (page 176).

18 Check the condition of the needle, and then install it.

If the needle is in a poor condition, for example, if it is bent, be sure to install a new needle.

- Refer to "Checking the needle" (page 40) and "Replacing the needle" (page 41).

CAUTION

- Never use bent needles. Bent needles can easily break, possibly resulting in injuries.



Note

- After completing this procedure, continue with the following procedure in "Checking machine operations" to check that the machine is operating correctly.



Memo

- Since the needle may have been damaged when the fabric was caught in the machine, we recommend replacing it with a new one.

■ Checking machine operations

If the needle plate has been removed, check machine operations to confirm that installation has been completed correctly.

1 Turn on the machine.

2 Select stitch .



Note

- Do not yet install the presser foot and thread.

3 Slowly turn the handwheel toward you (counterclockwise), and look from all sides to check that the needle falls at the center of the hole in the needle plate.

If the needle contacts the needle plate, remove the needle plate, and then install it again, starting with step 3 in "Removing the fabric from the machine" (page 184).

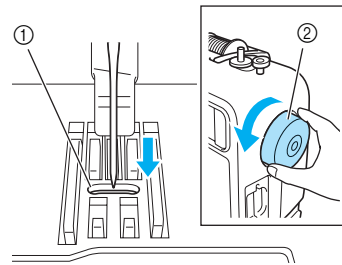

- ① Hole in the needle plate
- ② Handwheel

4 Select stitch . At this time, increase the stitch length and width to their maximum settings.

- For details on changing the settings, refer to "Adjusting the stitch width" (page 61) and "Adjusting the stitch length" (page 62).

5 Slowly turn the handwheel toward you (counterclockwise) and check that the needle bar and feed dogs operate correctly.

If the needle or feed dogs contact the needle plate, the machine may be malfunctioning; therefore, contact your nearest authorized service center.

6 Turn off the machine, and then install the bobbin and presser foot.

- Refer to "Installing the bobbin" (page 27) and "Replacing the presser foot" (page 43).

7 Correctly thread the machine.

- For details on threading the machine, refer to "Upper Threading" (page 31).



Note

- The thread may have become tangled as a result of incorrect upper threading. Make sure that the machine is correctly threaded.

8 Perform trial sewing with normal fabric.



Note

- Incorrect sewing may be the result of incorrect upper threading or sewing thin fabrics. If there are poor results from the trial sewing, check the upper threading or the type of fabric being used.

When the thread became tangled under the bobbin winder seat

If the bobbin winding starts when the thread is not passed under the pretension disk of the bobbin-winding thread guide correctly, the thread may become tangled under the bobbin winder seat. In such a case, wind off the thread according to the following procedure.

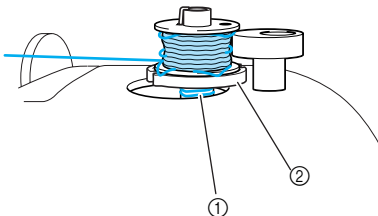

- ① Thread
- ② Bobbin winder seat



CAUTION

- Do not remove the bobbin winder seat even if the thread become tangled under the bobbin winder seat. It may result in injuries.
- Do not remove the screw of the bobbin winder presser, otherwise the machine may be damaged; you cannot wind off the thread by removing the screw.

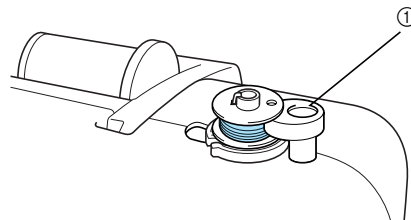

- ① Screw of the bobbin winder presser



If the thread became tangled under the bobbin winder seat, press ① ("Start/Stop" button) once to stop the bobbin winding. When the foot controller is plugged in, remove your foot from the foot controller.

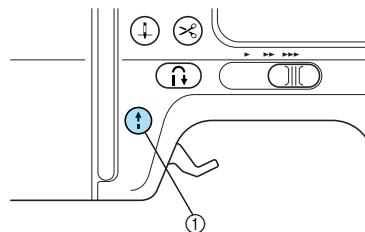

- ① "Start/Stop" button



Cut the thread with scissors beside the bobbin-winding thread guide.

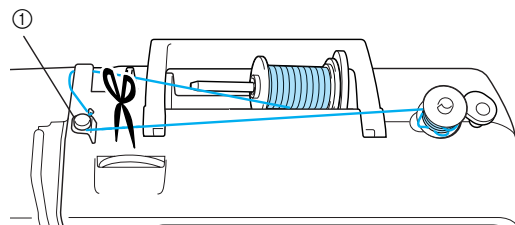

- ① Bobbin-winding thread guide

- 10 Slide the bobbin winder shaft to the left, and then remove the bobbin from the shaft.

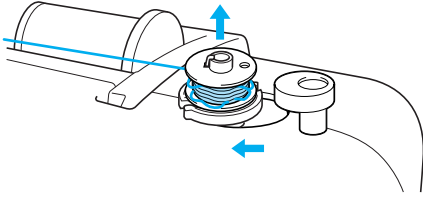

- 11 Hold the thread end with your left hand, and wind off the thread clockwise near the bobbin with your right hand as shown below.

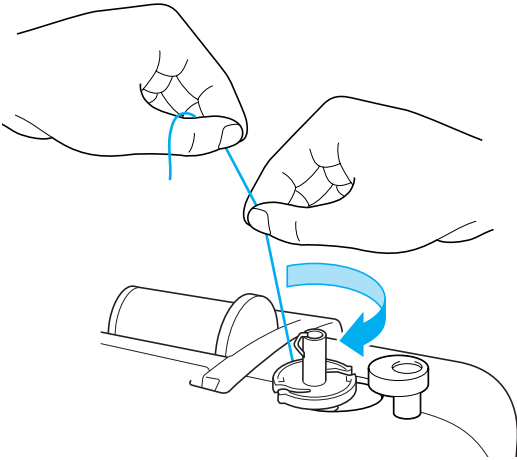

- 12 Wind the bobbin again.



Note

- Make sure that the thread passes under the pretension disk of the bobbin-winding thread guide correctly (page 24).

List of symptoms

Symptom	Probable Cause	Remedy	Reference
The sewing machine does not operate.	The machine is not turned on.	Turn on the machine.	page 17
	The start/stop button was not pressed.	Press the start/stop button.	page 55
	The presser foot lever is raised.	Lower the presser foot lever.	page 54
	The start/stop button was pressed, even though the foot controller is connected.	Do not use the start/stop button when the foot controller is connected. To use the start/stop button, disconnect the foot controller.	page 55
	The bobbin winder shaft is on the right side after winding the bobbin.	Slide the bobbin winder shaft to the left.	page 26
The needle breaks.	The needle is incorrectly installed.	Correctly install the needle.	page 41
	The needle clamp screw is loose.	Use the screwdriver to firmly tighten the screw.	
	The needle is bent or blunt.	Replace the needle.	
	The combination of fabric, thread and needle is not correct.	Select a thread and needle that are appropriate for the type of fabric being sewn.	page 39
	The presser foot that is used is not appropriate for the type of stitch that you wish to sew.	Attach the presser foot that is appropriate for the type of stitch that you wish to sew.	page 72
	The upper thread tension is too tight.	Loosen the upper thread tension.	page 62
	The fabric is pulled too much.	Lightly guide the fabric.	-
	The spool is incorrectly installed.	Correctly install the spool.	page 31
	The area around the hole in the needle plate is scratched, or has a burr on it.	Replace the needle plate. Contact your dealer or the nearest authorized service center.	-
	The area around the hole in the presser foot is scratched, or has a burr on it.	Replace the presser foot. Contact your dealer or the nearest authorized service center.	-
	The bobbin case is scratched, or has a burr on it.	Replace the bobbin case. Contact your dealer or the nearest authorized service center.	-
	A bobbin designed specifically for this machine is not used.	Incorrect bobbins will not work properly. Only use a bobbin designed specifically for this machine.	page 22
The upper thread was not threaded correctly.	Correct the upper threading.	page 32	

Symptom	Probable Cause	Remedy	Reference
The upper thread breaks.	The upper thread was not threaded correctly (for example, the spool is not installed correctly, the spool cap is too big for the spool being used, or the thread has come out of the needle bar thread guide.)	Correct the upper threading. Use the spool cap that best fits the size of the spool being used.	page 31
	There are knots or tangles in the thread.	Remove any knots or tangles.	-
	The selected needle is not appropriate for the thread being used.	Select a needle that is appropriate for the type of thread being used.	page 39
	The upper thread tension is too tight.	Loosen the upper thread tension.	page 62
	The thread is tangled, for example, in the bobbin case.	Remove the tangled thread. If the thread is tangled in the bobbin case, clean the race.	page 176
	The needle is bent or blunt.	Replace the needle.	page 41
	The needle is incorrectly installed.	Correctly install the needle.	
	The area around the hole in the presser foot is scratched, or has a burr on it.	Replace the presser foot. Contact your dealer or the nearest authorized service center.	-
	The bobbin case is scratched, or has a burr on it.	Replace the bobbin case. Contact your dealer or the nearest authorized service center.	-
	A bobbin designed specifically for this machine is not used.	Incorrect bobbins will not work properly. Only use a bobbin designed specifically for this machine.	page 22
Bobbin thread does not wind neatly on the bobbin.	The thread is not passed through the bobbin-winding thread guide correctly.	Correctly pass the thread through the bobbin-winding thread guide.	page 24
	Bobbin spins slowly.	Move the sewing speed controller to the right (so that the speed will be fast).	page 25
	The thread that was pulled out was not wound onto the bobbin correctly.	Wind the thread that was pulled off around the bobbin five or six times clockwise.	page 25
The lower thread is tangled or breaks.	The bobbin thread is incorrectly installed.	Correctly install the bobbin thread.	page 27
	The bobbin is scratched or does not rotate smoothly, or has a burr on it.	Replace the bobbin.	-
	The thread is tangled.	Remove the tangled thread and clean the race.	page 176











Symptom	Probable Cause	Remedy	Reference
The lower thread is tangled or breaks.	A bobbin designed specifically for this machine is not used.	Incorrect bobbins will not work properly. Only use a bobbin designed specifically for this machine.	page 22
The thread is tangled on the wrong side of the fabric.	The upper thread was not threaded correctly.	Correct the upper threading.	page 32
The thread tension is incorrect.	The upper thread was not threaded correctly.	Correct the upper threading. Make sure that the thread is hanged on the thread guide spring which is on the left side of the thread guide cover.	page 32, page 33
	The bobbin thread is incorrectly installed.	Correctly install the bobbin thread.	page 27
	The combination of fabric, thread and needle is not correct.	Select a thread and needle that are appropriate for the type of fabric being sewn.	page 39
	The presser foot holder is incorrectly installed.	Correctly install the presser foot holder.	page 45
	The thread tension is incorrect.	Adjust the tension of the upper thread.	page 62
	A bobbin designed specifically for this machine is not used.	Incorrect bobbins will not work properly. Only use a bobbin designed specifically for this machine.	page 22
The upper thread is too tight.	The bobbin thread is incorrectly installed.	Correctly install the bobbin thread.	page 27
The fabric is wrinkled.	The upper thread was not threaded correctly, or the bobbin is incorrectly installed.	Correctly thread the upper thread and correctly install the bobbin thread.	page 22, page 31
	The spool is incorrectly installed.	Correctly install the spool.	page 31
	The combination of fabric, thread and needle is not correct.	Select a thread and needle that are appropriate for the type of fabric being sewn.	page 39
	The needle is bent or blunt.	Replace the needle.	page 41
	If thin fabrics are being sewn, the stitch is too coarse.	Shorten the stitch length or sew with stabilizer material under the fabric.	page 62, page 70
	The thread tension is incorrect.	Adjust the tension of the upper thread.	page 62
Stitches are skipped.	The upper thread was not threaded correctly.	Correct the upper threading.	page 32
	The combination of fabric, thread and needle is not correct.	Select a thread and needle that are appropriate for the type of fabric being sewn.	page 39
	The needle is bent or blunt.	Replace the needle.	page 41

Symptom	Probable Cause	Remedy	Reference
Stitches are skipped.	The needle is incorrectly installed.	Correctly install the needle.	page 41
	Dust has accumulated under the needle plate or in the bobbin case.	Remove the needle plate cover and clean the race.	page 176
A high-pitched noise is made while sewing.	Dust has accumulated in the feed dogs or in the bobbin case.	Clean the race.	page 176
	The upper thread was not threaded correctly.	Correct the upper threading.	page 32
	The bobbin case is scratched, or has a burr on it.	Replace the bobbin case. Contact your dealer or the nearest authorized service center.	-
	A bobbin designed specifically for this machine is not used.	Incorrect bobbins will not work properly. Only use a bobbin designed specifically for this machine.	page 22
The thread does not pass through the eye of the needle.	The needle has not been raised to the correct position.	Press the needle position button.	page 32
	The needle is incorrectly installed.	Correctly install the needle.	page 41
The stitch is not sewn correctly.	The presser foot that is used is not appropriate for the type of stitch that you wish to sew.	Attach the presser foot that is appropriate for the type of stitch that you wish to sew.	page 72
	The thread tension is incorrect.	Adjust the tension of the upper thread.	page 62
	The thread is tangled, for example, in the bobbin case.	Remove the tangle thread. If the thread is tangled in the bobbin case, clean the race.	page 176
The fabric does not feed.	The feed dogs are lowered.	Slide the drop feed lever to the right.	page 106
	The stitch is too fine.	Lengthen the stitch length.	page 62
	The presser foot that is used is not appropriate for the type of stitch that you wish to sew.	Attach the presser foot that is appropriate for the type of stitch that you wish to sew.	page 72
	The thread is tangled, for example, in the bobbin case.	Remove the tangled thread. If the thread is tangled in the bobbin case, clean the race.	page 176
The fabric feeds in the opposite direction.	The feed mechanism is damaged.	Contact your dealer or the nearest authorized service center.	-
The needle threader lever does not lower to the correct position.	The needle has not been raised to the correct position.	Press the needle position button.	page 32
The sewing lamp does not come on.	The sewing lamp is damaged.	Contact your dealer or the nearest authorized service center.	-
	The machine is not turned on.	Turn on the machine.	page 17
Nothing appears in the LCD.	The brightness of the LCD is either too light or too dark.	Adjust the brightness of the LCD.	page 197

Symptom	Probable Cause	Remedy	Reference
Machine does not operate when embroidery key is pressed.	The embroidery unit is not attached.	Attach the embroidery unit.	page 141
Embroidery unit does not move.	No pattern selected.	Select a pattern.	page 150
	The embroidery unit is not set up correctly.	Set the embroidery unit up correctly.	page 141
Embroidery not neatly done.	The fabric is not fully stretched on the embroidery frame. The fabric is loose.	Stretch the fabric properly on the embroidery frame.	page 145
	No stabilizer material is attached.	Always use stabilizer material for embroidery.	page 144
	The thread is tangled and the bobbin case, etc., is plugged up.	Remove the tangled thread. When the bobbin case is plugged up, clean the race.	page 176
	The thread tension is incorrect.	Adjust the tension of the upper thread.	page 164
	The upper thread was not threaded correctly.	Correct the upper threading. Make sure that the thread is hanged on the thread guide spring which is on the left side of the thread guide cover.	page 32, page 33
	The bobbin thread is incorrectly installed.	Correctly install the bobbin thread.	page 27
	Objects are placed near the carriage or embroidery frame.	If the embroidery unit carriage or embroidery frame bumps into objects, the pattern will be misaligned. Do not place objects within the range of embroidery frame motion.	page 142
	Material coming out of the embroidery frame is causing problems.	Stretch the fabric on the frame once again so that the material coming out of the embroidery frame does not cause problems, rotate the pattern and embroider.	-
	A heavy fabric is being embroidered, and the fabric is hanging off the table.	If embroidery is done with the fabric hanging off the table, the embroidery unit movement will be impaired. Support the fabric while embroidering.	-
	The fabric is catching. It is pinched.	Stop the sewing machine and set the fabric up correctly.	-
	The carriage was moved while the embroidery frame was being removed or attached during embroidery.	If the carriage is moved during the process, the pattern may be misaligned. Be careful when removing or attaching the embroidery frame.	-







Error messages

When erroneous operations are performed messages and advice on operation will be displayed on the LCD. Follow what is displayed. If you press **CLOSE** or do the operation correctly while the error message is displayed, the message disappears.

No	Error Message	Probable Cause
1	 Can not recognize the data. The data may be corrupted.	There is a possibility that the data for the selected pattern is corrupted.
2	 Cannot sew on this screen.	Either the start/stop button or the reverse/reinforcement stitch button was pushed at a LCD screen other than the sewing LCD screen.
3	 Change the speed controller mode to "OFF".	The start/stop button was pressed without connecting the foot controller when the setting for adjusting the stitch width using the sewing speed controller is set to "ON" . You have selected a pattern for which the stitch width control cannot be used. (page 107)
4	 Change to the single needle mode, and replace the needle.  	The twin needle setting is selected while a pattern that cannot be sewn with the twin needle is selected.
5	 Check and rethread the upper thread.	Upper thread broken. Upper thread not set up correctly. Upper thread has run out. CAUTION Be sure to rethread the machine. If you press  (Start/stop button) without rethreading the machine, the thread tension may be wrong or the needle may break and cause injury.
6	 Data volume is too large for this pattern.	You tried to create a design with too many points with the My Custom Stitch function.
7	Deleting...	The machine is deleting a previously saved pattern while in embroidery edit mode.
8	 Disconnect the foot controller.	The start/stop button was pressed while the foot controller was connected. You tried to use the foot controller for embroidery.

No	Error Message	Probable Cause
9	ⓘ Do not change the USB media while it is being read.	You attempted to select a pattern after the USB media containing the pattern has been disconnected, then reconnected.
10	ⓘ Finish editing the pattern before sewing the pattern.	The "Start/Stop" button was pressed before the editing was completed with the My Custom Stitch function.
11	ⓘ Insert an embroidery card.	 on the LCD was pressed when no card was inserted.
12	ⓘ Lift the buttonhole lever.	A stitch other than the buttonhole, bar tack or darning stitch was selected and the start/stop button was pressed while the buttonhole lever is lowered.
13	ⓘ Load USB media.	You retrieved a pattern while no USB media is connected. You tried to use incompatible USB media.
14	ⓘ Lower the presser foot lever.	The start/stop button, reverse/reinforcement stitch button or thread cutter button was pressed while the presser foot was raised.
15	ⓘ Lower the buttonhole lever.	The buttonhole, bar tack or darning stitch was selected and the start/stop button was pressed while the buttonhole lever is raised.
16	ⓘ No more stitches can be combined.	You tried to combine more than 70 decorative stitches, satin stitches, cross stitches or combined utility stitches.
17	ⓘ Not enough available memory. Delete another pattern?	The memory is full and the pattern cannot be saved.
18	ⓘ OK to delete the selected pattern?	You pressed the back key or the embroidery key when a pattern was selected or the utility stitch key when a stitch is selected.

No	Error Message	Probable Cause
19	❗ OK to save the current settings?	You changed the stitch pattern settings, and then tried to save them by pressing the manual memory key.
20	❗ Press the needle position button to raise the needle.	You tried to select an embroidery pattern or change the layout when the needle was down. The machine is turned on while the needle is lowered and the embroidery unit is attached.
21	❗ Raise presser foot lever.	You tried to initialize the embroidery unit with the embroidery foot lowered.
22	❗ Reduce the number of patterns.	A pattern was being retrieved from a USB flash drive (USB flash memory) containing more than 200 embroidery patterns (including folders). In addition, this message will appear if embroidery patterns containing many colors have been saved on the USB media, even if it contains data for no more than 200 patterns (including folders).
23	❗ Retrieve the pattern.	The start/stop button was pressed after selecting a pattern which is saved in the machine's memory or entered from the USB port without pressing  (Retrieve key).
24	❗ Return the bobbin winding shaft to left.	The reverse/reinforcement stitch button, needle position button or thread cutter button was pressed while the bobbin winder shaft is moved to the right.
25	Saving...	A pattern is being saved.
26	❗ Select a pattern.	The start/stop button or reverse/reinforcement stitch button was pressed when no pattern is selected.
27	❗ The bobbin thread is running out.	Bobbin thread has run out. Little bobbin thread remains.
28	⚠ The carriage of the embroidery unit will move.	When the embroidery unit is attached.

No	Error Message	Probable Cause
29	 The pattern is too large for the embroidery frame.	You tried to set a number of characters that will not fit within the frame.
30	 The safety device has been activated.	The upper thread has become tangled around the bobbin case, and the needle is bent and hitting the needle plate, etc., so the sewing machine stops (refer to page 188).
31	 This button does not operate when the embroidery unit is attached.	You tried to use a function that cannot be used when the embroidery unit is attached.
32	 This embroidery card can not be used on this machine.	An Embroidery Memory Card that may not compatible with your machine has been inserted. <ul style="list-style-type: none"> • Certain licensed designs cannot be read by this machine. • Designs in an unacceptable card format cannot be read by this machine. • Design data saved in a hoop size not compatible with your machine has been selected.
33	 This key does not operate when the embroidery unit is attached.	The utility stitch key or the reverse/reinforcement stitch button was pressed while the embroidery unit is attached.
34	 This pattern cannot be used.	You try to retrieve a pattern downloaded as one for a different machine.
35	 Turn off the machine, and attach the embroidery unit.	The start/stop button, the embroidery key, or the memory key is pressed in embroidery mode, but the embroidery unit is not attached. The embroidery key was pressed when the embroidery unit is not attached.
36	Winding bobbin thread...	The bobbin winder is winding the bobbin.
37	F01-F07	If error message "F01" through "F07" appears in the LCD while the sewing machine is being used, the machine may be malfunctioning. Contact your nearest authorized service center.

Adjusting the LCD

If nothing appears in the LCD when the sewing machine is turned on, the brightness of the LCD is either too light or too dark. In such a case, perform the following operation.

- 1 Turn off the sewing machine.

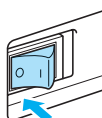

- 2 Turn the power on while pressing any of the operation panel keys except  (Setting key).

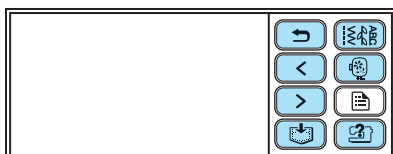

- 3 Press  or .



- 4 Turn off the sewing machine, then turn it on again.

Operation beep

Each time a key is pressed you will hear one beep. If an incorrect operation is performed you will hear two or four beeps.

- **If a key is pressed (correct operation)**
One beep sounds.
- **If an incorrect operation is performed**
Two or four beeps sound.

- **If the machine locks up, for example, because the thread is tangled**

The sewing machine beeps for four seconds and the machine automatically stops.

Be sure to check for the cause of the error, and correct it before continuing to sew.

- **Canceling the operation beep**

When the sewing machine is purchased, it is set to beep each time an operation panel key is pressed. This setting can be changed so that the machine does not beep.

- 1 Turn on the sewing machine.

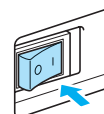

▶ The LCD comes on.

- 2 Press  (Setting key) in the operation panel.

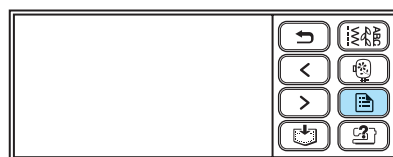

▶ The setting screen appears.

- 3 Press  (Next page key) twice.

- 4 Press OFF for the buzzer.



▶ The screen for changing the beep setting appears.

- 5 Press  (Back key).



▶ The initial stitch screen appears again.

Upgrading Your Machine's Software Using USB Media

You can use USB media and a computer to download software upgrades for your sewing machine. When an upgrade program is available on our website at "<http://solutions.brother.com>", please download the file(s) following the instructions on the website and steps listed below.



Note

- When using USB media to upgrade the software, check that no data other than the upgrade file is saved on the USB media being used before starting to upgrade.
- Upgrade file can be retrieved from a USB flash drive (USB flash memory) of any size.



Memo

- When the machine's software is upgraded, saved combinations of character and decorative stitches are erased. However, saved embroidery patterns are not erased.

- 1 Press and hold the  (Settings key) while turning on the machine.

▶ The following screen appears.



- 2 Insert the USB media into the USB port on the machine. The media device should only contain the upgrade file.

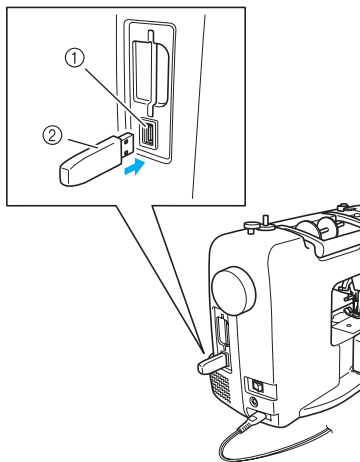

- 1 USB port for media
- 2 USB media



Note

- When using USB media equipped with an access indicator, the access indicator will begin flashing after the media is inserted into your computer or machine, and may take about 5 to 6 seconds before the media is recognized. (The length of time differs depending on the USB media.)

- 3 Press .

▶ The following screen appears.

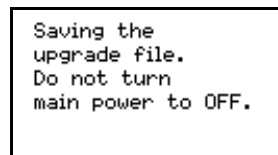

Note

- If an error occurred, a text error message will appear. At this time, turn the machine off, and then start the procedure again from step 1.

- 4 When the following screen appears, upgrading is completed.

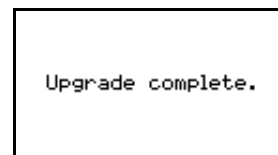

- 5 Remove the USB media, and turn the machine off and on again.

Index

- A**
- accessories 9, 10
 - adjusting layout 162
 - adjusting stitch length 62
 - adjusting stitch width 61
 - adjusting thread tension 62, 164
 - air vent 12
 - appliqué 101
 - appliqué pattern selection 160
 - appliqué stitch 101
 - attaching presser foot holder 45
 - attaching stabilizer material 144
 - attributes 18
 - automatic reverse/reinforcement stitches 64
 - automatic thread cutting 65
- B**
- back key 14
 - bar tack stitch 108
 - basic sewing 50
 - basting stitch 82
 - beep 197
 - blind hem stitch 84
 - bobbin 22
 - bobbin case removal 177
 - bobbin cover 12, 28
 - bobbin installation 27
 - bobbin thread, pulling up 29
 - bobbin winder 11, 22
 - bobbin winder seat 26
 - bobbin winding 22
 - bobbin-winding thread guide 11, 24
 - button sewing 92
 - buttonhole lever 12, 90
 - buttonhole sewing 88
 - buttonhole stitching 87
 - buzzer 187
- C**
- care 176
 - changing sewing direction 68
 - character spacing 124
 - checking needle 40
 - cleaning bobbin case 177
 - cleaning brush 9
 - cleaning machine surface 176
 - combining patterns 126
 - concealed seams 94
 - connecting character patterns 165
 - country thread 136, 152
 - crazy quilt stitching 103
 - cross stitches 51, 122
 - cuffs 46
 - curve sewing 68
 - custom stitches 131
 - cutting thread 59
 - cutting thread automatically 65
- D**
- darning 111
 - darning stitch 108
 - decorative stitches & patterns 122
 - deleting saved pattern 130
 - design examples 134
 - designing stitch patterns 131
 - drop feed lever 12, 92
- E**
- elastic tape 99
 - embroidering 136, 158
 - embroidering pattern 158
 - embroidering steps 137
 - embroidery bobbin thread 9
 - embroidery card 156
 - embroidery card slot 12, 156
 - embroidery character selection 154
 - embroidery data 169
 - embroidery foot installation 138
 - embroidery foot removal 140
 - embroidery frame 145
 - embroidery frame installation 148
 - embroidery frame removal 149
 - embroidery key 14
 - embroidery pattern selection 150
 - embroidery pattern types 150
 - embroidery sets 9
 - embroidery sheet 146
 - embroidery threads 136
 - embroidery unit connector slot 11
 - embroidery unit installation 141
 - embroidery unit removal 143
 - error messages 193
 - even seam allowance 70
 - examples of designs 134
 - extension table 46
 - extra spool pin 9, 36
 - eyelet punch 9, 91, 113
 - eyelet stitching 113
- F**
- fabric positioning 54
 - fagoting 115
 - fagoting stitch 114
 - feed dogs 12, 92
 - flat bed attachment 11, 46
 - foot controller 9, 56
 - foot controller jack 12, 56
 - frame pattern selection 155
 - fraying, preventing 78
 - free-arm sewing 46

free-motion quilting	106
front view	11

G

general sewing procedure	50
grid sheet set	9

H

handle	12
handwheel	12
heirloom stitching	119
help key	14
hook-and-loop fastener	69

I

installing bobbin	27
-------------------------	----

J

joining	119
joining stitch	101, 114

L

layout adjustment	162
LCD	18, 151
LCD button	152
LCD messages	183
LCD operation	18

M

machine surface cleaning	176
main power switch	12, 17
maintenance	176
manual needle threading	36
memory key	14
mirroring stitches	66
My Custom Stitch	131

N

needle bar thread guide	12, 34
needle condition	40
needle plate	12, 70
needle plate cover	12, 177
needle plate marking	70
needle position button	13
needle position, changing	83
needle replacement	41
needle set	9
needle threader lever	11, 35
needle threading	31
needles	39
next page key	14

O

operation beep	197
operation buttons	11, 13

operation keys	14
operation panel	11, 14
operation problems	178
operations	21
optional accessories	10
overcasting stitches	78

P

pant legs	46
parallel stitches	36
patchwork	103
pattern combinations	126
pattern embroidery	158
pattern realignment	125
pattern repetition	127
pattern retrieving	129, 174
pattern saving	129
pattern sewing	122, 123
pattern size	123
pattern, deleting	130
piecing	103
piecing straight stitch	101
plug	17
positioning fabric	54
power supply cord	17
power supply jack	12, 17
power switch	12, 17
preparations for embroidering	136
presser foot	12, 43
presser foot holder	12, 45
presser foot holder installation	45
presser foot holder removal	45
presser foot lever	11, 54
presser foot replacement	43
previous page key	14
pulling up bobbin thread	29

Q

quick reference guide	9
quilting	104
quilting guide	105
quilting stippling	101
quilting stitch	101

R

race	177
realigning pattern	125
reinforcement stitching	57, 108
release button	143
removing presser foot holder	45
repeated patterns	127
replacing needle	41
replacing presser foot	43
resewing	166
retrieving pattern	129, 174
reverse stitching	57
reverse/reinforcement stitch button	13, 58
reverse/reinforcement stitches, automatic	64

S

satin stitch length, changing	124
satin stitches	122
saving patterns	129, 174
scallop stitch	114
scallop stitching	116
screwdriver	9
seam allowance, even	70
seam ripper	9
securing stitching	57
selecting alphanumeric characters	154
selecting embroidery patterns	150
selecting stitches	51
selecting the needle	39
settings key	14
sewing basics	50
sewing direction change	68
sewing machine help key	14
sewing speed controller	13
shell tuck stitch	118
side cutter	80
smocking	117
smocking stitch	114
solving operation problems	178
spool cap	9, 23, 32
spool net	9, 24
spool of thread	31
stabilizer material	144
start/stop button	13
stippling	101
stitch length adjustment	62
stitch selection	51
stitch settings	72
stitch width adjustment	61, 107
stopping embroidering	167
straight stitch	72, 82, 94
stretch fabrics	99
stretch stitch	99

T

thick fabrics	68
thin fabrics	70
thread cutter	11
thread cutter button	13, 59
thread cutting	59
thread cutting, automatic	65
thread guide	11, 24, 33
thread guide cover	11, 24, 33
thread guide disk	12, 34
thread spools	31
thread take-up lever	11, 34
thread tension adjustment	62, 164
threading	31
threading bobbin	22
threading needle	31
threading needle manually	36
tips	68
touch panel	14
trial sewing	68
triple stretch stitch	82, 99, 108
troubleshooting	178

turning machine on/off	16
twin needle	9, 36
twin needle sewing	36

U

upgrading	198
upper thread	31
upper thread spool	31
upper thread tension	62, 164
upper threading	31
USB flash drive (USB flash memory)	12, 169, 172
USB port	12, 172
utility stitch key	14
utility stitch selection screen	18
utility stitches	72, 76

W

winding bobbin	22
winding needle	119

Z

zigzag stitches	79, 99, 101
zigzag width adjustment	61

Please visit us at <http://solutions.brother.com> where you can get product support and answers to frequently asked questions (FAQs).

English
885-V95/V96/V97/V98
Printed in China



XE7929-101①

Free Manuals Download Website

<http://myh66.com>

<http://usermanuals.us>

<http://www.somanuals.com>

<http://www.4manuals.cc>

<http://www.manual-lib.com>

<http://www.404manual.com>

<http://www.luxmanual.com>

<http://aubethermostatmanual.com>

Golf course search by state

<http://golfingnear.com>

Email search by domain

<http://emailbydomain.com>

Auto manuals search

<http://auto.somanuals.com>

TV manuals search

<http://tv.somanuals.com>