

BES-962BC BES-1262BC

INSTRUCTION MANUAL

BROTHER
EMBROIDERY
SYSTEMS



Please read this manual before using the machine.
Please keep this manual within easy reach for quick reference.

NINE NEEDLE SIX HEAD ELECTRONIC EMBROIDERY MACHINE
TWELVE NEEDLE SIX HEAD ELECTRONIC EMBROIDERY MACHINE

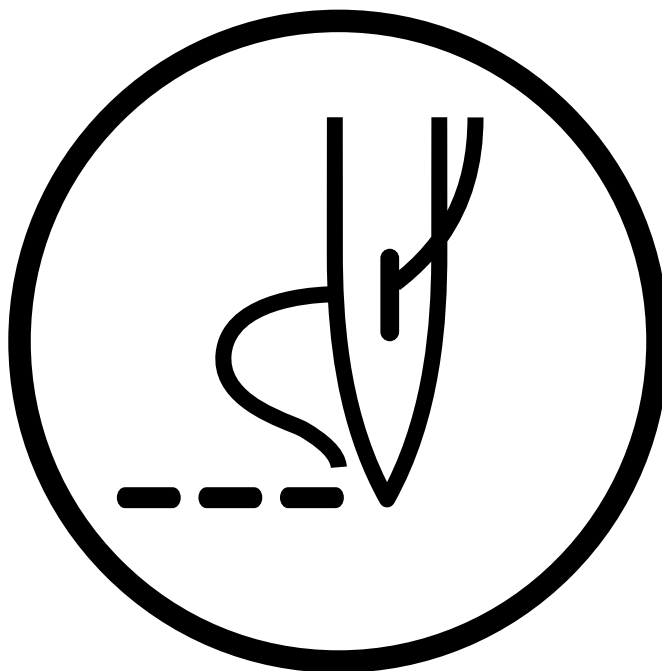

brother[®]

Precautions

- Unauthorized commercial or industrial use of trademarks or copyrighted materials (such as paintings, drawings, photos, logos, etc.) owned by other companies or persons is illegal. The use of such materials without the permission of their owners may result in criminal or civil liability.
- This manual may be subsequently modified without prior notice.
- Brother Industries, Ltd. shall assume no responsibility for any consequences of using this manual.

Thank you very much for buying a BROTHER sewing machine. Before using your new machine, please read the safety instructions below and the explanations given in the instruction manual.

With industrial sewing machines, it is normal to carry out work while positioned directly in front of moving parts such as the needle and thread take-up lever, and consequently there is always a danger of injury that can be caused by these parts. Follow the instructions from training personnel and instructors regarding safe and correct operation before operating the machine so that you will know how to use it correctly.

SAFETY INSTRUCTIONS

1 Safety indications and their meanings

This instruction manual and the indications and symbols that are used on the machine itself are provided in order to ensure safe operation of this machine and to prevent accidents and injury to yourself or other people. The meanings of these indications and symbols are given below.

Indications



DANGER

The instructions which follow this term indicate situations where failure to follow the instructions will almost certainly result in death or severe injury.



CAUTION

The instructions which follow this term indicate situations where failure to follow the instructions could cause injury when using the machine or physical damage to equipment and surroundings.

Symbols



..... This symbol () indicates something that you should be careful of.

The picture inside the triangle indicates the nature of the caution that must be taken. (For example, the symbol at left means "beware of injury".)



..... This symbol () indicates something that you must not do.



..... This symbol () indicates something that you must do.

The picture inside the circle indicates the nature of the thing that must be done. (For example, the symbol at left means "you must make the ground connection".)

2 Notes on safety

DANGER



Wait at least 5 minutes after turning off the power switch and disconnecting the power cord from the wall outlet before opening the face plate of the control box. Touching areas where high voltages are present can result in severe injury.

CAUTION

Environmental requirements



Use the sewing machine in an area which is free from sources of strong electrical noise such as high-frequency welders. Sources of strong electrical noise may cause problems with correct operation.



Any fluctuations in the power supply voltage should be within $\pm 10\%$ of the rated voltage for the machine. Voltage fluctuations which are greater than this may cause problems with correct operation.



The power supply capacity should be greater than the requirements for the sewing machine's electrical consumption. Insufficient power supply capacity may cause problems with correct operation.



The ambient temperature should be within the range of 5°C to 35°C during use. Temperatures which are lower or higher than this may cause problems with correct operation.



The relative humidity should be within the range of 45% to 85% during use, and no dew formation should occur in any devices. Excessively dry or humid environments and dew formation may cause problems with correct operation.



Avoid exposure to direct sunlight during use. Exposure to direct sunlight may cause problems with correct operation.



In the event of an electrical storm, turn off the power and disconnect the power cord from the wall outlet. Lightning may cause problems with correct operation.

Installation



Machine installation should only be carried out by a qualified technician.



Contact your Brother dealer or a qualified electrician for any electrical work that may need to be done.



The sewing machine weighs more than 720 kg. The installation should be carried out by a lift or a crane.



Do not connect the power cord until installation is complete, otherwise the machine may operate if the start switch is pressed by mistake, which could result in injury.



Be sure to connect the ground. If the ground connection is not secure, you run a high risk of receiving a serious electric shock, and problems with correct operation may also occur.



When securing the cords, do not bend the cords excessively or fasten them too hard with staples, otherwise there is the danger that fire or electric shocks could occur.



Be sure to wear protective goggles and gloves when handling the lubricating oil or grease, so that no oil or grease gets into your eyes or onto your skin, otherwise inflammation can result. Furthermore, do not drink the oil or grease under any circumstances, as they can cause vomiting and diarrhoea. Keep the oil out of the reach of children.













Avoid setting up the sewing machine near sources of strong electrical noise such as high-frequency welding equipment. If this precaution is not taken, incorrect machine operation may result.





Secure the machine with the adjustment bolts on the sound floor so that it will not move.

CAUTION







Sewing

-  This sewing machine should only be used by operators who have received the necessary training in safe use beforehand.
-  The sewing machine should not be used for any applications other than sewing.
-  Be sure to wear protective goggles when using the machine.
If goggles are not worn, there is the danger that if a needle breaks, parts of the broken needle may enter your eyes and injury may result.
-  Turn off the power switch at the following times, otherwise the machine may operate if the start switch is pressed by mistake, which could result in injury.
 - When threading the needle
 - When replacing the bobbin and needle
 - When not using the machine and when leaving the machine unattended
-  Do not get on the table.
Table may be damaged.
-  Secure the machine with the adjustment bolts on the sound floor before use the machine so that it will not move.
-  Attach all safety devices before using the sewing machine. If the machine is used without these devices attached, injury may result.
-  Do not touch any of the moving parts or press any objects against the machine while sewing, as this may result in personal injury or damage to the machine.
-  Do not touch the pulse motor and sewing machine bed section during operation or for 30 minutes after operation. Otherwise burns may result.
-  If an error occurs in machine operation, or if abnormal noises or smells are noticed, immediately turn off the power switch. Then contact your nearest Brother dealer or a qualified technician.
-  If the machine develops a problem, contact your nearest Brother dealer or a qualified technician.

Cleaning

-  Turn off the power switch before starting any cleaning work, otherwise the machine may operate if the start switch is pressed by mistake, which could result in injury.
-  Be sure to wear protective goggles and gloves when handling the lubricating oil or grease, so that no oil or grease gets into your eyes or onto your skin, otherwise inflammation can result. Furthermore, do not drink the oil or grease under any circumstances, as they can cause vomiting and diarrhoea.
Keep the oil out of the reach of children.

Maintenance and inspection

-  Maintenance and inspection of the sewing machine should only be carried out by a qualified technician.
-  Ask your Brother dealer or a qualified electrician to carry out any maintenance and inspection of the electrical system.
-  Turn off the power switch and disconnect the power cord from the wall outlet at the following times, otherwise the machine may operate if the treadle is depressed by mistake, which could result in injury.
 - When carrying out inspection, adjustment and maintenance
 - When replacing consumable parts such as the rotary hook and knife.
-  If the power switch needs to be left on when carrying out some adjustment, be extremely careful to observe all safety precautions.
-  Use only the proper replacement parts as specified by Brother.
-  If any safety devices have been removed, be absolutely sure to re-install them to their original positions and check that they operate correctly before using the machine.
-  Any problems in machine operation which result from unauthorized modifications to the machine will not be covered by the warranty.

3 Warning labels

* The following warning labels appear on the sewing machine.
Please follow the instructions on the labels at all times when using the machine. If the labels have been removed or are difficult to read, please contact your nearest Brother dealer.

1

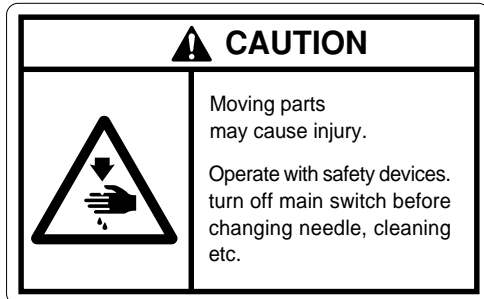

Safety devices: Finger guard, Belt cover, etc.

2

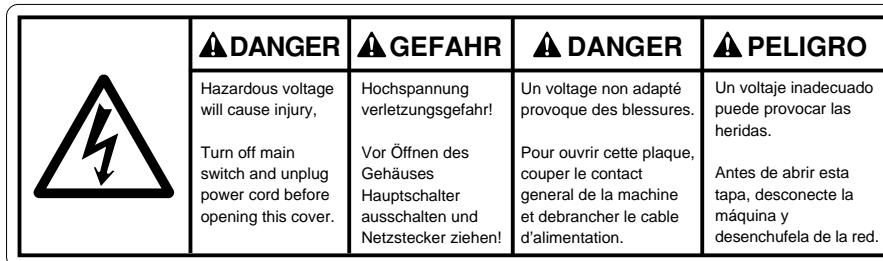

3

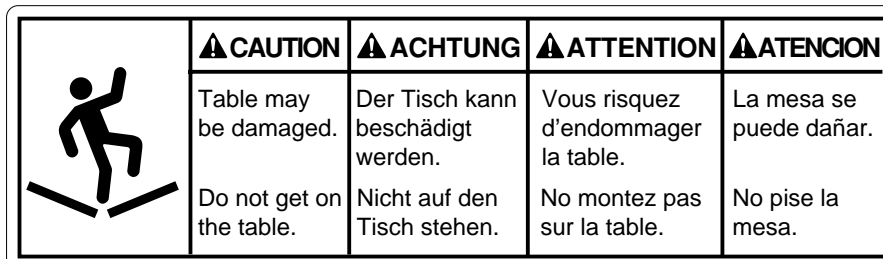

4



Never touch or push the thread take up during operation as it may result in injuries machine.

5



Never touch or push the needle bar during operation as it may result in injuries or damage to the sewing machine.

6

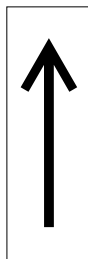

Direction of operation

7



Do not touch this part during activation or for 30 minutes after shut-off. Otherwise burns may result.

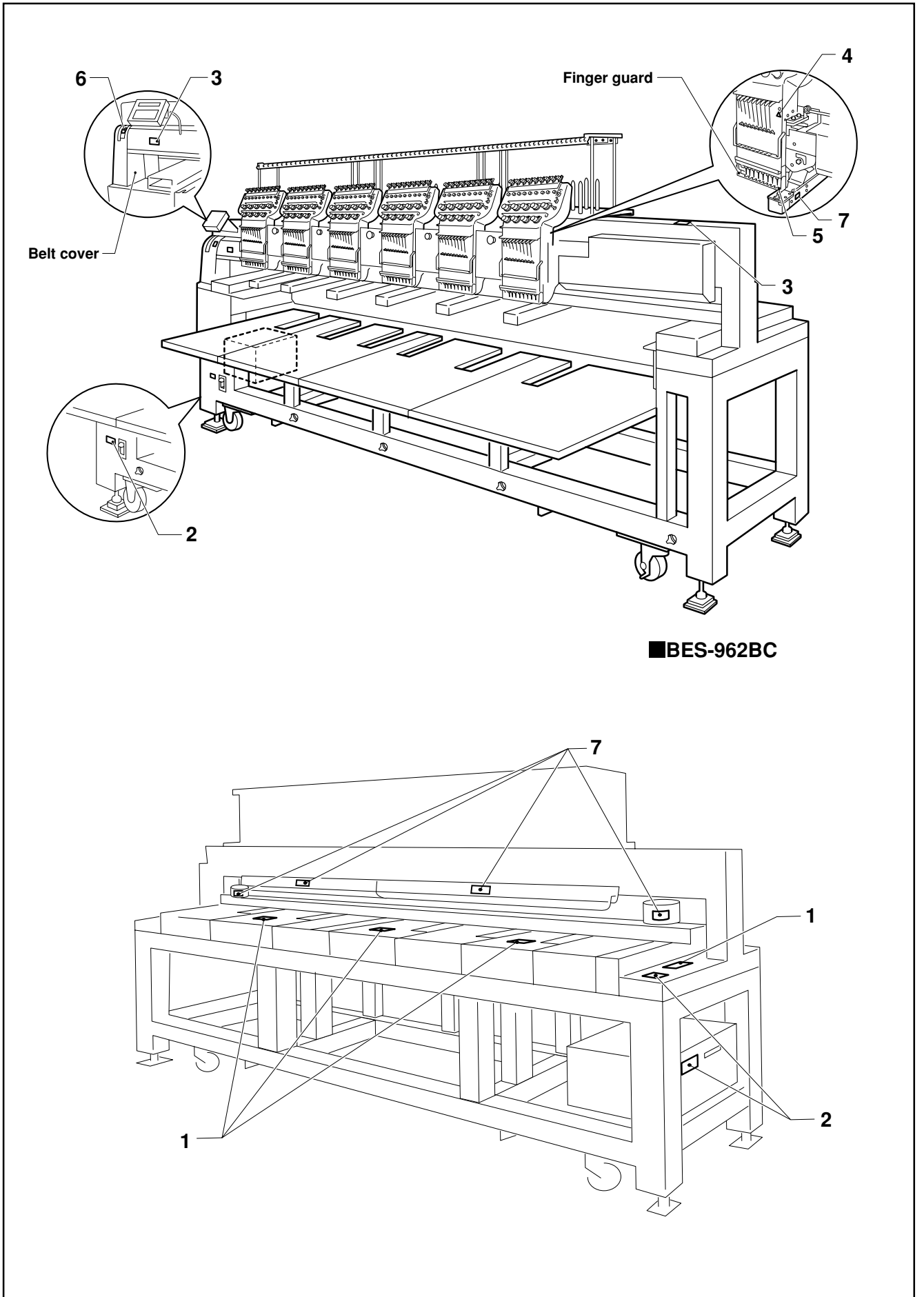

■ BES-962BC

Procedure of Reading This Manual

Explanation of models

This manual explains two models:

- BES-962BC (9 needles)
- BES-1262BC (12 needles)

Explanation for individual model is provided by identifying the model name. Check the model before using the machine. The display is BES-1262BC.

Configuration of this manual

This manual consists of the following chapters:

Chapter 1 An Introduction of Embroidery Machine

Provides information on the specifications of the embroidery machine, software installation environment, and basic software operations.

Chapter 2 Preparation of Embroidery Machine

Describes machine installation and preparation to be conducted before starting embroidering operation.

Chapter 3 Embroidering Procedures

Provides explanations on the operation panel and briefly reviews the flow of embroidering processes.

Chapter 4 Selecting and Transferring Embroidery Data

Explains how to use the Embroidery Data Explorer.

Chapter 5 Editing Embroidery Data

Explains how to use the Embroidery Data Editor.

Chapter 6 Embroidering

Explains how to use the Machine Controller.

Chapter 7 Operation of Machine

Provides information on machine operation during embroidering.

Chapter 8 Creating Production Report

Explains how to use the production report program.

Chapter 9 Maintenance

Describes appropriate maintenance of the machine.

Chapter 10 Adjustment

Explains how to adjust the needles.

Chapter 11 List of Error Codes

Provides information on error codes and action to be taken.

Chapter 12 Troubleshooting

Provides troubleshooting for the machine.

Connection and Installation of Optional Equipment

Describes connections between the machine/computer and optional equipment available.

Contents

SAFETY INSTRUCTIONS	1
Procedure of Reading This Manual	6

Chapter 1 An Introduction of Embroidery Machine

1. Specifications	16
2. Software	17
2-1 Necessary Systems	17
2-2 Configuration of Software	17
2-3 Notes on use	18
2-4 Help	18
2-5 Basic Operation of Software	19
2-6. Handling of floppy disk	23

Chapter 2 Preparation of Embroidery Machine

1. Names of Machine Components	26
2. Installation	27
2-1 Transportation of Machine	27
2-2 Installation of Machine	29
2-3 Preparation of Needle Bar Case	30
2-4 Mounting of Table	32
2-5 Mounting of Cotton Stand	36
2-6 Lubrication to Needle Bar Case	38
2-7 Connection of Personal Computer to Machines (for connecting 4 sets)	39
2-8 Connection of Power Supply	41
2-9 Installation of Software	42
3. Preparation for Embroidering	43
3-1 Upper Threading	43
3-2 Replacement of Bobbin	46
3-3 Replacing and Selecting Needle	47
3-4 Attachment of Embroidery Hoop and Frame	48
3-5 Adjustment of Thread Tension	55

Chapter 3 Embroidering Procedures

Functions of Operation Panel	58
Operation Panel	58
Switches at Machine Heads	60
Switches on Tension Plate	60
Flowchart of Preparation for Embroidering	62
Run the Software	63
Turn on the Machine Power	63

Register the Machine Name	64
Retrieve the Embroidery Data	64
Start Embroidering	65

Chapter 4 Selecting and Transferring Embroidery Data

Functions (Command Reference)	68
Description of Screen	69
Creating a Directory	70
Transferring data	71
Copy	73
Select from Menu	73
Drag Data	73
Moving Data	74
Select from Menu	74
Drag Data	74
Deleting Data	75
Recreate an icon	76
Select all	77
Renaming Data	78
Finding Data	79
Adjusting Screen Display	81
Reading Data in Floppy Disk	82
Reading DOS Format Data	82
Converting the Non DOS format data	84
Reading Data in Paper Tape	88
Settings for Data Reading	90
Writing Data in DST Format	91
Viewing Pattern Information	92

Chapter 5 Editing Embroidery Data

Functions (Command Reference)	94
Description of Screen	96
Opening Embroidery Data	97
Setting Display	98
Centering	98
Zoom	98
Needle Penetration	100
Embroidering Start/End	100

Trim and pause	100
Microstitch	101
Needle Bar and Speed Range	101
Thread Color	105
Tool bar	106
Status Bar	106
Back to Previous Status	107
Undo	107
Redo	107
Editing	108
Rotate	108
Horizontal Flip	109
Vertical Flip	109
Point Symmetry	109
Repeat	109
Resize	111
Delete Stitch	111
Insert or Delete Code	112
Insert Lock Stitch	113
Changing Data	114
Changing Start	114
Changing End	115
Mask	116
Group	117
Setting Group for Repetition	118
Selecting from Menu	118
Merge	119
Saving Data	121
Save	121
Save As...	122
Viewing Pattern Information	123
Printing Data	124

Chapter 6 Embroidering

Functions (Command Reference)	126
When the Power to the Machine is Off	126
When the Power to the Machine is On	126
Description of Screen	129
Settings before Turning On the Machine	130
Displaying the Tool Bar	130
Displaying the Status Bar	131

Upgrading the Version of Interface Board	131
Reset Interface Board	131
Communication Port.....	131
Language	132
Settings after Turning Power On	133
Tool Bar	133
Status Bar	133
Zoom In	133
Zoom Out	133
Zoom In Specified Range.....	134
Fit to Window	134
Whole Pattern	134
Grid	135
Hoop.....	135
Hoop position fine adjustment	135
Needle Penetration	136
Thread Color	137
Needle Bar and Speed Range	137
Setting Needle Bar	137
Setting Ranges.....	141
Grid Setting	142
Background color	142
Renaming Machine	143
Viewing Machine Information	144
Design Information	144
Setting Window Display	144
Minimizing and Aligning Windows	145
Language	147
Copying Data to Other Machines	147
Configuration	148
Upgrading the Machine Program	148
Setting the Machine	149
Needle Bar	149
Same Speed Range	150
Pause	150
Speed Range	151
Head Operation Suspend.....	151
Hoop Feed Position	152
Embroidery Area	152
Embroidery Hoop	153
Thread Trimming	156
Boring	157
Thread Breakage Sensor	158
Automatic Step Back	159
Automatic Hoop Feed	159

End of embroidery	160
Mending	161
Adjust	162
Activating speed up of driving shaft	163
Activate escape with pause	163
Short stitch speed reduction	164
Thin Material or Thick Material	165
Area Trace	166
Default Settings	167
Show Setting	168
Load Setting	170
Save Setting	171
Load Hoop	172
Embroidering	177
Starting Embroidering	177
Moving the Home Position	179
Step-forward/Step-back	180
Entering in the Step-forward/Step-back Mode	180
Setting Step-forward/Back Distance or Timing	181
Stepping Forward/Back	182
Resuming Embroidering	183
Moving Embroidery Position	184
Centering Pattern	185
Saving Data	186
Save	186
Save As...	186
Test	187
Running Other Programs	188

Chapter 7 Operation of Machine

1. Operating Procedures	190
1-1 Power Source	190
1-2 Preparation for Embroidering	190
2. Stopping the Machine	191
2-1 Procedure to Stop the Machine	191
2-2 Resetting Machine Stop	191
2-3 Emergency Stop of the Machine	191
2-4 Resetting Emergency Stop	191
3. Permission for Hoop Movement	192
4. Measures against Thread Breakage	193
4-1 Remedies	193
4-2 Mending	194

5. Jog Embroidering	196
6. Hoop Feed Position	196
7. Area Check	197
7-1 External Tracing	197
7-2 Automatic Hoop Movement in Area	197
8. Jog Switches	198
8-1 Hoop Movement to Start Position	198
8-2 Inching Mode during Embroidering (Forcible Hoop Movement)	199

Chapter 8 Creating Production Report

Functions (Command Reference)	202
Description of Screen	203
Displaying Report	204
Display Example of Details	205
Display Example of Thread Breakage Information on Needle Bar	206
Display Example of Thread Breakage Information in Pattern	207
Display Example of Output Information	208
Display Example of Total Output Information	210
Setting Display Items	211
General	211
Details	212
Thread Breakage Information on Needle Bar	213
Thread Breakage Information in Pattern	213
Output Information	214
Total Output Information	215
Recess Time Setting	216
Save As CSV...	217
Printing Production Report	218
Page Setup	218
Print	218
Copying Report Data	219
Deleting Report	220

Chapter 9 Maintenance

1. Cleaning	222
1-1 Cleaning and Lubrication of Rotary Hook	222
1-2 Cleaning of Needle Plate	223
1-3 Cleaning of Lowre Shaft Module Fan	223
2. Oiling	224
2-1 Head	224

3. Greasing	226
3-1 Head	226
3-2 Feed Guide Section	230

Chapter 10 Adjustment

1. Adjusting Needle Bar Height	232
2. Replacing (Attaching) Rotary Hook	236
3. Adjustment of Clearance Between Needle and Rotary Hook.....	237
4. Adjustment of Timing Between Needle and Rotary Hook	238
5. Adjustment of Presser Foot Height	239
6. Adjustment of Thread Trimmer	240
6-1 Attaching the Fixed Knife	240
6-2 Checking the Movable Knife Position	240
7. Thread Wiper Adjustment	242
8. Adjusting the Belt Tension	243

Chapter 11 Error code list

Chapter 12 Troubleshooting

Mechanical Section	252
Electrical Section	254
Personal Computer Section	263

Connection and Installation of Optional Equipment

Attaching Bobbin Winder	266
--------------------------------------	------------



Chapter 1

An Introduction of Embroidery Machine

1. Specifications

Embroidery machine used	9 needle embroidery machine head (six-head type)	12 needle embroidery machine head (six-head type)
Application	Pattern embroidery	
Sewing speed	Maximum 1000 rpm	
Distance between heads	400 mm	
Maximum feed range	450 (V) x 420 (H) mm (With all heads) 450 (V) x 500 (H) mm (With every other head) 95 (V) x 360 (H) mm (With cap frame)	
Sewing area	450 (V) x 420 (H) mm (With sash frame and all heads) 430 (V) x 300 (H) mm (With maximum-size tubular square hoop/flat hoop and all heads) 85 (V) x 360 (H) mm (With cap frame) 450 (V) x 500 (H) mm (With sash frame/flat hoop and every other head)	
Feed system	By timing belt and stepping motor drive	
Stitch length	0.1 ~ 12.7 mm (minimum pitch: 0.1 mm)	
Storage medium	3.5 2DD floppy disk (Tajima format) Paper tape with 25.4 mm width/8 holes (Tajima, Barudan, Zanks) 3.5 2HD floppy disk (the equivalent to Tajima format) 3.5 2DD floppy disk (Barudan FDR/FMC format) 3.5 2DD floppy disk (ZSK format)	
Thread trimming	Automatic thread trimmer	
Needle thread breakage	Needle thread breakage detector	
Power supply	Single phase 200 V, 50/60 Hz, 1.7kVA	
Weight	720 kg	
Dimensions	(Before assembly) 3650 (W) x 810 (L) x 1650 (H) mm (Leg height) 1310 mm (After setup) 3650 (W) x 1400 (L) x 1650 (H) mm	
Options	Embroidery hoops in different sizes, Bobbin winder, Parts for boring	
Fluorescent lamp	Option	Standard

2. Software

2-1 Necessary Systems

The following systems are needed for installing the software.

- Personal computer with a CPU of Intel Pentium 133 MHz or above (150 MHz or above is recommended.)
- Memory of 16 MB or above (32 MB or above is recommended.)
- Free space of 100 MB or above in the hard disk
- 3.5 floppy disk drive
- CD-ROM drive
- Video card of 1024 x 768 resolution in 256 colors (1280 x 1024 in 65000 colors is recommended.)
- Windows 95

2-2 Configuration of Software

This software is mainly composed of the following four programs. The software is provided on CD-R.

- (1) Embroidery Machine Controller
- (2) Embroidery Data Explorer
- (3) Embroidery Data Editor
- (4) Production Report

Program Functions

- (1) Machine Controller
This program controls embroidering operation of the machine.
A embroidering status can be displayed on the screen in real time, and data for operating the machine can be set.
- (2) Embroidery Data Explorer
This program handles files of embroidery data on patterns.
Transmission of embroidery data to the machine, as well as copy, move and retrieval of a file are available by means of this program. Embroidery data can be converted from the paper tape or floppy disk.
- (3) Embroidery Data Editor
This program allows editing of data on embroidering operation including scaling, rotation, color change, etc.
- (4) Production Report
This program is for collecting data on actual embroidering operation and calculating output, etc.

Relationship among Programs

When the software is started, the program (1) for actuating the machine starts first. Next, embroidery data is called by the program (2). Use the program (3), when required, for editing and embroidering. The embroidery data is totaled by the program (4).

The programs (2), (3), and (4) can be started from the menu of the program (1). Each program can also be started independently.

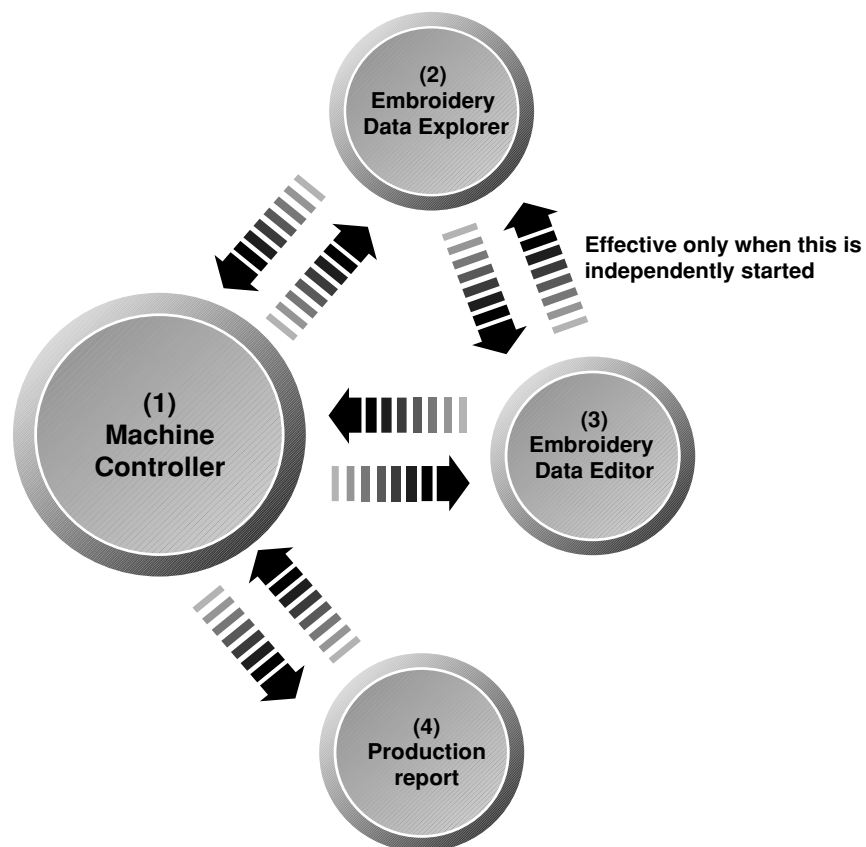

2-3 Notes on use

- Do not start other application software while the machine controller is used.
- Do not set the screen saver.
To cancel setting, select the "Screen saver" on the "Control panel" screen and set "Not used".
- Set the computer not to use the system agent included in the Windows 95 PLUS!.

2-4 Help

The software is equipped with an on-line help function as an accessory.

Click , then the icon of the desired item. A message is displayed to explain the meaning and usage of the item. Pressing the [F1] key brings up the help screen of the application for your reference.

2-5 Basic Operation of Software

This section explains the basics of using the software. It covers only the operating procedures that are commonly used for the software. If there are any special operating procedures inherent to a program, they are explained in each section.

How to Use the Mouse

When selecting an icon or a menu displayed on the screen, move the white arrow pointer on the screen to the required position, then press the button on the mouse.

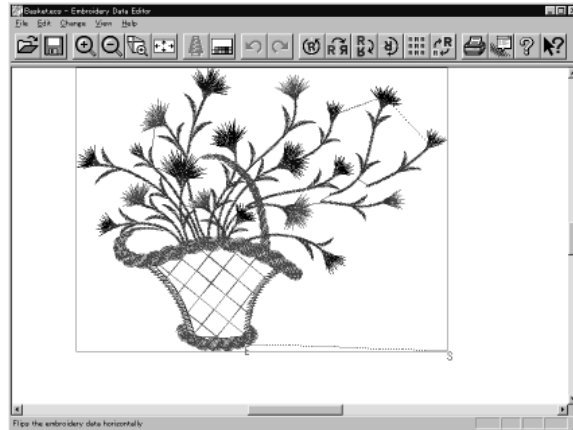

Place the mouse on a flat, smooth surface and move it by sliding on it. The white arrow pointer moves along the mouse motion.

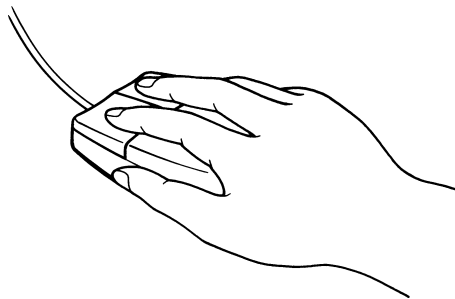

The mouse has two buttons. The left one is used in general. There are three ways of operating the mouse button as described below:

■ Click

Press the left button of the mouse once.

"Click [xx]" means moving the white arrow pointer to "xx" and pressing the left button once.

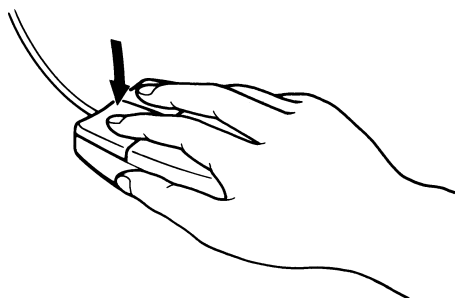

■ **Double-click**

Press the left mouse button twice continuously. Do not leave a long pause in between.

"Double-click [xx]" means moving the white arrow pointer to "xx" and pressing the left button twice continuously.

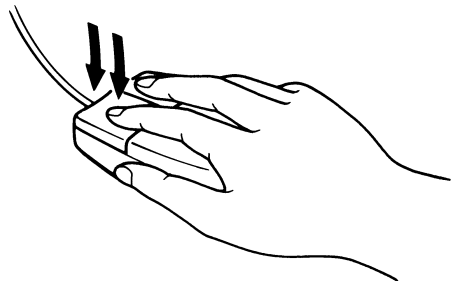

■ **Drag**

Move the mouse while holding down the left button.

Dragging is used for defining an area.

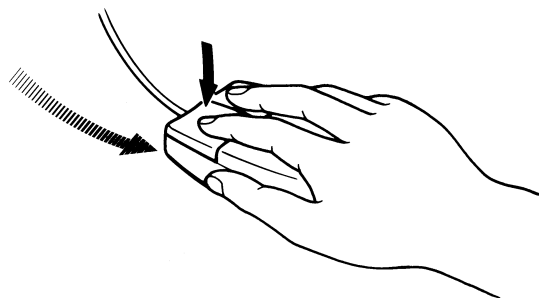

Names of Screen Components

Names of major components on the screen of the machine controller are described below:

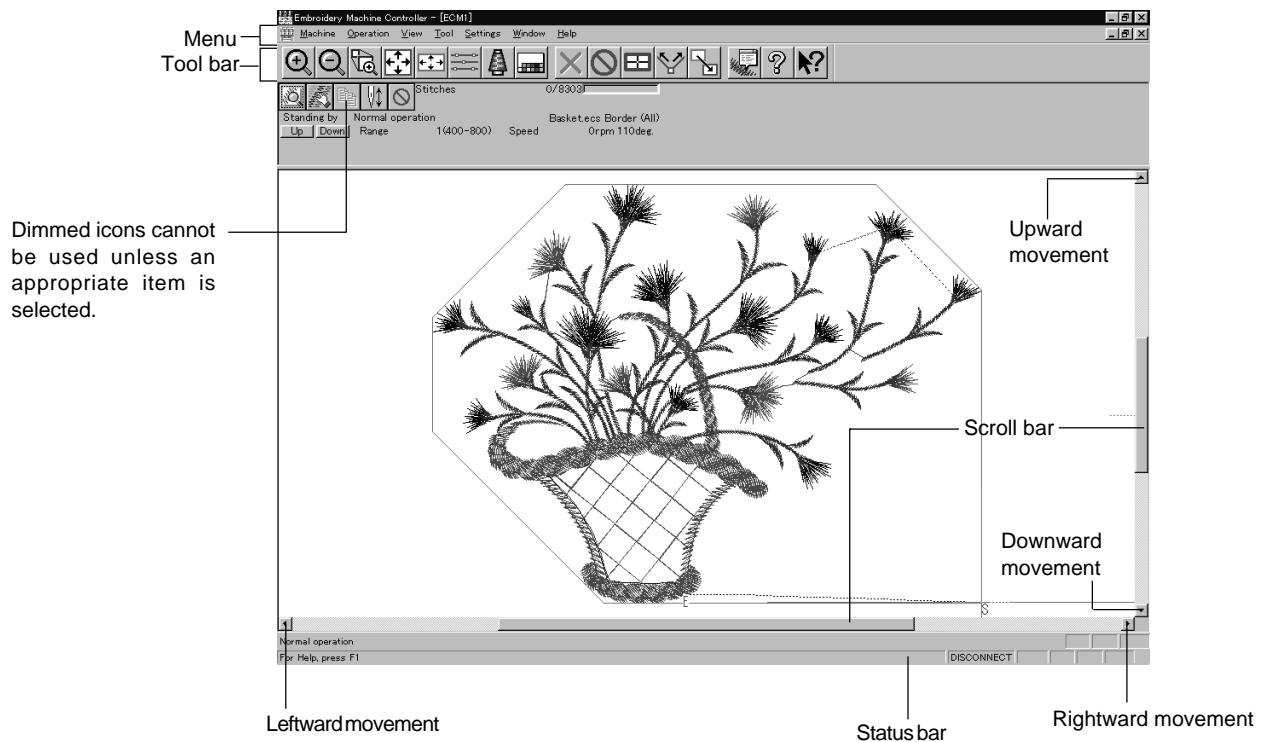

■ Menu

Processing of software is carried out by giving relative commands. Commands are divided in groups and stored in each menu. The menu displayed on the screen changes with depending on the program which is currently active.

■ Tool bar

A command is executed by clicking a relative icon (illustrated button) on the screen. If it is hard to recognize icons from illustrations, move the white arrow pointer to the icon. The name of the icon is displayed.

■ Scroll bar, scroll box, and scroll arrow

Some patterns may not be displayed entirely on the screen. Use the scroll bar to see hidden parts of the pattern into view.

When displaying the right part, for example, click the scroll arrow at the right end. The box in the scroll bar moves to the right. By dragging the scroll box to the right, the screen can scroll quickly.

The vertical scroll bar can be used in the same way.

■ Status bar

This bar is for displaying a brief description of the selected command.

Selection of Menu

Processing of software is carried out by giving a command. A command can be given by the mouse as described below:

1. Move the arrow pointer to a menu name and click there.

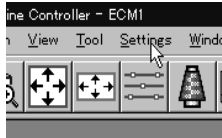

2. A list of commands is displayed. Click the required command.

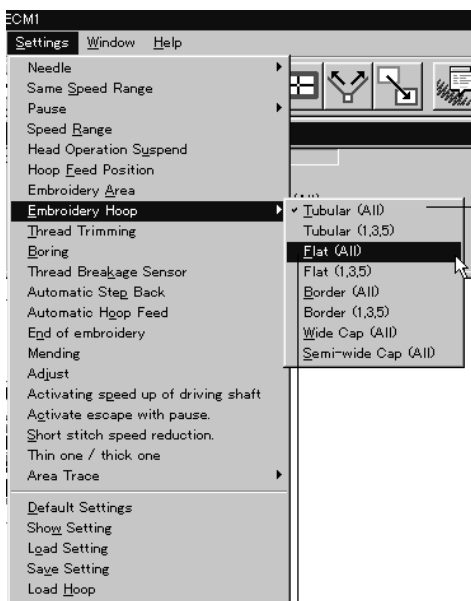

Dimmed commands cannot be used unless an appropriate item is selected.

Commands with a ► mark have sub menus.

The check mark (✓) indicates that the command is selected.

When the arrow pointer is moved to another menu while a list of commands is displayed, those of the latter menu are displayed.

Messages and symbols

Some messages to be displayed on a computer screen may contain the following symbols. These are the symbols for Windows; therefore, they are different from the symbols described in "SAFETY INSTRUCTIONS" on page 1.



Information: This symbol indicates the information on the result of an operation.



Warning: This symbol indicates a warning if user's judgment is needed to continue the current operation.



Important: This symbol indicates a problem if it occurs.

2-6. Handling of floppy disk

Do not force open the shutter for direct contact with the magnetic area.



Do not bring disks near magnetic matters such as magnetic screwdriver or the back side of the programmer.

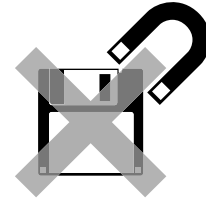

Do not store floppy disks in an extremely high or low ambient temperature.

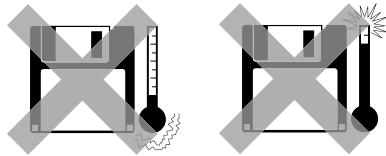

Do not use floppy disks under high humidity.



Do not use or store floppy disks in a dusty place.
Do not place it on cloth.

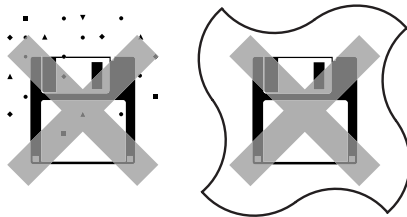

Do not store floppy disks under direct sunlight.

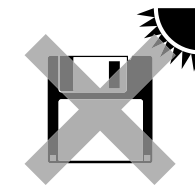

Do not bend the disk. Do not put things on the disk.



Avoid contact with solvent or drink.



Store it in the case immediately after using it to protect it from dust and damage.

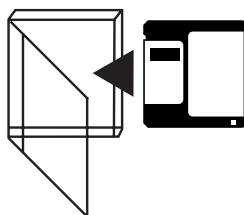

Use a commercially available cleaning disk to clean the head of the floppy disk drive periodically.



Do not remove the disk out of the drive during the access lamp is lit.

Protecting data in floppy disks

Write-protection is available for a floppy disk to prevent undesired data deletion. A write-protected disk is read-only. It is recommended to provide write-protection for disks which contain important data.

To do so, slide the write-protect notch to open the slot as shown below.

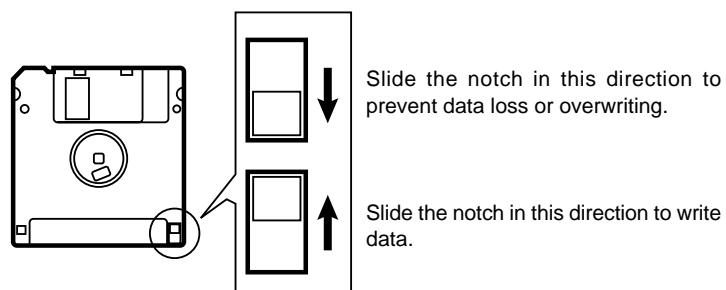



Chapter 2

Preparation of Embroidery Machine

1. Names of Machine Components

■ BES-962BC

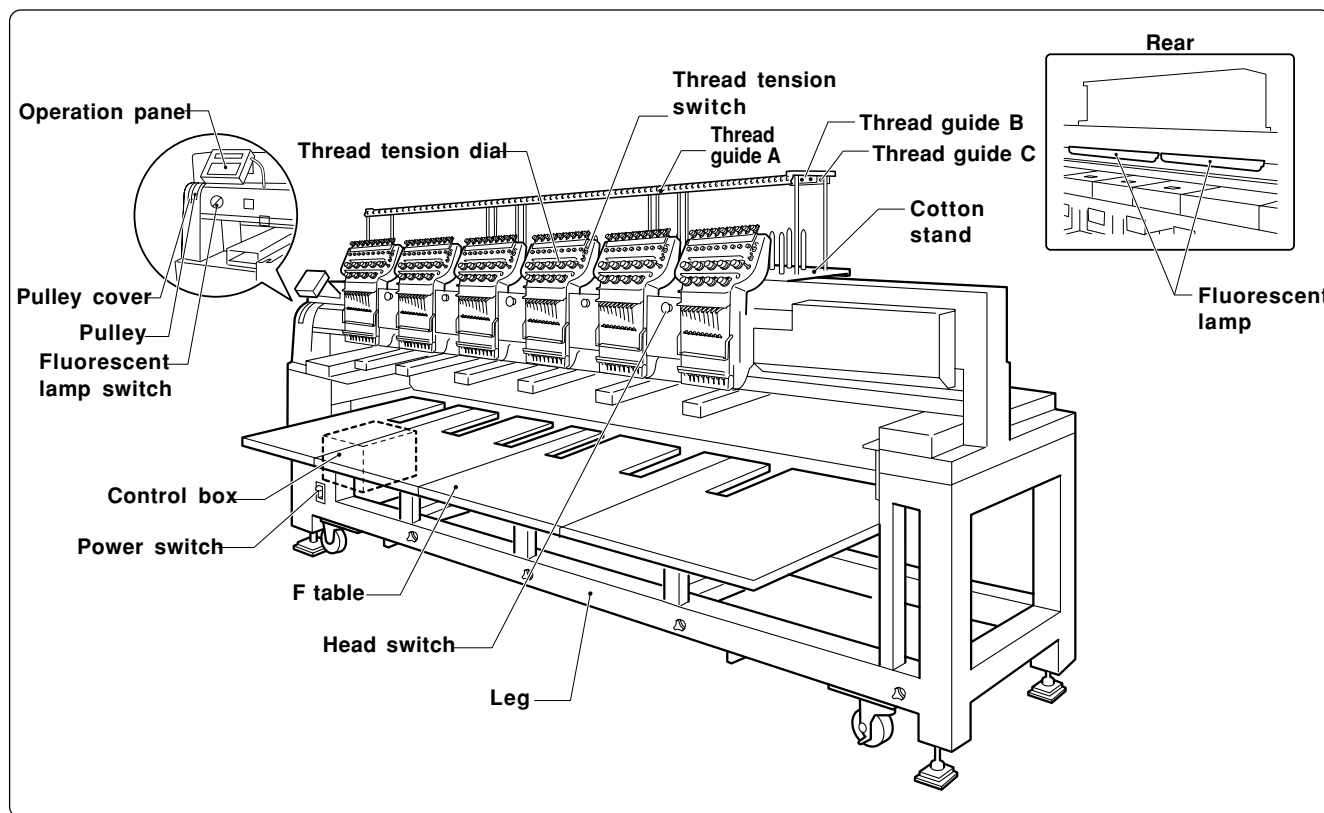

■ BES-1262BC

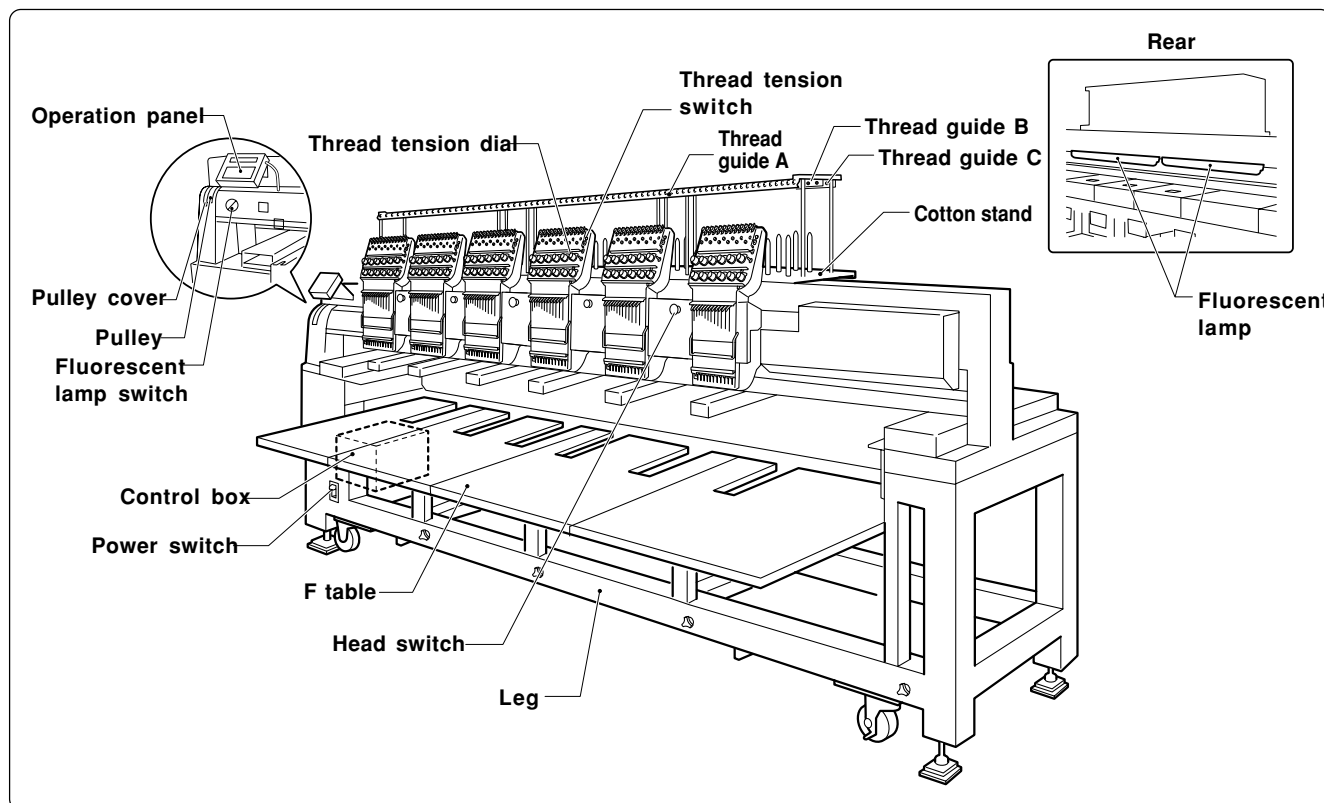

The machine heads are numbered 1 to 6 from the right front.

2. Installation

⚠ DANGER

- ⊘** Embroidery machines should be installed only by trained engineers.

! Electric wiring should be laid by your distributor or electric experts.

! The sewing machine weighs more than 720 kg. The installation should be carried out by a lift or a crane.

⊘ Do not connect the power source until installation is completed. Doing so may start the machine unintentionally through an accidental activation of the START switch, resulting in bodily injuries.
- !** Install a machine in a place away from a high-frequency welding machine or other machines that may generate a strong electric noise. Failure to do so may cause the embroidery machine to malfunction.

⚡ Be sure to connect the ground. If the ground connection is not secure, you run a high risk of receiving a serious electric shock, and problems with correct operation may also occur.

! Secure the machine with the adjustment bolts on the sound floor so that it will not move .

* After installation is completed, get the power supply from a dedicated outlet.

* When connecting multiple machines, exercise care not to exceed the capacity of the outlet.

2-1 Transportation of Machine

When relocating the machine, push the steel frame.

Note) Never push the cover or carriage.

■ When using a fork lift

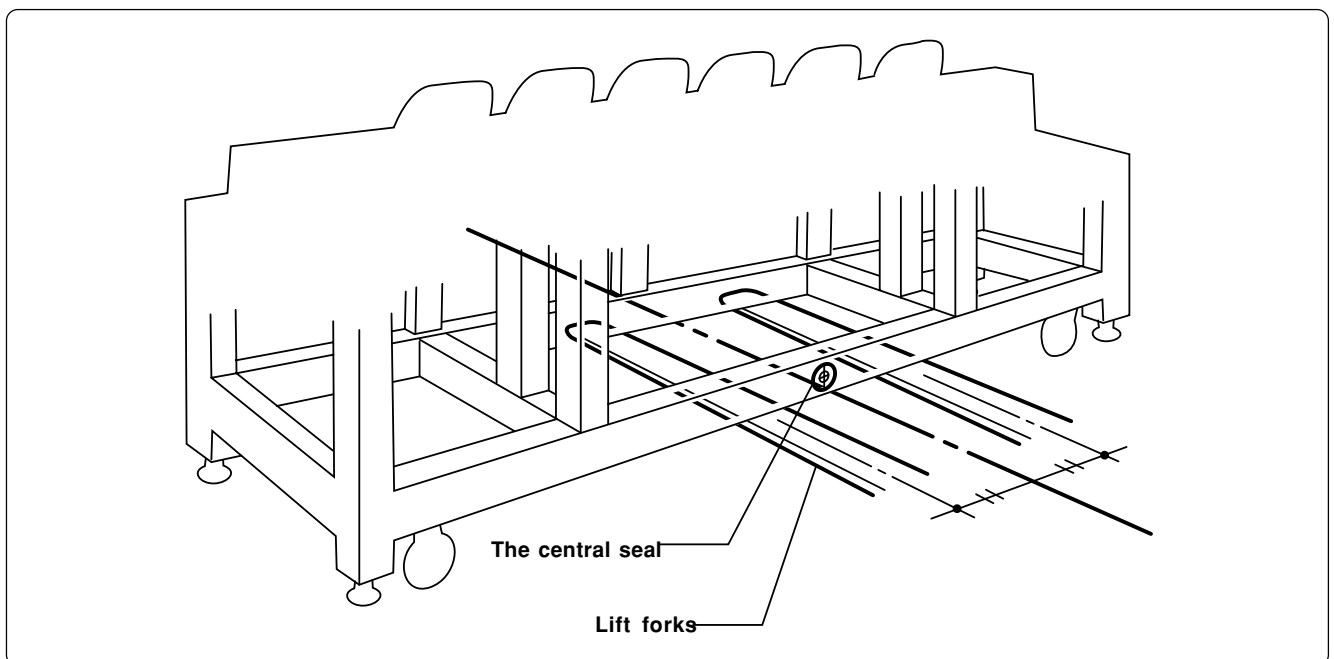

Viewing the machine from the back, position their center at the central seal, insert the forks under the legs and lift the machine.

■ When using a crane

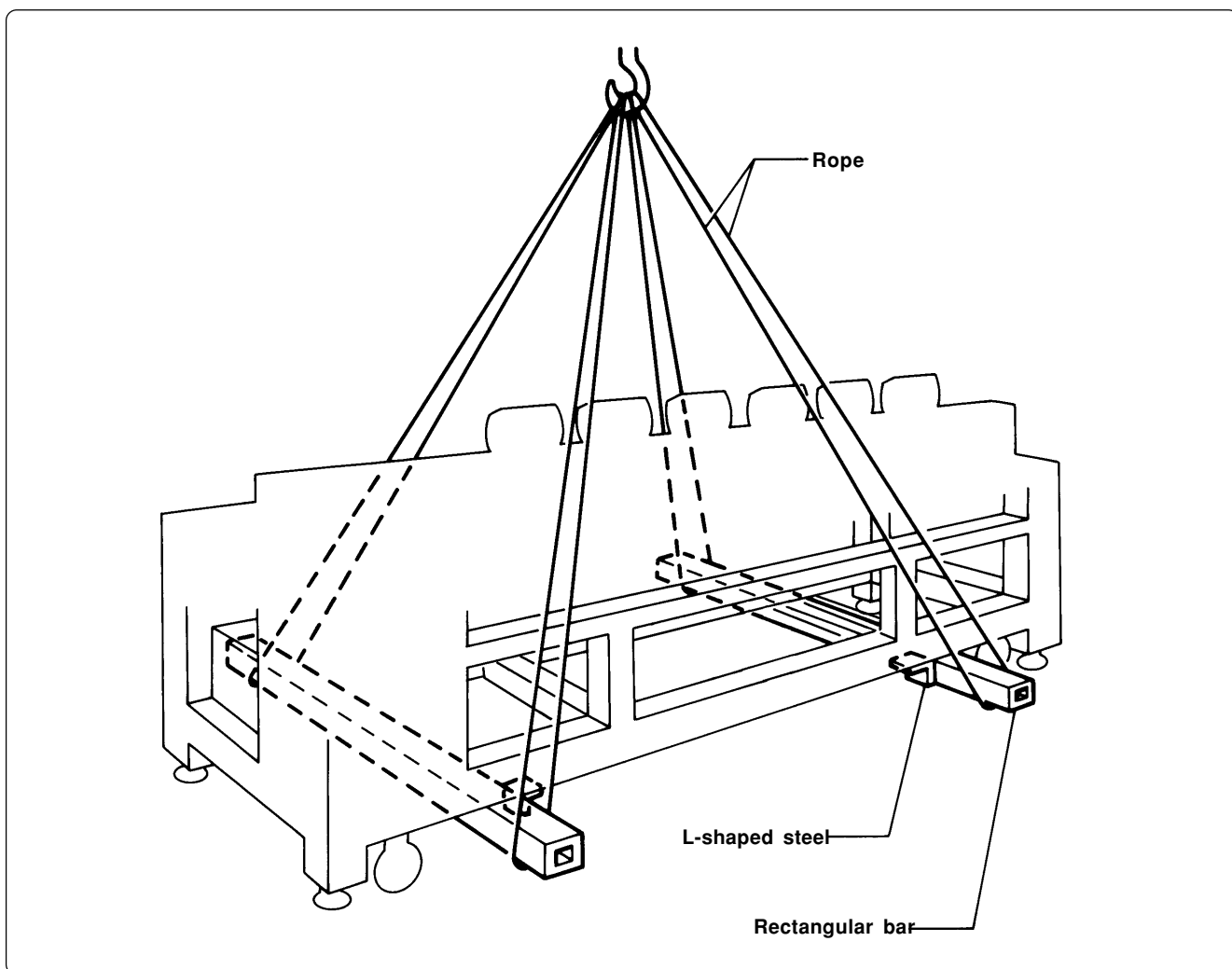

Place two rectangular bars on the four L-shaped steels on the bottom of the machine steel frame. Loop four ropes around the bars and lift the machine.

Note) When lifting the machine, make sure that the ropes do not contact the machine table or the tension plate.

2-2 Installation of Machine

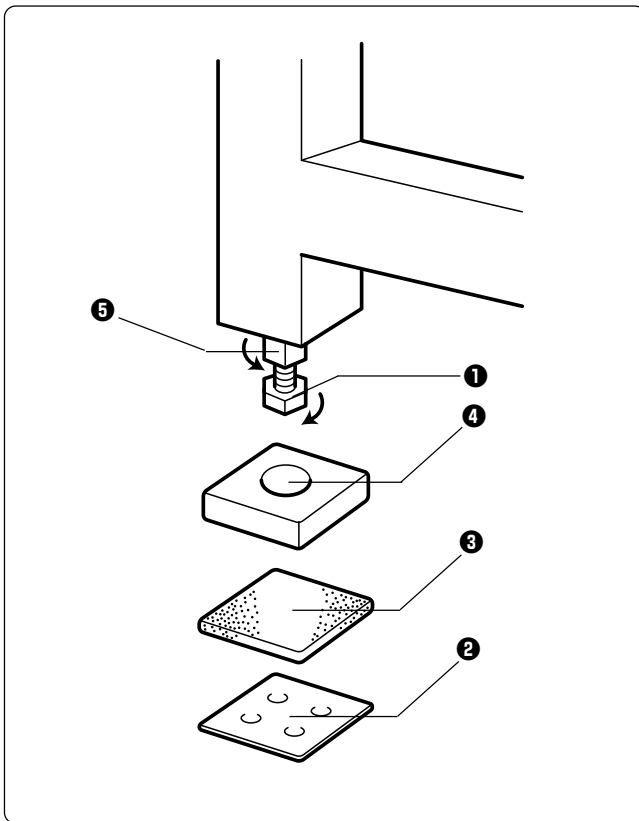

1. Place an adjustment bolt base ④, a rubber cushion 10 ③ (provided with the machine), and PE sheet ② under each of four adjustment bolts M20 ①. The adjustment bolt base must be on the rubber cushion.
2. Fit four adjustment bolts M20 ① into the conical dents of adjustment bolt bases ④, and adjust the embroidery machine in height.
The adjustment must be made in such a manner that the four bolts are under an equal load when the machine is placed down. (To lower adjustment bolt M20 ①, turn it in the direction of the arrow.)
Also, the casters should be raised by several millimeters.
3. After adjusting four adjustment bolts M20 ①, turn nuts M20 ⑤ in the direction of the arrow to fasten them.

Note) If the floor is not strong enough, the embroidery machine may be rocked during operation. In such a case, it is recommended that a secure base of concrete be placed below the embroidery machine.

2-3 Preparation of Needle Bar Case

■ BES-962BC

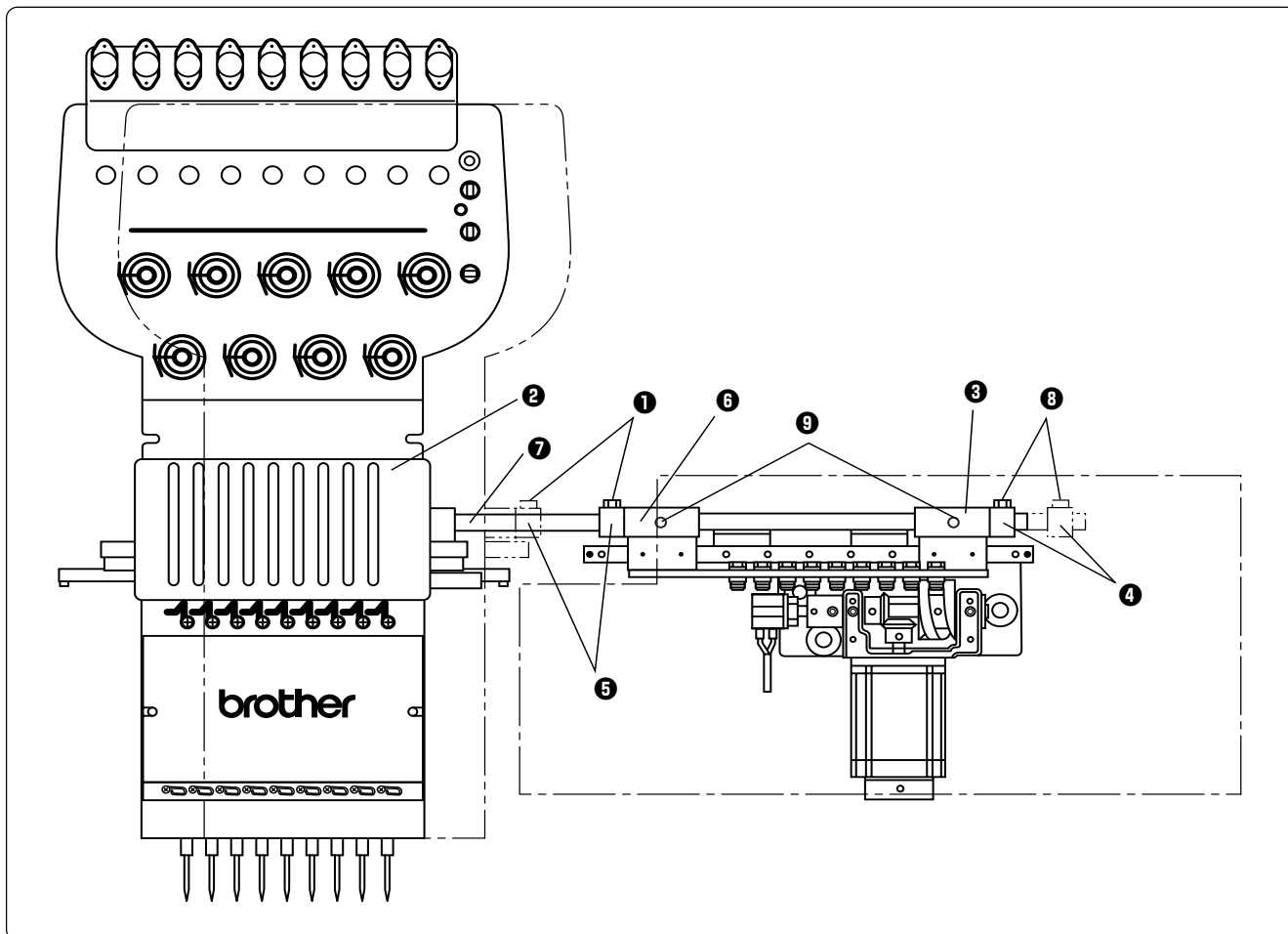

1. Loosen the bolt ① and set screw ⑨, and move the needle case ② to the left.
2. Press the change bracket collar ④ against the change case base ③ on the right, while pressing the change bracket collar ⑤ against the change case base ⑥ on the left, and tighten the bolt ① and set screw ⑩. Check that needles at needle bar No.1 and 9 are inserted into the needle plate holes smoothly.

Notes) • Check that the connecting shaft ⑦ does not have backlash in the horizontal direction.

- Never loose the bolt ⑧ of the change bracket collar ④. If this bolt is loosened, the change bracket collar ④ will be dislocated and the position of the needle bar case ② will need to be adjusted.

■ BES-1262BC

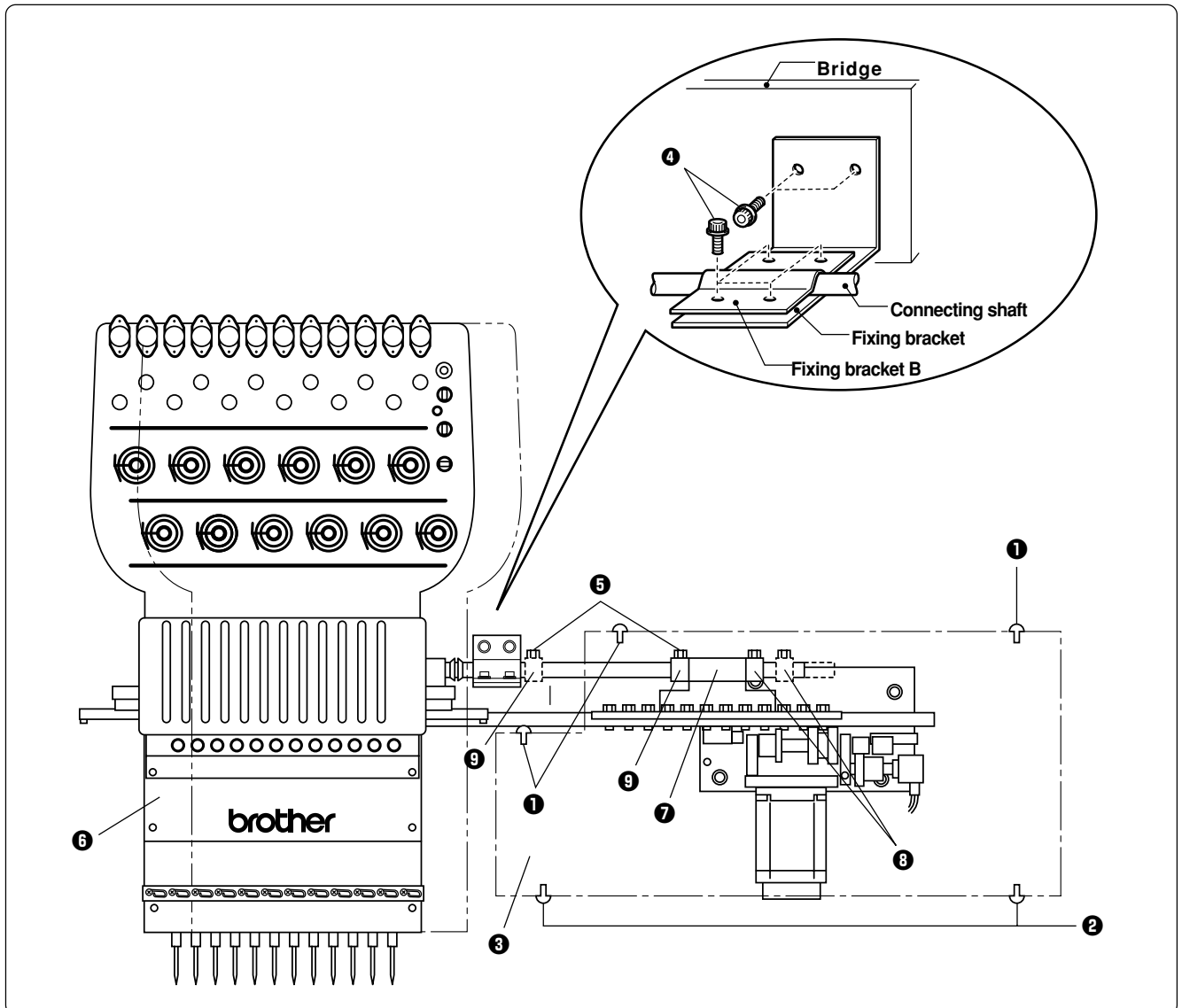

1. Remove 3 pieces of fixing screw ①, loosen 2 pieces of screw ② and remove the color change cover ③.
2. Remove the bolts ④ and detach the fixing bracket for transportation from the bridge and the connecting shaft.
3. Loosen the bolts ⑤ and set screw ⑩, and move the needle bar case ⑥ left side.
4. Press the change bracket collar ⑧ against the change case base ⑦, while pressing the left side change bracket collar ⑨ against the change case base ⑦, and tighten the bolts ⑤ and set screw ⑩. Check that needle bar No.1 and 12 are inserted into the needle plate holes smoothly.

Notes) • Check that there is no play for the connecting shaft in the horizontal direction.

- Never loose the bolt of the change bracket collar ⑧. If this bolt is loosened, the change bracket collar ⑧ will be dislocated and the position of the needle bar case ⑥ will need to be adjusted.

5. Attach the color change cover ③ by 3 pieces of fixing screw ① and 2 pieces of fixing screw ②.

2-4 Mounting of Table

■ Preparation for mounting the F table

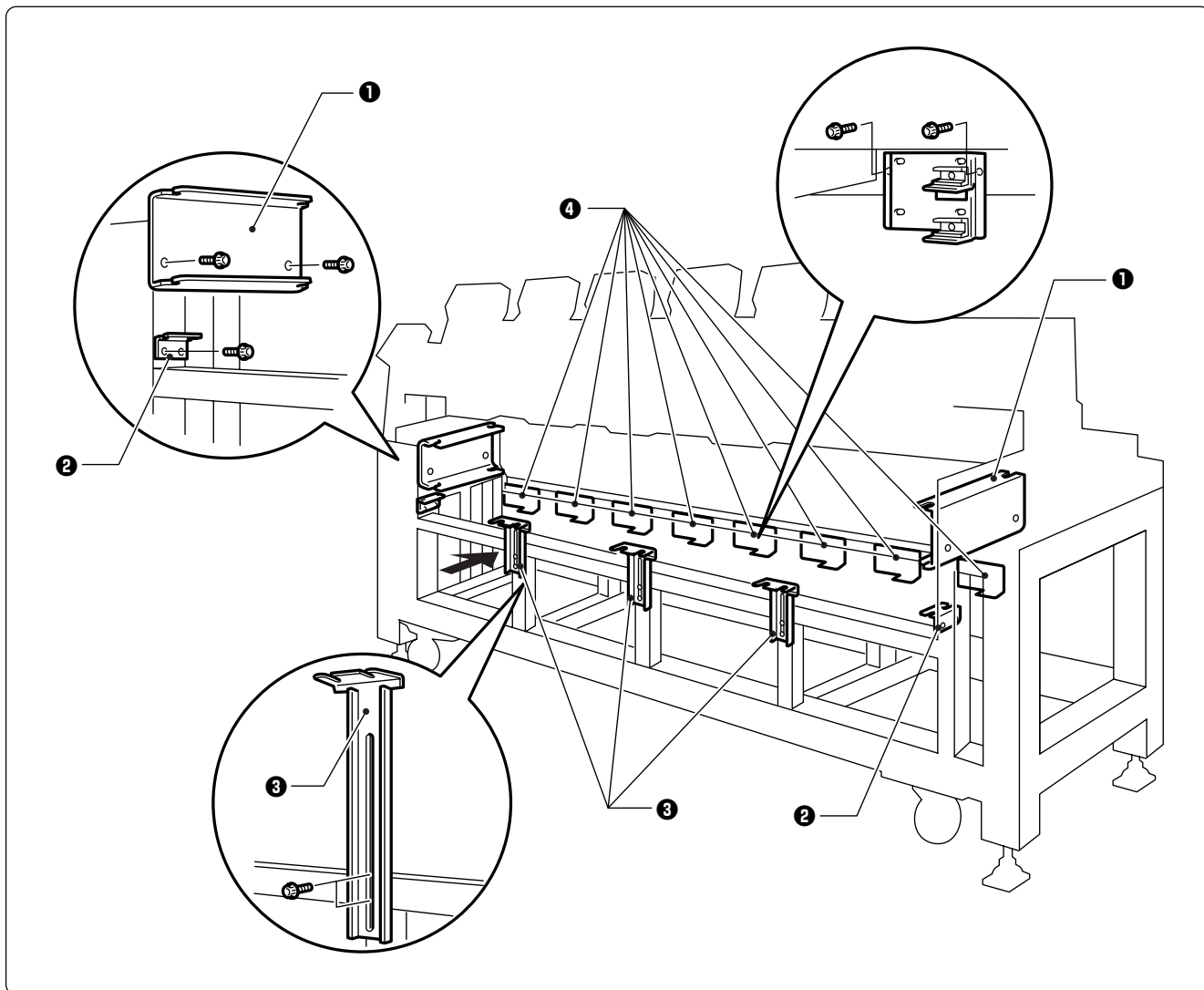

1. Tentatively mount the F table guides UN **①** and L **②** on both sides of the legs using two bolts each.
2. Tentatively mount three F table supports F **③** on the leg front using two bolts each.
3. Tentatively mount eight F table stoppers **④** on the rear legs using two bolts each.

Notes) • The steps 1 and 3 are required only when the F table set is purchased separately from the machine.
 • The F table is a standard attachment.

■ For embroidering with tubular square hoop (middle position)

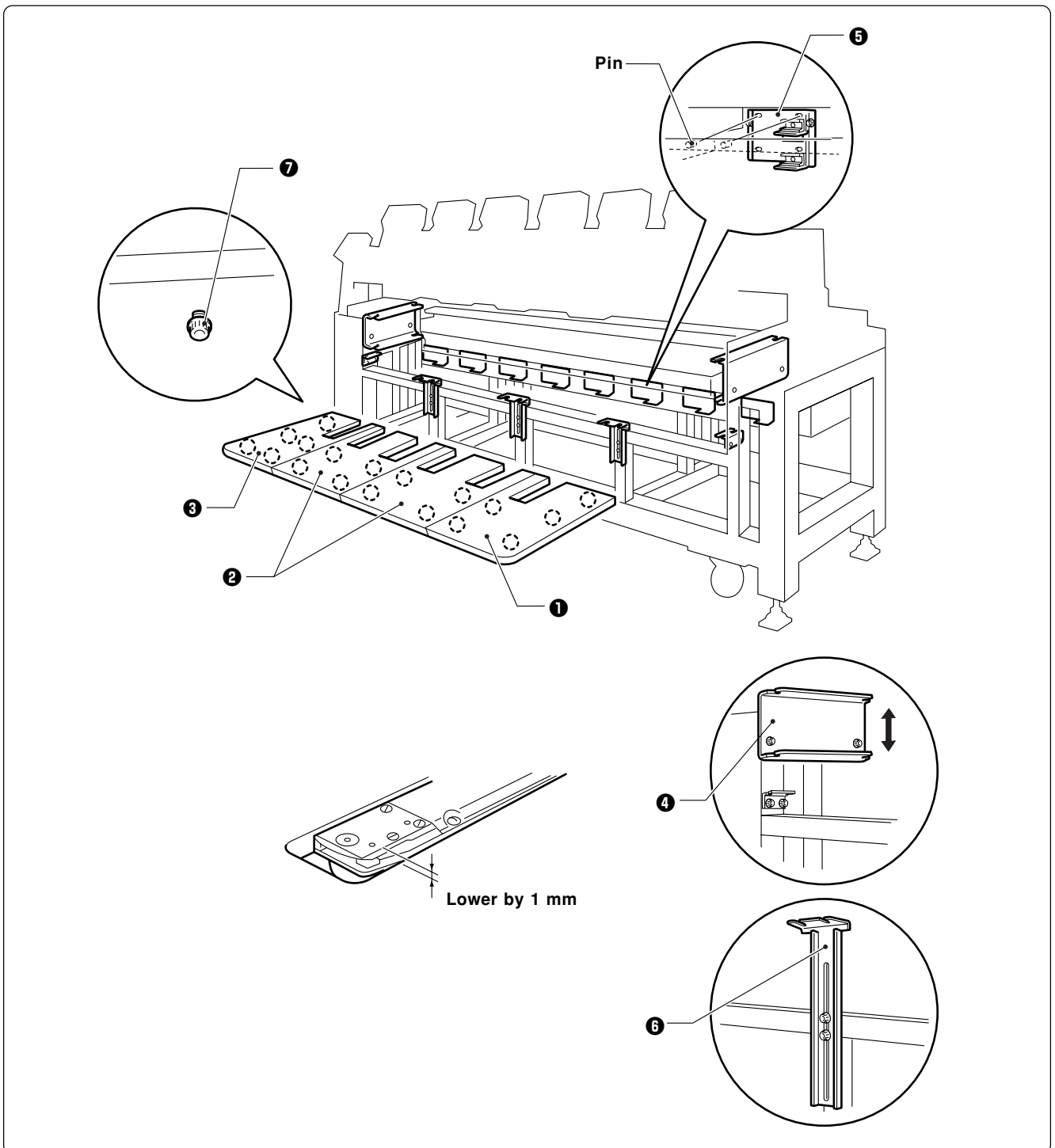

1. Attach four hexagon socket head cap screws to each of F table parts R ①, M (2 pcs) ②, and L ③ from the back.
2. Mount the F table parts from L ③ in order. Insert the bent part (lower) of F table guide UN ④ into the guide. Insert the F table rear pin into the hole of F table stopper N ⑤.
3. Adjust F table supports F ⑥ in height so as to make the F table parallel with the floor.
4. Tighten all hexagon socket head cap screws ⑦ firmly.

■ For embroidering with cap frame (lower position)

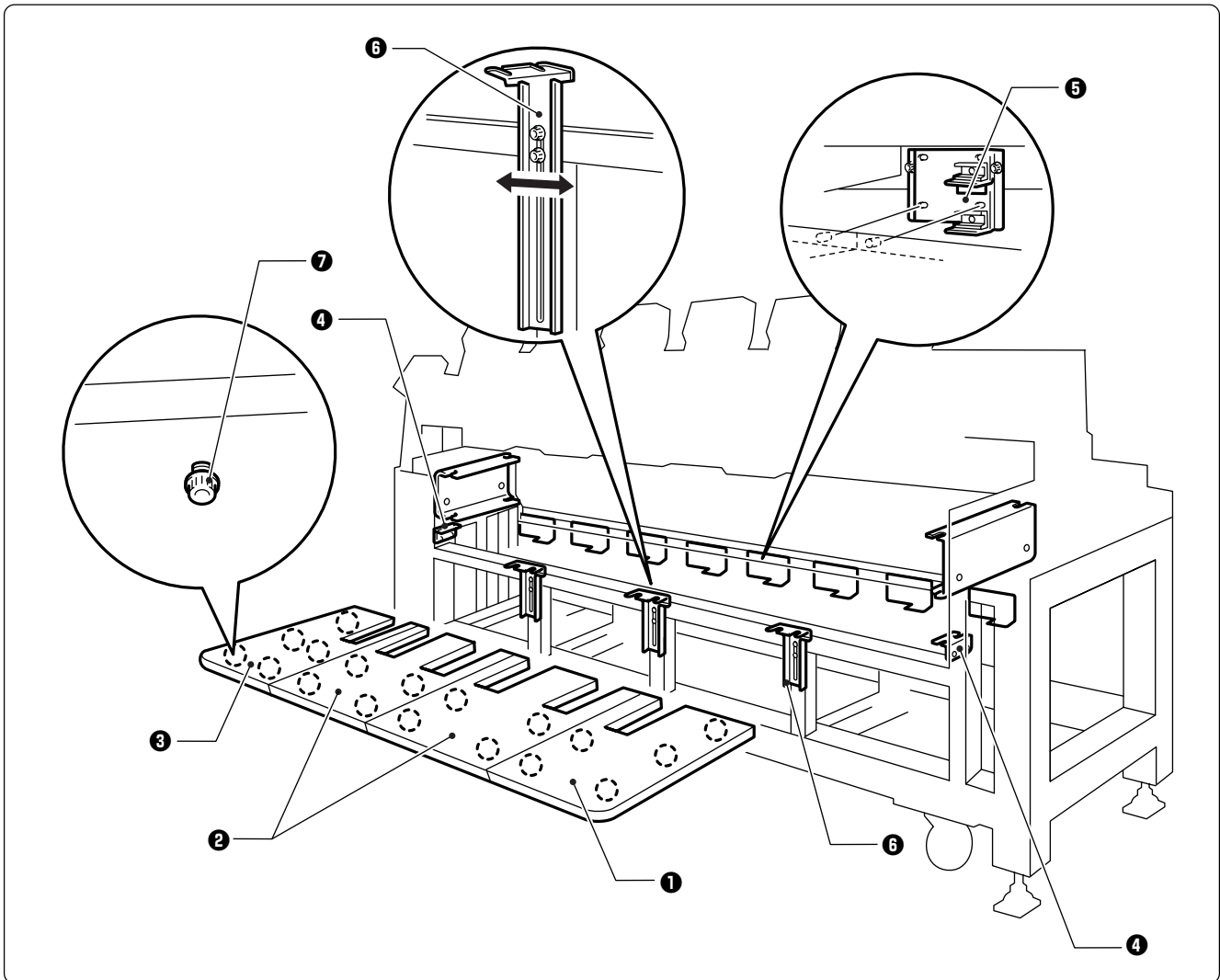

Note) If the F table is kept at the height adjusted for embroidering with tubular square hoop, the cap frame may interfere with the table. Lower the table by one level in this instance.

1. Attach four hexagon socket head cap screws to each of F table parts R ①, M (2 pcs) ②, and L ③ from the back.
2. Mount the F table parts from L ③ in order. Insert the bent part (lower) of F table guide L ④ into the guide. Insert the F table rear pin into the hole of F table stopper N ⑤.
3. Adjust F table supports F ⑥ in height so as to make the F table parallel with the floor.
4. Tighten all hexagon socket head cap screws ⑦ firmly.

■ For embroidering with flat hoop/sash frame (upper position)

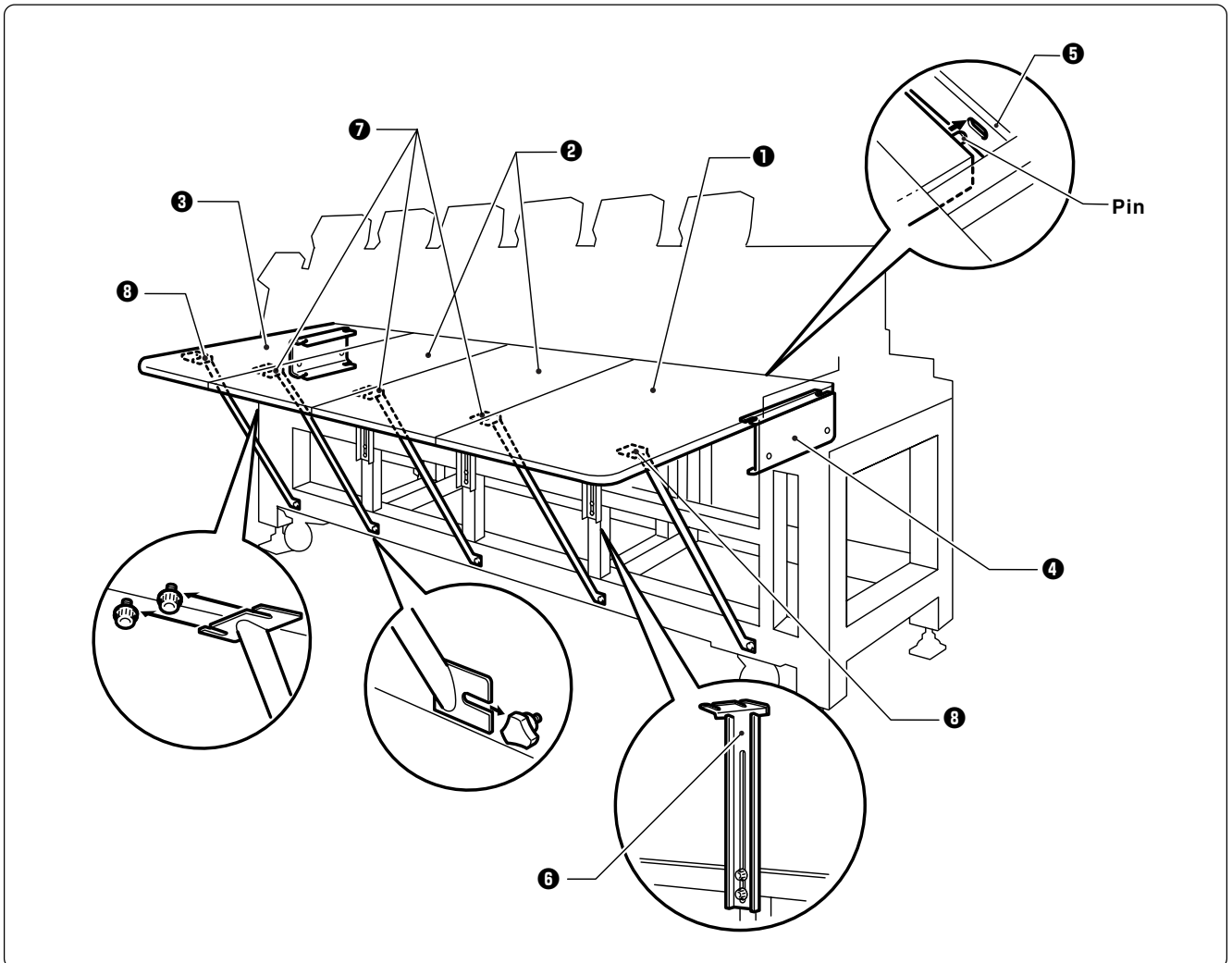

1. Attach four hexagon socket head cap screws to each of F table parts R ①, M (2 pcs) ②, and L ③ from the back.
2. Mount the F table parts from L ③ in order. Insert the bent part (upper) of F table guide UN ④ into the guide. Insert the F table rear pin into the hole of leg cover ⑤.
3. Adjust F table supports F ⑥ in height so as to make the F table lower than the bed top by 1 mm.
4. Tighten all hexagon socket head cap screws firmly.
5. Attach five thumb bolts to the lower front steel pipe of the leg section. Fasten the F table and the leg section using F table stays A (3 pcs) ⑦ and B (2 pcs) ⑧.

■ Procedure for embroidering with flat hoop/sash frame and every other head

Only the odd-numbered heads are operated for embroidering with flat hoop/sash frame. Embroidering is possible within an area up to 500 mm in the X-axis direction.

1. Set the needle bar case in the needle bar No. 1 position. Remove the presser feet.
2. Select a flat hoop (sash frame) for every other head operation.

2-5 Mounting of Cotton Stand

■ BES-962BC

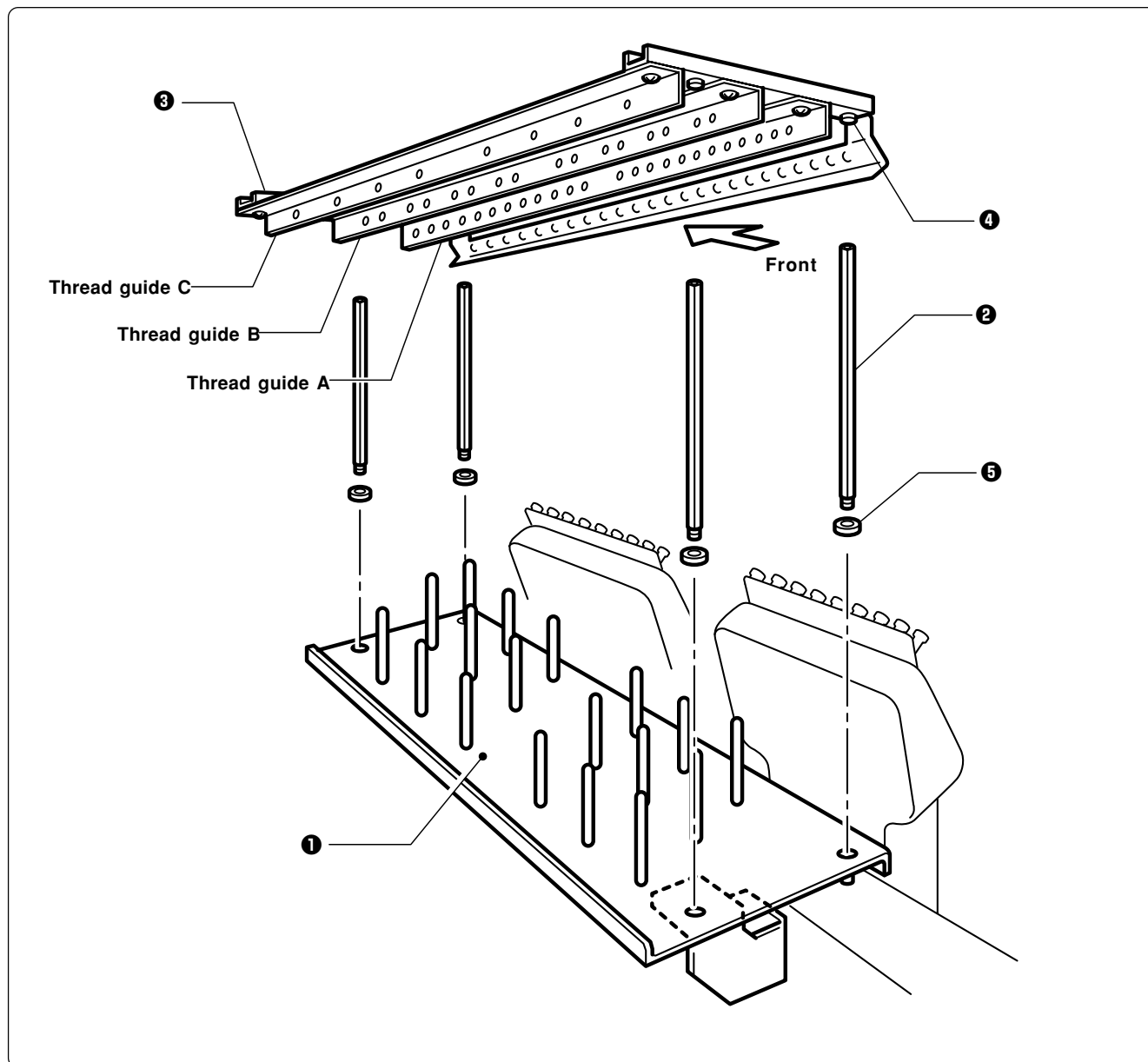

1. Attach four thread guide support bars ② to the cotton stand assembly ①, while fitting into the four holes.
2. Mount the thread guide assembly ③ on the thread guide support bars ② using the four screws ④.

Notes) • When mounting, use one flat washer ⑤ below the thread guide support bar ②.
 • Pay careful attention to the front and back directions of the thread guides (A, B, C).

■ BES-1262BC

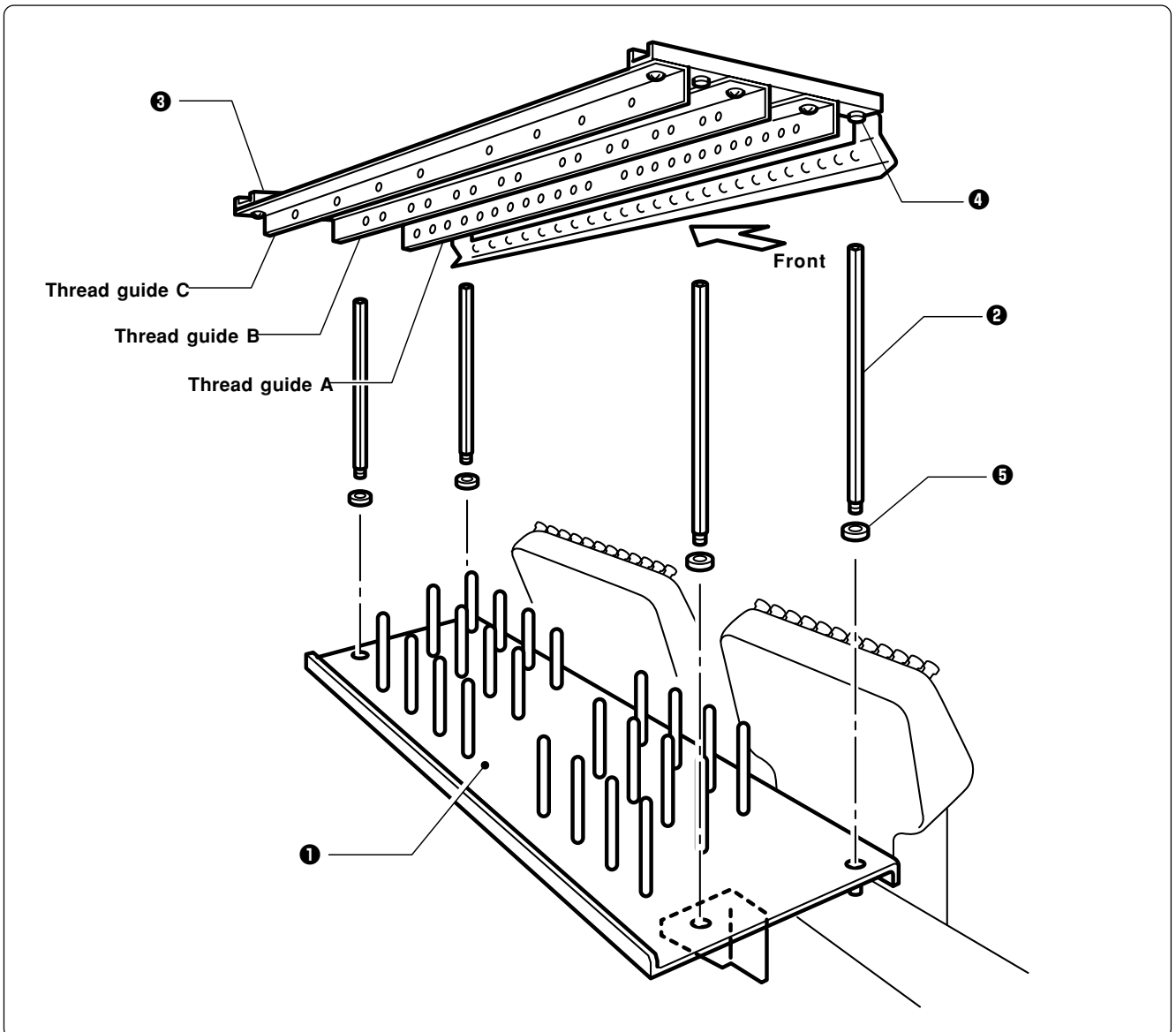

1. Attach four thread guide support bars ② to the cotton stand assembly ①, while fitting into the four holes.
2. Mount the thread guide assembly ③ on the thread guide support bars ② using the four screws ④.

Notes) • When mounting, use one flat washer ⑤ below the thread guide support bar ②.
 • Pay careful attention to the front and back directions of the thread guides (A, B, C).

2-6 Lubrication to Needle Bar Case

Proper lubrication is necessary for keeping the machine head in good condition.

CAUTION



Turn off the power switch before starting any cleaning work, otherwise the machine may operate if the start switch is pressed by mistake, which could result in injury.

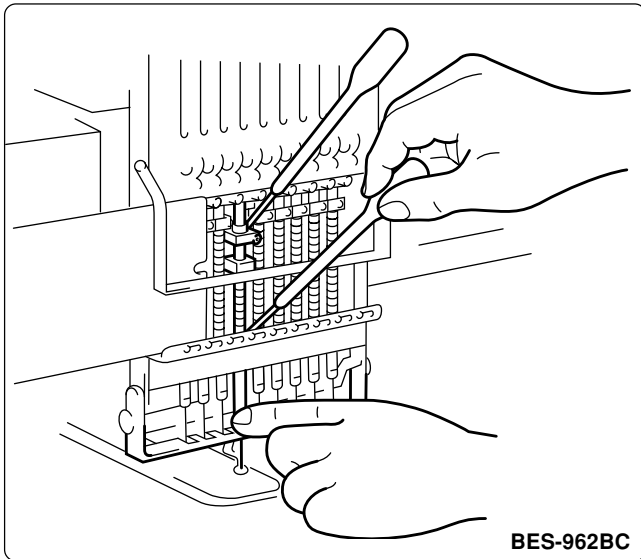

Before operating the machine for the first time after unpacking or after leaving the machine without operation for a long period of time, supply one or two drops of oil to two sections at the top and the bottom of each needle bar. (See the left figure.)

- Notes)
- Use the Brother's specified embroidery machine oil (Nisseki Embroidery Lube No. 10 or the equivalent).
 - Supplying an excessive amount of oil will cause dripping onto the material.

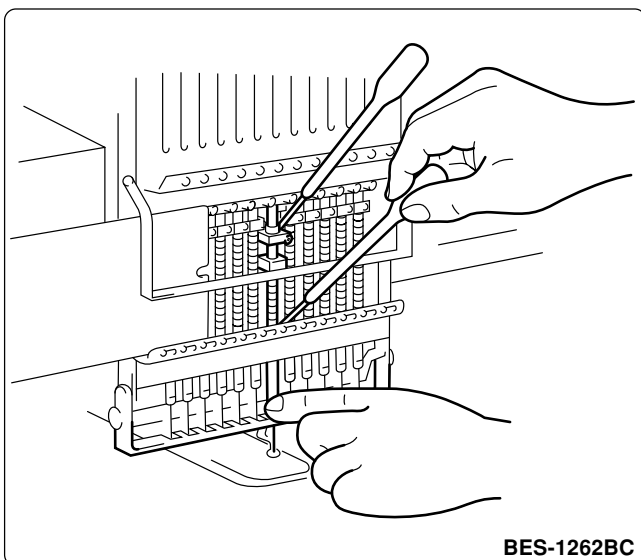

2-7 Connection of Personal Computer to Machines (for connecting 4 sets)

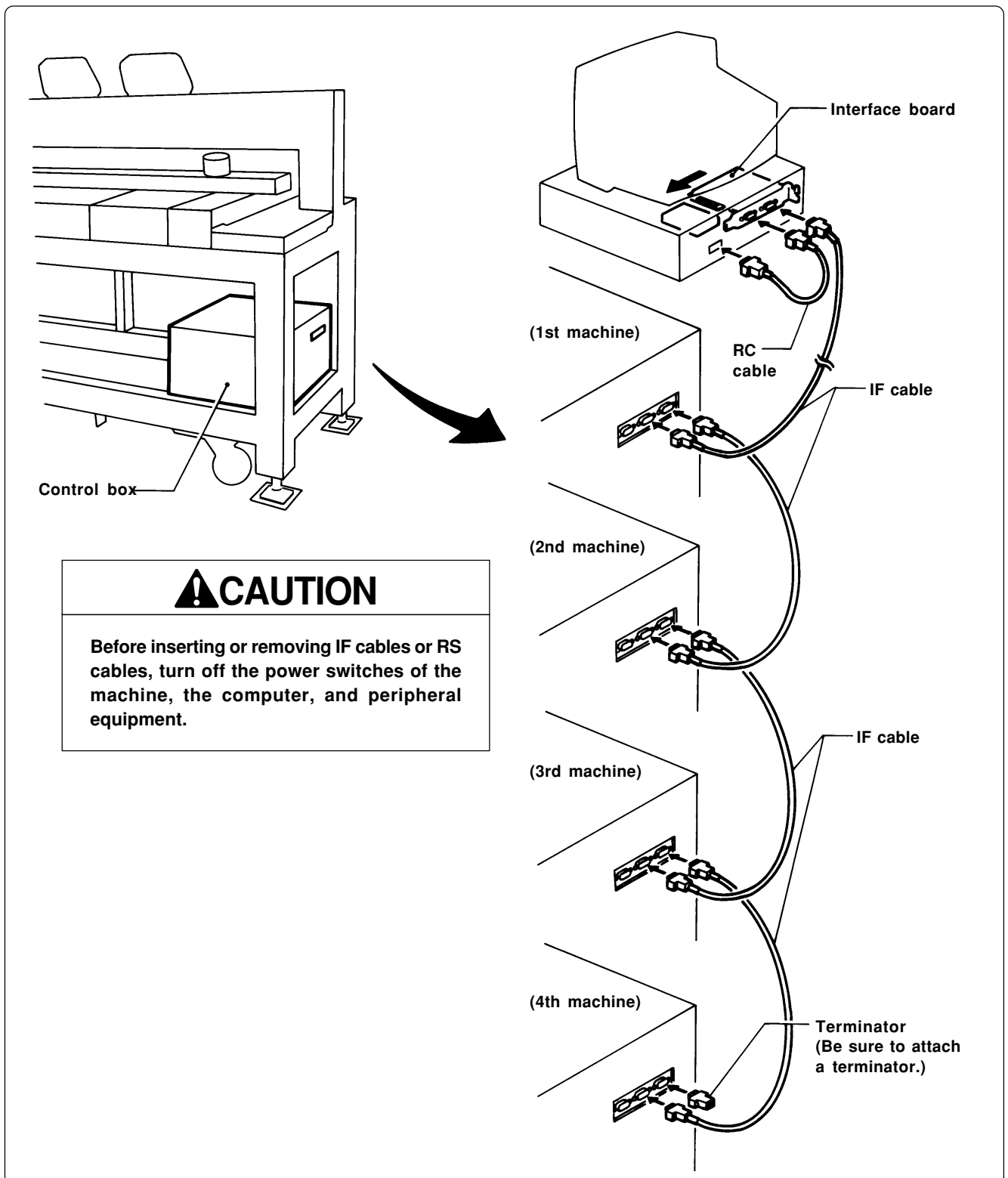

1. Turn off the power switch.
2. Open the cover of the personal computer and insert an interface board into the slot for the PCI bus.
3. Connect the interface board male connector and the personal computer RS-232C connector (COM1 or RS-232C-1) using the attached short RS cable.

4. Connect the interface board female connector and the control box connector SBUS1 of the first machine using an IF cable.

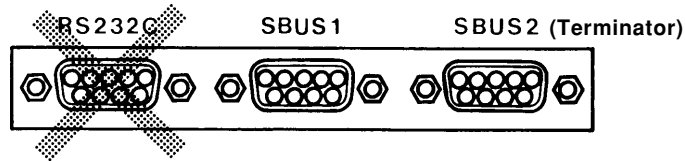

5. Connect the control box connector SBUS2 of the first machine and the control box connector SBUS1 of the second machine using an IF cable.
6. Connect the control box connector SBUS2 of the second machine and the control box connector SBUS1 of the third machine using an IF cable.
7. Connect the control box connector SBUS2 of the third machine and the control box connector SBUS1 of the fourth machine using an IF cable.
8. Attach a terminator to the control box connector SBUS2 of the fourth (last) machine.

- * The IF cables used for connection are identical. There is no difference between the two ends of the IF cable.
- * The order of connecting four machines is arbitrary.
- * The maximum number of connecting machines is four.
- * A terminator should be connected to the connector SBUS2 of the lastly connected machine. Connection to SBUS1, 2 can be interchangeable.
- * Do not connect anything to the RS-232C connector. Optional paper tape reader cannot be connected to this connector.

2-8 Connection of Power Supply

■ Uninterruptive power supply

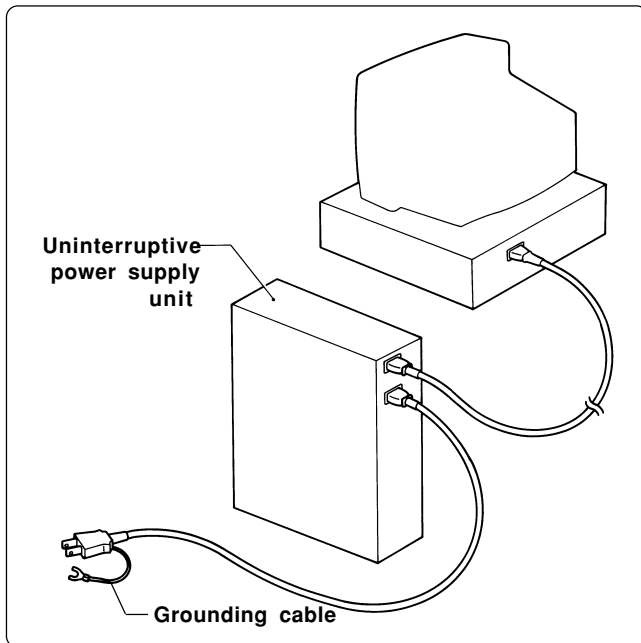

This unit is for protecting a personal computer from commercial power interruption, voltage drop, and external noise. Use of an uninterruptive power supply is strongly recommended.

Note) This unit is not an attachment of the Brother's embroidery machine, and should be purchased separately from a different source.

Note) When using an uninterruptive power supply, be sure to establish grounding.

■ Grounding

⚠ CAUTION



Turn off the power switch before starting preparation.

Failure to do so may start the machine unintentionally through an accidental activation of the START switch, resulting in bodily injuries.

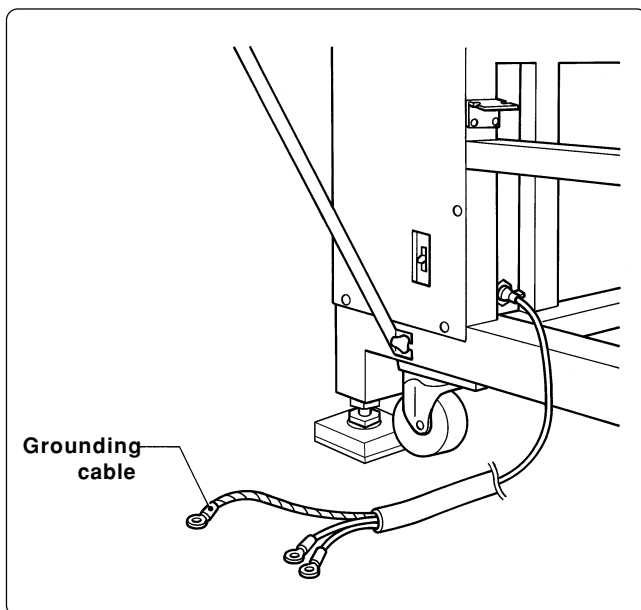

Notes) • When connecting the power supply, make sure to connect it to the grounding cable (with green and yellow stripes) .

• When plugging in the outlet, use a plug suited to the outlet.

2-9 Installation of Software

Use an attached CD-R for installing software. If a personal computer with no CD-R drive unit is used, connect a drive unit to the computer.

1. Set the CD-R for installation.

Setting the CD-R starts the installation program automatically.

2. Select the language and click "Next".

Note) When the software has already been installed, the following message appears.

[In case this application is already installed, please be sure to un-install it.]

Un-install the software.



3. The screen for user registration is displayed. Input your name and department. Click [OK] after inputting is finished.

4. Check the user information. Click [OK] if the contents are correct.

5. Specify a folder for setup.

6. Click [TO NEXT] to start installation.

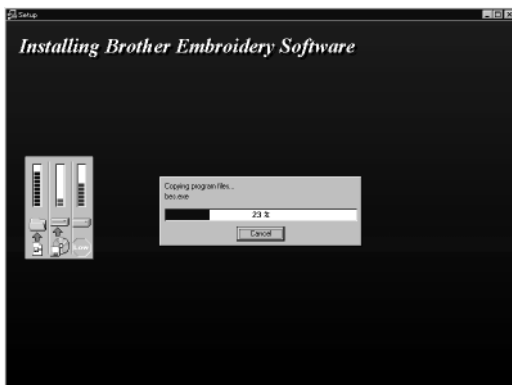

7. After setup is properly finished, a message is displayed.

8. Click [OK] to complete installation.

3. Preparation for Embroidering

⚠ CAUTION



Turn off the power switch before starting preparation.

Failure to do so may start the machine unintentionally through an accidental activation of the START switch, resulting in bodily injuries.

3-1 Upper Threading

■ BES-962BC

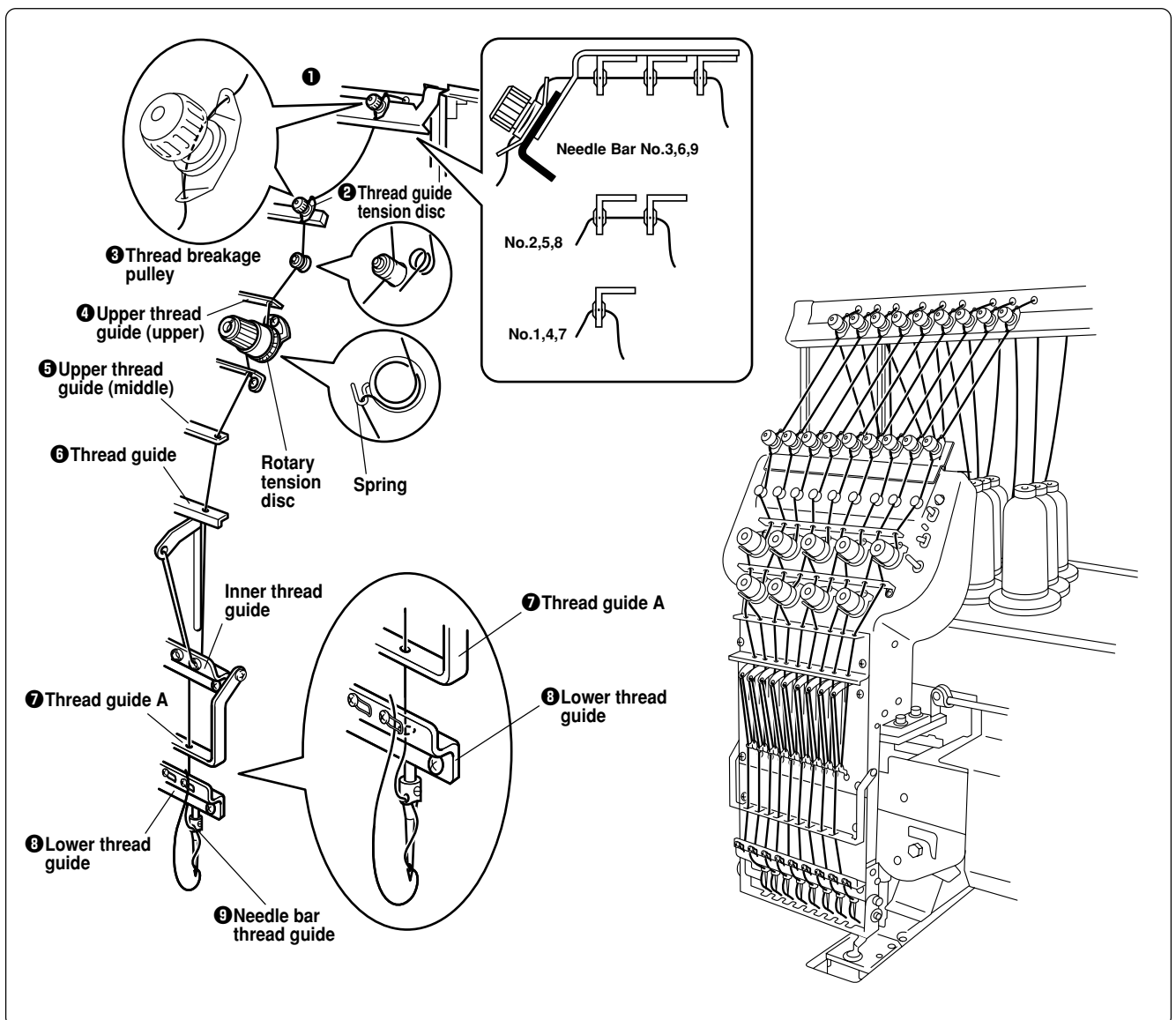

1. Pass an upper thread from the cotton stand through the hole of the thread guide right above each cotton stand bar. Pass the thread from the back to the front hole.
2. Pass the thread through the upper hole of the pretension. Push up the thread guide tension disc ② with your finger, and pass it from the left to the lower hole.

3. Pass the thread through the upper hole of the 2nd pretension. Push up the thread guide tension disc with your finger, and pass it from the left to the lower hole. Wind the thread clockwise twice around thread breakage pulley ③.
4. Pass the thread through the hole of upper thread guide(upper) ④. Wind the thread clockwise once around the rotary tension disc and place it on the spring.
5. Pass the thread through each hole of upper thread guide(middle) ⑤ and thread guide ⑥.
6. After passing the thread through the hole of thread guide ⑥, insert the thread into the right side of the inner thread guide and pass it through the hole of the thread take-up.
7. Bring the thread back to the inner thread guide. Insert the thread into the hole from the upper section into thread guide A ⑦.
8. Pass the thread through the hole of the needle bar thread guide ⑨ and pass it through the needle eye. Do not pass it through the presser foot. Pass it to presser spring at the front of lower thread guide ⑧.

■ BES-1262BC

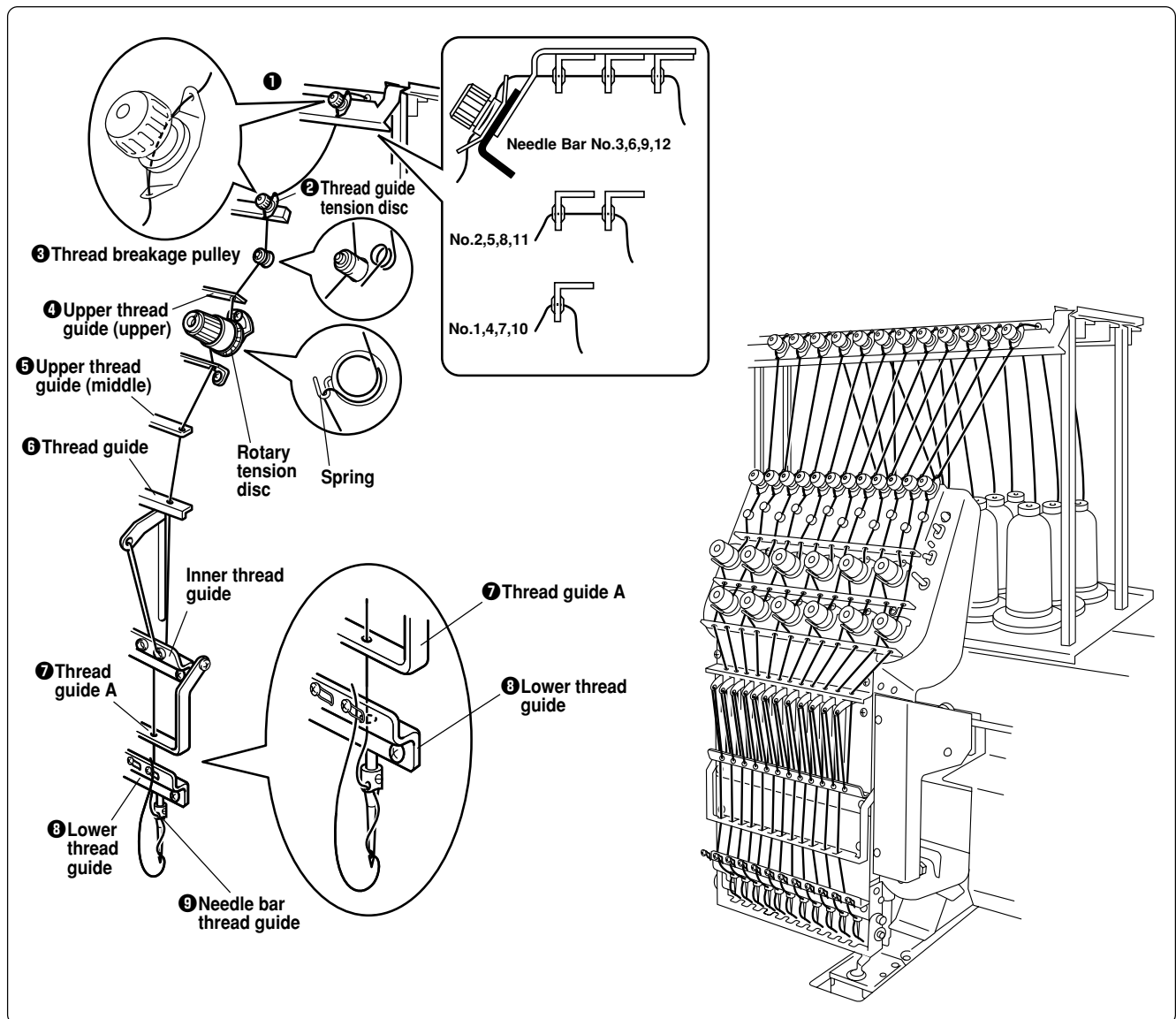

1. Pass an upper thread from the cotton stand through the hole of the thread guide right above each cotton stand bar. Pass the thread from the back to the front hole.

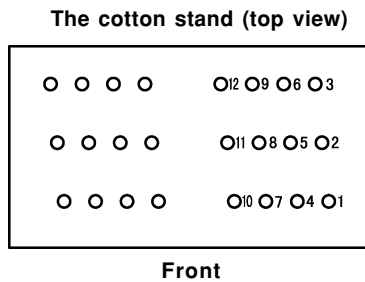

Pass a thread in the order indicated in the figure.

2. Pass the thread through the upper hole of the pretension. Push up the thread guide tension disc ❷ with your finger, and pass it from the left to the lower hole.
3. Pass the thread through the upper hole of the 2nd pretension. Push up the thread guide tension disc with your finger, and pass it from the left to the lower hole. Wind the thread clockwise twice around thread breakage pulley ❸.
4. Pass the thread through the hole of upper thread guide(upper) ❹. Wind the thread clockwise once around the rotary tension disc and place it on the spring.
5. Pass the thread through each hole of upper thread guide(middle) ❺ and thread guide ❻.
6. After passing the thread through the hole of thread guide 6, insert the thread into the right side of the inner thread guide and pass it through the hole of the thread take-up.
7. Bring the thread back to the inner thread guide. Insert the thread into the hole from the upper section into thread guide A ❼.
8. Pass the thread through the hole of the needle bar thread guide ❽ and pass it through the needle eye. Do not pass it through the presser foot. Pass it to presser spring at the front of lower thread guide ❾.

3-2 Replacement of Bobbin

Note) Remove dust, lint and oil from the bobbin case before replacement.

■ Removing bobbin case

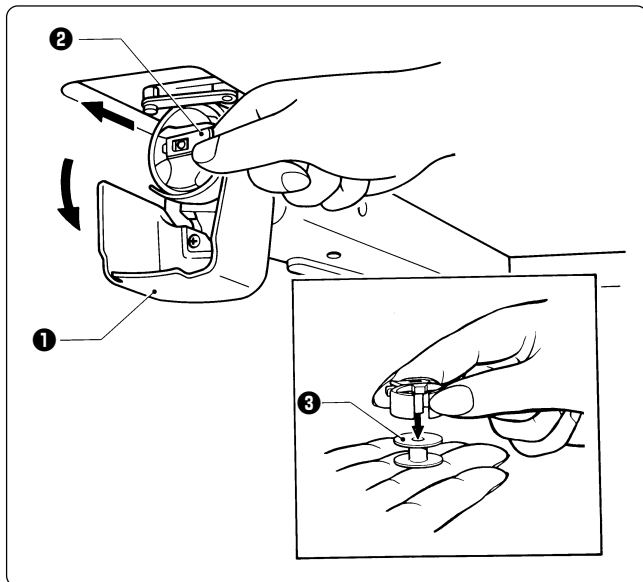

1. Open the rotary hook cover B ①.
2. Hold the knob ② and take out the bobbin case.
3. Close the knob and take out the bobbin ③.

■ Replacing bobbin

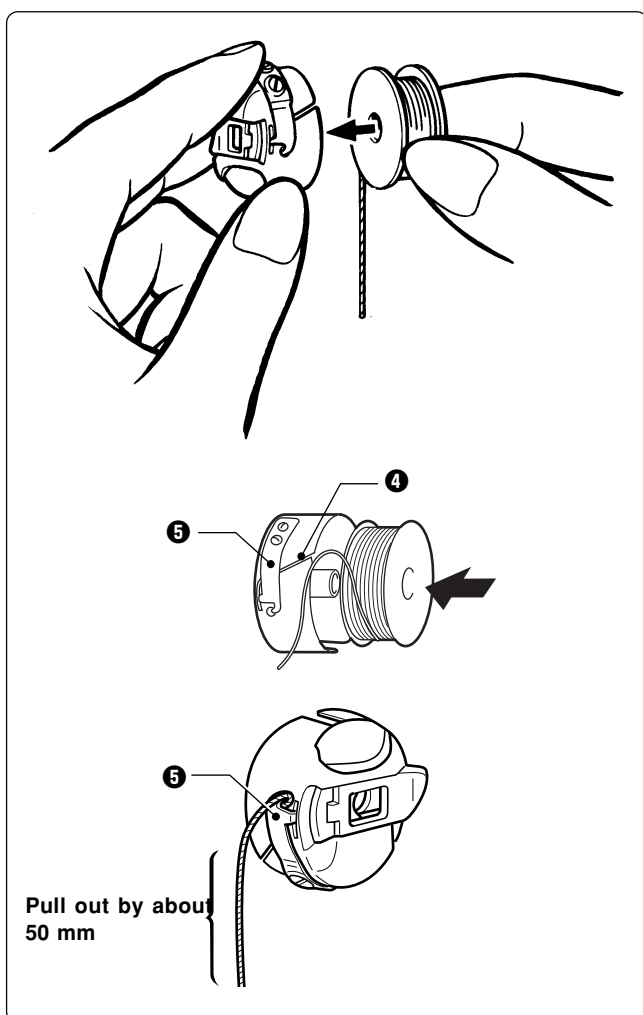

1. Put a new bobbin in the bobbin case.

Check the winding direction.

Check that the bobbin is pushed out of the bobbin case by about 0.5 mm. If not, the slip prevention spring of the bobbin case does not work. Adjust the height of the spring or replace it with a new one.

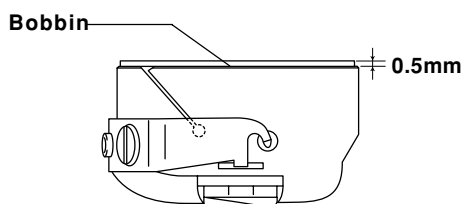

2. Slide the thread under the tension spring ⑤ through the notch ④.
3. Pull out the thread from the hole of the tension spring ⑤.
4. Pull out the thread by about 50 mm.

■ Attaching bobbin case

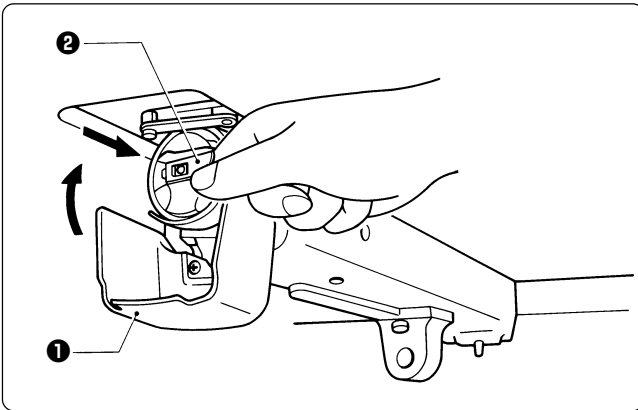

1. Hold the knob ② and attach the bobbin case securely.
2. Close the rotary hook cover B ①.

3-3 Replacing and Selecting Needle

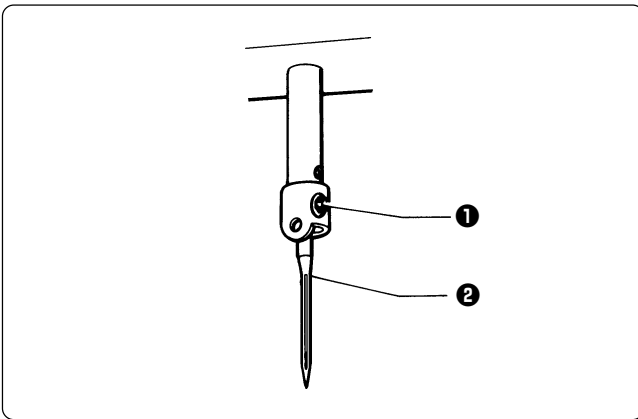

■ Removing needle

Loosen the set screw ① and remove the needle ②.

■ Attaching needle

With the flat side facing the front, insert the needle all the way until it meets the end of the needle bar. Tighten the set screw ① firmly.

- Note)
- Set the needle so that the notched part will come on the rotary hook side.
 - The needle should not be angled to the left (when viewed from the front).

* Relationship between materials and needles

Material	Needle	Needle thickness
Denim Leather	DB x K5	#14, #16, #18
Handkerchief		#9, #10
Shirt Towel		#11, #12, #13

■ Selecting needle

- When using special threads such as gold, silver, and rame yarn, use a heavy-duty needle (#11 ~ #16). For better finish, paste the waxed paper on the back of the material.
- In general, use DBxK5 #11 ~ #18 according to the material thickness. For knitted materials, use DBxK23 #11 because its rounded point prevents the knit thread from breaking.

3-4 Attachment of Embroidery Hoop and Frame

■ Tubular square hoop

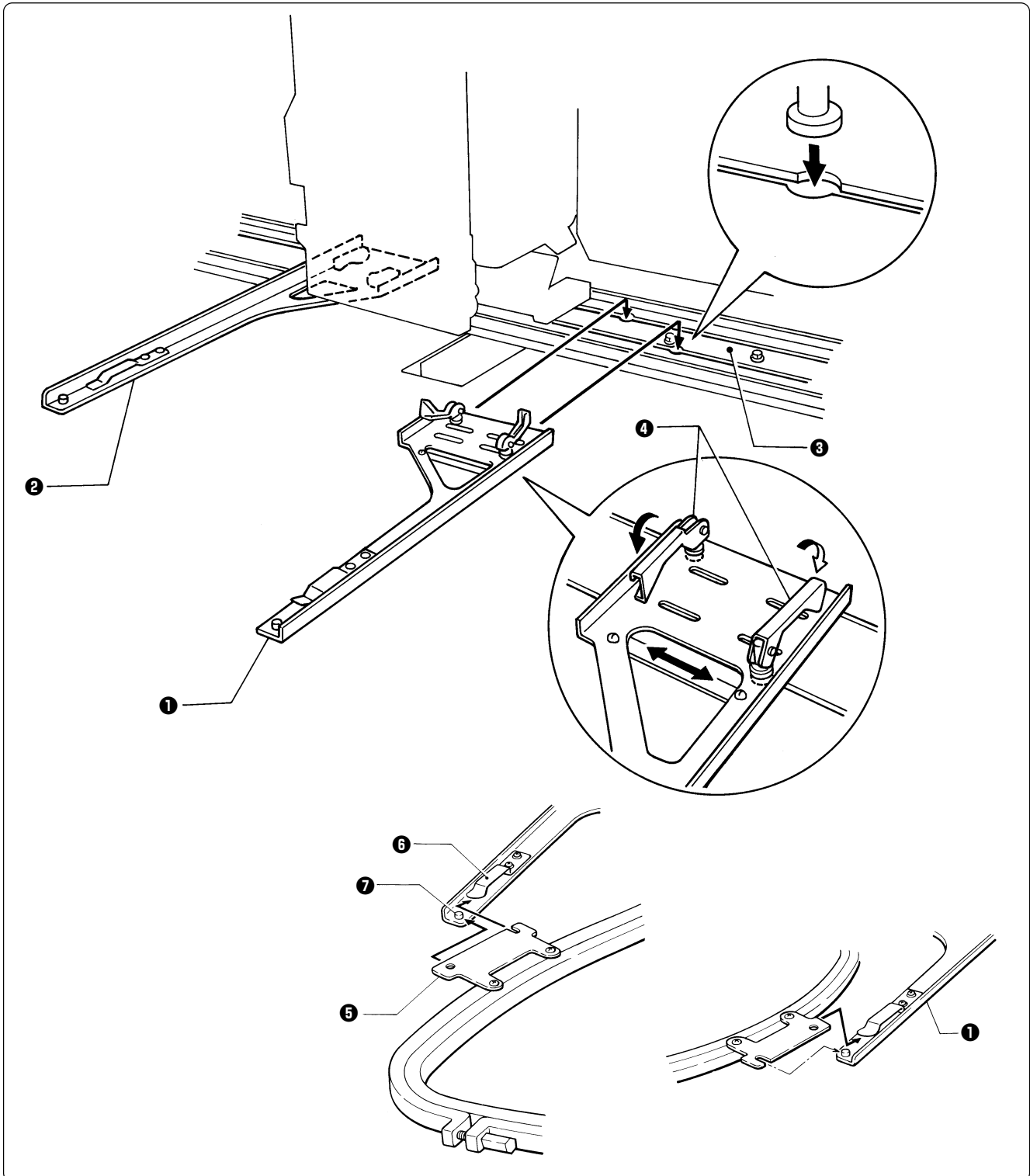

1. Insert the fixing pins of the tubular round arms R ① and L ② into the notches of the X-axis feed frame ③. Slide the arm to the right and left and lower the fixing lever ④ to fix them.
2. Set the right and left fixtures of the tubular square hoop ⑤ while sliding them under the flat spring ⑥ upward. Then fit the frame projecting part ⑦ into the hole of the tubular square hoop ⑤ securely.

- By changing the tubular round arm mounting width, various sizes can be set.

Note) Change the width, referring to the pin position.

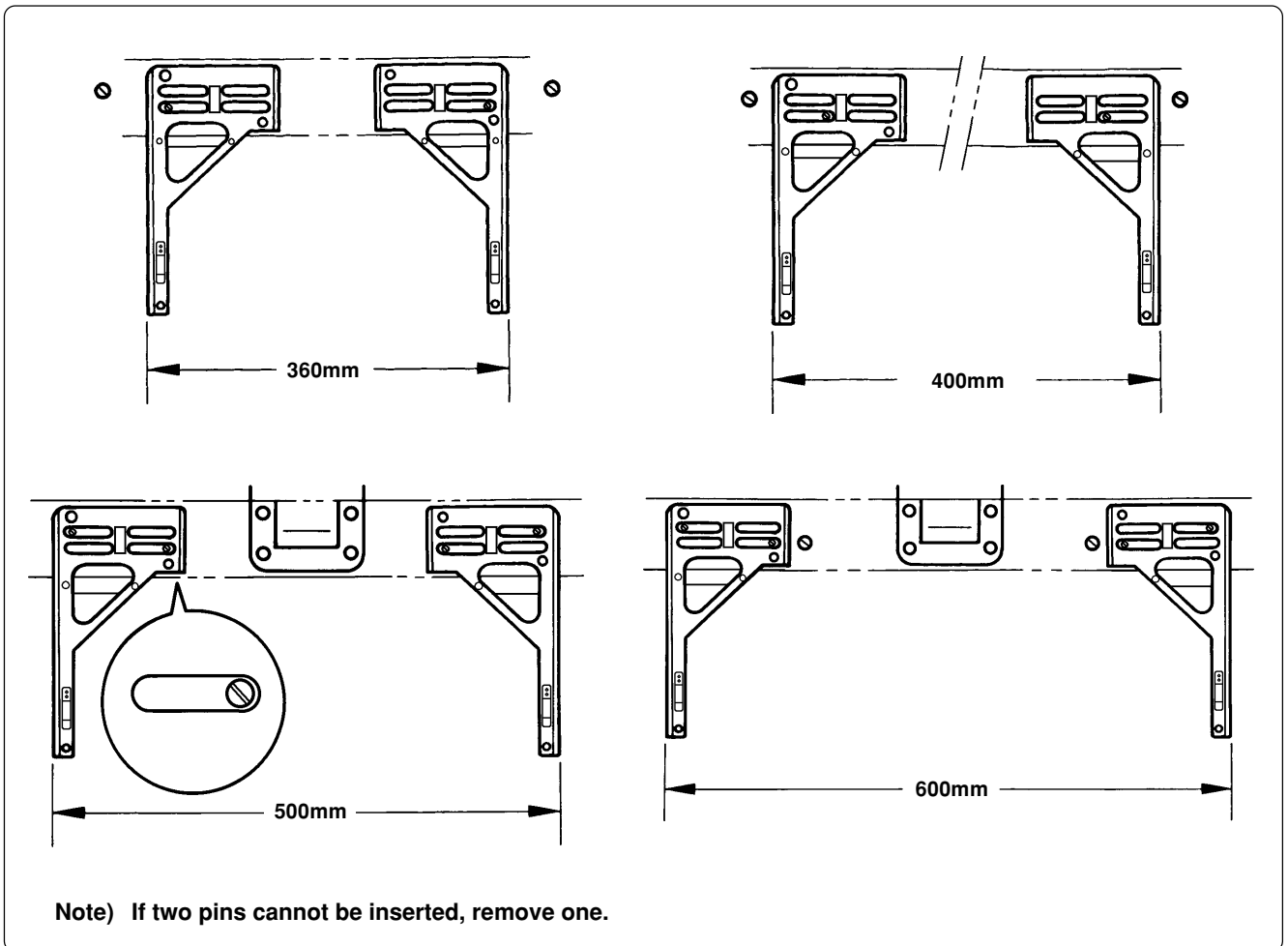

- If a tubular round arm has a backlash:
Follow these steps for adjustment:

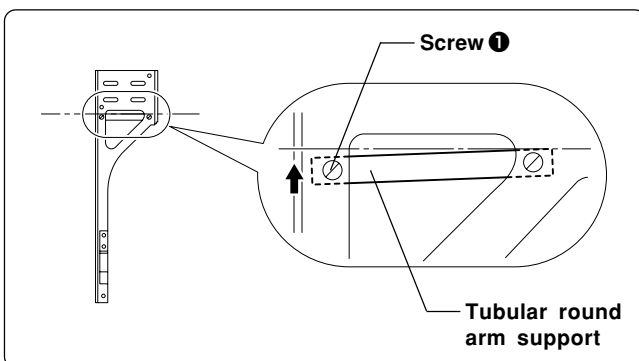

1. Move the end of the tubular round arm to the left.
 2. If a clearance is left as shown in the figure, loosen screw ❶ and adjust the tubular round arm support so as to eliminate the clearance between the support and the X-feed frame. Tighten screw ❶.
- * Follow the same steps when moving the end face of a tubular round arm to the right.

- If tubular round arms are not in a horizontal position:
Follow these steps for adjustment:

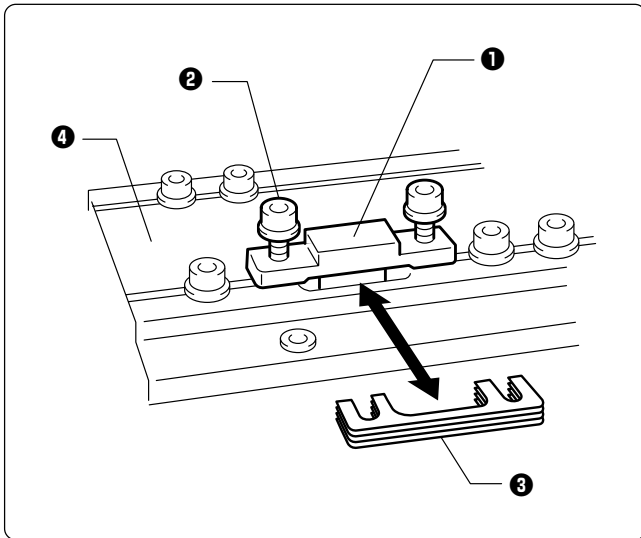

If the tubular round arms cannot be set in a horizontal position (inclined) because of the weight of fabrics, make an adjustment using roller spacers in the following steps. (Four roller spacers are inserted before shipment.)

1. Loosen bolts ② of X roller base ① and remove roller spacers ③.
2. Insert a proper number of roller spacers ③ between X roller base ① and X-feed frame N ④. Tighten bolts ②.

Note) When tightening bolts ②, press X roller base ① against X-feed frame N ④ and leave no backlash in between.

3. For the other roller spacers, follow the above steps.

Note) Use the same number of roller spacers in every position.

■ Holder base (optional)

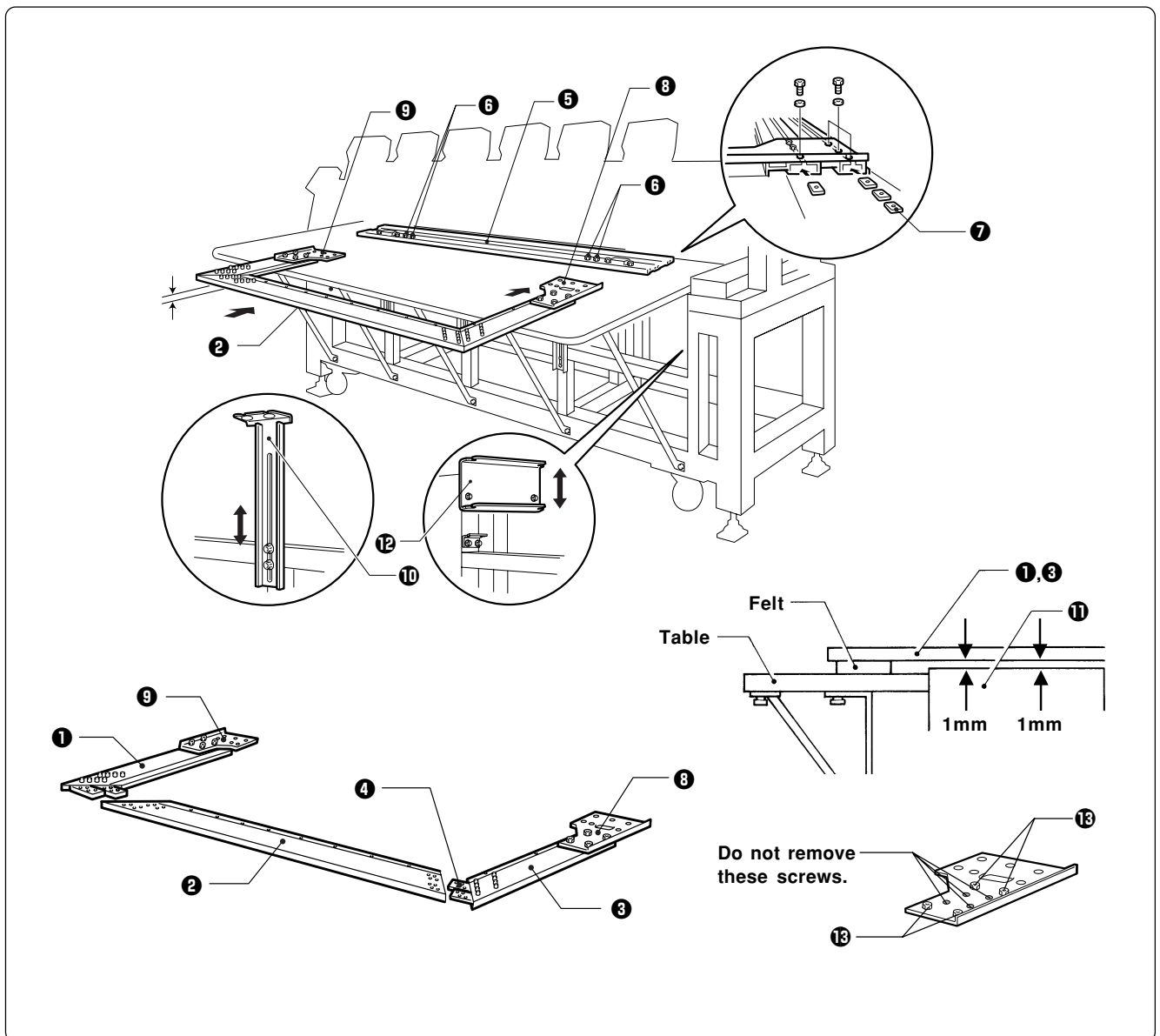

Attaching the holder base frame

1. Set the table. (Refer to "2-4 Mounting of Table" (Page 32) for details.)
2. Insert the frame connecting plate F ④ into the holder base frame LN ①, holder base frame CN ②, and holder base frame RN ③, using bolts and washers.
3. Remove four bolts ⑥ from the front of X-feed frame ⑤. Attach one each of square nut M6 ⑦ to the right and left sides at the front.
At the rear of the frame, attach three each of square nuts M6 ⑦ to the right and left sides.
4. Put frame connecting plates RN ⑧ and LN ⑨ on X-feed frame ⑤. Fix them with bolts and washers.
5. Check that the clearance between the table and the mounted holder base frame C assembly ② is even when viewed from the machine front.
[Adjustment] Loosen three bolts of the F table support F ⑩ and move it in the direction of the arrow for adjustment.

6. Check that the clearance between the Y-axis cover ⑪ and the mounted holder base frames LN ① and RN ③ is even when viewed from the right and left sides.

[Adjustment] Loosen the right and left bolts of the F table guide UN ⑫ and move it in the direction of arrow for adjustment.

7. Tighten each bolt securely after adjustment is finished.
8. If removing a holder base frame for frame replacement, etc., remove screw ⑬.

Keep the frame connecting plate attached to the X-feed frame.

Attaching the holder base

1. Mount the holder base mounting frame ③ on the X-axis feed frame ① and holder base frame C ②, using three clamp screws.
2. When the mounting pitch of the holder base is 370 mm, mount the holder base horizontally to the holder base mounting frames ③ using the thumb bolts ④.

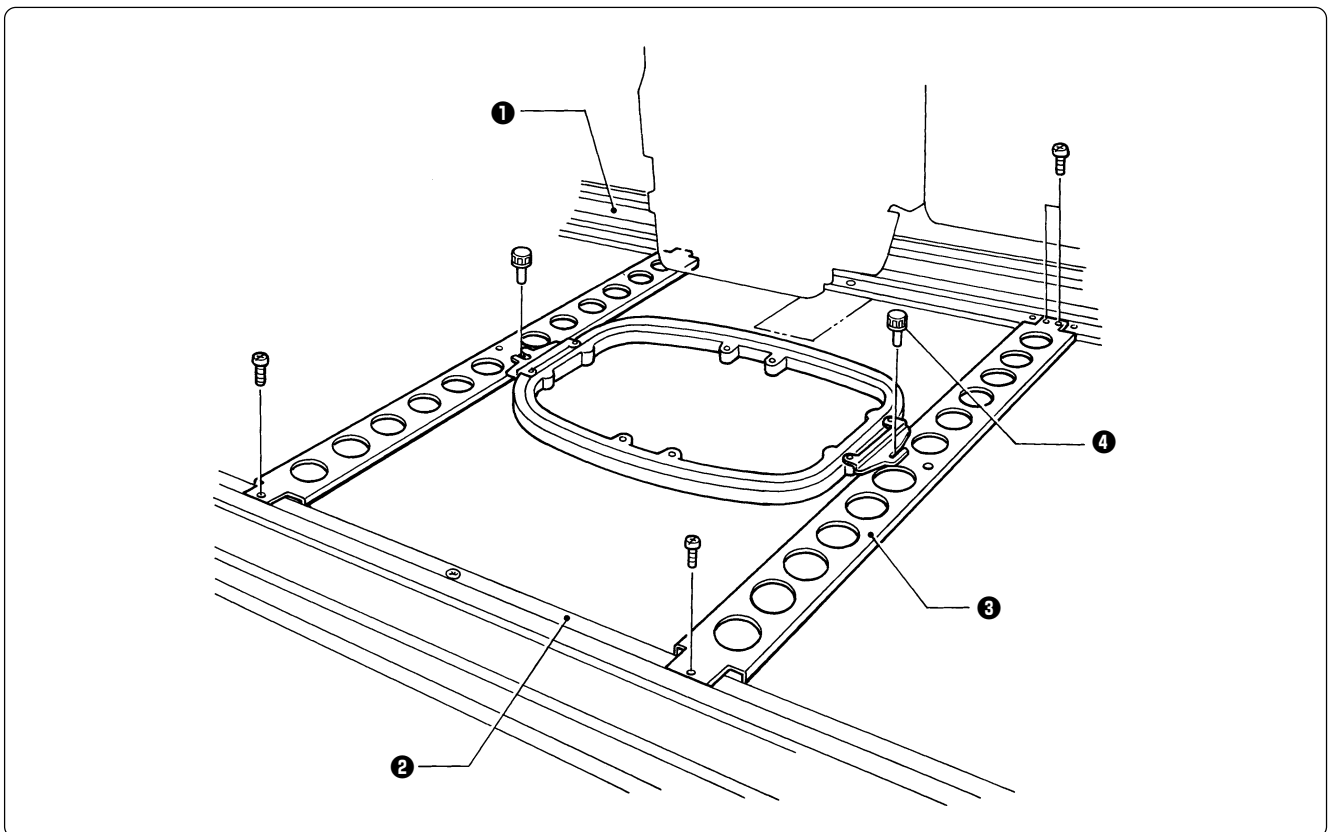

3. When the mounting pitch of the holder base is 550 mm, mount the holder base vertically to the X-axis feed frame ① and holder base frame C ② using the thumb bolts ④.

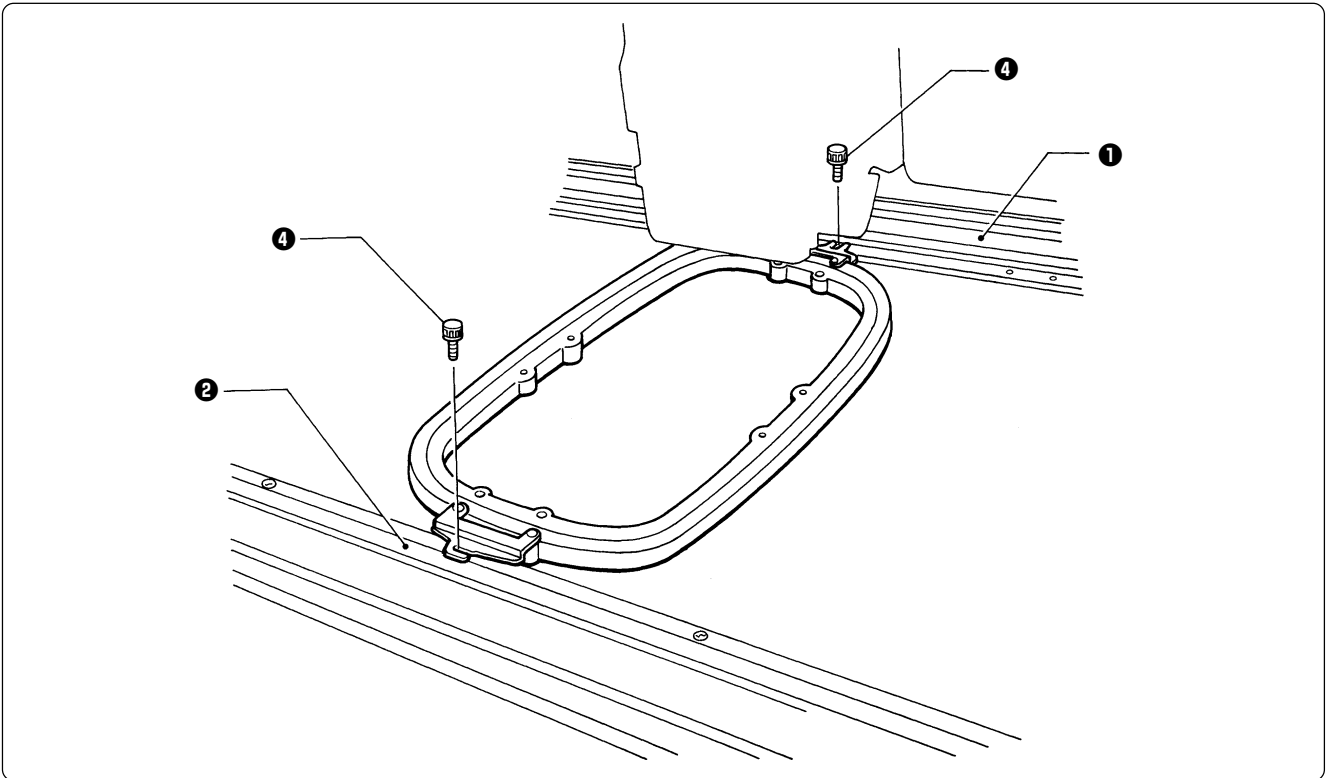

■ Sash frame (optional)

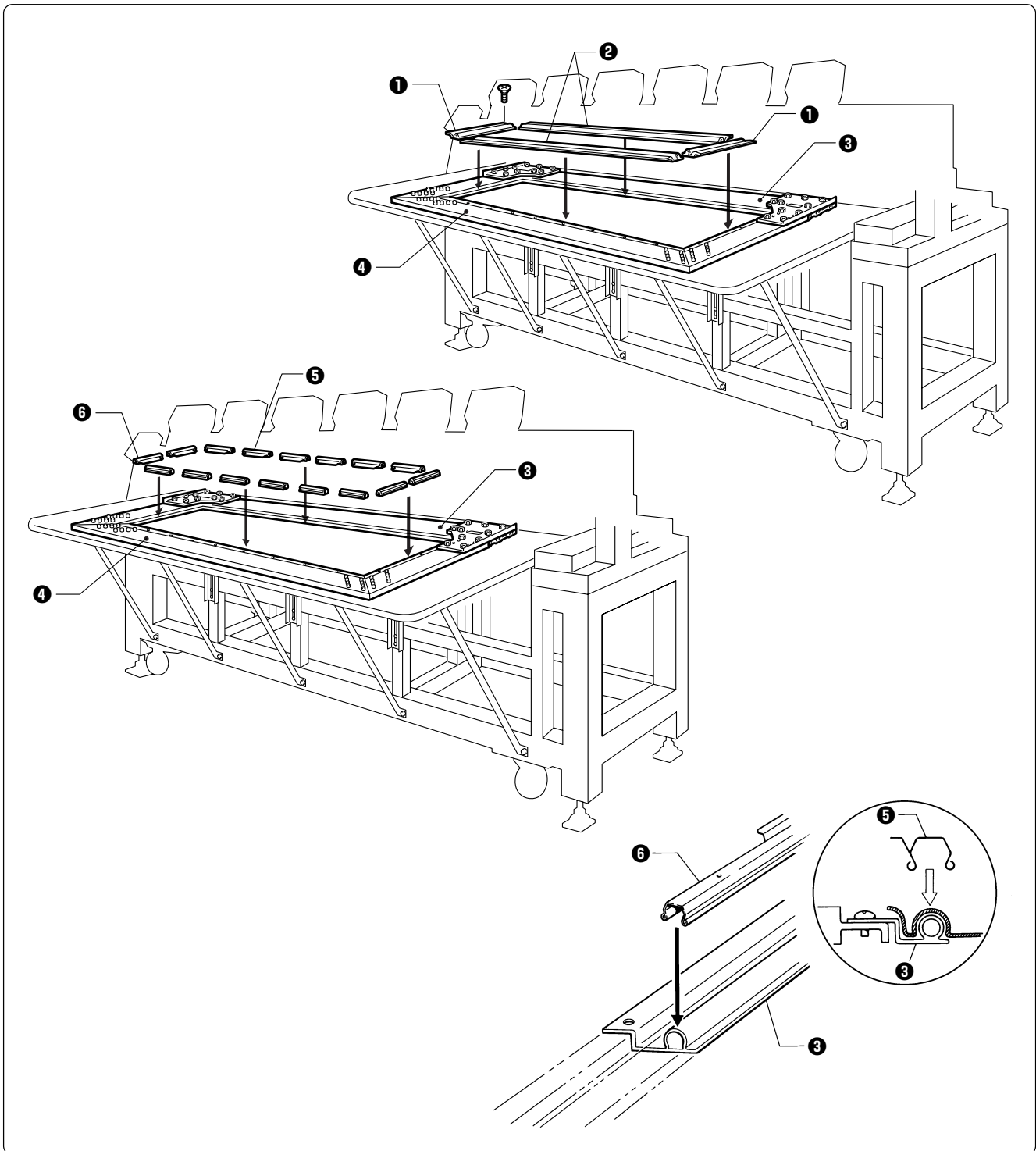

Attaching the sash frame

1. Set the table. (Refer to "2-4 Mounting of Table" (Page 32) for details.)
2. Mount two vertical sash frames ① on the holder base frames L and R, and two horizontal sash frames ② on the X-axis feed frame ③ and the holder base frame C ④, using the screws.
3. Set the material. Then, set sixteen sash clips 290 ⑤ horizontally on the upper and lower sides, four sash clips 220 ⑥ vertically on the left and right sides.

3-5 Adjustment of Thread Tension

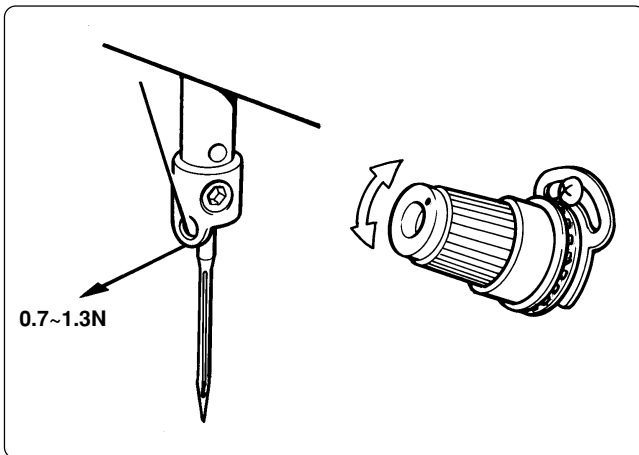

■ Adjustment of upper thread

Adjust upper thread tension to 0.7~1.3N when the thread is pulled at the needle bar thread guide.

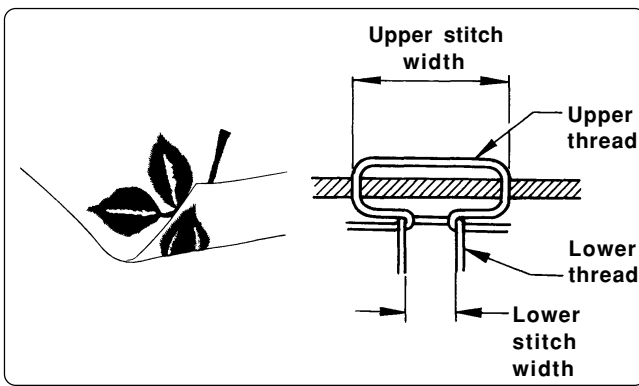

* Correct adjustment

Turn the upper thread tension dial so that the needle thread can be pulled to the back of the material and that the lower stitch width will be about 1/3 of the upper stitch width.

■ Adjustment of tension spring

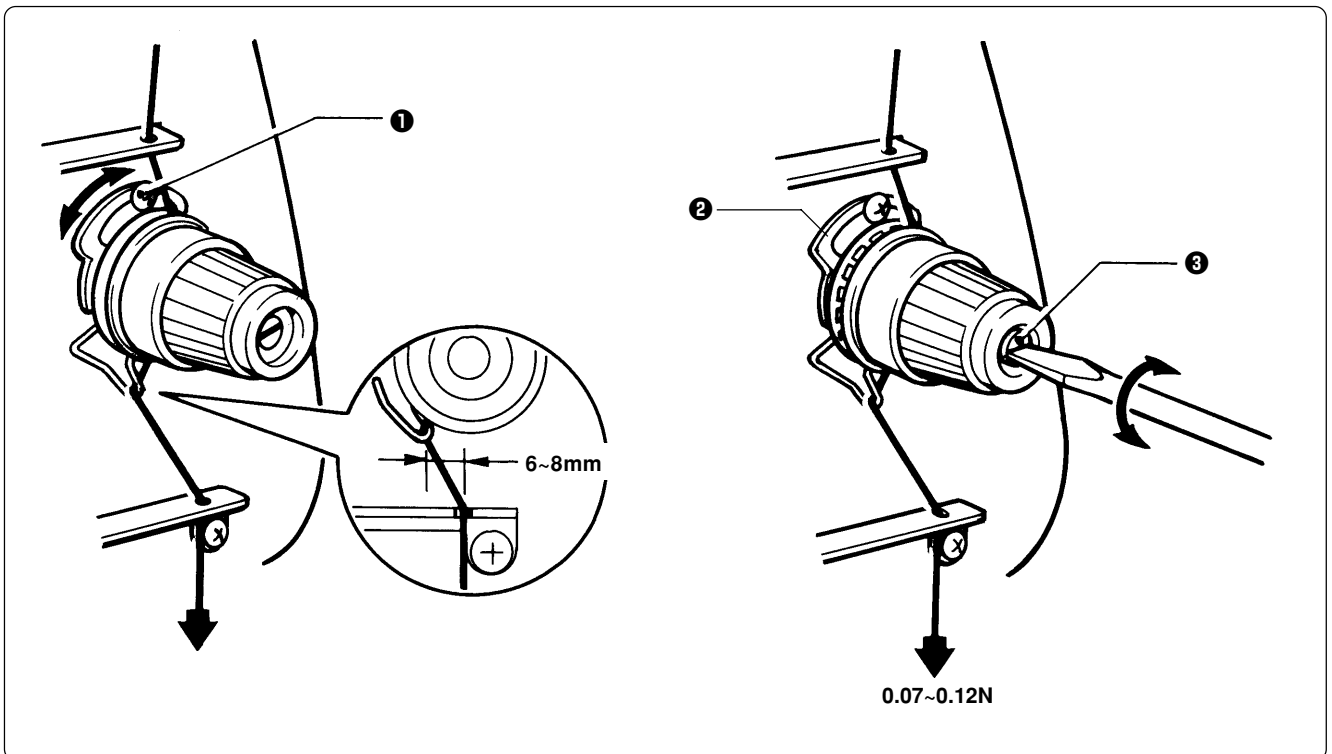

1. The tension spring should be adjusted to 6~8 mm in height and 0.07~0.12 N in force.

2. For adjusting the height, loosen the screw ❶ and turn the tension spring bracket ❷.
3. For adjusting the tension spring force, insert a driver tip in the groove of the thread tension bar ❸ and turn it.

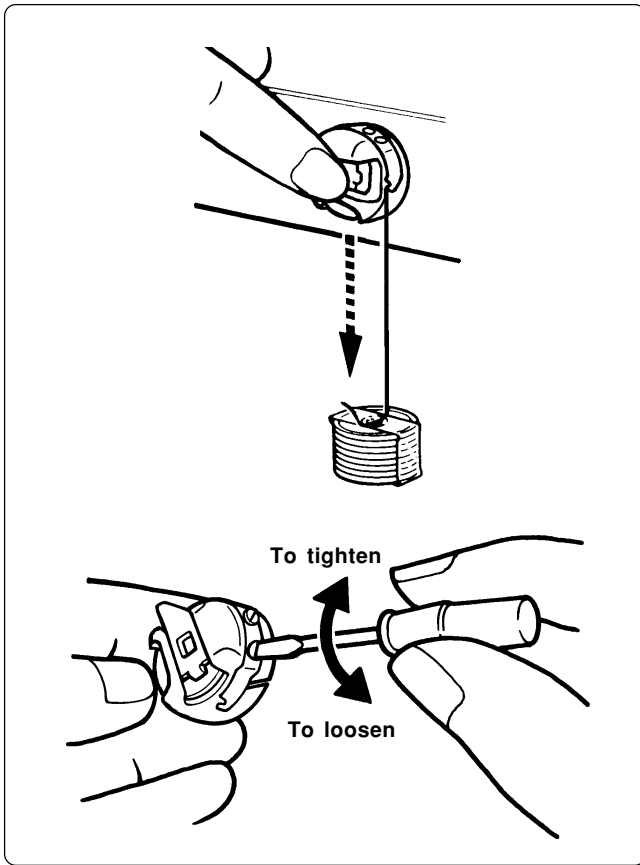

■ Lower thread tension

The standard tension of the lower thread is 0.15~ 0.3N.

This tension may vary depending on the used thread. In general, press the bobbin case to a smooth vertical surface and hang the designated number of coins. Turn the thread tension screw so that the lower thread will come out smoothly.

Note) Check that the bobbin is pushed out of the bobbin case by about 0.5 mm. If not, the slip prevention spring of the bobbin case does not work. Adjust the spring in height or replace it with a new one. (Refer to “Replacing Bobbin” on page 46.)



Chapter 3

Embroidering Procedures

After installation of machine and setting-up of the personal computer (PC), start embroidering. This chapter explains about the operation panel on the machine as well as precautions for the actual embroidering process.

Functions of Operation Panel

Operation Panel

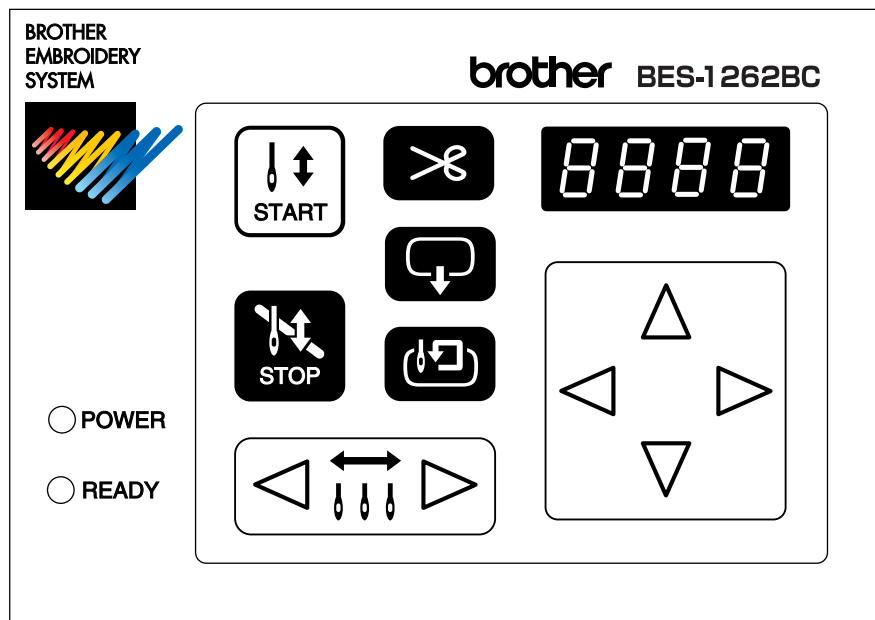

Starts embroidering.

Restarts after moving the carriage to embroidering start position by using the jog switch.

Restarts embroidering after a suspension.



Cancels errors during embroidering.

Exits from the embroidering mode. Hold down switch and press  switch.

Suspends embroidering.



Trims thread during suspension.



Checks the embroidering area.

Exits from embroidering mode. Press this switch while holding down  switch simultaneously to stop embroidering.

Moves the hoop automatically when embroidering position is out of the embroidering area.

Sets the machine to the inching mode when this switch is pressed during suspension.



Moves the hoop to software-set position. When this switch is pressed again, the hoop returns to the previous position.

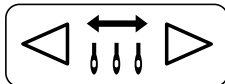

Moves the needle bar. The needle moves by the diameter every time this switch is pressed.

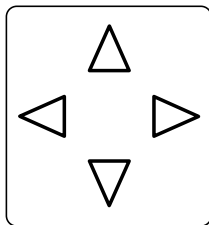

Moves the hoop.

Step-back or forward is available during suspension, by one stitch every time the switch is pressed (Use \triangleleft \triangleright switches only.)

Changes the speed range during embroidering (Use \triangle ∇ switches only).

Carries out inching of the hoop when the switch is pressed in the inching mode ( appears on the panel).

■ Canceling errors

When an error message appears, it is canceled by pressing  switch.

Pressing other switches can stop alarm sound.

When thread breakage or wiper out error has occurred, step-back or forward switch can be used to cancel errors.

Switches at Machine Heads

BES-962BC

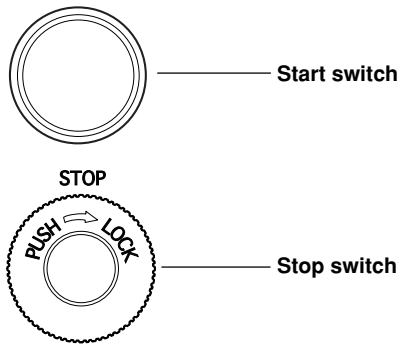

BES-1262BC

Between head No.1 and No.2
 Between head No.3 and No.4
 Between head No.5 and No.6

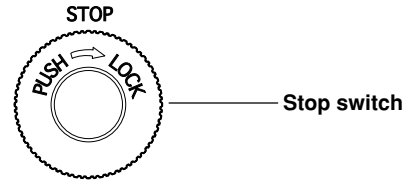

Between head No.2 and No.3
 Between head No.4 and No.5

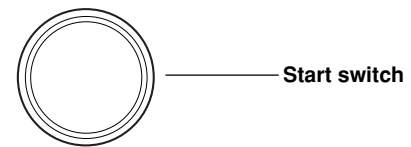

■ Stop switch

Stops embroidering operation. When embroidering is stopped, STOP flashes. Refer to "Resetting Machine Stop" (→ page 191) to stop flashing.

■ Start switch

Starts embroidering. Holding down this button executes embroidering at a low speed. When resuming embroidering after stop switch, release machine stop before pressing this button. Refer to "Resetting Machine Stop" (→ page 191) for details.

Switches on Tension Plate

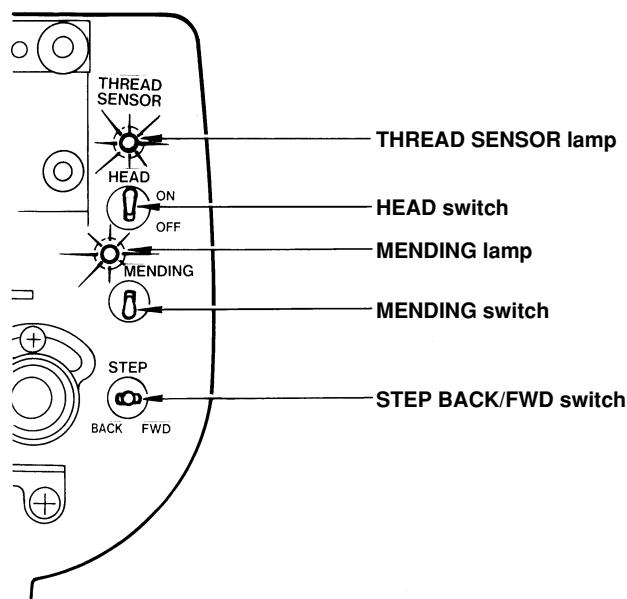

■ THREAD SENSOR lamp

When red light is on, thread breakage sensor is functioning. When the light is off, the sensor is not effective. When the embroidery machine stops due to thread breakage, the lamp flashes.

■ HEAD switch

When it is set to ON, needle bar on the head moves for embroidering. When it is set to OFF, the needle bar does not move for embroidering.

■ MENDING lamp

This lamp lights up when the embroidery machine is in the mending mode.

■ MENDING switch

This switch is set to ON to drive or to suspend the machine head during embroidering for a designated period of time.

■ STEP BACK/FWD switch

When it is turned to BACK, the machine steps back. When it is turned to FWD, the machine steps forward. If you keep the switch turned for a while, the machine will continue stepping even after you let the switch alone. When it is turned to the opposite side, the machine stops.

During timing adjustment of the rotary hook in the test mode, the rotary hook slightly rotates to the left/right when this switch is turned to left/right respectively. Refer to "Adjustment of timing Between Needle and Rotary Hook" (→ page 238) for further details.

Flowchart of Preparation for Embroidering

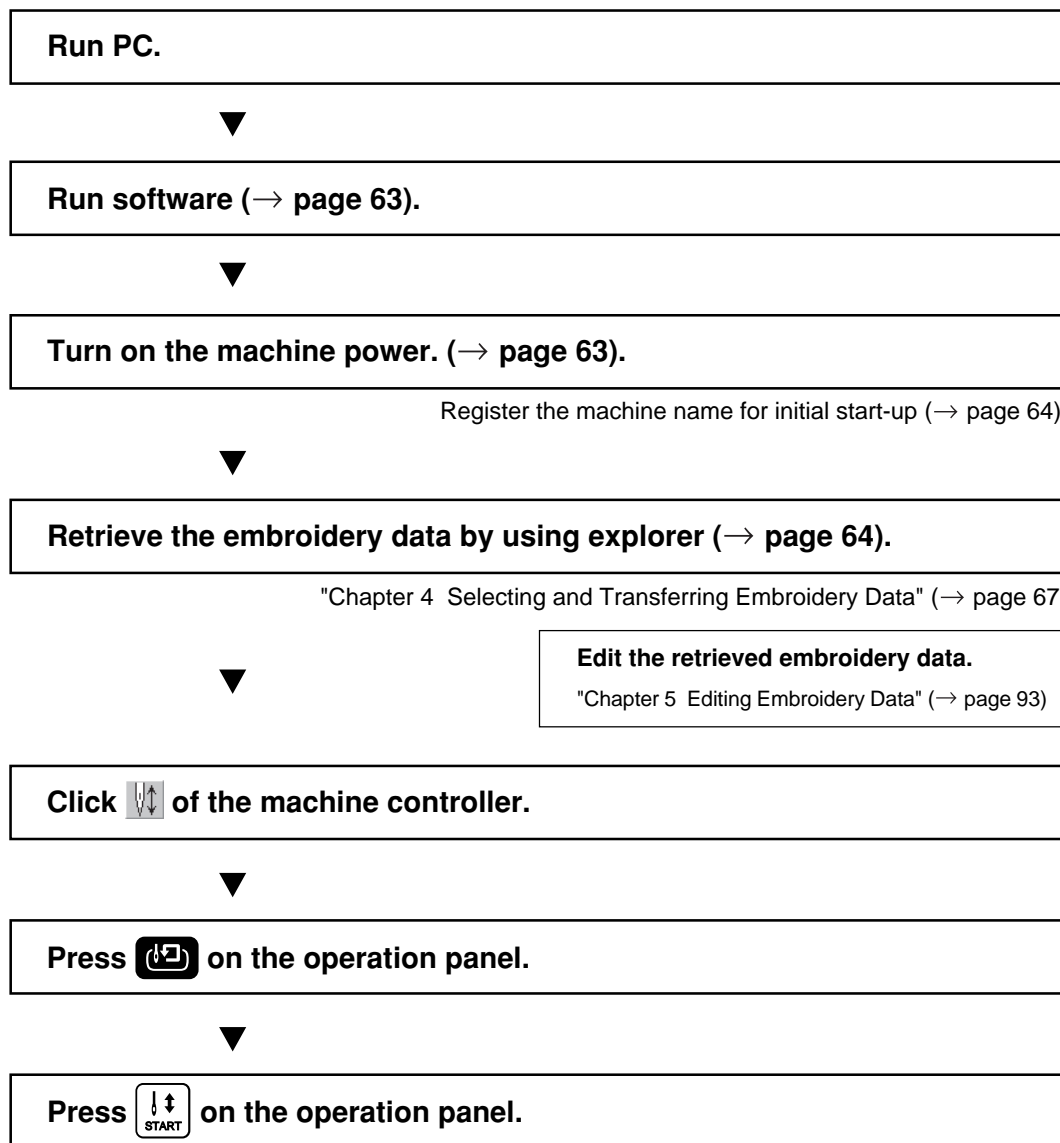

Run the Software

1. Select [Program] - [Brother Embroidery System] - [Ecs] from the Start menu.

The software starts up.

Turn on the Machine Power

1. Turn on the power to the machine.

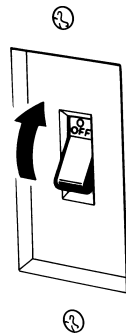

2. Reset the emergency stop button.

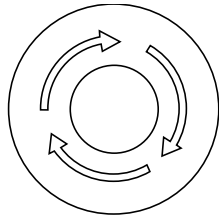

3. Turn on the power switch.

4. The computer screen changes when the machine is turned on.

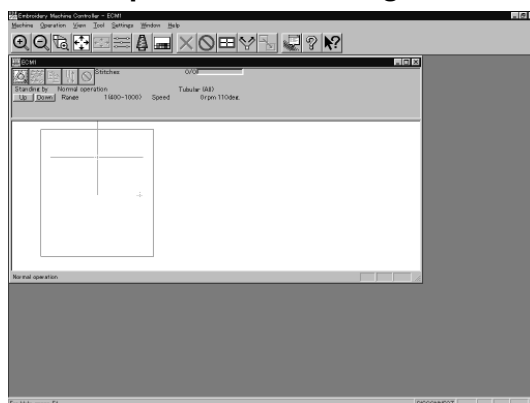

Register the Machine Name

Enter the machine name if the software is run for the first time or when a new machine is connected.

1. Enter a machine name.



Select an identifying color for the machine. This color is shown on the title bar for a while when the arrow pointer is moved to the title bar of a machine window.

2. Click [OK].

Retrieve the Embroidery Data

1. Click .

The embroidery data explorer starts up.

2. Double-click the desired data or click **OK** after clicking the desired data.

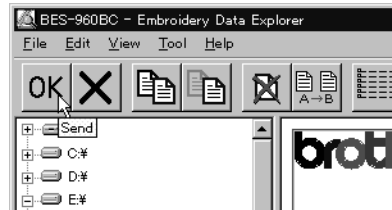

3. The selected data is transferred to the machine controller.

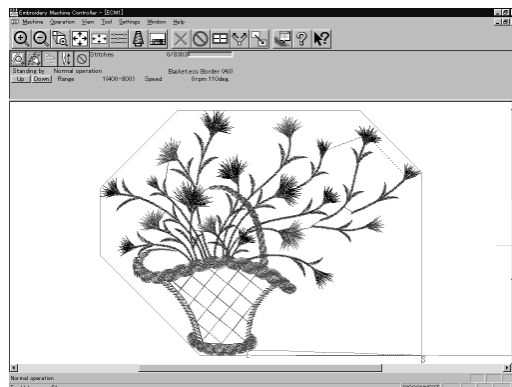

4. Click .

The data is transferred to the machine for preparation of embroidering.

Start Embroidering

1. Check that the READY lamp on the machine operation panel is on.

 POWER

 READY

2. Press  to check the embroidering area.

3. Press  to start embroidering.





Chapter 4

Selecting and Transferring Embroidery Data





Clicking  on the machine controller brings up a screen which allows selecting or transference of registered embroidery data. Moving, copying, and deleting of embroidery data can also be carried out on this screen.

Functions (Command Reference)







File menu

New		Creates a new directory. (→ page 70)
Exit of Selection		Transfers embroidery data to the machine controller. (→ page 71)
Exit		Exits from embroidery data explorer.

Edit menu

Copy		Copies the selected embroidery data. (→ page 73)
Move		Moves the selected embroidery data to a different directory. (→ page 74)
Delete		Deletes the selected embroidery data. (→ page 75)
Rename		Renames the selected embroidery data. (→ page 78)
Recreate an icon		Creates an icon of data for other models. (→ page 76)
Select all		Selects all the data. (→ page 77)

View menu

Tool Bar		Displays the tool bar.
Status Bar		Displays the status bar.
List		Displays embroidery data in the text form. (→ page 81)
Image		Displays the image of embroidery data. (→ page 81)
Sort by Name		Sorts embroidery data by name (in the reverse order). (→ page 81)
Sort by Stitches		Sorts embroidery data by the number of stitches in ascending order (in descending order). (→ page 81)
Sort by Colors		Sorts embroidery data by the number of colors in ascending order (in descending order). (→ page 81)
Sort by Date		Sorts embroidery data by date in descending order (in ascending order). (→ page 81)
Refresh		Displays the latest data by updating the screen. (→ page 81)

Tool menu

Find Files		Retrieves files. (→ page 79)
DST/DSB/DSZ → ECS Conversion		Reads DOS format data. (→ page 82)
Non DOS (Barudan, ZSK...) Conversion		Reads non-DOS format data. (→ page 84)
Tape → ECS Conversion		Reads data in paper tape. (→ page 88)
ECS → DST Conversion		Converts ECS data to DST data. (→ page 91)
Setup		Defines settings of data reading. (→ page 90)

Description of Screen

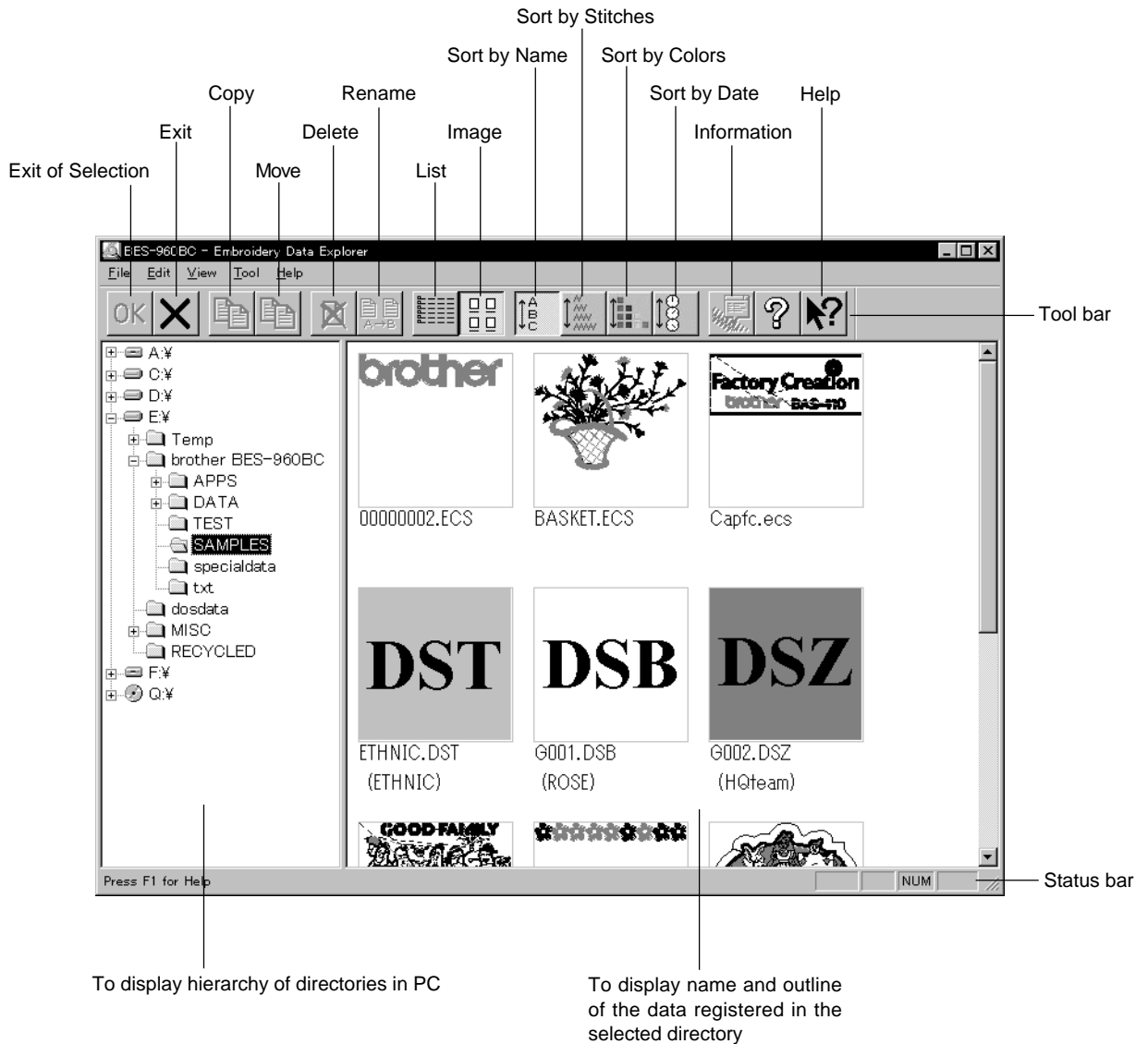

Creating a Directory

Creates a new directory. A directory can be created within another directory.

1. Click and select a parent directory in the window on the left.



2. Select [New] - [Folder] from File menu.

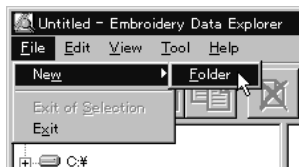

3. Enter a new folder name.

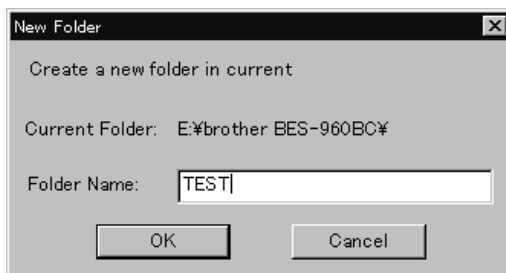

4. Click [OK].
5. A new directory is added to the window.



Transferring data

Transfer registered embroidery data to the machine controller or Embroidery data editor.

1. Double-click data, or click data and **OK** .

The explorer exits automatically after transferring the selected data.

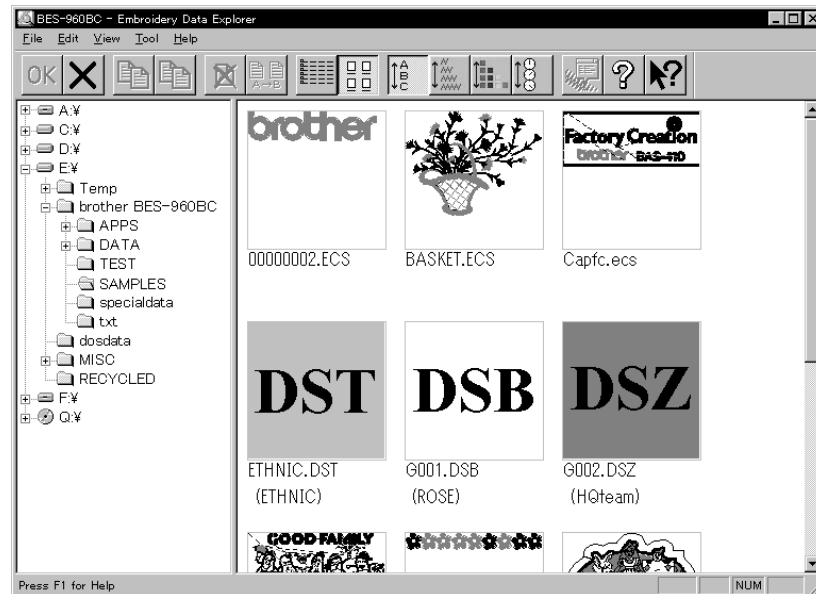

Transferring DST and DSB data

1. Double click DST or DSB data or click the data and click **OK** .
2. The pattern image is displayed. To read the data, click **[OK]**.

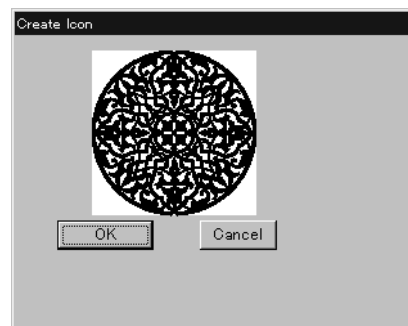

3. **Set the number of feeds for trim. Select the number of feeds or specify the feed length for trimming and click [OK].**

The data is transferred and the explorer ends automatically.

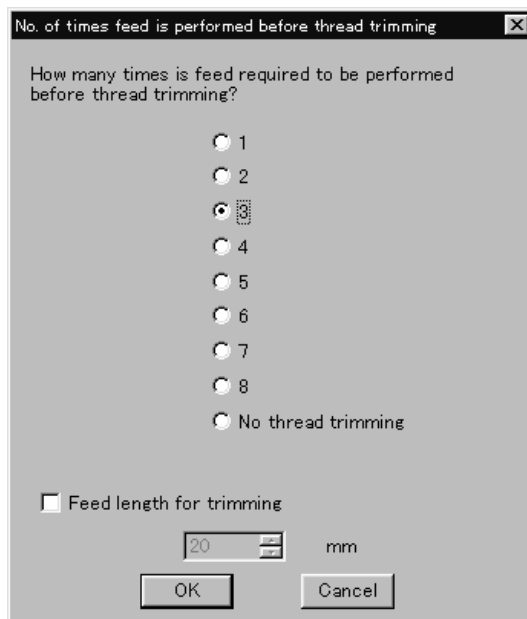

Transferring data on a network

1. **Before starting the software, click [START] - [PROGRAM] - [EXPLORER].**
2. **Select [Map Network Drive] from Tool menu.**
3. **Select the desired drive and enter the path, and click [OK].**
4. **Exit from the explorer.**

If no image appears:

If no image of embroidery data appears, select "Display Detail" on "Screen" of the control panel to adjust display color.

Choose one of the following options, then restart PC.

- 256 colors
- High color (16 bits)
- Full-color (24 bits)



Select the display color using "Color Pallet".

Copy

Copies embroidery data.

- Select from the menu or drag the data icon to the destination.

Select from Menu

1. Click data for selection.
2. Select [Copy] from Edit menu or click .

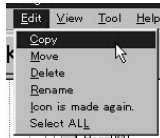

3. Select destination directory. Name copy data.

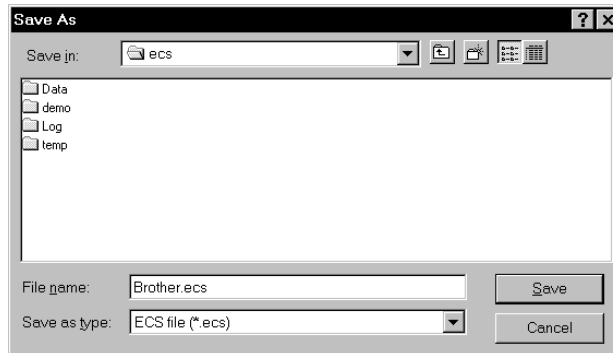

4. Click [Save].

Drag Data

1. Click data for selection.
2. Drag data to destination directory while pressing [Ctrl] key.
The pointer turns into . Release the mouse button when the directory name is inverted.

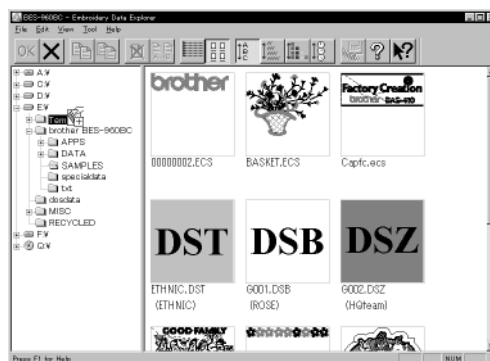

3. Check that the copy destination directory is correct, then click [Yes].

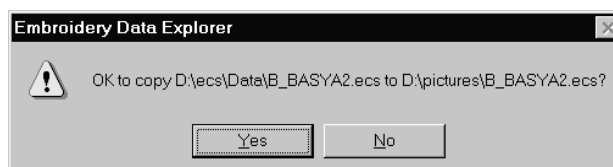

Moving Data

Moves embroidery data to a different directory.

- Select from the menu or drag the data icon to the destination.

Select from Menu

1. Click data for selection.
2. Select [Move] from Edit menu or click .

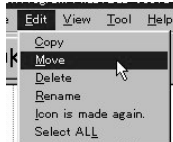

3. Select the destination directory and click [Save].

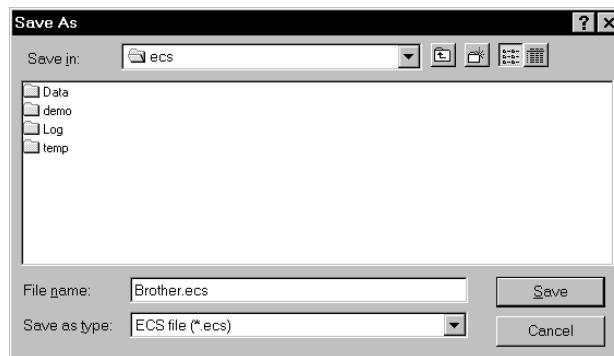

Drag Data

1. Click data for selection.
2. Drag data to the destination directory.

The arrow pointer turns into . Release the mouse button when the directory name is inverted.



3. Check that the copy destination directory is correct, then click [Yes].

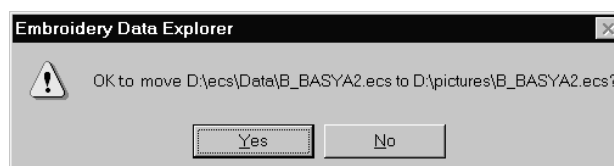

Deleting Data

Deletes embroidery data.

1. **Click data for selection.**

The frame of selected data becomes red.

2. **Select [Delete] from Edit menu or click  .**

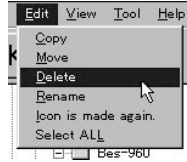

3. **Click [Yes] to delete the selected data.**

Recreate an icon

Creates an icon of data for other models.

- Icons of the data created by the following models can be recreated.
 - BES-941BC
 - BES-961BC
 - BES-1241BC
 - BES-1261BC
 - BES-963BC
 - BES-1263BC

- When ECS data saved on a machine such as the BES-963BC is read the by the embroidering data explorer, some information (No. of repetitions, etc.) cannot be restored.

1. Click and select the data displayed as "Icon is not completed".

The frame of the data selected is displayed in red.

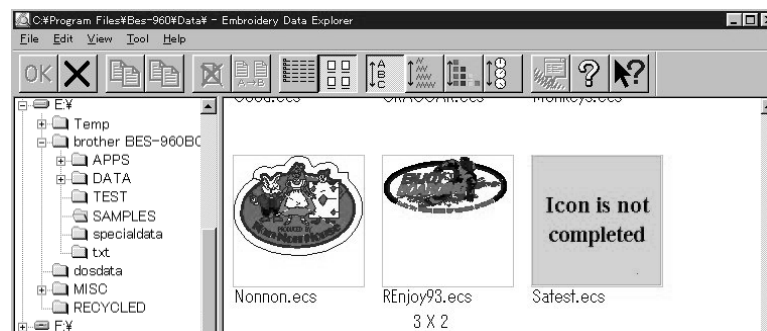

2. Select [Icon is made again.] from the Edit menu.

3. The pattern image is displayed.

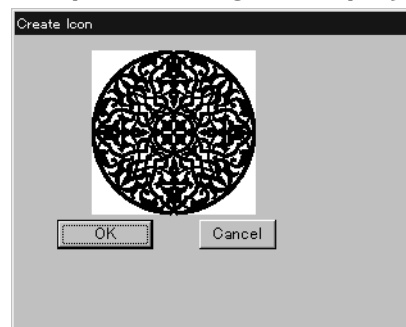

4. Click [OK].

Select all

Selects all the data in the folder displayed.

- Only copying, movement, and deletion by drag & drop are enabled when multiple patterns are selected simultaneously. Transfer to the machine controller is disabled.

1. Select [Select all] from the Edit menu.

The frame of the data selected is displayed in red.

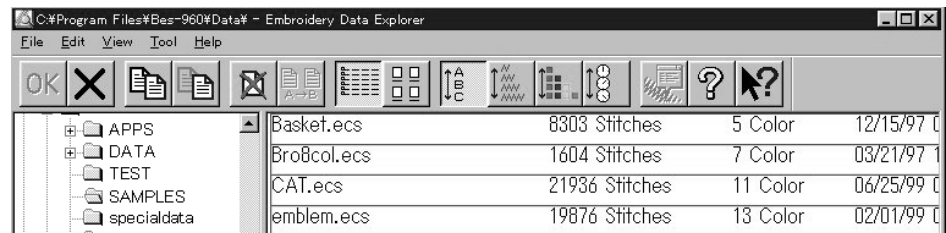

In the text display mode

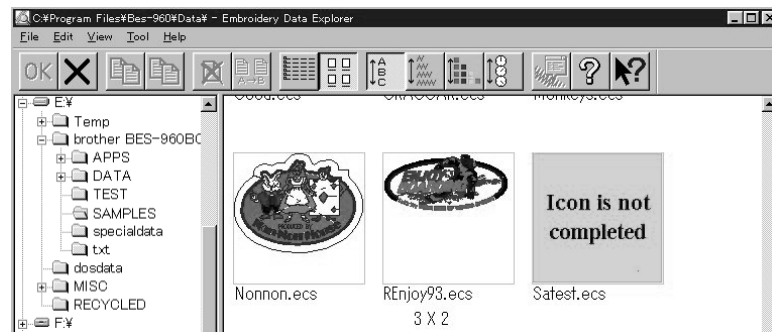

In the image display mode

Renaming Data

Renames the registered embroidery data.

- Data name consists of the name area and three characters called "extension" which indicates data type. Enter ".ECS" at the end of the data name.



- Upper and lower cases are not distinguished in the data name.

1. Click data for selection.

The frame of selected data turns red.

2. Select [Rename] from Edit menu or click  .

3. Enter a new data name.

Enter a data name including extension.



4. Click [OK].

Finding Data

Retrieves and views embroidery data.

1. Select [Find Files] from Tool menu.
2. Enter the file name of embroidery data for search.
Enter the file name correctly.



3. Click [Find].



If the specified embroidery data is found, the data is displayed.



Finding Files With Wildcard Characters

Wildcard characters can be used as a substitute of a single character or multiple characters. Characters "?" and "*" can be used as wildcard characters for search.

■ Using "?"

The wildcard character "?" represents any single character. For instance, if "Basket?.ecs" is entered to the file name box, the search will find any file name including 'Basket' and a following character. Any number of wild characters can be used to replace other characters.

■ Using "*"

The wildcard character "*" represents a character or combination of characters. For instance, if "*.ecs" is entered to the file name box, the search will find all files with extension "ecs".

Adjusting Screen Display

Selects the information type to display on the screen.

■ Tool bar

If it is checked, the tool bar appears.

■ Status bar

If it is checked, the status bar appears.

■ File display format

Choose either option.

List	Displays a list of all embroidery data names and details in the directory in text format.
Image	Displays a list of all embroidery data names and images in the directory.

■ File sorting order

Choose one of the following options. Clicking the icon will switch between ascending order and descending order.

Sort by Name	Sorts files by name.
Sort by Stitches	Sorts files by the number of stitches in ascending order (in descending order).
Sort by Colors	Sorts files by the number of colors in ascending order (in descending order).
Sort by Date	Sorts embroidery data by date in descending order (in ascending order).

■ Updating to the latest information

Displays the latest information.

1. Select [Refresh] from View menu.

Reading Data in Floppy Disk

Reads data in a floppy disk and registers it as embroidery data.

■ The following data formats can be registered.

• DOS format data

Tajima	Data with file name "xxxx.DST"
Barudan	Data with file name "xxxx.DSB"
Zanks	Data with file name "xxxx.DSZ"

• Non DOS format data

Barudan FDR
Barudan FMC
Zanks ZSK

Reading DOS Format Data

1. Select [DST/DSB/DSZ → ECS Conversion] from Tool menu.
2. Select data to read and click [Open].

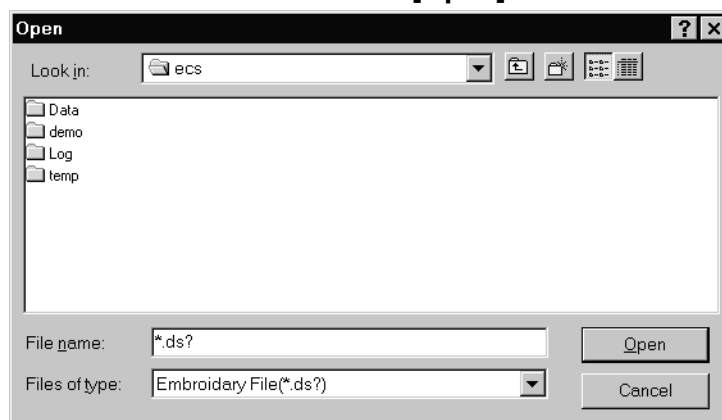

3. The image of the selected pattern appears.



4. **Set feed counts for thread breakage. Select the number of feeds or specify the feed length for trimming and click [OK].**

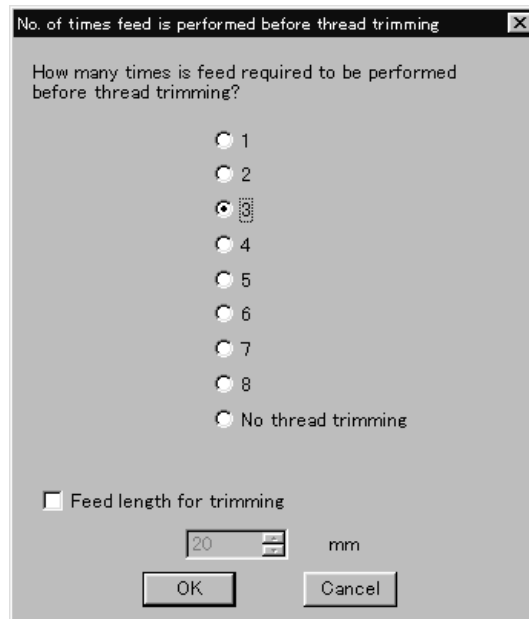

5. **Select the directory to save and name the file.**

Do not change extension ".ECS".

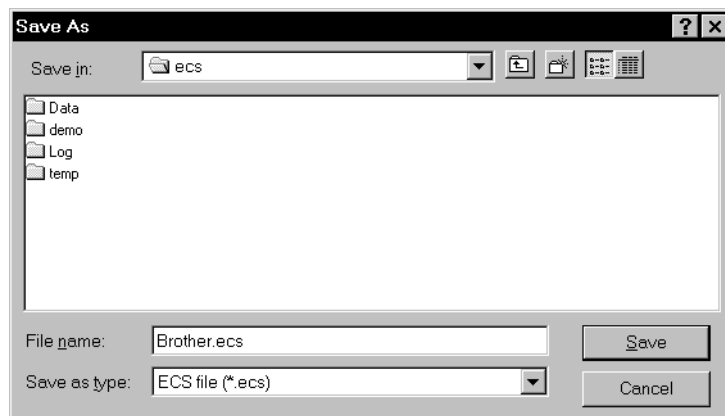

6. **Click [Save].**

Converting the Non DOS format data

Change ECS data into DST data and save.

Viewing Files

To view files of FDR, FMC and ZSK data, carry out the following steps:

■ Viewing Details

Click  .

Names, types, Numbers, sizes, number of stitches of FDR data are displayed.

Names, sizes, number of stitches of FMC data are displayed.

Names, Numbers, sizes, number of stitches of ZSK data are displayed.

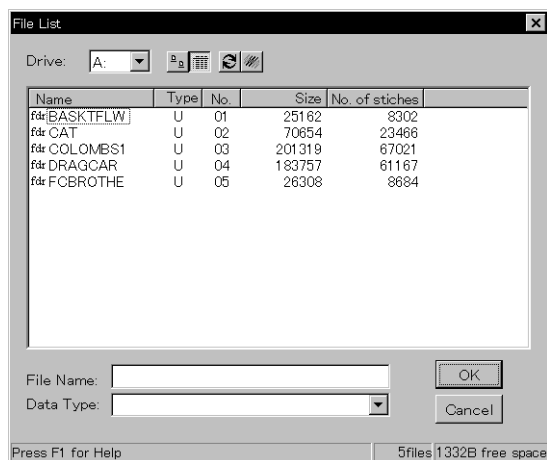

When reading FDR data

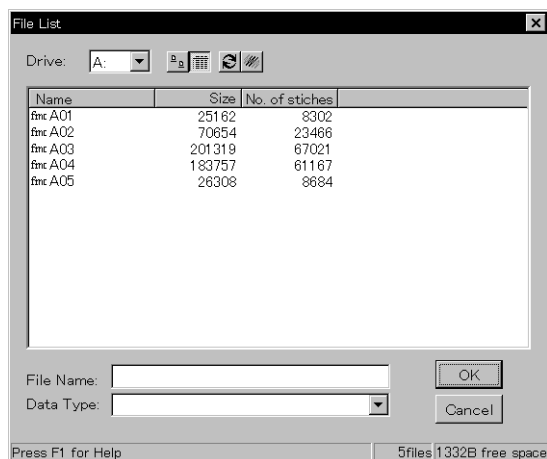

When reading FMC data

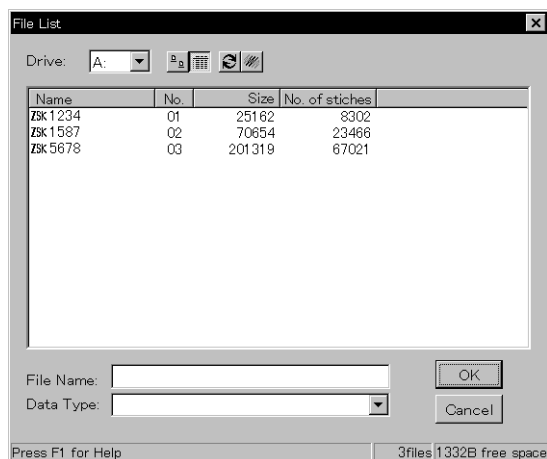

When reading ZSK data

■ Viewing Icon

Click  .



■ Preview and Refresh

The data image can be displayed before reading the data. Click the desired icon or the name for display. Click  to display the data image. On the detailed display, "fdr" and "fmc" changes to image display. To cancel the preview, click



1. Set the floppy disk such as Barudan which is non-DOS format at the floppy disk drive of the PC.
2. Select [Non DOS (Barudan, ZSK...) Conversion] from Tool menu.

3. Select data to read and click [OK].

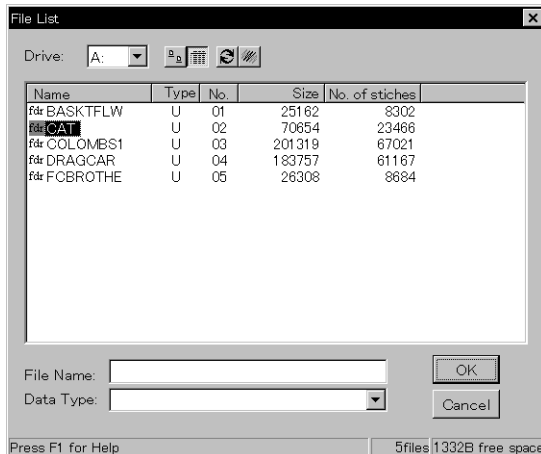

When "Details" is selected



When "Icon" is selected

4. The image of the selected pattern appears. To convert the selected data into ECS data. Click [OK].

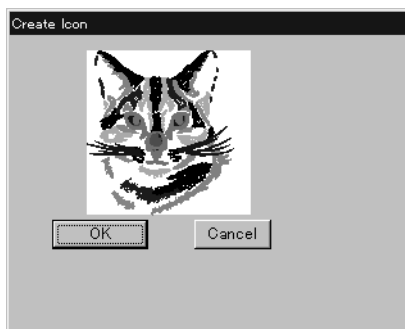

5. **Set feed counts for thread breakage. Select the number of feeds or specify the feed length for trimming and click [OK].**

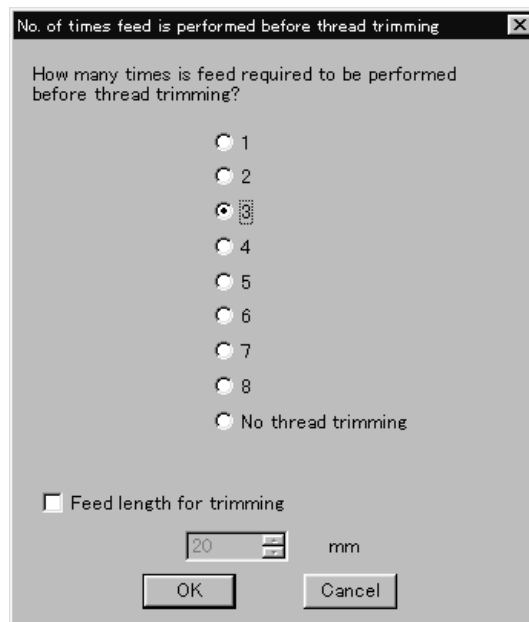

6. **Select the directory to save the file and name the file.**
Do not change extension ".ECS".

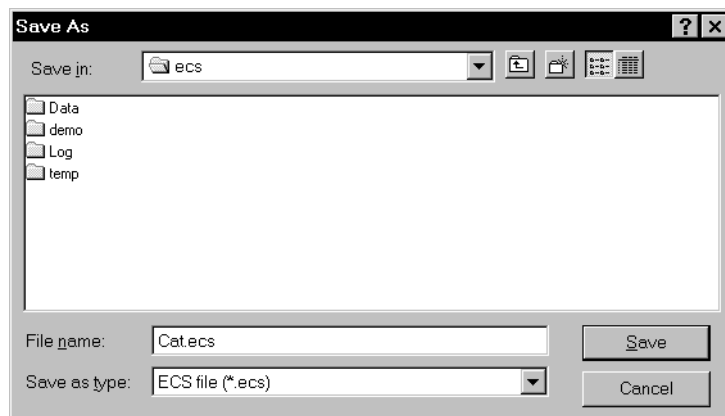

7. **Click [Save].**

Reading Data in Paper Tape

Saves data in paper tape as embroidery data.

- An optional paper taper reader is required for reading data.
- Before saving any data, check that the paper tape reader (optional) is connected to PC correctly.
- Available interfaces are as follows:
 - COM1
 - COM2
- Readable data formats of paper tape are as follows:
 - Tajima
 - Barudan
 - Zanks (ZSK)

1. Turn on the power to the paper tape reader.
2. Set paper tape after the LED of READ button light up.

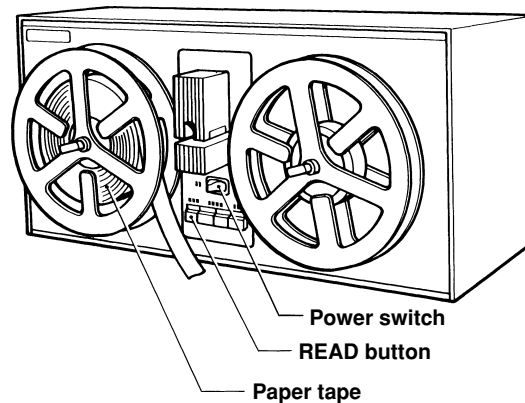

3. Select [Tape → ECS Conversion] from Tool menu.
4. Select data format and click [OK].

The paper tape reader (optional) starts reading data.

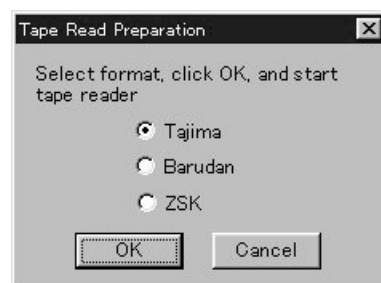

5. The image of the selected pattern appears.

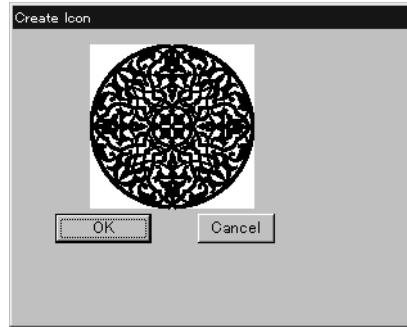

6. Select the directory to save and name the file.

Do not change extension ".ECS".

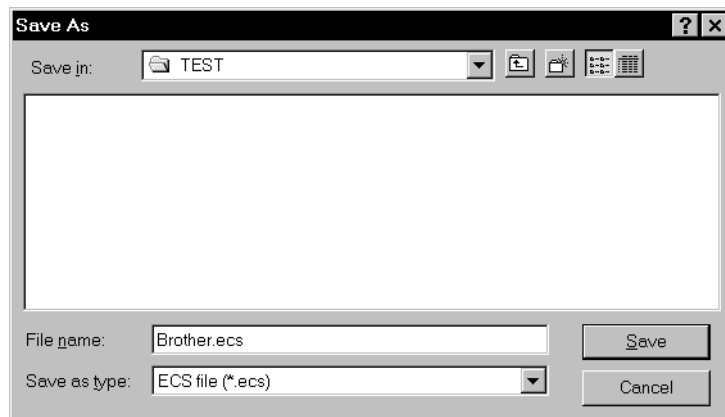

7. Click [Save].

Settings for Data Reading

Sets up the interface and data transfer speed of the paper tape reader or external disk drive.

1. Select [Setup] from Tool menu.
2. Select port and speed.



3. Click [OK].

Writing Data in DST Format

Convert the ECS data into DST data for saving.

1. Click the desired ECS data to convert into DST data.
2. Select [ECS to DST conversion] from Tool menu.
3. Select the directory to save and name the file.

Do not change extension ".dst".

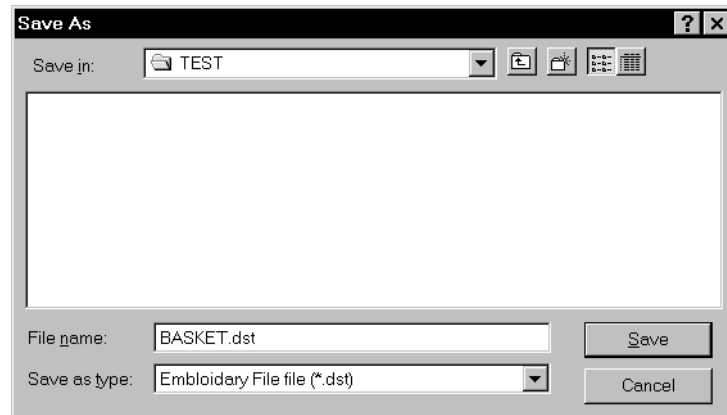

4. Click [Save].
5. Set feed counts for thread breakage. Select the count and click [OK].

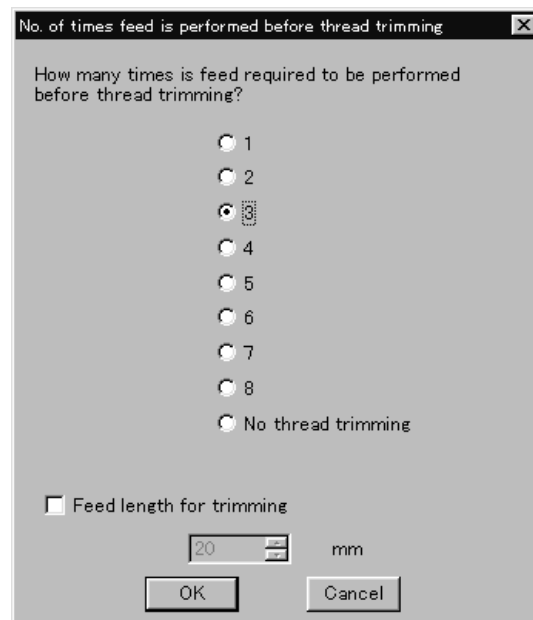

Viewing Pattern Information

Detail information of embroidery data can be checked.

■ The following items can be checked.

Pattern name	File name and path of embroidery data
File Version	Version number of the file
No. of stitches	The number of stitches in embroidery data
No. of colors	The number of colors used in embroidery data
Mask Size	Size of masking
Start of Embroidering	Coordinates of embroidering start position
End of Embroidering	Coordinates of embroidering end position
Last modified	Date of last revision of data

1. Click data for selection.

The frame of the selected data turns red.

2. Select [Design Information] from Help menu or click  .

3. After checking, click [OK].





Chapter 5

Editing Embroidery Data









Clicking  of the machine controller brings up a screen which allows editing of embroidery data. This screen allows simple processing of embroidery data and display setting of display.

Functions (Command Reference)

File menu

Open		Selects embroidery data. (→ page 97)
Merge		Add other pattern to the pattern in editing. (→ page 119)
Save		Saves the edited embroidery data over the current file. (→ page 121)
Save as		Saves the edited embroidery data as a separate file. (→ page 122)
Print		Prints embroidery data. (→ page 124)
Print Preview		Views printing condition of embroidery data.
Print Setup		Designates printer settings.
Exit Editing		Exits from editing of embroidery data.

Edit menu



Undo		Returns to the previous step. (→ page 107)
Redo		Repeats the step of "Undo". (→ page 107)
Rotate		Rotates the image. (→ page 108)
Horizontal Flip		Flips the image horizontally. (→ page 109)
Vertical Flip		Flips the image vertically. (→ page 109)
Point Symmetry		Rotates the image 180 degrees about the center. (→ page 109)
Repeat		Repeats copying of the image. (→ page 109)
Resize		Resizes the image. (→ page 111)
Delete Stitch		Delete a stitch whose length is the designated length or less. (→ page 111)
Insert or delete code		Insert or delete the code for trim, pause and color change. (→ page 112)
Insert lock stitch		Insert a lock stitch before and after thread trimming. (→ page 113)

Change menu

Start		Changes the start position of embroidery data. (→ page 114)
End		Changes the end position of embroidery data. (→ page 115)
Mask		Changes the mask of embroidery data. (→ page 116)
Group		Group the patterns created in "Repeat" into one. (→ page 117)

View menu

Centering		Centers embroidery data. (→ page 98)
Zoom		Zooms in or out. (→ page 98)
Needle Penetration		Displays the needle penetration positions. (→ page 100)

Embroidering Start/End		Displays the start/end positions of embroidering. (→ page 100)
Trim and pause		Displays the code insertion position for trim and pause. (→ page 100)
Microstitch		Displays the position of the stitch whose length is the designated length or less. (→ page 101)
Needle bar and speed range		Displays the setting screen for needle bar and speed range. (→ page 101)
Thread color		Displays the pattern in thread color. (→ page 105)
Tool Bar		Shows/hides the tool bar. (→ page 106)
Status Bar		Shows/hides the status bar. (→ page 106)

Description of Screen

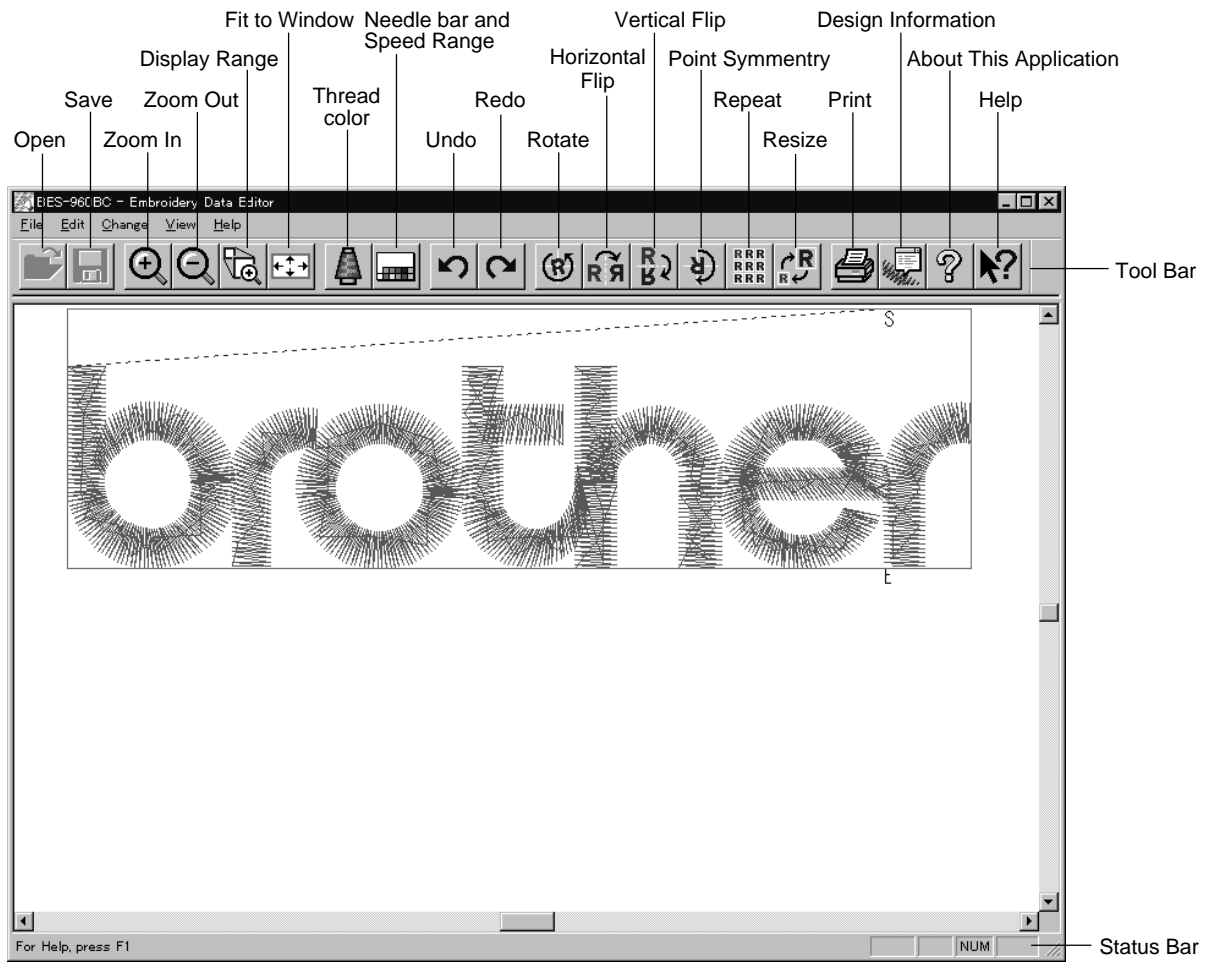

Opening Embroidery Data

This function is available with embroidery data editor.

1. Select [Open] from File menu or click  .
Double-click the data or click the data and **OK** .
2. Click a file for selection and click [Open].

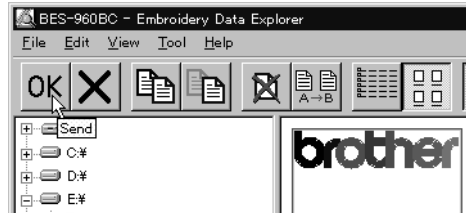

Setting Display

Sets the condition of the display screen. Items with check marks to the left are selected.

Centering

Brings the image to the center of the screen.

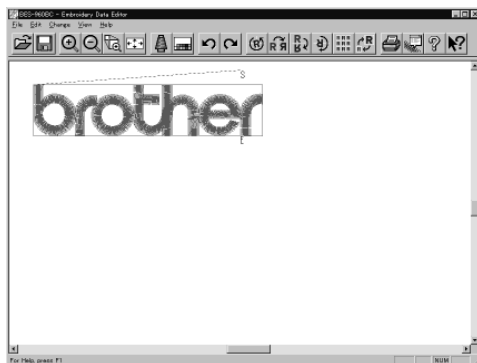

Before selecting



After selecting

1. Select [Centering] from View menu.

Zoom

Zooms in/out the pattern.

- The following four types of zooming are available.

Zoom In	Enlarges the image to 125%.
Zoom Out	Reduces the image to 80%.
Range	Magnifies the range defined by the mouse to the full window size.
Full Window	Displays the whole image to the size of the window.

Zoom In

1. Select [Zoom] - [Zoom In] from View menu or click .

Repeats zooming of the image by the number of clicks.



Before selecting



After selecting

Zoom Out

1. Select [Zoom] - [Zoom Out] from View menu or click  .

Repeats zooming of the image by the number of clicks.

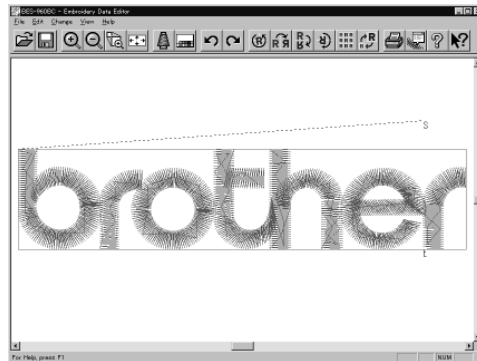

Before selecting



After selecting

Range

1. Select [Zoom] - [Range] from View menu or click  .

2. Drag and define the range to zoom in with the mouse.



Before selecting

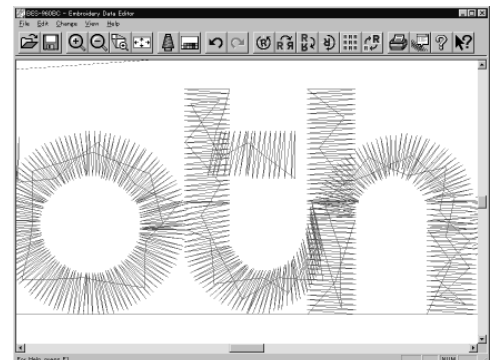

After selecting

Fit to window

1. Select [Zoom] - [Fit to window] from View menu or click  .



Before selecting



After selecting

Needle Penetration

Chooses whether or not the needle penetration positions are displayed.

1. Select [Needle Penetration] from View menu.

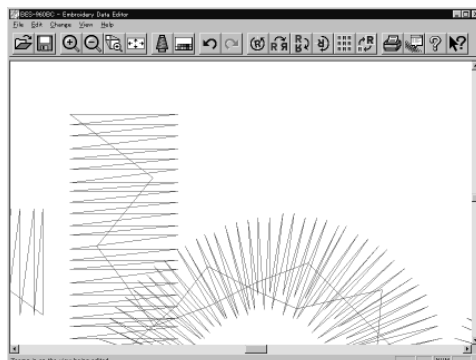

Before selecting

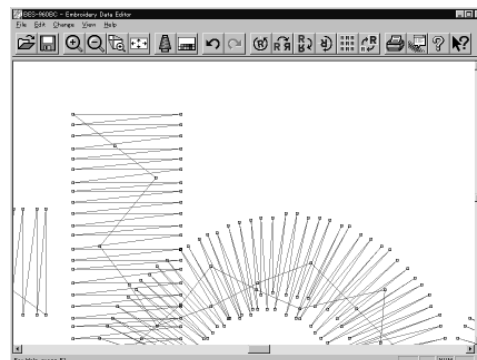

After selecting

Embroidering Start/End

Displays start and end points as "S" and "E" on the screen respectively. If points "S" and "E" are identical, "E" has priority over "S".

1. Select [Embroidering Start/End] from View menu.



Before selecting

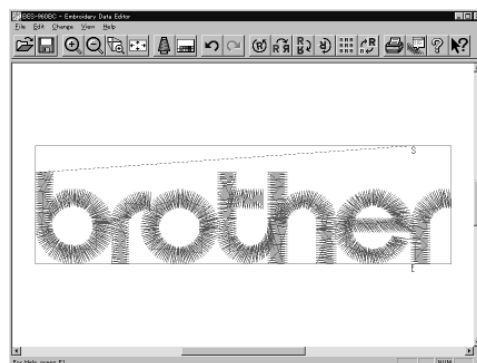

After selecting

Trim and pause

Displays the position of the trim code and the pause code.

Trim is displayed by X and pause is displayed by ☒.

1. Select [Trim and pause] from the View menu.

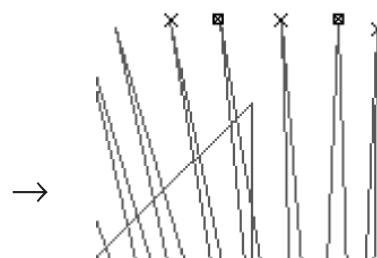
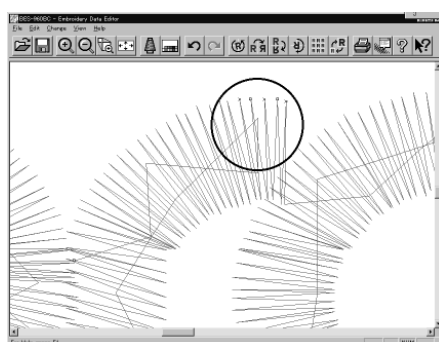

Microstitch

Displays the position of the stitch whose length is the designated length or less with ■ .

Length can be designated from 0.0 to 1.0 mm in units of 0.1 mm, or from 0.00' to 0.04' in units of 0.01'.

1. Select **[Microstitch]** from the **View** menu.
2. Designate the length of the stitch to be viewed. Select **[View]** and designate the length of the microstitch.



3. Click **[OK]**.

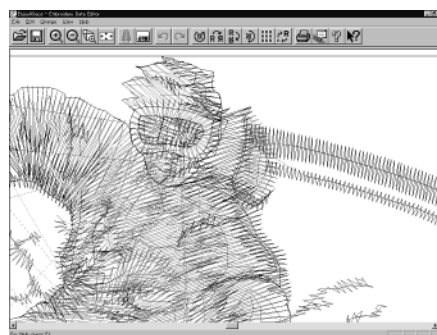

Before selecting

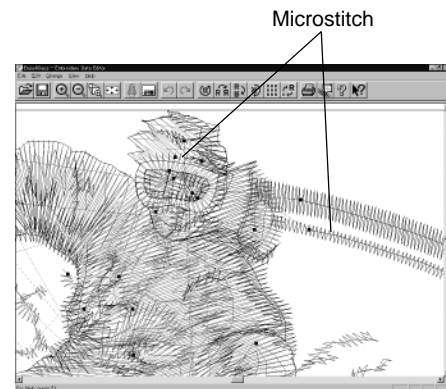

After selecting

Needle Bar and Speed Range

Displays status of the needle bar and speed range.

1. Select the **[Needle bar and speed range]** from the **View** menu or click  .

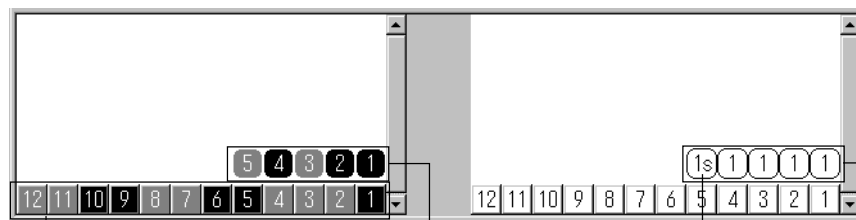

Indicates the needle number and the color.

Indicates the stitching order and the color.

Pause is set when the range shows S marking.

Indicates the range of each needle bar.

Change of display color

- When the color of the embroidering sequence is changed, the color displayed on the screen is changed. When ending embroidering or reading other data, the confirmation screen for saving the setting appears.

■ A display color can be selected from among the following four items.

Basic color which can be selected screen on the "Color selection"	Refer to steps 1 and 2.
Color sample supplied by a manufacturer	Refer to steps 1 and 3.
Color sample created by a user	Refer to steps 1 and 3.
Adjustment of an intermediate color from the color sample supplied by a manufacturer or naming and registration of a newly created color	Refer to steps 1 to 7.

■ The following screen is displayed when colors to be displayed are set to 256 in [Display Properties] and the color sample supplied by a manufacturer cannot be selected or an intermediate color cannot be created.

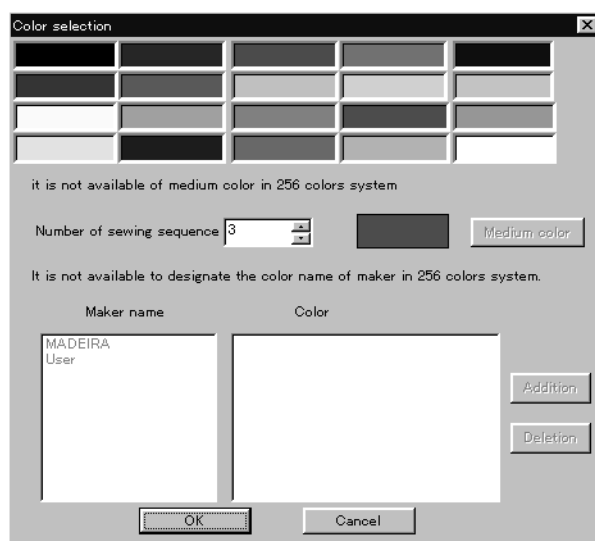

1. Double click the desired embroidering sequence to change the color.

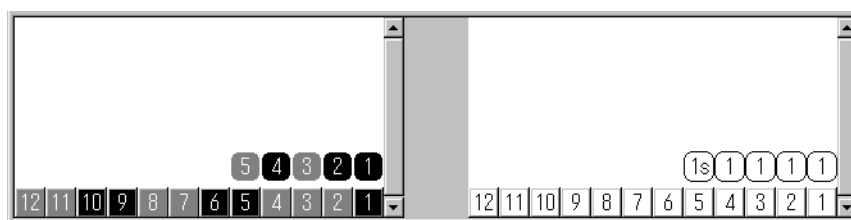

2. Select a new color on the [Color selection] screen.

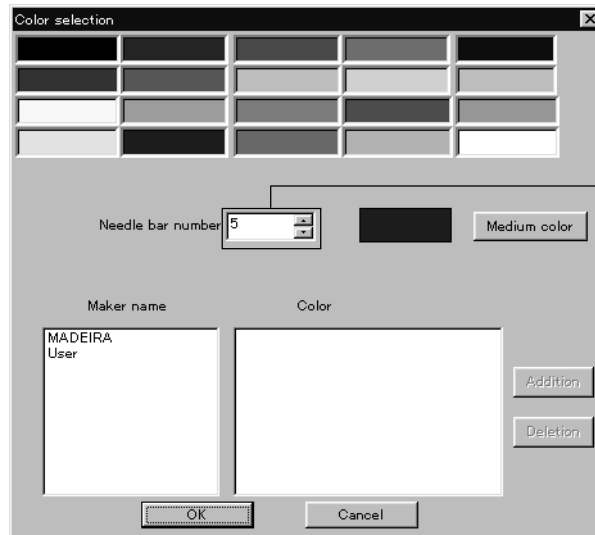

The needle bar number can be changed.

3. When selecting a color from a color sample, click maker name or [User] and double click [Color].

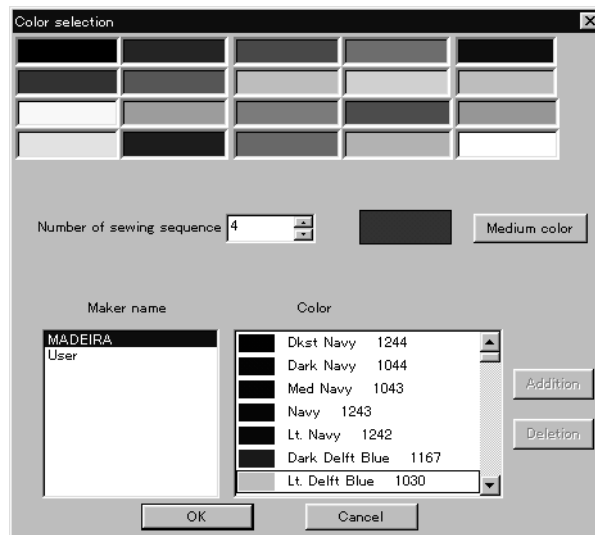

4. When finely adjusting the selected color, click [Medium color]. Click [User] to crate a new color, then click [Addition].

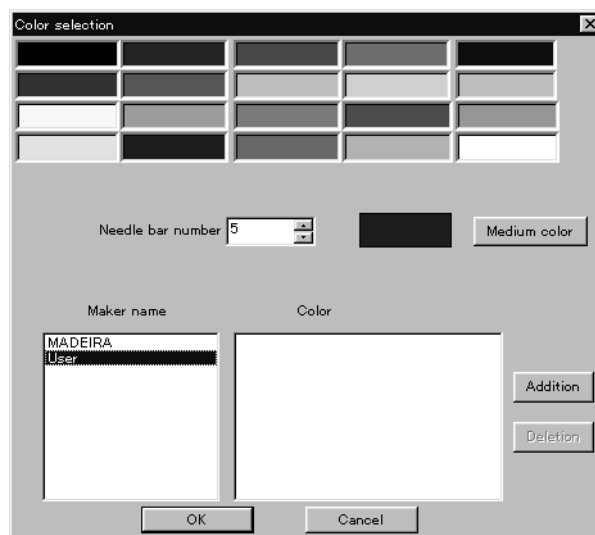

5. Select an arbitrary color from basic colors.
Click [Define Custom Colors] to create a medium color.

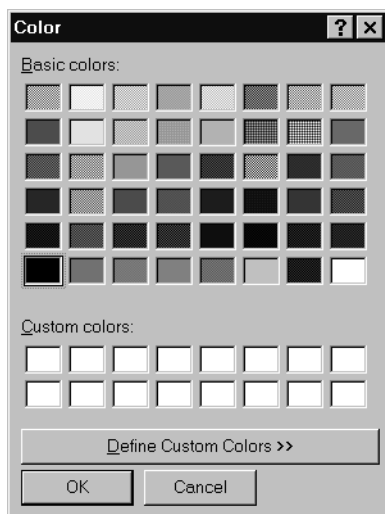

6. Select a color by clicking on the color chart or by inputting a value, and click [OK].

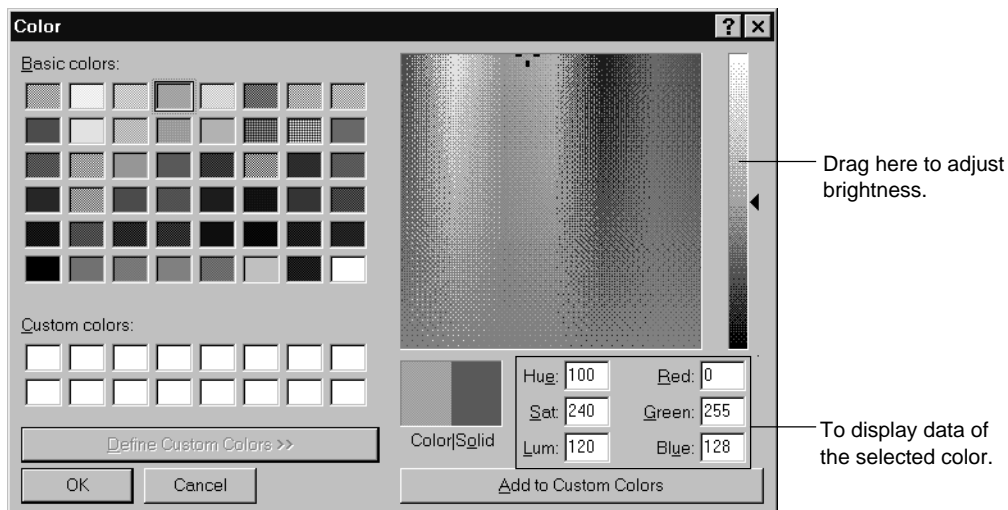

7. Input the name of the color and click [OK] when [User] is selected in step 4.

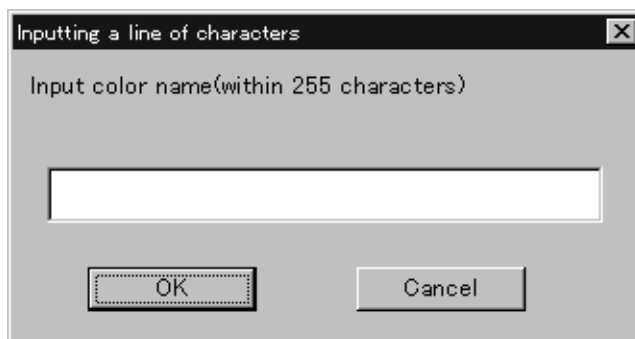

Changing needle bar allocation

1. Drag the embroidering sequence on the needle bar number.

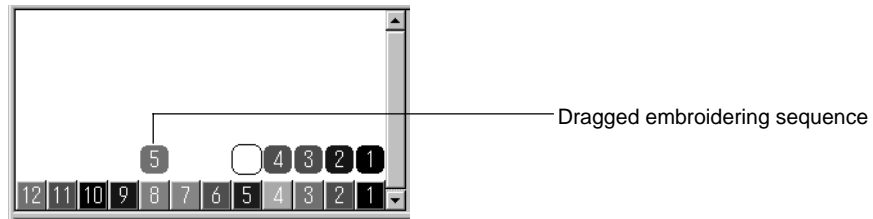

Setting the range

1. Double click the desired needle bar range to change.
2. Click the desired range.

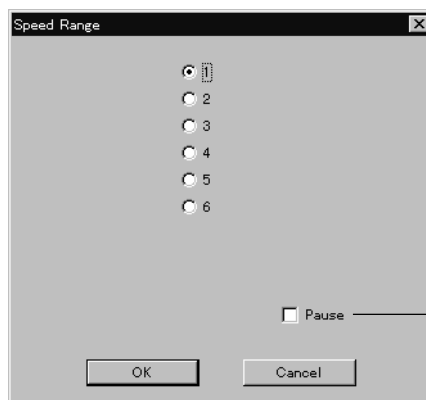

3. Click [OK].

Thread Color

The embroidery data is displayed in thread color.

- This function is available only when the embroidery data edit is started from the machine controller.

1. Select [Thread color] from the View menu or click  .

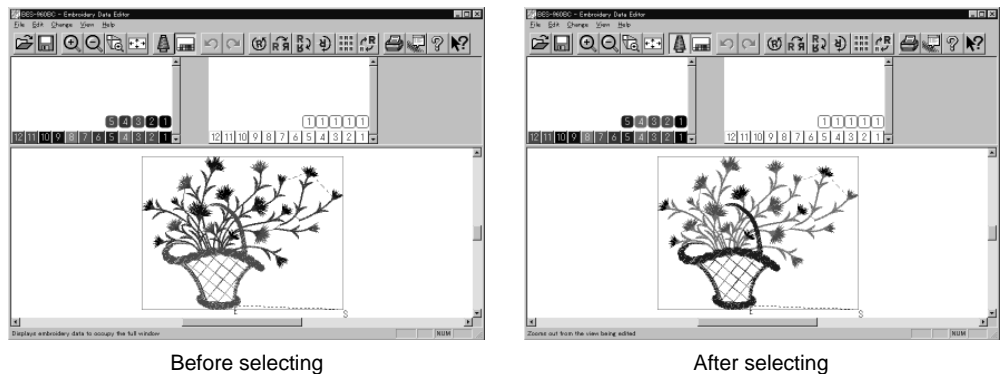

Tool bar

Shows/hides the tool bar. The tool bar contains icons with the same functions as the menu.

1. Select [Tool Bar] from View menu.

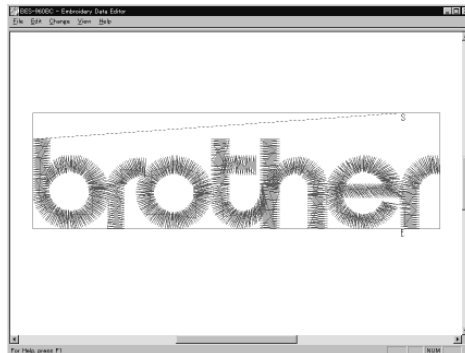

Before selecting

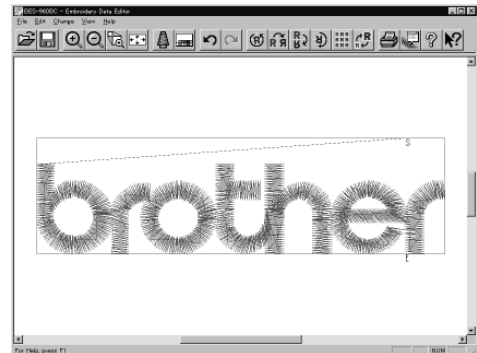

After selecting

Status Bar

Shows/hides the tool status. The status bar provides information on the current status and advice for operation.

1. Select [Status Bar] from View menu.

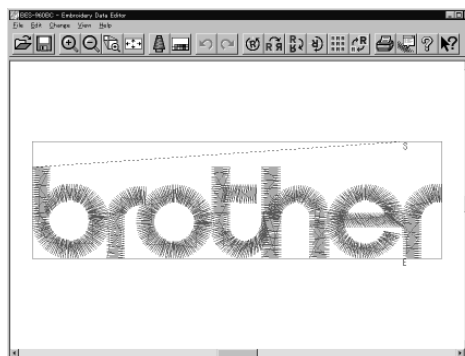

Before selecting

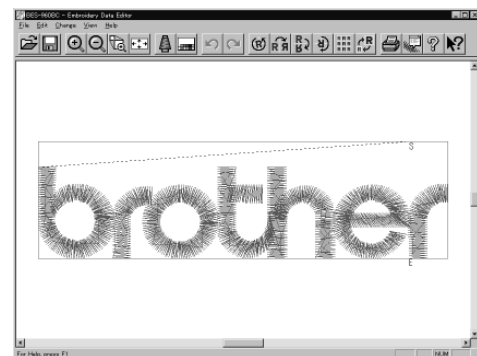

After selecting

Back to Previous Status

Undo

Makes the edit or change invalid. The screen returns to the state before the change.

■ The screen can return to 3 steps maximum.

1. Select [Undo] from the Edit menu or click  .

Redo

Repeats the canceled step of "Undo".

■ The screen can return to 3 steps maximum.

1. Select [Redo] from the Edit menu or click  .

Editing

Rotate

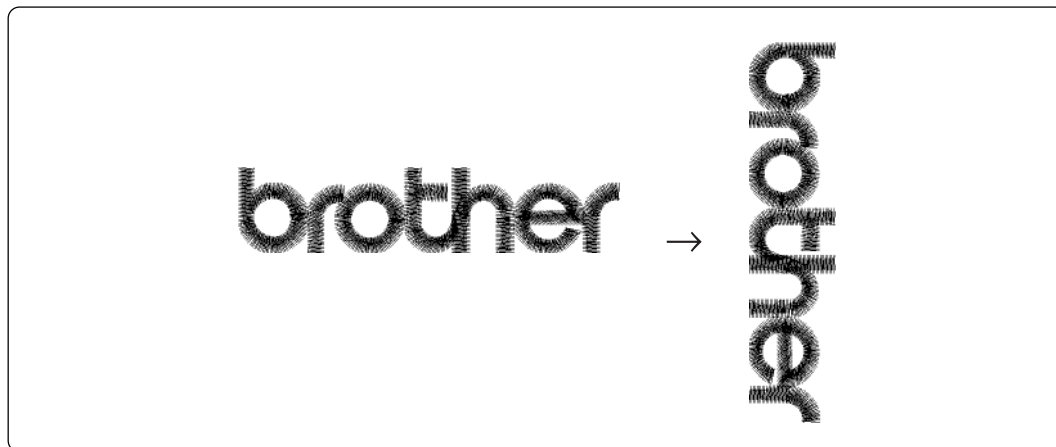

- Available range of rotation is -359 to 359 degrees.
- When the patterns to be repeated are grouped, the whole pattern rotates. When they are not grouped, each pattern rotates in each hoop.

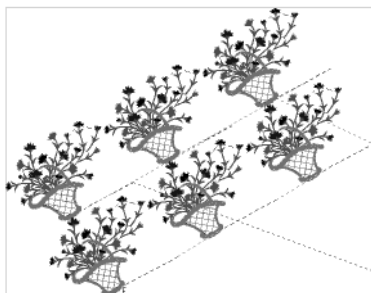

When the patterns are grouped

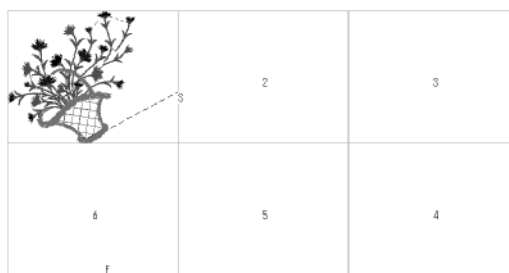

When the patterns are not grouped

1. Select [Rotate] from View menu or click .

2. Select angle.

If [Free] is selected, specify the angle.

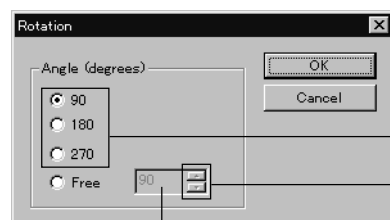

To select angle.

Click here to increase/decrease the value.

The value can be directly entered.

3. Click [OK].

Horizontal Flip

Flips the image horizontally.

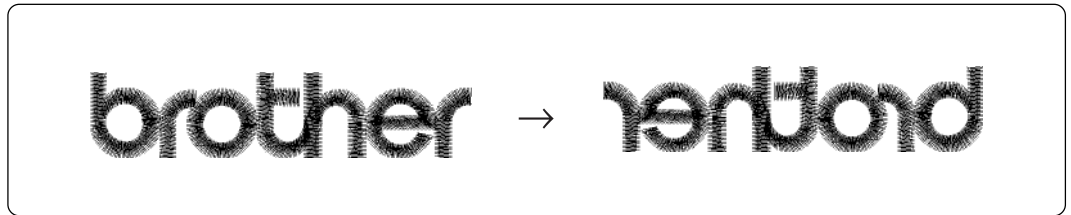

1. Select [Horizontal Flip] from Edit menu or click  .

Vertical Flip

Flips the image vertically.

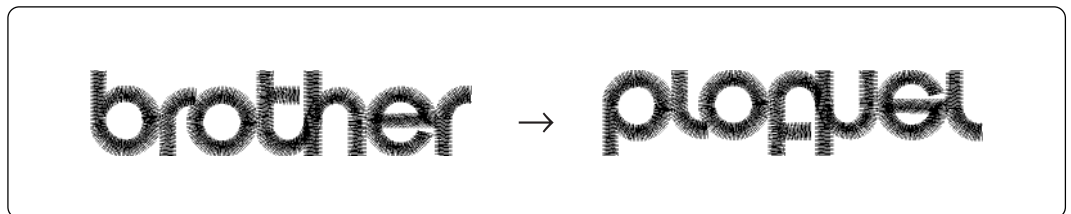

1. Select [Vertical Flip] from Edit menu or click  .

Point Symmetry

Flips the image 180 degrees to the center position of the image.

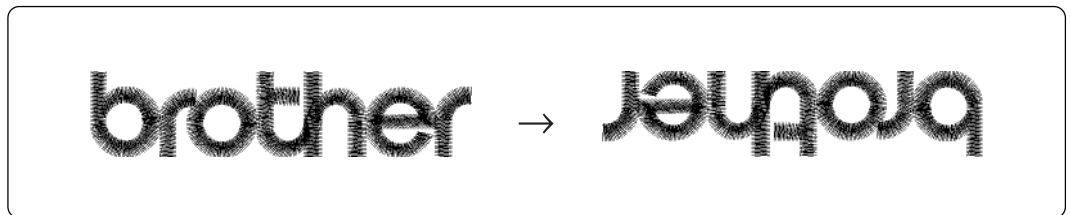

1. Select [Point Symmetry] from Edit menu or click  .

Repeat

Repeats copying of the image by the specified number.

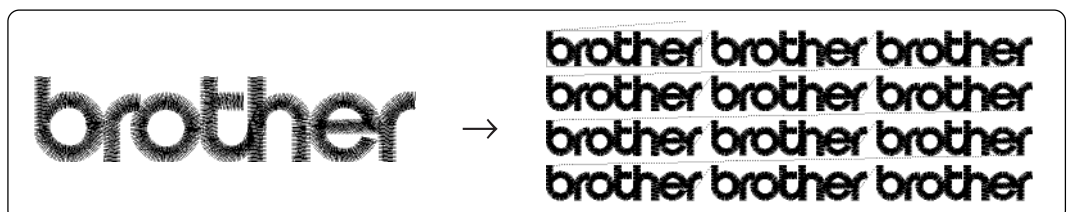

- The number for repetition is 1 to 100 for both vertical (Row) and horizontal (Column) directions.
- The unit for repetition can be set in inches. To use the inch unit, set the length to [inch] on the [Configuration] of Tool menu of the machine controller. (→ page 148)
- The pattern connection can be set in "Direction" as follows:

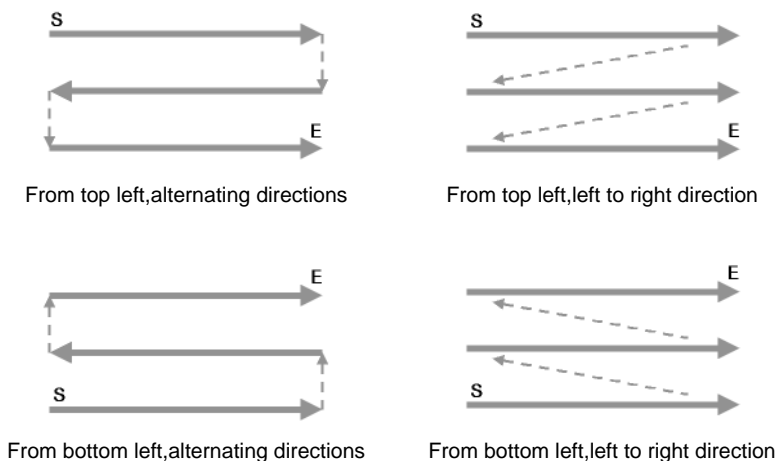

1. Select [Repeat] from Edit menu or click  .
2. Specify the number, interval and direction of repetition.

Repeat count in the longitudinal direction

Repeat count in the lateral direction

The value can be directly entered.

Click here to increase/decrease the value.

Select the direction of repetition.

Select the reference position for spacing.

All patterns created in repetition are grouped as a single pattern.

Longitudinal distance (Unit: 0.1 mm or 0.01')

Lateral distance (Unit: 0.1 mm or 0.01')

3. Click [OK].

Resize

Resizes the image.

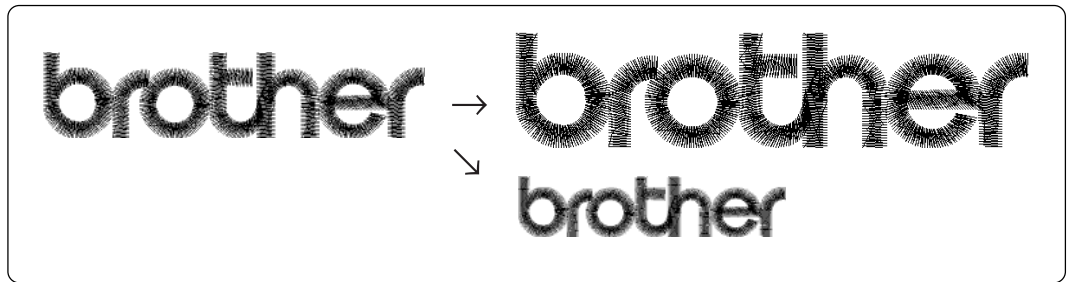

- The available range of resizing is 50 to 200% in both the X and Y directions.
- Resizing changes the thread density along with the percentage.

1. Select [Resize] from Edit menu or click .
2. Specify the percentage of resizing.

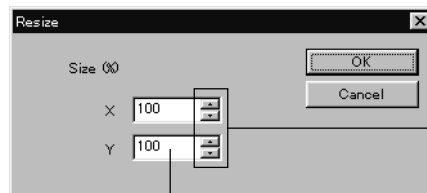

Click here to increase/decrease the value.

The value can be directly entered.

3. Click [OK].

Delete Stitch

Delete a stitch whose length is the designated length or less. Length can be designated from 0.0 to 1.0 mm in units of 0.1 mm, or from 0.00' to 0.04' in units of 0.01'.

1. Select [Stitch deletion] from Edit menu.
2. Designate the length of the stitch to be deleted.

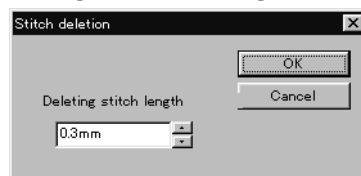

3. Click [OK].
4. Deleted result is displayed. Click [OK].



Insert or Delete Code

Codes of trim, pause and color change can be inserted or deleted by moving the needle to the desired position.

1. Select [Insert or delete code] from the Edit menu.

Needle movement tool bar is displayed.

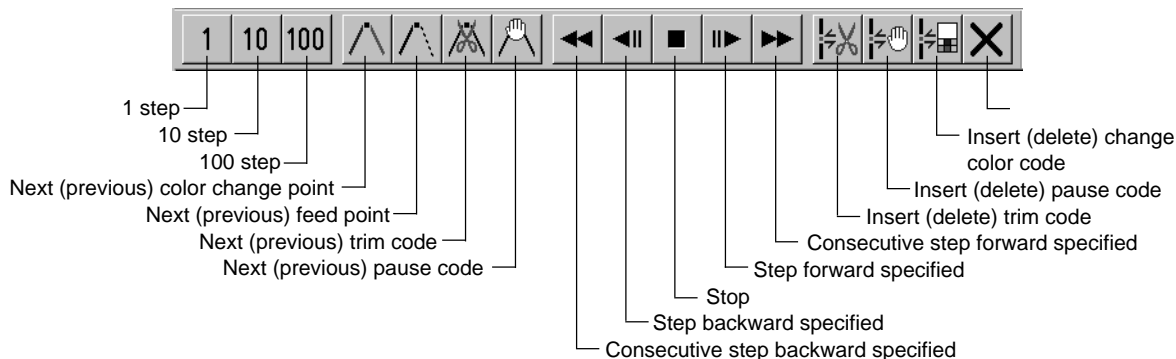

2. Select the movement method of needle position.

Click either of the following buttons:

1 step		Moves the needle position by 1 step each.
10 step		Moves the needle position by 10 step each.
100 step		Moves the needle position by 100 step each.
Next (previous) color change point		Moves the needle position to the next (previous) color change point.
Next (previous) feed point		Moves the needle position to the next (previous) feed point.
Next (previous) trim code		Moves the needle position to the next (previous) trim code.
Next (previous) pause code		Moves the needle position to the next (previous) pause code.

3. Move the needle position to the desired position.

Click either of the following buttons:

Consecutive step backward specified		The needle position returns consecutively until the "Stop" button is pressed.
Step backward specified		The needle position returns for the specified length.
Stop		The needle position stops movement.
Step forward specified		The needle position moves forward for the specified length.
Consecutive step forward specified		The needle position moves forward consecutively until the "Stop" button is pressed.

4. Insert or delete the code.

Click either of the following buttons:

Insert (delete) trim code		Insert (or delete) the trim code at the current needle position.
Insert (delete) pause code		Insert (or delete) the pause code at the current needle position.
Insert (delete) change color code		Insert (or delete) the change color code at the current needle position.

5. To end code insertion or deletion, click .

Insert Lock Stitch

Find the pattern of [Stitch] - [Trim] for [Before Trimming] and find the pattern of [Trim] - [Feed] - [Stitch] - [Stitch] for [After Trimming], then insert a lock stitch.

- Insertion method of lock stitch depends on the length of the second stitch as follows:

Stitch length	Method of lock stitch
1.2 mm or more	Insert 3 stitches of 0.3 mm stitch.
From 0.9 mm to less than 1.2 mm	Insert 2 stitches of 0.3 mm stitch.
From 0.6 mm to less than 0.9 mm	Insert 1 stitch of 0.3 mm stitch.
Less than 0.6 mm	Do not insert the lock stitch.

- The inserted lock stitch cannot be deleted. However, use [Undo] in the Edit menu to return to the status before inserting the lock stitch just after the lock stitch is inserted.

1. Select [Insert lock stitch] from the Edit menu.
2. Designate the position to insert the lock stitch and click [OK].



3. If the lock stitch can be inserted, click [Yes].



Changing Data

Changing Start

Changes the start position of embroidering.

Options	Functions
Center, upper left corner, middle left corner, lower left corner, middle top edge, middle bottom edge, upper right corner, middle right corner, or lower right corner of the mask	Starts embroidering at the specified position.
Specify using mouse	Starts embroidering at the position clicked with the mouse.
Cancel	Cancels the specified position.

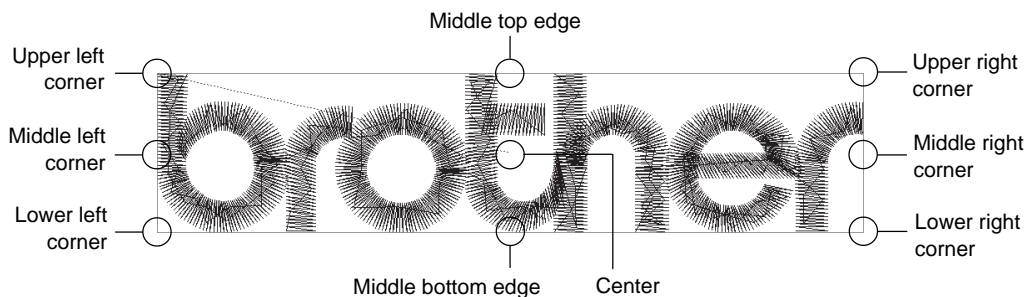

1. Select [Start] from Change menu.

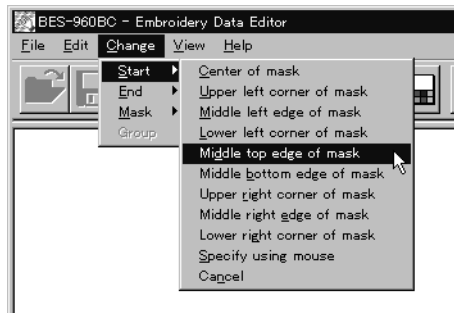

Click the start position if [Specify using mouse] is selected.

Changing End

Changes the end position of embroidering.

Options	Functions
Center, upper left corner, middle left corner, lower left corner, middle top edge, middle bottom edge, upper right corner, middle right corner, or lower right corner of mask.	Ends embroidering at the specified position.
Specify using mouse	Ends embroidering at the position clicked with the mouse.
End at start position	Ends embroidering at the end position.
Cancel	Cancels the specified position.

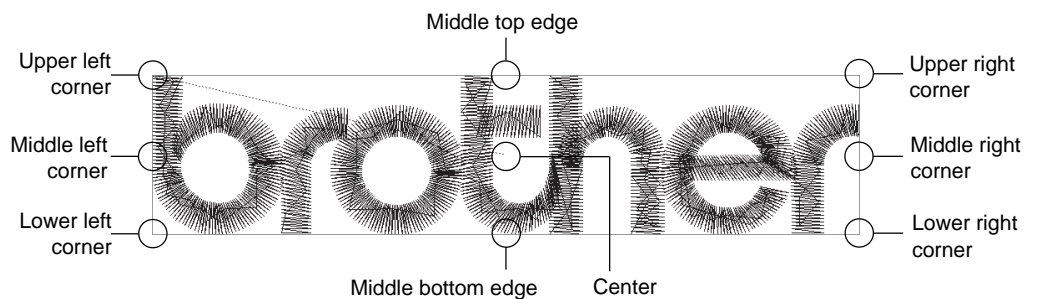

1. Select [End] from Change menu.

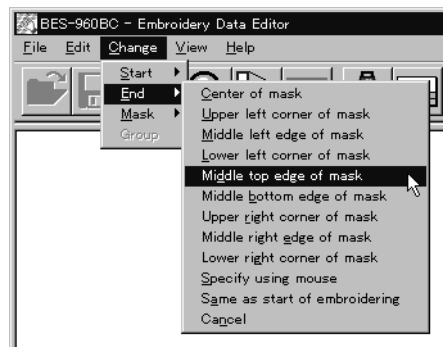

Click an end position if [Specify using mouse] is selected.

Mask

Changes the mask that represents the periphery of embroidery data. Since the automatic mask is a rectangle, the pattern within the hoop may be displayed as an error. In this case, set masking in manual mode.

■ Mask is displayed in a khaki line.

■ There are two types of mask setting as follows:

Automatic	The system measures the image size to create a mask automatically.
-----------	--

Manual	After selecting this mode, specify the mask area using the mouse.
--------	---

1. Select [Mask] from Change menu. Select automatic or manual mode.

If [Automatic] is selected, a mask is created automatically.

If [Manual] is selected, drag the area with the mouse to specify the mask.



Group

All patterns created in repetition are grouped as a single pattern.

- The difference between the grouped pattern and the non-grouped pattern is as follows:

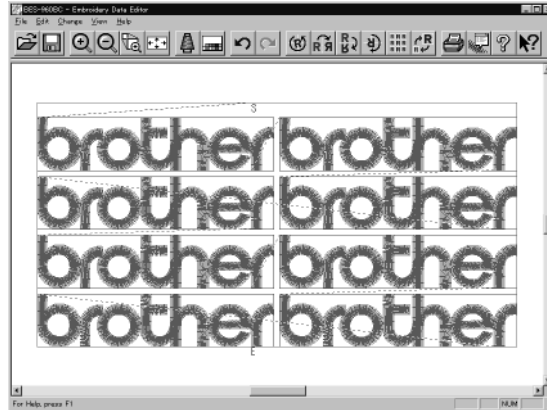

When the patterns are grouped

- Each pattern is displayed in each mask.
- The whole grouped pattern rotates. (→ page 108)

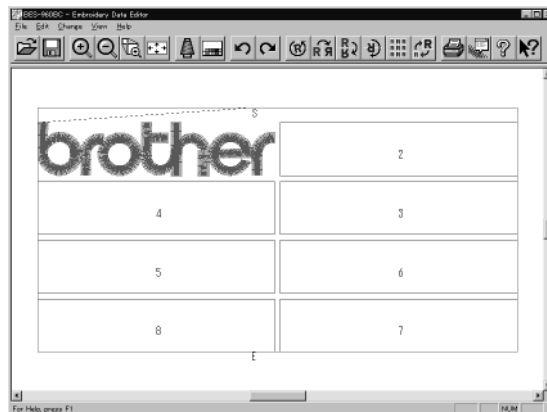

When the patterns are not grouped

- The pattern is displayed only in the original copy source. Figures in other masks represent the embroidering sequence.
- Each pattern in the mask rotates individually. (→ page 108)

Setting Group for Repetition

1. Select [Repeat] in the Edit menu or click  .
2. Click the checkbox of [Group] to put a check mark.

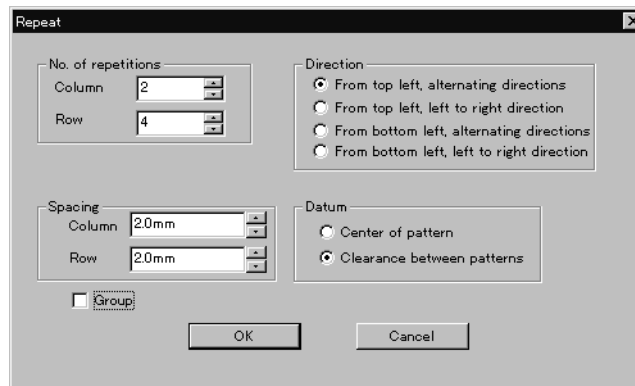

Selecting from Menu

1. Select [Group] from Change menu.

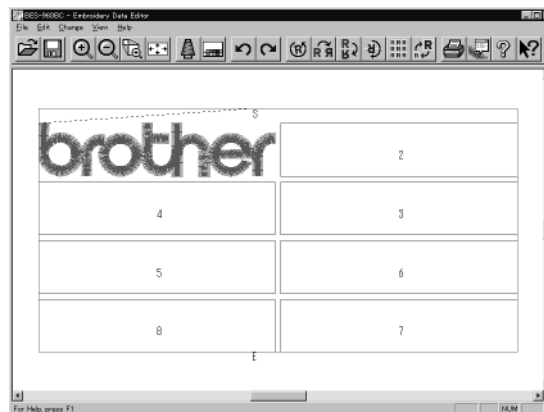

Merge

Merge other patterns to the pattern in editing.

- If the pattern to be merged is repetition data, it is automatically grouped and merged.
- If the pattern to be merged is grouped repetition data, it is merged at the specified position.

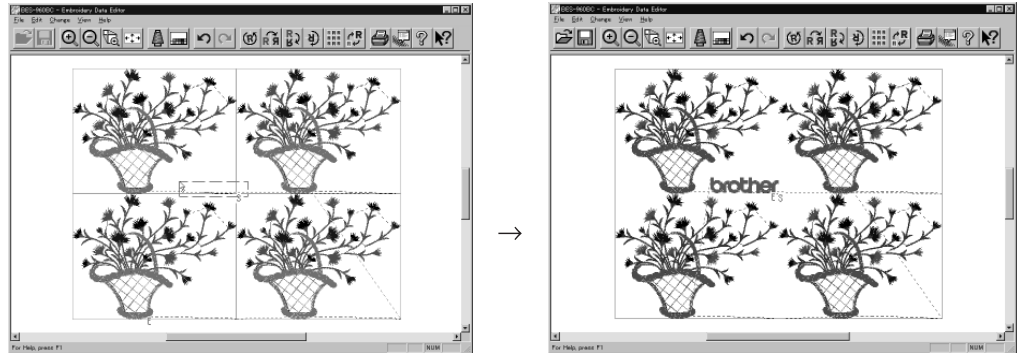

- If the pattern to be merged is non-grouped repetition data, it is merged to each pattern. If the pattern does not fit the mask, the mask is automatically adjusted.

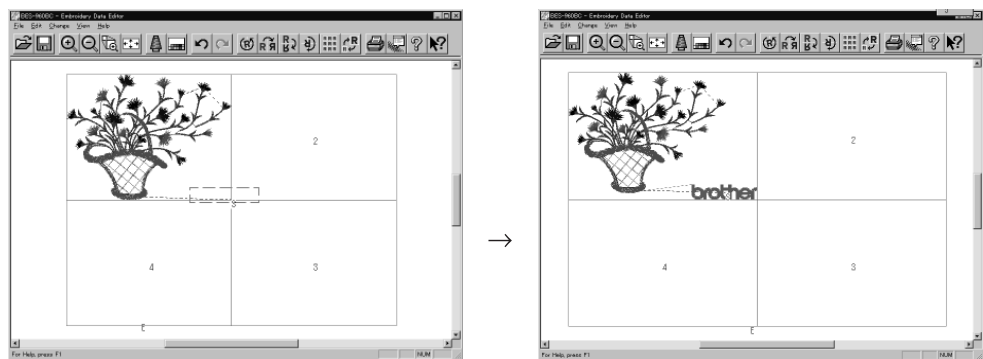

1. Select [Merge] from the File menu.
2. Select the pattern to be merged.



- 3. The pattern mask is displayed in a broken line. Move the mask to the desired position for merging. Click the mouse.**

Move the mouse while pressing the shift key. The mask moves horizontally and vertically.

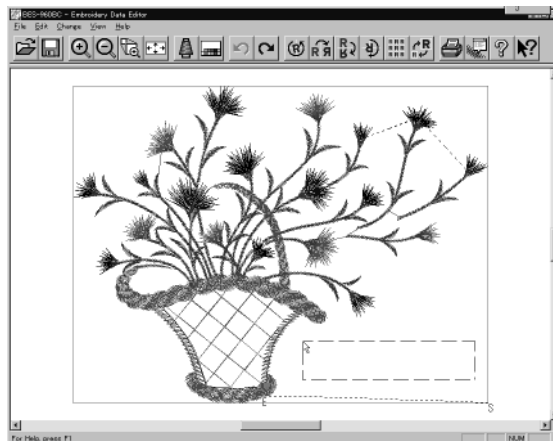

- 4. If the position is acceptable, click [Yes].**

When [No] is clicked, repeat the steps from 3.

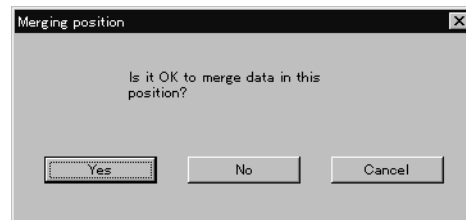

- 5. The pattern is merged.**



Saving Data

Saves the edited data. The edited data can be saved over the current file or renamed as a separate file.

Save

Saves the edited data over the current file. The original data is deleted.

1. Select [Save] from File menu or click  .
2. If the edited data is larger than the mask, choose whether to carry out automatic masking or not.

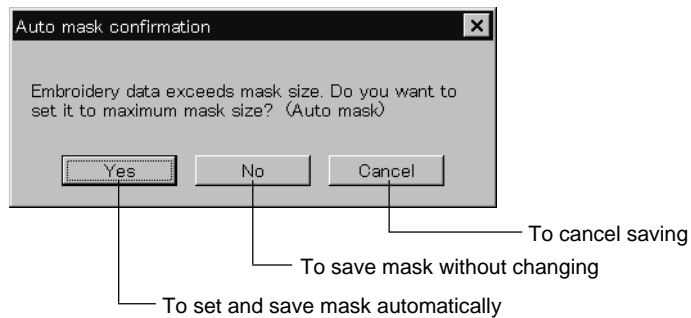

3. If color etc. has been is changed, the pattern image appears.



Save As...

Renames and saves the edited data as a new file.

1. Select [Save as...] from File menu.
2. Select the directory to save the new file. Enter a new file name.

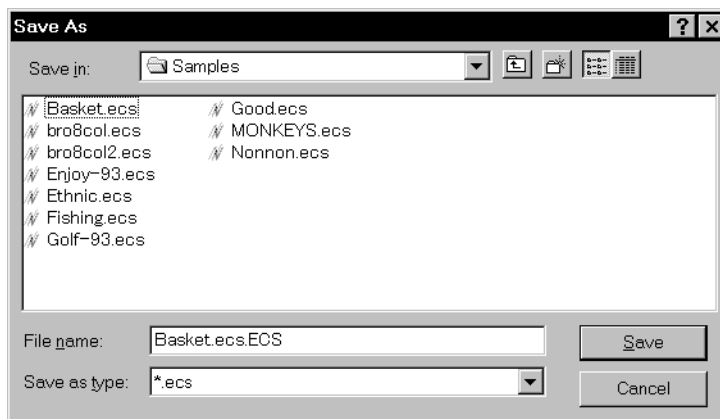

3. Click [Save].
4. If the edited data is larger than the mask, choose whether to carry out automatic masking or not.

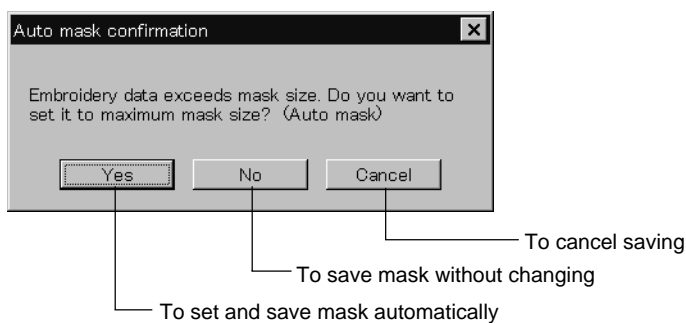

5. If color etc. has been is changed, the pattern image appears.



Viewing Pattern Information

Detail information of embroidery data can be checked.

■ The following items can be checked.

No. of stitches	The number of stitches in embroidery data
No. of colors	The number of colors used in embroidery data
Mask Size	Size of masking
Start of Embroidering	Coordinates of embroidering start position
End of Embroidering	Coordinates of embroidering end position

1. Select [Design Information] from Help menu or click  .
2. After checking, click [OK].

Printing Data

Prints data in editing.

1. **Select [Print] from File menu or click  .**
Specify the number of copies and other conditions. Click [OK].



Chapter 6 Embroidering

The PC controls the machine operation as well as settings of the machine. Note that the menu which appears on the screen depends on whether the power to the machine is turned on or off.

Functions (Command Reference)

When the Power to the Machine is Off

File menu

Exit	Exits the machine controller.
------	-------------------------------

View menu

Tool Bar	Displays the tool bar. (→ page 130)
Status bar	Displays the status bar. (→ page 131)

Tool menu

Edit Embroidery Data	Runs the embroidery data editor.
Embroidery Data Explorer	Runs the embroidery data explorer.
Production Report	Runs the production report.
Upgrade Interface Board	(→ page 131)
Reset Interface Board	(→ page 131)

Configuration menu

Communication Port	Sets the communication port between the PC and machine. (→ page 131)
Language	Changes display language. (→ page 132)

When the Power to the Machine is On







Machine menu

Save	The machine data is overwritten for saving. (→ page 186)
Save As	The machine data is saved as a different name. (→ page 186)
Minimize Window Size	Minimizes the size of display screen on the machine. (→ page 145)
Rename Machine	Renames the machine. (→ page 143)
Machine Information	Displays machine information. (→ page 144)
Exit	Exits from the machine controller.

Operation menu

Start Embroidering	Starts embroidering. (→ page 177)
Stop Machine	Suspends embroidering. (→ page 178)
Cancel Embroidering	Cancels embroidering. (→ page 178)
Home Position	Moves the home position. (→ page 179)
Step F/B	Carries out step-forward or step-back. (→ page 180)
Move Embroidery Position	Moves embroidering position. (→ page 184)
Centering Pattern	Moves pattern to the center. (→ page 185)
Test	Tests the machine. (→ page 187)

View menu

Tool Bar	Displays the tool bar. (→ page 133)
Status Bar	Displays the status bar. (→ page 133)
Zoom In 	Zooms in the embroidery data. (→ page 133)
Zoom Out 	Zooms out the embroidery data. (→ page 133)
Zoom In Specified Range 	Zooms in the specified range. (→ page 134)
Fit to Window 	Displays the whole embroidery area. (→ page 134)
Whole Pattern 	Displays the whole embroidery data. (→ page 134)
Grid	Displays 1 x 1 cm square grids on the background. (→ page 135)
Hoop	Displays the outline of embroidery hoop. (→ page 135)
Hoop position fine adjustment	Adjusts the view position of the embroidery hoop. (→ page 135)
Needle Penetration 	Displays the position of needle penetration. (→ page 136)
Thread Color 	Adjusts the color of the embroidery data to the thread spool. (→ page 137)
Needle Bar and Speed Range	Displays needle bar and speed range. (→ page 137)
Grid Setting	Sets the color and the pitch of grid. (→ page 142)
Background color	Changes the background color of the data. (→ page 142)

Tool menu

Language	Changes display language. (→ page 132)
Edit	Allows editing of embroidery data.
Embroidery Data Explorer	Allows selection of embroidery data.
Production Report	Creates production report.
Run Embroidery Data Editor independently	Runs the embroidery data editor. (→ page 188)
Run Embroidery Data Explorer independently	Runs the embroidery data explorer. (→ page 188)
Copy to Another Machine	Copies embroidery data to other machines. (→ page 147)
Configuration	Sets configuration for embroidering. (→ page 148)
Version Upgrades	Upgrades the version of the machine parts. (→ page 148)

Settings menu

Needle Bar	Uses the same needle bar for all embroidering. (→ page 149)
Same Speed Range	Sets the head. (→ page 150)
Pause	Sets whether to stop the needle bars temporarily when changing all the needle bars. (→ page 150)
Speed Range	Defines the speed range. (→ page 151)
Head Operation Suspend	Cancels the head operation which is not halted on the machine side. (→ page 151)
Hoop Feed Position	Sets the hoop feed position. (→ page 152)
Embroidery Area	Sets the area for embroidering. (→ page 152)
Embroidery Hoop	Sets the type of embroidery hoop. (→ page 153)
Thread Trimming	Sets the inching and thread removal amount. (→ page 156)
Boring	Sets boring. (→ page 157)
Thread Breakage Sensor	Sets operation of thread breakage sensor. (→ page 158)
Automatic Step Back	Sets automatic step back count for thread breakage. (→ page 159)
Automatic Hoop Feed	Feeds hoop to the hoop feed position automatically after embroidering. (→ page 159)
Embroidery end setting	Sets if the machine returns to the start point after end of embroidery. (→ page 160)
Mending	Sets details of mending. (→ page 161)
Adjust	Sets the adjusting value. (→ page 162)
Speeding up of main shaft startup	Speeds up the startup speed of the main shaft. (→ page 163)
Hoop feed during temporary stop for color change	Sets whether to feed the hoop during temporary stop of the needle bars to change colors. (→ page 163)
Reducing speed in a short stitch	Reduces speed when stitching in a designated small pitch. (→ page 164)
Thin material or thick material	Adjusts the timing of needle drop and hoop movement. (→ page 165)
Area tracing	Select the outside shape of area tracing before starting sewing. (→ page 166)
Default Settings	Resets changes of the machine setting to the default at the factory shipment. (→ page 167)
Show Setting	Shows the contents of settings. (→ page 168)
Load Setting	Loads the setting details. (→ page 170)
Save Setting	Saves the changed setting. (→ page 171)
Load Hoop	Selects the hoop type. (→ page 172)

Window menu

Cascade	Cascades windows. (→ page 144)
Tile	Tiles windows. (→ page 144)
Arrange Icons	Align icons. (→ page 146)

Description of Screen

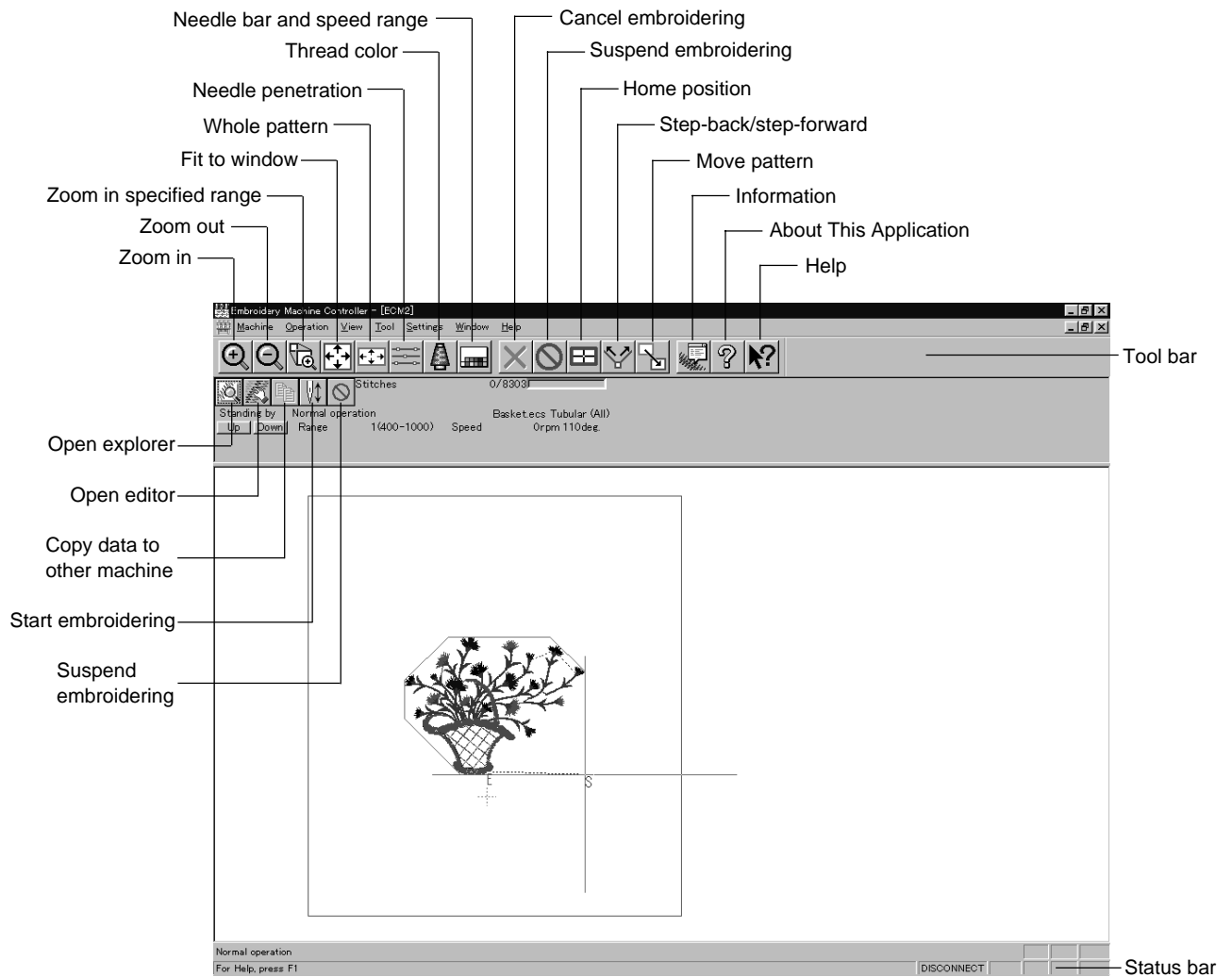

Settings before Turning On the Machine

Describes settings available before the machine is turned on.

■ The following items can be set.

- Displaying the tool bar
- Displaying the status bar
- Upgrading the version of interface board (*)
- Resetting the interface board (*)
- Communication port
- Language

(*) Dealer engineers carries out version upgrading and resetting of the interface board.

Displaying the Tool Bar

Shows/hides the tool bar. The tool bar contains icons with the same functions as the menu.

■ There are two kinds of tool bars as follows:

Main	Main menu items are displayed on this tool bar.
Step Back	This tool bar appears during step-back/forward.

1. Select [Tool Bar] from View menu and put the check mark.

Click here again to remove the check mark. Then the tool bar disappears.

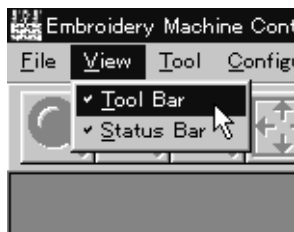

Displaying the Status Bar

Shows/hides the status bar. The status bar provides information on the current status and advice for operation.

1. **Select [Status Bar] from View menu and put the check mark.**

Click here again to remove the check mark. Then the status bar disappears.

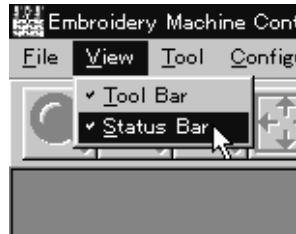

Upgrading the Version of Interface Board

Upgrades the version of interface board program connected to PC. This function is protected by a password. A dealer engineer will use this function if required.

Reset Interface Board

Resets the CPU on the interface board connected to PC to give the same effect as restart.

This function is protected by a password. A dealer engineer will use this function if required.

Communication Port

Sets communication port between PC and machine.

1. **Select [Communication Port] from Configuration menu.**

2. **Select communication port for use.**

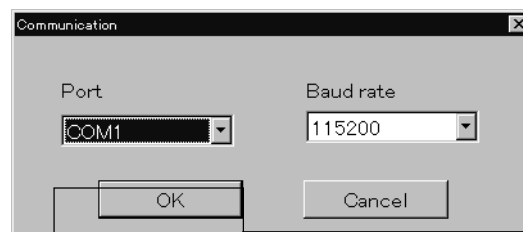

If the required port name does not appear, key-in the name.

3. **Click [OK].**

Language

Changes display language.

■ The following three languages are displayed as "Available Languages".

English	Displays English.
Languages system uses	Displays the system language of PC.
Each respective language	Displays the local language.

1. **Select [Language] from Configuration menu (Tool menu when the power to machine is on).**
2. **Select display language among "Available Languages".**

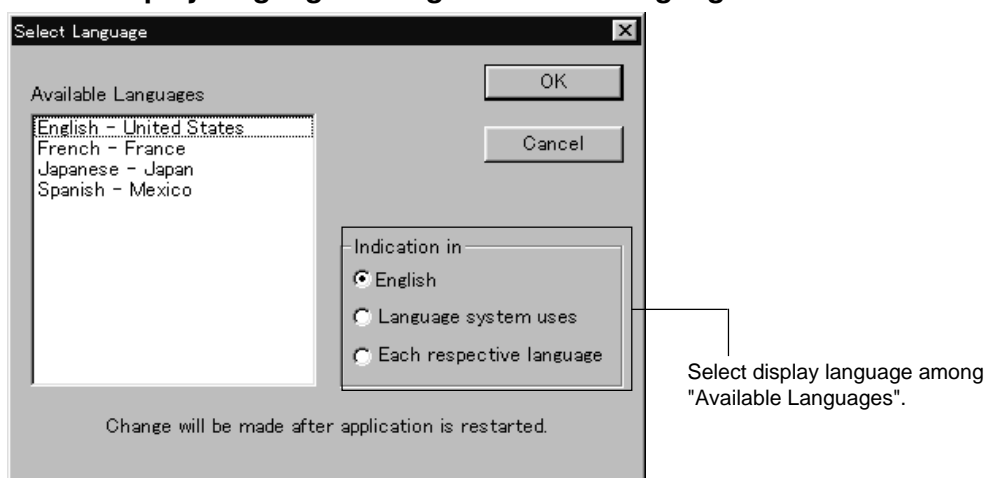

When "Each respective language" is selected, the list for "Available Languages" may not be displayed properly.

3. **Click [OK].**
4. **Exit and rerun the software.**

Settings after Turning Power On

Describes settings available after turning power on to the machine.

Tool Bar

Shows/hides the tool bar. The tool bar contains icons with the same functions as the menu.

Refer to page 130.

Status Bar

Shows/hides the status bar. The status bar provides information on the current status and advice for operation.

Refer to page 131.

Zoom In

Enlarges the image to 125%.

1. Select [Zoom In] from Display menu or click .

Repeats zooming of the image by the number of clicks.

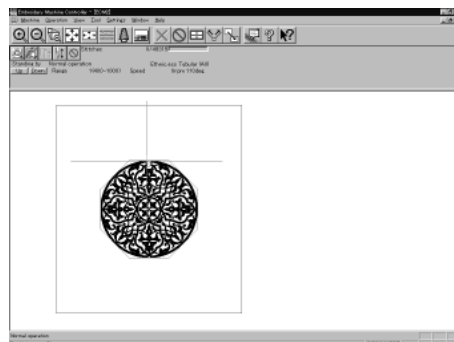

Before selecting

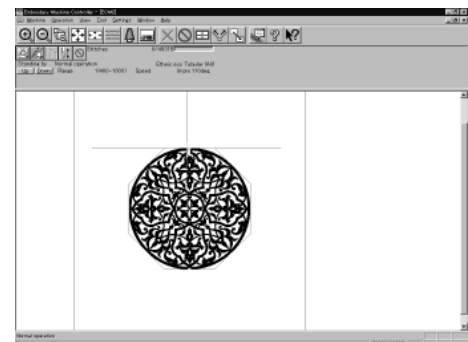

After selecting

Zoom Out

Reduces the image to 80%.

1. Select [Zoom Out] from Display menu or click .

Repeats zooming of the image by the number of clicks.

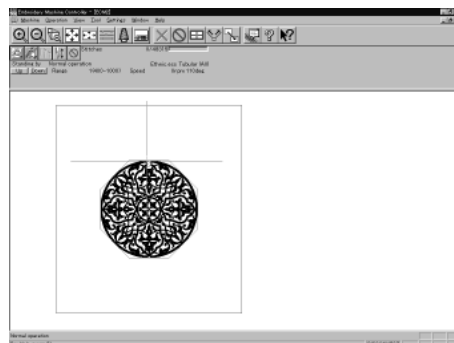

Before selecting

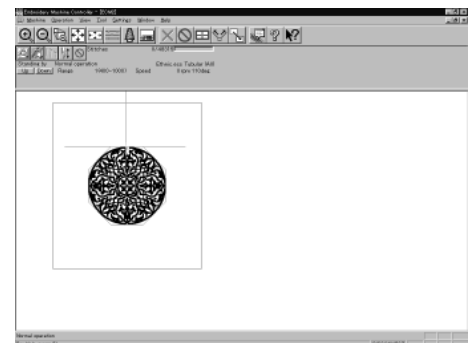

After selecting

Zoom In Specified Range

Enlarges the range specified with the mouse to the full window size.

1. Select [Zoom In Specified Range] from Display menu or click  .
The arrow pointer turns into  .

2. Drag and specify the range to zoom in with the mouse.

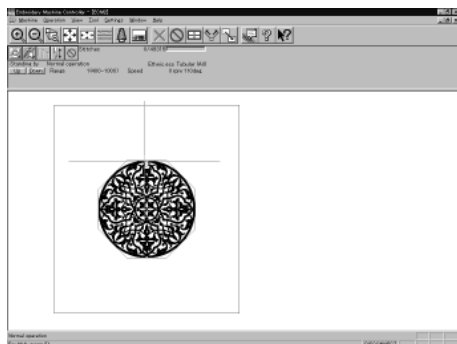

Before selecting

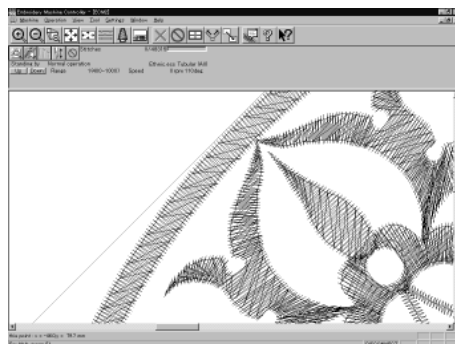

After selecting

Fit to Window

Displays the whole embroidery area.

1. Select [Fit to Window] from View menu or click  .

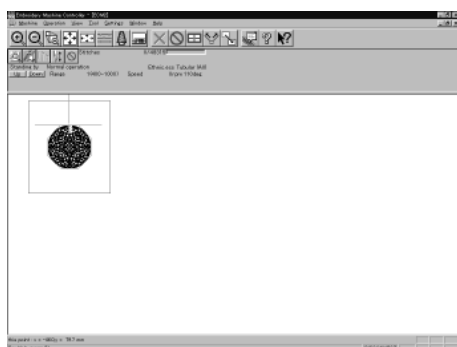

Before selecting

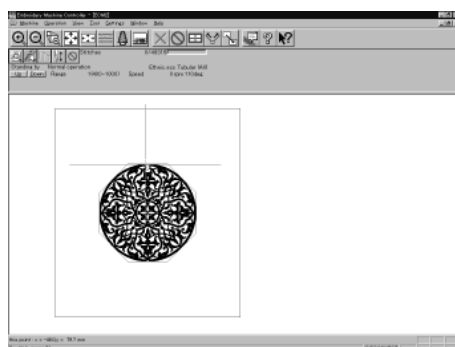

After selecting

Whole Pattern

Displays the whole pattern.

1. Select [Whole Pattern] from View menu or click  .

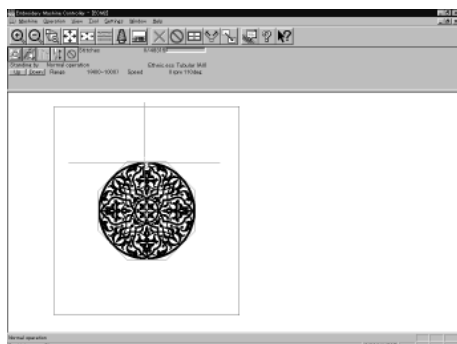

Before selecting

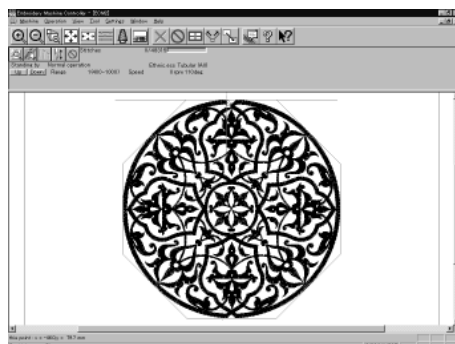

After selecting

Grid

Displays 1 x 1 cm square grids on the background.

1. Select [Grid] from View menu and put the check mark.



Before selecting



After selecting

Hoop

Displays the outline of embroidery hoop. The type of embroidery hoop can be changed in [Load Hoop] of Settings menu.

■ Embroidering is allowed within the green guide in the hoop.

1. Select [Hoop] from the View menu and put a check mark.

If the hoop is not displayed, carry out the step to read the hoop. For details, refer to [Load Hoop] (→ page 172).

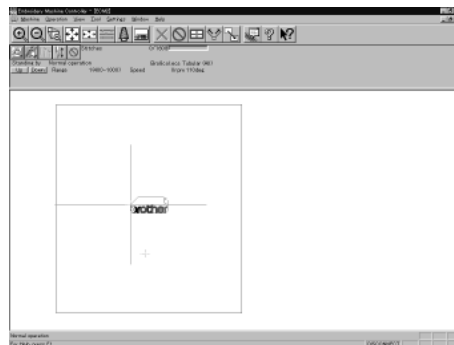

Before selecting

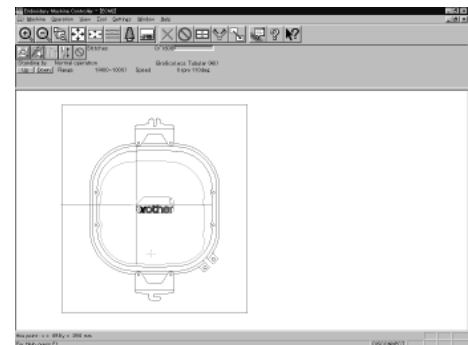

After selecting

Hoop position fine adjustment

Adjusts the view position of embroidery hoop.

■ The position can be adjusted in the range of ± 20 mm in both the X and Y directions.

1. Select [Hoop position] from the View menu.

The hoop view position is stored in the hoop data. If you reinstall the program, the hoop view position is initialized because it is overwritten.

2. Designate the adjusting position and click [OK].

The hoop is displayed in a displaced position.

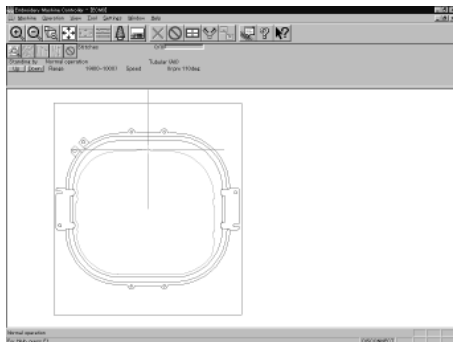
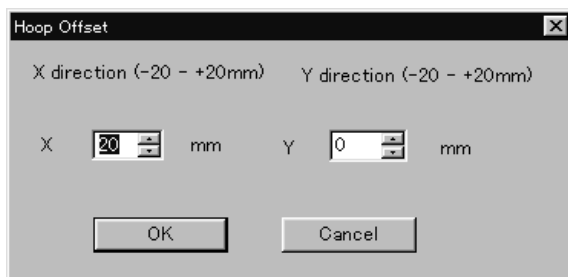

Before selecting

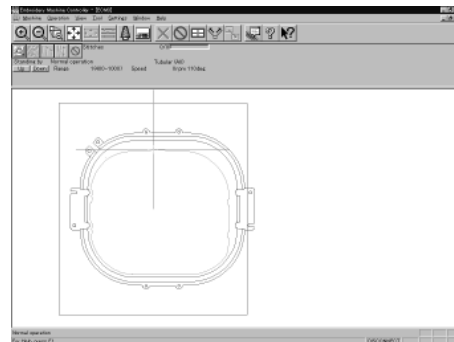

After selecting

Needle Penetration

Chooses whether or not the needle penetration positions are displayed.

Clicking  also provides the same function.

1. Select [Needle Penetration] from View menu and put the check mark.

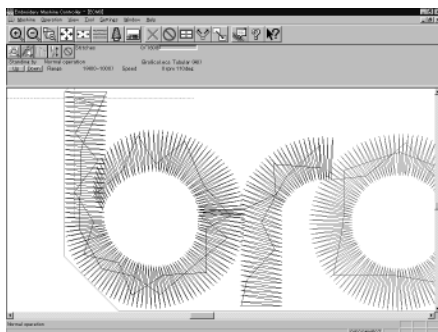

Before selecting

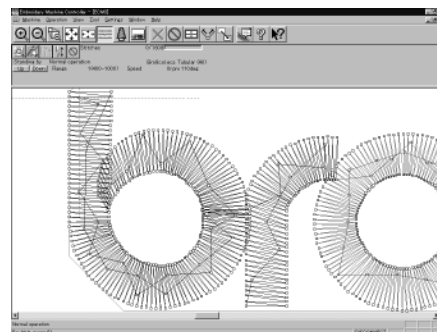

After selecting

Thread Color

Displays the pattern using colors currently set to the needle bar. Clicking  also provides the same function.

1. Select [Thread Color] from View menu and put the check mark. Display color of the image changes.



Before selecting



After selecting

Needle Bar and Speed Range

Displays the needle bar and speed range.

1. Select [Needle Bar and Speed Range] from View menu and put the check mark or click .

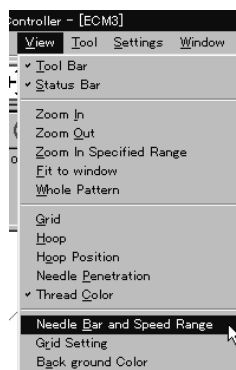

Setting Needle Bar

Needle bar allocation and display color can be changed on this screen.

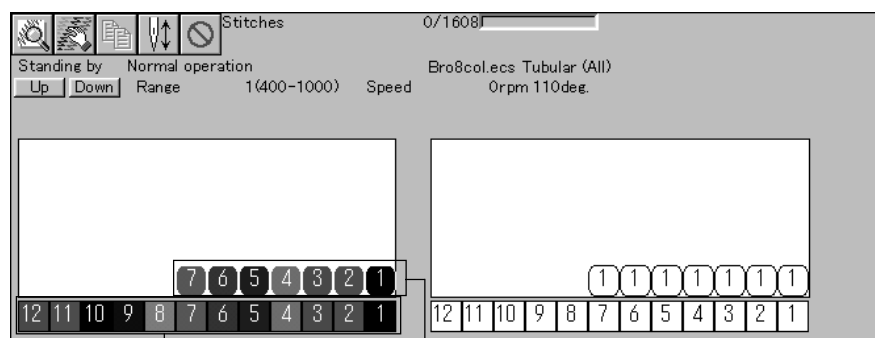

To display needle bar number and color

To display embroidering sequence and color

Changing display colors

- The color of needle bar changes to the actual color.
- Changing the thread spool also changes the display color. A confirmation screen to save appears before exiting from embroidering or retrieving other data.
- A display color can be selected from among the following four items.

Basic color which can be selected screen on the "Color selection"	Refer to steps 1 and 2.
Color sample supplied by a manufacturer	Refer to steps 1 and 3.
Color sample created by a user	Refer to steps 1 and 3.
Adjustment of an intermediate color from the color sample supplied by a manufacturer or naming and registration of a newly created color	Refer to steps 1 to 7.

- The following screen is displayed when colors to be displayed are set to 256 in [Display properties] and the color sample supplied by a manufacturer cannot be selected or an intermediate color cannot be created.

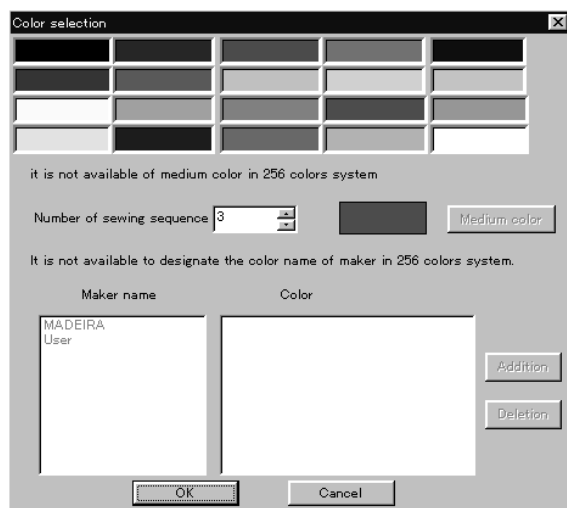

1. Double-click the thread spool or needle bar number.

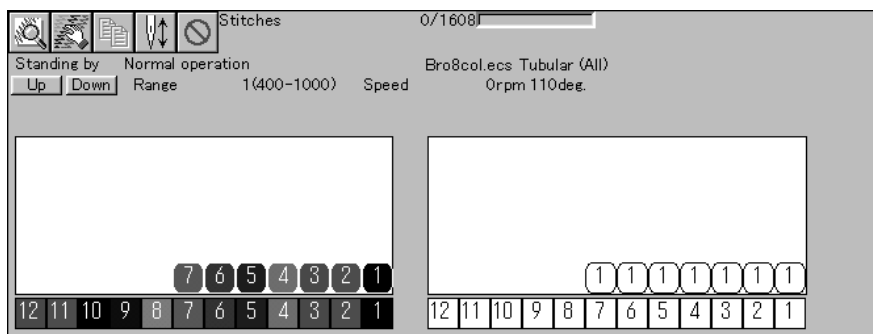

2. Select a new color on the [Color selection] screen.

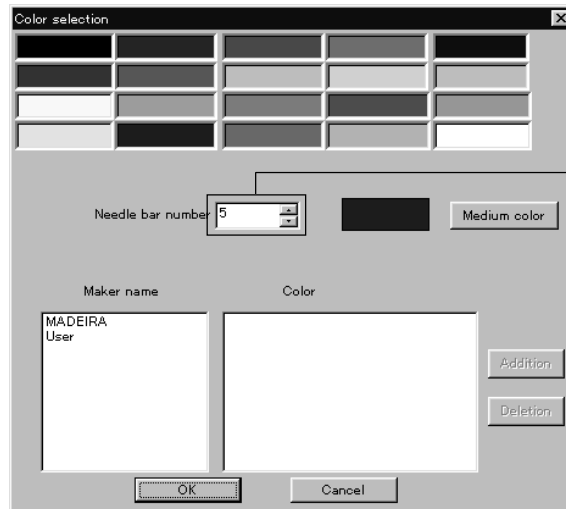

The needle bar number can be changed.

3. When selecting a color from a color sample, click maker name or [User] and double click [Color].

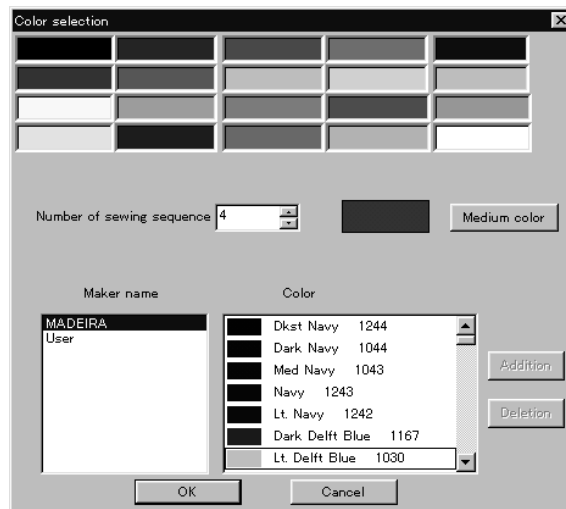

4. When finely adjusting the selected color, click [Medium color]. Click [User] to crate a new color, then click [Addition].

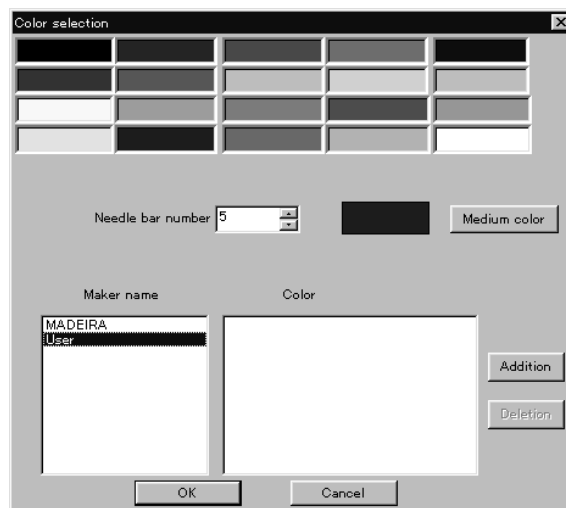

5. Select an arbitrary color from basic colors.
Click [Define Custom Colors] to create a medium color.

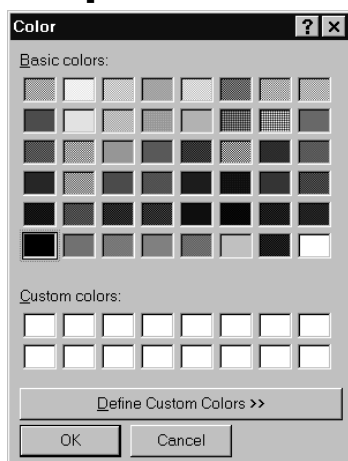

6. Click the color chart or enter values to create a new color, and click [OK].

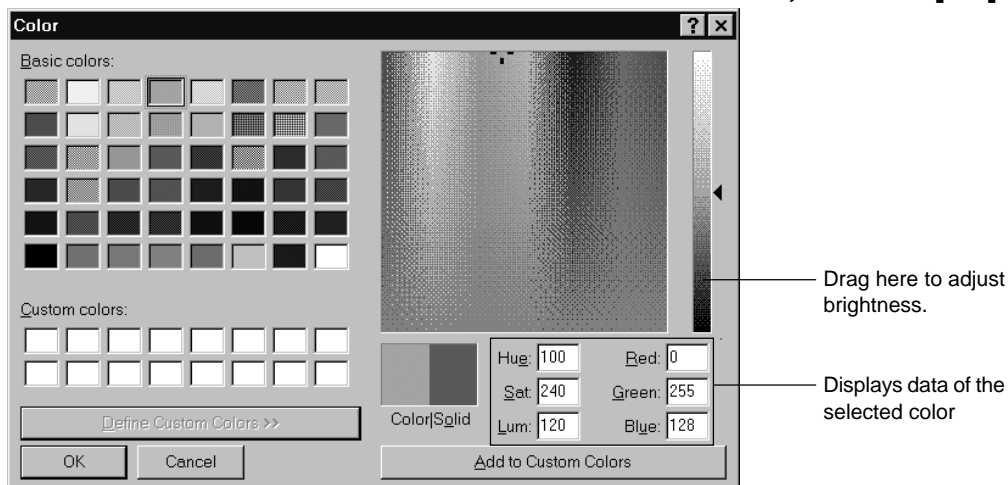

7. Input the name of the color and click [OK] when [User] is selected in step 4.

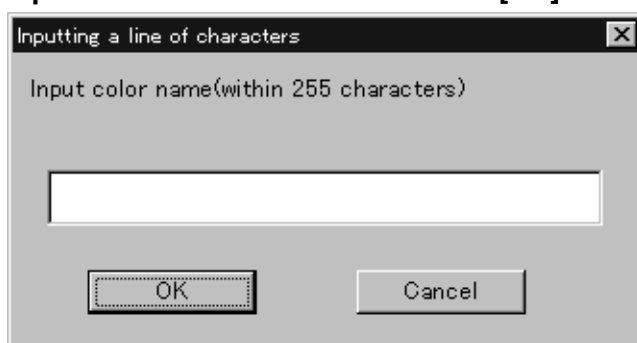

Changing needle bar allocation

1. Drag a thread spool to the desired needle bar number.

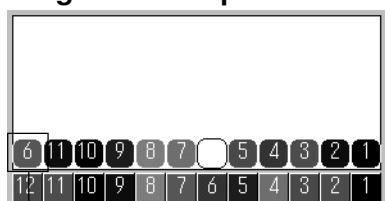

— This thread spool has been dragged

Setting Ranges

There are two methods for setting ranges.

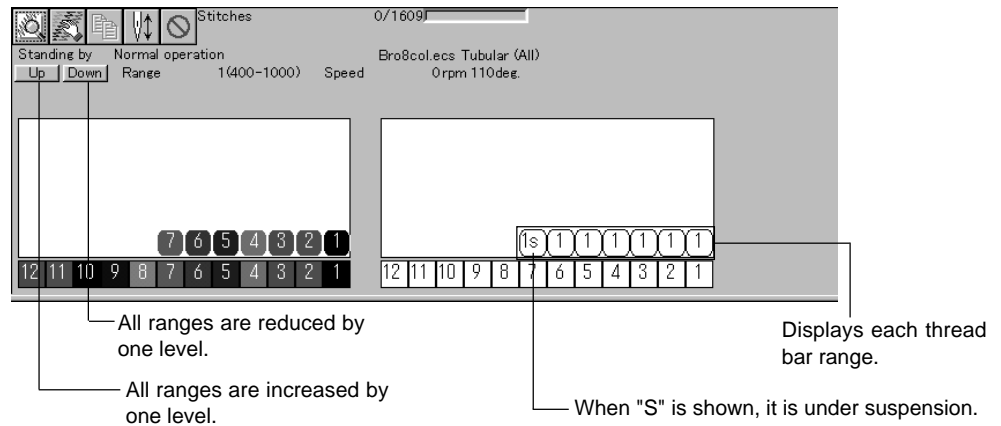

Changing all ranges

1. Click [Up] to increase range. Click [Down] to reduce range.

One clicking changes the range by one level.

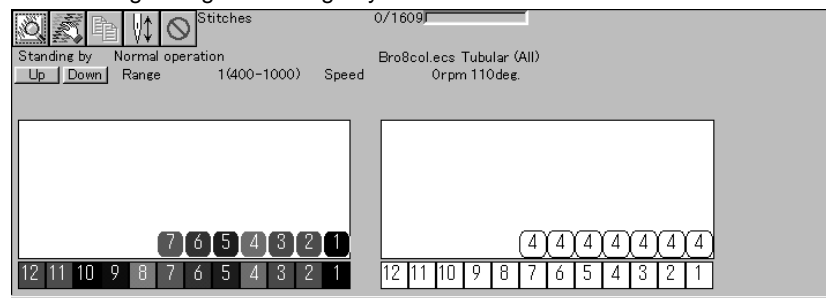

Changing individual range

1. Double-click the range display.
2. Click a speed range for selection.

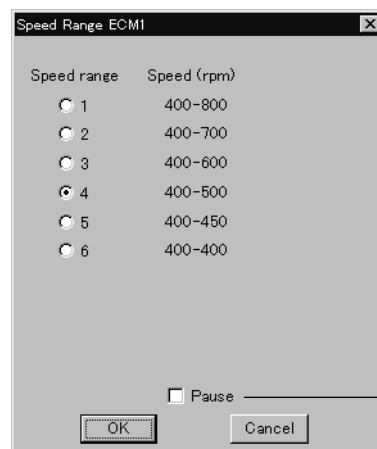

Click here to put a check mark for pause before starting the designated embroidering sequence.

3. Click [OK].

Grid Setting

Sets the pitch and the color of grid.

- The grid interval can be set at the increment of 1 mm (0.1 inch for inch unit).
- The value for setting is 1 - 100 mm (0.1 - 10 inches for inch unit).

1. Select [Grid setting] from the View menu.

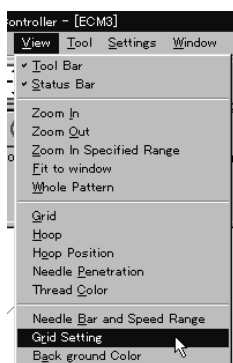

2. Set the pitch.

Click the [color] to change the grid color. For setting, refer to steps 5 to 7 in page 140.

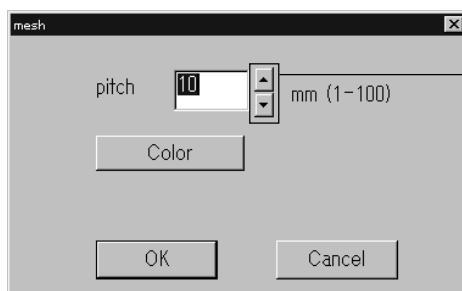

Click this to increase or decrease the value.

Background color

Changes the background color of the data.

1. Select [Background color] from the [View] menu.

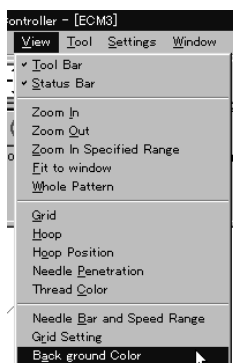

2. **Select or create the background color. Refer to steps 5 to 7 on page 140 for details.**

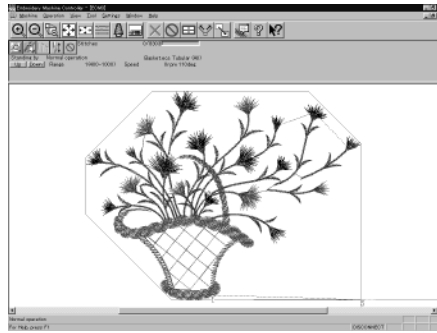

Before changing the background color

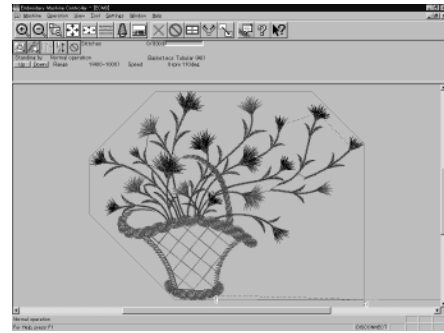

After changing the background color

Renaming Machine

Rename the registered machine.

- Up to 50 half-size (25 full-size) characters can be registered for a machine name.

1. **Select [Rename Machine] from Machine menu.**
2. **Enter a new name.**

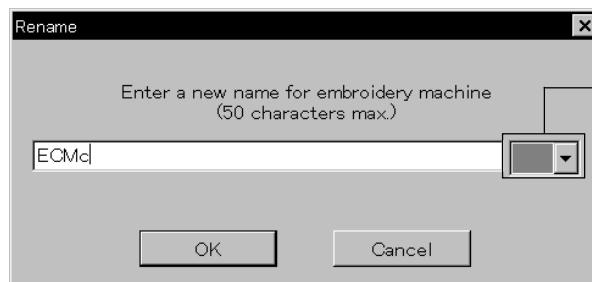

Select an identifying color for the machine. This color is shown on the title bar for a while when the arrow pointer is moved to the title bar of a machine window.

3. **Click [OK].**

If the message "The entered name already exists" appears, enter another name.

Viewing Machine Information

Detail specification of the machine can be displayed.

1. Select **[Machine Information]** from **Machine** menu.
2. Click **[OK]** after checking the information.

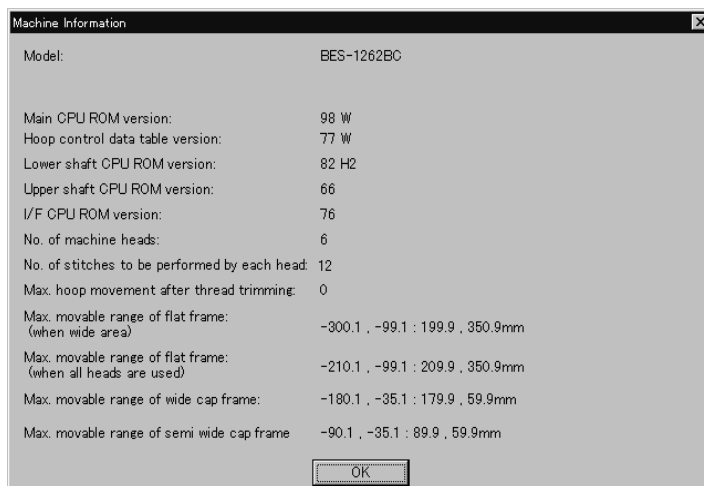

Design Information

Detail specification of the embroidery data can be checked.

Pattern name	File name and path of embroidery data
No. of stitches	The number of stitches in embroidery data
No. of colors	The number of colors used in embroidery data
Mask Size	Size of masking
Start of Embroidering	Coordinates of embroidering start position
End of Embroidering	Coordinates of embroidering end position

1. Select **[Design Information]** from **Help** menu or click  .
2. After checking, click **[OK]**.

Setting Window Display

Specifies the window that displays machine condition if multiple machines are connected simultaneously.

- There are two types of window display as follows:

Cascade	Windows are slightly offset.
Tile	Windows are tiled.

1. Select [Cascade] or [Tile] from Window menu.

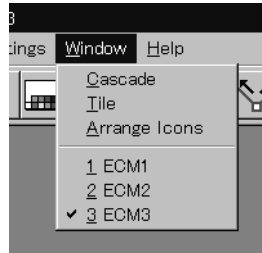

When [Cascade] is selected

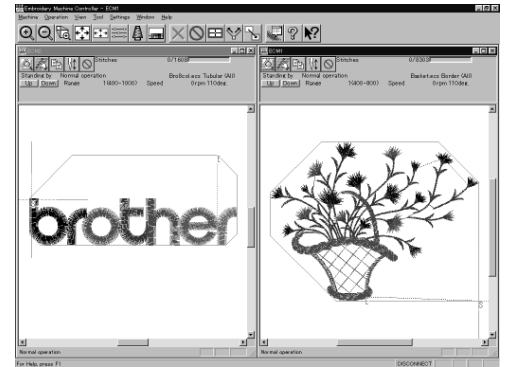

When [Tile] is selected

Minimizing and Aligning Windows

Windows on the screen can be minimized to the icon size and aligned.

Minimize Window Size

1. Select [Minimize Window Size] from Machine menu or click  on the upper right corner of the screen.



Click here.

2. The window is minimized.

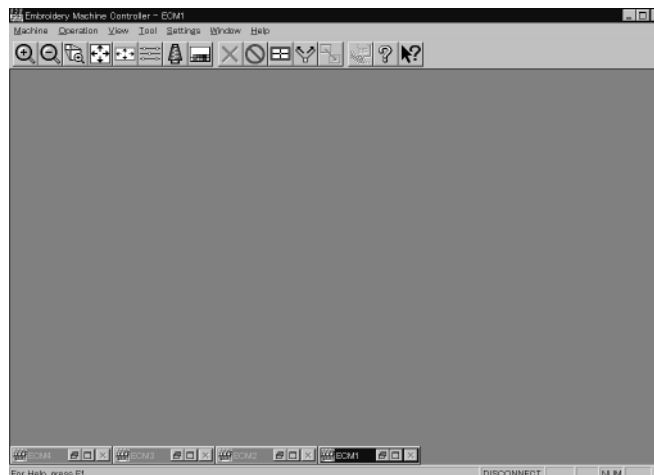

Arrange Icons

Minimized windows that are scattered can be aligned.

■ This command is available for minimized windows.

1. Select [Arrange Icons] from Window menu.

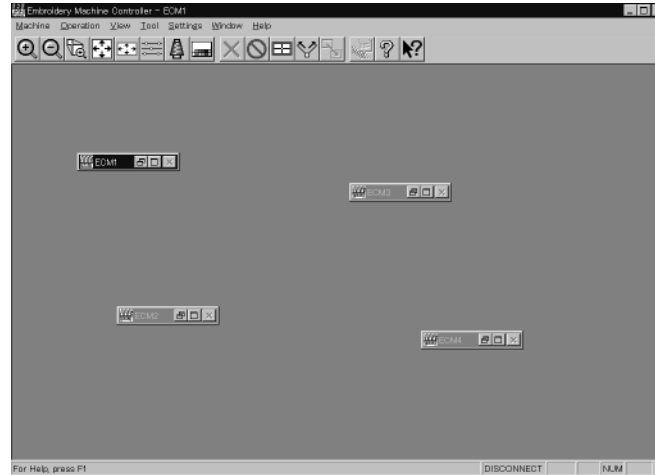



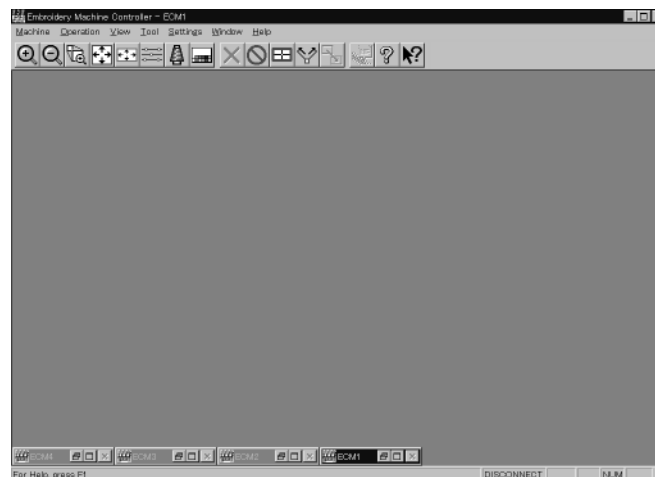

2. The minimized windows are aligned.



Changing window size

Several square buttons with figures are displayed at the right end of the title bar. These buttons are used to change the window size.

-  If this button is clicked when running an ordinary software, it is displayed on the task bar in the minimized size as a button.
-  If this button is clicked, the window size changes to a medium size.
-  If this button is clicked, the window changes to the full size of the desktop.
-  This button is used to end the software or to close the folder. This button cannot be clicked when the machine window is displayed.

Language

Changes display language.

Refer to page 132.

Copying Data to Other Machines

When multiple machines are connected, the embroidery data of a machine can be copied to another machine.

1. Click the window of the machine displaying the copy source data.

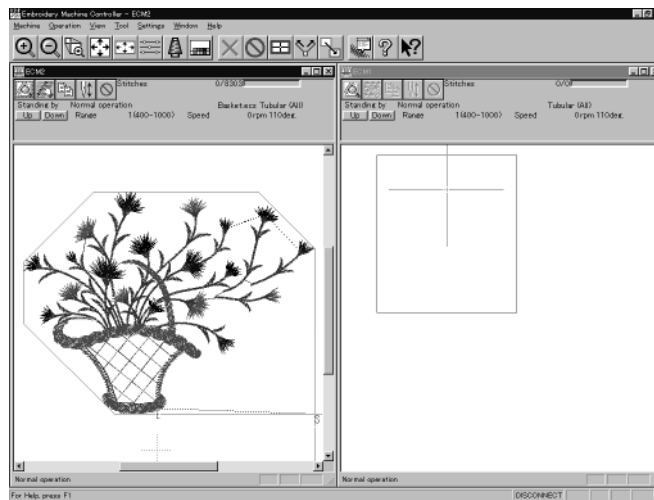

2. Click  .

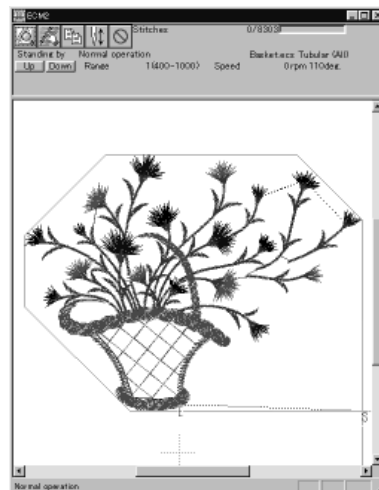

3. Click and select the machine name of the destination.

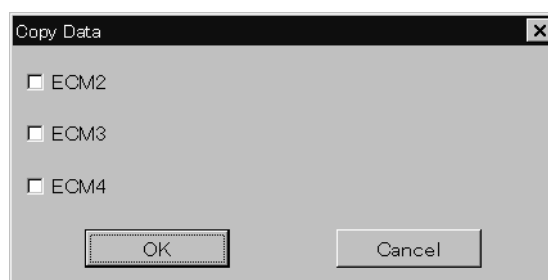

4. Click [OK].

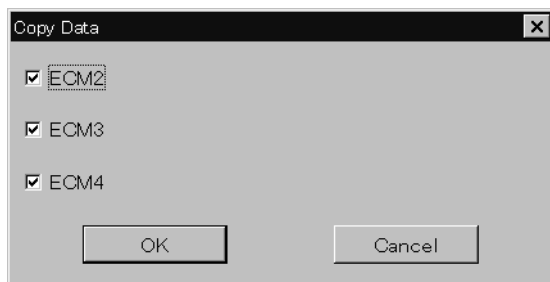

The data, is copied.

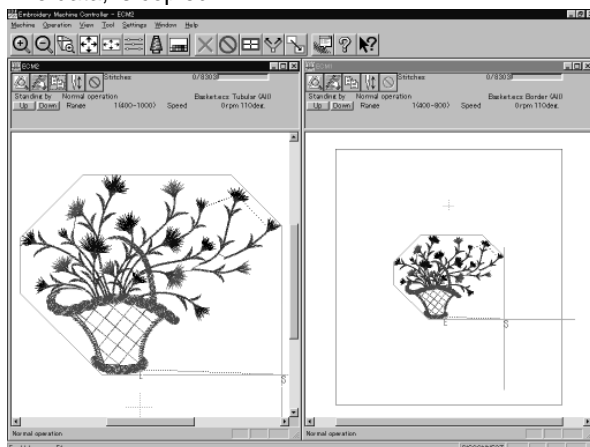

Configuration

Sets the environment of data reading and display.

1. Select [Configuration] from Tool menu.
2. Click and select the item for setting.

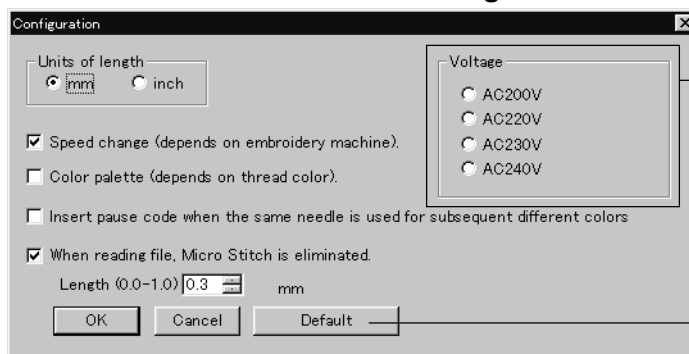

Select the applicable power voltage.

Click here to the default setting.

[When reading file, Micro Stitch is eliminated.] is set to be deleted in default status (checked).

3. Click [OK].

Upgrading the Machine Program

Upgrades the programs at each part of the machine.

This function is protected by a password. A dealer engineer will use this function if required.

Setting the Machine

Performs the detail setting of the embroidering status. Items that can be selected in Setting menu are explained here.

Needle Bar

Patterns are sewn by one needle.

1. Select the [Needle]-[Same Needle] from Settings menu.
2. Click the needle number for selection.



3. Click [OK].

The embroidering sequence appears at all specified needle points.

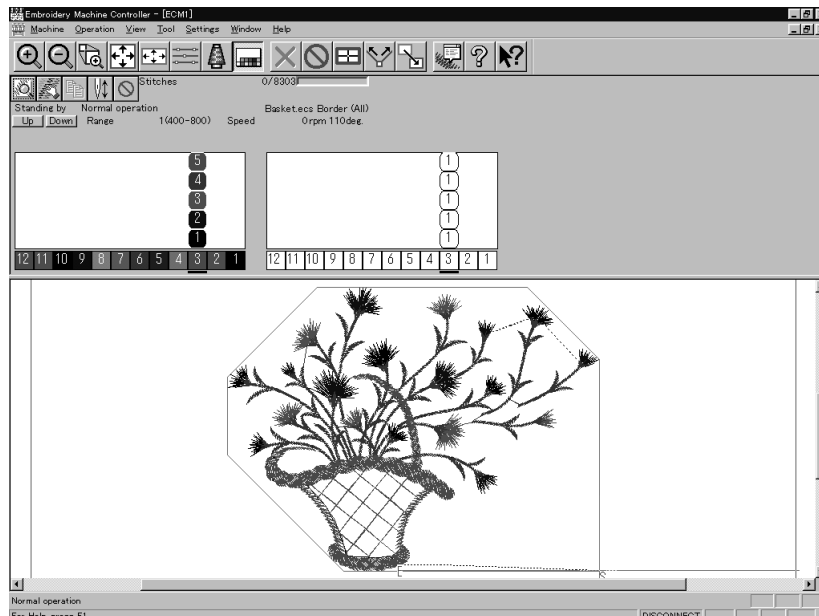

Default setting (equating the sewing order number and needle bar number)

1. Select [Needle] - [Default] from Settings menu.

Same Speed Range

Embroiders patterns at the specified speed range.

1. Select **[Same Speed Range]** from **Settings** menu.
2. Click a speed range for selection.

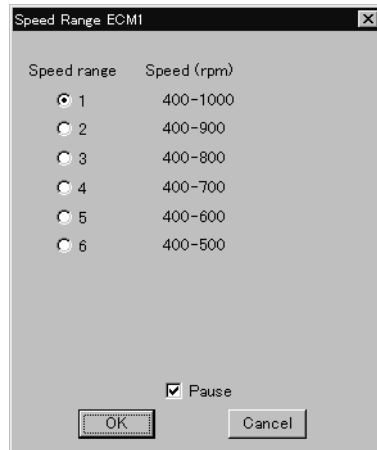

3. Click **[OK]**.

The speed range appears at the specified areas.

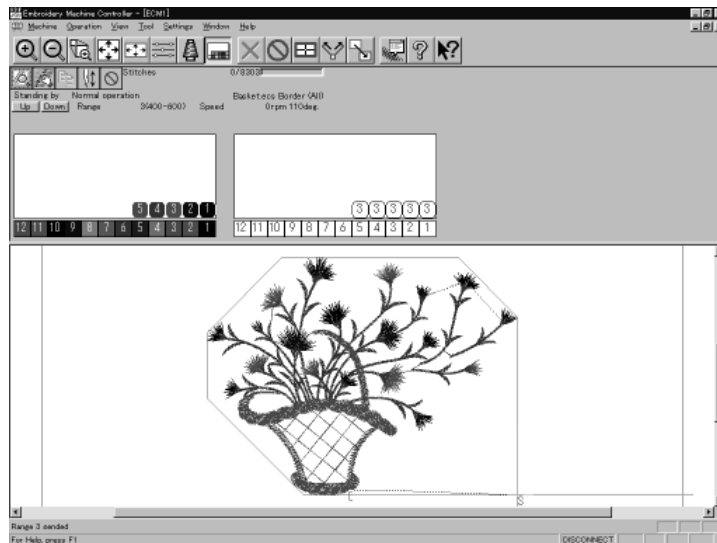

Pause

Sets whether to stop the needle bars temporarily when changing all the needle bars.

Stopping all the needle bars temporarily

1. Select **[Pause] - [Add all]** from **Settings** menu.

Resetting temporary stop of all the needle bars

1. Select **[Pause] - [Delete all]** from **Settings** menu.

Speed Range

Specifies the maximum speeds for respective ranges suitable for the hoop type.

- Actual embroidering speed depends on the pitch.
- Before shipment, "1" is set to the highest speed; "6" is set to the lowest speed.

1. Select [Speed Range] from Settings menu.
2. Specify the desired range.

Range	Minimum	Maximum	(rpm)
1	400	1000	(400-1000)
2	400	900	(400-900)
3	400	800	(400-800)
4	400	700	(400-700)
5	400	600	(400-600)
6	400	500	(400-500)

Indicates ranges of the current setting.

When a value exceeding the above ranges is entered, it is automatically set to the min. or max. speed.

3. Click [OK].

Head Operation Suspend

Sets the machine head for rest.

- Setting at the machine head has priority.
- When the HEAD switch at the machine head is set to ON and then to OFF, the setting is canceled.

1. Select [Head Operation Suspend] from Settings menu.
2. Click the machine head that needs to be at rest and remove the check mark.

Head operation suspend

3. Click [OK].

Hoop Feed Position

Set the basic position of the hoop (hoop feed position) for cancellation of embroidering.

- The hoop feed position can be set only in the embroidering area surrounded by a red frame.

1. Select [Hoop Feed Position] from Settings menu.
2. Click the point to feed the hoop.

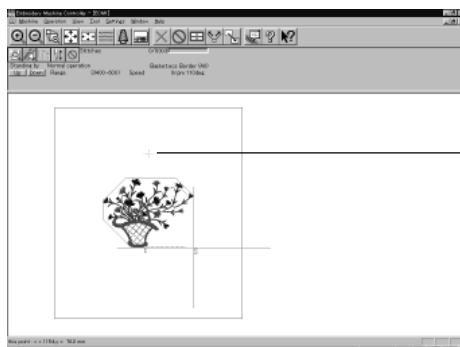

Hoop feed position

3. The gray cross appears and shows the hoop feed position.

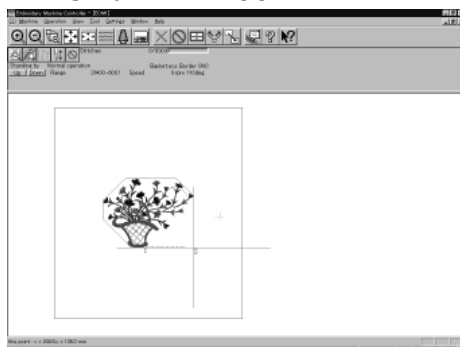

Embroidery Area

Sets the embroidery area.

1. Select [Embroidery Area] from Settings menu.
2. Drag the embroidery area using the mouse for designation.

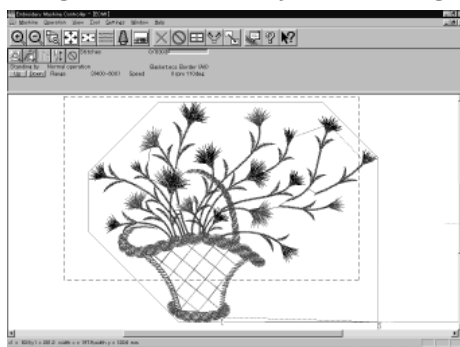

The embroidery area is displayed in light blue.

Embroidery Hoop

The type of specified embroidery hoop changes the display.

■ The following selections are available:

Tubular (All)

Tubular (1, 3, 5)

Flat (All)

Flat (1, 3, 5)

Border (All)

Border (1, 3, 5)

Wide cap frame

Semi-wide cap frame (All)

1. Select [Embroidery Hoop] and the type from Settings menu.

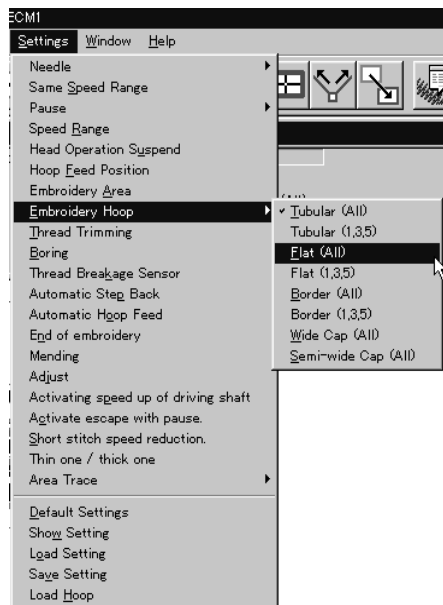

The pattern direction and embroidering area may vary depending on the selected embroidery hoop type. Make sure that the selection is correct.

■ When "Tubular (All)" is selected

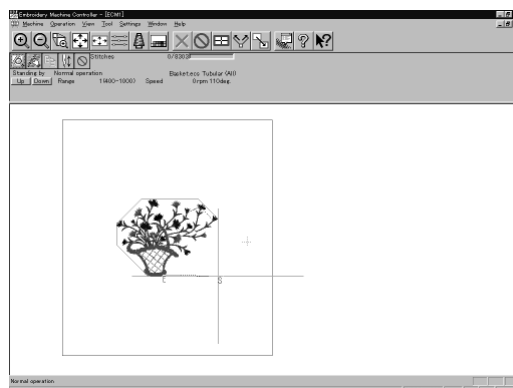

■ When "Tubular (1, 3, 5)" is selected

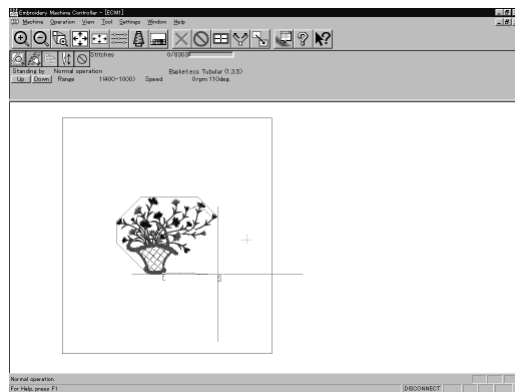

■ When "Flat (All)" is selected

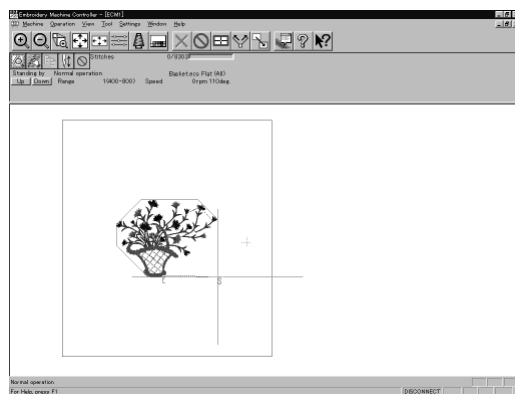

■ When "Flat (1, 3, 5)" is selected

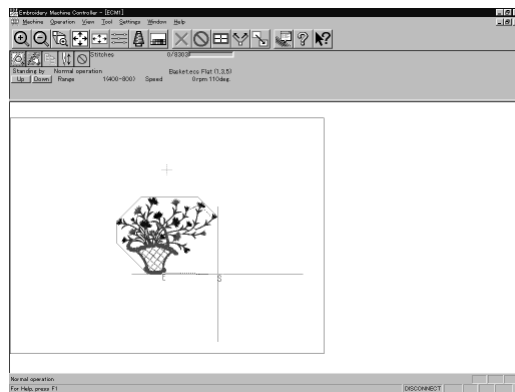

■ When "Border (All)" is selected

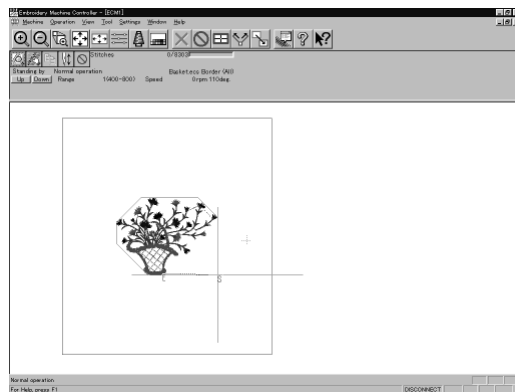

■ When "Border (1, 3, 5)" is selected

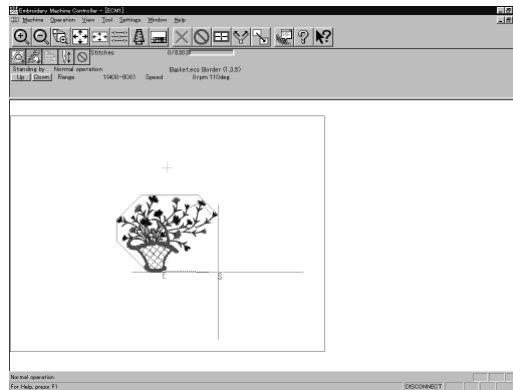

■ When "Wide cap (All)" is selected

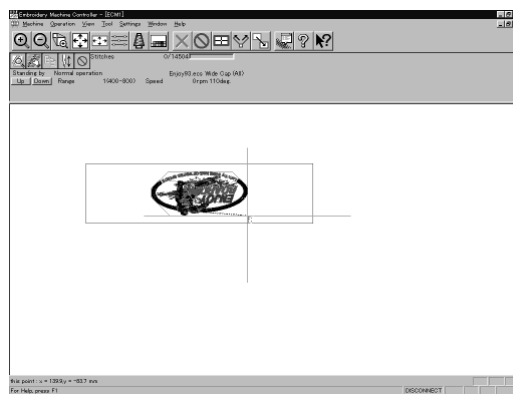

The image is displayed upside down.
The speed is automatically adjusted to 800 rpm or less.

■ When "Semi-wide cap (All)" is selected

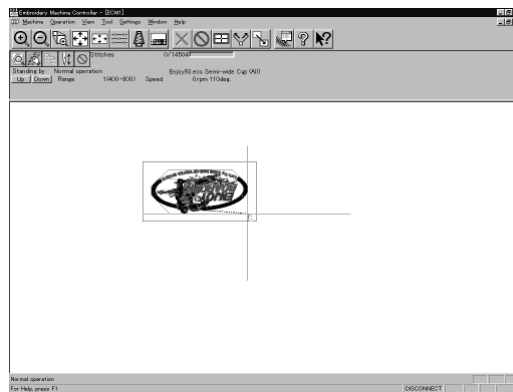

The image is displayed upside down.
The speed is automatically adjusted to 800 rpm or less.

Thread Trimming

■ The following items can be set:

Enable inching	Sets inching motion for thread trimming.
Hoop movement after thread trimming	Sets the needle penetration length for trimming. The length can be set in inches. To set the length in inch unit, select [Inch] from the [Configuration] of Tool menu. The available values are as follows: For mm 0 - 100 mm (The standard value is 15 mm.) For inch 0 - 3.9 inch (The standard value is 0.6 inch.)
Thread length (1-10) for all machines	Sets the overall thread amount through the needle. Value of 1 to 10 can be set. The smaller the value is, the shorter the length is.
Thread length after thread trimming	Sets the overall thread amount through the needle. Value of 1 to 10 can be set. The smaller the value is, the shorter the length is.

1. Select [Thread Trimming] from Settings menu.
2. Set inching, thread length, etc.

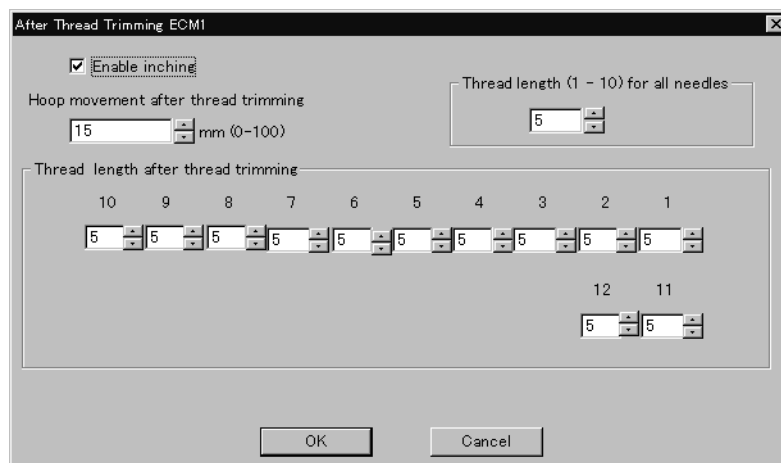

3. Click [OK].

Boring

Turns on/off the machine boring mode.

■ The following items can be set:

Boring	Sets ON/OFF of boring.
Shift data	Shifts data by 15 mm to needle number 1. The screen display remains unchanged.

■ Boring can be set only for embroidery data which is prepared for boring. Make sure that the data is correct before embroidering.

■ Install the following optional parts on the machine before embroidering.

- Boring knife
- Needle plate for boring

■ If the embroidery data for boring is zoomed in or out, or is rotated, embroidering may not be correctly carried out.

1. Select [Boring] from Settings menu.

When the boring mode is on, the check mark (✓) appears at the top of [Boring] in the menu.

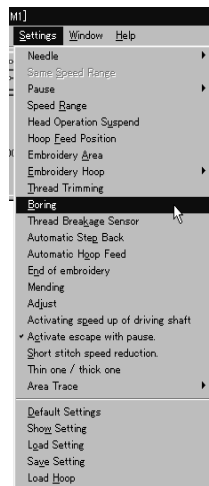

2. Click the setting item to put the check mark.

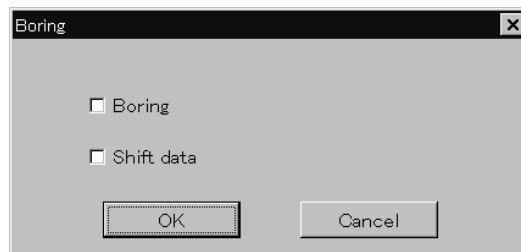

3. Click [OK].

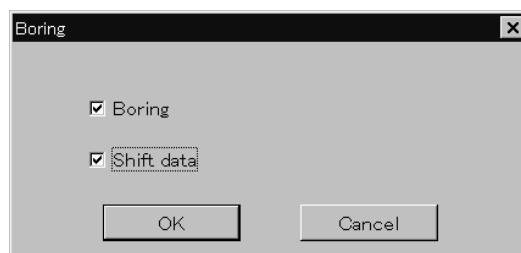

Thread Breakage Sensor

The sensor for thread breakage can be turned ON/OFF or the sensor sensitivity for each needle bar can be set.

■ The sensitivity can be set within the range of 1 - 100. The smaller the value is, the higher the sensitivity is.

1. Select [Thread Breakage Sensor] from Setting menu.
2. Click the head you want to disable the sensor and remove the check mark (√).

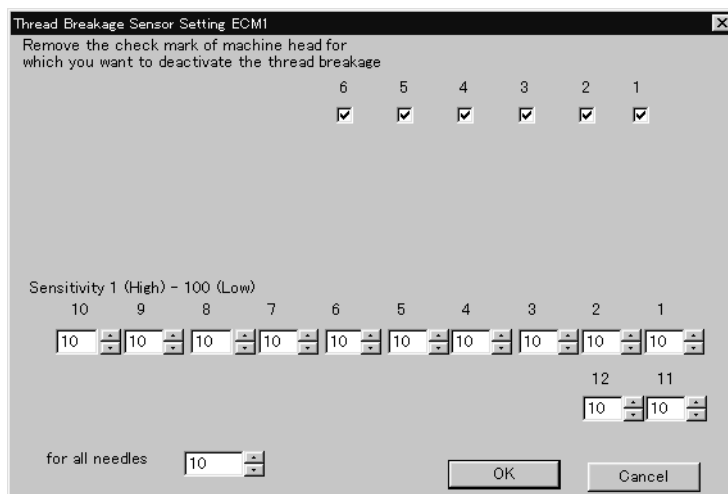

3. Adjust the sensor sensitivity.

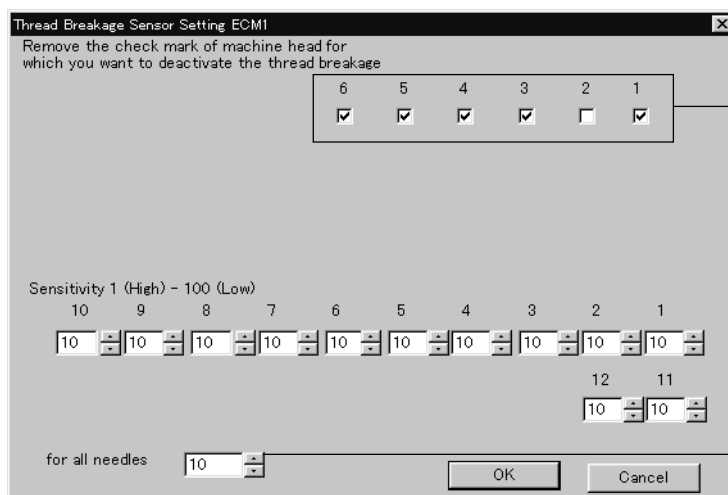

4. Click [OK].

Automatic Step Back

Sets the number of stitches for automatic step back if thread breakage occurs.

- The number of stitches that can be set is from 0 to 255.
- Additional step-back can be made for sensitivity value of the thread breakage sensor.

1. Select **[Automatic Step Back]** from **Settings** menu.
2. Enter the number of stitches for automatic step back.

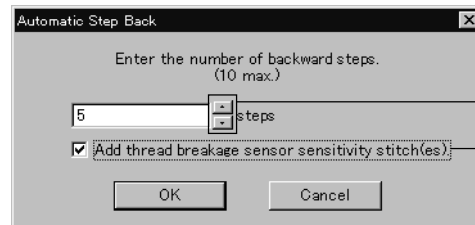

Click here, and the value decreases/increases.

Click here to give additional step-back for the sensing distance with the thread breakage sensor.

3. Click **[OK]**.

Automatic Hoop Feed

Sets automatic hoop feed for a thread breakage.

1. Select **[Automatic Hoop Feed]** from **Settings** menu and put the check mark (√).

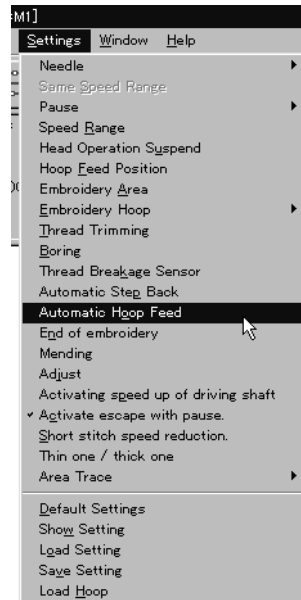

End of embroidery

Sets if the machine returns to the start point after end of embroidery.

1. Select [End of embroidery] from Settings menu.

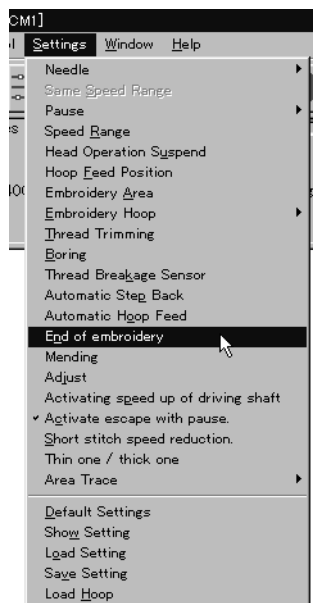

2. Click the checkbox to put a check mark (✓) when the machine returns to the start point after end of embroidery. Click [OK].

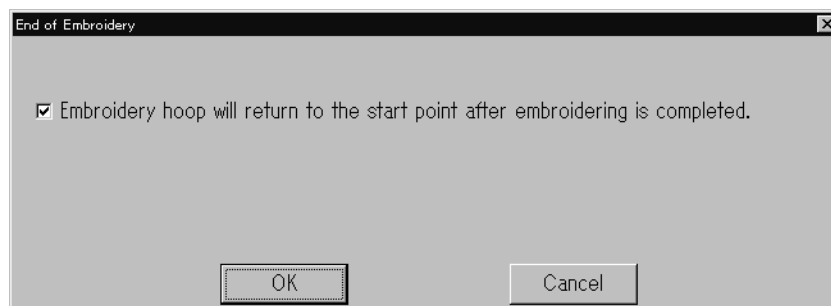

Mending

Sets the details of mending.

■ Items and descriptions are as follows:

Automatically reset breakage error	Error is automatically canceled when a thread breakage occurs.
Thread entangled error to rotary hook	Selects how to reset the rotary hook thread entanglement error.
After the end of mending	Sets whether to stop or suspend the needle bar at the mending end position.
Raise the presser foot when clearing a thread trimming error	Raises the presser foot when resetting the thread trimming error.
Stitches before mending	Sets the number of stitches for stopping before mending. The values for setting are 1 - 10.
When the machine is stopped	Selects how the trimming is made during stopping.
Insert lock stitch at the beginning of sewing after thread breakage	Automatically conducts lock stitch when trimming thread.

1. Select [Mending] from Settings menu.

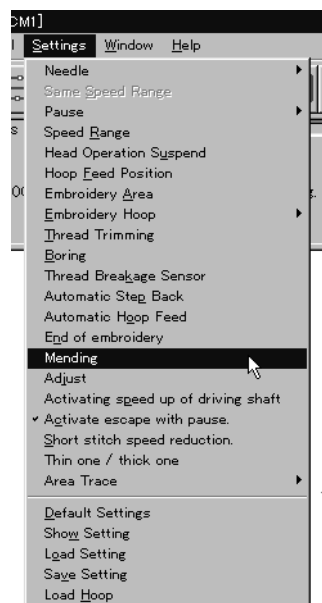

2. Click [OK] when the items are set.

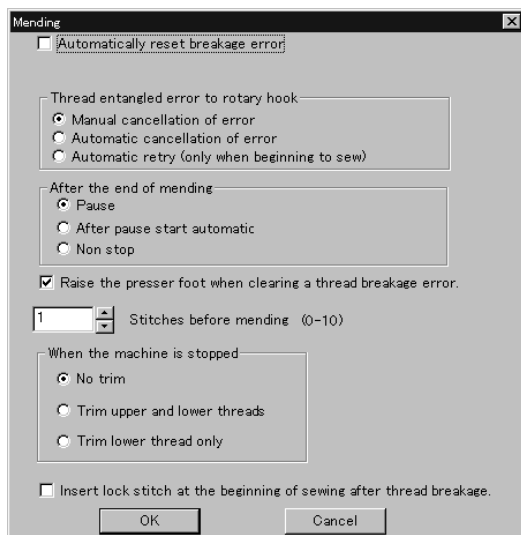

Manually trim the lower thread immediately after resetting a thread breakage error if feeding by stitch back is long (i.e., 40 to 50 mm or more) when "After the end of mending" is set to "Non stop".

Set "When the machine is stopped" to "Trim lower thread only".

Adjust

Adjustment value of the needle is set.

■ The adjustment value is set at the increment of 0.1 mm.

■ The setting range is $-0.5 \sim 2$ mm in X and Y directions.

1. Select [Adjust] from Settings menu.

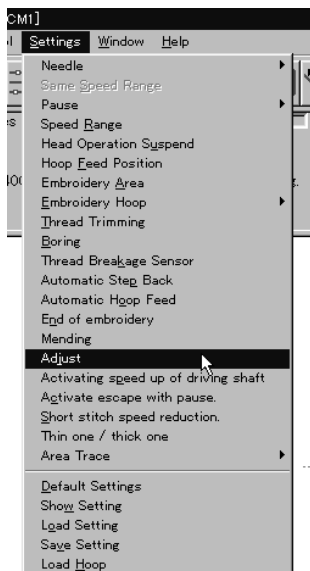

2. When setting is complete, click [OK].

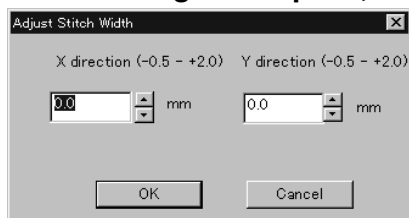

Activating speed up of driving shaft

Speeds up the startup of the main shaft. Select this function when sewing thick material.

1. Select [Activating speed up of driving shaft] from Settings menu and check it.

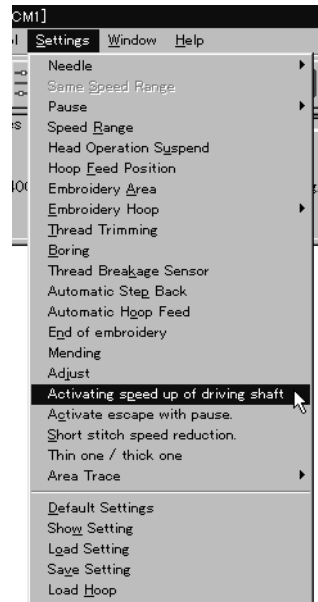

Activate escape with pause

Sets whether to feed the hoop during temporary stop of the needle bars to change colors. Select this function when embroidering applique.

1. Select [Activate escape with pause] from Settings menu and check it.

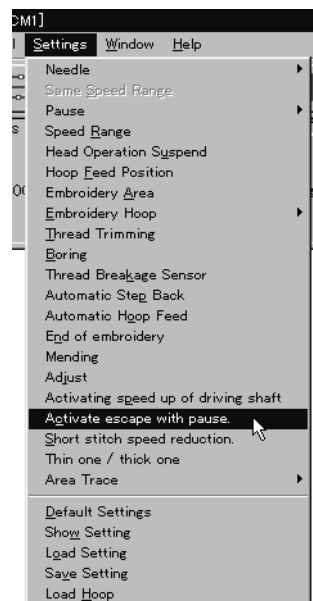

Short stitch speed reduction

Reduces speed when stitching in a designated pitch.

- The pitch can be designated between 0.0 and 2.0 mm in units of 0.1 mm.
- The speed can be set between 400 rpm and the maximum speed of the current hoop in units of 10 rpm.

1. Select [Short stitch speed reduction] from Settings menu.

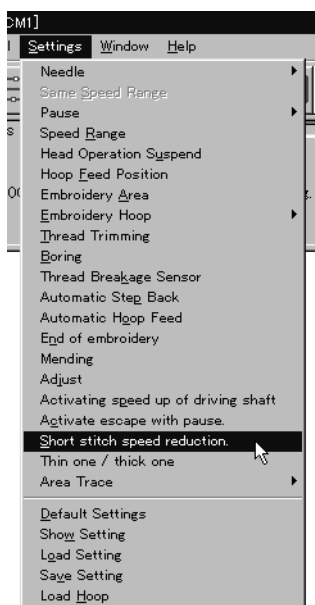

2. Click [Reducing speed] to check it and click [OK] when items are set.

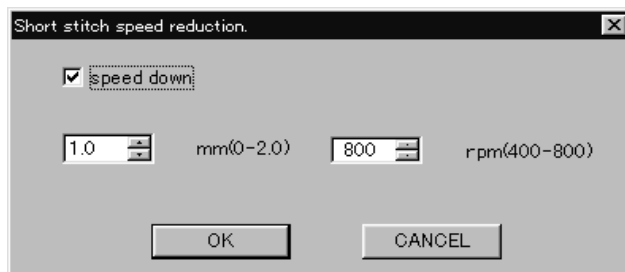

Thin Material or Thick Material

Adjusts the timing of needle drop and hoop movement.

- The value can be designated between 95 and 125 degrees in units of 1 degree. The smaller values are suitable for thick material and the larger ones are suitable for thin material.

1. Select [Thin material or thick material] from Settings menu.

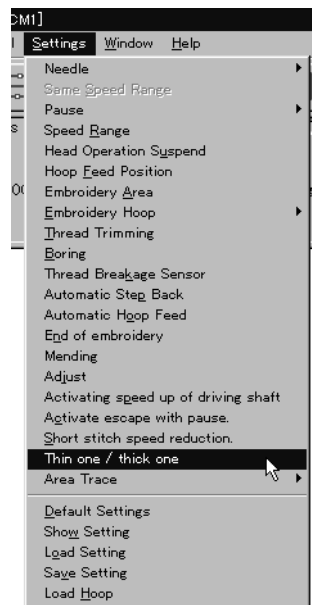

2. Adjust the value by moving the slide bar control. Click [OK] when it is set.

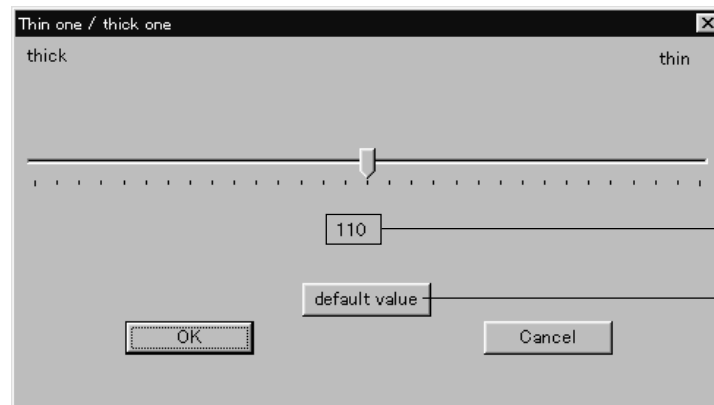

The selected value is displayed.

Clicking this button will reset the value to the standard one (110).

Area Trace

Select the outside shape of area tracing before starting sewing.

- The following two types can be selected. The selected outside shape is displayed on the screen.



Rectangle

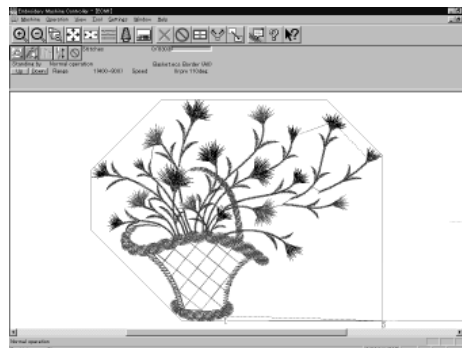

Octagon

1. Select the outside shape of [Area trace] from Settings menu and check it.

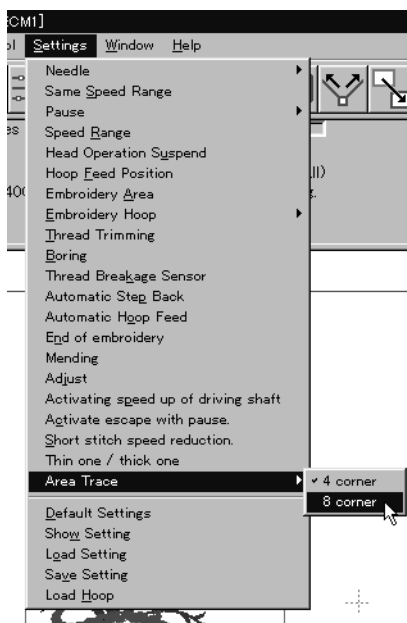

Default Settings

Resets changes of the machine setting to the default.

■ Items for setting and initialization are as follows:

Speed Range	Automatically selects the value suitable for the hoop type.	
Head Operation Suspend	Cancels the head operation which is not set for rest on the machine.	
Hoop Feed Position	Returns to the machine home position.	
Embroidering Area	Sets the size each for the selected hoop.	
Thread Trimming	Inching motion	Yes
	Thread removal feed length	15 mm (0.6 inch)
	Thread remaining amount	5
Boring	Boring	No
	Data shift	No
Thread Breakage Sensor	All sensors are on.	
	Sensitivity	10
Automatic Step Back	0	
Thread Breakage Sensor Sensitivity	Not affected by the thread breakage sensor sensitivity	
Automatic Feed Hoop	No	
Return to the start point	Yes	
Mending	Automatically rest breakage error	No
	Automatically reset the rotary hook thread entanglement error	No
	Raise the presser foot when resetting the thread trimming error	Yes
	Stop the machine at the mending end position	Yes
	Stitches before mending	1 stitch
	Trim during stop in mending setting	No
	Conduct lock stitch when trimming thread	No
Adjustment	0.0 mm for X direction 0.0 mm for Y direction	
Speeding up startup of the main shaft	No	
Hoop feed during temporary stop for color change	No	
Reducing speed in a small pitch	No	
Thin material or thick material	110 degrees	
Area Trace	"Four-sided" is selected.	

1. Select [Default Settings] from Settings menu.

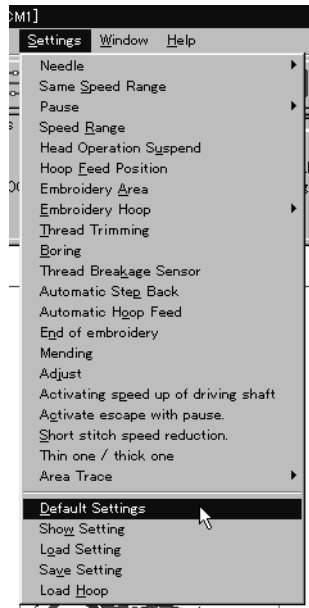

2. Click [OK].

Show Setting

Shows the setting contents and defaults.

■ The following items are shown:

- Embroidering area
- Thread trimming inching motion
- Thread removal feed length
- Boring
- Shift
- Thread breakage sensor sensitivity
- Automatic step back
- Automatic feed hoop
- Return to the stant point
- Speed up after starting the main shaft

1. Select [Show Setting] from Settings menu.

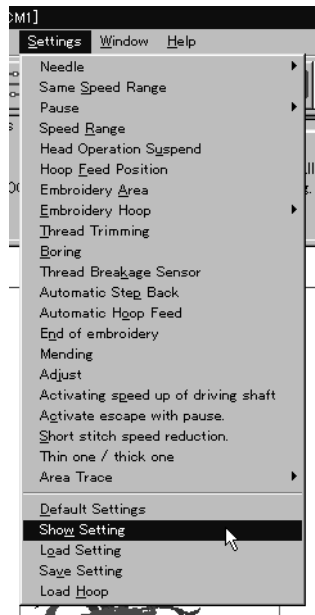

2. After checking, click [OK].

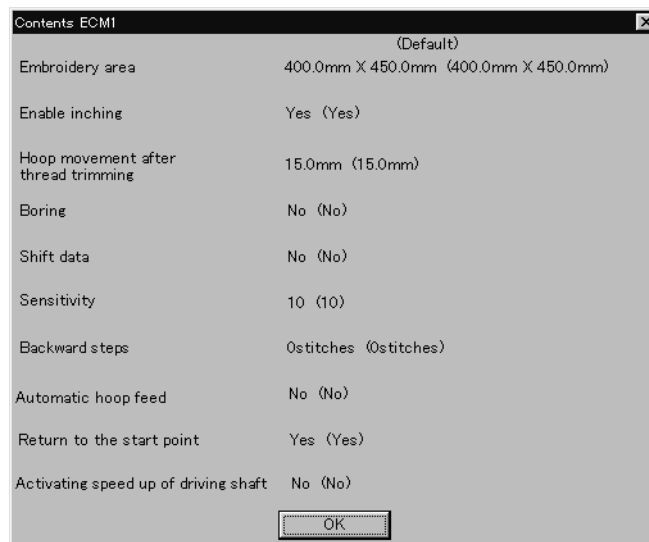

Load Setting

Load the setting.

■ The set file has an extension of ".ecm".

1. Select [Load setting] from Settings menu.

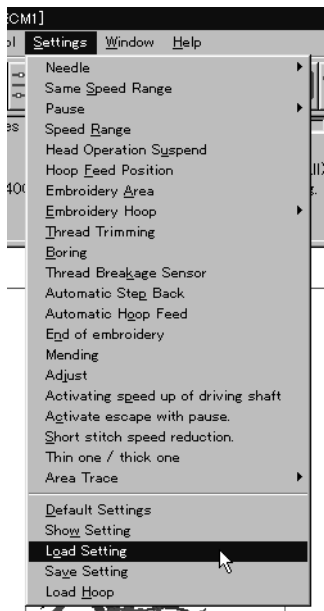

2. Select the folder and click [Open].

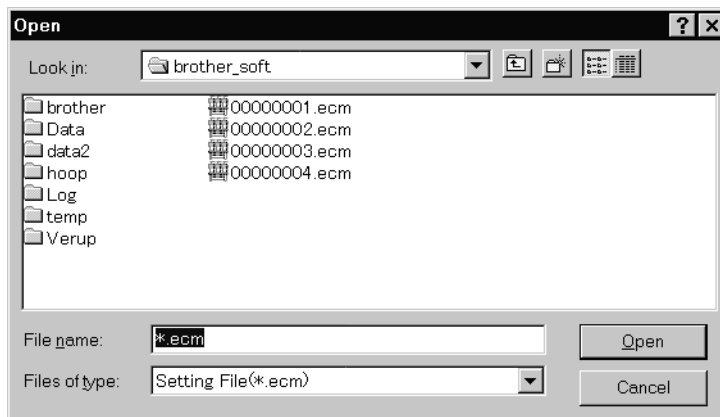

Save Setting

Saves the edit settings.

■ Save the setting files with an extension of ".ecm".

1. Change the setting.
2. Select [Save setting] from Settings menu.

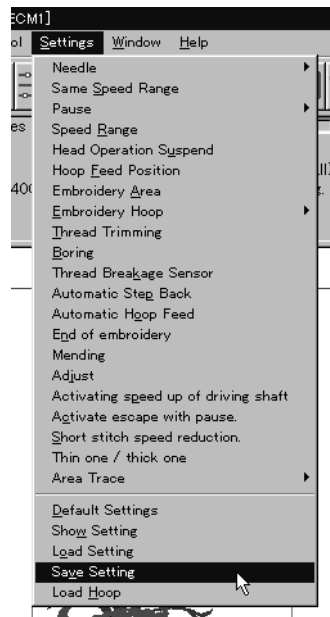

3. Select the registration folder and put a file name.

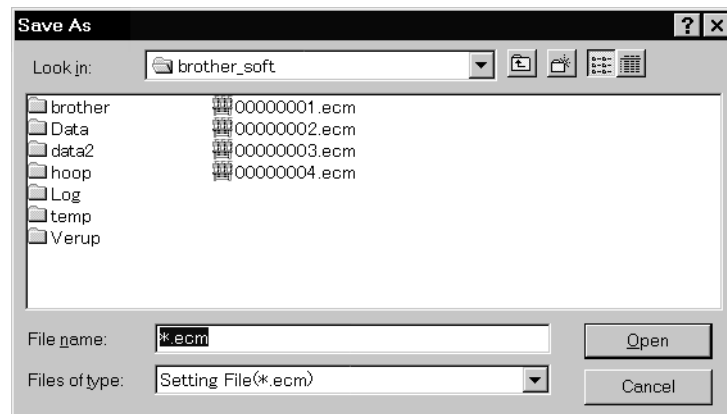

4. Click [Save].

Load Hoop

Load the optional hoop displayed in "Hoop".

- The hoop file to be loaded has an extension of ".ehp".
- The types and the shapes of hoop for loading are as follows:

Round frame

ROUND_FRAME21.ehp

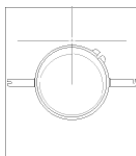

ROUND_FRAME25.ehp

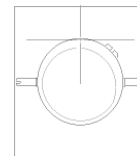

Square frame

SQUARE_FRAME24X24.ehp

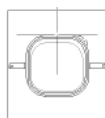

SQUARE_FRAME45X23.ehp

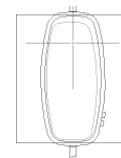

SQUARE_FRAME45X27.ehp

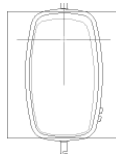

SQUARE_FRAME45X32.ehp

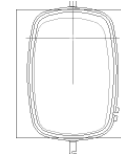

Spider net frame

SPIDER_NET_FRAME05B-1.ehp

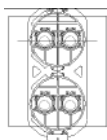

SPIDER_NET_FRAME05B-2.ehp

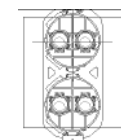

SPIDER_NET_FRAME05B-3.ehp

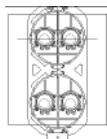

SPIDER_NET_FRAME05B-4.ehp

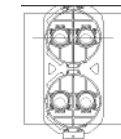

SPIDER_NET_FRAME07T-1.ehp

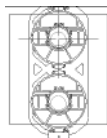

SPIDER_NET_FRAME07T-2.ehp

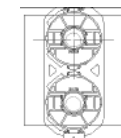

SPIDER_NET_FRAME07T-3.ehp

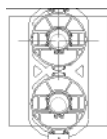

SPIDER_NET_FRAME07T-4.ehp

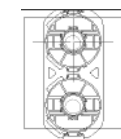

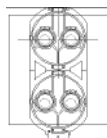

SPIDER_NET_FRAME07B-1.ehp

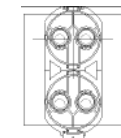

SPIDER_NET_FRAME07B-2.ehp

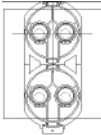
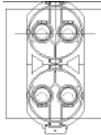
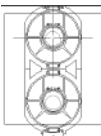
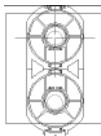
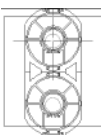
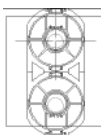
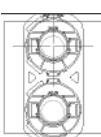
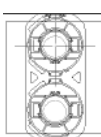
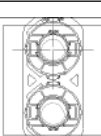
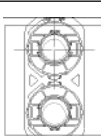
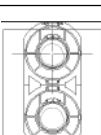
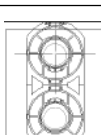
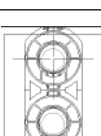
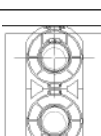
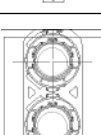
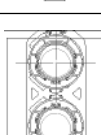
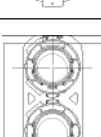
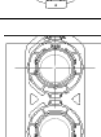
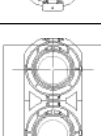
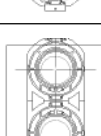

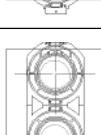
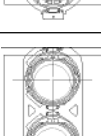
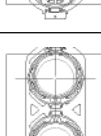
SPIDER_NET_FRAME07B-3.ehp		SPIDER_NET_FRAME07B-4.ehp	
SPIDER_NET_FRAME09T-1.ehp		SPIDER_NET_FRAME09T-2.ehp	
SPIDER_NET_FRAME09T-3.ehp		SPIDER_NET_FRAME09T-4.ehp	
SPIDER_NET_FRAME10B-1.ehp		SPIDER_NET_FRAME10B-2.ehp	
SPIDER_NET_FRAME10B-3.ehp		SPIDER_NET_FRAME10B-4.ehp	
SPIDER_NET_FRAME12T-1.ehp		SPIDER_NET_FRAME12T-2.ehp	
SPIDER_NET_FRAME12T-3.ehp		SPIDER_NET_FRAME12T-4.ehp	
SPIDER_NET_FRAME13B-1.ehp		SPIDER_NET_FRAME13B-2.ehp	
SPIDER_NET_FRAME13B-3.ehp		SPIDER_NET_FRAME13B-4.ehp	
SPIDER_NET_FRAME15T-1.ehp		SPIDER_NET_FRAME15T-2.ehp	
SPIDER_NET_FRAME15T-3.ehp		SPIDER_NET_FRAME15T-4.ehp	
SPIDER_NET_FRAME16B-1.ehp		SPIDER_NET_FRAME16B-2.ehp	

SPIDER_NET_FRAME16B-3.ehp

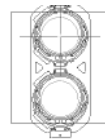

SPIDER_NET_FRAME16B-4.ehp

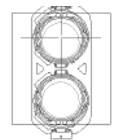

SPIDER_NET_FRAME18T-1.ehp

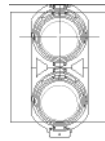

SPIDER_NET_FRAME18T-2.ehp

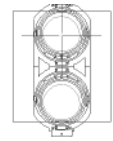

SPIDER_NET_FRAME18T-3.ehp

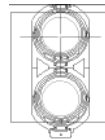

SPIDER_NET_FRAME18T-4.ehp

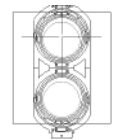

SPIDER_NET_FRAME19B.ehp

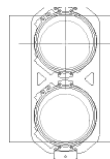

Tubular frame

TUBULAR_FRAME-05.ehp

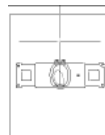

TUBULAR_FRAME-07.ehp

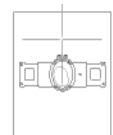

TUBULAR_FRAME-10.ehp

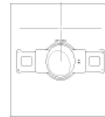

TUBULAR_FRAME-13.ehp

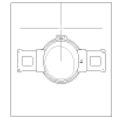

TUBULAR_FRAME-16.ehp

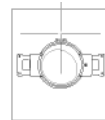

TUBULAR_FRAME-19.ehp

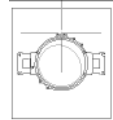

TUBULAR_FRAME23X24.ehp

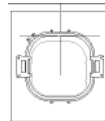

TUBULAR_FRAME23X43.ehp

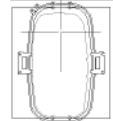

TUBULAR_FRAME28X30.ehp

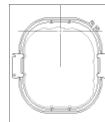

TUBULAR_FRAME30X28.ehp

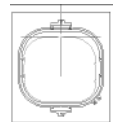

TUBULAR_FRAME30X43.ehp



TUBULAR_FRAME30X48.ehp

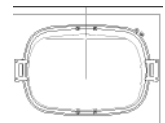

TUBULAR_FRAME40X43.ehp

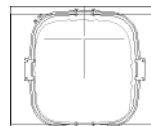

Holder base frame

HOLDER_BASE23X24.ehp

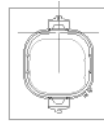

HOLDER_BASE23X43.ehp

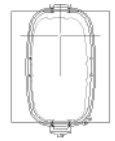

HOLDER_BASE30X28.ehp

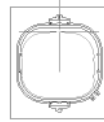

HOLDER_BASE30X43.ehp

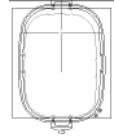

HOLDER_BASE30X48.ehp

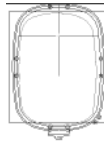

HOLDER_BASE40X43.ehp

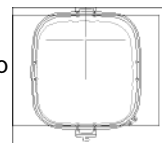

Tubular round frame

TUBULAR_ROUND07.ehp

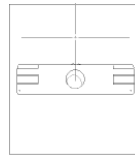

TUBULAR_ROUND09.ehp

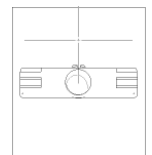

TUBULAR_ROUND12.ehp

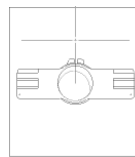

TUBULAR_ROUND15.ehp

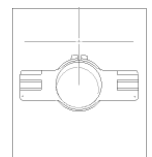

TUBULAR_ROUND18.ehp

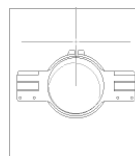

TUBULAR_ROUND24X24.ehp

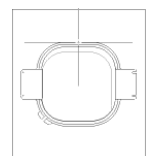

TUBULAR_ROUND24X30.ehp

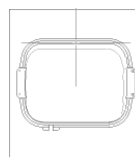

TUBULAR_ROUND30X30.ehp

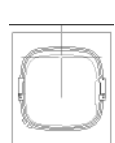

TUBULAR_ROUND32X45.ehp

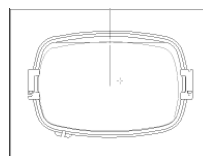

TUBULAR_ROUND335X453.ehp

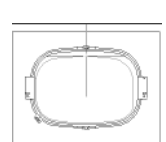

Cap frame semi-wide frame

Cap frame semi-wide.ehp

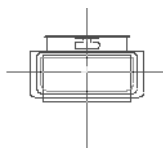

Cap frame wide frame

Cap frame wide.ehp

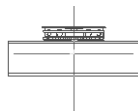

1. Select [Load hoop] from Settings menu.

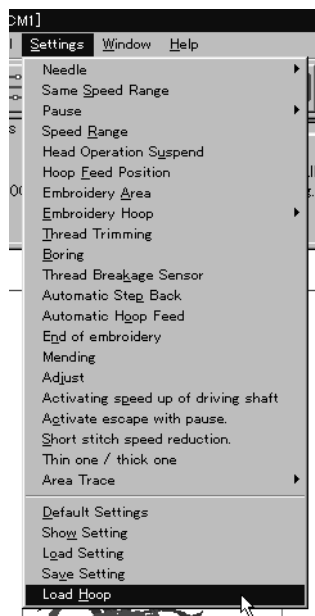

2. Select the folder and click [Open].

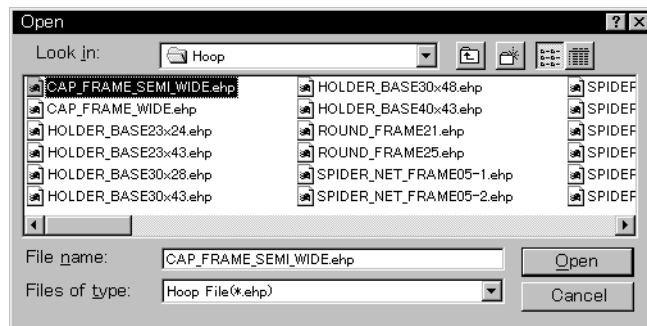

Embroidering

How to start embroidering and operation after the start are explained here.

Starting Embroidering

■ The following screen appears when the edit data is retrieved from the explorer.

To run the embroidery data explorer

To run the embroidery data editor

To copy the current data to other linked machines

To start embroidering

To suspend embroidering

To display the speed and the range

To display the overall number of stitches and the current number of stitches

The progress of embroidering is displayed on a bar chart.

To display the name of the embroidering data

To display the timing angle of the needle drop and hoop movement.

Click here and the overall speed range increases by one level.

Click here and the overall speed range decreases by one level.

To display the status of the machine.

1. Click .

"Hoop" appears at the machine display window.

2. Press the button. Embroidering starts.

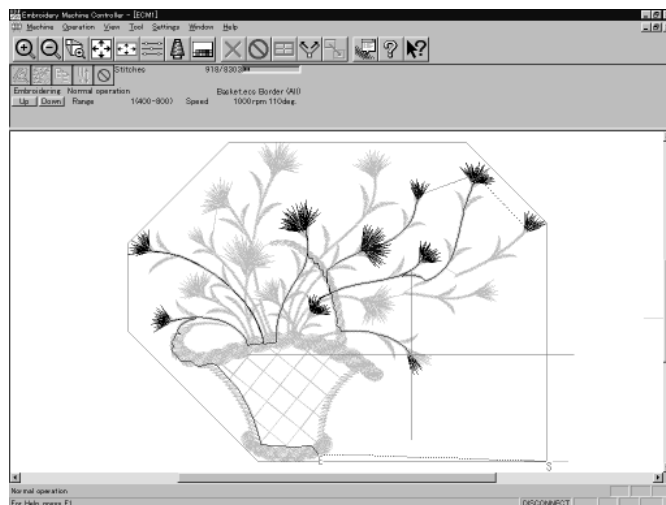

Embroidery data appears in gray, indicating the embroidering status.



Pause

1. Click .

Canceling

1. Press the  button while pressing the  button on the machine operation panel.
2. Click .
3. The check screen appears. Click [Yes] to cancel.



Moving the Home Position

Move the selected machine home position.

1. Select [Home Position] from Operation menu or click  .



Step-forward/Step-back

Allows step-forward or step-back of stitches without embroidering.

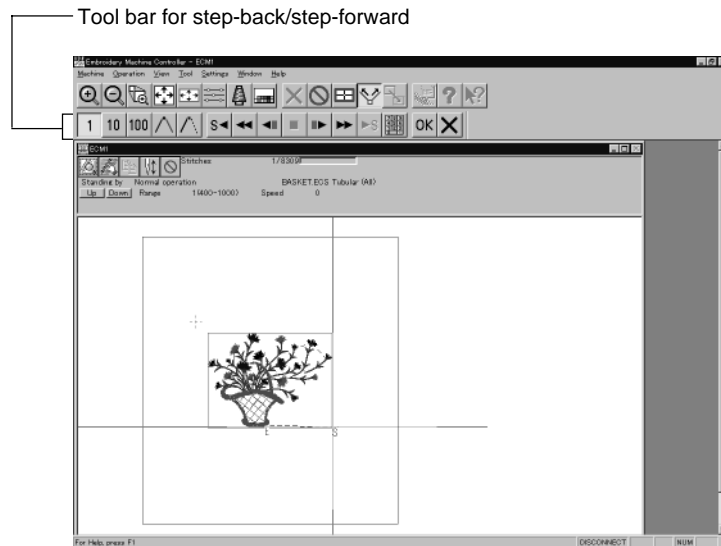
- Click  to stop embroidering for step-forward/back mode.
- The special tool bar appears in the step-forward/back mode.



Entering in the Step-forward/Step-back Mode

1. Click  to stop embroidering.
2. Select [Step F/B] from the Operation menu or click . A cross appears on the screen. The current needle position is the intersection of the vertical and horizontal lines.

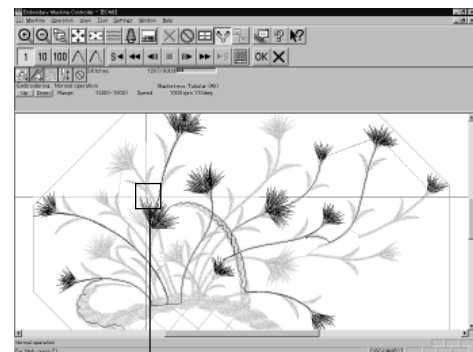
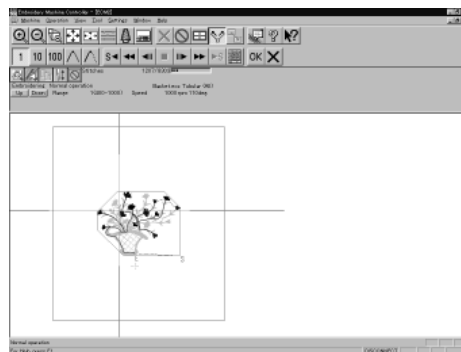

Current needle position

Canceling step-forward/step-back

1. Click  of the step forward/back tool bar.

The cross disappears and the step forward/back mode is canceled.

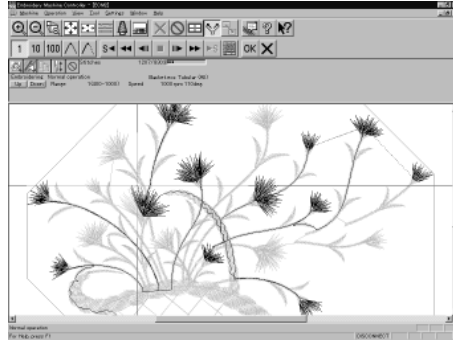





Setting Step-forward/Back Distance or Timing

Select step-forward/back distance or timing.

- The functions of icons are as follows:



	Moves forward (backward) by 1 stitch.
	Moves forward (backward) by 10 stitches.
	Moves forward (backward) by 100 stitches.
	Moves to the next (previous) color change.
	Moves to the next (previous) feed.

1. Click the icon to select the desired function.

Stepping Forward/Back

Steps forward/back the stitches actually.

■ The functions of icons are as follows:



- S Returns to the start position. For repeating patterns, returns to the start position of the current pattern.
- ◀◀ Moves backward by the specified distance continuously. Click ■ to stop movement.
- ◀|| Moves backward by the specified distance.
- Click this to stop after clicking ◀◀ or ▶▶.
- ||▶ Moves forward by the specified distance.
- ▶▶ Moves forward by the specified distance continuously. Click ■ to stop movement.
- ▶S This is selected for repeating patterns. The machine goes to the start position of the next pattern.
- 7 8 9
4 5 6
1 2 3
0 Specify the travel length from the embroidery start point.

■ Selection of movement to the start position. The needle moves as follows:

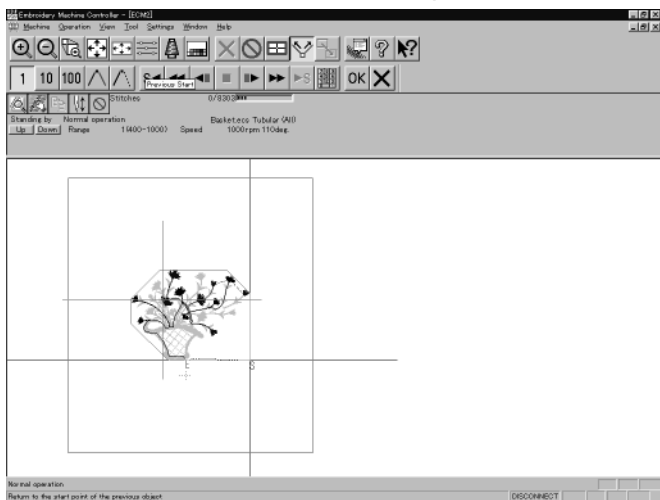

Click the S icon and the needle moves to the start position of the current pattern.

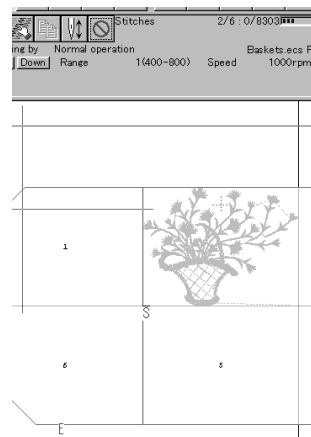
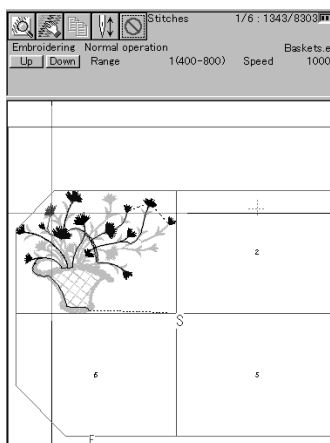

Click the ▶S icon and the needle moves to the start position of the next repeating pattern.

1. Select the icon and move the cross to the desired position for step forward/back.

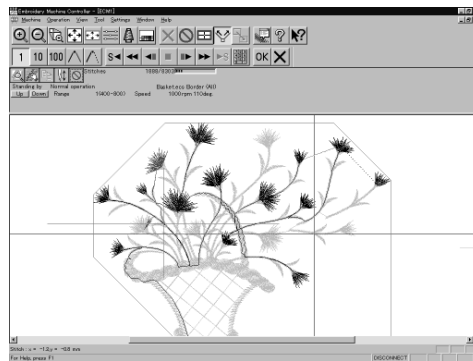

Forward

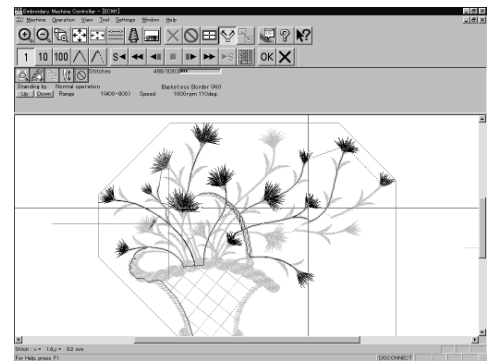

Backward

Specifying the Value

Specify the travel length from the embroidery start point.

1. Click .
2. Input the number of stitches to start embroidery. Click [OK].

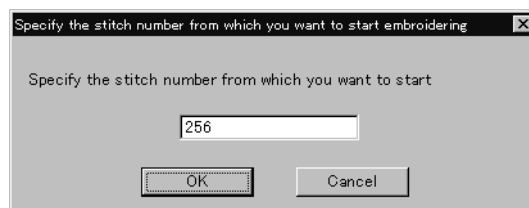

Resuming Embroidering

1. Click  in the tool bar.

The cross disappears. The embroidery status at the step forward/backward position of the stitches is displayed.

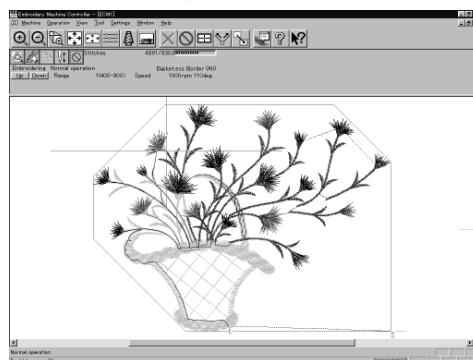

Forward

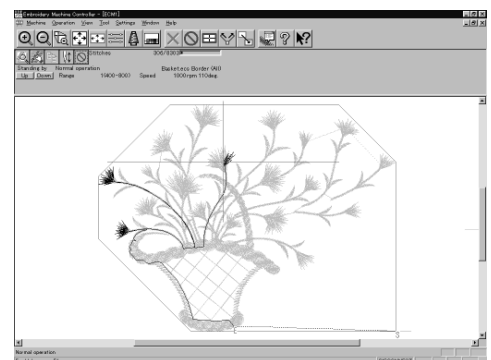

Backward

2. Click .

It is ready to resume embroidering and "Hoop" appears at the machine display window.

3. Press  on the machine.

Moving Embroidery Position

Changes the position of embroidery data.

- Movement is allowed only in the embroidering area (within the red frame).

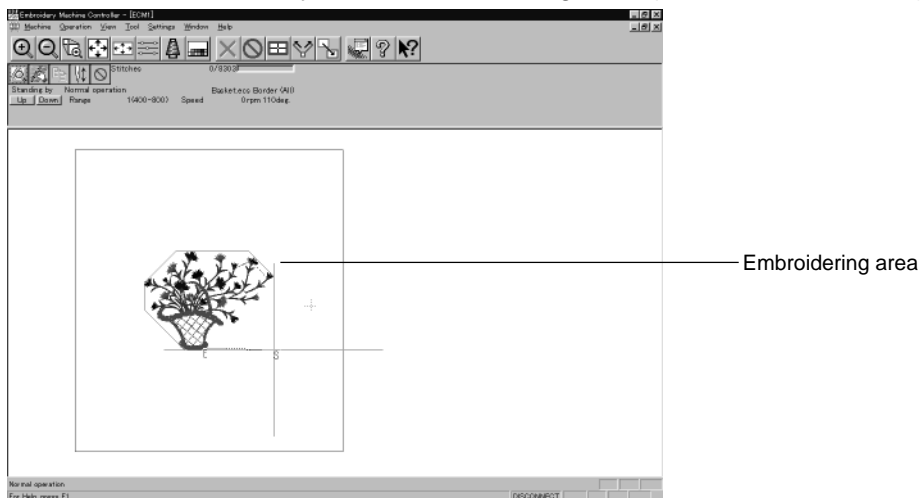

1. Select [Move Embroidery Position] from Operation menu or click  .

2. The pointer turns into  . Drag the embroidery data.
The mouse arrow becomes + while dragging.

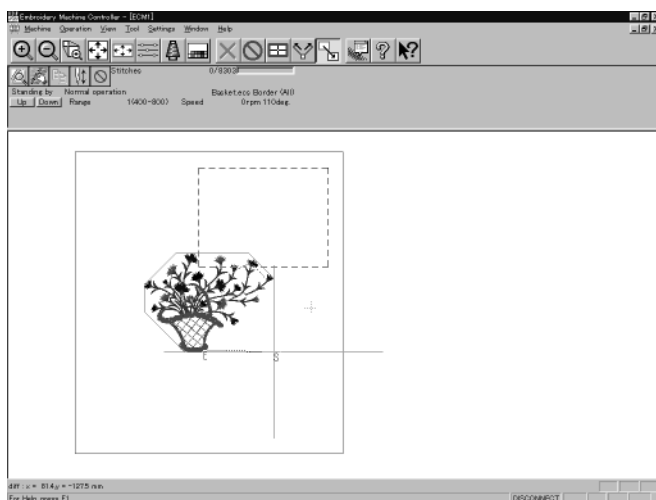

Centering Pattern

Moves the pattern to the machine home position.

1. Select [Move Pattern] from Operation menu.

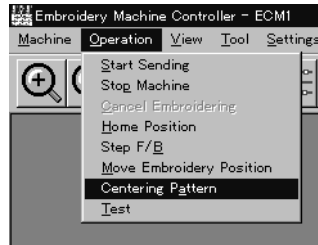

2. The pattern is moved.

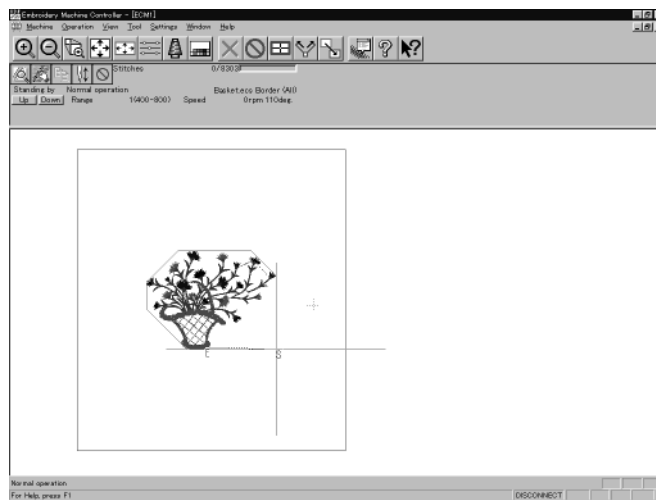

Saving Data

Saves the edited data. The edited data can be saved over the current file or renamed as a separate file.

Save

Saves the edited data over the current file. The original data is deleted.

1. Select [Save] from File menu or click  .
2. If color etc. has been is changed, the pattern image appears.



Save As...

Renames and saves the edited data as a new file.

1. Select [Save as...] from File menu.
2. Select the directory to save the new file. Enter a new file name.

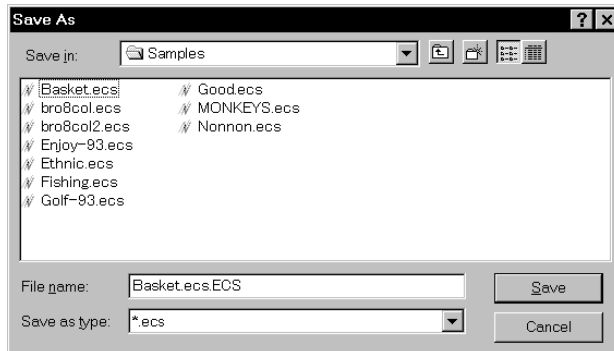

3. Click [Save].
4. If color etc. has been is changed, the pattern image appears.



Test

Carries out sensor information check, actuator operation test, test for main shaft rotation, etc. for machine maintenance.

This function is protected by a password. A dealer engineer will use this function if required.

Running Other Programs

Other programs can be started when the machine power is not turned on or when the machine is in operation for embroidery.

■ The following programs can be started:

Embroidery data explorer	Allows transfer and copy of the embroidery data. Data transfer to the machine controller is not allowed.
Embroidery data editor	Allows editing of embroidery data.
Production report	Allows display and print-out of production data, etc.

1. Select [Embroidery Data Explorer independently] or [Embroidery Data Editor independently] from Tool menu.

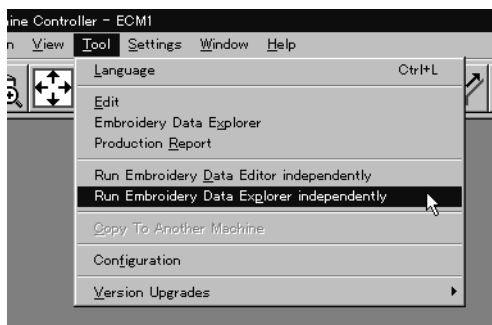

Selecting [Embroidery Data Edit Individual Start]

■ Input the number of needle bars. Input the number according to your machine specifications. Click [OK].

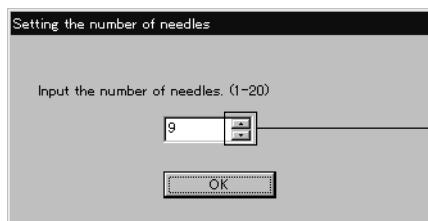

Click this to increase or decrease the value.



Chapter 7 Operation of Machine

1. Operating Procedures

1-1 Power Source

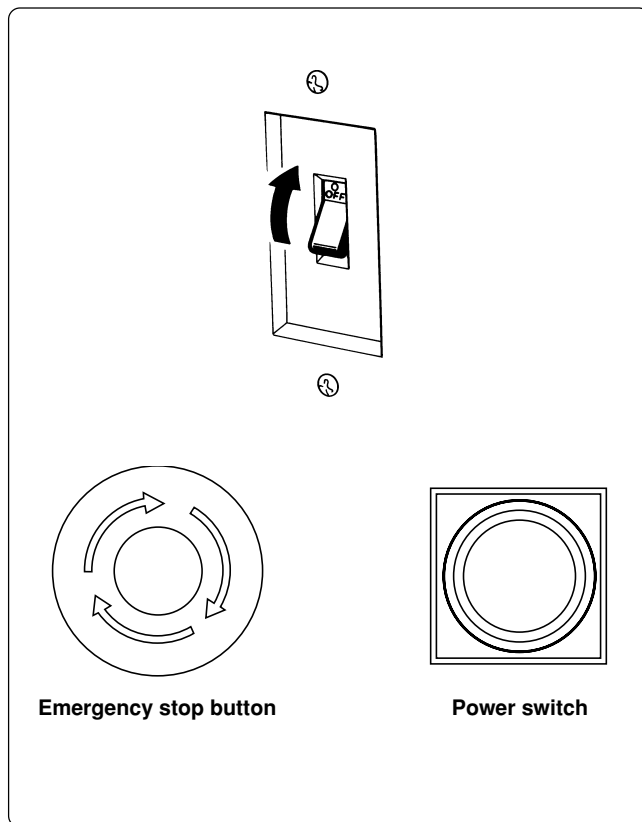

1. Turn the power on to the machine.
2. Reset the emergency stop button.
3. Press the high power switch.
4. The power lamp lights up and the display window indicates "BES-", and then "962 (BES-1262BC : "1262")".



BES- → 962

- An alarm buzzer sounds three times. Then the needle bar and presser foot move up and the frame moves up to the reference point.

The machine enters the waiting state for an embroidering data selection.

Note) When turning the power off and back it on again, wait for at least 10 seconds.

1-2 Preparation for Embroidering

- Select embroidering data while the machine is in the waiting state for an embroidering data selection, and transmit required data by pressing the  icon.
- The READY lamp lights up and the machine is placed in the waiting state.
- Using the jog switches () determine a position to start embroidering.
Note) An error code is displayed in the display window if a pattern comes out of the hoop.
- Pressing the START switch starts embroidering.

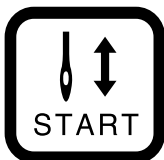

- * During embroidering, the speed is indicated in the display window.
- After embroidering is finished, the hoop returns to the start point and the machine is placed in the stand-by state.

2. Stopping the Machine

2-1 Procedure to Stop the Machine

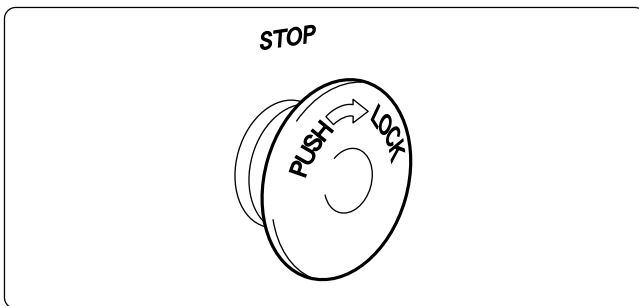

Press the stop button or  to stop operation of the machine.

The stop button adopts the push-turn-lock method. If you want to keep the machine stopped, turn the stop button clockwise while pushing it.

2-2 Resetting Machine Stop

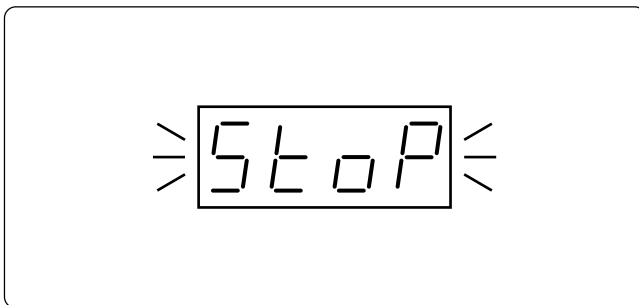

- When the stop button is locked by turning it while pressing it, the message, "STOP", is displayed while blinking on the operation panel.
- To reset the stop button, turn it counterclockwise while pressing it. The knob of the button pops up and machine stop is reset.
- Check to see that the other stop button is reset.

2-3 Emergency Stop of the Machine

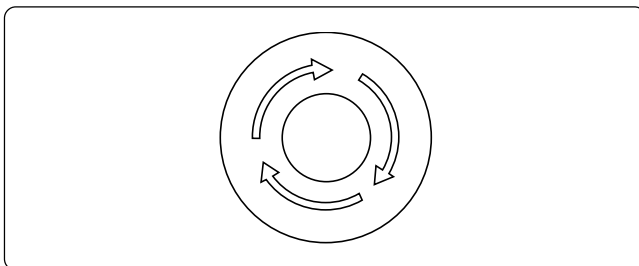

When the emergency stop button is pressed, all power except for that for the fluorescent lamp is turned off.

2-4 Resetting Emergency Stop

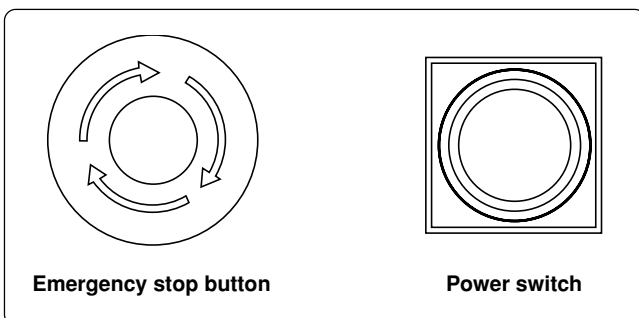

When turning the emergency stop button in the direction of the arrow illustrated on the button, the knob of the button pops up and emergency stop is reset.

Press the power switch to turn on the power again.

3. Permission for Hoop Movement

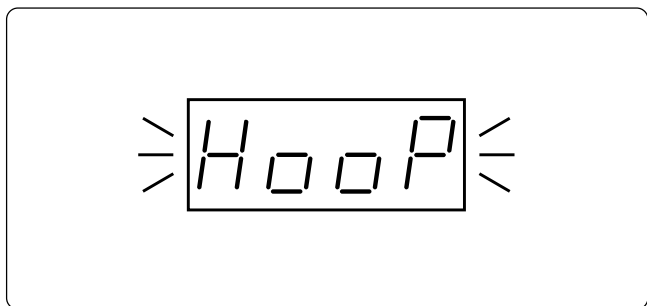

- When the computer has given a command to move the embroidery hoop, "HOOP" is displayed while blinking on the operation panel.
- Press the check switch and the embroidery hoop moves to the designated position.



4. Measures against Thread Breakage

4-1 Remedies

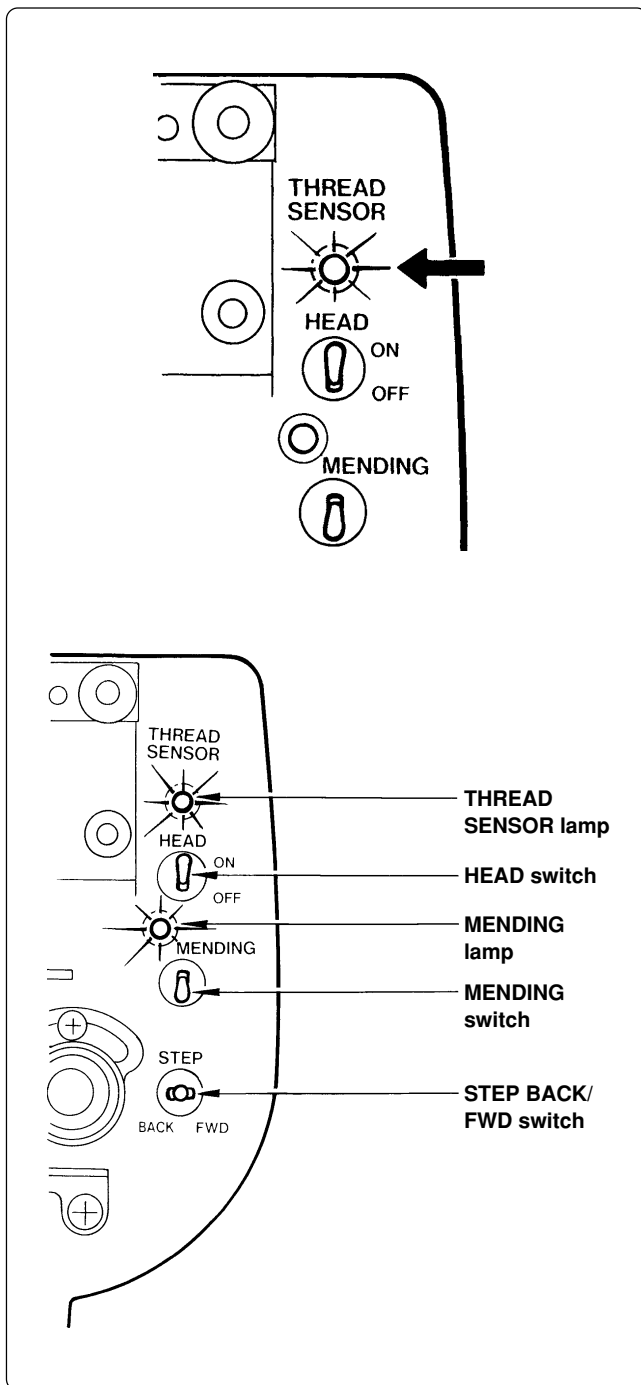

1. If embroidering is suspended due to thread breakage, the **THREAD SENSOR** lamp of the machine head with a thread breakage blinks.

2. **Correct the broken thread and pass it through again.**

* Refer to "Chapter 2, 3-1 Upper Threading" for details.

3. **Press the STOP switch or press the STEP BACK/FWD switch in order to reset the alarm.**



4. **Return the hoop to a position where thread breakage occurred by pressing the STEP BACK switch.**

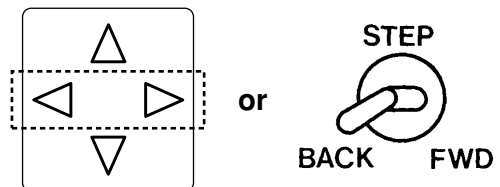

Note) When the switch is turned for 20 stitches or more, the machine continues operation without holding the switch. To stop the machine, turn the switch to the opposite side.

5. **Press the START switch on the operation panel or the start switch located between the machine heads to resume operation.**

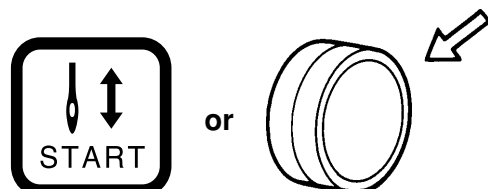

4-2 Mending

The machine head whose MENDING lamp is lit performs embroidering by the preset number stitches. When it is completed, all the machine heads start normal embroidering operation.

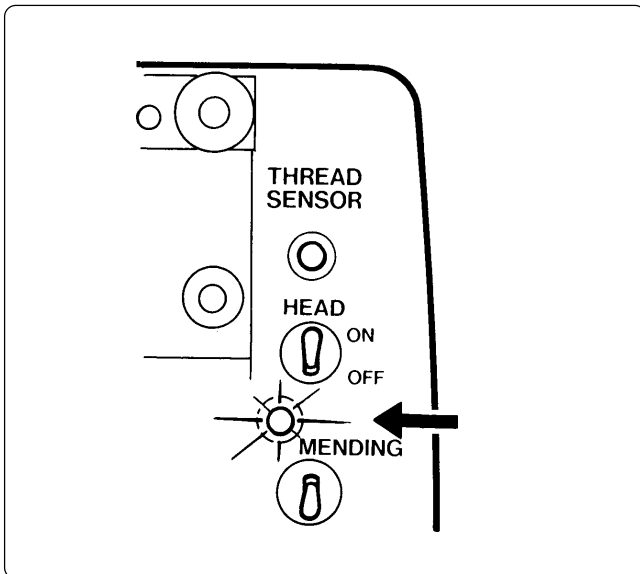

- The MENDING lamps except for the machine head whose needle thread has been broken are turned off.
- At this time, the machine head, whose MENDING lamp is on, performs resewing from the step-back position while the other machine heads (with MENDING lamps off) are stopped. When resewing is completed, the other machine heads (except those halted or with bed retracted) also start embroidering.

Manual operation

The mending start and end positions can be set for each machine head using the MENDING switch on the tension plate.

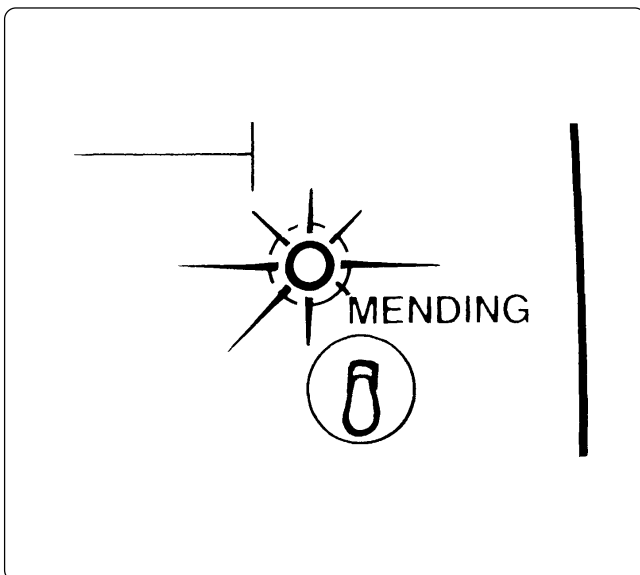

The MENDING lamp is lit when the MENDING switch of each machine head is flipped up during standby. Resewing from the step-back position to this position can be executed.

- * When the MENDING switch is flipped up while the MENDING lamp is off, the lamp is turned on; when the MENDING switch is flipped up again while the MENDING lamp is lit, the lamp is turned off.

Note) The mending end position cannot be set for each machine head.

When all MENDING lamps are turned on, the mending end position will be set to the position where one of the lamps is turned off first.

Note) To cancel the mending end position, turn all the MENDING lamps are turned on (except for halted machine heads) .

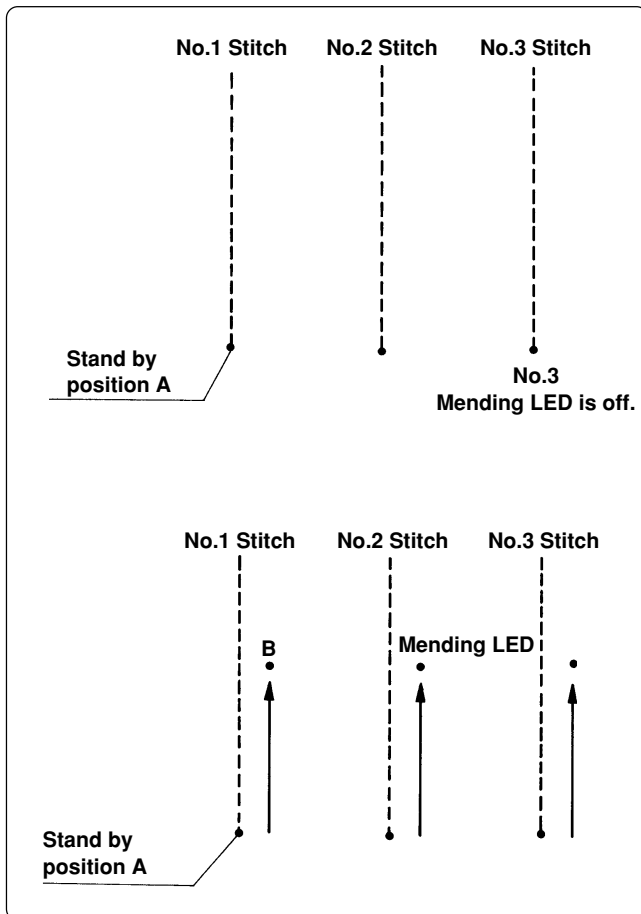

1. Turn off the MENDING lamp No. 3 at the standby position A.
(The position A should be the mending end position.)

2. Press the jog ◀ switch or  to move it backward.

Turn off the MENDING lamp No. 2 at the position B.

(The position B does not become the end position; the position A remains the end position.)

Note) When the MENDING switch of the machine head whose lamp is off is pressed:

- The MENDING lamp of the machine head is lit, and mending is executed for the machine head.

Note) When the MENDING switch of the machine head whose lamp is on is pressed:

- The MENDING lamp of the machine head goes off and mending is not executed for the machine head.

5. Jog Embroidering

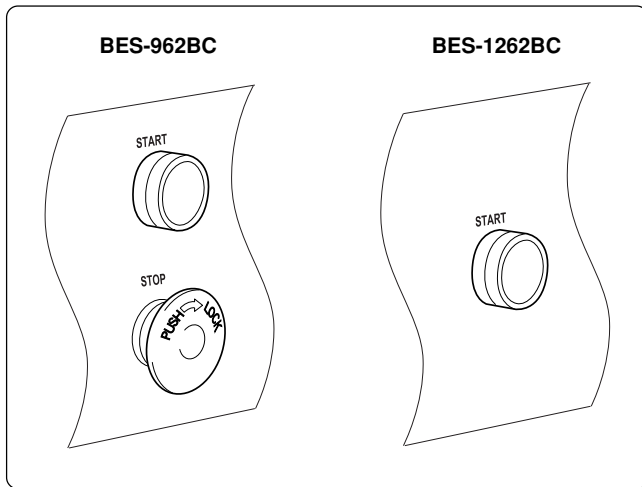

- Jog embroidering can be used for preventing the thread from slipping from the needle at the start of embroidering.
- Jog embroidering can be executed as long as the start switch at the machine head is held down.

Note) Never apply a tape on the switch to keep jog operation for a long time. Doing so may cause damage to the machine.

6. Hoop Feed Position

- In order to ease mounting and dismounting of the embroidery hoop, another needle position can be set as a hoop feed position in the movable area additionally to the current needle position. (The hoop feed position should be set by the personal computer.)
- In order to ease material attachment while operation is suspended, the hoop can be moved to the feed position at any time by the hoop feed switch.
- The hoop can also be moved to the feed position automatically after embroidering is finished. Refer to "Automatic Hoop Feed" on Page 159 for details.



7. Area Check

7-1 External Tracing

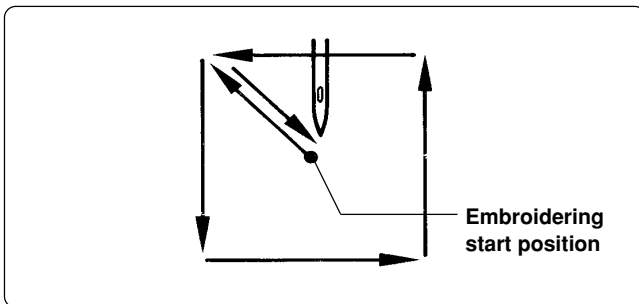

- If the check switch is pressed in other cases than "area over", the rectangular outline of the pattern is traced.



7-2 Automatic Hoop Movement in Area

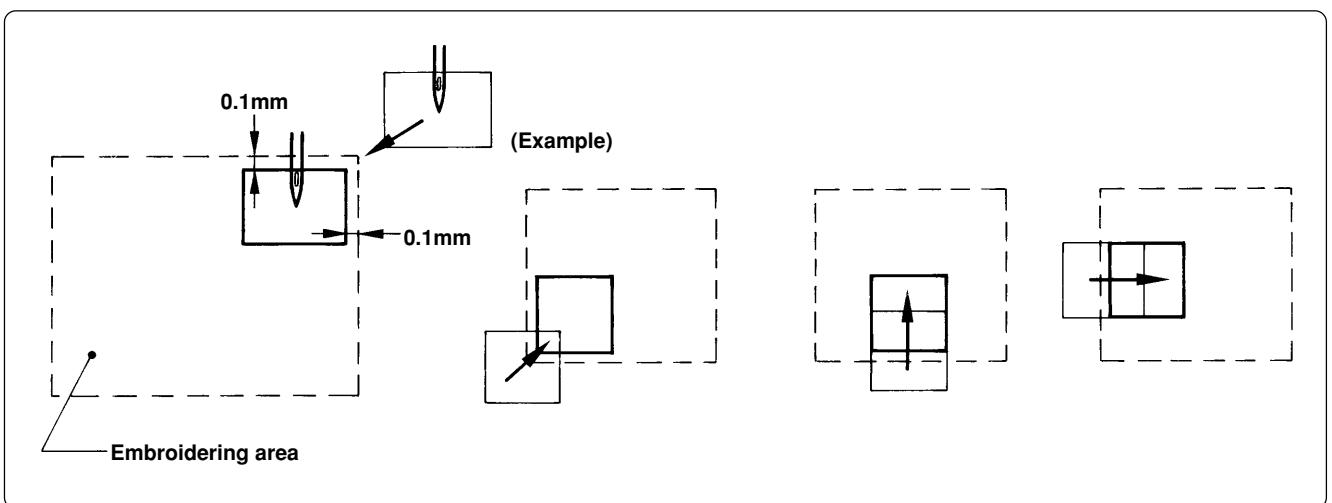

- If "area over" is displayed, press the check switch. The hoop automatically moves inside the embroidering area, where the pattern is set, at the nearest position.



Note) After finishing the movement inside the area by this function, execute external tracing. Then, check that the needle and the presser foot do not interfere with the hoop before starting embroidering.

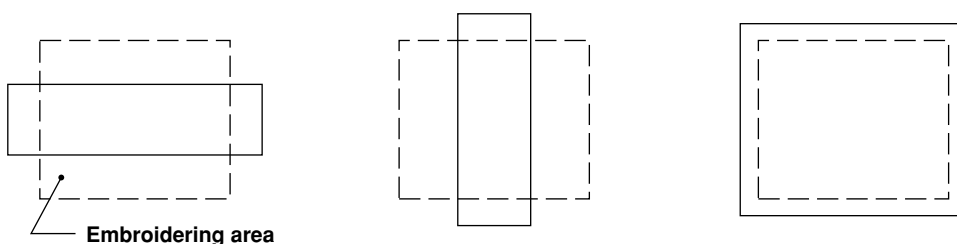

If the pattern is not held in the embroidering area as shown below, the hoop cannot move into the area. Enlarge the embroidering area on the personal computer.

8. Jog Switches

8-1 Hoop Movement to Start Position

The hoop immediately after the embroidering mode becomes valid can be moved so that the start position can be set as required.

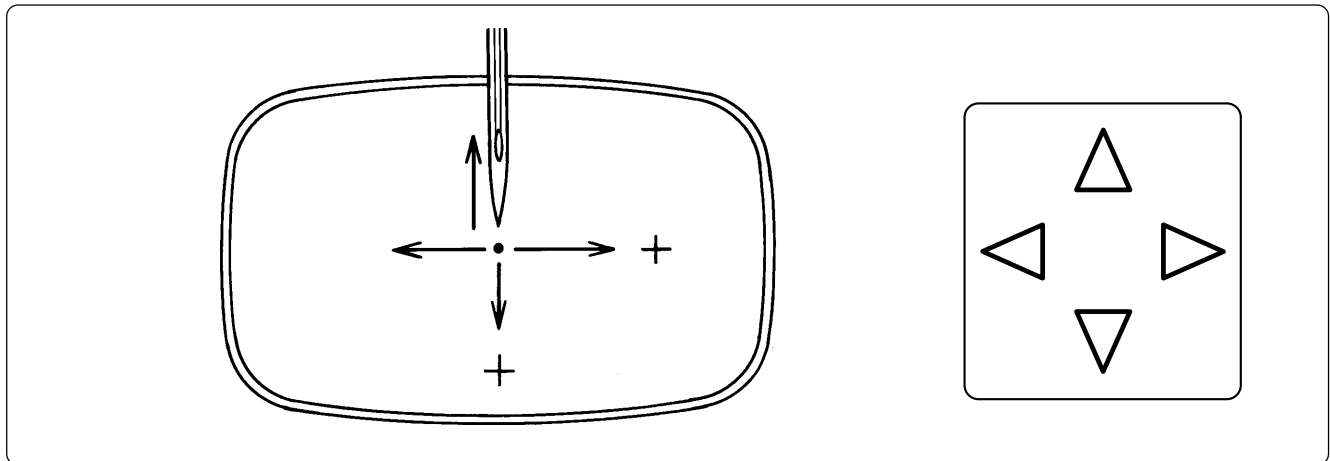

8-2 Inching Mode during Embroidering (Forcible Hoop Movement)

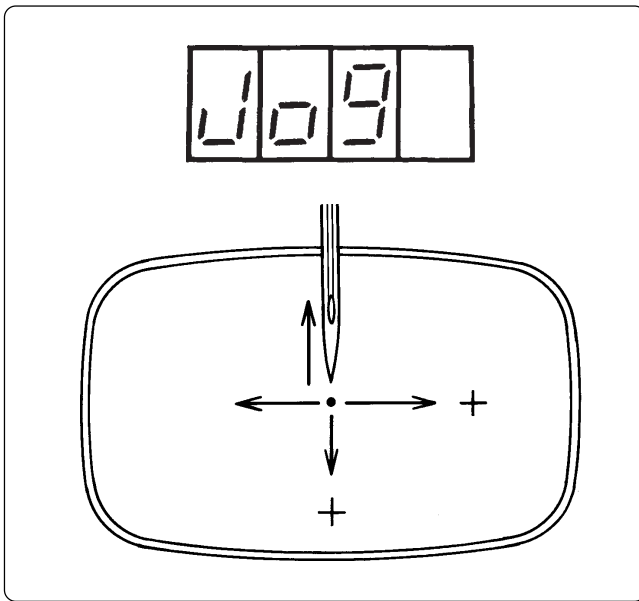

1. Press the jog switch \triangle while pressing the "STOP" switch and "AJST" is displayed. 
2. Press the jog switch \triangleright to forcibly change the hoop. "JOG" is displayed.
3. Press the "START" switch and press the jog switch. The hoop moves to the direction of the pressed switch.

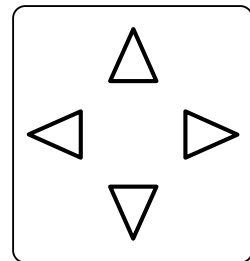
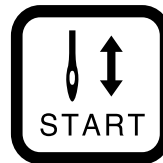

Notes) • Note that the forcible hoop movement will produce deviation of embroidering by the amount.

- If the hoop and material are deviated from each other during embroidering, correct it by using the jog switches.

4. Pressing the STOP switch resets the inching mode.



5. Press the START switch restarts embroidering.

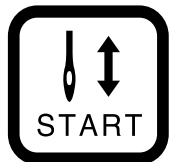





Chapter 8

Creating Production Report

Records and controls the machine operation. The production report can be created based on this data. Detailed information of production report allows efficient embroidering control.

Functions (Command Reference)









File menu

Open Report File		Opens the report file. (→ page 204)
Save As CSV		Saves the current report data in CSV format. (→ page 217)
Print		Prints the report. (→ page 218)
Print Preview		Displays the print preview on the screen.
Page Setup		Displays the setting screen for printing. (→ page 218)
Exit from Production Report		Exits from the production report.

Edit menu

Copy		Copies the selected area to the clipboard. (→ page 219)
Select All		Selects all report data.

View menu

Details		Displays detail data. (→ page 205)
Thread Breakage Information on Needle Bar		Displays the thread breakage information for each machine needle. (→ page 206)
Thread Breakage information in pattern		Displays the thread breakage information for each pattern. (→ page 207)
Output information		Displays the production output of each machine. (→ page 208)
Total output information		Displays the total production output. (→ page 210)
Top page		Displays the top page.
Previous page		Displays the previous page.
Next page		Displays the next page.
Last page		Displays the last page.
Tool Bar		Displays the tool bar.
Status Bar		Displays the status bar.

Settings menu

Items to be displayed		Sets the display item. (→ page 211)
Delete report file (s)		Deletes the report file. (→ page 220)

Description of Screen

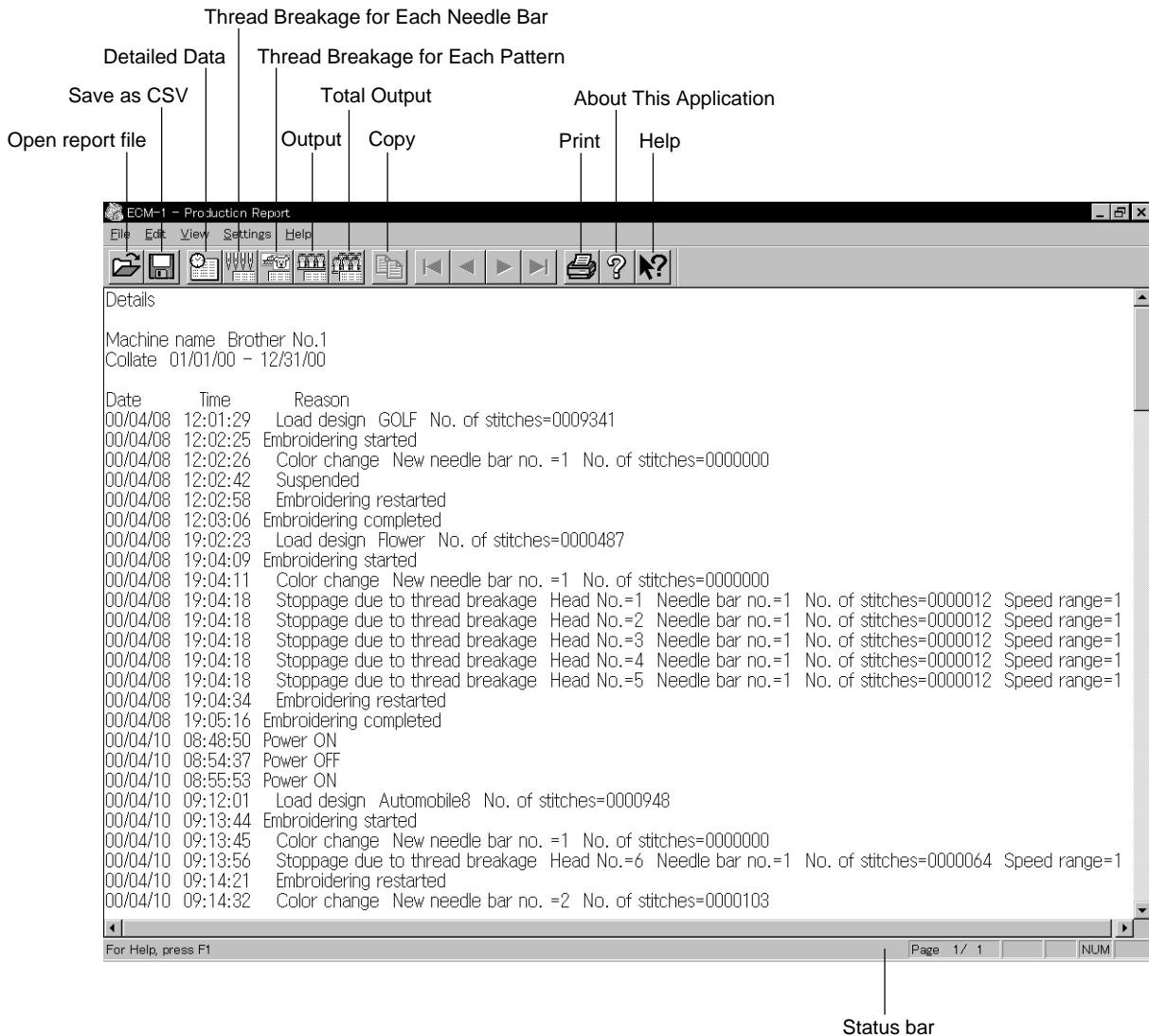

Displaying Report

Displays the machine operation status in the form of report.

■ The following reports can be displayed:

Details	Displays detail data while the machine is in operation.
Thread Breakage information on Needle Bar	Displays the thread breakage information for each machine.
Thread Breakage information in Pattern	Displays the thread breakage information for each pattern.
Output information	Displays production output or efficiency of the selected machine.
Total output information	Displays production output or efficiency of multiple machines.

■ Items to be displayed in each report can be set. For details, refer to "Setting Display Items" (→ page 211).

1. **Select the desired report from View menu or on the tool bar.**

2. **Select [Open] from File menu or click .**

3. **Select the applicable machine.**

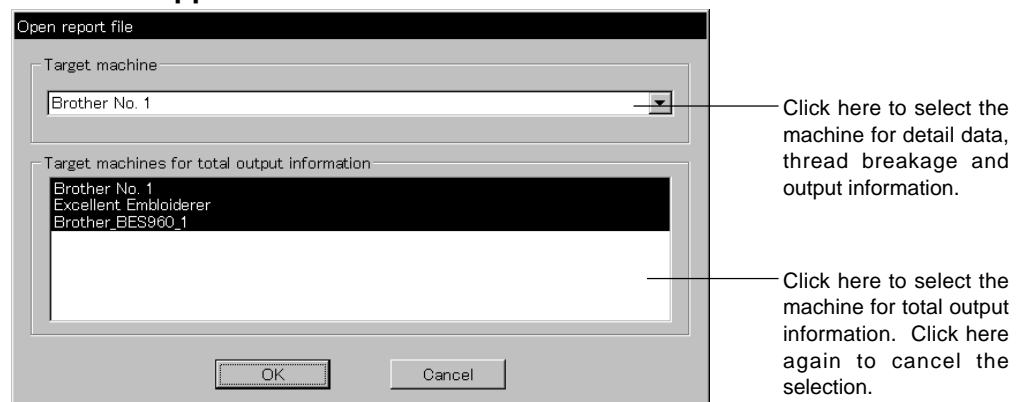

4. **Click [OK].**

5. **Specify the period to read.**

For more information, refer to "General" in "Setting Display Items" on page 211.

6. **Click [OK].**

The report appears.

Display Example of Details

Displays the machine information chronologically that are collected within the specified period.

The following information is indicated under the "Reason" column:

Display	Contents
Power ON	The machine power was turned on. If the computer is turned on after the machine power has been on, it shows the time when the computer recognized the machine.
Power OFF	The machine power was turned off. If the computer is turned off before the machine power, it shows the time when the computer program quit.
Load design (*)	The name of the loaded pattern and the number of stitches are indicated. This is also recorded when embroidering was started after the power was turned off and back on.
Embroidering started	Embroidering was started.
Embroidering completed	Embroidering was completed.
Embroidering canceled	Embroidering was canceled. The information on the pattern is deleted from the record.
Color change (*)	The needle bar number and the number of stitches after color change are indicated.
Suspended (*)	The machine operation was suspended by the operator.
Stoppage due to thread breakage (*)	A thread breakage occurred. The head number, the needle bar number and the speed range are indicated.
Error (*)	The machine was stopped due to an error.
Embroidering restarted (*)	Embroidering was restarted after a suspension, a thread breakage, or an error.

The items marked with "*" can be shown or hidden on the "Setting items to be displayed" screen.

Production Report

Machine name: Brother No.1
Collate: 01/01/00 - 12/31/00

Date	Time	Reason
00/04/08	12:01:29	Load design: GOLF No. of stitches=0009341
00/04/08	12:02:25	Embroidering started
00/04/08	12:02:26	Color change: New needle bar no. =1 No. of stitches=0000000
00/04/08	12:02:42	Suspended
00/04/08	12:02:58	Embroidering restarted
00/04/08	12:03:06	Embroidering completed
00/04/08	19:02:23	Load design: Flower No. of stitches=0000487
00/04/08	19:04:09	Embroidering started
00/04/08	19:04:11	Color change: New needle bar no. =1 No. of stitches=0000000
00/04/08	19:04:18	Stoppage due to thread breakage: Head No.=1 Needle bar no.=1 No. of stitches=0000012 Speed range=1
00/04/08	19:04:18	Stoppage due to thread breakage: Head No.=2 Needle bar no.=1 No. of stitches=0000012 Speed range=1
00/04/08	19:04:18	Stoppage due to thread breakage: Head No.=3 Needle bar no.=1 No. of stitches=0000012 Speed range=1
00/04/08	19:04:18	Stoppage due to thread breakage: Head No.=4 Needle bar no.=1 No. of stitches=0000012 Speed range=1
00/04/08	19:04:18	Stoppage due to thread breakage: Head No.=5 Needle bar no.=1 No. of stitches=0000012 Speed range=1
00/04/08	19:04:34	Embroidering restarted
00/04/08	19:05:16	Embroidering started
00/04/10	08:48:50	Power ON
00/04/10	08:54:37	Power OFF
00/04/10	08:55:53	Power ON
00/04/10	09:12:01	Load design: Automobile8 No. of stitches=0000948
00/04/10	09:13:44	Embroidering started
00/04/10	09:13:45	Color change: New needle bar no. =1 No. of stitches=0000000
00/04/10	09:13:56	Stoppage due to thread breakage: Head No.=6 Needle bar no.=1 No. of stitches=0000064 Speed range=1
00/04/10	09:14:21	Embroidering restarted
00/04/10	09:14:32	Color change: New needle bar no. =2 No. of stitches=0000103

For Help, press F1 Page: 1 / 1 [M.M.]

Display Example of Thread Breakage Information on Needle Bar

Displays the information on thread breakage occurrences with head numbers and needle bar numbers. Three needle bars with frequent thread breakage are indicated.

Display	Contents
No. of times thread is trimmed (*)	Number of thread breakage occurrences per needle bar
No. of stitches (*)	Number of stitches embroidered with the needle bar during the specified period
Thread breakage rate (*)	Thread breakage rate per 10,000 stitches (10000 x No. of times thread is trimmed) /No. of stitches
Total (*)	Total for all the heads or all the needle bars
Needle bar with frequent thread breakage occurrence (*)	Three needle bars that have thread breakage frequently, in the decreasing order of frequency

The items marked with "*" can be shown or hidden on the "Setting items to be displayed" screen.

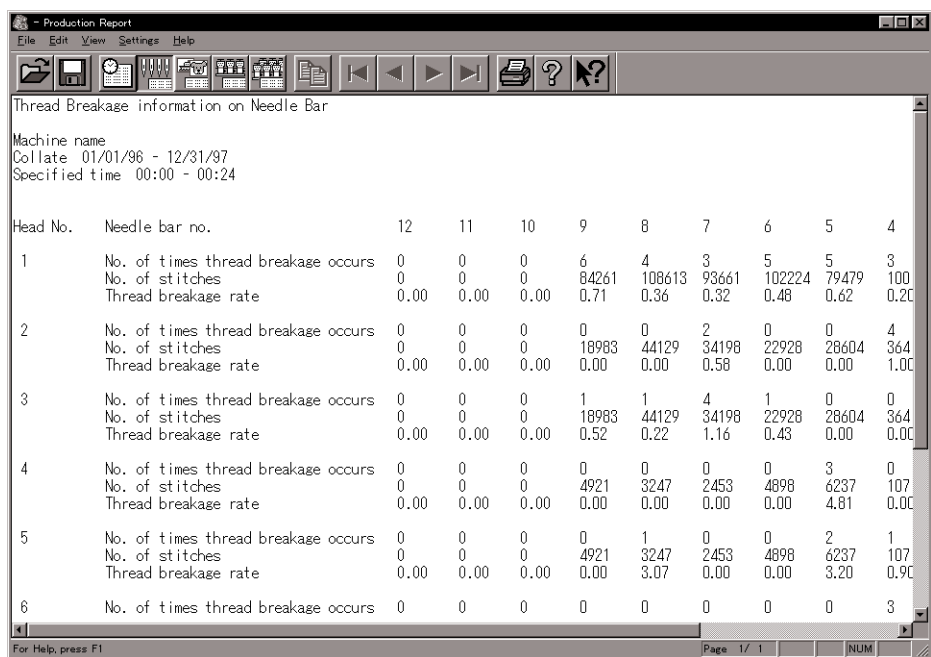

Display Example of Thread Breakage Information in Pattern

Displays thread breakage information for each pattern.

Display	Contents
n th	The pattern was embroidered for the "n"th time.
Pattern name	Name of the pattern that was embroidered
Head No. (*)	Head number where a thread breakage occurred
Needle bar no. (*)	Needle bar number where a thread breakage occurred
n th stitch (*)	The ordinal number of the stitch when a thread breakage occurred
Speed range (*)	Speed range that was effective when a thread breakage occurred

The items marked with "*" can be shown or hidden on the "Setting items to be displayed" screen.

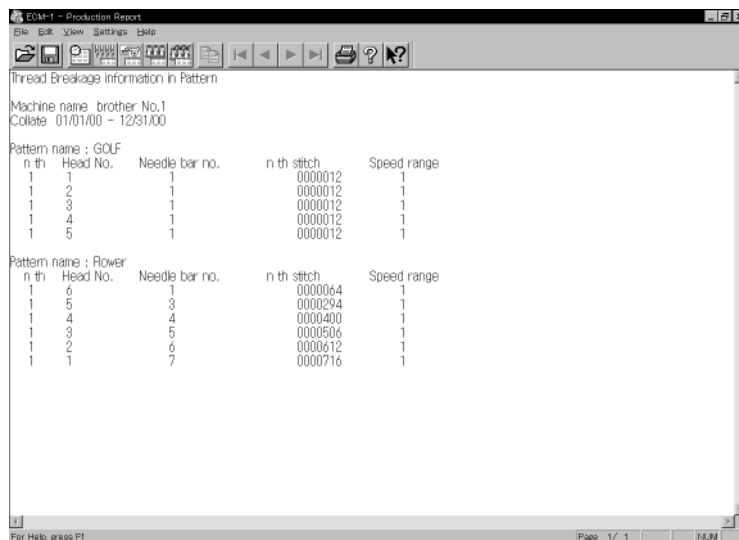

Display Example of Output Information

Displays the production information that are collected during the specified period.

Display	Contents
Total electricity supply time	Total time when the machine was energized within the specified period
Total embroidering time	Total time when the machine embroidered within the specified period
Total actual embroidering time	Total actual time when the machine embroidered within the specified period
Excluded time	Total time of intermission and maintenance for the number of days in the specified period
Electricity supply efficiency	Electricity supply efficiency by calculating below: (Total electricity supply time - excluded time) / total electricity supply time
Embroidering efficiency period	Ratio of the actual embroidering time to the total embroidering time Total actual embroidering time / total embroidering time
Number	The pattern embroidered during the specified period is numbered.
Pattern name	Name of the pattern
No. of stitches in pattern	Number of stitches in the pattern
Total stitches (*)	Total number of stitches by repeating embroidering No. of stitches in pattern X No. of times embroidered
No. of colors in pattern (*)	Number of colors in the pattern
No. of times embroidered (*)	Number of embroidering repeated
No. of workpieces embroidered (*)	Number of finished sheets by one embroidering cycle
Total no. of heads which are stopped	Total number of the heads at rest for one embroidering cycle
Embroidering time (*)	Time from embroidering start to the end for the pattern
Actual embroidering time (*)	Embroidering time from which the time for interruption, stop due to thread breakage, and stop due to error is excluded
Average embroidering speed	Average embroidering speed in the actual embroidering time (the number of stitches per minute) Total stitches/actual embroidering time
Efficiency 1 (*)	Ratio of the actual embroidering time to the embroidering time for the pattern with time for interruption excluded Actual embroidering time/(embroidering time-time for interruption)
Efficiency 2 (*)	Ratio of the actual embroidering time to the embroidering time Actual embroidering time / embroidering time
Time stopped (*)	Total of stop time during embroidering
Reason for stoppage (*)	Reasons for stoppage are indicated. Refer to the next page.

The items marked with "*" can be shown or hidden on the "Setting items to be displayed" screen.

Details of reason for stoppage

Interrupted	Frequency and total time stopped by the operator
Stoppage due to thread breakage	Frequency and total time stopped by thread breakage
Error	Frequency and total time stopped by errors

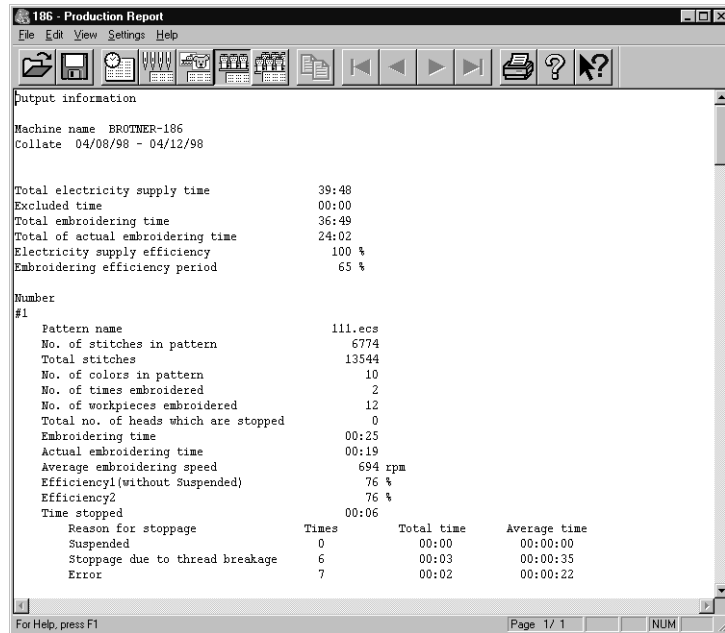

Display Example of Total Output Information

Displays the output information per pattern on multiple machines that are selected.

Display	Contents
Number	The pattern embroidered during the specified period is numbered.
Pattern name	Name of the pattern
No. of stitches in pattern	Number of stitches in the pattern
Total stitches (*)	Total number of stitches by repeating embroidering No. of stitches in pattern X No. of times embroidered
No. of colors in pattern (*)	Number of colors in the pattern
No. of times embroidered (*)	Number of embroidering repeated
No. of workpieces embroidered (*)	Number of finished sheets by one embroidering cycle
Total no. of heads which are stopped	Total number of the heads at rest for one embroidering cycle
Embroidering time (*)	Time from embroidering start to the end for the pattern
Actual embroidering time (*)	Actual embroidering time excluding the stop time by thread breakage, suspension and errors from the embroidering time
Actual embroidering speed (*)	Average embroidering speed in the actual embroidering time (the number of stitches per minute) Total stitches/actual embroidering time
Efficiency 1 (*)	Ratio of the actual embroidering time to the embroidering time for the pattern with time for interruption excluded Actual embroidering time/(embroidering time-time for interruption)
Efficiency 2 (*)	Ratio of the actual embroidering time to the embroidering time Actual embroidering time / embroidering time
Time stopped (*)	Total of stop time during embroidering
Reason for stoppage (*)	Reasons for stoppage are indicated. Refer to page 209.

The items marked with "*" can be shown or hidden on the "Setting items to be displayed" screen.

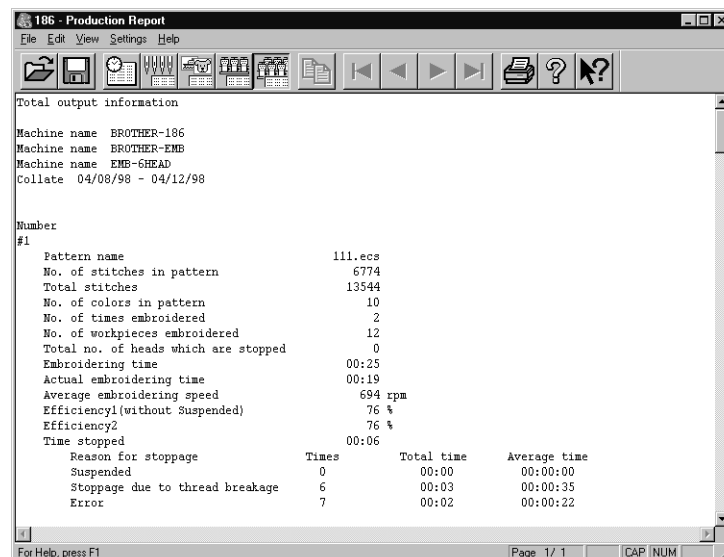

Setting Display Items

Sets display items for each production report.

- The following tab windows can be set:

General	Items related to the overall display of the output report.
Details	Items related to detail data.
Thread Breakage information on Needle Bar	Items related to thread breakage for each needle bar.
Thread Breakage information in Pattern	Items related to thread breakage for each pattern.
Output information	Items related to output information.
Total output information	Item related to total output information.
Recess time setting	Items not included in the efficiency calculation for output information and total output information.

1. Select [Items to be displayed] from Settings menu.

2. "Setting items to be displayed" screen appears.

Click the tab on the screen and the tab window for the items appears.

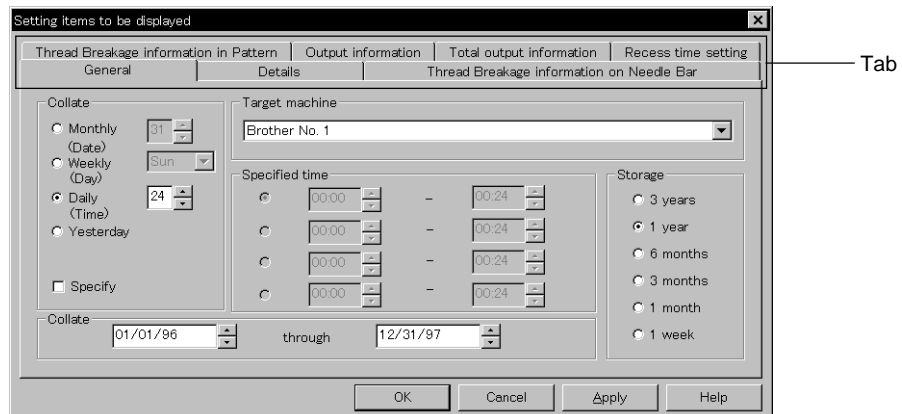

General

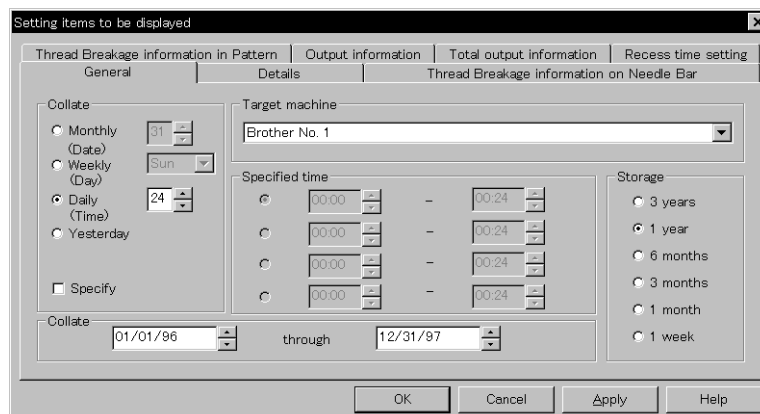

■ Collate

Selects the data collection period. If month, week or day is selected, set the end date or end hour.

■ Storage

Selects the data save period.

Details

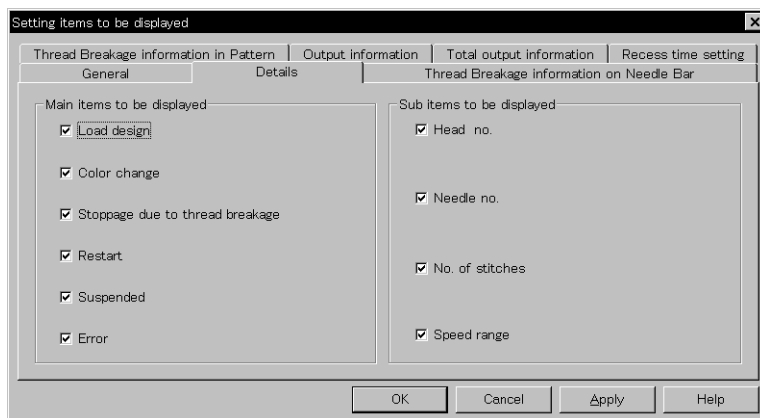

■ Main items to be displayed

Displays each event and the time.

Load design	Transfer time of embroidery data
Color change	Time of color change
Stoppage due to thread breakage	Time of thread breakage
Restart	Time of resuming embroidering after suspension
Stop after pressing button	Time when the emergency stop button was pressed
Suspended Error	Time when an error has occurred

■ Sub items to be displayed

Displays the following for each item in main display items.

Head no.	Head number
Needle no.	Needle number
No. of stitches	Number of stitches
Speed range	Speed range

Thread Breakage Information on Needle Bar

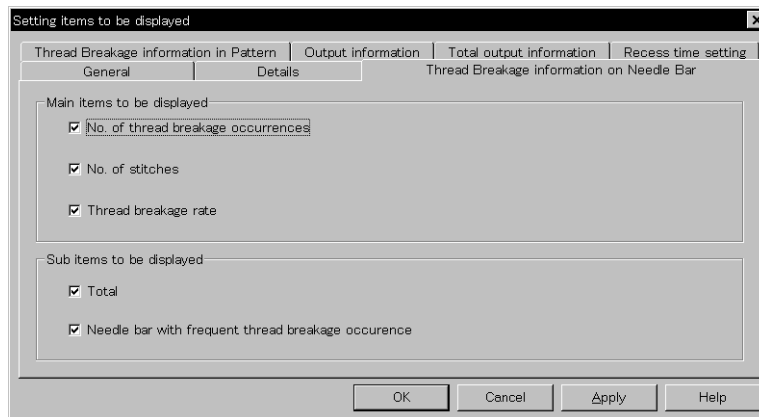

■ Main items to be displayed

No. of thread breakage occurrences	Number that thread breakage has occurred
No. of stitches	Number of stitches used in embroidery
Thread breakage rate	Rate of thread breakage for 10,000 stitches

■ Sub items to be displayed

Displays the following for each item in main display items.

Total	Total of the item for each head and each needle
Needle Bar with frequent thread breakage occurrences	Data of three needles that have caused thread breakage most frequently

Thread Breakage Information in Pattern

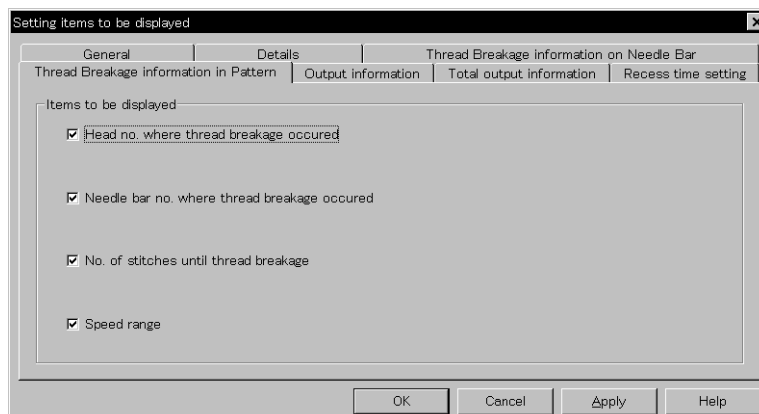

Head no. where thread breakage occurred	Head number that has caused thread breakage
Needle bar no. where thread breakage occurred	Needle number that has caused thread breakage
No. of stitches until thread breakage	Number of stitches until thread breakage has occurred
Speed range	Speed range when thread breakage has occurred

Output Information

Time is calculated to the unit of second, but the display unit is in minute. This may result in minor differences.

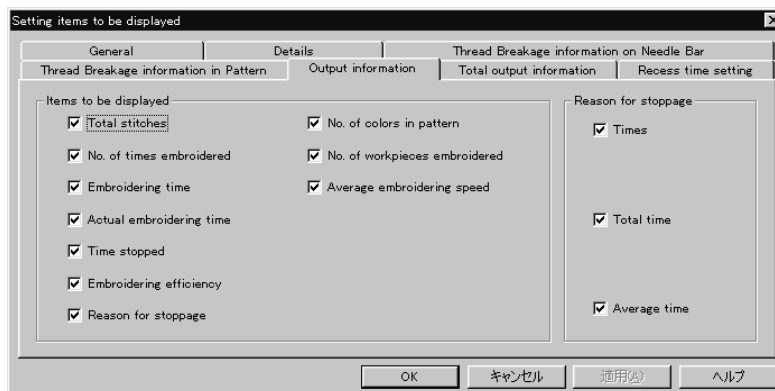

■ Items to be displayed

Total stitches	The total number of embroidery stitches from start to end
No. of times embroidered	Number of embroidering
Embroidering time	The total time from start to end spent for embroidery
Actual embroidering time	Time spent for embroidering
Time stopped	Time not spent for embroidering
Embroidering efficiency	Actual embroidery time/ (Embroidering time-Interrupted) Actual embroidery time/Embroidering time (in %)
Reason for stoppage	Event that caused a stop
No. of colors in pattern	Number of colors in pattern
No. of workpieces embroidered	Number of sheets embroidered.
Average embroidering speed	Number of total stitches/Actual embroidery time (number of stitches for 1 minute in embroidering)

■ Reason for stoppage

Items for selection appear when [Reason for Stoppage] is clicked in the "Items to be displayed" column.

The display shows for three cases: emergency button stop, thread breakage, and error stop.

Frequency	Number of stops
Total time	Total stop time
Average time	Average stop time per occurrence (in seconds)

Total Output Information

Time is calculated to the unit of second, but the display unit is in minute. This may result in minor differences.

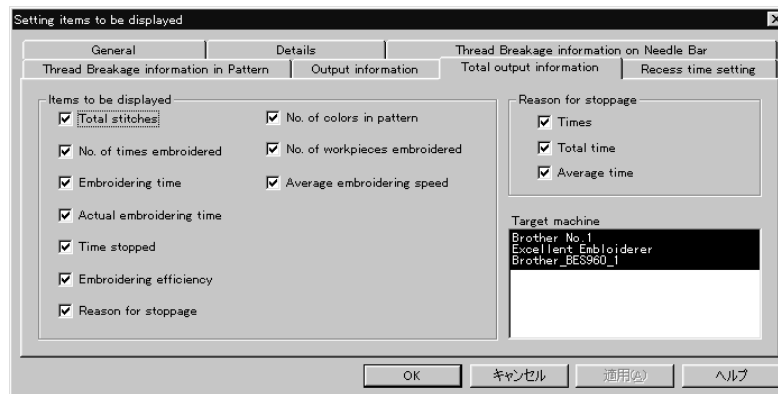

■ Items to be displayed

Total stitches	The total number of embroidery stitches from start to end
No. of times embroidered	Number of embroidering
Embroidering time	The total time from start to end spent for embroidery
Actual embroidering time	Time spent for embroidering
Time stopped	Time not spent for embroidering
Embroidering efficiency	Actual embroidery time/ (Embroidering time-Interrupted) Actual embroidery time/Embroidering time (in %)
Reason for stoppage	Event that caused a stop
No. of colors in pattern	Number of colors in pattern
No. of workpieces embroidered	Number of sheets embroidered.
Average embroidering speed	Number of total stitches/Actual embroidery time (number of stitches for 1 minute in embroidering)

■ Reason for stoppage

Items for selection appear when [Reason for Stoppage] is clicked in the "Items to be displayed" column.

The display shows for three cases: emergency button stop, thread breakage, and error stop.

Frequency	Number of stops
Total time	Total stop time
Average time	Average stop time per occurrence (in seconds)

■ Target machine

Click and select the machine for calculation. To cancel the selection, click again.

Recess Time Setting

Sets the time not to be included in the calculation. This time is displayed on the "Output" report as "Time Excluded".

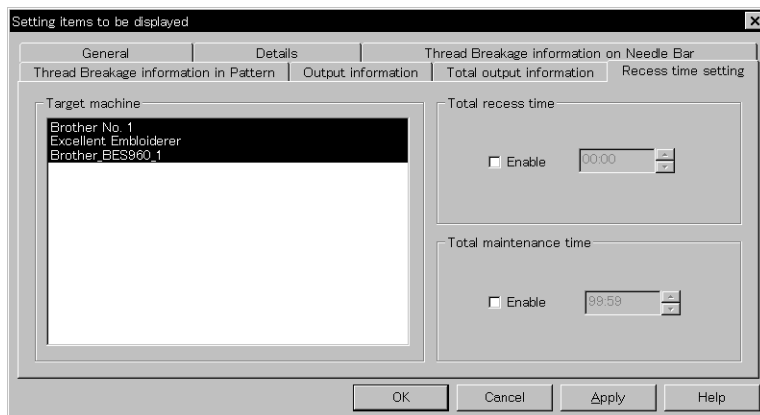

■ Target machine

Click and select the applicable machine for calculation.

■ Total recess time

Set the time not to be included in the day-to-day calculation during the designated period.

■ Total maintenance time

Set the time not to be included in the calculation throughout the period.

Save As CSV...

Converts the production report data to CSV format that can be read in spreadsheet software.

1. Select [Save As CSV] from File menu or click  .
2. The file name "Untitled. csv" automatically appears. To change the name, change "Untitled".
3. Select the directory to be saved and click [Save].

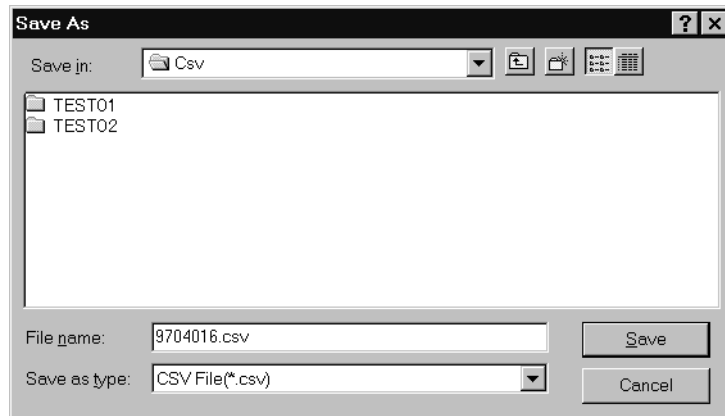

■ What is CSV format?

CSV (Comma Separated Value format) means a type of file formats used for PC. Data in each item is divided by commas and recorded as a text file. This format is mainly used for a spreadsheet software or data base software. The extension is "csv".

Printing Production Report

Prints the production report from a printer.

Page Setup

Printing method is set as required.

1. **Select [Page setup] from the File menu.**

Setting screen is displayed.

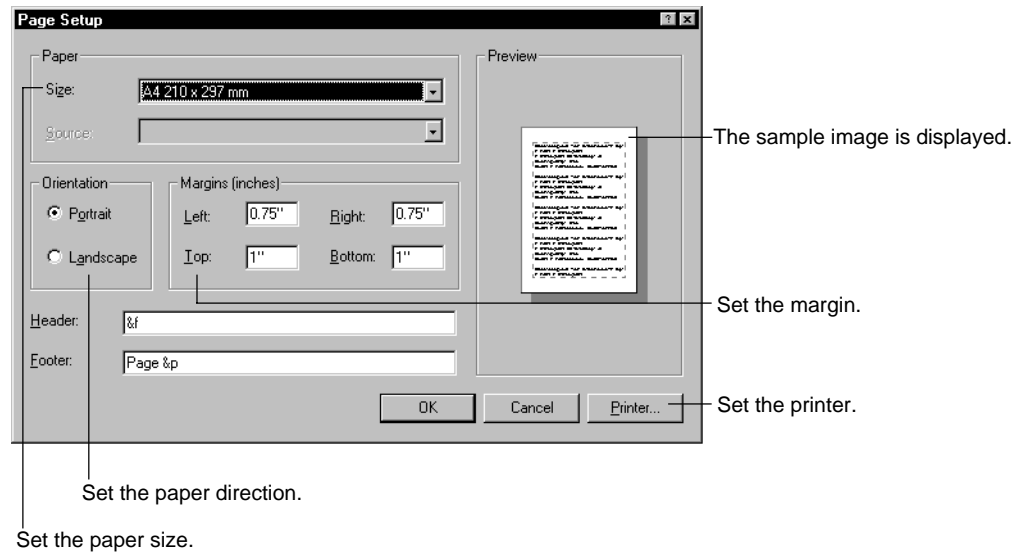

Print

1. **Select [Print] from File menu or click  .**

Set the number of sheets and click [OK].

Copying Report Data

Copies the selected area as text data. This allows use of the production report on other word processing software.

1. Select [Select All] from Edit menu, or drag and select the area to be copied.

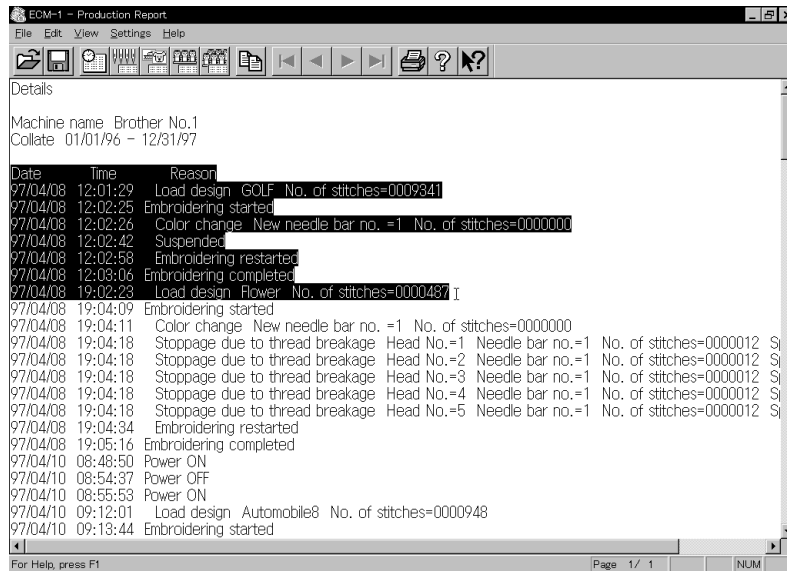

When dragging for selection

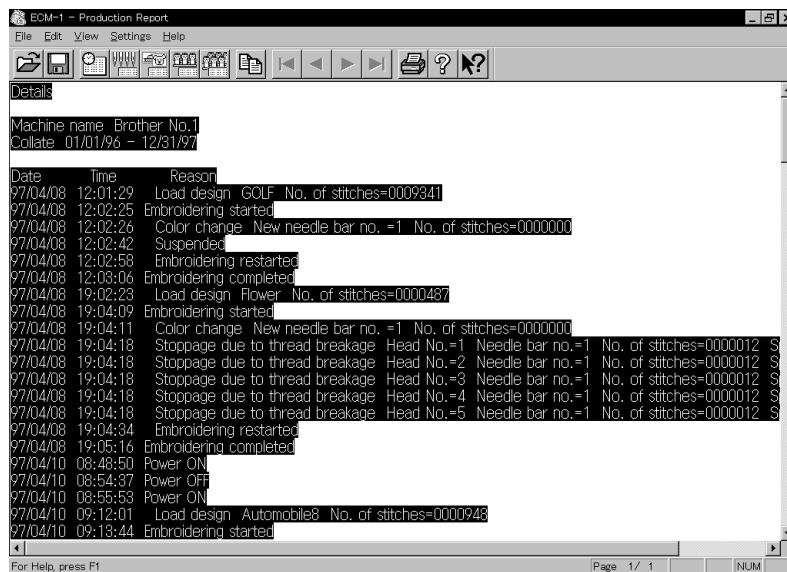

When selecting [Select All]

2. Select [Copy] from Edit menu or click  .
3. The area is copied as text data. Start a word processing software and select [Paste] from Edit menu.

Copied data is saved until another data is copied or cut.

Deleting Report

Deletes the record data for production report.

1. Select [Delete report file(s)] from Settings menu.

The password entry screen is displayed. Refer to the Brother sales department for password information.

2. Set the period to be deleted.

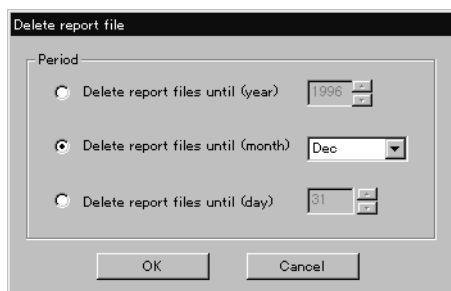

3. Click [OK].



Chapter 9 Maintenance

⚠ CAUTION

- ⚠
 Turn off the power switch before starting maintenance.
 Failure to do so may start the machine unintentionally through an accidental activation of the START switch, resulting in bodily injuries.

- ⊘
 Be sure to wear protective goggles and gloves when handling the lubricating oil or grease, so that no oil or grease gets into your eyes or onto your skin, otherwise inflammation can result.
 Furthermore, do not drink the oil or grease under any circumstances, as they can cause vomiting and diarrhoea.
 Keep the oil out of the reach of children.

- Keep the machine clean at all times to prevent machine trouble.
- Keep the machine clean.
 Remove dirt with a soft, dry cloth. If necessary, clean with the detergent-soaked cloth, then wipe off the detergent with a cloth dampened with (hot) water.
- Caution
 Never use benzene or thinner for cleaning the machine.

1. Cleaning

1-1 Cleaning and Lubrication of Rotary Hook

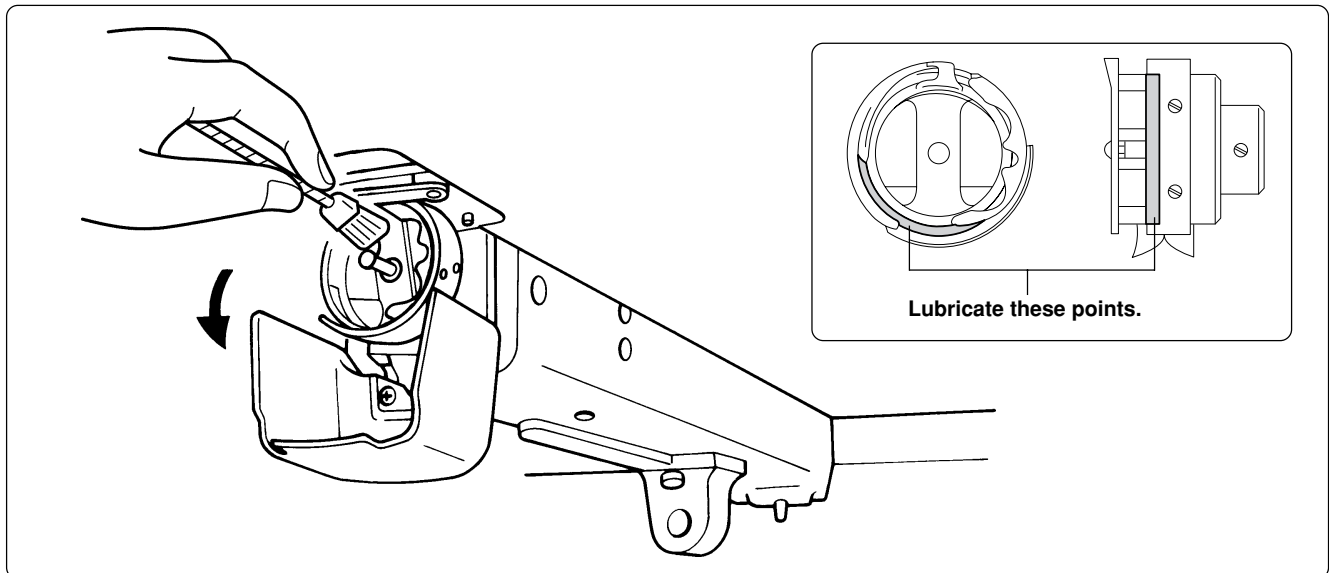

- Clean rotary hooks daily using the brush provided at the time of lubrication. If a rotary hook is too dirty, cleaning with a compressor (compressed air) is recommended.
- If thread breakage or rotary hook noise occurs during embroidering, lubricate the race of the rotary hook.

- Note)
- Use the dropper provided to supply oil. Use BROTHER's embroidery machine oil (equivalent to Nisseki Sewing Lub No. 10).
 - Supply a proper amount of oil. Any excess may stain fabrics, etc.

1-2 Cleaning of Needle Plate

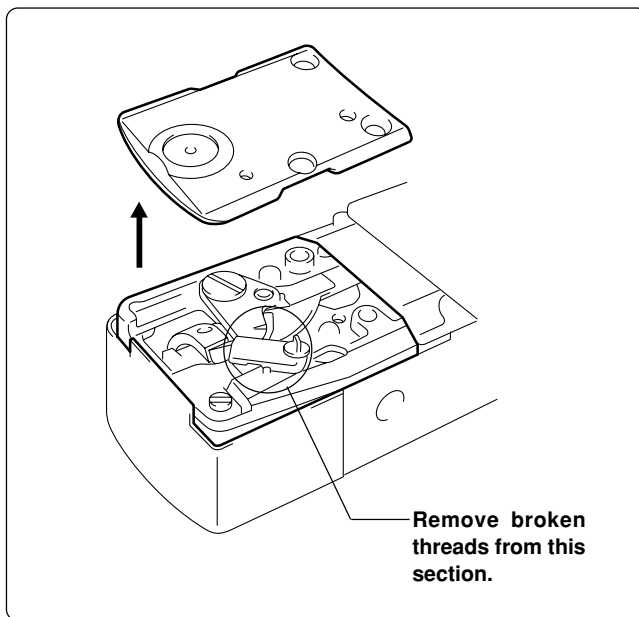

Broken threads left around the movable or fixed knives or the lower thread holding plate may result in thread trimming failure or parts damage. Clean them once a month.

1-3 Cleaning of Lower Shaft Module Fan

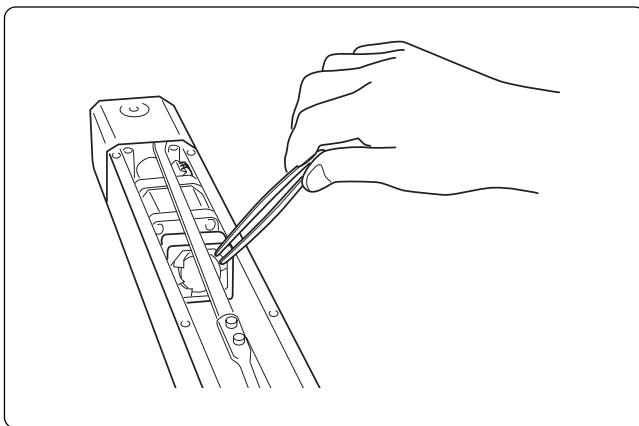

Remove lint from lower shaft module fan and its surroundings once a month using a pair of tweezers, etc.

2. Oiling

To extend the machine's service life, supply oil to the following places at regular intervals.

- (Note)
- When oiling, be sure to supply Brother's machine oil (Nisseki Sewing Lube #10 or the equivalent) using the dropper.
 - Excessive oiling may cause the material to be stained.

2-1 Head

■ BES-962BC

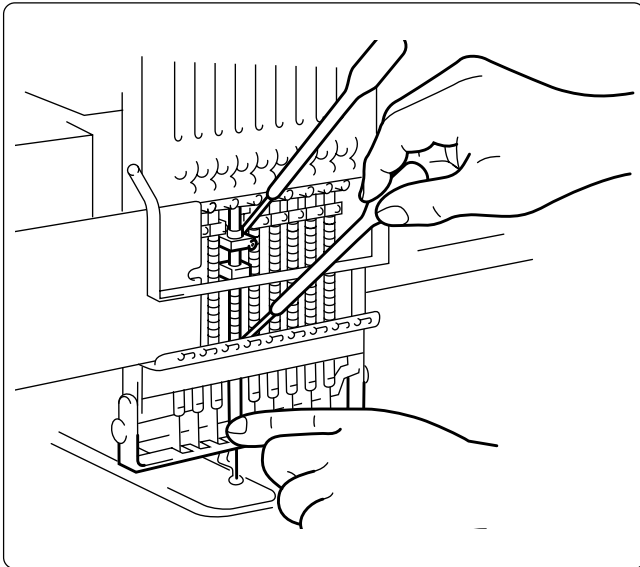

- Supply oil to the top and the bottom of each needle bar (18 points) daily as shown in the figure.

■ BES-1262BC

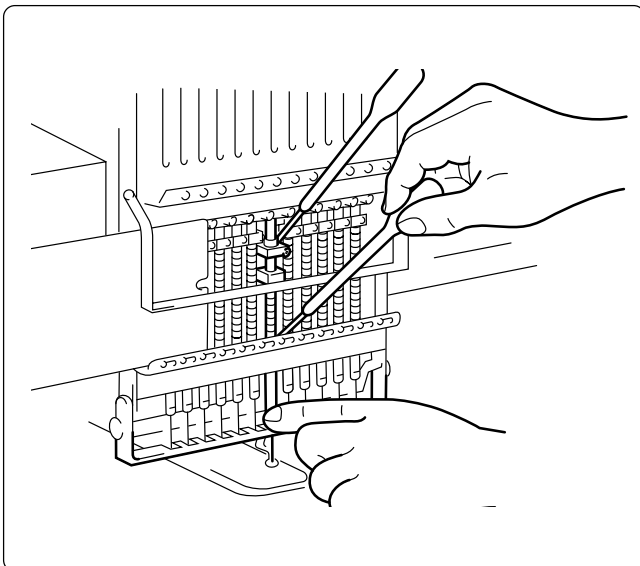

- Supply oil to the top and the bottom of each needle bar (24 points) daily as shown in the figure.

■ BES-962BC

Lubricate the following part indicated by the arrow ("clearance" between the connecting rod and the needle thread take-up bearing) once a week.

(Note) • In lubrication, select needle bar 9 and remove arm cover L to check the lubrication area. Be sure to wipe off excessive oil spilt at the lower part of the arm.

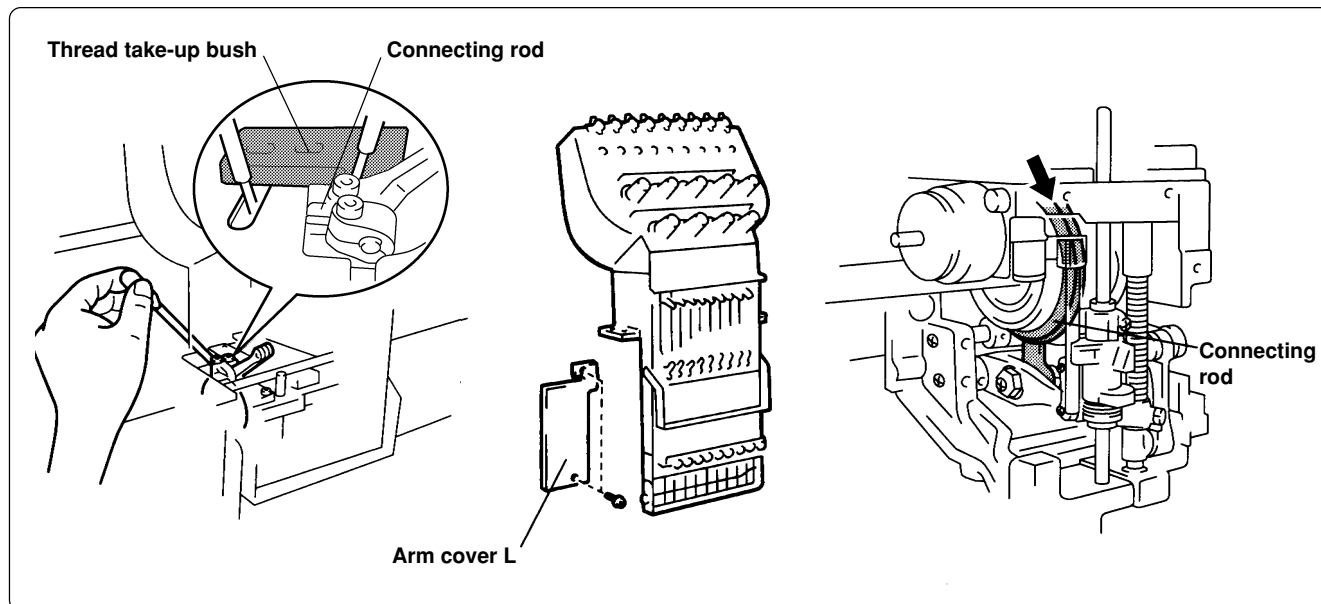

■ BES-1262BC

Lubricate the following part indicated by the arrow ("clearance" between the connecting rod and the needle thread take-up bearing) once a week.

(Note) • In lubrication, select needle bar 12 and remove the head cover to check the lubrication area. Be sure to wipe off excessive oil spilt at the lower part of the arm.

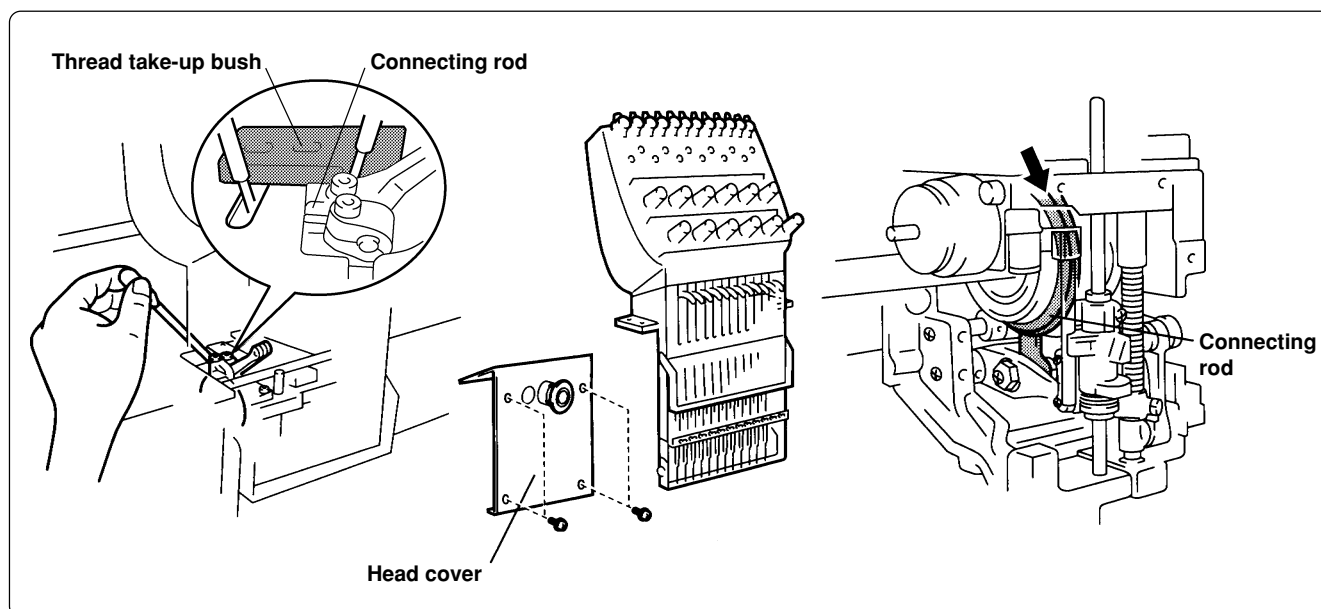

3. Greasing

To extend the machine's service life, supply grease to the following places at regular intervals.

(Note) • When greasing, be sure to use the grease tank BR2 (black) provided with the machine.

- For overhauling, contact your distributor or refer it to trained experts.

3-1 Head

■ Grease two places indicated by the arrow once a month.

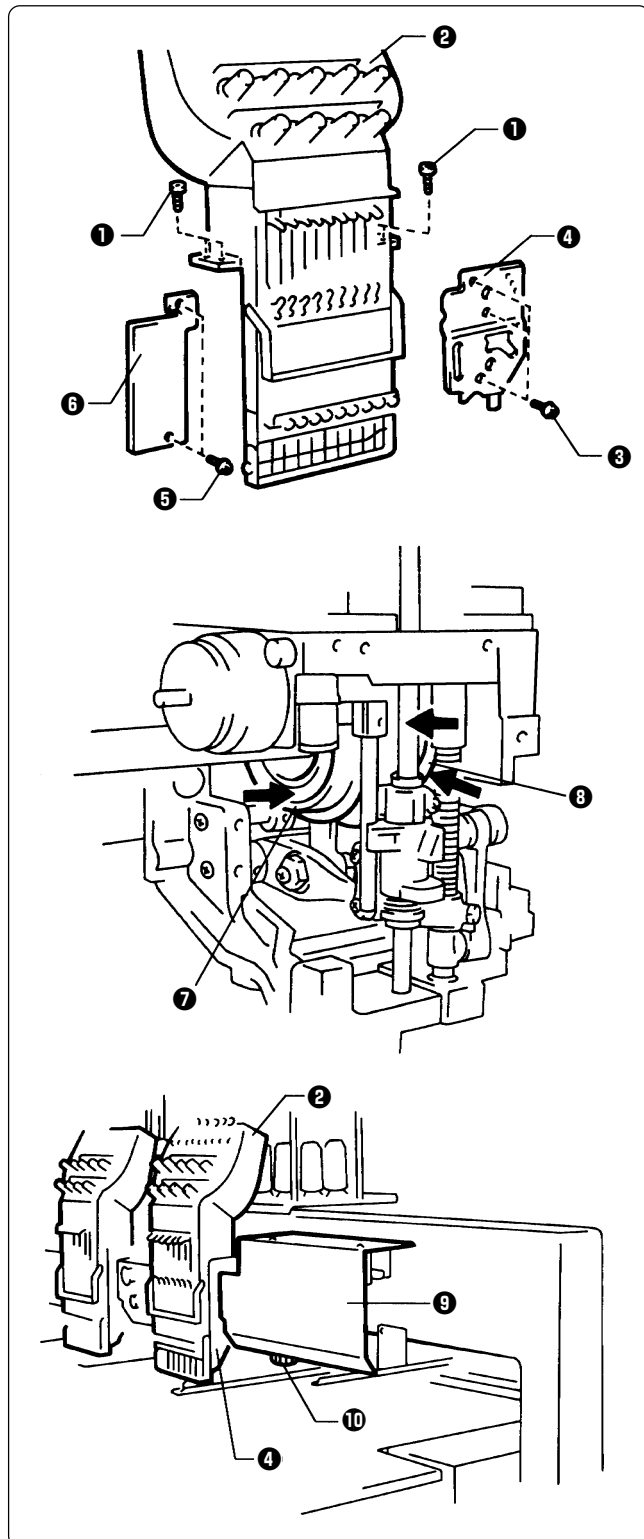

BES-962BC

1. Remove two connectors from the rear of the needle bar case.
2. Loosen four bolts ①, and remove the needle case ②.
3. Loosen three screws ③, and remove the presser foot guide plate ④.
4. Loosen two bolts ⑤, and remove the arm cover L ⑥.
5. Grease all the grooves of the thread take-up cam ⑦ and the work clamp cam ⑧.

* After greasing, assemble in the reverse order.

(Note) • When assembling the needle bar case ②, place it on the machine and turn the change pulley ⑩ behind the cover ⑨ at right. Check that it is engaged, and then tighten the bolts.

- When attaching the presser foot guide plate ④, move the presser foot up and down by the retracting lever to check that it is not distorted.

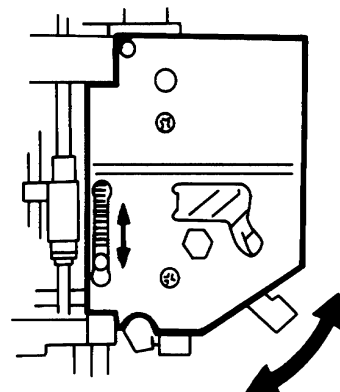

BES-1262BC

1. Remove two connectors from the rear of the needle bar case.
2. Loosen four screws ①, and remove the head cover ②, and loosen two screws ③ and remove the head cover R ④.
(Note) Because the heads No.1 and No.2 have the head covers R and L respectively, remove both the the covers when greasing.
3. Loosen four bolts ⑤, and remove needle bar case ⑥.
4. Loosen three bolts ⑦, and remove presser foot guide plate ⑧.
5. Grease all the grooves of the thread take-up cam ⑨ and the work clamp cam ⑩.

* After greasing, assemble in the reverse order.

- (Note)
- When reattaching the head cover ② after its removal, move the needle bar case to the needle bar 6 position.
 - When assembling the needle bar case ⑥, place it on the machine and turn the change pulley ⑫ behind the cover ⑪ at right. Check that it is engaged, and then tighten the bolts.
 - When attaching the presser foot guide plate ⑧, move the presser foot up and down by the retracting lever to check that is it not distorted.

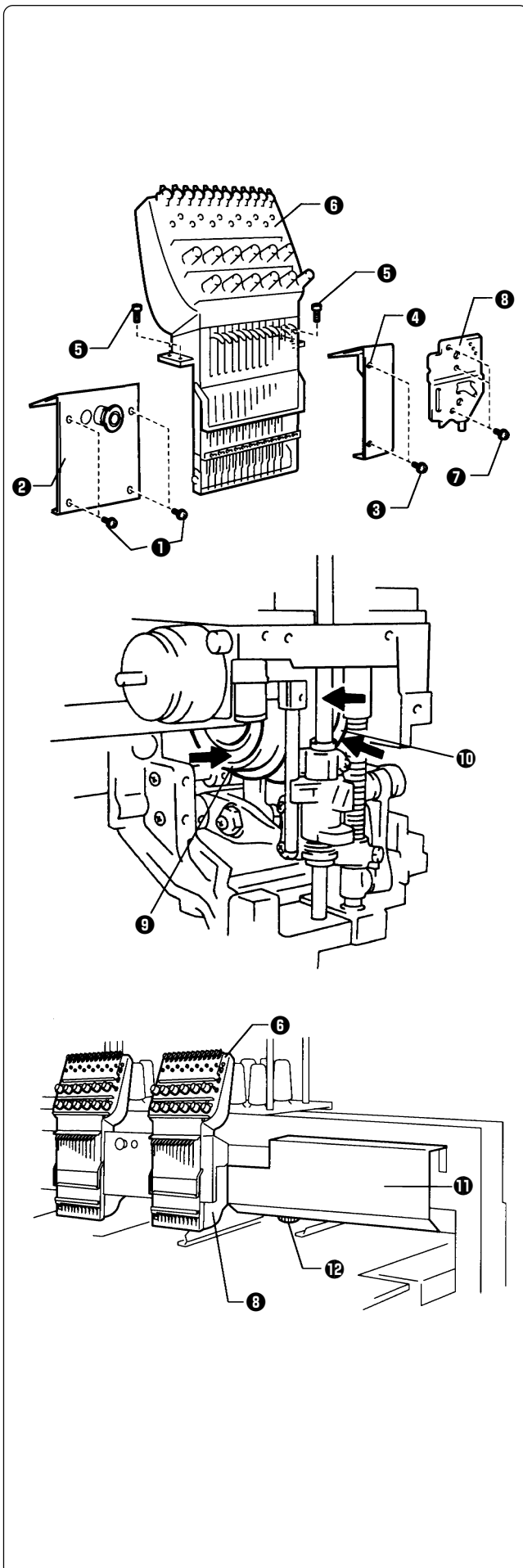
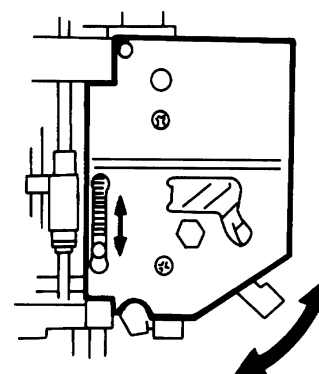

■ Grease the places indicated by the arrow once in six months.

(Note) When greasing, be sure to use the grease tank BR2 (black) provided with the machine.

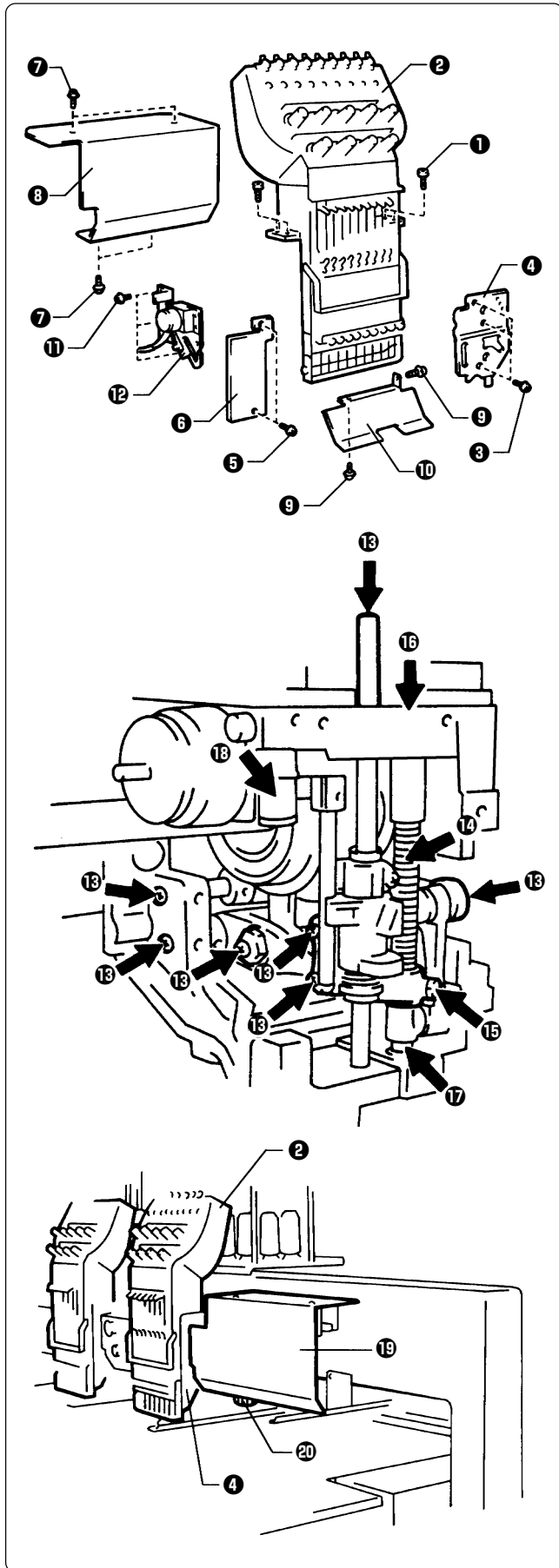

BES-962BC

1. Remove two connectors from the rear of the needle bar case.
2. Loosen four bolts ①, and remove the needle case ②.
3. Loosen three screws ③, and remove the presser foot guide plate ④.
4. Loosen two screws ⑤, and remove the arm cover L ⑥.
5. Loosen four screws ⑦, and remove the head cover ⑧.
6. Loosen two bolts ⑨, and remove the cap eaves guide ⑩.
7. Loosen three bolts ⑪, and remove the wiper solenoid assembly ⑫.
8. Remove screws ⑬ (7 pcs) indicated by arrows. Apply grease to the tapped holes with the syringe provided and tighten the screws again. Also apply grease to presser bar spring ⑭, the end of presser bar guide bracket ⑮, presser bar metals U ⑯ and D ⑰, and jump rotary shaft ⑱.

* After greasing, assemble in the reverse order.

(Note) • When assembling the needle bar case ②, place it on the machine and turn the change pulley ⑳ behind the cover ⑲ at right. Check that it is engaged, and then tighten the bolts.

• When attaching the presser foot guide plate ④, move the presser foot up and down by the retracting lever to check that it is not distorted.

For more information, refer to the illustration on page 226.

BES-1262BC

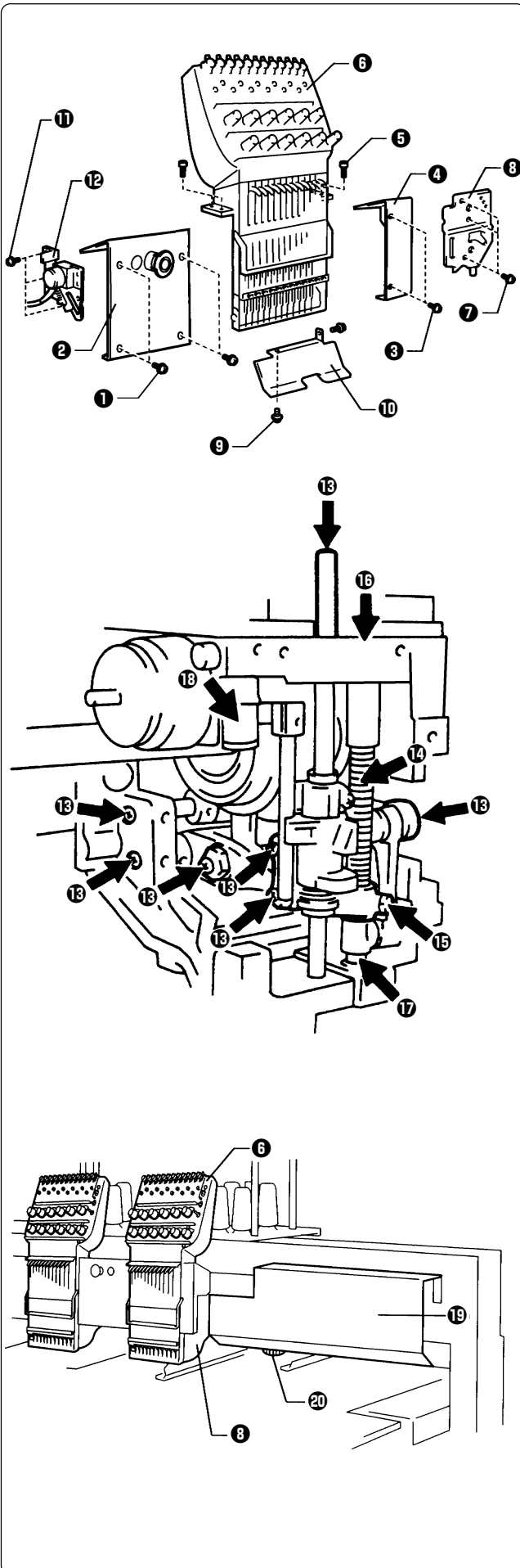

1. Remove two connectors from the rear of the needle bar case.
2. Loosen four screws ①, and remove the head cover ②, and loosen two screws ③ and remove the head cover R ④.
(Note) Because the heads No.1 and No.4 have the head covers R and L respectively, remove both the the covers when greasing.
3. Loosen four bolts ⑤, and remove the needle case ⑥.
4. Loosen three screws ⑦, and remove the presser foot guide plate ⑧.
5. Loosen two bolts ⑨, and remove the cap eaves guide ⑩.
6. Loosen three bolts ⑪, and remove the wiper solenoid assembly ⑫.
7. Remove screws ⑬ (7 pcs) indicated by arrows. Apply grease to the tapped holes with the syringe provided and tighten the screws again.
Also apply grease to presser bar spring ⑭, the end of presser bar guide bracket ⑮, presser bar metals U ⑯ and D ⑰, and jump rotary shaft ⑱.

* After greasing, assemble in the reverse order.

- (Note) • When reattaching the head cover ② after its removal, move the needle bar case to the needle bar 6 position.
- When assembling the needle bar case ⑥, place it on the machine and turn the change pulley ⑳ behind the cover ⑲ at right. Check that it is engaged, and then tighten the bolts.
 - When attaching the presser foot guide plate ⑧, move the presser foot up and down by the retracting lever to check that is it not distorted.

For more information, refer to the illustration on page 227.

3-2 Feed Guide Section

■ Check the X-feed linear guides (2 positions) and the Y-feed linear guides (one each on the right and left, and one point on bed No. 3).

(Note) When greasing, be sure to use the grease tank 30 provided with the machine.

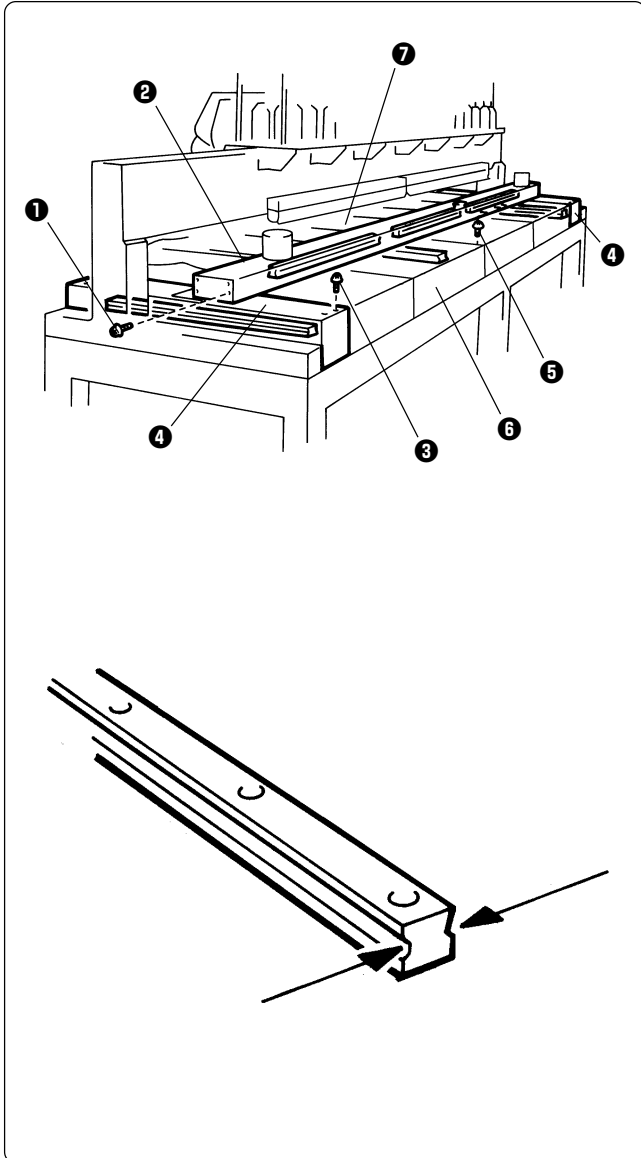

Procedure

1. Loosen 12 screws ①, and remove the X-feed cover ②.
2. Loosen eight screws ③, and remove the cover ④.
3. Remove thirteen screws ⑤. Remove bed covers B ⑥ and C ⑦.
4. Grease the X-feed linear guides (3 positions), the Y-feed linear guides (one each on the right and left), and the linear guide inside the No. 3 bed. Slide the guide to spread grease entirely.

* After greasing, assemble in the reverse order.



Chapter 10 Adjustment

⚠ CAUTION

⚠ Turn off the power switch and pull out the plug before starting adjustment. Failure to do so may start the machine unintentionally through an accidental activation of the START switch, resulting in bodily injuries.

• Adjustment

⚠ If adjustment should be made while the power switch is turned on, pay special attention to your safety.

⊘ Maintenance and inspection of the machine should be conducted only by trained engineers.

1. Adjusting Needle Bar Height

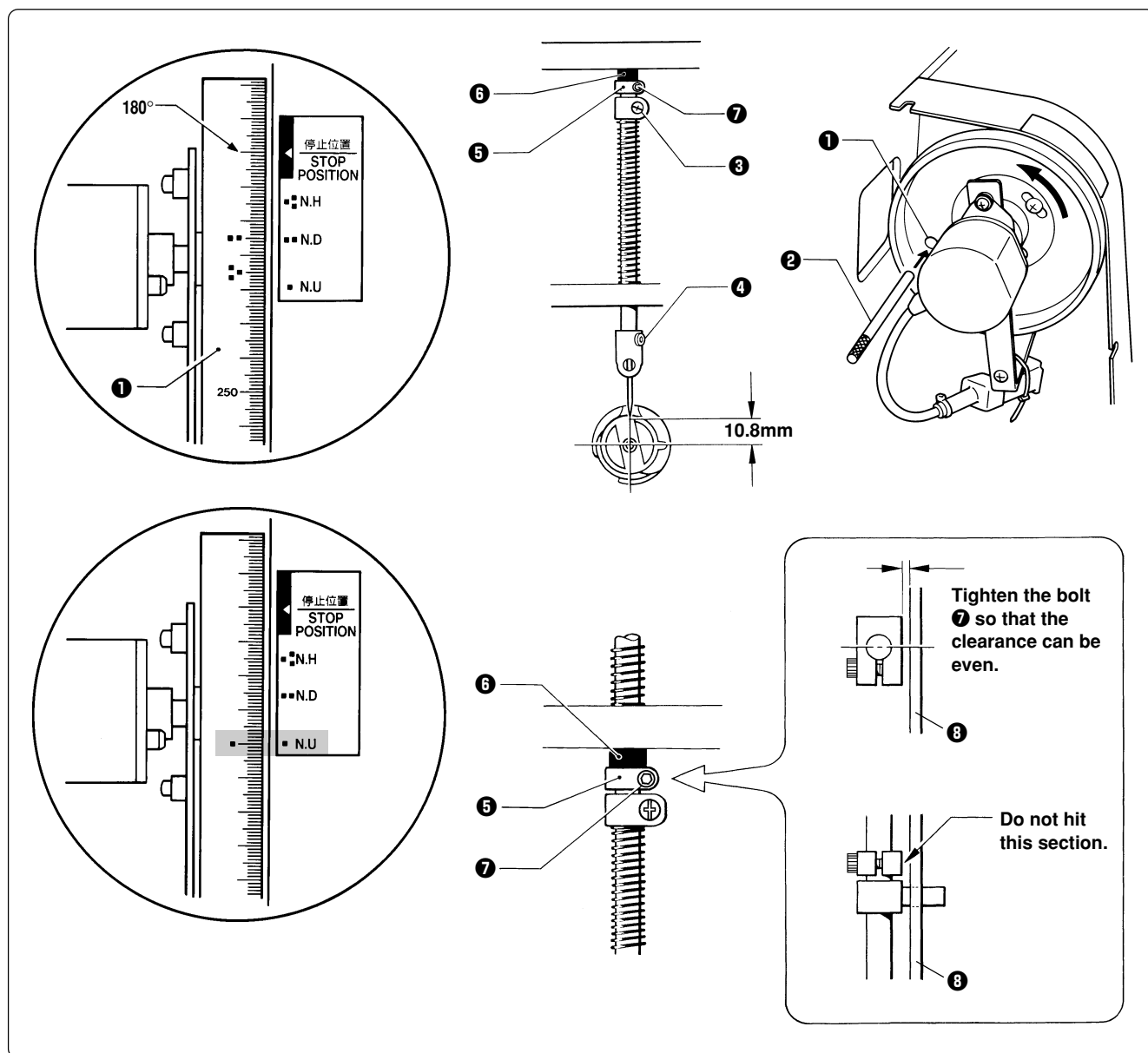

1. Dismount the pulley cover and turn the pulley B ❶ until the pulley scale indicates 180° and the needle bar is set at the lowest position. (The pulley B "■" mark and the stop mark "■" are aligned.)
2. Insert the positioning bar ❷ into the hole of the pulley B ❶ and fix the drive shaft.
Note) Turn the pulley B securely in the clockwise direction to eliminate a backlash.
3. Loosen Needle bar guide bracket set screw ❸ and the bolt ❹ of the top dead center stopper ❺ when the needle tip is positioned 10.8 mm above the center of the rotary hook shaft. Adjust the position of the needle bar thread guide so that the set screw ❷ on it is turned to the right by 25 ~ 30°. Tighten Needle bar guide bracket set screw ❸ securely.
Note) When tightening the needle bar clamp set screw ❸, the hole in the needle bar guide should face the front.
4. After adjustment is finished, remove the positioning bar ❷.
5. Set the needle bar at the highest position (where the pulley B indication mark "■" and the cover indication mark "■" are aligned). Lightly press the top dead center stopper ❺ toward the cushion rubber ❻, and tighten Socket head bolt for top dead center stopper ❹ while pressing down the needle bar clamp so that it faces the front. (Tightening torque: 0.78 N·m)
Note) • Make sure that the top dead center stopper does not hit the needle bar guide rail ❸ at this time.

■ When using the bottom dead center gauge

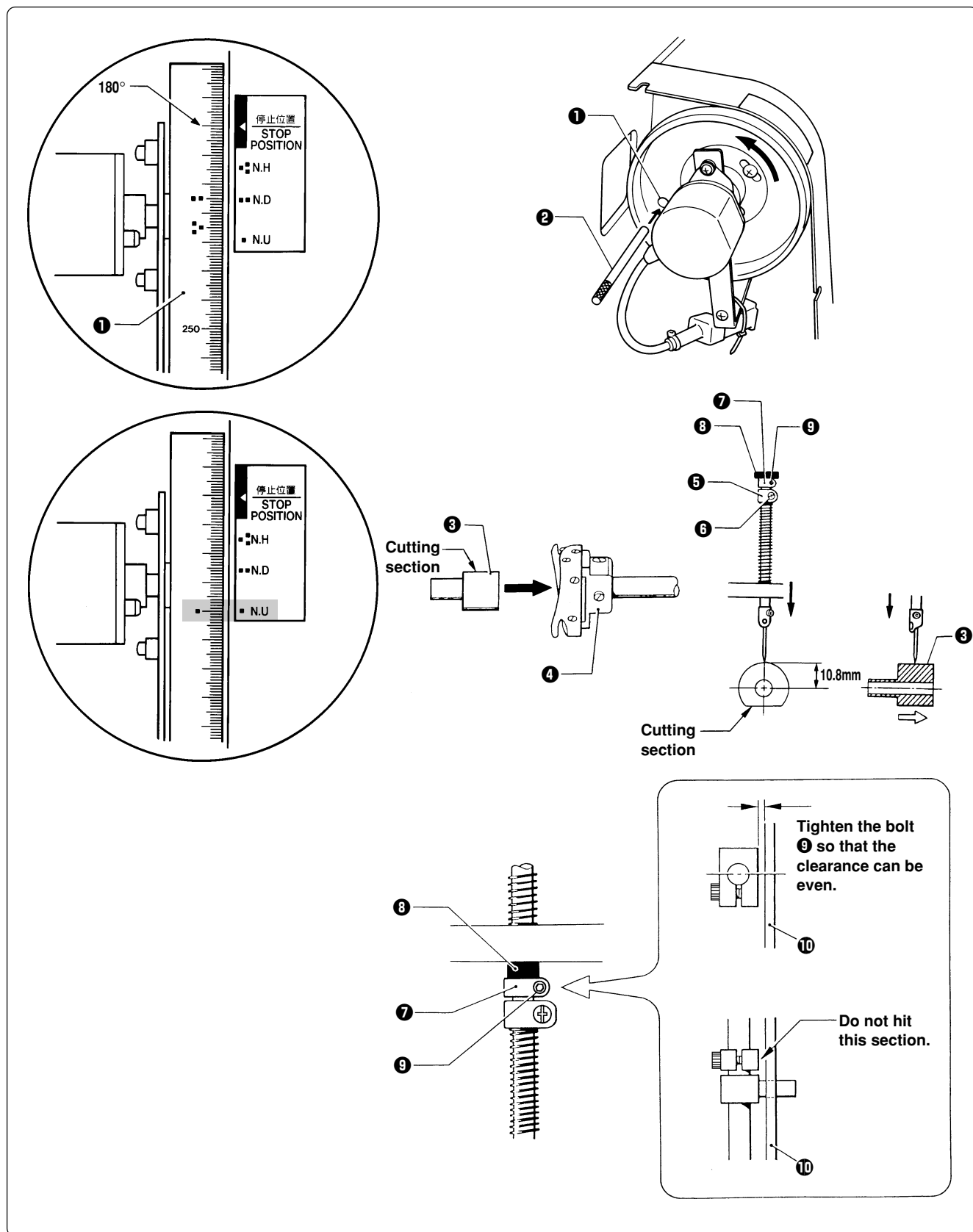

1. Turn the pulley B ❶ until the scale of pulley B ❶ indicates 180° (where the pulley B indication mark "■" and the stop mark "■" are aligned) and the needle bar is set at the lowest position.
2. Insert the positioning bar ❷ into the hole of the pulley B ❶ and fix the drive shaft.
Note) Turn the pulley B securely in the clockwise direction.
3. Insert the bottom dead center gauge ❸ into the rotary hook ❹.
4. Loosen the screw ❺ of the needle bar clamp ❽ and Socket head bolt for top dead center stopper ❹, then move the needle bar up and down until the needle tip touches the gauge ❸ lightly.
Note) • The needle point should touch the gauge at a place other than the cutting section.
• The bottom dead center gauge should be set in or removed from the rotary hook with its cutting section facing upward.
5. Tighten the screw ❺ of the needle bar clamp ❽ securely.
6. After adjustment is finished, remove the positioning bar ❷.
7. Set the needle bar at the highest position (where the pulley B indication mark "■" and the cover indication mark "■" are aligned). Lightly press the top dead center stopper ❺ toward the cushion rubber ❽, and tighten Socket head bolt for top dead center stopper ❹ while pressing down the needle bar clamp so that it faces the front. (Tightening torque: 0.78 N·m)
Note) • Make sure that the top dead center stopper ❺ does not hit the needle bar guide rail ❿ at this time.

2. Replacing (Attaching) Rotary Hook

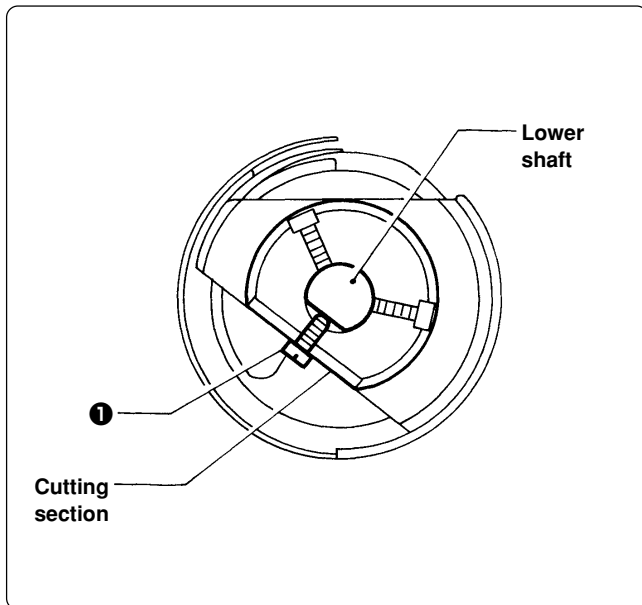

1. Turn the power switch off.
2. Tighten the screw ❶ of the rotary hook cutting section to fit to that of the lower shaft ❷.
3. When mounting, press it inward until it stops.

Note) After replacing rotary hooks, refer to "4. Adjustment of Timing Between Needle and Rotary Hook (Page 238)" and adjust the timing.

3. Adjustment of Clearance Between Needle and Rotary Hook

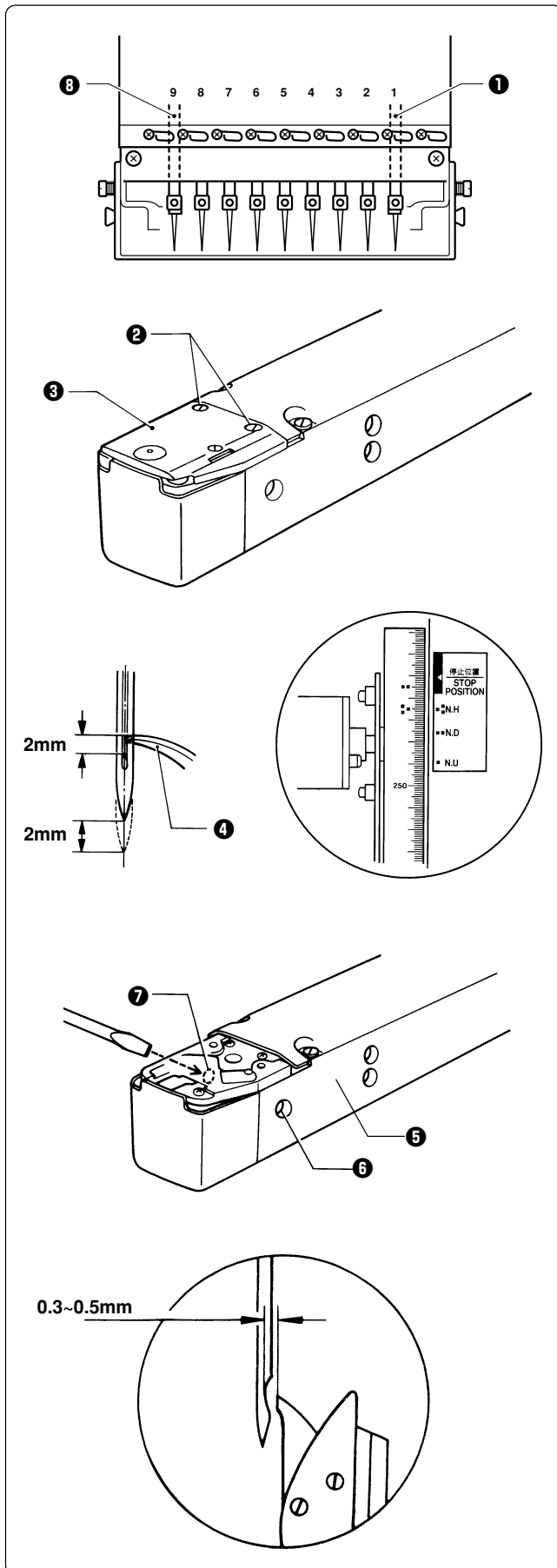

1. Turn the power switch off.
2. Select the needle bar No. 1 ①.
The illustration at the left shows the case of BES-962BC. For BES-1262BC, the No. 12 needle becomes needle bar No. 9.
3. Remove two flat screws ② and dismount the needle plate ③.
4. Turn the pulley B until the pulley indication mark "■" and the stop mark "NH■" are aligned.
5. Turn the rotary hook ④ manually so that the rotary hook point is aligned properly.
6. Loosen the set screw ⑥ on the side of the bed ⑤.
7. Turn the eccentric screw ⑦ on the left side of the bed ⑤ using a regular screwdriver and adjust a clearance between the needle and the rotary shaft to 0.3 ~ 0.5 mm.
8. Adjust the clearance between the needle and the rotary hook's point to 0.3 ~ 0.5 mm at the needle bar No. 9 ⑧ (No. 12 needle for BES-1262BC).

Note) If the clearance between the needle and the rotary hook point is not within the range of 0.3 ~ 0.5 mm, adjust again as described in the step ④ until the needle bar No. 1 or No. 9 (No. 12 for BES-1262BC) whichever has the smallest clearance may not be interfered by the rotary hook point.

4. Adjustment of Timing Between Needle and Rotary Hook

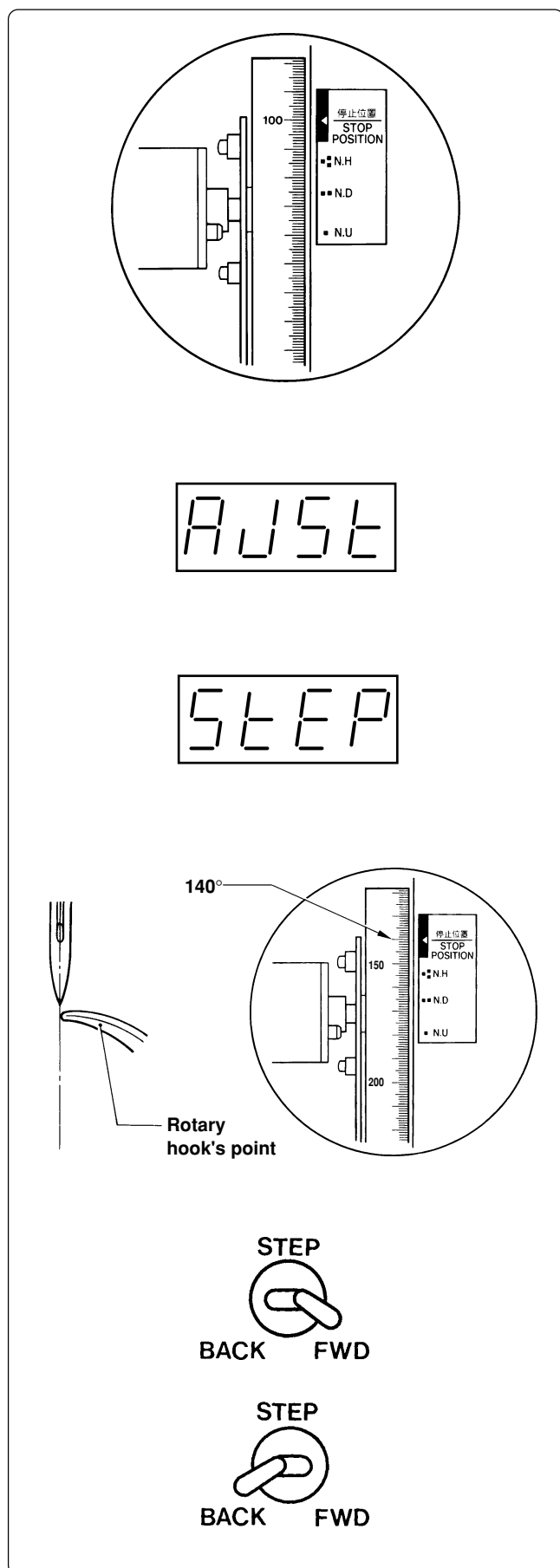

1. Turn the power switch on.
2. Check that the machine pulley is at the stop position (at 100° of the scale). If not, turn the pulley until it comes to the stop position.

3. While the machine is at the stop position, press the JOG switch (▽) while holding down the STOP switch. "AJST" is indicated on the display.



4. Pressing the START switch. "STEP" is indicated. The rotary hook in each machine head rotates to the currently set timing position and the rotary hook can be adjusted.

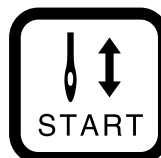

5. Turn the machine pulley manually until the relationship between the needle point and the rotary hook's point can be easily checked (at around 140° of the scale).
6. Press the STEP BACK/FWD switch to move the rotary hook for each head to adjustment.
 - STEP BACK
For rotating the rotary hook little by little in the clockwise direction
 - STEP FWD
For rotating the rotary hook little by little in the counterclockwise direction

Make this adjustment for each machine head so that the needle and the rotary hook's point can fit with each other.

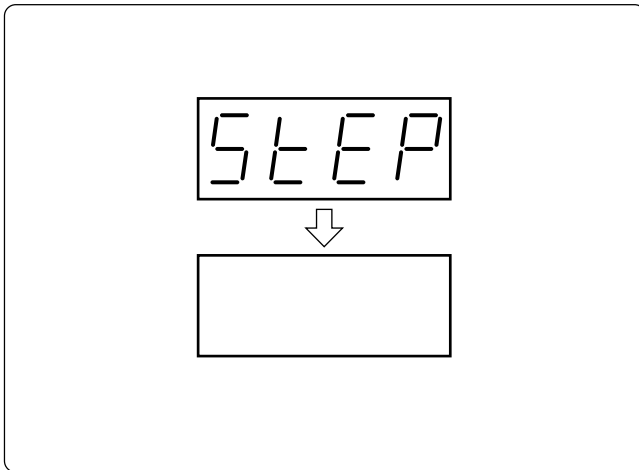

7. After timing adjustment the is finished for each head, set the pulley to the stop position (at 100° of the scale) and press the STOP switch. "STEP" disappears from the display, and the machine enters the standby state.



The adjustment of the rotary hook is completed and the timing is stored. The rotary hook returns to the stop position accordingly.

5. Adjustment of Presser Foot Height

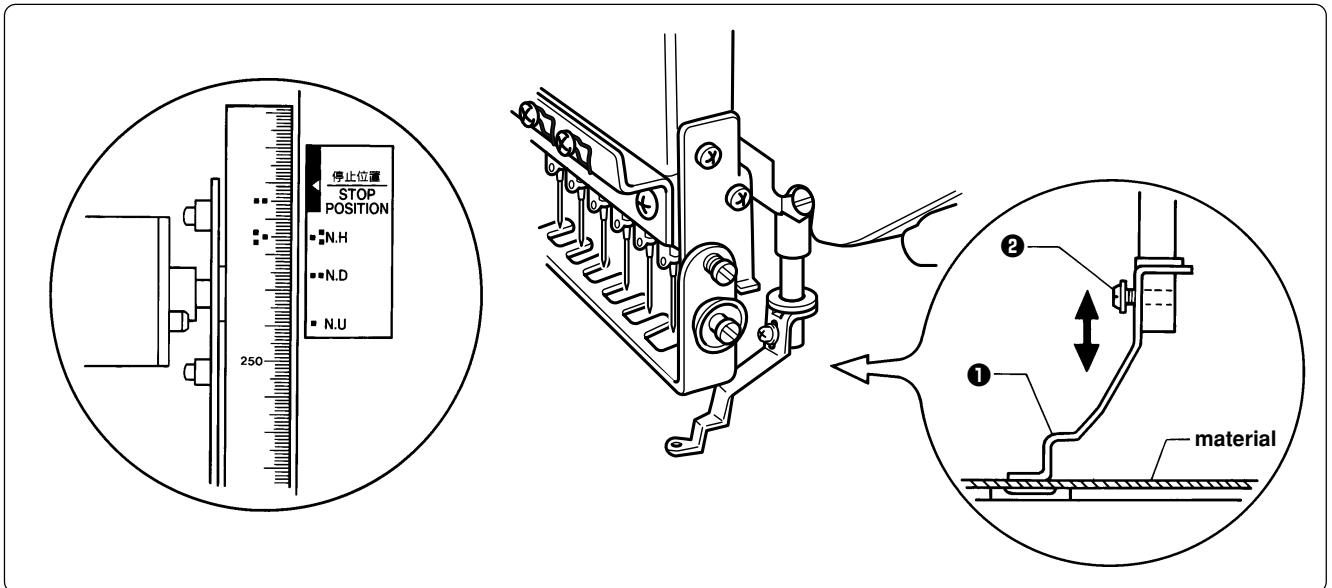

1. Turn the power switch off.
2. Select the needle bar No. 1.
3. Loosen the screw ② of the presser foot ①, and adjust the presser foot ① until it comes above the cloth top surface when it is at the bottom dead center (where the pulley indication mark "■" and the cover indication mark "■" are aligned).

Note) When the presser feet have been adjusted in height, check that each needle lowers to the center of the presser foot hole.

6. Adjustment of Thread Trimmer

6-1 Attaching the Fixed Knife

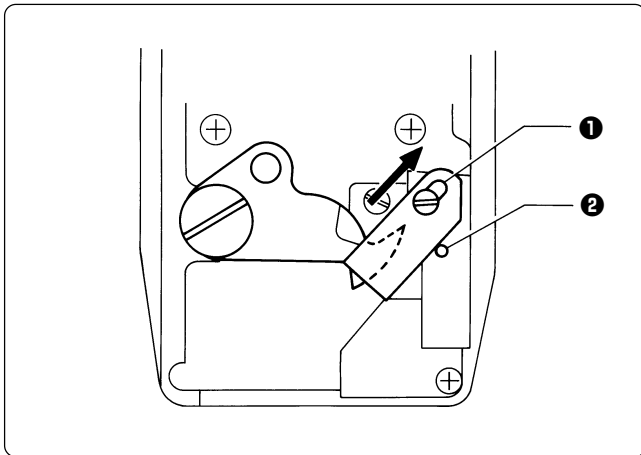

Attach the fixed knife **1** to the pin **2** and move it backward to the end of the slot, then mount it there.

6-2 Checking the Movable Knife Position

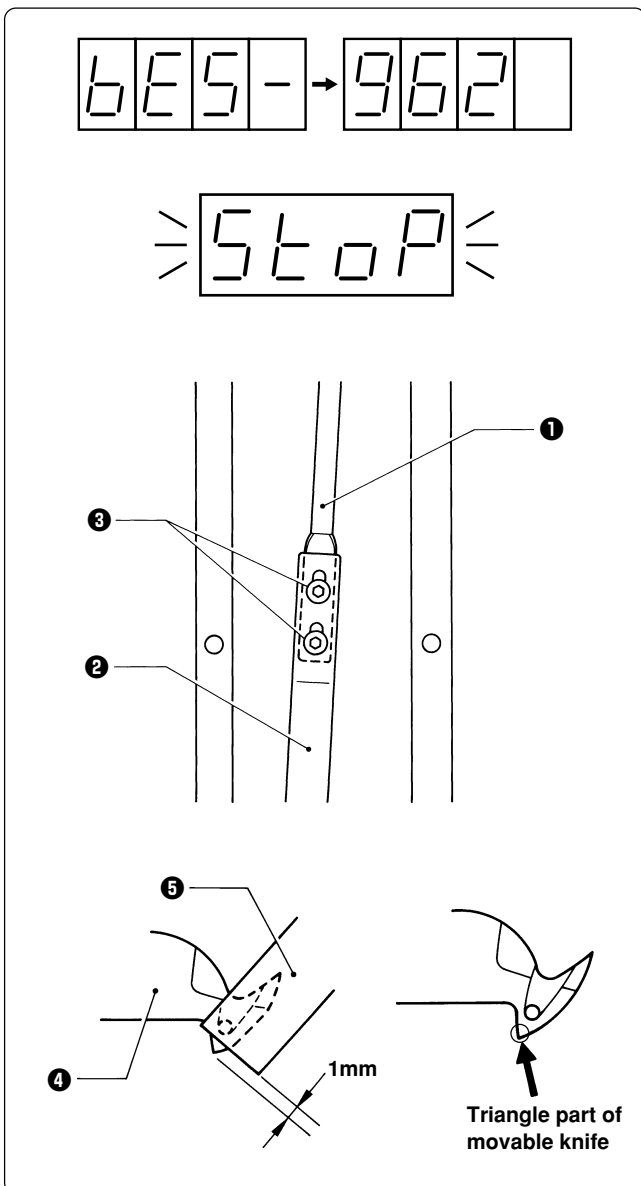

1. Turn the power switch on and wait until the hoop home position detection is finished.
2. Press the stop switch for safety.



Adjust the movable knife position in this state.

3. Loosen two bolts **3** that connect the thread trimmer connecting rods C **1** and B **2**.
4. Tighten the two bolts **3** until the triangle part of the movable knife **4** is projected by 1 mm from the fixed knife **5**.

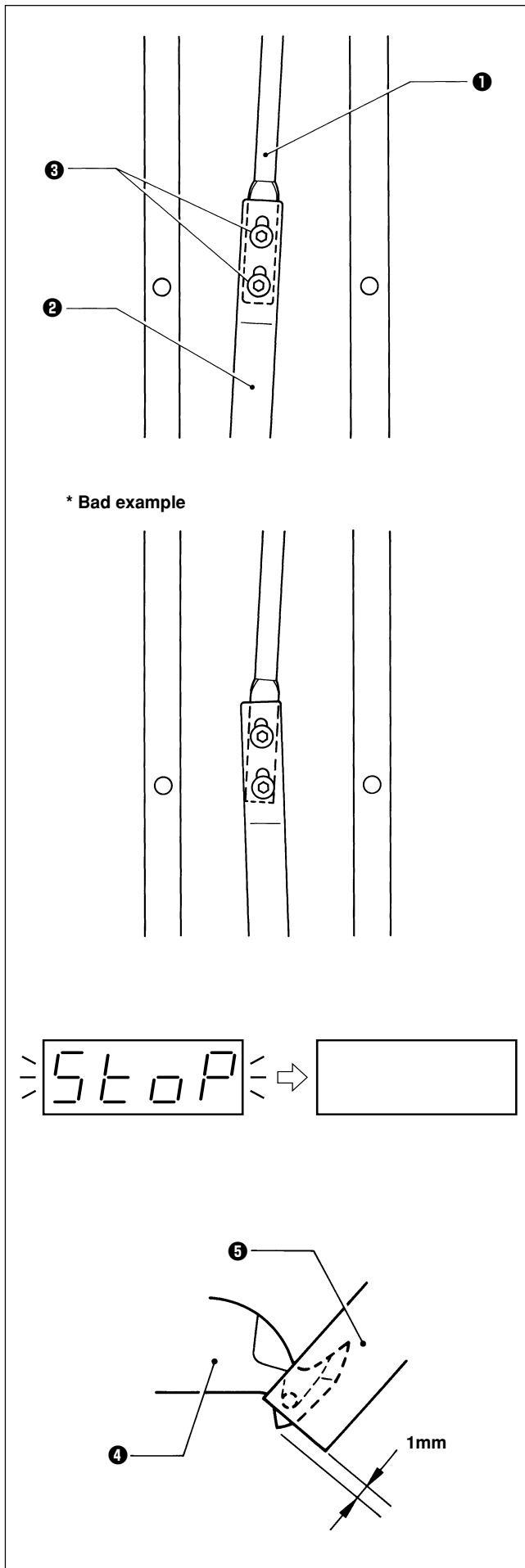

* Precautions for tightening the two bolts ③:

- The thread trimmer connecting rod B ② has a backlash of about 0.1 ~ 0.2 mm back and forth. Tighten the two bolts ③ while pulling them forward by the backlash amount.
- Tighten the two bolts ③ so that the thread trimmer connecting rods B ② and C ① are positioned in a straight line.

Mount head No. 3 so as to make thread trimmer connecting rod D ④ parallel with the side of the bed. (Check that no interference will occur during feed in the crosswise direction.)

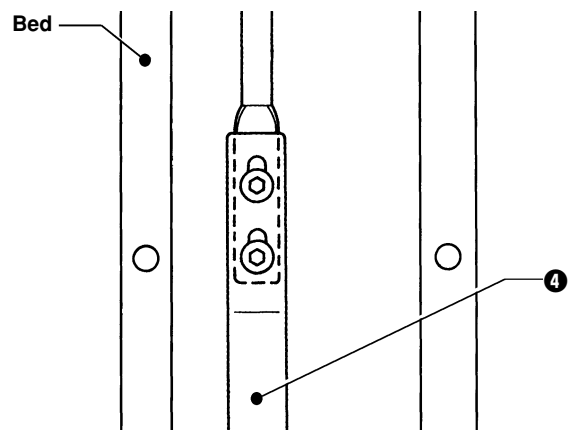

5. After adjustment is finished, reset the stop switch. "STOP" stops blinking and disappears.

6. Turn the power switch off once, then on again. Check that the clearance between the movable knife ④ and the fixed knife ⑤ is 1 mm.

7. When adjusting again, follow the step 2 and after.

7. Thread Wiper Adjustment

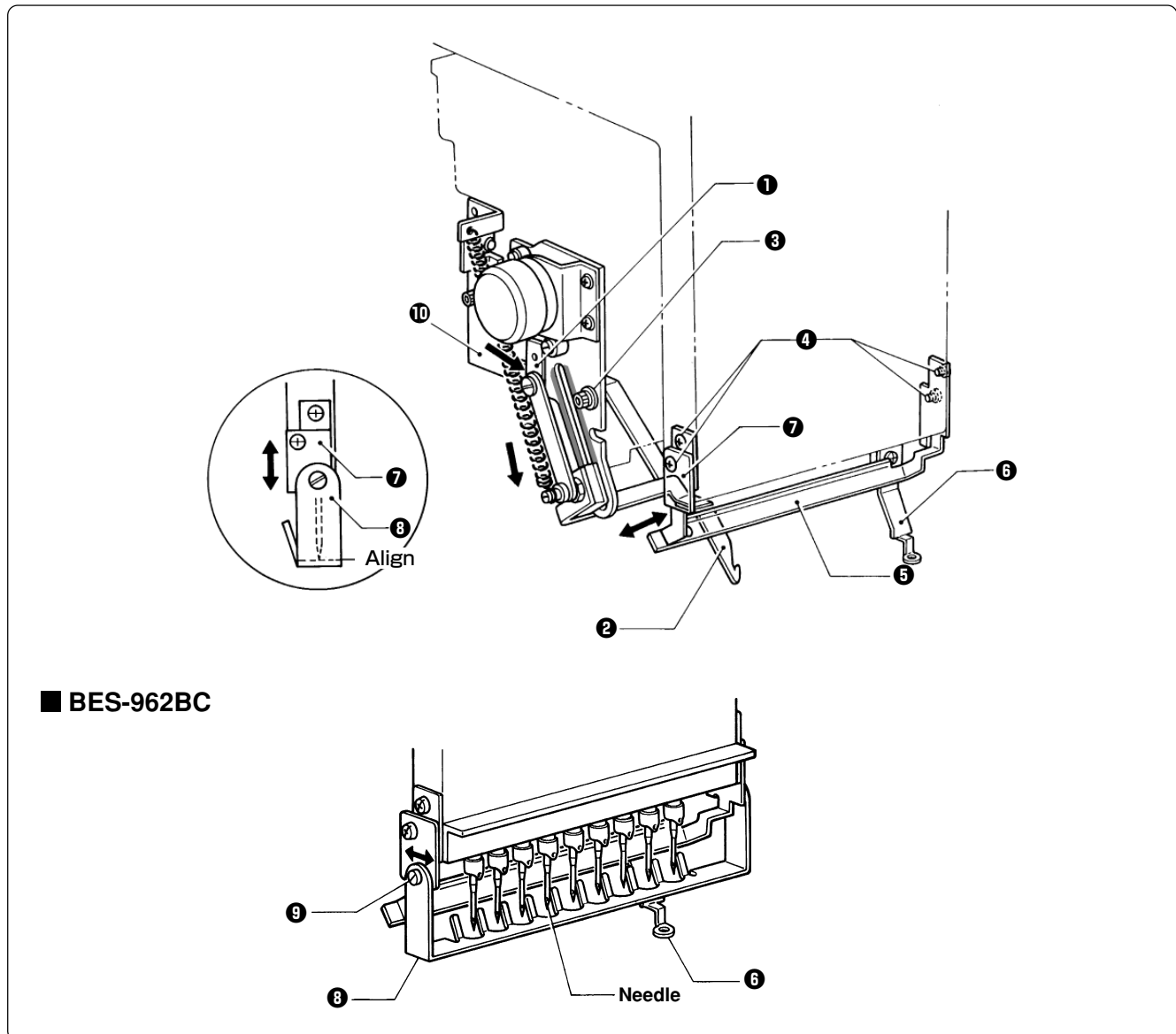

■ BES-962BC

1. Move solenoid arm **①** in the direction of the arrow with your finger. Loosen three bolts **③** and adjust thread hook **②** for smooth movements.
2. If there is a difference in motion between needle bars No. 1 and No. 9 (No. 12 for BES-1262BC), loosen four screws **④** and make an adjustment by moving thread presser base **⑤** in the direction of the arrow.
Make sure that no interference will occur when pressure foot **⑥** is raised by the solenoid.
3. Move finger guard plate **⑦** up and down, and align the top of finger guard **⑧** with the tips of the needles.
4. After the above steps are complete, check thread hook **②** for smooth movements.

If the thread hook does not move smoothly, apply grease (Grease Tank BR2 (black)) to the gray part of thread guide solenoid base **⑩** and check its movements.

- Note)
- Care should be taken if the finger guard is inclined. If the finger guard in such a state is pushed excessively toward the needle at the time of color change, it may interfere with the presser foot.
 - Then make an adjustment in the crosswise direction by sliding bolt **⑨** of finger guard **⑧**.

8. Adjusting the Belt Tension

The belt Tension is adjusted to the optimum tension at the time of shipment from the factory. However, as the belt is used, it becomes run in and may loosen around the machine pulley and motor pulley . Use the following procedure to check the belt tension.

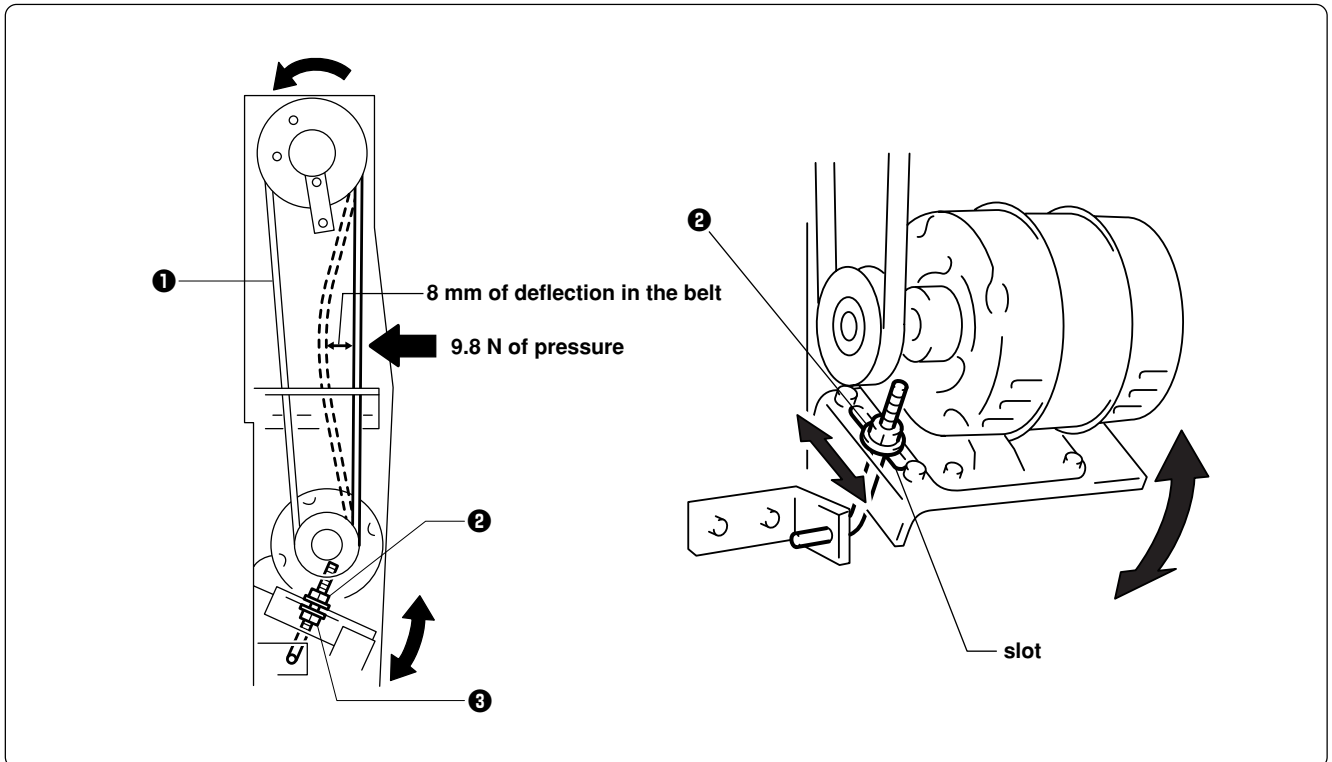













Place a gauge against the belt ①, loosen the nut ②, and then turn the nut ③ to move the slot to the appropriate position so that there is 8 mm of deflection in the belt ① when 9.8 N of pressure is applied.







The machine operating direction is counterclockwise when seen from the machine pulley end.









Chapter 11 Error code list

Code	Error	Measures
E-00	No error occurs.	This is not usually displayed.
E-01	Either motor of main shaft, X- or Y-axis, or lower shaft has locked.	
E-02	Overtravel occurs during home position detecting movement.	Turn the power off and on once. If the same error occurs again, the home position sensor is faulty.
E-03	The stop switch is pressed during home position detecting movement.	Press the  or turn on the F/B switch on the head to either side to restart the home position detecting movement again.
E-04	Zero detecting movement out of range	This is not usually displayed.
E-05	Needle stop position error	Adjust the pulley stop position (100 degrees) above the needle and press the  or turn on the F/B switch on the head to either side.
E-06	Needle bar case position error	This is not usually displayed.
E-07	Needle bar case lock	Press the  or turn on the F/B switch on the head to either side. If the same error occurs again, the color change mechanism is faulty.
E-08	Stop switch or emergency switch was pressed while the needle bar case is traveling.	This is not usually displayed.
E-09	X-axis home position detection error	Turn the power off and on once. If the same error occurs again, the X-axis mechanism is faulty.
E-0A	Thread breaking error	After passing through the thread, press the  or turn on the F/B switch on the head to either side.
E-0B	Stop or emergency stop during sewing	This is not usually displayed.
E-0C	Insufficient bobbin thread	
E-0D	The machine does not return to the home position.	Turn the power off and on once.
E-0E	Mending finish	This is not usually displayed.
E-0F	Undefined error	
E-14	Y-axis home position error	Turn the power off and on once. If the same error occurs again, the Y-axis mechanism is faulty.
E-15	Stop error during SSP processing (when pressing the stop key while the hoop is moving)	Hoop movement restarts if you press  .
E-16	The destination needle bar number given from PC is out of the movable area.	This is not usually displayed.
E-17	The speed Vol. number given from PC is out of the appropriate range.	
E-18	X-axis stepping motor connector error	Turn the power off and on once after checking to see that the connector of the X-axis stepping motor is properly connected.
E-1A	Destination coordinates error	This is not usually displayed.
E-1B	The machine has reached the mending stop position.	
E-1C	The machine stops during mask tracing.	Tracing is cancelled if the  key is pressed when the machine is stopped during mask tracing. Press the  key to continue tracing.
E-1D	The machine stops while the needle is moving between patterns during repeat sewing.	This is displayed when the stop switch is pressed while the hoop is moving. Press the  to move the hoop again. (It is necessary to press the  again to start sewing.)
Errors E-1C and E-1D are not displayed due to mechanical problems.		

Code	Error	Measures
E-1E	When the power is turned on, bed can not be retracted.	This is displayed when every other head control is selected or when the bed is retreated (including when the power is turned on). Remove the presser foot of the retreating head and press the return key or turn the F/B switch of the head to either side. If every other head control is not selected or the bed is not retreated, the bed sensor position may be faulty. Readjust it. Press the  key. If the same error occurs again, adjust it with the presser foot switch.
E-1F	Presser foot down error while searching for home position just after the power is turned on.	Press the  or turn on the F/B switch on the head to either side. If the same error occurs again, adjust the presser foot switch.
E-21	Hoop overhang(+X)	Pattern or the needle position is out of the embroidering area. Reset the embroidering area on PC or move the hoop to the sewable position.
E-22	Hoop overhang(+Y)	
E-23	Hoop overhang(+X, +Y)	
E-24	Hoop overhang(-X)	
E-25	Hoop overhang(+X, -X)	
E-26	Hoop overhang(-X, +Y)	
E-27	Hoop overhang(+X, -X, +Y)	
E-28	Hoop overhang(-Y)	
E-29	Hoop overhang(+X, -Y)	
E-2A	Hoop overhang(+Y, -Y)	
E-2B	Hoop overhang(+X, +Y, -Y)	
E-2C	Hoop overhang(-X, -Y)	
E-2D	Hoop overhang(+X, -X, -Y)	
E-2E	Hoop overhang(-X, +Y, -Y)	
E-2F	Hoop overhang(+X, -X, +Y, -Y)	
E-31	Needle overhang(+X)	
E-32	Needle overhang(+Y)	
E-33	Needle overhang(+X, +Y)	
E-34	Needle overhang(-X)	
E-36	Needle overhang(-X, +Y)	
E-38	Needle overhang(-Y)	
E-39	Needle overhang(+X, -Y)	
E-3C	Needle overhang(-X, -Y)	
E-40	The status of presser foot is issued as an alarm when every second machine is used.	When using the every other head mode, remove the presser feet according to the warning message.
E-41	Invalid start-up error	Turn the power off and on once.
E-42	XY movement error	Press the  or turn on the F/B switch on the head to either side.

Code	Error	Measures
E-43	Slave I/F EEPROM read error	Turn the power off and on once. If the same error occurs again, the main PC is faulty.
E-A1	Spindle motor lock	Press the  or turn on the F/B switch on the head to either side. If it occurs frequently, the main shaft mechanism is faulty.
E-A2	Main PC board temperature too high	This is not usually displayed.
E-A3	Spindle motor voltage too low	
E-A4	Spindle motor voltage too high	
E-A5	Spindle motor CPU error	
E-A6	Spindle motor CPU communication command error	
E-A7	Spindle motor CPU send/receive error	
E-A8	Spindle stop position signal error	Adjust the pulley stop position (100 degrees) above the needle and press the  . If the error occurs frequently, the parts related to the main shaft stop position sensor are faulty.
E-A9	Spindle CPU parameter error	This is not usually displayed.
E-B0	Lower shaft CPU error	
E-B1	Thread tangle in rotary hook	Check to see that no lint is tangled in the rotary hook and press the  or turn on the F/B switch on the head to either side.
E-B2	Hook motor origin point error	
E-B3	Hook motor standby position error	The rotary hook may be rotated forcefully. Press the  or turn on F/B switch on the head to either side to cancel the error. If the same error occurs again, the lower shaft sensor is improperly adjusted.
E-B4	Hook motor motor mode error	This is not usually displayed.
E-B5	Hook motor communication error	
E-B6	Hook motor parameter error	
E-B7	Hook motor overheat error	Turn the power off and on once. If the same error occurs again, the lower shaft motor is faulty.
E-B8	Hook motor overcurrent error	
E-B9	Thread trimming motor zero point error	Turn the power off and check the thread trimmer and turn the power on again. If it occurs again, the thread trimmer is faulty.
E-BA	Power supply frequency error	Turn the power off and on once. If the same error occurs again, the power PCB or power supply is faulty.
E-BC	No power error	It may usually occur momentarily when turning off the machine. If it occurs when the machine is on, it is a power failure detection error.
E-BD	Lower shaft flash memory error	Turn the power off and on once. If the same error occurs again, the main PCB is faulty.
E-BE	Lower shaft version-up error	Press the  or turn on the F/B switch on the head to either side to cancel the error and upgrade the version again.
E-BB, BF	Lower shaft motor undefined error	This is not usually displayed.
E-C1	Area over during embroidering	Set the embroidering area again on PC.
E-C2	Wiper out error	If the wiper is tangled with a thread, remove it. Press the  or turn on the F/B switch on the head to either side.

Code	Error	Measures
E-C3	Embroidering data buffer empty	Is the IF cable disconnected? If it is connected normally, the cable or the main board is faulty.
E-C4	Presser foot down error	Press the  or turn on the F/B switch on the head to either side. If the same error occurs again, adjust the presser foot switch.
E-C5	Measured voltage value could not be received from the lower shaft motor CPU.	This is not usually displayed.
E-C6	Voltage value could not be transferred to the lower shaft motor CPU.	
E-C7	Lower shaft error	The machine may be being tested in the BC test mode. Exit the test mode or turn the power off and on once. If the same error occurs again, the main PCB is faulty.
E-C8	Hook motor origin point error	Check the operation of the main shaft brake and the stop position of the main shaft (100 degrees).
E-C9	Embroidering start error	The  is pressed while no sewing data has been transferred to the embroidery machine. Clear this error by the  . To start sewing, transfer necessary data from the machine controller and press the  .
E-CA	No sewing permission is given from PC.	This is not usually displayed.
E-CB	Spindle rotation speed error	Press the  or turn on the F/B switch on the head to either side to cancel the error and press the  . If the same error occurs again, there is a possibility that the spindle is overloaded.
E-CC	Shuttle thread entanglement automatic reset	This is not usually displayed.
E-CD	Speed command can not be received.	Turn the power off and on once. If the same error occurs again, the main PCB is faulty.
E-CE	Cylinder bed position error	Secure the bed. If the bed is secured, the bed sensor position may be faulty. Readjust it.
E-CF	Rated voltage value could not be received from the lower shaft motor CPU.	Turn the power off and on once. If the same error occurs again, the main PCB is faulty.
E-D0	Power PC board error	Turn the power off and on once. If the same error occurs again, the power PCB is faulty.
E-D1	Cooling fan motor stop B Turn the power off.	Turn off the power and check the fan harness. Turn on the power again. If the same error occurs again, the fan or the power PCB is faulty.
E-D2	Power voltage upper limit error	(1) The voltage setting is improper. -> Set it again.
E-D3	Power voltage lower limit error	(2) Press the  or turn on the F/B switch on the head to either side. If the same error occurs again, the power PCB or the power supply is faulty.
E-E1	X-axis pulse motor overcurrent stop	Turn the power off and on once.
E-E2	Y-axis pulse motor overcurrent stop	
E-E3	Cooling fan motor stop A Press R.	Turn off the power and check the fan harness. Turn on the power again. If the same error occurs again, the fan or the power PCB is faulty.
E-E4	Lower shaft communication error	Turn the power off and on once. If the same error occurs again, the main PCB is faulty.
E-E5	Over-run error during interfacing to main PCB CPU	This is not usually displayed.
E-E6	Framing error during interfacing to main PCB CPU	
E-E7	Parity error during interfacing to main PCB CPU	
E-E8	Receiving time up error during interfacing to main PCB CPU	

Code	Error	Measures
E-E9	Send/Receive inconsistent error during interfacing to main PCB CPU	This is not usually displayed.
E-EA	ACK code receiving error during interfacing to main PCB CPU	
E-EB	Send/Receive ID code error during interfacing to main PCB CPU	
E-EC	Send data checksum error during interfacing to main PCB CPU	
E-ED	Data empty error during interfacing to main PCB CPU	
E-EF	Receiving error on interface	
E-F1	Send time up error	
E-F2	Request-to-waiting time up error	
E-F3	Request-to-recive time up error	
E-F4	Receive command error	
E-F5	NACK code receiving error	
E-F6	Data requested for needle position can not be returned.	
E-F7	It is not receive command for the request one.	
E-F8	PRE code error	
E-F9	No applicable command	
E-FA	Interface receive data sum check error	
E-FB	Send time up error	
E-FF	No status is returned from spindle, lower shaft motor, or CPU.	



Chapter 12 Troubleshooting

If there is any indication of trouble with the machine, check and correct as described in the table. If the trouble cannot be corrected, turn off the power and contact your distributor for corrective actions.

Mechanical Section

	Problem	Check Point
Check these points once again	<ul style="list-style-type: none"> ■ Thread breakage 	<ul style="list-style-type: none"> • Is the machine properly threaded? • Is thread tension too high? • Is the rotary hook assembly clogged? • Is there thread in the bobbin? • Is the needle bent? • Is there a rough edge or flaw on the needle plate, rotary hook, or bobbin case that might cut the thread? • Is the needle installed correctly (direction, angle, etc.) • Is the presser foot in contact with the material? • Are the thread thickness and needle size correct? • Is a thread with right-hand twist being used? (If such a thread is used, replace with a thread with left-hand twist.) • Is there any adhesive on the needle? • Is the material tension too weak? • Is there too much play between the outer rotary hook and inner rotary hook? • Does the outer rotary hook turn smoothly? • Is the clearance between the rotary hook stopper and the rotary hook adjusted correctly? • Does the thread come out from the bobbin case smoothly?
	<ul style="list-style-type: none"> ■ Needle (presser foot) interference with embroidery hoop 	<ul style="list-style-type: none"> • Is the embroidery hoop too small? • Check the size and needle start position in the sewing data.
	<ul style="list-style-type: none"> ■ Needle breakage 	<ul style="list-style-type: none"> • Is the needle attached correctly (direction, height, etc.)? • Is the needle bent? • Is the rotary hook attached correctly? • Is the timing set correctly? • Is there any backlash with the needle bar case (back/forth and right/left)? • Is the rotary hook stopper correctly attached to stop the rotary hook? • Is the needle size correct and the tip sharp? • Does the thread pass through the hole center of the presser foot?
	<ul style="list-style-type: none"> ■ Not embroidered properly 	<ul style="list-style-type: none"> • Is the material edge caught in the machine? (Are embroidery hoop and other related parts operating correctly?) • Is the material stretched properly? • Is thread tension proper? Does the lower thread come out smoothly?
	<ul style="list-style-type: none"> ■ Machine operation abnormal 	<ul style="list-style-type: none"> • Is any set screw of the rotary encoder loosened? • Is any set screw of the machine pulley loosened? • Is any set screw of the machine motor pulley loosened? • Is embroidery data normal? • Is the XY carriage belt loosened?

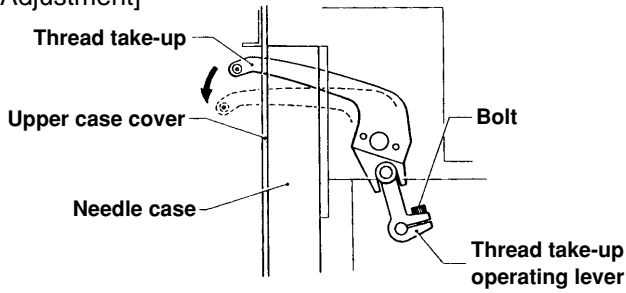
	Problem	Check Point
Check these points once again	<ul style="list-style-type: none"> Machine operation abnormal 	<ul style="list-style-type: none"> Is the XY carriage belt damaged? Are any set screws for the XY pulley loosened? Are any set screws for the coupling of the XY pulse motor loosened?
	<ul style="list-style-type: none"> Upper shaft locks at a certain point in one cycle 	<ul style="list-style-type: none"> Is the thread take-up stopped due to interference with the upper case cover? <p>[Adjustment]</p>  <p>Loosen the hexagon socket head cap screw of the thread take-up operating lever and adjust the take-up movable range. Tighten it securely afterwards.</p> <ul style="list-style-type: none"> Are the needle bar clamp and the top dead center stopper positioned correctly?
	<ul style="list-style-type: none"> Error display 	<ul style="list-style-type: none"> Check the rotary hook of a machine head whose MENDING lamp (green) is blinking to see if the thread is caught. <p>[Adjustment]</p> <ol style="list-style-type: none"> Take out the thread tangled in the rotary hook race so that the rotary hook can be rotated forcibly by manual operation. Check that the machine pulley is set to 100° of the scale, and press the END switch. <p>[Measures]</p> <ol style="list-style-type: none"> If the thread end is left too long or stitching is left loosened before starting embroidering, the thread is caught in the machine and operation stops. When starting embroidering, hook the thread end on the spring or hold it with a hand. Leave thread of about 60 ~ 70 mm from the needle hole when starting embroidering. <ul style="list-style-type: none"> Is thread tangled in the rotary hook? Clean the rotary hook. Conduct BC sensor test of the PC test mode. If there is any failure, replace the lower shaft with a new one. (Refer to "Replacing the Lower Shaft Module".)
	<ul style="list-style-type: none"> Upper shaft pulley does not turn. 	<ul style="list-style-type: none"> Is the presser foot lifted at a retract position when the power is turned on? <p>Lower the presser foot for the six machine heads using the lever.</p>
	<ul style="list-style-type: none"> Stitches cannot be made. 	<ul style="list-style-type: none"> Is the needle attached properly? Is the timing of the needle and rotary hook correct?

Electrical Section

Cautions

- Be sure to turn off the power of the machine and unplug the power cord before checking cable connections.
- When you check connection of the cables as instructed in this manual, also check connection and continuity between connectors.
- Carry out items described in the "Measures" section in order of appearance.
- Some checks and replacement works can be conducted only by repair people. In such cases, contact your dealer.

Symptom	Measures
The machine does not operate even if the power is turned on.	<ul style="list-style-type: none"> • Is the power cord of the machine plugged in? → Plug in the power cord. • Is the connector at the rear of the control box connected? → Connect it after checking the connector number and the harness number. • Is the connector in the control box or the power supply base connected? → Connect it after checking the types and colors of the connectors. • Is fuse F1 or F2 on the power PCB in the power supply base blown? → Replace the fuse with a new one. If the fuse is blown again, something is faulty. Check to see if the wiring is correct. Replace the control box with a new one.
The machine does not operate even if the power is turned on. The message, "Release stop SW to operate!", is displayed on the panel.	<ul style="list-style-type: none"> • Is the stop switch turned on? → Reset the stop switch.
<ul style="list-style-type: none"> • The message, "Is the presser foot removed?", is displayed on the machine controller when the power is turned on. • The red LED of head 2 or 4 or 6 does not light and the presser foot remains lowered. 	<ul style="list-style-type: none"> • Is the retract bed sensor adjusted properly? → Adjust the retract bed sensor of the faulty head. (Refer to "Replacing the retract bed sensor PCB".) • Refer to the block diagram showing cable connection and check connection from the retreat bed sensor to the main PCB. • Check to see if the frame type is set to every other head with the machine controller.
An overtravel error occurs.	<ul style="list-style-type: none"> • Is the frame within the cap frame area? → Move the frame within the cap frame area and turn on the power. • Check to see if the signal of the X area sensor turns ON and OFF in PORT test mode. → When the signal does not change, refer to the block diagram showing the cable connections and check to see if connection from the X area sensor to the main PCB is proper. Replace the X area sensor with a new one.
The needle stop position error occurs.	<ul style="list-style-type: none"> • Is the pulley manually turned and out of the stop angle? → Turn the pulley, adjust the needle at the stop position, and reset the error. • Check the signal of the stop position sensor in the encoder test mode. → Refer to the adjustment or cable connection block diagram and check connection from the needle position detention sensor to the main PCB. Replace the needle position detection sensor with a new one.

Symptom	Measures
The needle stop position error occurs.	<ul style="list-style-type: none"> • Is the main shaft brake solenoid operating? → If not, refer to the block diagram showing the cable connections and check to see if the connections from the brake solenoid to the power PCB and from connector P27 of the power PCB to connector P1 of the main PCB are proper. • Check the resistance value of the main shaft brake solenoid at the connector section of the solenoid. The normal resistance value is approximately 50Ω. → If it is not normal, replace the solenoid with a new one. In this case, the power PCB in the control box may also be faulty. Replace it with a new one if it does not operate properly even after a new solenoid is installed. • Are there any problems with the main shaft mechanism? (i.e., The screw of the main shaft pulley is loose.)
The needle bar case lock error occurs.	<ul style="list-style-type: none"> • Is the INDEX motor rotating? → If not, refer to the block diagram showing the cable connections and check to see if connection from the INDEX motor to the main PCB is proper. Check the resistance values of pins 1 and 2 and pins 3 and 4 at the connector section of the INDEX motor. The normal resistance value is approximately 4.4Ω. → If it is not normal, replace the INDEX motor with a new one. Also replace the main PCB with a new one. • Manually turn the color change pulley. → If it is abnormally heavy, adjust the color change mechanism and the needle cap case. • Start the machine after invalidating its initial setting and operate the head solenoid in solenoid test mode. → If a certain head and the heads following it do not operate, refer to the block diagram showing the cable connections and check to see if connection of the head communication sign is proper. • Only head 1 does not operate. → Check the communication line to head 1 and connection of the power harness for head 1. • Do the rotary switch settings of each head PCB correspond with the numbers of each head? → If not, set them according to the head numbers. • Start the machine after invalidating its initial setting and enter the CASE test mode. Do figures on the panel change when the color change pulley is manually turned? → If not, check to see if connection from the needle bar position sensor to connector P7 of the head PCB (1) is proper. • Replace the needle bar position sensor (potentiometer) with a new one. • Replace the head PCB 1 with a new one.

Symptom	Measures
X-axis or Y-axis home position detection error occurs.	<ul style="list-style-type: none"> • Was the XY carriage moving? → If so, refer to the block diagram showing the cable connections and check to see if connection from the X and Y area sensor to the main PCB is proper. • Was the XY motor rotating? → If so, check the XY carriage mechanism. • If the XY motor is not rotating, refer to the cable connection block diagram and check to see if connection from the XY motor to the main PCB is proper.
The thread breakage error frequently occurs although thread is not broken.	<ul style="list-style-type: none"> • Enter the CASE test mode and turn the thread breakage sensor pulley corresponding to each needle bar of the head with which this error occurs while switching the needle bar from number 1 in ascending order and check to see that the red LED on the head blinks. → If there is no problem, lower the thread breakage sensitivity value of the machine controller. (The standard value is 0.) • Check connection from the thread breakage sensor PCB to the head PCB if it does not blink. • Replace the thread breakage sensor PCB with a new one.
The X-axis motor connector connection error occurs.	<ul style="list-style-type: none"> • Refer to the block diagram showing the cable connections and check the connection from the two X motors on the left and right to the main PCB.
The main shaft motor lock error occurs.	<ul style="list-style-type: none"> • Enter the encoder signal mode and manually turn the main shaft pulley. → If it is abnormally heavy, the main shaft mechanism is faulty. • Does the main shaft motor rotate at all when the error occurs? → If it does not rotate at all, check fuse F5 on the power supply PCB in the control box. Refer to the block diagram showing the cable connections and check to see if connection from the main shaft motor to the main PCB is proper. Also check connection of connectors P6 and P4 of the main PCB and connectors P19 and P12 on the power PCB in the box, and connection from connector P11 of the power supply PCB to the 14v terminal of the power transformer. • Manually turn the main shaft pulley in the encoder signal test mode and check to see if the stop position signal and encoder signal are proper. → If either of the signals does not change, refer to the block diagram showing the cable connections and check to see if connection from the encoder and stop position sensor to the main PCB is proper.
ERROR A7 occurs.	<ul style="list-style-type: none"> • Check the CPU ROM version for the upper shaft. → If it is version A, replace it with the latest ROM of version B or later. (PROM#4 on the main PCB)
ERROR A8 frequently occurs.	<ul style="list-style-type: none"> • In the encoder signal test mode, manually turn the main shaft pulley and check to see that the stop position signal is correct. → If the signal does not change, refer to the cable connection block diagram and check to see if connection from the stop position sensor to the main PCB is proper.

Symptom	Measures
Thread is frequently tangled in the rotary hook.	<ul style="list-style-type: none"> • Is thread tangled in the rotary hook? → Clean the rotary hook. • Conduct BC sensor test of the test mode. → If there is any failure, replace the lower shaft module with a new one. • Conduct automatic out-of-step limit measurement of BC automatic test in the test mode. → Replace the lower shaft module with a new one if there is any fault. • Check to see if the lower shaft fan of the head with which the error frequently occurs is correctly rotating. → If the fan is at standstill, check to see if connection from the lower shaft fan to the BC PCB is proper. Replace the lower shaft fan with a new one. • If all the lower shaft fans are at standstill, check fuse F4 on the power supply PCB in the control box. • Is the hole next to the bed with which the error frequently occurs clogged with dust? → If so, clean it.
The lower shaft motor zero point error occurs.	<ul style="list-style-type: none"> • Is thread tangled in the rotary hook? → Clean the rotary hook. • Is the lower shaft with which the error occurs rotating? → If so, check to see if connection from the lower shaft sensor PCB to the BC PCB is proper. Adjust the lower shaft sensor. Replace the lower shaft sensor PCB with a new one. • If the lower shaft with which the error occurs is not rotating, check to see if connection from the lower shaft motor to the BC PCB is proper. Replace the lower shaft module with a new one. Replace the BC PCB with a new one.
The lower shaft motor standby position error occurs.	<ul style="list-style-type: none"> • Is the rotary hook rotated manually? → This is not a fault. • Check to see if connection from the lower shaft sensor PCB to the BC PCB is proper. Replace the lower shaft module with a new one.
The lower shaft overheat error occurs.	<ul style="list-style-type: none"> • Check to see if the lower shaft fan is normally rotating. If the fan is at standstill, check to see if connection from the lower shaft fan to the BC PCB is proper. Replace the lower shaft fan with a new one. • If all the lower shaft fans are at standstill, check fuse F4 on the power supply PCB in the control box. • Is the hole next to the bed with which the error frequently occurs clogged with dust? → If so, clean it. • Check to see if connection from the thermister of the lower shaft module to the BC PCB is proper.

Symptom	Measures
Lower shaft motor overcurrent error occurs.	<ul style="list-style-type: none"> • Is the red LED for the BC PCB off? → If not, refer to the block diagram showing the cable connections and check to see if the connection from the BC PCB to the main PCB is proper. • Check to see if connection from the lower shaft motor to the BC PCB of the bed on BC PCB whose red LED is off is proper. → Replace the harness or the lower shaft module if a short circuit occurs due to line insertion. • Measure the resistance values of pin 1 and pin 2, pin 2 and pin 3, pin 3 and pin 4, pin 4 and pin 5, and pin 5 and pin 1 at the connector of the lower shaft motor with the tester and check to see if they are approximately 2.6Ω. → Replace the faulty lower shaft module with a new one. • Replace the BC PCB with a new one.
Thread trimming motor zero point error occurs.	<ul style="list-style-type: none"> • Is lint clogged between the travelling blades? → Remove it. • Is the thread trimming motor operating? → If so, refer to the block diagram showing the cable connections and check to see if connection from the thread breakage sensor to the main PCB is proper. Also adjust the thread breakage sensor PCB. (Refer to "Replacing thread breakage sensor PCB.") • If it is not operating, refer to the block diagram showing the cable connections and check to see if connection from the thread trimming motor to the main PCB is proper. • Check to see if connection from connector P3 of the main PCB to connector P9 of the power supply PCB in the control box is proper. • Check fuse F6 on the power supply PCB in the control box. → If it is blown, replace it with a new one. If it is blown again, replace the power supply PCB.
Power frequency error occurs.	<ul style="list-style-type: none"> • Check to see if connection from connector P16 of the main PCB to connector P10 of the power supply PCB in the control box is proper. • Refer to the block diagram showing the cable connection and check to see if connection from connector P26 of the power PCB in the control box to connector P7 of the power supply PCB in the power supply base is proper. • Check fuse F3 on the power supply PCB in the power supply base. → If it is blown, replace it with a new one. If it is blown again, there is a fault somewhere in the 24v system circuit.
Wiper out error occurs.	<ul style="list-style-type: none"> • Does the wiper on the error head remain projected? → If the wiper is tangled with a thread, remove it. If the wiper does not return smoothly, adjust it. • Enter the solenoid test mode and operate the wiper solenoid. Check the icon on the panel. → If a sensor signal is not given, check to see if connection from the wiper sensor to the head PCB is proper. Replace the wiper sensor with a new one. Replace the head PCB with a new one.

Symptom	Measures
Presser foot down error occurs.	<ul style="list-style-type: none"> • Is the presser foot attached? → If not, attach it. • Does it rise and drop immediately? → If so, adjust the presser foot sensor. • Does the presser foot rise and make some noise for a while? → If so, check to see if connection from the presser foot sensor to the head PCB is proper. Replace the presser foot sensor with a new one. Replace the head PCB with a new one. • Does the presser foot move? If it does not move at all, check to see if connection from the presser foot motor to the head PCB is proper. Replace the presser foot motor with a new one. Replace the head PCB with a new one.
ERROR C7 occurs.	<ul style="list-style-type: none"> • Is the lower shaft being tested in the test mode? → If so, refer to the operation method of the test mode and exit the test mode or turn the power off once and on again. • Turn the power off once and on again. If the same error occurs again, replace the main PCB with a new one.
Main shaft rotation speed error occurs.	<ul style="list-style-type: none"> • Enter the encoder signal test mode and manually turn the main shaft pulley. → If it is abnormally heavy, the main shaft mechanism is faulty. • Refer to the block diagram showing the cable connections and check to see if connection from the main shaft motor to the main PCB is proper. Also check the connection from connectors P6 and P4 of the main PCB to connectors P19 and P12 of the power supply PCB in the box and the connection from connector P11 of the power PCB to the 14v terminal of the power transformer.
Cylinder bed position error occurs.	<ul style="list-style-type: none"> • The bed retract sensor is not adjusted properly. Adjust it properly.
Power PCB error occurs.	<ul style="list-style-type: none"> • Check to see if connection from connector P16 of the main PCB to connector P10 of the power supply PCB in the control box is proper. • Refer to the block diagram showing the cable connections and check to see if connection from connector P4 of the BC PCB to the power supply PCB in the control box, and connection from connector P9 of the main PCB to connector P3 of the power supply PCB in the control box are proper. • Replace the power supply PCB with a new one. • Replace the main PCB with a new one.
Cooling fan motor stops. Exhaust fan motor stops. When all three fans in the control box stop	<ul style="list-style-type: none"> • Refer to the block diagram showing the cable connections and check to see if connection from connector P5 of the power PCB in the control box to connector P1 of the power supply PCB in the power supply base, and connection from connector P4 of the power supply PCB in the power supply base to the 18v terminal of the power transformer are proper. • Check fuse F3 on the power supply PCB in the power supply base. → If it is blown, replace it with a new one. If it becomes blown again, the 24v system circuit is faulty.

Symptom	Measures
Only cooling fan motor stops.	<ul style="list-style-type: none"> • Check to see if the cooling fans on the left of the main PCB and inward of the power supply PCB are rotating. → If either of them is at standstill, check to see if connection from the cooling fan which is at standstill to P20 or P25 of the power supply PCB in the control box is proper. If they are connected properly, replace the cooling fan which is at standstill. • Both cooling fans are rotating. → Check to see if connection from connector P16 of the main PCB to connector P10 of the power supply PCB in the control box is proper. Replace the main PCB with a new one. • Check to see if the cooling fan on the right side of the main PCB is rotating. → If it is at standstill, check to see if connection from the cooling fan to P12 of the main PCB is proper. If they are connected properly, replace the faulty cooling fan. • The cooling fan is rotating. → Replace the main PCB with a new one.
Power voltage upper or lower limit error occurs.	<ul style="list-style-type: none"> • Is the voltage set on the panel? → If not, set it according to the power supply voltage of the area where the machine is used. • Is the tap voltage of the power transformer (terminal connection of mark tube T) adjusted to the power voltage of the area where the machine is used? → If not, switch the tap connection. • Check the input voltage values in the power/voltage check test mode. Measure the power supply voltage with the tester and compare them. → If the voltage value is significantly out of the normal range ($\pm 5\text{v}$ or more), calibrate it with the voltage calibration in the test mode. • When you cannot enter the test mode because this error frequently occurs, set the voltage to a relatively high value with the machine controller if it is E-D2 and to a relatively low value if it is E-D3 to avoid errors. Check and calibrate the voltage in the test mode. • Check to see if connection from connector P16 of the main PCB to connector P10 of the power supply PCB in the control box is proper. • Is the power supply abnormally low because a machine with a large capacity (compressor and the like) is used? → Change the power to the other system. Use a stabilizer. • Replace the power PCB with a new one. Replace the main PCB with a new one.
X-axis motor overcurrent stop occurs.	<ul style="list-style-type: none"> • Measure the resistance values of pin 1 and pin 2, pin 2 and pin 3, pin 3 and pin 4, pin 4 and pin 5, and pin 5 and pin1 at each connector section of two X-axis motors with the tester and check to see if they are approximately 2.1Ω. → Replace the faulty motor with a new one. • Refer to the block diagram showing the cable connection and check to see if connection from the X-axis motor to the main PCB is proper. • Replace the main PCB with a new one.

Symptom	Measures
Y-axis motor overcurrent stop occurs.	<ul style="list-style-type: none"> • Measure the resistance values of pin 1 and pin 2, pin 2 and pin 3, pin 3 and pin 4, pin 4 and pin 5, and pin 5 and pin 1 at each connector section of the Y-axis motor with the tester and check to see if they are approximately 2.4Ω. → Replace the faulty motor with a new one. • Refer to the block diagram showing the cable connection and check to see if connection from the Y-axis motor to the main PCB is proper. • Replace the main PCB with a new one.
The following errors frequently occur. <ul style="list-style-type: none"> • Lower shaft memory error • ERROR E5 to ERROR FF 	<ul style="list-style-type: none"> • Replace the main PCB with a new one.
Only a certain head does not operate.	<ul style="list-style-type: none"> • Is the head out of action with either the head switch or the machine controller? • Refer to the block diagram showing cable connections and check to see that other cables are connected to the head switch PCB and the head PCB and the head PCB properly.
Jump solenoids and wiper solenoids of all heads do not operate.	<ul style="list-style-type: none"> • Refer to the block diagram showing cable connections and check to see if connection from connector P4 of the power supply PCB in the control box to connector P6 of the power supply PCB in the power supply base, and connection from connector P5 of the power supply PCB in the power supply base to the 39 terminal of the power transformer are proper. • Check fuse F4 on the power supply PCB in the power supply base. → If it is blown, replace it with a new one. The 50v circuit is faulty if the fuse is blown immediately after turning on the power even after replacing the fuse.
Jump solenoid does not operate.	<ul style="list-style-type: none"> • Check to see if connection from the jump solenoid to connector P10 of the head PCB is proper. • Check the resistance value of the jump solenoid which does not operate with the connector section. The normal resistance value is approximately 56Ω. → If it is faulty, replace the solenoid with a new one. In this case, the head PCB may also be faulty. Also replace the head PCB with a new one if it does not operate properly even after replacing the solenoid. • Refer to the block diagram showing the cable connections and check to see if connection from connector P12 of the head PCB to connectors P7, 8, 13, 14, 15, and 16 on the power supply PCB in the control box is proper. • Replace the head PCB with a new one.

Symptom	Measures
Wiper solenoid does not operate.	<ul style="list-style-type: none"> • Check to see if connection from the wiper solenoid to connector P11 of the head PCB is proper. • Check the resistance value of the wiper solenoid which does not operate with the connector section. The normal resistance value is approximately 28Ω. → If it is faulty, replace the solenoid with a new one. In this case, the head PCB may also be faulty. Also replace the head PCB with a new one if it does not operate properly even after replacing the solenoid. • Refer to the block diagram showing the cable connections and check to see if connection from connector P12 of the head PCB to connectors P7, 8, 13, 14, 15, and 16 on the power supply PCB in the control box is proper. • Replace the head PCB with a new one.
The lower shaft PCB is faulty.	<ol style="list-style-type: none"> 1. Turn off the power of the machine. 2. Disconnect P4 and P10 of the lower shaft PCB. If the lower shaft PCB is removed from the machine or P8 or P9 is disconnected, the lower shaft connected to other lower shaft PCB will not operate, either. 3. Turn on the power of the machine. The E-B2 error occurs and the green LED blinks with the head corresponding to the faulty lower shaft. Turn off the pause switch of the head (flip it down) and keep flipping up the mending switch until the green LED stops blinking. 4. If there is just one lower shaft PCB, reset the LEDs of the two heads and reset the error with the STOP key on the panel or the step back key of the head.
The lower shaft module is faulty.	<ol style="list-style-type: none"> 1. Turn off the power of the machine. 2. Disconnect P1, P3, and P5 (for a fixed bed) or P2, P4, and P6 (for a retract bed) connected to the lower shaft PCB from the faulty lower shaft module. 3. Turn on the power of the machine. The E-B2 error occurs and the green LED blinks for the bed corresponding to the faulty lower shaft. Turn off the pause switch of the head (flip it down) and keep flipping up the mending switch until the green LED stops blinking. 4. When the LED of the corresponding head stops blinking, reset the error with the STOP key on the panel or the step back key of the head.
<p>Note:</p> <p>The above operation will prohibit operation of the lower shaft connected to the faulty lower shaft PCB or the faulty lower shaft module and cause the corresponding heads to pause. This is reset when the power of the machine is turned on again. Start from the step 3 to prohibit the operation again.</p>	

Personal Computer Section

	Trouble	Check Point
Check these points once again	<ul style="list-style-type: none"> ■ The power lamp does not light up when the computer power switch is turned on. 	<ul style="list-style-type: none"> • Is the cable correctly plugged in the computer? • Is the AC line live?
	<ul style="list-style-type: none"> ■ The display does not light up when the computer power switch is turned on. 	<ul style="list-style-type: none"> • Is the display power lamp on? • Is the display's cable correctly connected? • Is the display's contrast correctly adjusted?
	<ul style="list-style-type: none"> ■ "Windows" cannot be started. 	<ul style="list-style-type: none"> • Is a floppy disk inserted?
	<ul style="list-style-type: none"> ■ "Windows" can be started but the embroidery software cannot. 	<ul style="list-style-type: none"> • Is the selection of other icons possible? • Is the selected icon correct? • Can you double-click more quickly?
	<ul style="list-style-type: none"> ■ The window does not open though the machine power is turned on? 	<ul style="list-style-type: none"> • Is the cable to the machine and the interface board correctly connected? • Is the interface board attached properly? (Refer to Page 39.) • Is the correct COM port selected? (Refer to Page 131.)
	<ul style="list-style-type: none"> ■ The screen changes when the mouse is not operated for a while. 	<ul style="list-style-type: none"> • The screen saver is preset. Invalidate this function on the control panel screen. Do not validate the power-saving function.
	<ul style="list-style-type: none"> ■ The screen of the editor, the explorer or the production report disappears during operation. 	<ul style="list-style-type: none"> • The machine controller screen was clicked so that the current screen is hidden behind it. Move the mouse to the bottom of the screen and select the program (editor, explorer, or production report).
	<ul style="list-style-type: none"> ■ Colors set for a design and threads are not available. 	<ul style="list-style-type: none"> • The number of colors is set to 256. Increase the number to 65000 or more on the control panel screen.



Connection and Installation of Optional Equipment

Attaching Bobbin Winder

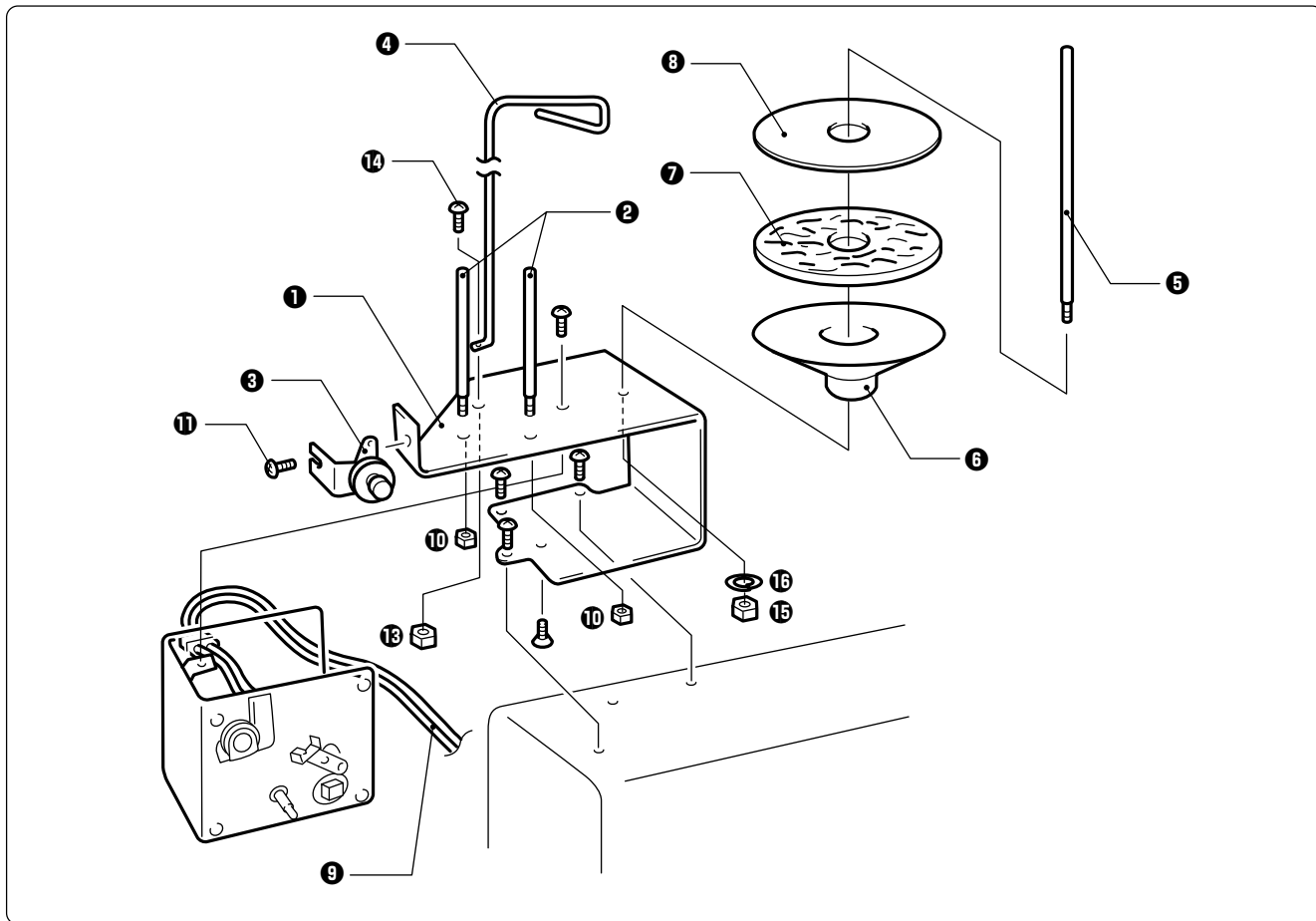

1. Mount two pieces of bobbin stand L **2** on the thread winder stay **1** with nut 4 **10**.
2. Mount the thread winder assembly (set) **3** on the thread winder stay **1** with the tightening screw **11**.
3. Mount the thread guide **4** with the drilling bolt set 6 x 20 **14** and nut 6 **16**.
4. Mount the spool shaft B **5** and pan **6**, spool mat **7**, and spool cushion **8** with nut 5 **15** and spring washer **16**.
5. Insert the thread winder harness **9** in the 2P (No. 6) connectors on the rear of the control box.

■ Winding lower thread

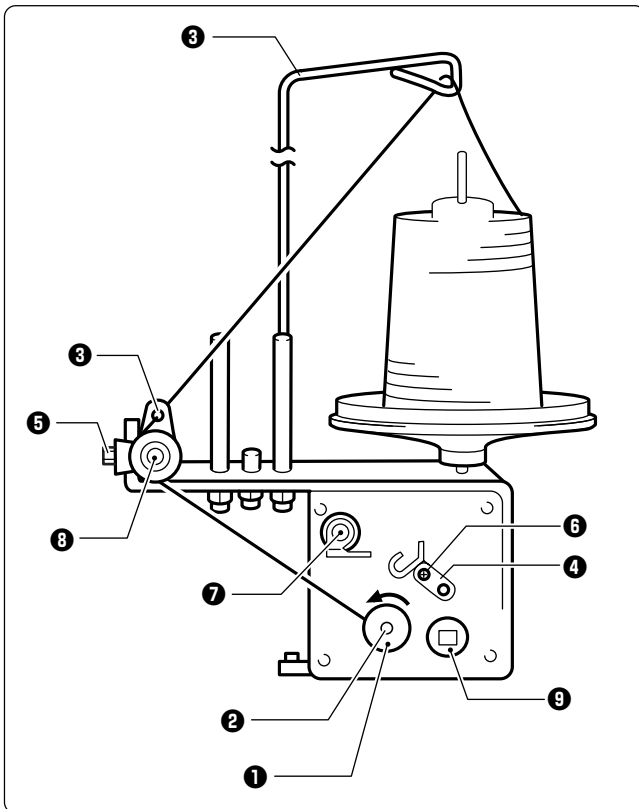

1. Turn the power switch on.
2. Set the bobbin ① in the bobbin winder shaft ②.
3. Put the thread through the thread guide ③.
4. Wind the thread around the bobbin ① several times in the direction of the arrow.
5. Press the bobbin hold ④.

Note) If the thread cannot be wound evenly, loosen the screw ⑤ and move the thread guide ③ right and left for adjustment.

In order to wind more threads around the bobbin, loosen the thread ⑥ and move the bobbin hold ④.

6. After winding is finished, pull out the bobbin from the bobbin winder shaft and trim the thread using the thread trimmer ⑦.

Note) • If the thread is wound too tight and comes off from the tension disk, loosen the knob ⑧. If the thread is too loose, tighten the knob ⑧.

- If the circuit protector ⑨ functions, the bobbin winder motor does not rotate. Leave it for a while for cooling. Then press the circuit protector ⑨. (The thread does not come out when the motor is not cooled enough.)

brother[®]

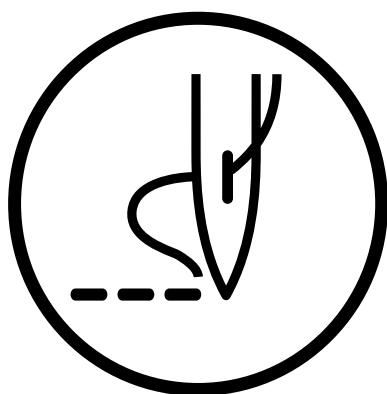

INSTRUCTION MANUAL

BROTHER INDUSTRIES,LTD. NAGOYA,JAPAN

Printed in Japan

155-962,C62
S93962-002
2000.03.H(1)

Free Manuals Download Website

<http://myh66.com>

<http://usermanuals.us>

<http://www.somanuals.com>

<http://www.4manuals.cc>

<http://www.manual-lib.com>

<http://www.404manual.com>

<http://www.luxmanual.com>

<http://aubethermostatmanual.com>

Golf course search by state

<http://golfingnear.com>

Email search by domain

<http://emailbydomain.com>

Auto manuals search

<http://auto.somanuals.com>

TV manuals search

<http://tv.somanuals.com>