

brother®

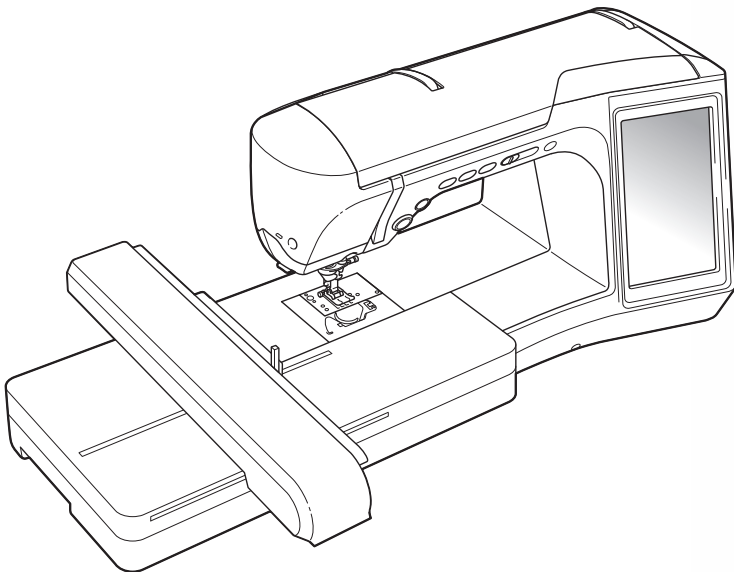

Upgrade KIT I Operation Manual

Before using this upgrade kit, be sure to read this Operation Manual for information on its correct use.



CONTENTS

BEFORE YOU START.....	2
NEW FEATURES.....	2
Chapter 1 How to Create Bobbin Work.....	3
ABOUT BOBBIN WORK.....	4
PREPARING FOR BOBBIN WORK.....	5
Required Materials.....	5
Upper Threading.....	6
Preparing the Bobbin Thread.....	6
CREATING BOBBIN WORK (SEWING).....	10
Positioning the Fabric and Sewing.....	10
Bobbin Work Free Motion Sewing.....	12
CREATING BOBBIN WORK (EMBROIDERY).....	13
Selecting the Pattern.....	13
Start Embroidering.....	14
ADJUSTING THE THREAD TENSION.....	17
TROUBLESHOOTING.....	18
Chapter 2 New Features and New Patterns.....	19
HOW TO USE NEW FEATURES.....	20
Displaying the Fabric While Aligning the Embroidery Position.....	20
CHANGING THE PATTERN SIZE WHILE MAINTAINING THE DESIRED THREAD DENSITY (STITCH RECALCULATOR).....	23
NEW PATTERNS.....	25
Thumbnail List.....	25
Embroidery Patterns Color Change Table.....	26

Before using this upgrade kit, be sure to read this Operation Manual for information on its correct use.

BEFORE YOU START

It is important to perform the upgrade according to the procedure outlined in the Installation Guide. The machine can then be used as outlined in this upgrade Operation Manual. Additional new machine features and instructions are located in the New Features of Version 2 guide.

NEW FEATURES

The following features will be activated with the upgrade for Kit I.

- The bobbin case (gray) and bobbin cover (for bobbin work) are included, allowing you to embroider the added bobbin work embroidery patterns or sew using decorative thread or ribbon too thick to flow freely through the needle. (page 5)
- Positioning of the embroidery pattern can be aligned while displaying the fabric being used in the LCD screen. Embroidery can easily be positioned. (page 20)
- Embroidery patterns can be enlarged or reduced while maintaining their thread density. (page 23)
- Embroidering patterns for bobbin work have been added so bobbin work can immediately be sewn. (page 25)
- One cursive font of character patterns has been added to increase your embroidering enjoyment. (page 25)



Chapter ***1***

How to Create Bobbin Work

ABOUT BOBBIN WORK

You can create embroidery, which gives a three-dimensional appearance to the surface of the fabric, by winding the bobbin with heavy weight thread or ribbon too thick to be fed through the sewing machine needle and sewing on the wrong side of the fabric.

Bobbin work is sewn using the special bobbin case (gray) and bobbin cover with tabs included with Kit I.

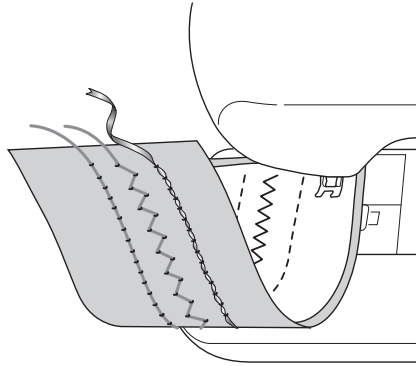

1. Utility stitches

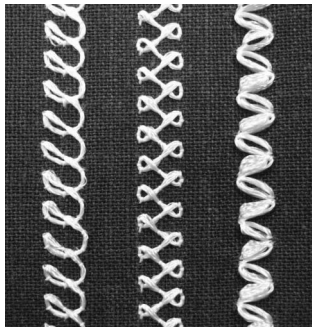

2. Decorative stitches



3. Free motion sewing

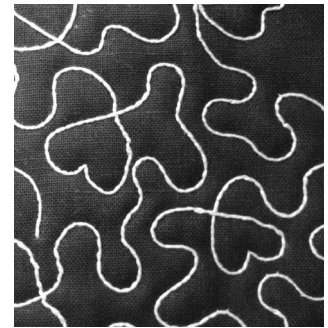

Bobbin work embroidery is sewn using the bobbin work patterns included with this product in addition to some of the utility stitches.

PREPARING FOR BOBBIN WORK

Required Materials

■ Bobbin case and bobbin cover

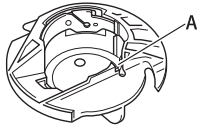

- ① Bobbin case (gray)
There is a notch at the location marked by "A".

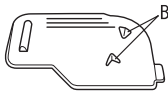

- ② Bobbin cover with tabs (for bobbin work)
There are ribs "B" on the back of the bobbin cover.
The ribs press down on the bobbin so it is not lifted out when thick thread is being fed from it.

■ Lower thread

We recommend the following types of threads for bobbin work.

<Sewing/Embroidery>



No.5 or finer hand embroidery thread or decorative thread



Flexible woven ribbon
(When embroidering: approx. 2mm (approx. 5/64 inch) recommended)

<Sewing only>



Fine embroidery ribbon (silk or silk-like material) (3.5 mm (approx. 1/8 inch) or less, recommended)

* If ribbon is to be used, we recommend that tension not be applied. Refer to page 8 for more detailed instructions.



Note

- Do not use thread heavier than No.5 hand embroidery thread.
- Some threads may not be appropriate for bobbin work. Be sure to sew trial stitches before sewing on your project.

■ Upper thread

Sewing machine embroidery thread (polyester thread) or monofilament (transparent nylon) thread.
If you do not wish for the upper thread to be visible, we recommend using transparent nylon monofilament thread or polyester light weight thread (50wt. or above) that is the same color as the lower thread.

■ Needle

Use a needle appropriate for the upper thread and fabric being used. Refer to "Fabric/Thread/Needle Combinations" (in the chapter "CHANGING THE NEEDLE") and "Embroidery Step by Step" in the machine's Operation Manual.

■ Presser foot

Utility stitches or decorative stitches: Monogramming foot "N"



Free motion sewing: Free motion quilting foot "C", Free motion open toe quilting foot "O" or Free motion echo quilting foot "E"

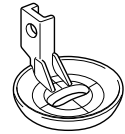
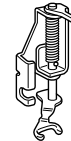

Embroidery: Embroidery foot "W"

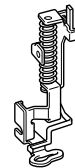

■ Fabric

Be sure to sew trial stitches on a piece of scrap fabric, which includes the same threads and fabric as what is being used in your project.



Note

- The sewing results may be affected by the type of fabric used. Before sewing your project, be sure to sew trial stitches on a piece of scrap fabric that is the same as the fabric used in the project.

Upper Threading

- 1 **Install a needle appropriate for the upper thread and fabric to be used.**

For details on installing the needle, refer to "CHANGING THE NEEDLE" in the machine's Operation Manual.

- 2 **Attach the presser foot.**

For details on attaching the presser foot, refer to the following topics in the machine's Operation Manual.

- CHANGING THE PRESSER FOOT
- Using Free motion Quilting Foot "C"
- Using free motion Open Toe Quilting Foot "O"
- Echo Quilting Using the Free Motion Echo Quilting Foot "E"
- Attaching Embroidery Foot "W"

- 3 **Thread the machine with the upper thread.**

For details on threading the machine, refer to "Upper Threading" in the machine's Operation Manual.

Preparing the Bobbin Thread

In order to create bobbin work, the bobbin case must be replaced with the one for bobbin work. Before creating bobbin work, clean the bobbin case and the race.

- 1 **Raise the needle and presser foot, and then turn off the machine.**
- 2 **Remove the flat bed attachment or embroidery unit.**
- 3 **Grasp both sides of the needle plate cover, and then slide it toward you to remove it.**

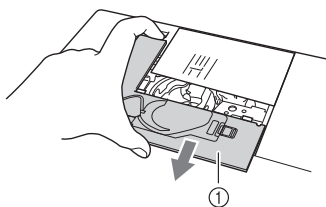

① Needle plate cover

- 4 **Remove the bobbin case.**

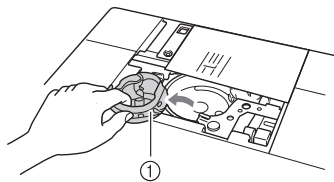

① Bobbin case

- 5 **Use the cleaning brush included with the machine or a vacuum cleaner to remove any lint and dust from the race and its surrounding area.**

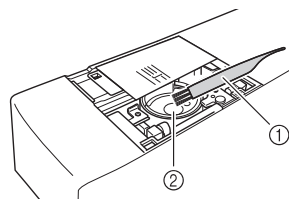

① Cleaning brush
② Race

- 6 **Wipe the bobbin case (gray) with a soft lint free cloth to clean it.**

- 7 **Insert the bobbin case so that the projection on the bobbin case aligns with the spring.**

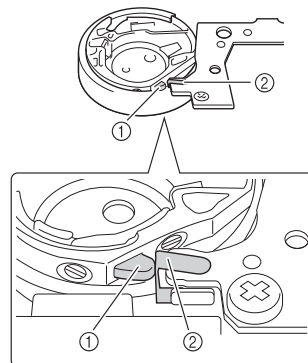
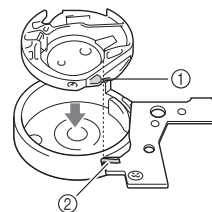

① Projection
② Spring

Note

- The bobbin case (gray) cannot be used for sewing in any way other than bobbin work. After sewing bobbin work, refer back to the steps in "Preparing the Bobbin Thread" on page 6 for removing and cleaning the bobbin case (gray), and then reinstall the standard bobbin case (black).

CAUTION

- Be sure to use the bobbin case (gray) when creating bobbin work. Using any other bobbin case may result in the thread becoming tangled or damage to the machine.
- Make sure that the bobbin case is correctly installed. If the bobbin case is incorrectly installed, the thread may become tangled or the machine may be damaged.

- 8** Wind a decorative thread around the bobbin by hand. After winding the bobbin so it is filled as shown below (about 80%), cut the thread.



For precautions on winding the bobbin for embroidering, refer to step ② of "Selecting the Pattern" on page 13.

CAUTION

- Be sure to use the machine's included bobbin or one designed specifically for this machine. Using any other bobbin may result in damage or injuries.

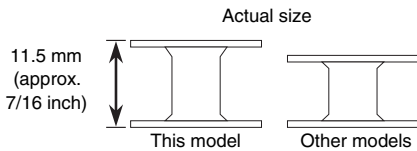

Note

- Slowly and evenly wind the thread around the bobbin.
- For best results, wind the bobbin so the thread is snug and not twisted.

- 9** Using scissors carefully trim the thread tail as close to the bobbin as possible.

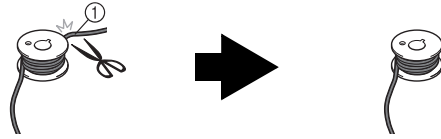

① Beginning of wound thread

CAUTION

- If thread extends beyond the top of the bobbin too much, the thread may become tangled or the needle may break.

- 10** Install the bobbin wound with thread.

Whether or not tension should be applied to the bobbin thread depends on the type of thread being used.

■ When tension is applied to the bobbin thread

Insert bobbin into bobbin case so the thread unwinds from the left side.

Then correctly pass the thread through the tension spring as shown below.

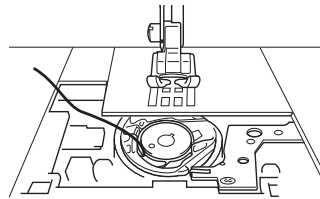
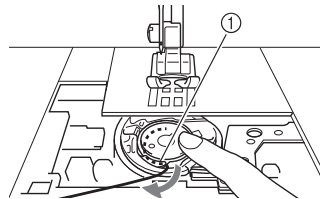

① Tension spring

⚠ CAUTION

- When winding the bobbin, make sure the thread is not frayed. Sewing with frayed thread may result in the thread catching on the tension spring of the bobbin case, the thread becoming tangled or damage to the machine.
- Do not guide the bobbin thread through the groove in the needle plate cover, otherwise the lower threading cannot be done correctly.

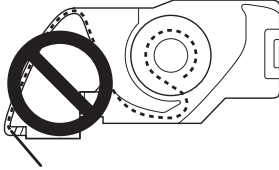

■ When tension is not applied to the bobbin thread

If the bobbin thread in the trial stitching is too tight and adjusting the bobbin case tension does not help, do not pass the thread through the tension spring.

Hold the bobbin with your left hand so the thread unwinds from the right side and hold the end of the thread with your right hand.

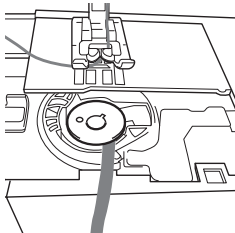
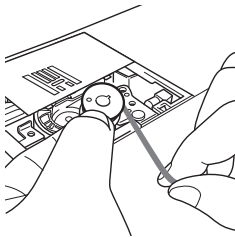

- 11** Pull out about 8 cm (approx. 3 inches) of bobbin thread.

- 12** Lightly hold the end of the upper thread while turning the handwheel toward you (counterclockwise) until the mark on the handwheel aligns with the center top of machine.

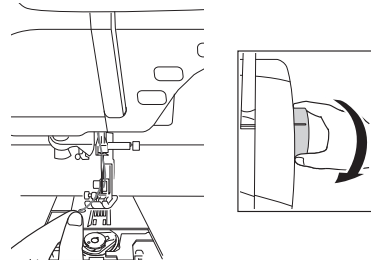

- 13** Gently pull the upper thread to bring the bobbin thread up through the needle plate.

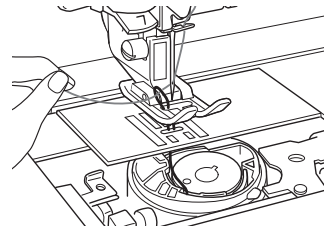

→ A loop of the bobbin thread comes out through the hole in the needle plate.

- 14** Insert tweezers through bobbin thread loop and pull bobbin thread above the needle plate.

- 15** Align the upper thread and bobbin thread, and then pull out about 10 cm (approx. 4 inches) of the threads and pass them under the presser foot toward the rear of the machine.

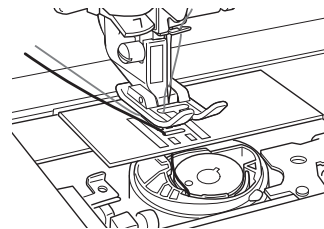

16 Install the needle plate cover and bobbin cover with tabs.

For details on installing the needle plate cover, refer to "Cleaning the Race" in the machine's Operation Manual.

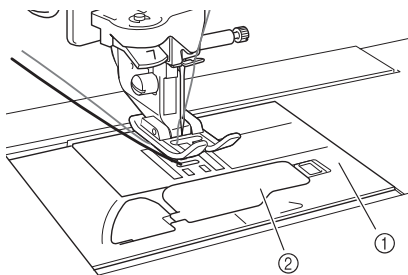

- ① Needle plate cover
- ② Bobbin cover with tabs

⚠ CAUTION

- When creating bobbin work, use the bobbin cover with tabs, otherwise the thread may become tangled or the needle may break.



Note

- When installing the needle plate cover, do not allow it to pinch the thread.

17 Install the flat bed attachment or embroidery unit.



Note

- When installing the flat bed attachment or embroidery unit, do not allow it to pinch the thread.
- When the bobbin thread is replaced with a new one, be sure to repeat the procedure from ①, otherwise the lower threading will not be done correctly.

→ This completes the upper and lower threading.



Note

- If utility stitches are to be used, refer to "CREATING BOBBIN WORK (SEWING)" on page 10. If embroidery patterns are to be used, refer to "CREATING BOBBIN WORK (EMBROIDERY)" on page 13.

CREATING BOBBIN WORK (SEWING)

Positioning the Fabric and Sewing

Note

- Be sure to sew trial stitches using same fabric and threads as project in order to check the sewing results.
- The bobbin thread may become tangled due to the type of pattern and thread that are being used. Since this may cause the needle to break, immediately stop sewing if this occurs. Turn off the machine and cut out the tangled thread with scissors. Then, clean the race and bobbin case as described in "Preparing the Bobbin Thread" on page 6.

- 1 Turn on the machine.
- 2 Select a stitch in the Utility and Decorative

Stitches mode. For this example, press .

Memo

- For best results, select a longer stitch length and a wider stitch width. Depending on the selected stitch, it may not be possible to change the stitch length and stitch width settings.

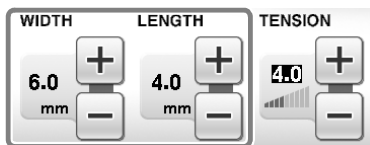

- Depending on the fabric, bunched stitches may result. We recommend selecting a simple stitch and sewing trial stitches to check the sewing results.



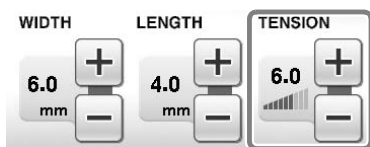

- 3 Adjust the upper thread tension.

For details on adjusting the upper thread tension, refer to "Setting the Thread Tension" in the machine's Operation Manual.



Memo

We recommend a setting between 6 and 8 for the upper thread tension.

- 4 Make sure the automatic thread cutting () and automatic reinforcement/reverse stitching () have been turned off.

CAUTION

- Before sewing, make sure the automatic thread cutting has been turned off. If sewing is started with automatic thread cutting turned on, the thread may become tangled or the machine may be damaged.

- 5 Place a lightweight tear-away stabilizer on top (wrong side) of the fabric.
- 6 Using an awl, punch a hole in the fabric at the beginning of stitching so the bobbin thread can be fed through the fabric.

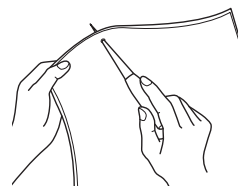

- 7 Press  .
→ The screen changes, and all keys and operation buttons are locked.
- 8 Use the presser foot lever to raise the presser foot.
- 9 With the wrong side facing up, place the fabric under the presser foot.

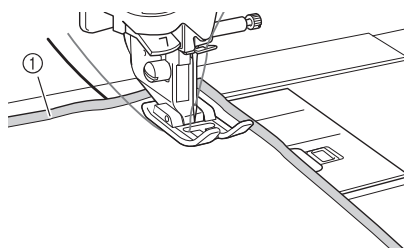

① Wrong side of fabric

- 10** Turn the handwheel toward you (counterclockwise) to feed the needle into the punched hole. Position the upper thread over the presser foot and lightly hold then, lower the presser foot.

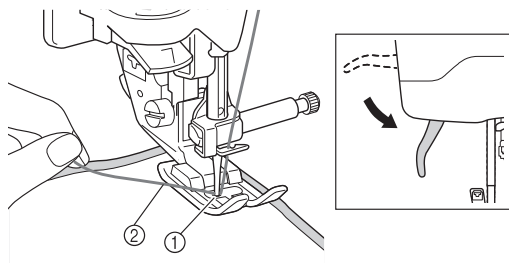

- ① Punched hole
② Upper thread over the presser foot

- 11** Pulling the upper thread gently, turn the handwheel toward you (counterclockwise) until the mark on the handwheel aligns with the center top of machine.

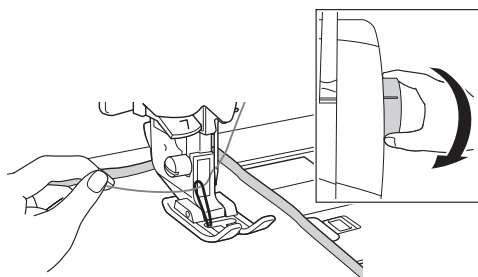

→ A loop of the bobbin thread comes out through the hole in the fabric.

- 12** Raise the presser foot lever, and then use tweezers to pull up the bobbin thread and bring the end of the thread to the top of the fabric.



- Note**
- Pull the thread while holding down the fabric so it does not move out of place.

- 13** Align the upper thread and bobbin thread, and then pass them under the presser foot toward the rear of the machine.

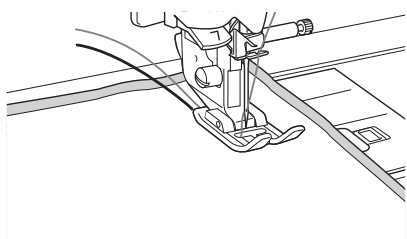

- 14** While gently holding threads at the rear of the machine, turn the handwheel to feed the needle into the punched hole again, and then lower the presser foot lever.

- 15** Press  in the screen.

→ All keys and operation buttons are unlocked, and the previous screen is displayed.

- 16** Select a low speed, gently hold the threads behind the presser foot and start sewing. Threads can be released after several stitches have been made.

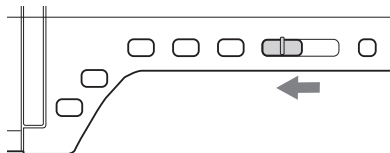

Note

- Before sewing, check that there is enough thread in the bobbin.

- 17** When you have reached the end of the stitching area, stop the machine.



Note

- Do not sew reinforcement/reverse stitches at the end of the stitching, otherwise the threads may become tangled or the needle may break. In addition, it will be difficult to pull the bobbin thread up to the wrong side of the fabric.

- 18** Raise the needle and presser foot.

- 19** Leaving about 10 cm (approx. 4 inches) of thread at the ends, use scissors to cut the threads.

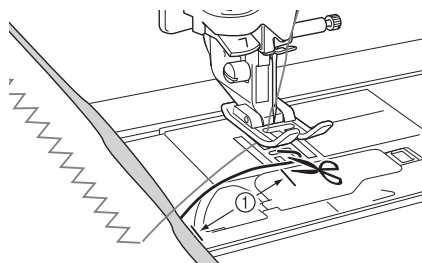

- ① 10 cm (approx. 4 inches)



Note

- Do not press the "Thread Cutter" button to cut the threads, otherwise the machine may be damaged.

■ Finishing the thread ends

- 1 At the end of the stitching, pull the end of the bobbin thread up to the wrong side of the fabric.

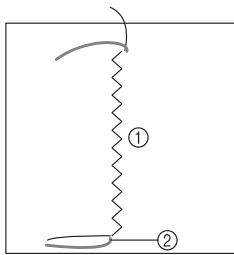

- ① Wrong side of fabric
- ② Bobbin thread



Note

- If it is difficult to pull up the bobbin thread, use a ribbon embroidery needle to pull the thread up to the wrong side of the fabric. Otherwise, use an awl to pull up the bobbin thread.

- 2 From the wrong side of the fabric, tie the bobbin thread and the upper thread together by hand, and then cut off excess threads with scissors.

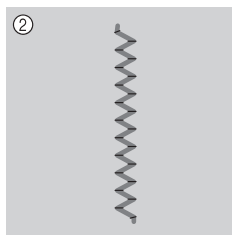
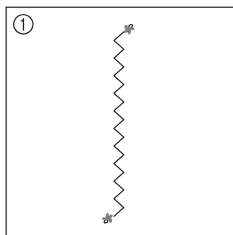

- ① Wrong side of fabric
- ② Surface of fabric



Note

- To ensure threads do not come undone after being tied place a drop of fabric glue on knots.

- 3 If the desired results could not be achieved, adjust the tension of the bobbin thread and of the upper thread, and then try sewing the stitching again.

For more details, refer to "ADJUSTING THE THREAD TENSION" on page 17.

Bobbin Work Free Motion Sewing

- For bobbin work free motion sewing use the instructions for "CREATING BOBBIN WORK (SEWING)" beginning on page 10.
- For information about using the free motion quilting foot "C", free motion open toe quilting foot "O", or free motion echo quilting foot "E" refer to "Free Motion Quilting" located in the machine's Operation Manual.
- If so desired, use a template or draw your design on the stabilizer to allow for ease of stitching. Remember, your stitches with your decorative thread will be on the underneath side of your fabric and the stabilizer will be on the top of the wrong side of your fabric.

CREATING BOBBIN WORK (EMBROIDERY)

Selecting the Pattern



Note

- Prepare the machine for bobbin work as described in "PREPARING FOR BOBBIN WORK" on page 5.

1 Attach the embroidery foot "W" and the embroidery unit.

2 Install a bobbin wound with an adequate amount of thread for pattern.



Note

- For an estimated length of bobbin thread required for each pattern, see page 26. Be sure to use a bobbin wound with enough thread. If the bobbin runs out of thread while sewing, the embroidery cannot be completed.
- Depending on the thread thickness, it may not be possible to wind the bobbin with the necessary length of thread. In this case, try winding the bobbin again, or use a lighter weight thread.

3 Pull up the bobbin thread above the needle plate.

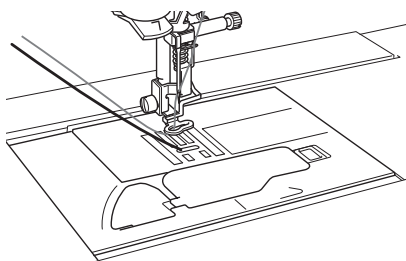

4 Turn on the machine.

5 Press .

→ The carriage will move to the initialization position.

6 To select a bobbin work embroidery pattern, press (Embroidery).



Note

- Embroidery patterns for bobbin work cannot be used in the embroidery edit screen ().

7 Press , then advance to page 10 or 11 (page numbers are for small thumbnail size) of the pattern selection screen for bobbin work patterns.

8 Select one of the bobbin work embroidery patterns.

Embroidery patterns for bobbin work appear with the letter "B" in the lower-left corner of the key.

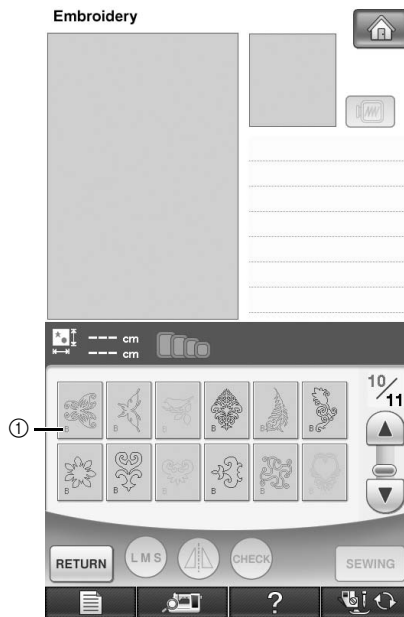

① "B" mark

→ Regardless of the setting that had been selected, the automatic thread cutting function is turned off.

→ When a bobbin work embroidery pattern is selected the embroidery sewing speed is automatically set at 350 spm.

CAUTION

- When sewing bobbin work, be sure to select an embroidery pattern for bobbin work. If any other type of pattern is selected, the machine may be damaged.



Note

- Embroidery sewing speed defaults to 350 spm when a bobbin work embroidery pattern is selected. The Settings screen will not allow speed to be adjusted.



Memo

- When an embroidery pattern for bobbin work is selected, the automatic thread cutting function is turned off. Afterward, if a pattern other than one for bobbin work is selected, the automatic thread cutting function is returned to the setting that was selected before the embroidery pattern for bobbin work was chosen.

9 Press **SEWING** .

→ The sewing screen is displayed.

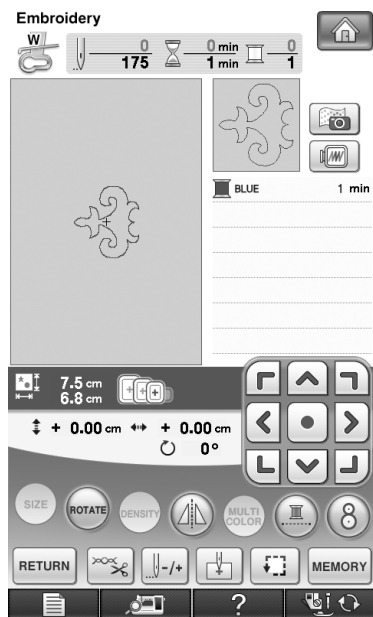

Note

- Since bobbin work is sewn from the wrong side of the fabric, the pattern shown in the screen appears as a mirror image of the final sewn embroidery. If necessary, flip the image to preview it. In addition, when sewing with the thread colors shown in the sewing screen, select a bobbin thread that matches what is shown in the screen.

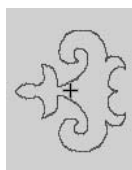

① Image shown in screen

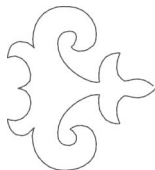

② Sewn embroidery (Right side of fabric)

Memo

- With embroidery patterns for bobbin work, the size and thread density cannot be changed. In addition, the automatic thread cutting function cannot be turned on.

10 Press **TENSION** , and then adjust the tension of the upper thread.

For details on adjusting the tension of the upper thread, refer to “Adjusting Thread Tension” in chapter 5 of the machine’s Operation Manual.

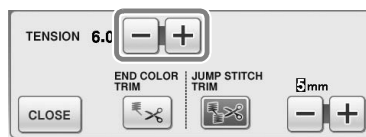

Memo

- We recommend a setting between 6 and 8 for the upper thread tension.

Start Embroidering

- 1 Hoop the fabric so the right side of the fabric is facing down with the stabilizer lying on the top. Use an embroidery frame that fits the size of the pattern and then attach the frame to the machine. These patterns are embroidered from the wrong side of the fabric so technically you are working in “reverse” of normal embroidering.

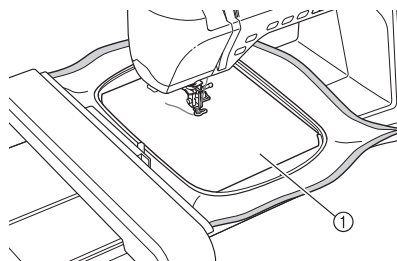

① Wrong side of fabric

CAUTION

- Always use a stabilizer material for embroidery. Otherwise, the needle may break and cause injuries. Not using a stabilizer material may result in a poor finish to your project.

- 2 It is necessary to move to the beginning of stitching so press **←/→** , and then press **↵+1** .

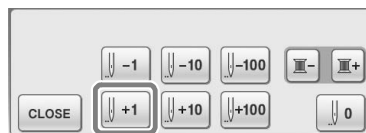

→ The embroidery frame moves to the beginning of stitching.

- 3 Press **CLOSE** .

4 Press  .

→ The screen changes, and all keys and operation buttons are locked.

5 Using the presser foot lever, raise the presser foot.

6 To bring the bobbin thread above the fabric, rotate the handwheel counterclockwise while holding the upper thread.

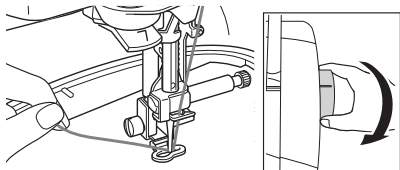

7 As shown below, pull the upper thread to pull the bobbin thread up through the fabric.

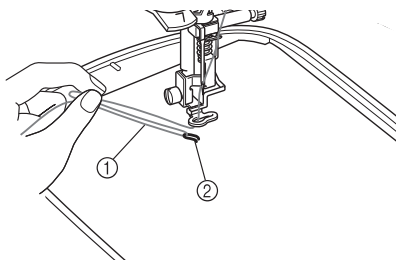

- ① Upper thread
- ② Bobbin thread



Memo

- If the bobbin thread cannot be pulled up, use an awl to create small hole to help pull bobbin thread to surface.

8 Press  to unlock all keys and buttons.

9 Lower the presser foot.

10 While holding both the upper thread and the bobbin thread, sew a section of the pattern.

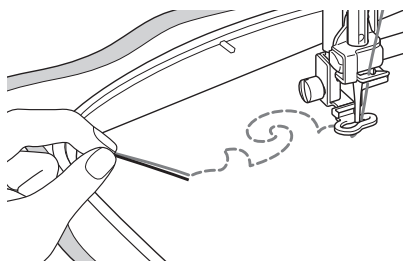

11 Stop the machine, and then tie the upper thread and the bobbin thread together to secure the threads.

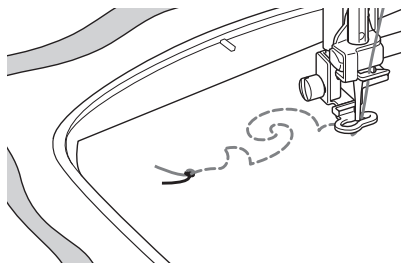

12 Start sewing again to finish the pattern.

13 Raise the needle and presser foot, remove the embroidery frame, and then cut the upper thread and the bobbin thread.

When cutting the threads, be sure to leave an adequate length of thread so they can be properly secured.

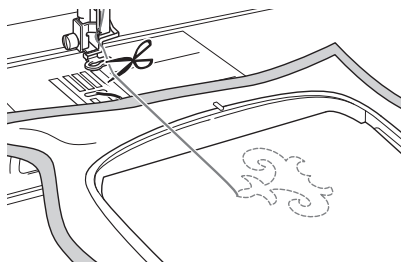

14 Using a hand sewing needle such as a ribbon embroidering needle, pull the bobbin thread to the top (wrong side) of the fabric, and then tie the upper thread and the bobbin thread together.

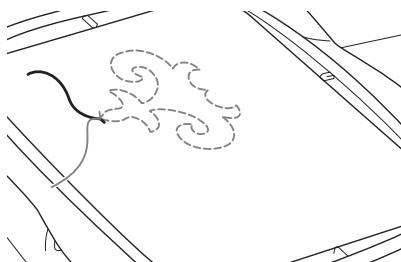

Memo

- If there is a gap between the start point and end point of the pattern, cut the threads, remove the fabric from the machine, and then use a ribbon embroidering needle to hand sew stitches to connect the starting and ending points.

-
- 15 Remove the fabric from the embroidery frame, and check the finished embroidery.

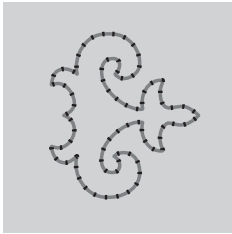

① Right side of fabric

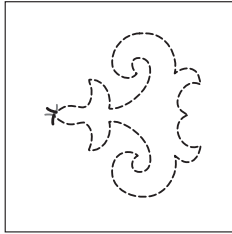

② Wrong side of fabric

- 16 If the desired results could not be achieved, adjust the tension of the bobbin thread and of the upper thread, and then try sewing the pattern again.

For more details, refer to "ADJUSTING THE THREAD TENSION" on page 17.



Memo

- Check bobbin after each bobbin work embroidery pattern is sewn to make sure there is adequate bobbin thread for the next pattern.
-

ADJUSTING THE THREAD TENSION

After sewing trial stitches and checking the sewing results, adjust the thread tensions if necessary. After adjusting the tensions, be sure to sew trial stitches again in order to check the sewing results.

■ Adjusting the upper thread tension

We recommend a setting between 6 and 8 for the upper thread tension.

If utility stitches are being used, refer to "Setting the Thread Tension" in chapter 2 of the machine's Operation Manual. If embroidery patterns are being used, refer to "Adjusting Thread Tension" in chapter 5 of the machine's Operation Manual.

■ Adjusting the tension of the bobbin thread

If the desired stitching cannot be achieved after adjusting the upper thread tension, adjust the tension of the bobbin thread. The tension of the bobbin thread can be adjusted by turning the slotted-head (-) screw on the bobbin case (gray) for bobbin work.

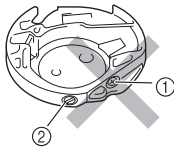

- ① Do not turn the phillips screw (+).
- ② Adjust with a small screwdriver.

To increase the tension of the bobbin thread, turn the slotted-head (-) screw 30° to 45° clockwise.

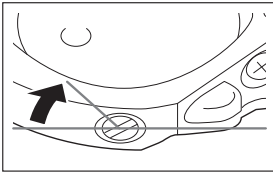

To decrease the tension of the bobbin thread, turn the slotted-head (-) screw 30° to 45° counterclockwise.

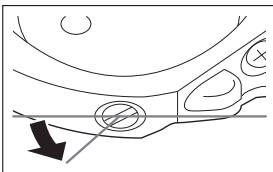

Note

- Turning the screw on the bobbin case (gray) may push up the spring plate, as shown below. If this occurs, gently press down the spring plate with a screwdriver so it is lower than the top surface of the bobbin case (gray), and then insert the bobbin case into the machine.

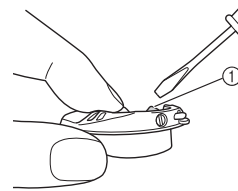

① Spring plate

⚠ CAUTION

- **DO NOT** adjust the position of the phillips (+) screw on the bobbin case (gray) as this may result in damage to the bobbin case, rendering it useless.
- If the slotted screw (-) is difficult to turn, do not use force. Turning the screw too much or providing force in either (rotational) direction may cause damage to the bobbin case. Should damage occur, the bobbin case may not maintain proper tension.



Note

- If the bobbin thread tension is tight, the thread cannot be passed through the tension spring when the bobbin is installed in the bobbin case. (Refer to "When tension is not applied to the bobbin thread" on page 8.)

TROUBLESHOOTING

Several solutions for minor problems are described below. If the problem persists, contact your nearest authorized dealer.

- **The thread was accidentally cut automatically and the bobbin thread is caught inside the machine**

- 1 Cut the thread near the fabric above the needle plate, and then remove the fabric.

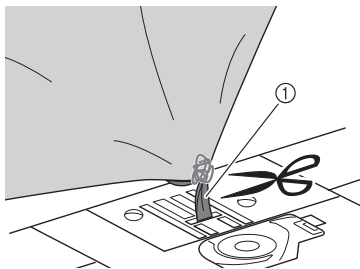

① Thread



Note

- If an embroidery pattern was sewn, remove the embroidery frame.

- 2 Remove the bobbin, and then hold it out toward the left side of the machine.

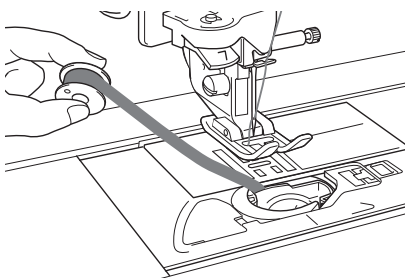

- 3 Lower the presser foot.

- 4 Press the "Thread Cutter" button again, and then pull the thread out to the left while the thread cutter is operating.

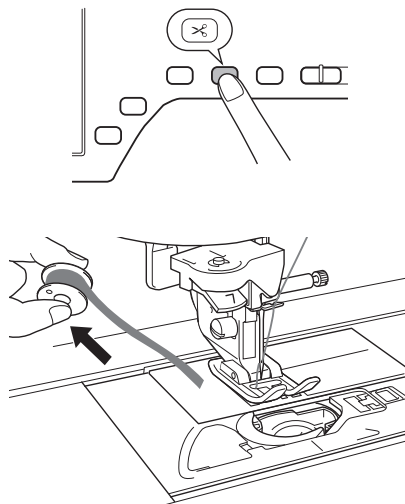

CAUTION

- Do not pull on the thread with excessive force, otherwise the machine may be damaged.

- **The pattern is misaligned**

Refer to "ADJUSTING THE THREAD TENSION" and increase the upper thread tension. If the pattern is still misaligned, reduce the tension of the bobbin thread.

Example: Decorative Stitch

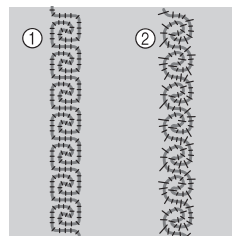

- ① Correct tension
- ② The upper thread tension is too loose, or the bobbin thread tension is too tight.

- **The bobbin thread catches on the tension spring of the bobbin case**

Sew with no tension applied to the bobbin thread. (Refer to "When tension is not applied to the bobbin thread" on page 8.)



Chapter **2**

New Features and New Patterns

HOW TO USE NEW FEATURES

Displaying the Fabric While Aligning the Embroidery Position

The fabric hooped in the embroidery frame can be displayed on the LCD so that the embroidery position can be aligned.

This feature can be used from the sewing screen of embroidery mode and the edit and sewing screens of embroidery edit mode.

As an example, the following procedure is described using the edit screen of the embroidery edit mode.



Note

- When embroidery frame (small: H 2 cm × W 6 cm (H 1 inch × W 2-1/2 inches)) is installed, the built-in camera cannot be used to align the embroidering position. Install medium embroidery frame or larger.
- For details on using thicker fabric such as quilting, refer to "Positioning the pattern on thick fabric" (page 22).

1 Hoop the fabric in the embroidery frame, and then attach the frame to the embroidery machine.

2 Select the pattern, and then press  .

Note

- Check page 8/8 of Settings screen to make sure the Fabric Thickness Sensor is turned off when using light to medium weight fabrics.

3 Press  .

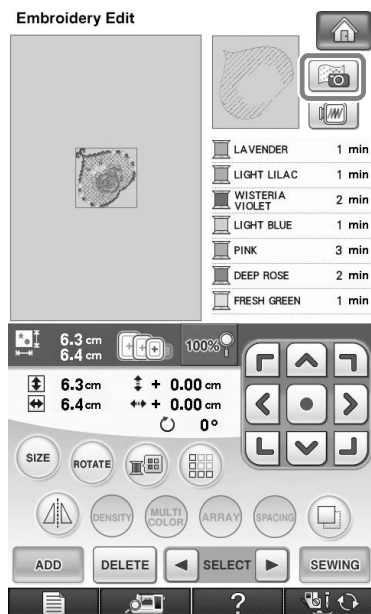

4 When the following message appears, press

 .





→ The embroidery frame moves so the fabric can be scanned.

Memo

- If you do not wish the upper thread to be scanned together with the fabric, scan the fabric without the needle threaded with the upper thread.

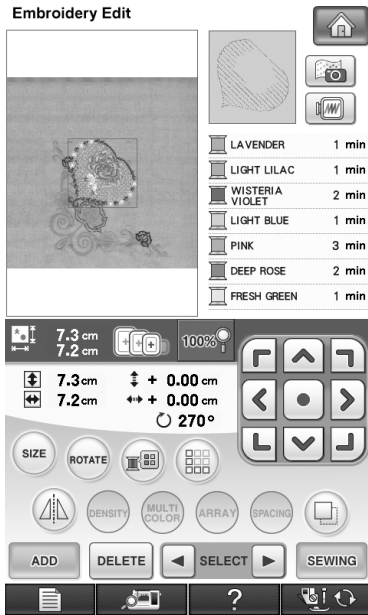
- 5 When the fabric appears as a background for the pattern, the pattern can be edited if it is necessary.



- 6 Use  to align the pattern with the desired embroidery position.

- The pattern can be moved to the desired position by using your finger or the touch pen to drag the pattern displayed on the screen.

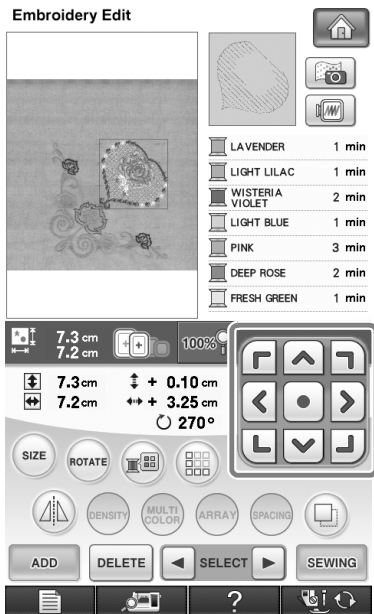

 Memo

- If necessary, press  to display a preview in order to check the pattern position.

- 7 Press **SEWING** to start embroidering.

→ When embroidery is finished, the fabric displayed in the background disappears.

Whether the fabric disappears or remains displayed can be specified from page 8/8 of the Settings screen.

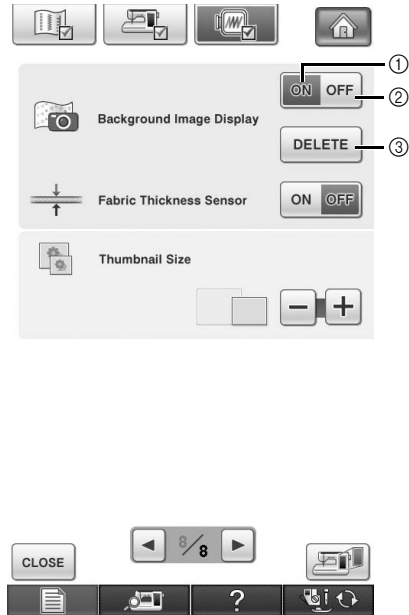

- Set to "ON" to leave the fabric displayed in the background.
- When set to "OFF", the background will disappear.
- Press **DELETE** to remove the background image completely.

 Memo

- The pattern can also be aligned from the sewing screen.

 Note

- If the embroidery is not sewn the fabric background will remain on the screen.

In Settings screen 8/8 press **DELETE** to erase the background image.

■ Positioning the pattern on thick fabric

When positioning the pattern on thick fabric such as quilting, the fabric may not be detected correctly. In order for the fabric to be correctly detected, its thickness must first be measured.



Memo

- This feature is functional only when the fabric is scanned. It will not affect embroidering if it is turned on with normal embroidery.

- 1 Hoop the fabric in the embroidery frame, and then attach the frame to the embroidery machine.
- 2 Select the pattern, and then press .
- 3 Display page 8/8 of the Settings screen, and then set "Fabric Thickness Sensor" to "ON".

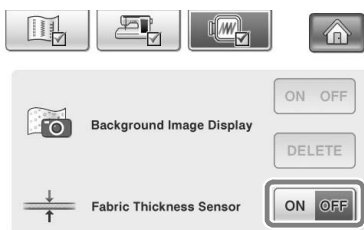

- 4 Press .
- 5 Press .

- 6 Affix the embroidery positioning sticker to the fabric within the area indicated by the red frame in the LCD, and then press .

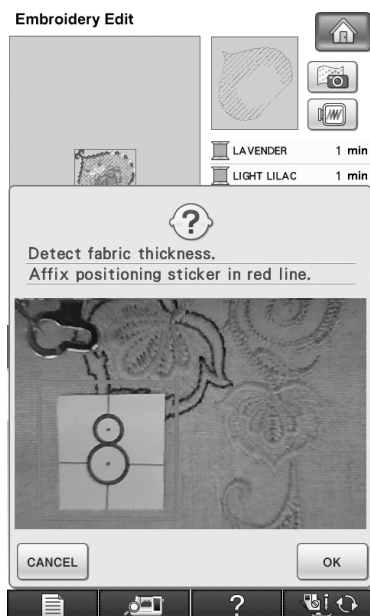

- 7 When the following message appears, remove the embroidery positioning sticker, and then press .

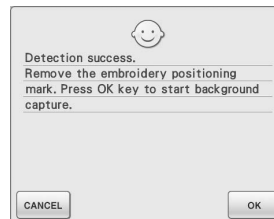

→ The embroidery frame is moved, and the embroidery positioning sticker affixed to the fabric is detected.

- 8 Continue with step 6 on page 21 to align the pattern with the desired embroidery position.

⚠ CAUTION

- Use fabrics with a thickness of less than 3 mm (approx. 1/8 inch). Using fabrics thicker than 3 mm (approx. 1/8 inch) may cause the needle to break.

CHANGING THE PATTERN SIZE WHILE MAINTAINING THE DESIRED THREAD DENSITY (STITCH RECALCULATOR)

In the embroidery edit screen, the size of the pattern can be changed while the desired thread density is maintained.

With this function, the pattern will be enlarged or reduced at a larger ratio than with normal pattern resizing.

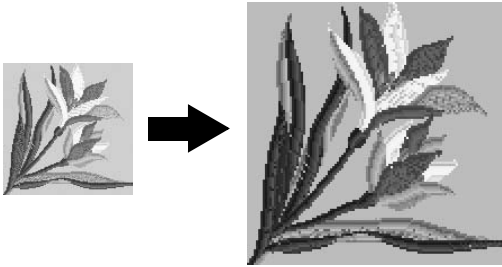

Note

- Be sure to sew trial embroidery using same fabric and threads as project in order to check the sewing results.

1 Press .



2 Select the pattern to be resized, and then press .

Note

- This function cannot be used with alphabet character patterns, frame patterns or border patterns. However, a border pattern can be edited after this function has been used.
- Patterns with a large number of stitches (about 100,001 or more) cannot be resized while maintaining a desired thread density. The maximum limit for the number of stitches differs depending on the data size of pattern.
- If this function is used, thread density is maintained while the pattern is enlarged/reduced. However, the needle drop point pattern is not entirely maintained.

Use the normal resizing mode  depending on the results of trial embroidering.

3 Press .

4 Press  to enter **Stitch Recalculator mode** (.

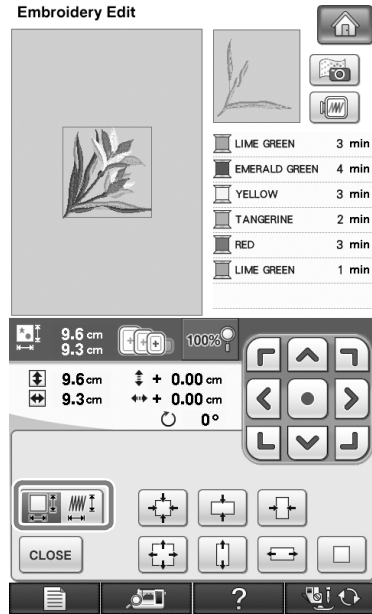

Memo

- Stitch Recalculator cannot be used if the key appears as .

5 When the following message appears, press



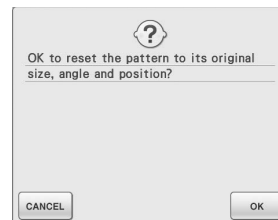



.

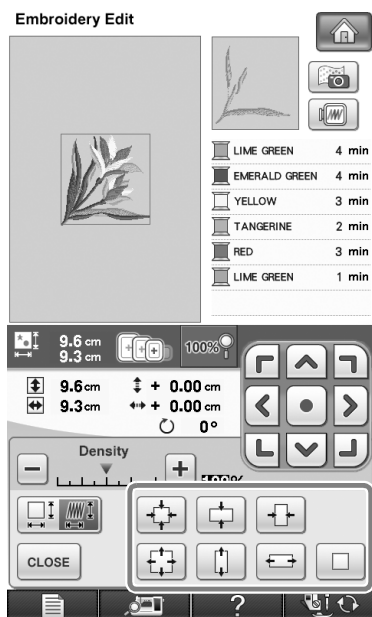

→ The pattern will be returned to its original size, angle, and position as it was before it was edited.

6 Select how to change the pattern size.





- * Press  to enlarge the pattern proportionately.
- * Press  to shrink the pattern proportionately.
- * Press  to stretch the pattern horizontally.
- * Press  to compact the pattern horizontally.
- * Press  to stretch the pattern vertically.
- * Press  to compact the pattern vertically.
- * Press  to return the pattern to its original appearance.

Memo

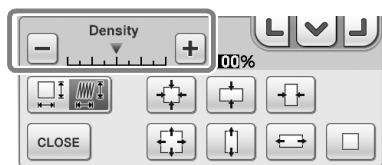
- With the density scale bar, the thread density can be changed.
A setting between 80% and 120% in 5% increments can be specified.



- * Press  to make the pattern less dense.
- * Press  to make the pattern more dense.

7 Press  .

8 Press  .

Note

- Depending on the pattern, embroidering may not be possible at the appropriate thread density. Before sewing on your project, be sure to sew trial embroidery on a piece of scrap fabric that is the same as the fabric used in the project using the same needle and embroidery thread.
- If the pattern is enlarged and there is space between stitches, a better effect can be achieved by increasing the thread density.
- If the pattern is reduced and the stitching is too thick, a better effect can be achieved by reducing the thread density.

CAUTION

- Depending on the pattern, the stitching may become entangled or the needle may break when the pattern is reduced. If this occurs, slightly enlarge the pattern.

NEW PATTERNS

Thumbnail List



Utility embroidery patterns



Note

- Must be accessed through Embroidery mode; not Embroidery Edit mode.

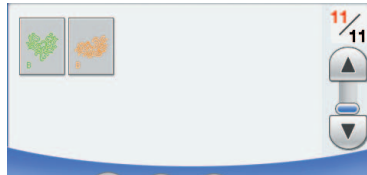
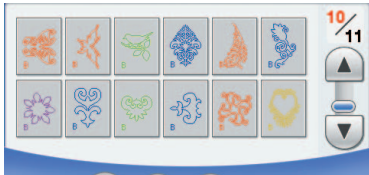

Alphabet character patterns

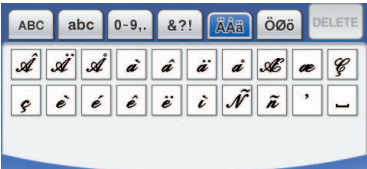
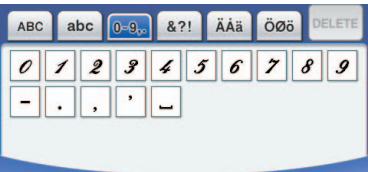
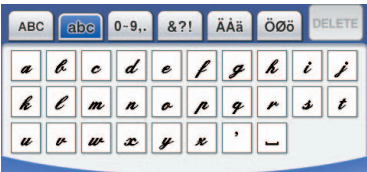
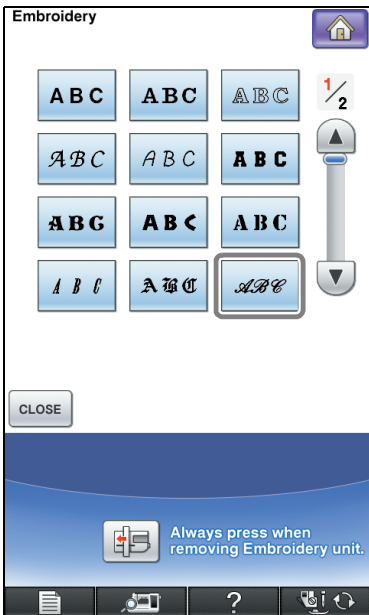

Embroidery Patterns Color Change Table

Embroidery patterns for bobbin work are reversed when they have been sewn.

Use these patterns to create beautiful bobbin work embroidery after selecting upper and lower threads of the desired colors according to the descriptions in "Required Materials" on page 5.

The beginning and end of stitching are specified for bobbin work patterns. They cannot be used for normal embroidering.

No.1



4 min	① Time required for embroidering
	② Embroidery thread color
030	③ Embroidery thread color number
↑ 22.4 cm ↔ 19.9 cm	④ Embroidery size
 4.5 m (3.9m + 0.6 m)	⑤ Total length of thread needed to sew the pattern (to sew the pattern + to tie ends)

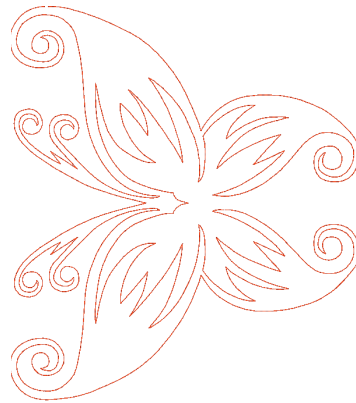

No.2



1 min
030
↑ 17.5 cm ↔ 9.7 cm
 1.5 m (0.9m + 0.6 m)

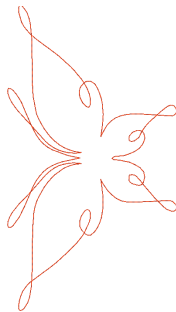

No.3



1 min
509
↑ 12.4 cm ↔ 12.7 cm
 1.6 m (1.0m + 0.6 m)



No.4



3 min
405
↑ 16.5 cm ↔ 12.5 cm
 2.8 m (2.2m + 0.6 m)

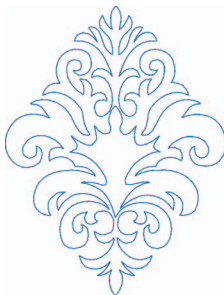

No.5



2 min
030
↑ 19.6 cm ↔ 9.8 cm
 2.3 m (1.7m + 0.6 m)



No.6



1 min
405
↑ 17.5 cm ↔ 10.4 cm
 1.8 m (1.2m + 0.6 m)



No.7

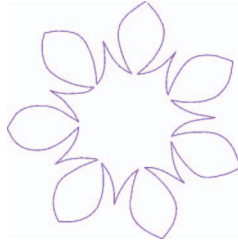

1 min
620
↑ 13.6 cm
↔ 13.3 cm
1.6 m (1.0m + 0.6 m)

No.8

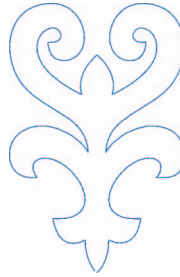

1 min
405
↑ 15.4 cm
↔ 10.0 cm
1.6 m (1.0m + 0.6 m)

No.9



1 min
509
↑ 6.3 cm
↔ 7.5 cm
1.1 m (0.5m + 0.6 m)

No.10



1 min
405
↑ 7.5 cm
↔ 6.8 cm
1.0 m (0.4m + 0.6 m)

No.11



2 min
030
↑ 12.6 cm
↔ 12.6 cm
2.4 m (1.8m + 0.6 m)

No.12



3 min
328
↑ 22.4 cm
↔ 17.7 cm
3.5 m (2.9m + 0.6 m)

No.13



2 min
542
↑ 12.4 cm
↔ 13.6 cm
2.7 m (2.1m + 0.6 m)

No.14



2 min
209
↑ 8.2 cm
↔ 11.8 cm
2.2 m (1.6m + 0.6 m)

Free Manuals Download Website

<http://myh66.com>

<http://usermanuals.us>

<http://www.somanuals.com>

<http://www.4manuals.cc>

<http://www.manual-lib.com>

<http://www.404manual.com>

<http://www.luxmanual.com>

<http://aubethermostatmanual.com>

Golf course search by state

<http://golfingnear.com>

Email search by domain

<http://emailbydomain.com>

Auto manuals search

<http://auto.somanuals.com>

TV manuals search

<http://tv.somanuals.com>