

brother®

Operation Manual

1 GETTING READY

2 SEWING BASICS

3 UTILITY STITCHES

4 EMBROIDERY

5 APPENDIX

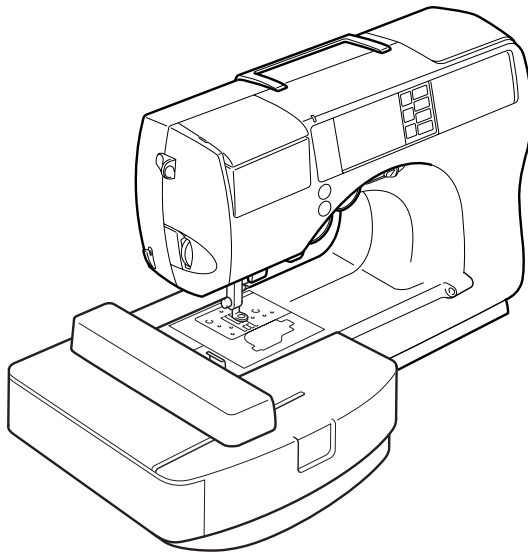

Easy Thread Cassette System

Operation Manual

Included Accessories

After opening the box, check that the following accessories are included. If any item is missing or damaged, contact your retailer.

Accessories



Note

(For U.S.A. only)

- Foot controller: Model N5V
This foot controller can be used on this machine model SE-270D.
- The screw of the presser foot holder is available through your authorized dealer.
(Part code: XA4813-051)

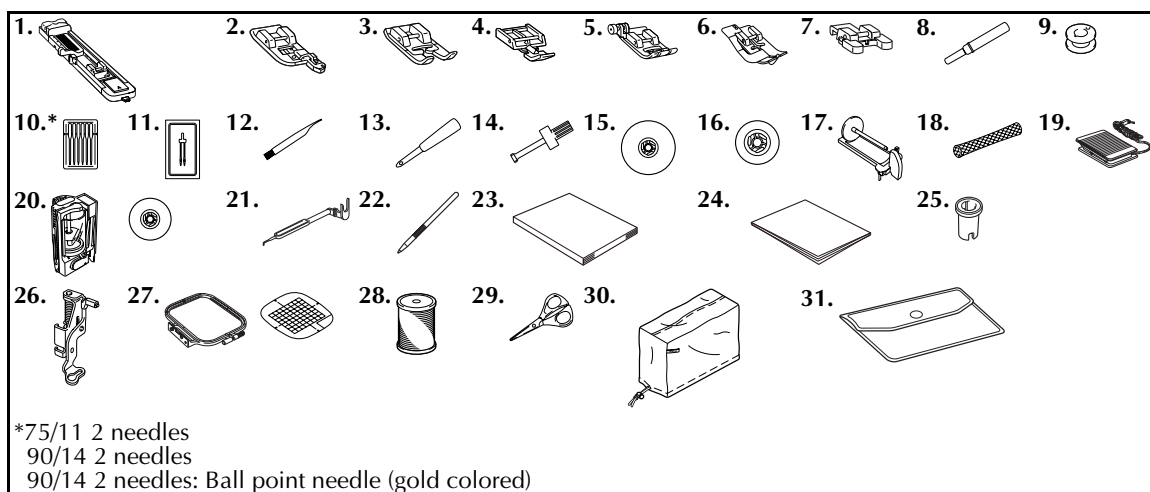

No.	Part Name	Part Code		No.	Part Name	Part Code	
		U.S.A.	Others			U.S.A.	Others
1	Buttonhole foot "A"	XC2691-021		19	Foot controller	XC6651-121	
2	Overcasting foot "G"	XC3098-051		20	Thread cassette set (on machine)	SA250	TC1:XC4716-023
3	Monogramming foot "N"	X53840-351					
4	Zipper foot "I"	X59370-051					
5	Zigzag foot "J" (on machine)	XC3021-051					
6	Blind stitch foot "R"	XC4051-051		21	Needle-changing tool	XC4551-020	
7	Button fitting foot "M"	X59375-151		22	Touch pen	XA9940-021	
8	Seam ripper	X54243-001		23	Operation manual	XC8545-021	
9	Bobbin (4)	SA156	SFB:XA5539-151	24	Quick reference guide	XC8556-021	
10	Needle set	X58358-051		25	Spool cap (special)	XA5752-021	
11	Twin needle	X59296-151		26	Embroidery foot "Q"	XC3829-021	
12	Cleaning brush	X59476-051		27	Embroidery set (medium) H 10 cm X W 10 cm (H 4 inch X W 4 inch)	SA432	EF62:XA6628-002
13	Eyelet punch	135783-001		28	Embroidery bobbin thread (white)	SA-EBT	EBT-CE:X81164-001
14	Screwdriver	XC4237-021		29	Scissors	XC1807-121	
15	Spool cap (large)	130012-054		30	Soft cover	XC4842-022	
16	Spool cap (small)	130013-154		31	Accessory bag	XC4487-021	
17	Extra spool pin	XC3834-021					
18	Spool net	XA5523-050					

Names of Machine Parts and Their Functions

The names of the various parts of the sewing machine and their functions are described below. Before using the sewing machine, carefully read these descriptions to learn the names of the machine parts.

Front view

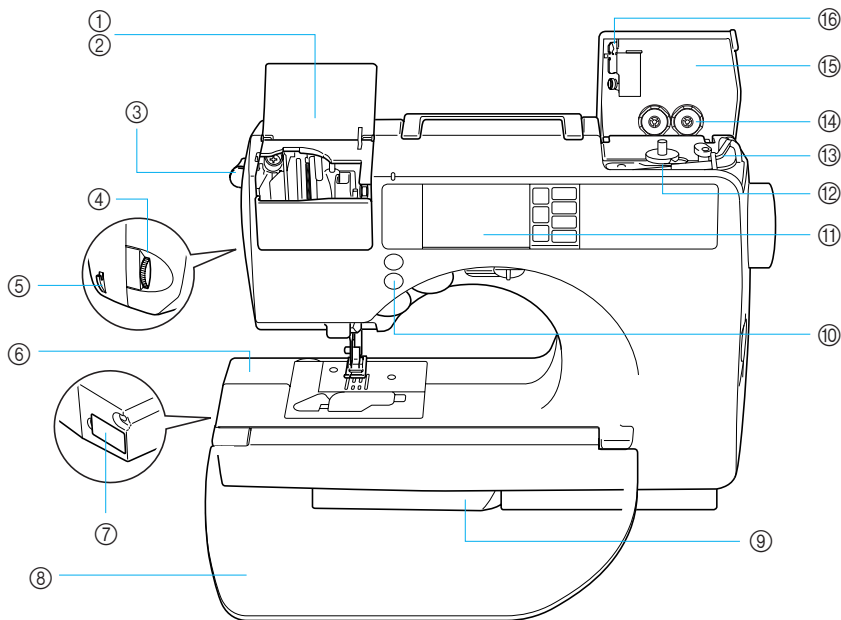

- ① **Thread cassette compartment cover**
- ② **Thread cassette compartment**
Insert a thread cassette into the thread cassette compartment.
- ③ **Thread cassette eject lever**
Press this lever to eject the installed thread cassette.
- ④ **Thread tension dial**
Use the thread tension dial to adjust the tension of the upper thread.
- ⑤ **Thread cutter**
Pass the threads through the thread cutter to cut them.
- ⑥ **Arm**
Plug in the connector for the embroidery unit.
- ⑦ **Embroidery unit connector slot**
Plug in the connector for the embroidery unit.
- ⑧ **Flap**
Use the flap to create a table. When the sewing machine is not being used, store the machine with the flap folded up. Remove the flap to sew cylindrical pieces such as sleeve cuffs.
- ⑨ **Sliding leg**
Pull out the sliding leg during free-arm sewing.
- ⑩ **Operation buttons**
Use the operation buttons to start the sewing machine and raise and lower the needle. (page Cover D)
- ⑪ **Operation panel**
Select a stitch from those that appear in the operation panel. (page Cover E)
- ⑫ **Bobbin winder**
Use the bobbin winder when winding the bobbin.
- ⑬ **Bobbin thread spool pin**
Place the spool of thread for the bobbin onto this spool pin in order to wind the bobbin.
- ⑭ **Bobbin storage compartment**
Store the bobbins designed specifically for this sewing machine in this compartment.
- ⑮ **Bobbin winder cover**
Open this cover when winding the bobbin.
- ⑯ **Thread guide for bobbin winding**
Pass the thread around this thread guide when winding the bobbin thread.

Needle and presser foot section

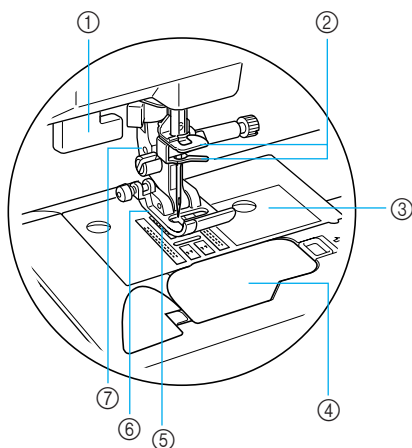

- ① **Buttonhole lever**
Lower the buttonhole lever when sewing buttonholes and bar tacks.
- ② **Needle bar thread hooks**
Pass the upper thread through the needle bar thread hooks.
- ③ **Needle plate**
The needle plate is marked with guides for sewing straight seams.
- ④ **Bobbin cover/Shuttle**
Remove the bobbin cover, and then insert the bobbin into the shuttle.
- ⑤ **Feed dogs**
The feed dogs feed the fabric in the sewing direction.
- ⑥ **Presser foot**
The presser foot applies pressure consistently on the fabric as the sewing takes place. Attach the appropriate presser foot for the selected stitching.
- ⑦ **Presser foot holder**
The presser foot is installed onto the presser foot holder.

Right-side/rear view

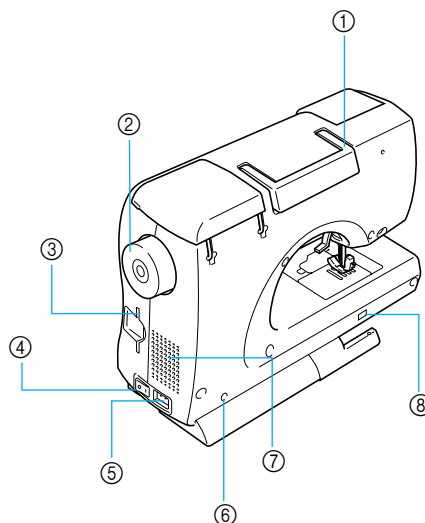

- ① **Handle**
Carry the sewing machine by its handle when transporting the machine.
- ② **Balance wheel**
Turn the balance wheel toward you to raise and lower the needle to sew one stitch.
- ③ **Embroidery card slot**
Insert the embroidery card.
- ④ **Main power switch**
Use the main power switch to turn the sewing machine on and off.
- ⑤ **Power supply jack**
Insert the plug on the power supply cord into the power supply jack.
- ⑥ **Foot controller jack**
Insert the plug on the end of the foot controller cable into the foot controller jack.
- ⑦ **Air vent**
The air vent allows the air surrounding the motor to be exchanged. Do not cover the air vent while the sewing machine is being used.
- ⑧ **Feed dog position switch**
Use the feed dog position switch to lower the feed dogs.



Memo

- Refer to Cover B, C, D or E pages while you are learning to use your machine.

Operation buttons

The operation buttons help you to easily perform various basic sewing machine operations.

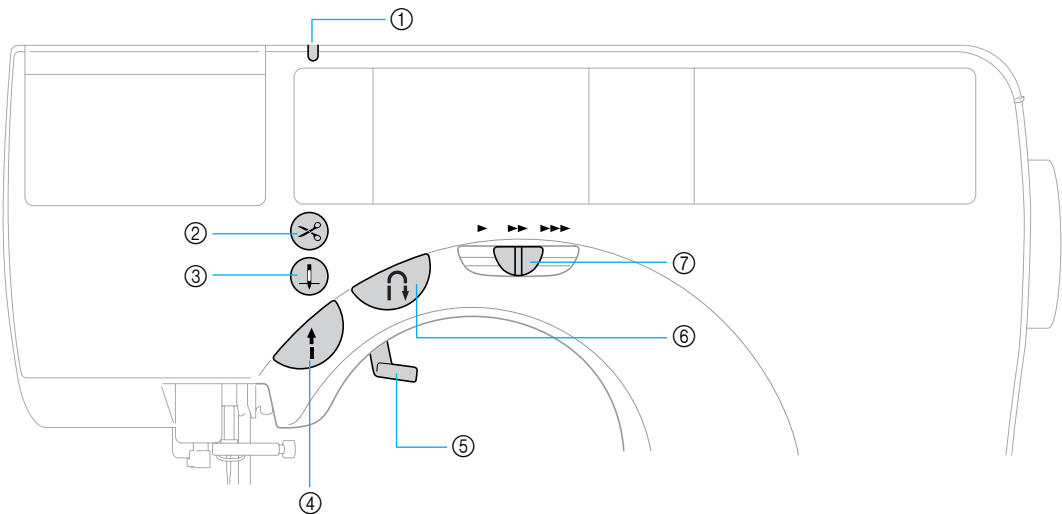

① Thread cassette indicator

The indicator lights up or goes off depending on the condition of the sewing machine.

- Green: A thread cassette can be inserted.
- Red: A thread cassette cannot be inserted.
- Off: The sewing machine has been turned off or a thread cassette is already inserted.

② Thread cutter button

Press the thread cutter button after sewing is stopped to cut both the upper and the bobbin threads. For details, refer to "Cutting the thread" (page 50).

③ Needle position button

Press the needle position button to raise or lower the needle. Pressing the button twice sews one stitch.

④ Start/stop button

Press the start/stop button to start or stop sewing. The machine sews at a slow speed at the beginning of sewing while the button is depressed. When sewing is stopped, the needle is lowered in the fabric. For details, refer to "Starting to sew" (page 47).

⑤ Presser foot lever

Raise and lower the presser foot lever to raise and lower the presser foot.

⑥ Reverse/reinforcement stitch button

Press the reverse/reinforcement stitch button to sew reverse stitches or reinforcement stitches. Reverse stitches are sewn by keeping the button pressed down to sew in the opposite direction. Reinforcement stitches are sewn by sewing 3 to 5 stitches on top of each other. For details, refer to "Securing the stitching" (page 49).

⑦ Sewing speed controller

Slide the sewing speed controller to adjust the sewing speed.

CAUTION

- Do not press the thread cutter button after the threads have already been cut, otherwise the needle may break, the threads may become tangled or damage to the machine may occur.





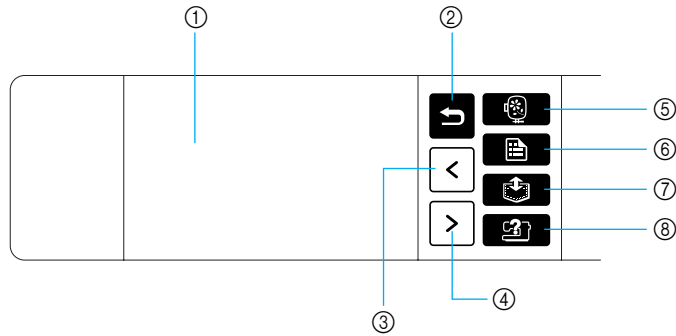

Note

- Do not press the thread cutter button if there is no fabric under the presser foot or while the machine is sewing, otherwise damage to the machine may occur.
- When cutting thread thicker than #30, nylon thread or other special threads, use the thread cutter on the side of the machine. For details, refer to "Cutting the thread" (page 50).

Operation panel

The front operation panel has an LCD (liquid crystal display) and operation keys.



- ① **LCD (liquid crystal display) (touch panel)**
Selected pattern settings and messages are displayed. Touch the keys displayed on the LCD to perform operations.
For details, refer to "LCD (liquid crystal display) operation" (page 12).
- ② **Back key** 
Press to return to the previous LCD display.
- ③ **Previous page key** 
Displays the previous screen when there are items that are not displayed on the LCD.
- ④ **Next page key** 
Displays the next screen when there are items that are not displayed on the LCD.
- ⑤ **Embroidery key** 
When it is in embroidery, press to return to the initial embroidery screen.
- ⑥ **Settings key** 
Press to set the needle stop position, the buzzer sound, and more.
- ⑦ **Memory key** 
Press to enter character embroidery into the sewing machine memory.
- ⑧ **Sewing machine help key** 
Press to get help on using the sewing machine. Displays simple explanations of setting upper thread / bobbin winding / setting bobbin thread / needle replacement / embroidery unit attachment / embroidery frame attachment / embroidery foot attachment / presser foot replacement.

Introduction

Thank you for purchasing this sewing machine. Before using this sewing machine, carefully read the "Important Safety Instructions" (page 5), and then study this manual for the correct operation of the various functions. In addition, after you have finished reading this manual, store it where it can quickly be accessed for future reference.

Sewing Machine Features

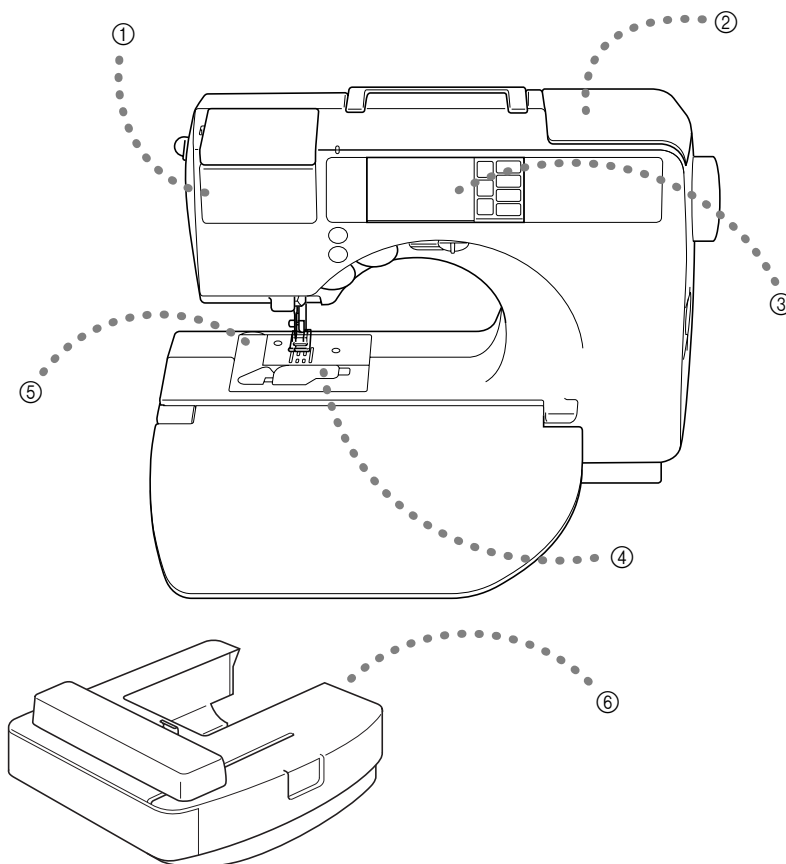

- ① **Thread cassette**
Easily thread the upper thread by loading a spool of thread into the thread cassette. Then, simply insert the thread cassette into the compartment to thread the needle. (page 22)
- ② **Simple bobbin-winding**
The bobbin can quickly and easily be wound with thread. (page 16)
- ③ **Built-in stitches**
You can select from the built-in stitches available, including utility stitches and decorative stitches. (page 64)
- ④ **One-touch lower threading**
You can start sewing without pulling up the bobbin thread. (page 19)
- ⑤ **Automatic thread cutting**
The thread can be cut automatically after sewing. (page 57)
- ⑥ **Embroidery**
You can embroider built-in embroidery patterns, characters, framed decorations, and designs from optional embroidery cards. (page 111)

Contents

Included Accessories	Cover A
Accessories	Cover A
Names of Machine Parts and Their Functions	Cover B
Front view	Cover B
Needle and presser foot section	Cover C
Right-side/rear view	Cover C
Operation buttons	Cover D
Operation panel	Cover E
Introduction	1
Sewing Machine Features	1
Important Safety Instructions	5

GETTING READY 9

Turning the Machine On/Off.....	10
Power supply precautions	10
Turning on the machine	11
Turning off the machine	11
LCD (liquid crystal display) operation	12
Viewing the LCD	12
Changing the Machine Settings	13
Checking machine operating procedures	15
Winding/Installing the Bobbin.....	16
Bobbin precautions	16
Winding the bobbin	16
Installing the bobbin	19
Upper Threading	21
About the spool of thread	21
Loading the spool into the thread cassette	22
Threading the needle	25
Using the extra spool pin	27
Thread the needle manually (without using the needle threader)	28
Using the twin needle	29
Pulling up the bobbin thread	31
Replacing the Needle	33
Needle precautions	33
Needle types and their uses	34
Checking the needle	35
Replacing the needle	35
Replacing the Presser Foot	38
Presser foot precautions	38
Replacing the presser foot	38
Removing the presser foot holder	40
Sewing Cylindrical Pieces.....	41
Free-arm sewing.....	41

SEWING BASICS 43

Sewing.....	44
General sewing procedure	44
Selecting stitching	45
Positioning the fabric	46
Starting to sew	47
Securing the stitching	49
Cutting the thread	50

Adjusting the Thread Tension	52
Thread tension	52
Changing the upper thread tension	53
Adjusting the Stitch Width and Length	54
Adjusting the stitch width	54
Adjusting the stitch length	55
Useful Functions.....	56
Automatically sewing reverse/reinforcement stitches	56
Automatically cutting the thread	57
Mirroring stitches	58
Useful Sewing Tips	59
Trial sewing	59
Changing the sewing direction	59
Sewing curves	59
Sewing thick fabrics	60
Sewing thin fabrics	60
Sewing stretch fabrics.....	60
Sewing an even seam allowance	61

UTILITY STITCHES 63

Stitch Settings.....	64
Utility stitches	64
Overcasting Stitches.....	69
Sewing overcasting stitches using overcasting foot "G"	69
Sewing overcasting stitches using zigzag foot "J"	70
Sewing overcasting stitches using the optional side cutter	71
Basic Stitching	73
Basting	73
Basic stitching	73
Blind Hem Stitching	75
Buttonhole Stitching.....	77
Buttonhole sewing	78
Button sewing	82
Zipper Insertion.....	84
Inserting a centered zipper	84
Inserting a side zipper	86
Sewing Stretch Fabrics and Elastic Tape	89
Stretch stitching.....	89
Elastic attaching	89
Appliqué, Patchwork and Quilt Stitching	91
Appliqué stitching	91
Patchwork (crazy quilt) stitching	93
Piecing.....	93
Quilting	94
Free-motion quilting.....	96
Satin stitching.....	97
Reinforcement Stitching.....	98
Triple stretch stitching	98
Bar tack stitching.....	98
Darning.....	100
Eyelet Stitching.....	102
Decorative Stitching.....	103
Fagoting	104
Scallop stitching.....	105
Smocking	105
Shell tuck stitching	106
Joining	107
Heirloom stitching	108

Embroidering neatly	112
What to prepare	112
Embroidery step by step	114
Attaching the embroidery foot	115
Attaching the embroidery foot	115
Removing the embroidery foot	117
Attaching the embroidery unit	118
Embroidery unit precautions	118
Attaching the embroidery unit	118
Removing the embroidery unit	120
Preparing the fabric.....	122
Attaching a stabilizer material to the fabric	122
Setting the fabric in the embroidery frame	123
Attaching the embroidery frame	126
Attaching the embroidery frame	126
Removing the embroidery frame	127
Selecting embroidery patterns.....	128
Copyright Information	128
Embroidery pattern types.....	128
LCD (liquid crystal display) operation	129
Selecting characters	130
Selecting embroidery patterns	131
Selecting a frame pattern	132
Using an embroidery card	133
Embroidering.....	134
Embroidering a pattern	134
Appliquéing	136
Convenient Functions.....	138
Adjusting the layout	138
Storing characters.....	139
Adjusting the thread tension	141
Resewing	141
Thread runs out partway through a design.....	142
Stopping while embroidering	142

Maintenance.....	146
Cleaning the machine surface	146
Cleaning the shuttle	146
Troubleshooting	148
Error messages	153
Nothing appears in the LCD	155
Operation beep.....	155
Cancelling the operation beep	156
Index	157

Important Safety Instructions

When using this machine, basic safety precautions should always be taken, including the following:

Read all instructions before using.

DANGER - To reduce the risk of electric shock:

1. The machine should never be left unattended while plugged in. Always unplug the machine from the electrical outlet immediately after using and before cleaning.

WARNING - To reduce the risk of burns, fire, electric shock, or injury to persons:

1. Do not allow this machine to be used as a toy. Close attention is necessary when the machine is used by or near children.
2. Use this machine only for its intended use as described in this manual. Use only accessories recommended by the manufacturer as contained in this manual.
3. Never operate this machine if it has a damaged cord or plug, if it is not working properly, if it has been dropped or damaged, or dropped into water. Return the machine to the nearest authorized dealer or service center for examination, repair, electrical or mechanical adjustment.
4. Never operate the machine with any air openings blocked. Keep ventilation openings of the machine and foot control free from the accumulation of lint, dust, and loose cloth.
5. Never drop or insert any object into any opening.
6. Do not use outdoors.
7. Do not operate where aerosol (spray) products are being used or where oxygen is being administered.
8. To disconnect, turn the main switch to the symbol "○" position which represents off, then remove plug from outlet.
9. Do not unplug by pulling on cord. To unplug, grasp the plug, not the cord.
10. Keep fingers away from all moving parts. Special care is required around the machine needle.
11. Always use the proper needle plate. The wrong plate can cause the needle to break.
12. Do not use bent needles.
13. Do not pull or push fabric while stitching. It may deflect the needle causing it to break.
14. Switch the machine to the symbol "○" position when making any adjustments in the needle area, such as threading needle, changing needle, threading bobbin, or changing presser foot, and the like.
15. Always unplug the machine from the electrical outlet when removing covers, lubricating, or when making any other user servicing adjustments mentioned in the instruction manual.
16. This sewing machine is not intended for use by young children or infirm persons without supervision.
17. Young children should be supervised to ensure that they do not play with this machine.
18. If the Light unit is damaged, it must be replaced by authorized dealer.

SAVE THESE INSTRUCTIONS

This machine is intended for household use.

FOR USERS IN THE UK, EIRE, MALTA AND CYPRUS ONLY

If this machine is fitted with a three-pin non-rewireable BS plug then please read the following.

IMPORTANT

If the available socket outlet is not suitable for the plug supplied with this equipment, it should be cut off and an appropriate three-pin plug fitted. With alternative plugs an approved fuse must be fitted in the plug.

NOTE

The plug served from the main lead must be destroyed as a plug with bared flexible cords is hazardous if engaged in a live socket outlet. In the event of replacing the plug fuse, use a fuse approved by ASTA to BS 1362, i.e. carrying the  mark, rating as marked on plug. Always replace the fuse cover, never use plugs with the fuse cover omitted.

WARNING

DO NOT CONNECT EITHER WIRE TO THE EARTH TERMINAL WHICH IS MARKED WITH THE LETTER 'E', BY THE EARTH SYMBOL  OR COLOURED GREEN OR GREEN AND YELLOW.

The wires in this main lead are colored in accordance with the following code:

Blue	Neutral
Brown	Live

As the colors of the wiring in the main lead of this appliance may not correspond with the colored markings identifying the terminals in your plug, proceed as follows.

The wire which is colored blue must be connected to the terminal which is marked with the letter 'N' or colored black or blue.

The wire which is colored brown must be connected to the terminal which is marked with the letter 'L' or colored red or brown.

CONGRATULATIONS ON CHOOSING OUR MACHINE

Your machine is one of the most advanced computerized household sewing machines. To fully enjoy all the features, we suggest that you study the manual before using the machine.

PLEASE READ BEFORE USING THIS MACHINE

For safe operation

1. Be sure to keep your eye on the needle while sewing. Do not touch the balance wheel, thread take-up lever, needle, or other moving parts.
2. Remember to turn off the power switch and unplug the cord when:
 - Operation is completed
 - Replacing or removing the needle or any other parts
 - A power failure occurs during use
 - Maintaining the machine
 - Leaving the machine unattended
3. Do not store anything on the foot controller.
4. Plug the machine directly into the wall. Do not use extension cords.

For a longer service life

1. When storing this machine, avoid direct sunlight and high humidity locations. Do not use or store the machine near a space heater, iron, halogen lamp, or other hot objects.
2. Use only neutral soaps or detergents to clean the case. Benzene, thinner, and scouring powders can damage the case and machine, and should never be used.
3. Do not drop or hit the machine.
4. Always consult the operation manual when replacing or installing any assemblies, the presser feet, needle, or other parts to assure correct installation.

For repair or adjustment

In the event a malfunction occurs or adjustment is required, first follow the troubleshooting table in the back of the operation manual to inspect and adjust the machine yourself. If the problem persists, please consult your local authorized Brother dealer.

For additional product information and updates, visit our web site at www.brother.com



GETTING READY

The various preparations required before starting to sew are described in this chapter.

Turning the Machine On/Off	10
LCD (liquid crystal display) operation	12
Winding/Installing the Bobbin.....	16
Upper Threading	21
Replacing the Needle	33
Replacing the Presser Foot	38
Sewing Cylindrical Pieces.....	41

Turning the Machine On/Off

This section explains how to turn the sewing machine on and off.

Power supply precautions

Be sure to observe the following precautions concerning the power supply.

WARNING

- Use only regular household electricity for the power source. Using other power sources may result in fire, electric shock, or damage to the machine.
- Turn off the main power and remove the plug in the following circumstances:
 - When you are away from the machine
 - After using the machine
 - When the power fails during use
 - When the machine does not operate correctly due to a bad connection or a disconnection
 - During electrical storms

CAUTION

- Do not use extension cords or multi-plug adapters with many other appliances plugged in to them. Fire or electric shock may result.
- Do not touch the plug with wet hands. Electric shock may result.
- When unplugging the machine, always turn off the main power first. Always grasp the plug to remove it from the outlet. Pulling on the cord may damage the cord, or lead to fire or electric shock.
- Do not allow the power cord to be cut, damaged, modified, forcefully bent, pulled, twisted, or bundled. Do not place heavy objects on the cord. Do not subject the cord to heat. These things may damage the cord and cause fire or electric shock. If the cord or plug is damaged, take the machine to your authorized dealer for repairs before continuing use.
- Unplug the power cord if the machine is not to be used for a long period of time. Otherwise a fire may result.

Turning on the machine

Prepare the included power cord.

- 1 Make sure that the sewing machine is turned off (the main power switch is set to "O"), and then plug the power supply cord into the power supply jack on the right side of the machine.
- 2 Insert the plug of the power supply cord into a household electrical outlet.

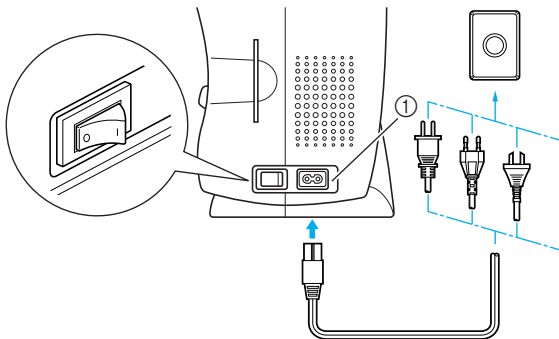

① Power supply jack

- 3 Press the right side of the main power switch on the right side of the machine (set it to "I").

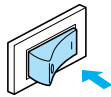

▶ The sewing lamp comes on when the machine is turned on.

- 4 Fold the flap at the front of the sewing machine down toward you.

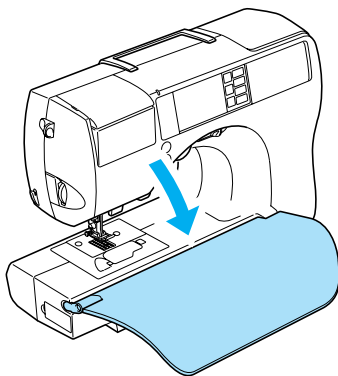

Turning off the machine

When you are finished using the sewing machine, turn it off. In addition, before transporting the sewing machine to another location, be sure to turn it off.

- 1 Make sure that the machine is not sewing.
- 2 Press the left side of the main power switch on the right side of the machine (set it to "O").

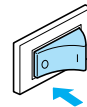

▶ The sewing lamp goes off when the machine is turned off.

- 3 Unplug the power supply cord from the electrical outlet.
Grasp the plug when unplugging the power supply cord.

- 4 Unplug the power supply cord from the power supply jack.

Note

- If a power outage occurs while the sewing machine is being operated, turn off the sewing machine and unplug the power supply cord. When restarting the sewing machine, follow the necessary procedure to correctly operate the machine.

(For U.S.A. only)

- This appliance has a polarized plug (one blade wider than the other). To reduce the risk of electrical shock, this plug is intended to fit in a polarized outlet only one way. If the plug does not fit fully in the outlet, reverse the plug. If it still does not fit, contact a qualified electrician to install the proper outlet. Do not modify the plug in any way.

LCD (liquid crystal display) operation

Selected stitch, pattern settings and messages are displayed on the LCD (liquid crystal display) on the front of the sewing machine.

Viewing the LCD

When the power is turned on, the LCD comes on, and the following screen is displayed.

The LCD display is changed using the        keys on the right, and operations performed by directly touching the LCD.

If it is difficult to press the buttons on the LCD by hand, you can use the touch pen to operate the LCD display.

■ Utility stitch selection screen

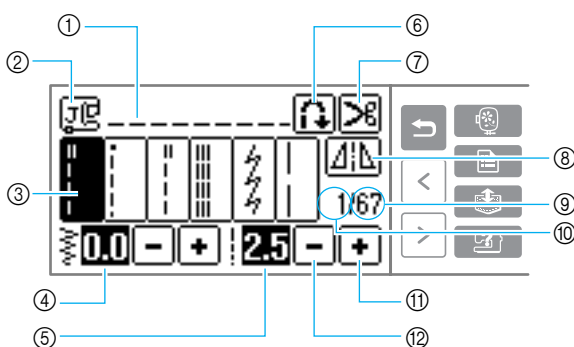

- ① Selected stitch
- ② Presser foot to be used
- ③ Stitches
- ④ Stitch width (mm)
- ⑤ Stitch length (mm)
- ⑥ Automatic reverse/reinforcement
- ⑦ Automatic thread cutting
- ⑧ Horizontal mirror image key
- ⑨ Number of stitches in group
- ⑩ Number of the selected stitch
- ⑪ Increase value
- ⑫ Decrease value



Memo

- A different screen is displayed when the embroidery unit is attached.
- Refer to "Error messages" (page 153) for messages displayed on the LCD.
- Depending on the model of sewing machine, an animation may be displayed when the power is turned on. When an animation is displayed, the screen above will be displayed if you touch the LCD with your finger.

Changing the Machine Settings

Various sewing machine operations and sewing settings can be changed. The stitch or machine attributes that can be set are listed below.

Attribute	Icon	Details	Settings
Thread color/ needle count		You can switch among thread color/thread number/needle count when embroidering.	Thread color/Embroidery thread number/Country Embroidery thread number/Needle count/Time to Embroider (after TIME is pressed)
Needle position		Specifies where the needle is positioned when the sewing machine is stopped.	Down Up
Twin needle sewing		Specifies the twin needle.	Normal needle Twin needle
Thread color index		When embroidery data containing custom thread colors specified with the PE-DESIGN Ver.5.0 is saved on a blank card, the stored custom thread colors are displayed on the machine, if "ON" is selected for this setting.	ON OFF
Automatic thread cutting for embroidery		Press this key to use the automatic thread cutting function when embroidering.	ON OFF
Stitch width control		Allows the stitch width to be adjusted with the sewing speed controller.	ON OFF
Buzzer		Specifies whether or not a beep is sounded with each operation (page 156).	ON OFF
Opening screen		Sets whether or not to display the opening screen when the power is turned on. (There are models where this cannot be changed.)	ON OFF
Language		Allows the language used in the screens to be changed.	English, French, German, Dutch, Spanish, Italian, Danish, Norwegian, Finnish, Swedish, Portuguese, Russian, Japanese, Korean or others
LCD brightness		Adjusts the brightness of the LCD.	Lighter - + Darker

1 Turn on the sewing machine.

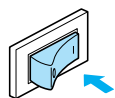



▶ The LCD comes on.

2 Press (Settings key) on the display panel.



▶ The settings screen appears.

- 3** Press the item to be set.
Switch screens using  (Previous page key) and  (Next page key).

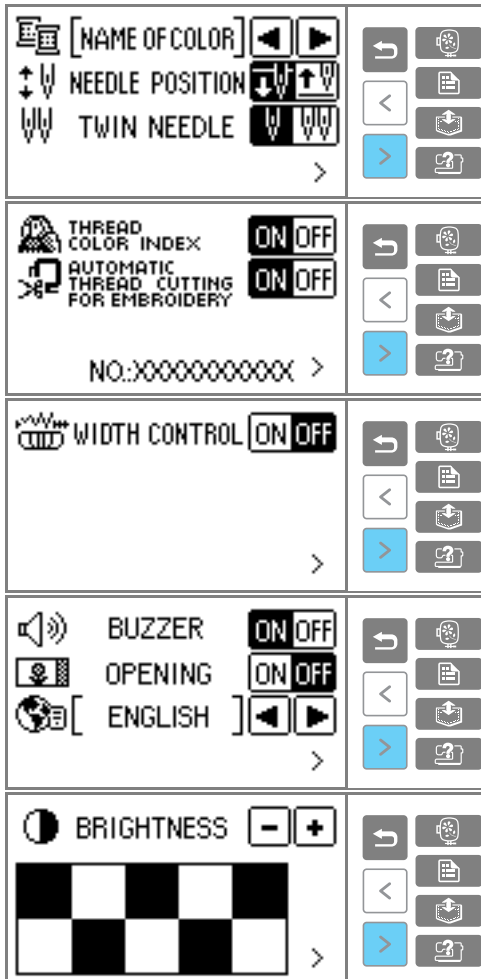

- The items shown in reverse highlighting are the settings at the time of purchase.

□ **Example:** Changing the needle stop position



- 4** When settings are complete, press  (Back key).

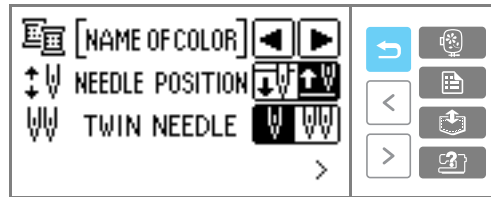

- ▶ The initial screen appears again.

Note

- The "Thread color index" is the color number display used when embroidery cards made by "PE-Design" are used.
- The "NO." is the number for the sewing machine.
- Settings that are changed are not lost when the power is turned off.

Checking machine operating procedures

Displays simple explanations of setting upper thread / bobbin winding / setting bobbin thread / needle replacement / embroidery unit attachment / embroidery frame attachment / embroidery foot attachment / presser foot replacement on the LCD.

1 Turn on the sewing machine.

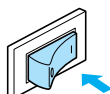

▶ The LCD comes on.

2 Press (Sewing machine help key) on the display panel.



▶ The sewing machine help screen appears.

3 Press the item to be displayed.

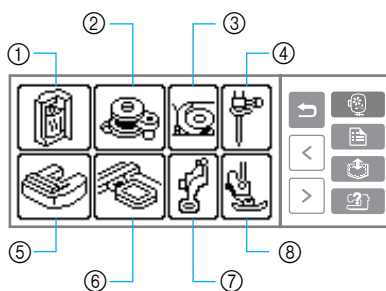

- ① Threading the upper thread
- ② Winding the bobbin
- ③ Installing the bobbin
- ④ Needle replacement
- ⑤ Embroidery unit attachment
- ⑥ Embroidery frame attachment
- ⑦ embroidery foot attachment
- ⑧ Replacing the presser foot

▶ The first screen describing the procedure for the selected topic appears.

- Pressing , returns you to the item selection screen.

4 Press (Next page key) to switch to the next page.

If you press , you return to the previous page.

□ Example: Upper threading

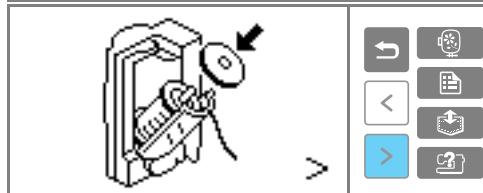
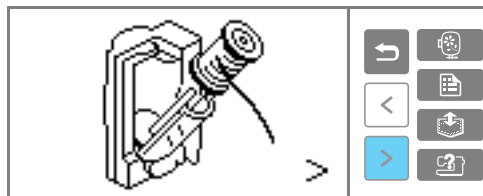

⋮

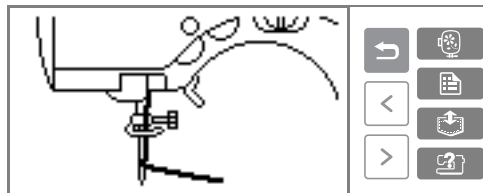

5 After you finish looking, press (Back key) two times.

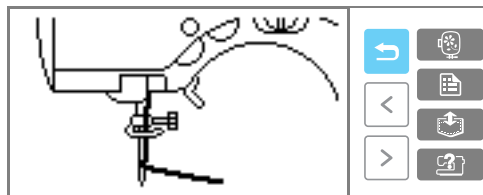

▶ The initial stitch screen appears again.

Note

- For details on each topic, refer to the corresponding page in this Operation Manual.

Winding/Installing the Bobbin

This section describes how to wind the thread onto the bobbin, and then insert the bobbin thread.

Bobbin precautions

Be sure to observe the following precautions concerning the bobbin.

CAUTION

- Only use the Bobbin (part code: SA156, SFB:XA5539-151) designed specifically for this sewing machine. Use of any other bobbin may result in injuries or damage to the machine.
- The included bobbin was designed specifically for this sewing machine. If bobbins from older models are used, the machine will not operate correctly. Use only the included bobbin or bobbins of the same type (part code: SA156, SFB:XA5539-151).

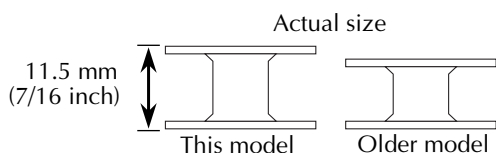

- Please use a transparent bobbin.

Winding the bobbin

Wind the thread around the bobbin to prepare the bobbin thread.

- 1 Turn on the sewing machine.

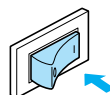

- 2 Open the bobbin winder cover at the top on the right side of the sewing machine. Raise until it stops with a click.

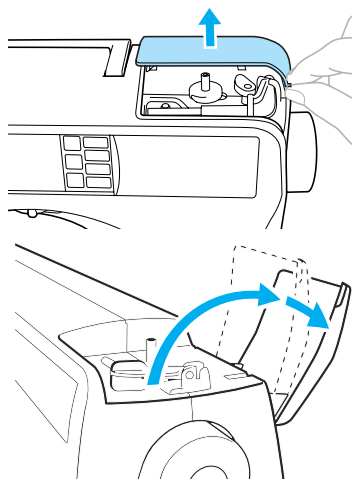

- 3 Swing up the bobbin thread spool pin. Move the bobbin thread spool pin up as far as possible.

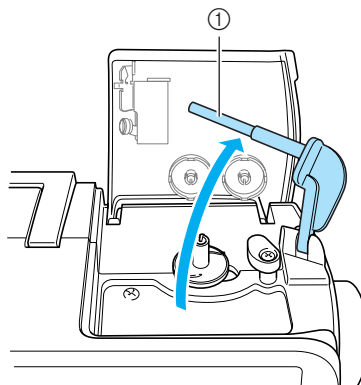

① Bobbin thread spool pin

- 4 Place the bobbin on the bobbin winder shaft so that the spring on the shaft fits into the notch in the bobbin.

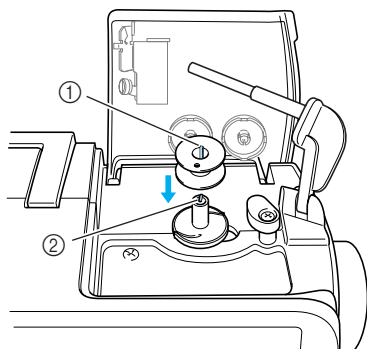

- ① Notch
② Bobbin winder shaft spring

- 5 Slide the bobbin winder shaft to the right.

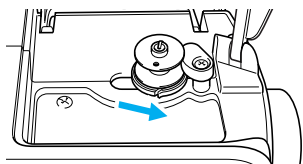

- 6 Place the spool of thread for the bobbin onto the bobbin thread spool pin.

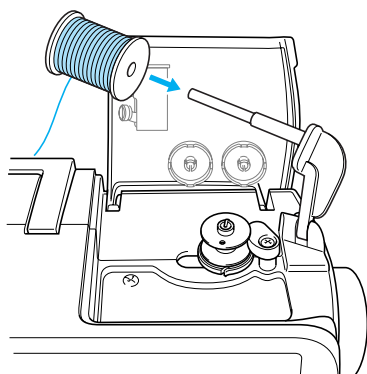

- Use the special Brother embroidery bobbin thread when embroidering.

- 7 Slide the spool cap onto the bobbin thread spool pin.

With the rounded side of the spool cap positioned toward the left, slide the spool cap onto the bobbin thread spool pin as far as possible until the right side of the spool touches the right end of the bobbin thread spool pin.

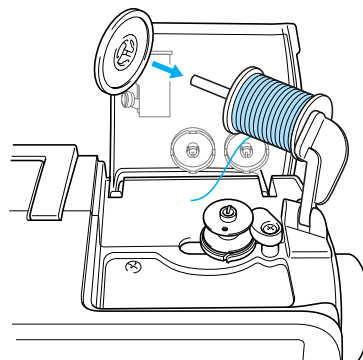

! CAUTION

- Two spool cap sizes are available, allowing you to choose a spool cap that best fits the size of spool being used. If the spool cap is too small for the spool being used, the thread may catch on the slit in the spool or the needle may break.

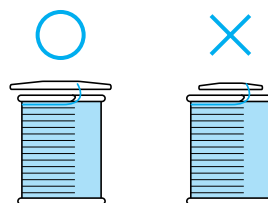

★ Note

- If a spool of thread 12 mm (1/2 inch) in diameter and 75 mm (3 inch) high is inserted onto the bobbin thread spool pin, use the special spool cap.

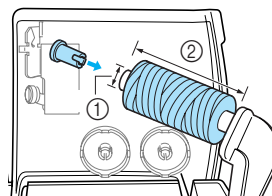

- ① 12 mm (1/2 inch)
② 75 mm (3 inch)

**Memo**

- When using thread that winds off quickly, such as transparent nylon thread or metallic thread, place the spool net over the spool before placing the spool of thread onto the spool pin.
- If the spool net is too long, fold it to fit the size of the spool.

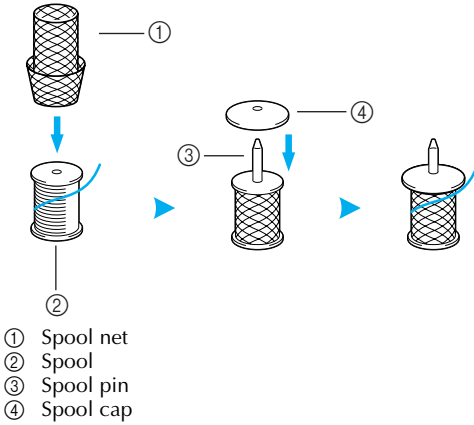
**8 Pull out some thread, and then thread the thread guide for bobbin winding.**

Be sure that the thread is fully in the two thread guides for bobbin winding.

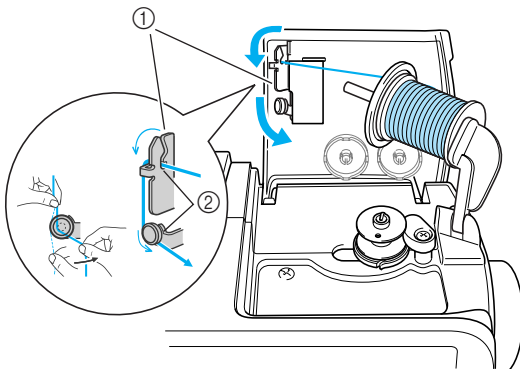
**9 Wind the thread that was pulled out onto the bobbin.**

Wind the thread that was pulled clockwise five or six times without any slack.

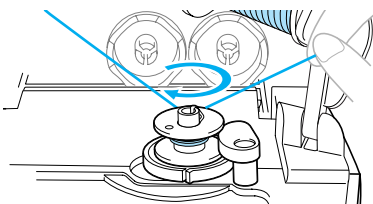
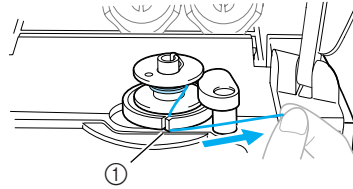
**10 Pull the thread to the right and pass it through the slit in the bobbin winder seat.**

- ▶ The thread is cut to a suitable length.

CAUTION

- Be sure to cut the thread as described. If the bobbin is wound without cutting the thread using the cutter built into the slit in the bobbin winder seat, the thread may become tangled in the bobbin or the needle may bend or break when the bobbin thread starts to run out.

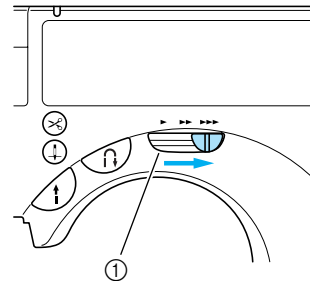
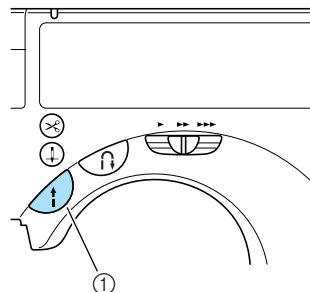
11 Slide the sewing speed controller to the right (so that the speed will be fast).**12 Press (Start/stop button) once.**

- If it does not start when the start/stop button is pressed, an animation is displayed on the LCD. Press the start/stop button after touching the LCD.

- ▶ The bobbin starts spinning and winding the thread, and "Winding bobbin thread..." appears on the LCD.
- ▶ When winding is complete, the bobbin stops spinning or spins freely.

13 When the bobbin either stops spinning or spins freely, press  (Start/stop button).

- ▶ The sewing machine stops, and the "Winding bobbin thread..." display disappears from the LCD.

14 Use scissors to cut the end of the thread wound around the bobbin.

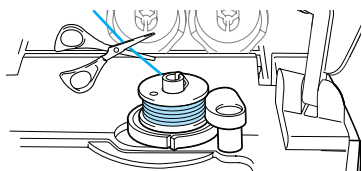

15 Slide the bobbin winder shaft to the left.

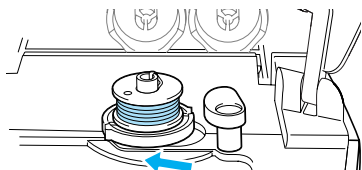

16 Remove the bobbin from the shaft.

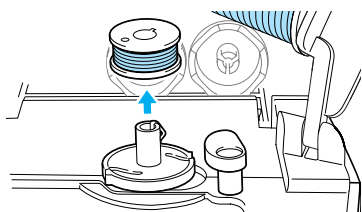

17 Remove the spool cap and spool.

18 Swing down the bobbin thread spool pin, close the bobbin winder cover, and then slide the sewing speed controller back to its original position.



Memo

- When the sewing machine is started or the balance wheel is turned after winding the bobbin, the machine will make a clicking sound; this is not a malfunction.

Installing the bobbin

Install the bobbin wound with thread.

CAUTION

- Use a bobbin that has been correctly wound with thread, otherwise the needle may break or the thread tension will be incorrect.

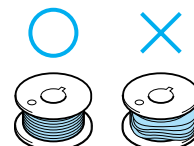

- The bobbin was designed specifically for this sewing machine. If bobbins from older models are used, the machine will not operate correctly. Use only the included bobbin or bobbins of the same type (part code: SA156, SFB:XA5539-151).

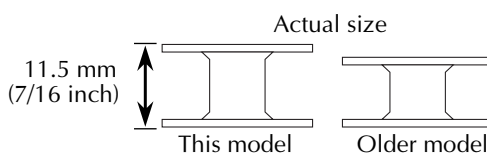

1 Slide the bobbin cover latch to the right.

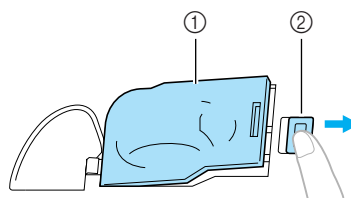

- ① Bobbin cover
- ② Latch

- ▶ The bobbin cover opens.

2 Remove the bobbin cover.

3 Hold the bobbin with your right hand and hold the end of the thread with your left.

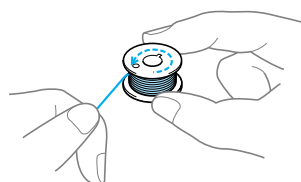

- Be careful not to drop the bobbin.

- 4** Insert the bobbin into the shuttle so that the thread unrolls to the left.

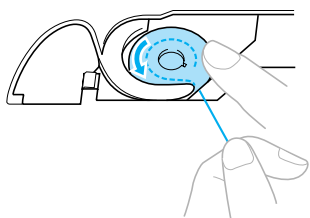

- Be sure to insert the bobbin correctly.

CAUTION

- Be sure to hold down the bobbin with your finger and unroll the bobbin thread correctly, otherwise the thread may break or the thread tension will be incorrect.

Memo

- The order that the bobbin thread should be passed through the shuttle is indicated by marks around the shuttle. Be sure to thread the machine as indicated.

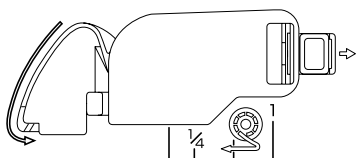

- 5** Lightly hold down the bobbin with your right hand, and then guide the thread as shown with your left hand.

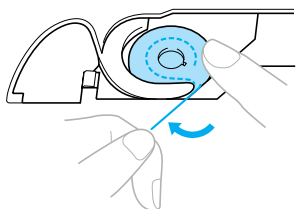

- 6** Pass the thread through the slot as shown, and then pull the thread out toward the front.

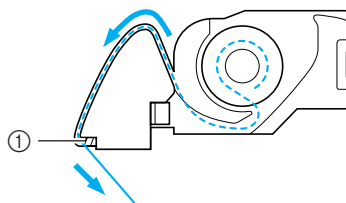

① Cutter

- ▶ The cutter cuts the thread.

- Make sure that the thread is correctly inserted through the tension-adjusting spring of the shuttle. If it is not inserted, re-insert the thread.

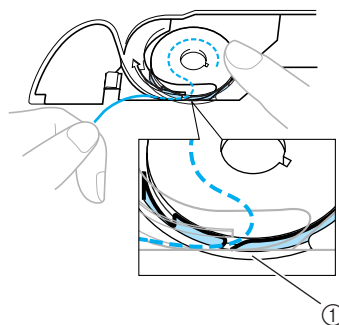

① Tension-adjusting spring

- 7** Reattach the bobbin cover.

Insert the tab in the lower-left corner of the bobbin cover, and then lightly press down on the right side.

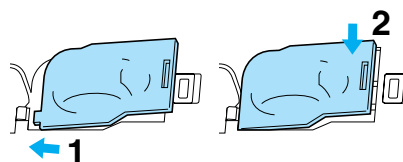

- ▶ The bobbin threading is finished.

Next, thread the upper thread. Continue with the procedure in "Upper Threading" (on the next page).

Memo

- You can begin sewing without pulling up the bobbin thread. If you wish to pull up the bobbin thread before starting to sew, pull up the thread according to the procedure in "Pulling up the bobbin thread" (page 31).

Upper Threading

In this section, the procedures for positioning the spool for the upper thread and threading the needle are described.

1

CAUTION

- When threading the upper thread, carefully follow the instructions. If the upper threading is not correct, the thread may become tangled or the needle may bend or break.

About the spool of thread

With this sewing machine, a spool of thread can be loaded into the thread cassette, and then the thread cassette can be threaded. Information about the spools of thread is described below.

Spools that can be loaded into the thread cassette

Normally, a spool of thread is loaded into the thread cassette and used. The spools that can be loaded must have a diameter smaller than the orange spool cap and a height shorter than the mark on the cover of the thread cassette.

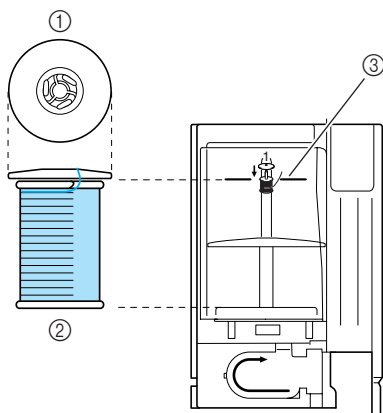

- ① Spool cap (orange)
- ② Spool
- ③ Mark on thread cassette compartment cover

Spools that cannot be loaded into the thread cassette

When using spools that cannot be loaded into the thread cassette, use the extra spool pin.

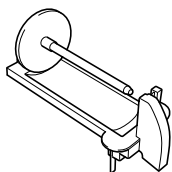

When using the extra spool pin, attach either the large or small white spool cap, depending on the size of the spool. Use the spool cap with a diameter that is slightly larger than the diameter of the spool.

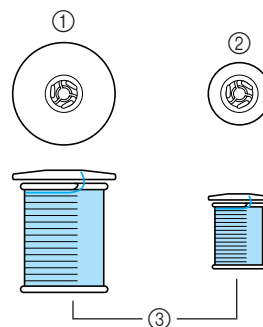

- ① Spool cap (large)
- ② Spool cap (small)
- ③ Spool

Memo

- For details on using the extra spool pin, refer to "Using the extra spool pin" (page 27).
- When using a spool of cross-wound thread, install the small white spool cap with some space between the cap and the spool.

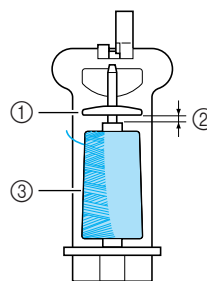

- ① Spool cap (small)
- ② Gap
- ③ Spool

CAUTION

- Two spool cap sizes are available, allowing you to choose a spool cap that best fits the size of spool being used. If the spool cap is too small for the spool being used, the thread may catch on the slit in the spool or the needle may break.

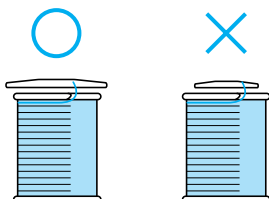
**Loading the spool into the thread cassette**

Load the spool of thread into the thread cassette to prepare the upper thread.

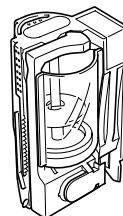
**Memo**

- The order for threading the thread cassette is indicated on the thread cassette. Also check the markings on the thread cassette while threading it.

- 1 Turn on the sewing machine.

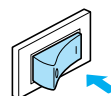

- 2 Open the thread cassette compartment cover at the top on the left side of the machine.

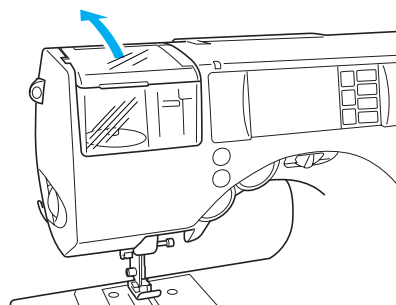

- 3** Push the thread cassette eject lever on the left side of the machine toward the back.

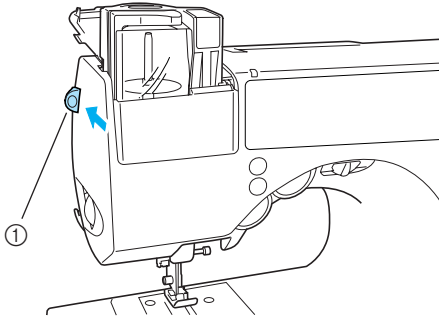

- ① Thread cassette eject lever
▶ The thread cassette is raised.

- If the sewing machine is turned off, the thread cassette will not be ejected correctly.

- 4** Remove the thread cassette.

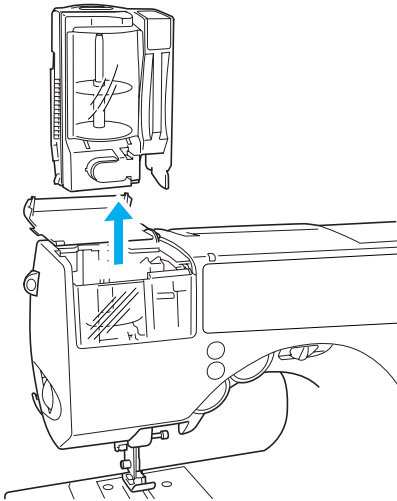

- 5** Pull the cover of the thread cassette out toward you, and then pull off the spool cap that is inserted onto the spool pin.

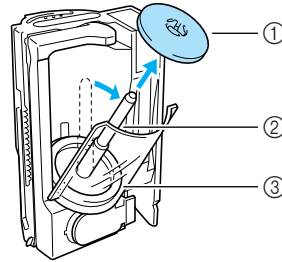

- ① Spool cap (orange)
② Spool pin
③ Cover

- 6** Place the spool for the upper thread onto the spool pin.

Slide the spool onto the spool pin so that the thread unwinds from the left, as seen from the top.

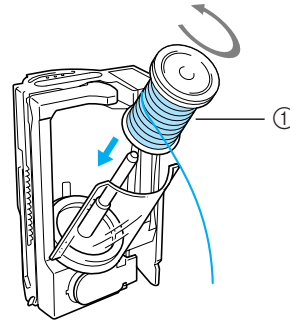

- ① Spool

- 7** Slide the spool cap onto the spool pin.

With the rounded side of the spool cap positioned toward the top, slide the spool cap onto the spool pin as far as possible until the down side of the spool touches the down end of the spool pin.

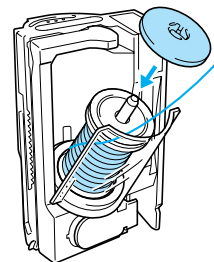

- Only the orange spool cap should be placed on the spool pin in the thread cassette.

CAUTION

- If the spool or the spool cap is not positioned correctly, the thread may become tangled around the spool pin or the needle may break.

- 8** While holding the end of the thread with your right hand and the thread cassette with your left hand, close the cover. Close until it clicks.

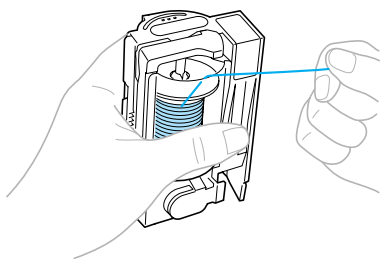

- 9** Pass the thread through the slit in the top of the thread cassette. Follow arrow 2 indicated on the thread cassette.

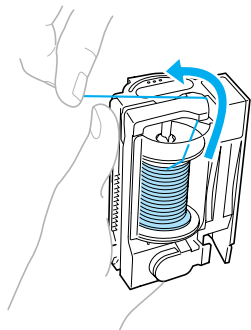

- 10** Pull the thread to the left and pass it through the slit along the left side of the thread cassette. Follow arrow 3 indicated on the thread cassette.

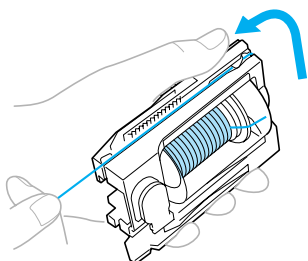

- When using special thread such as metallic thread, use the thumb of your left hand to lightly press down on the area indicated in the illustration to create an opening that allows for easier threading.

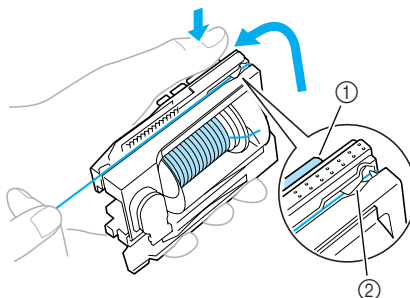

- ① Push
② Gap

- 11** Pass the thread along the bottom of the thread cassette. Follow arrow 4 indicated on the thread cassette.

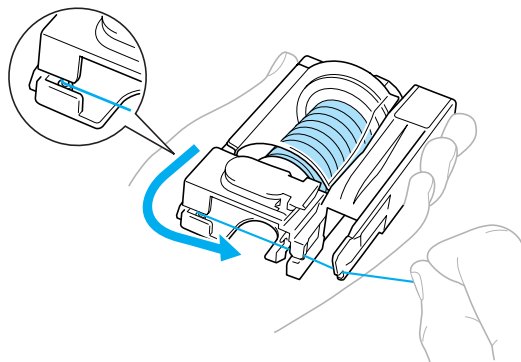

- 12** Pass the thread through the notch in the lower-right corner of the thread cassette, and then pull the thread to the left. Follow arrow 5 indicated on the thread cassette.

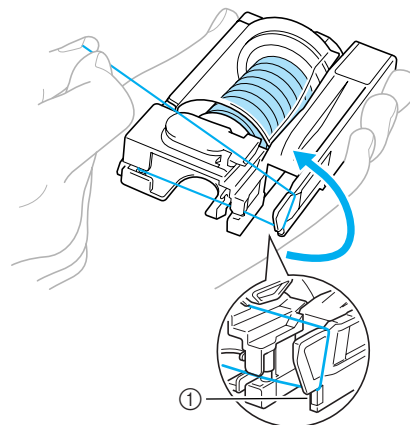

- ① Notch

- 13** Pull the thread under the disc at the front in the lower-left corner and around to the right, and then the thread will be cut with the cutter. Follow arrow 6 indicated on the thread cassette.

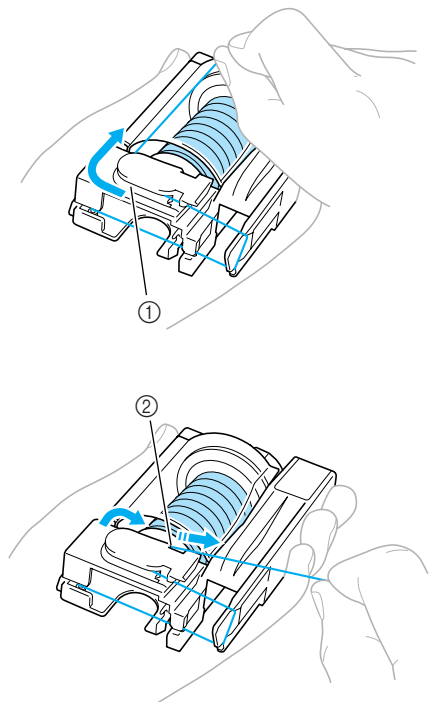

- ① Disc
② Cutter

▶ The spool of thread is now loaded in the thread cassette.

Note

- Be sure the thread is cut as described above, otherwise the needle threader cannot be used to thread the needle.

Threading the needle

In this section, the procedures for installing the thread cassette and threading the needle are described. The needle threader is used to thread the needle at the same time that the thread cassette is inserted.

Memo

- The needle threader can be used with sewing machine needles 75/11 through 100/16.
- Thread with a thickness of 130/20 or thicker cannot be used with the needle threader.
- The needle threader cannot be used with the wing needle or the twin needle.
- If the needle threader cannot be used, refer to "Thread the needle manually (without using the needle threader)" (page 28).

- 1** Check that the thread cassette indicator is lit up in green.

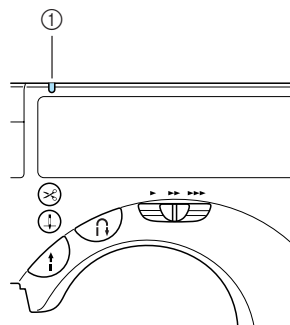

- ① Thread cassette indicator

- If the thread cassette indicator is lit up in red, the needle has not been raised to the correct position. Press ⊕ (Needle position button) once to raise the needle.

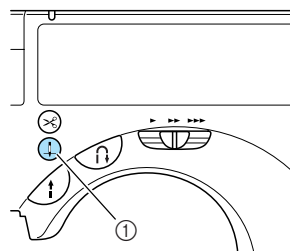

- ① Needle position button

- If the needle is not raised to the correct position, the needle cannot be threaded with the needle threader. Be sure to check that the thread cassette indicator is lit up in green before inserting the thread cassette.

2 Insert the thread cassette into the thread cassette compartment.

Slowly press down on the thread cassette until it clicks into place.

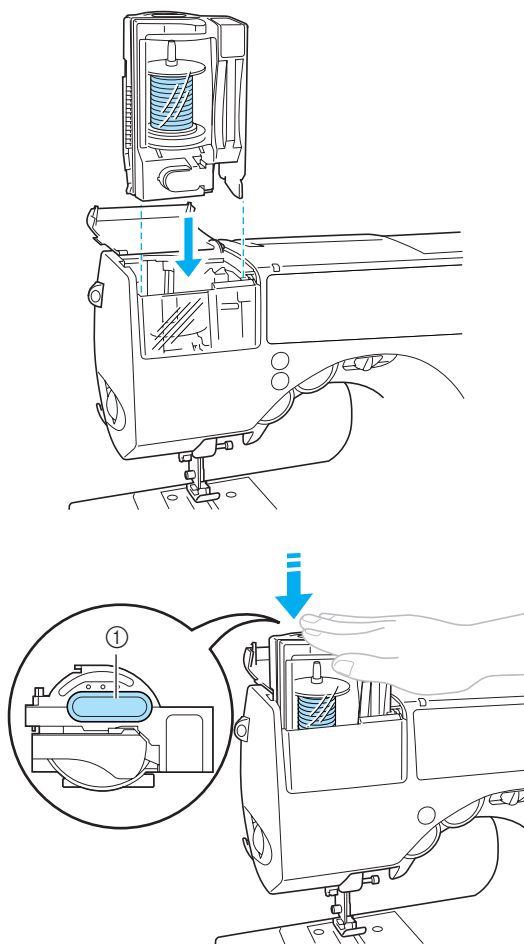

① Push here

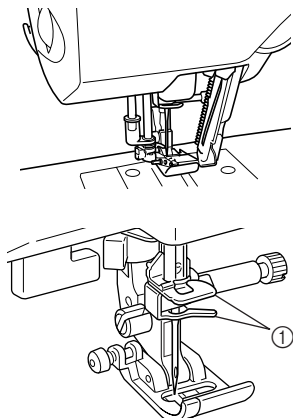

① Needle bar thread hooks

▶ At the same time that the thread cassette is inserted, the needle is threaded.

▶ The thread cassette indicator goes off.

- If any of the following operations are performed, the needle may not be threaded or the machine may be damaged.

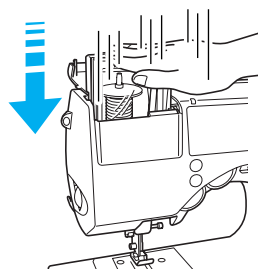

× Pushing the cassette down too fast

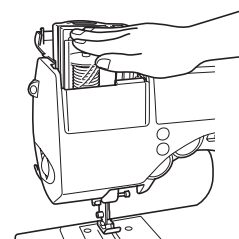

× Pushing down on a part of the cassette other than the gray area

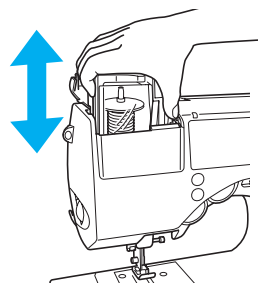

× Inserting the cassette only partway, then pulling it out

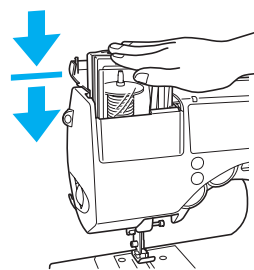

× Inserting the cassette partway and pausing it before fully inserting it

- If the needle could not be threaded or the thread was not passed through the needle bar thread hook, refer to "Loading the spool into the thread cassette" (page 22) and perform the procedure again starting from step 2.

- The thread cassette can be inserted whenever the presser foot lever is raised or lowered. However, when the side cutter is attached, be sure to lower the presser foot lever before installing the thread cassette. For more details, refer to "Sewing overcasting stitches using the optional side cutter" (page 71).

! CAUTION

- The needle threader will automatically thread the needle when the thread cassette is pushed down. Be sure to keep your hands and other items away from the needle, otherwise injuries may occur.

- 3** Carefully pull on the loop of thread passed through the eye of the needle to pull out the end of the thread.

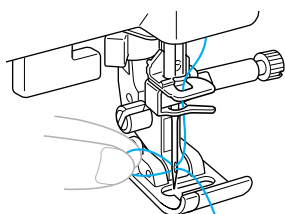

- When embroidering, go to **5**.

- 4** Pass the thread through the presser foot, and then pull out about 10-15 cm (3/8-5/8 inch) of thread toward the rear of the machine.

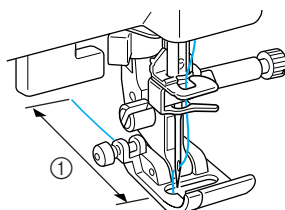

① 10-15 cm (3/8-5/8 inch)

- ▶ The upper threading is finished.

- 5** Close the thread cassette compartment cover.

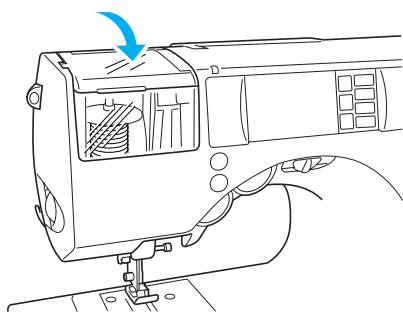

- ▶ Now that the upper threading and the lower threading are finished, you are ready to begin sewing.

- When embroidering, go to **3** in "Embroidering a pattern" (page 134).

Note

- When inserting the thread cassette into its compartment, slowly press it down.
- If the sewing machine could not be threaded, try performing the procedure again starting from loading the spool of thread into the thread cassette.

Using the extra spool pin

When using spools with a size that cannot be loaded into the thread cassette, use the extra spool pin.

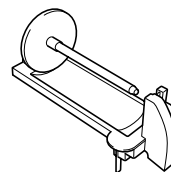

- 1** Place the spool of thread onto the extra spool pin.

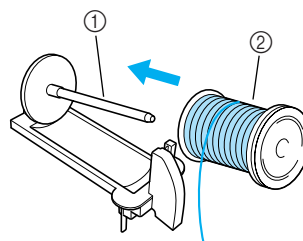

- ① Extra spool pin
- ② Spool

- 2** Slide the spool cap for the size of the spool onto the spool pin.

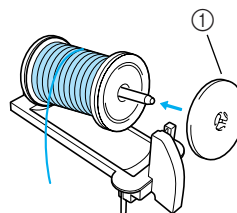

- ① Spool cap

- For more details, refer to "About the spool of thread" (page 21).

- 3** Insert the tabs on the extra spool pin into the holes on the top of the thread cassette.

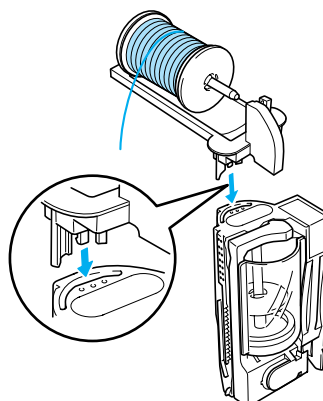

- 4** Thread the thread cassette with the thread from the spool on the extra spool pin.

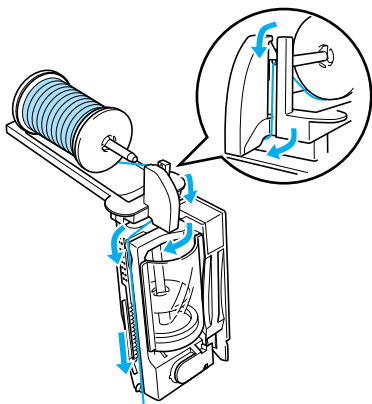

- For more details, refer to "Loading the spool into the thread cassette" (page 22).

- 5** Check that the thread cassette indicator is lit up in green, and insert the thread cassette (with the extra spool pin attached) into the thread cassette compartment.

Use both hands to press down on both sides of the extra spool pin.

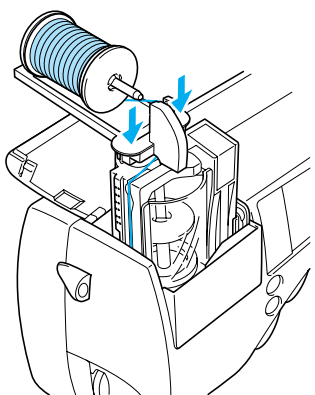

- ▶ At the same time that the thread cassette is inserted, the needle is threaded.
- ▶ The extra spool pin is now installed.

Thread the needle manually (without using the needle threader)

When using special thread, thread with a thickness of 130/20 or thicker, the wing needle or the twin needle which cannot be used with the needle threader, thread the needle as described below.

- 1** Remove the needle.

- Refer to "Replacing the needle" (page 35).
- When using the wing needle, the twin needle or thread that cannot be used with the needle threader, be sure to remove the needle, otherwise the machine may be damaged.

- 2** Check that the thread cassette indicator is lit up in green, and then insert the thread cassette into the thread cassette compartment.

- For details, refer to **1** through **e** (page 25).
- ▶ Pass the thread through the needle bar thread hooks.

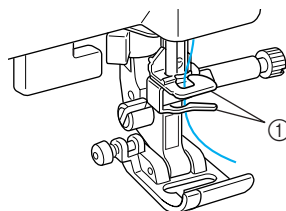

- ① Needle bar thread hooks

- 3** Replace the needle.

- Refer to "Replacing the needle" (page 35).

- 4** Pass the thread through the eye of the needle from front to back.

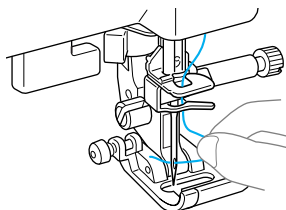

Using the twin needle

Using the twin needle, you can sew two parallel lines of the same stitch with two different colors. Both upper threads should have the same thickness and quality. Be sure to use the twin needle and the extra spool pin. For details on the stitches that can be sewn with the twin needle, refer to "Stitch Settings" (page 64).

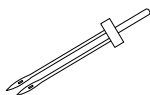

! CAUTION

- Only use the twin needle (Part code : X59296-051). Use of any other needle may bend the needle or damage the machine.
- Never use bent needles. Bent needles can easily break, possibly resulting in injuries.
- Do not try installing the twin needle while the thread cassette is not installed, otherwise the needle may break or damage to the machine may result.

1 Remove the needle.

- For details, refer to "Replacing the needle" (page 35).

2 Load the spool for the first thread color into the thread cassette.

Thread the thread cassette up to arrow 2, indicated on the thread cassette.

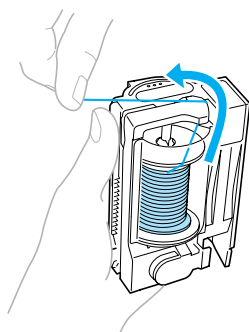

- For more details, refer to steps 1 through 9 in "Loading the spool into the thread cassette" (page 22).

3 Load the spool for the second thread color onto the extra spool pin.

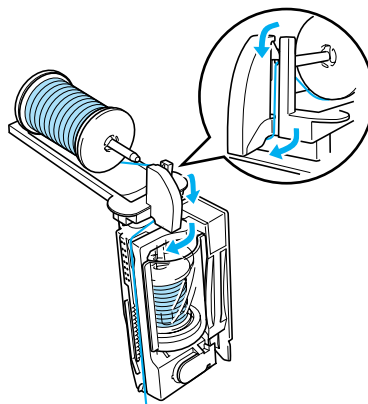

- For more details, refer to steps 1 through 4 in "Using the extra spool pin" (page 27).

4 Use the two threads to thread the thread cassette, and then cut the threads.

Thread the thread cassette along arrows 3 through 6, indicated on the thread cassette.

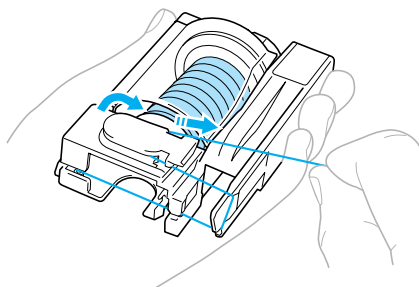

- For more details, refer to steps 10 through 13 in "Loading the spool into the thread cassette" (page 22).

- 5** Insert the thread cassette (with the extra spool pin attached) into the thread cassette compartment.

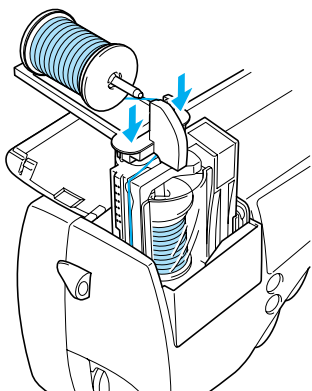

- For more details, refer to step **5** in "Using the extra spool pin" (page 27).
- ▶ Pass both threads through the needle bar thread hooks.
- If the thread cassette is inserted with the twin needle attached, the sewing machine may be damaged.

- 6** Install the twin needle.

- For details, refer to "Replacing the needle" (page 35).

- 7** Manually thread the left needle with the thread for the left side of the stitch.

- For details, refer to "Thread the needle manually (without using the needle threader)" (page 28).

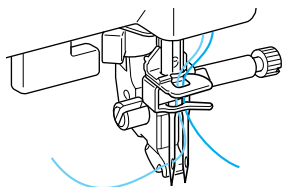

- 8** Remove the thread for the right side of the stitch from only the lower hook of the needle bar thread hooks, and then use it to thread the right needle.

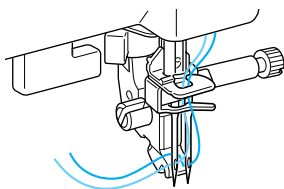

- 9** Attach zigzag foot "J".

- For details on changing the presser foot, refer to "Replacing the Presser Foot" (page 38).

! CAUTION

- When using the twin needle, be sure to attach zigzag foot "J", otherwise the needle may break or the machine may be damaged.

- 10** Turn on the sewing machine and select a stitch.

- For stitch selection see "Selecting stitching" (page 45).
- See "Stitch Settings" (page 64) for stitches that use a twin needle.

! CAUTION

- When using the twin needle, be sure to select an appropriate stitch, otherwise the needle may break or the machine may be damaged.

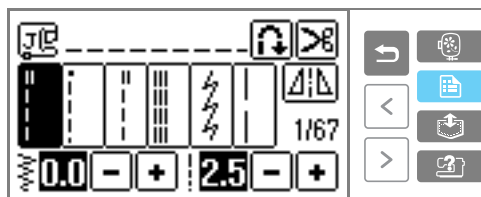

- 11** Press  (Settings key) in the operation panel.



- ▶ The settings screen appears.

- 12** Press .



- ▶  displays in reverse highlight.
- If pressed again, it returns to .
- ▶ The twin needle can now be used.

13 Press  (Back key).

- ▶ The initial screen appears again, and  appears.

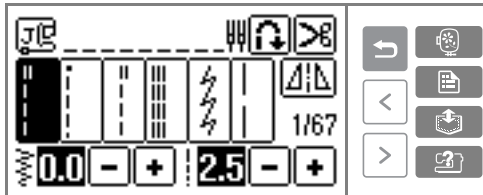

CAUTION

- When using the twin needle, be sure to select the twin needle setting, otherwise the needle may break or the machine may be damaged.

14 Start sewing.

- For details on starting to sew, refer to "Starting to sew" (page 47).
- ▶ Two lines of stitching are sewn parallel to each other.

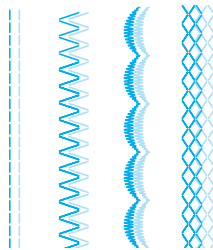

Note

- When changing the sewing direction, press  (Needle position button) to raise the needle from the fabric, and then raise the presser foot lever and turn the fabric.

CAUTION

- Do not try turning the fabric with the twin needle left down in the fabric, otherwise the needle may break or the machine may be damaged.
- When the twin needle mode is selected (), do not turn the balance wheel after removing the thread cassette. Otherwise the needle may break or the machine may be damaged.

Pulling up the bobbin thread

When making gathers or before free-motion quilting, first pull up the bobbin thread as described below.

1 Insert the bobbin into the shuttle.

- Refer to steps 1 through 5 of "Installing the bobbin" (page 19).

2 Pass the bobbin thread through the slot. Do not cut the thread with the cutter.

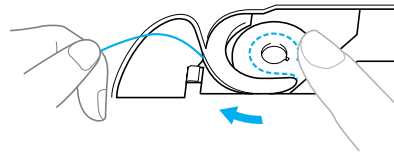

3 While lightly holding the upper thread with your left hand, press  (Needle position button) twice to raise the needle.

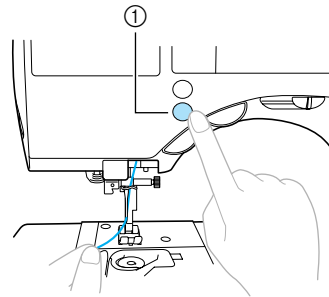

① Needle position button

- ▶ The bobbin thread is looped around the upper thread and can be pulled up.

4 Carefully pull the upper thread upward to pull out the end of the bobbin thread.

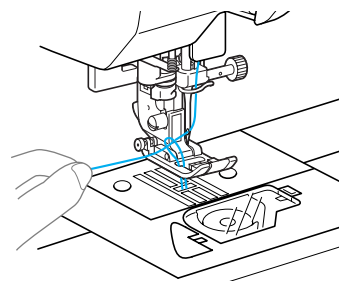

- 5** Pull out about 10-15 cm (4-5 inches) of the bobbin thread under the presser foot toward the rear of the machine.

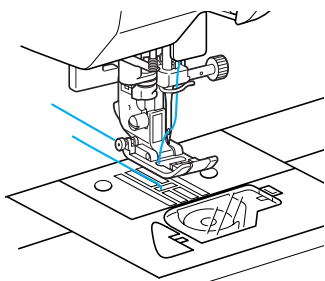

- 6** Reattach the bobbin cover. Insert the tab in the lower-left corner of the bobbin cover, and then lightly press down on the right side.

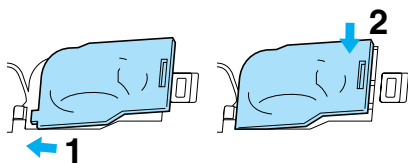

Replacing the Needle

This section provides information on sewing machine needles.

Needle precautions

Be sure to observe the following precautions concerning the handling of the needle. Failure to observe these precautions is extremely dangerous, for example, if the needle breaks and fragments are dispersed. Be sure to read and carefully follow the instructions below.



CAUTION

- **Only use home sewing machine needles. Use of any other needle may bend the needle or damage the machine.**
- **Never use bent needles. Bent needles can easily break, possibly resulting in injuries.**

Needle types and their uses

The sewing machine needle that should be used depends on the fabric and thread thickness. Refer to the following table when choosing the thread and needle appropriate for the fabric that you wish to sew.

Fabric Type/Application		Thread		Size of Needle
		Type	Size	
Medium weight fabrics	Broadcloth	Cotton thread	60–80	75/11–90/14
	Taffeta	Synthetic thread		
	Flannel, Gabardine	Silk thread	50–80	
Thin fabrics	Lawn	Cotton thread	60–80	65/9–75/11
	Georgette	Synthetic thread		
	Challis, Satin	Silk thread	50–80	
Thick fabrics	Denim	Cotton thread	30–50	90/14–100/16
	Corduroy	Synthetic thread	50	
	Tweed	Silk thread		
Stretch fabrics	Jersey	Thread for knits	50–60	Ball point needle (golden colored) 75/11–90/14
	Tricot			
Easily frayed fabrics		Cotton thread	50–80	65/9–90/14
		Synthetic thread		
		Silk thread		
For top-stitching		Synthetic thread	30	90/14–100/16
		Silk thread		

■ Thread and needle number

The lower the thread number is, the larger the thread, and the larger the needle number, the larger the needle.

■ Ball point needle (gold colored)

To avoid skipped stitches use ball point needles with stretch fabrics.

■ Transparent nylon thread

Use a 90/14 to 100/16 needle, regardless of the fabric or thread.

■ Embroidery needles

Use a 75/11 home sewing machine needle. When embroidering on thick fabrics such as denim, use a 90/14 or 100/16 home sewing machine needle.

- A 75/11 needle is already installed when the sewing machine is purchased.

CAUTION

- The appropriate fabric, thread and needle combinations are shown in the table above. If the combination of the fabric, thread and needle is not correct, particularly when sewing thick fabrics (such as denim) with thin needles (such as 65/9 to 75/11), the needle may bend or break. In addition, the stitching may be uneven or puckered or there may be skipped stitches.

Checking the needle

Sewing with a bent needle is extremely dangerous since the needle may break while the machine is being operated.

Before using the needle, place the flat side of the needle on a flat surface and check that the distance between the needle and the flat surface is even.

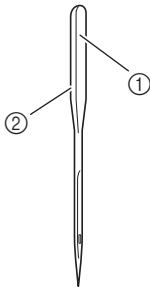

- ① Flat side
- ② Needle type marking

■ Correct needle

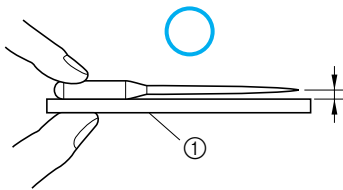

- ① Flat surface

■ Incorrect needle

If the distance between the needle and the flat surface is not even, the needle is bent. Do not use a bent needle.

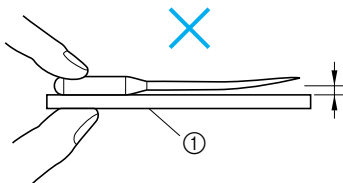

- ① Flat surface

Replacing the needle

Replace the needle as described below. Use the screwdriver and a needle that has been determined to be straight according to the instructions in "Checking the needle".

- 1 Press  (Needle position button) once or twice to raise the needle.

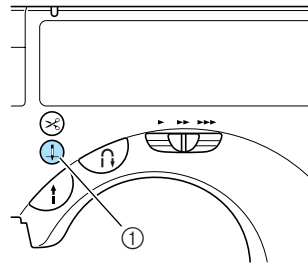

- ① Needle position button

- 2 Turn off the sewing machine.

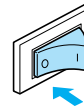

! CAUTION

- Before replacing the needle, be sure to turn off the sewing machine, otherwise injuries may occur if the start/stop button is accidentally pressed and the machine starts sewing.

- 3 Lower the presser foot lever.

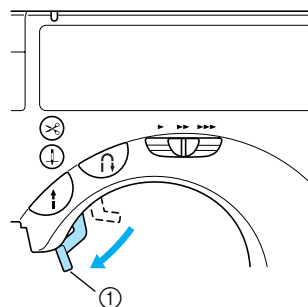

- ① Presser foot lever

- 4** Hold the needle with your left hand, and then use a screwdriver to turn the needle clamp screw counterclockwise to remove the needle.

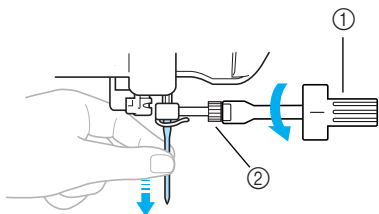

- ① Screwdriver
② Needle clamp screw

- Do not apply a strong force when loosening or tightening the needle clamp screw, otherwise certain parts of the sewing machine may be damaged.

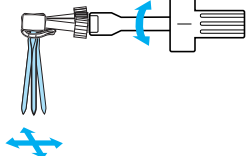

- 5** With the flat side of the needle toward the rear of the machine, insert the needle until it touches the needle stopper.

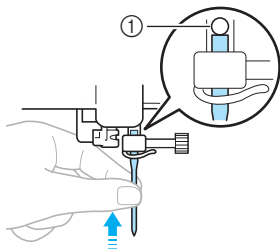

- ① Needle stopper

- 6** While holding the needle with your left hand, use the screwdriver to tighten the needle clamp screw.

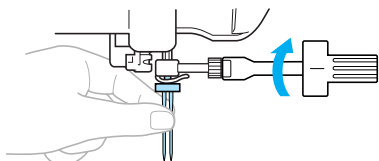

Install the twin needle in the same way.

! CAUTION

- Be sure to insert the needle until it touches the needle stopper and securely tighten the needle clamp screw with the screwdriver, otherwise the needle may break or damage may result.

■ Using the needle-changing tool

Use the needle-changing tool to replace the needle as described below.

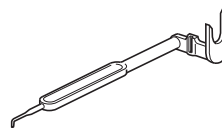

- 1** Place the needle in the hole in the needle-changing tool.

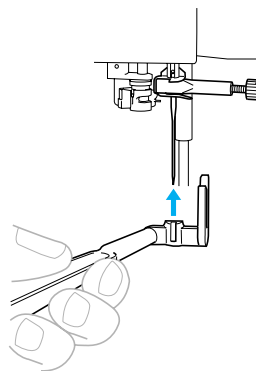

- 2** Lift up the needle-changing tool so that the fork hooks onto the needle clamp screw.

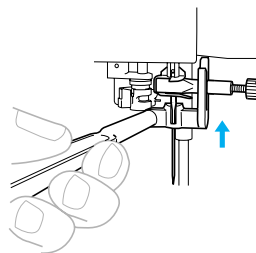

- 3 Using the screwdriver, loosen the needle clamp screw.

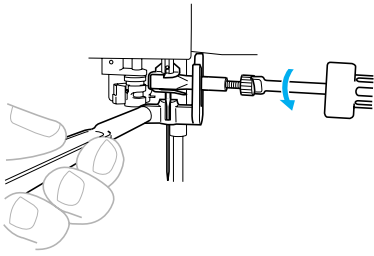

- 4 Lower the needle-changing tool.

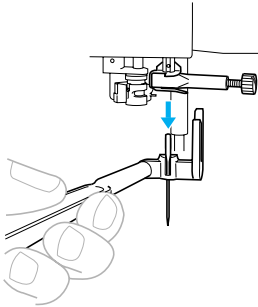

- The needle can be removed from the needle bar.

- 5 Insert the new needle into the hole in the needle-changing tool.
Insert the needle with the flat side of the needle toward the rear of the machine.

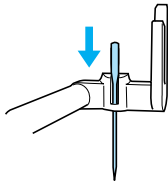

- 6 Lift up the needle-changing tool so that the fork hooks onto the needle clamp screw.

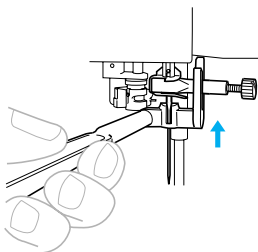

- 7 Insert the needle until it touches the needle stopper, and then use the screwdriver to tighten the needle clamp screw.

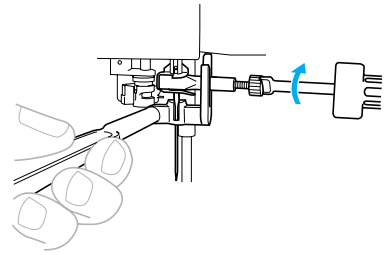

- The needle is installed.

- 8 Lower the needle-changing tool off of the needle.



Note

- The needle-changing tool can not be used for the twin needle.

Replacing the Presser Foot

The presser foot presses down on the fabric.

Presser foot precautions

Be sure to observe the following precautions concerning the presser feet.

! CAUTION

- Use the presser foot appropriate for the type of stitch that you wish to sew, otherwise the needle may hit the presser foot, causing the needle to bend or break.
- Only use presser feet designed specifically for this sewing machine. Use of any other presser foot may result in injuries or damage to the machine.

Replacing the presser foot

Replace the presser foot as described below.

- 1 Press  (Needle position button) once or twice to raise the needle.

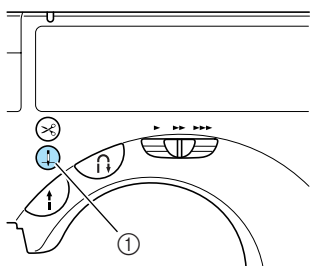

① Needle position button

- If the needle does not move when the needle position button is pressed, an animation is displayed on the LCD. Press the needle position button after touching the LCD.

▶ The needle is raised.

- 2 Turn off the sewing machine.

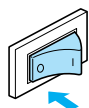

! CAUTION

- Before replacing the presser foot, be sure to turn off the sewing machine, otherwise injuries may occur if the start/stop button is accidentally pressed and the machine starts sewing.

- 3 Raise the presser foot lever.

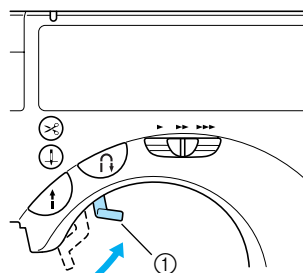

① Presser foot lever

▶ The presser foot is raised.

- 4 Press the black button at the back of the presser foot holder.

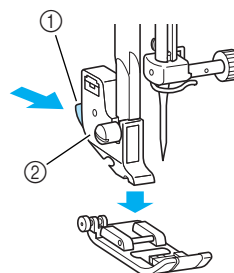

① Black button

② Presser foot holder

▶ The presser foot holder releases the presser foot.

5 Place a different presser foot below the holder so that the presser foot pin is aligned with the notch in the holder.

Position the presser foot so the letter indicating the presser foot type (A, G, I, J, M, N or R) is positioned to be read.

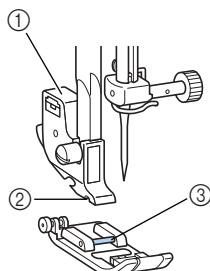

- ① Presser foot holder
- ② Notch
- ③ Pin

6 Slowly lower the presser foot lever so that the presser foot pin snaps into the notch in the presser foot holder.

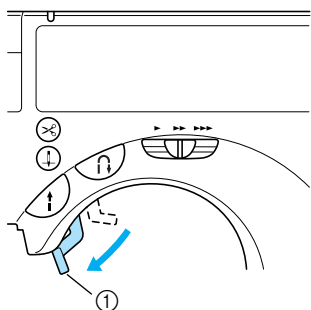

- ① Presser foot lever
- ▶ The presser foot is attached.



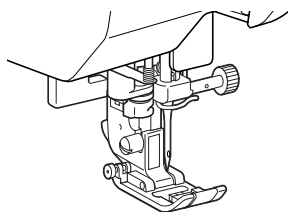

7 Raise the presser foot lever to check that the presser foot is securely attached.

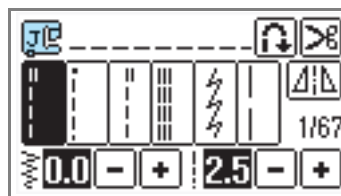

Note

- When a stitch is selected, the icon for the presser foot that should be used appears in the screen. Check that the correct presser foot is attached before starting to sew. If the wrong presser foot is installed, turn off the sewing machine, attach the correct presser foot, and then select the desired stitch again.



-  Buttonhole foot "A"
-  Overcasting foot "G"
-  Zigzag foot "J"
-  Button fitting foot "M"
-  Monogramming foot "N"
-  Blind stitch foot "R"
-  Side cutter "S"
-  Embroidery foot "Q"

- For details on the presser foot that should be used with the selected stitch, refer to "Stitch Settings" (page 64).

Removing the presser foot holder

Remove the presser foot holder when cleaning the sewing machine or when installing a presser foot that does not use the presser foot holder, such as the embroidery foot and quilting foot. Use the screwdriver to remove the presser foot holder.

1 Remove the presser foot.

- For details, refer to "Replacing the presser foot" (page 38).

2 Use the screwdriver to loosen the presser foot holder screw.

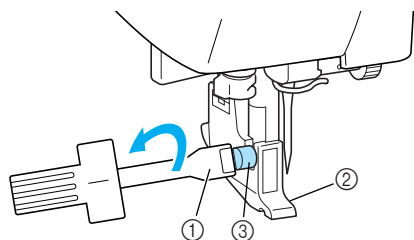

- ① Screwdriver
- ② Presser foot holder
- ③ Presser foot holder screw

■ Attaching the presser foot holder

1 Align the presser foot holder with the lower-left side of the presser bar.

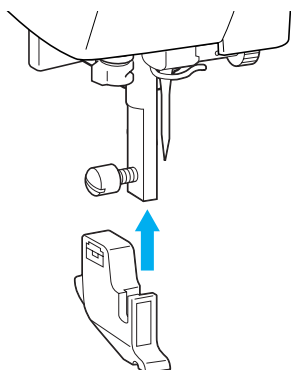

2 Hold the presser foot holder in place with your right hand, and then tighten the screw using the screwdriver in your left hand.

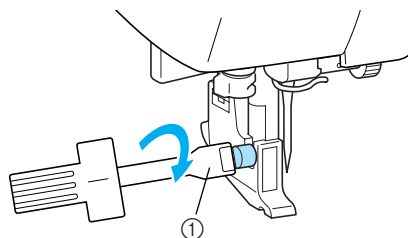

- ① Screwdriver

⚡ Note

- If the presser foot holder is not correctly installed, the thread tension will be incorrect.

Sewing Cylindrical Pieces

Free-arm sewing makes sewing cylindrical pieces easy.

Free-arm sewing

Removing the flap allows for free-arm sewing, making it easier to sew cylindrical pieces such as sleeve cuffs and pant legs.

- 1 Slide the flap off to the left.

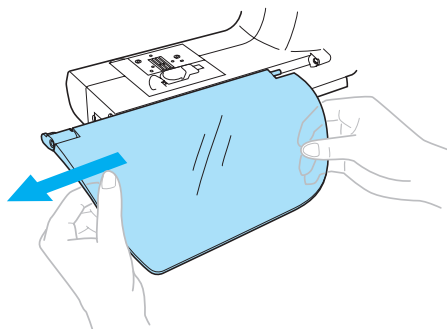

▶ With the flap removed, free-arm sewing is possible.

- 2 Pull the sliding leg (at the bottom of the machine) out toward you.

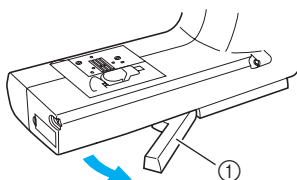

① Sliding leg

- During free-arm sewing, be sure to pull out the sliding leg.

- 3 Slide the part that you wish to sew onto the arm, and then sew from the top.

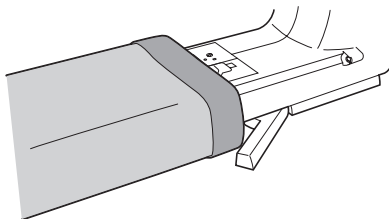

- 4 When you are finished with free-arm sewing, push the sliding leg back into position.

- 5 Then, install the flap back to its original position.

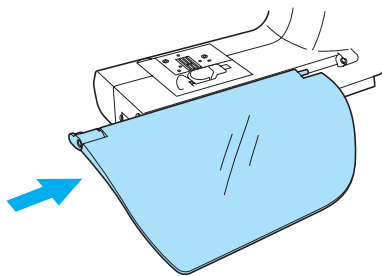



2 SEWING BASICS

The necessary preparations for sewing are described in this chapter.

Sewing.....	44
Adjusting the Thread Tension.....	52
Adjusting the Stitch Width and Length.....	54
Useful Functions.....	56
Useful Sewing Tips	59

Sewing

Basic sewing operations are described below.

Before operating the sewing machine, read the following precautions.

CAUTION

- While the machine is in operation, pay special attention to the needle location. In addition, keep your hands away from all moving parts such as the needle and balance wheel, otherwise injuries may occur.
- Do not pull or push the fabric too hard while sewing, otherwise injuries may occur or the needle may break.
- Never use bent needles. Bent needles can easily break, possibly resulting in injuries.
- Make sure that the needle does not strike basting pins, otherwise the needle may break or bend.

General sewing procedure

Follow the basic procedures below to sew.

1	Turn on the machine.	Turn on the sewing machine. For details on turning on the machine, refer to "Turning on the machine" (page 11).
↓		
2	Select the stitch.	Select the stitch appropriate for the area to be sewn. For details on selecting a stitch, refer to "Selecting stitching" (page 45).
↓		
3	Attach the presser foot.	Attach the presser foot appropriate for the stitch. For details on replacing the presser foot, refer to "Replacing the presser foot" (page 38).
↓		
4	Position the fabric.	Place the area to be sewn under the presser foot. Be sure that the fabric pieces are sewn in the correct order and that the right and wrong sides of the fabric are aligned correctly. For details on positioning the fabric, refer to "Positioning the fabric" (page 46).
↓		
5	Start sewing.	Start sewing. For details on starting to sew, refer to "Starting to sew" (page 47).
↓		
6	Cut the thread.	Cut the thread at the end of sewing. For details on cutting the thread, refer to "Cutting the thread" (page 50).

Selecting stitching

Stitches are selected using LCD operations. There are 67 utility stitches. Right after turning the power on, the straight stitch (left needle position) is selected.

1 Determine the stitch to be used, and get the matching presser foot ready.

- Refer to "Stitch Settings" (page 64).

2 Attach the presser foot.

The machine comes with zigzag foot "J" attached.

- For details, refer to "Replacing the presser foot" (page 38).

CAUTION

- Use the presser foot appropriate for the stitch. If the wrong presser foot is used, the needle may hit the presser foot and break or bend.

3 Turn on the sewing machine.

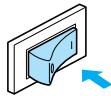

- ▶ The straight stitch (left needle position) is shown selected in the LCD.

4 Press the stitch selection.

< (Previous page key) displays the previous screen, and > (Next page key) displays the next screen.

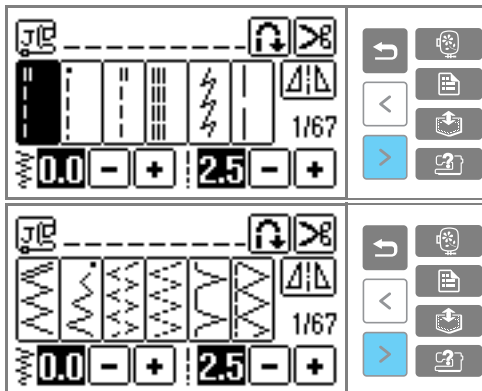

□ Example: 11 is selected:

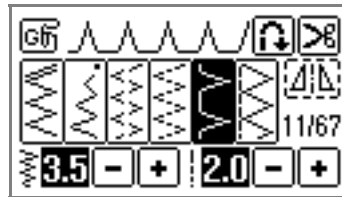

- ▶ The stitch is selected, and the stitch number and settings are displayed.

5 If necessary, specify the setting for automatic reverse/reinforcement stitching and adjust the stitch length, etc.

Memo

- Uses of stitches and other stitch selections are explained in "UTILITY STITCHES" (page 63).
- Automatic reverse/reinforcement stitching and other settings are explained in "Useful Functions" (page 56).

Note

- When a stitch is selected, the icon for the presser foot that should be used appears in the screen. For details, refer to "Replacing the Presser Foot" (page 38). Check that the correct presser foot is attached before starting to sew. If the wrong presser foot is installed, turn off the sewing machine, attach the correct presser foot, and then select the desired stitch again.

Positioning the fabric

Be sure that the fabric pieces are sewn in the correct order and that the right and wrong sides of the fabric are aligned correctly.

- 1 Turn on the sewing machine.

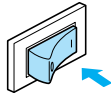

- 2 Press  (Needle position button) once or twice to raise the needle.

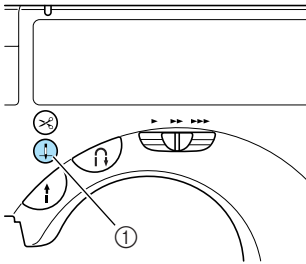

① Needle position button

- 3 Place the fabric under the presser foot.

- If the seam allowance is positioned on the right side, sewing in a straight line is easier and the extra fabric does not get in the way.

- 4 While holding the end of the thread and the fabric with your left hand, turn the balance wheel toward you with your right hand to lower the needle to the starting point of the stitching.

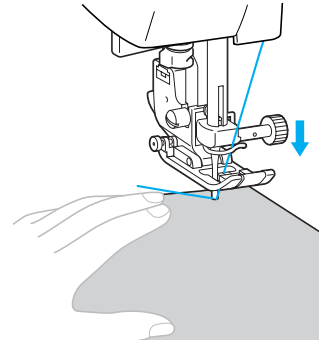
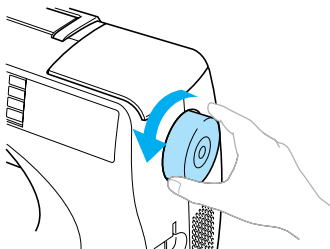

- 5 Lower the presser foot lever.

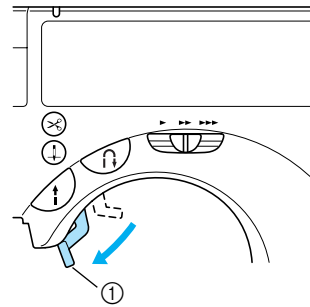

① Presser foot lever

▶ The fabric is now positioned to be sewn.

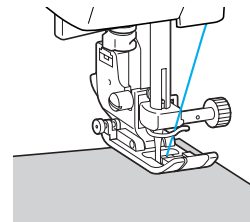

Starting to sew

Once you are ready to start sewing, you can start the sewing machine. The sewing speed can be adjusted using either the sewing speed controller or the foot controller.



Note

- When the foot controller is plugged in, the start/stop button cannot be used to start or stop sewing.

■ Using the operation button

Sewing can be started and stopped using the operation button  (Start/stop button).

① Slide the sewing speed controller to the left or right to select the desired sewing speed.

Slide the sewing speed controller to the left to sew at a slower speed, or slide the speed controller to the right to sew at a faster speed.

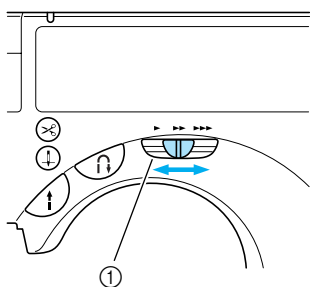

① Sewing speed controller

② Press (Start/stop button) once.

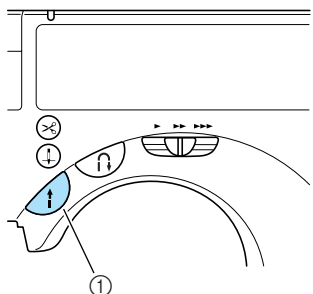

① Start/stop button

- ▶ The machine starts sewing.

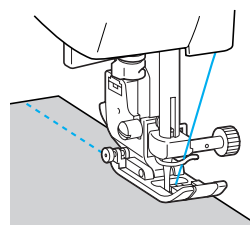

- If you continue to hold the start/stop button pressed immediately after the sewing starts, the machine will sew at a slow speed.

③ When the end of the stitching is reached, press (Start/stop button) once.

- ▶ The machine stops sewing with the needle down (in the fabric).

④ When you have finished sewing, press (Needle position button).

- ▶ The needle is raised.

⑤ Cut the threads.

- For details, refer to "Cutting the thread" (page 50).

■ Using the foot controller

Sewing can be started and stopped using the foot controller.

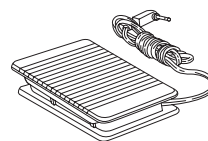

① Turn off the sewing machine.

When connecting the foot controller, be sure to turn off the sewing machine in order to prevent the machine from accidentally being started.

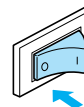

② Insert the foot controller plug into its jack on the back side of the sewing machine.

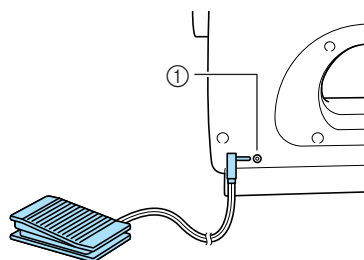

① Foot controller jack

**Note**

(For U.S.A. only)

- Foot controller: Model N5V
This foot controller can be used on this machine model SE-270D.

3 Turn on the sewing machine.

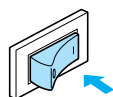

4 Slide the sewing speed controller to the left or right to select the desired sewing speed.

Slide the sewing speed controller to the left to sew at a slower speed, or slide the speed controller to the right to sew at a faster speed.

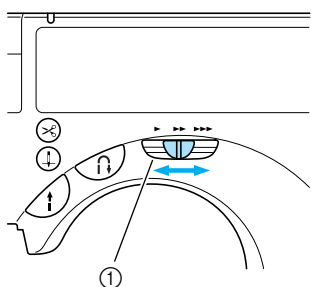

① Sewing speed controller

- The speed set using the sewing speed controller is the foot controller's maximum sewing speed.

5 Once you are ready to start sewing, slowly press down on the foot controller.

Pressing down on the foot controller increases the sewing speed; releasing the pressure on the foot controller decreases the sewing speed.

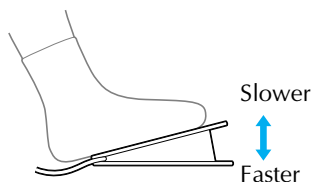

- Slowly press down on the foot controller. Pressing it down hard starts sewing too quickly.

▶ The machine starts sewing.

6 When the end of the stitching is reached, completely release the foot controller.

- ▶ The machine stops sewing with the needle lowered (in the fabric).

7 When you have finished sewing, press (Needle position button).

- ▶ The needle is raised.

8 Cut the threads.

- For details, refer to "Cutting the thread" (page 50).

**Memo**

- When the foot controller is plugged in, the start/stop button cannot be used to start or stop sewing.
- When sewing is stopped, the needle remains lowered (in the fabric). The machine can be set so that the needle will stay up when sewing is stopped. For details on setting the machine so that the needle stays up when sewing is stopped, refer to "Changing the Machine Settings" (page 13).

CAUTION

- Do not allow thread or dust to accumulate in the foot controller, otherwise a fire or an electric shock may occur.
- Do not place objects on the foot controller, otherwise damage to the machine or injuries may occur.
- If the machine is not to be used for a long period of time, unplug the foot controller, otherwise a fire or an electric shock may occur.

Securing the stitching

When sewing with the straight stitch, for example, at the end of an opening or where seams do not overlap, use reverse stitching or enforcement stitching to secure the end of the thread.

- 1 Lower the needle into the fabric at the beginning of the stitching, and then lower the presser foot lever.

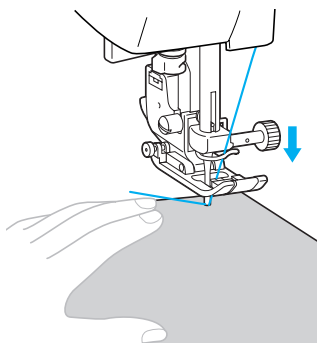

- 2 Press  (Start/stop button) or press down on the foot controller.

At this time, if the start/stop button is held pressed, the machine sews at a low speed.

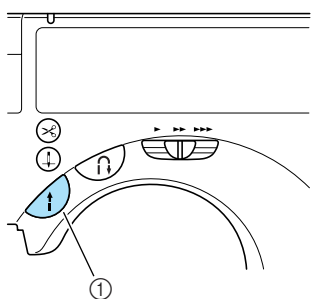

- 1 Start/stop button

- For details, refer to "Starting to sew" (page 47).

▶ The machine starts sewing.

- 3 After sewing 3 to 5 stitches, press  (Reverse/reinforcement stitch button). Keep the reverse/reinforcement stitch button held down until you reach the beginning of the stitching.

- The machine sews at a slow speed when the reverse/reinforcement stitch button is held down.

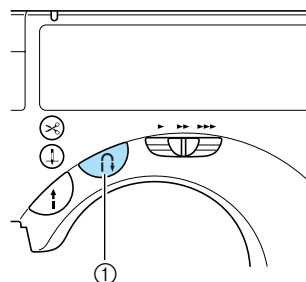

- 1 Reverse/reinforcement stitch button

▶ While the reverse/reinforcement stitch button is held pressed, reverse stitches are sewn.

- 4 After sewing back to the beginning of the stitching, release the reverse/reinforcement stitch button.

▶ The machine stops sewing.

- 5 Press  (Start/stop button), or press down on the foot controller.

▶ The machine starts sewing in the normal sewing direction.

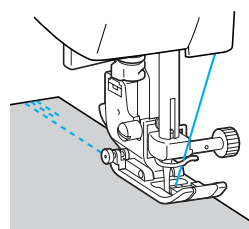

- 6 When the end of the stitching is reached, press  (Reverse/reinforcement stitch button).

Keep the reverse/reinforcement stitch button held down until 3 to 5 reverse stitches are sewn.

▶ While the reverse/reinforcement stitch button is depressed, reverse stitches are sewn.

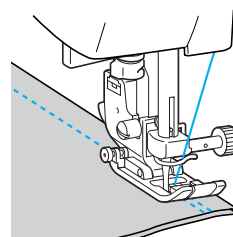

7 After 3 to 5 reverse stitches have been sewn, release  (Reverse/reinforcement stitch button).

▶ The machine stops sewing.

8 Press , or press down on the foot controller.

At this time, if the start/stop button is held pressed, the machine sews at a low speed.

▶ The machine starts sewing in the normal sewing direction.

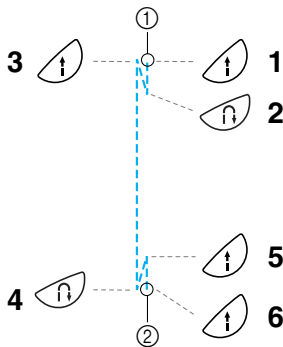

9 After sewing to the end of the stitching, the sewing machine stops.

Release the start/stop button or foot controller.



① Beginning of stitching
② End of stitching

■ Sewing stitches

Reverse stitches are set for the 1 , 3  and 7  stitches.

When  (Reverse/reinforcement stitch button) is pressed with stitches other than these, reinforcement stitches are used. Reinforcement stitches are 3 to 5 stitches sewn on top of each other in one place.

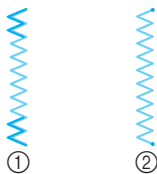

① Reverse stitching
② Reinforcement stitching

 Memo

- The sewing machine can be set to automatically sew reverse or reinforcement stitches at the beginning and end of the stitching. For details, refer to "Automatically sewing reverse/reinforcement stitches" (page 56).

Cutting the thread

When you have finished sewing, cut the threads.

■ Using the thread cutter button

1 When you wish to finish the stitching, press  (Thread cutter button) once.

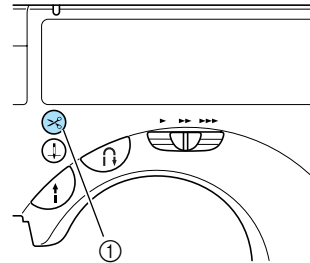

① Thread cutter button

▶ The threads are cut and the needle is raised.

2 Raise the presser foot lever, then remove the fabric.

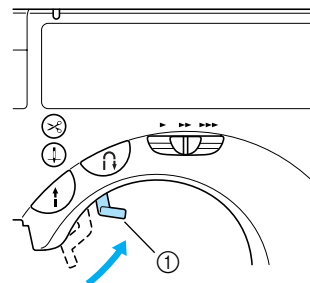

① Presser foot lever

 CAUTION

- Do not press the thread cutter button after the threads have already been cut, otherwise the needle may break, the threads may become tangled or damage to the machine may occur.
- Do not press the thread cutter button if there is no fabric under the presser foot or while the machine is sewing, otherwise damage to the machine may occur.



Memo

- The machine can be set so that the threads will be cut when sewing is finished. For details on setting the machine so that the threads are cut automatically, refer to "Automatically cutting the thread" (page 57).

■ Using the thread cutter

When sewing with thread thicker than #30, nylon or metallic threads, or other special threads, use the thread cutter on the side of the machine to cut the threads.

- 1 When you wish to finish the stitching and the sewing machine is stopped, press  (Needle position button) once.

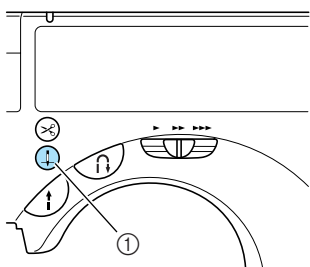

- 1 Needle position button
- ▶ The needle is raised.

- 2 Raise the presser foot lever.

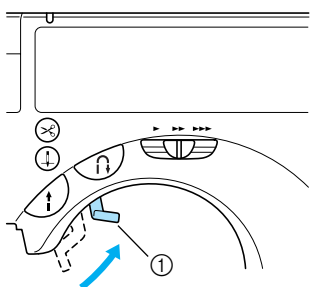

- 1 Presser foot lever

- 3 Pull the fabric to the left side of the machine, and then pass the threads through the thread cutter to cut them.

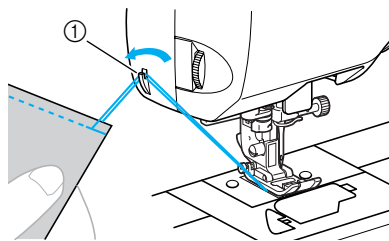

- 1 Thread cutter

Adjusting the Thread Tension

The tensions of the upper thread and of the bobbin thread (thread tension) should be adjusted so that they are equal.

Thread tension

You may need to change the thread tension, depending on the fabric and thread being used.

■ Correct thread tension

The upper thread and the bobbin thread should cross near the center of the fabric. Only the upper thread should be visible from the right side of the fabric, and only the bobbin thread should be visible from the wrong side of the fabric.

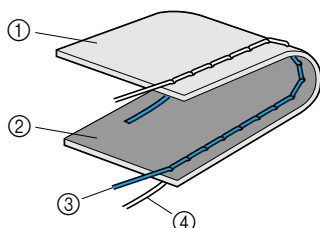

- ① Wrong side of fabric
- ② Right side of fabric
- ③ Upper thread
- ④ Bobbin thread

■ Upper thread is too tight

If the bobbin thread is visible from the right side of the fabric, the upper thread is too tight.

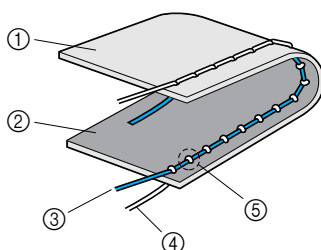

- ① Wrong side of fabric
- ② Right side of fabric
- ③ Upper thread
- ④ Bobbin thread
- ⑤ The bobbin thread is visible from the right side of the fabric.

Turn the thread tension dial downward to a lower number to loosen the upper thread.

■ Upper thread is too loose

If the upper thread is visible from the wrong side of the fabric, the upper thread is too loose.

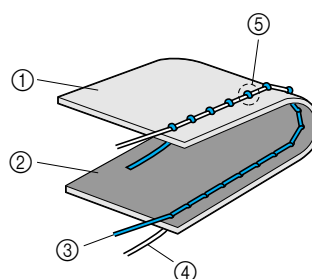

- ① Wrong side of fabric
- ② Right side of fabric
- ③ Upper thread
- ④ Bobbin thread
- ⑤ The upper thread is visible from the wrong side of the fabric.

Turn the thread tension dial upward to a higher number to tighten the upper thread.

Changing the upper thread tension

The tension is changed using the thread tension dial on the left side of the sewing machine.

- 1 Test the stitching using a scrap of the actual fabric to be used.
- 2 Referring to the illustration below, turn the thread tension dial on the left side of the sewing machine.
The larger the number is, the greater the upper thread tension.

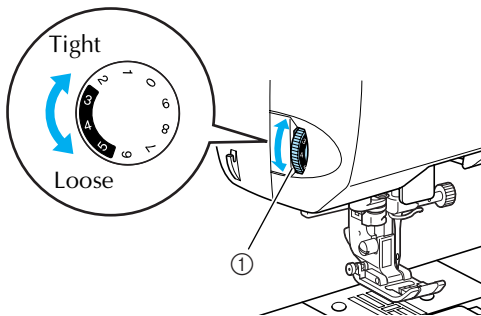

① Thread tension dial

- 3 Test it until the thread tension is suitable.



Memo

- Recommended tension setting for normal stitching is 3-4-5 within the shaded area of the upper tension dial.

Adjusting the Stitch Width and Length

The stitch width and length can be adjusted. Normally, when a stitch is selected, the appropriate width and length are automatically selected.

Adjusting the stitch width

The zigzag width can be adjusted on the LCD.

1 Turn on the sewing machine.

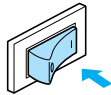

▶ The LCD comes on.

2 Select a stitch.

▶ A screen containing settings for the selected stitch appears.

- For details on selecting a stitch, refer to "Selecting stitching" (page 45).
- Immediately after the stitch is selected, the standard settings (highlighted) appear.

3 To make the stitch width narrower, press **-**. To make the stitch width wider, press **+**.

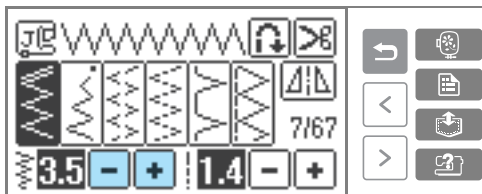

▶ The stitch width is changed.

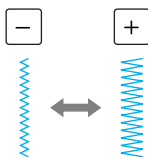

- If the setting is changed, the highlighted value is erased.



Memo

- To reset the stitch width to its standard setting, select the same stitch again or change the setting to the highlighted value.
- If the straight stitch (left needle position or triple stretch stitch) was selected, changing the stitch width changes the needle position. Increasing the width moves the needle to the right; reducing the width moves the needle to the left.
- The sewing machine can be set so that the stitch width can easily be changed with the sewing speed controller. For details, refer to "Satin stitching" (page 97).
-  means the setting cannot be adjusted.

CAUTION

- After adjusting the stitch width, slowly turn the balance wheel toward you and check that the needle does not touch the presser foot. If the needle hits the presser foot, the needle may bend or break.

Adjusting the stitch length

The stitch length can be adjusted on the LCD.

1 Turn on the sewing machine.

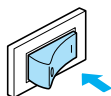

▶ The LCD comes on.

2 Select a stitch.

▶ A screen containing settings for the selected stitch appears.

- For details on selecting a stitch, refer to "Selecting stitching" (page 45).
- Immediately after the stitch is selected, the standard settings (highlighted) appear.

3 To make the stitch length shorter, press **-**. To make the stitch length longer, press **+**.

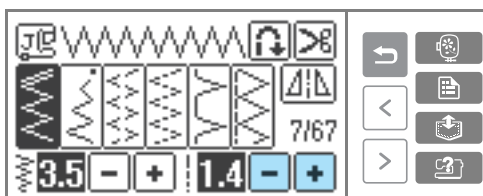

▶ The stitch length is changed.

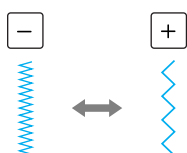

- If the setting is changed, the highlighted value is erased.

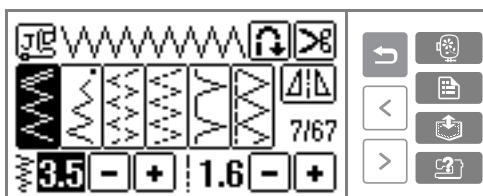

Memo

- To reset the stitch length to its standard setting, select the same stitch again or change the setting to the highlighted value.
-  means the setting cannot be adjusted.

CAUTION

- If the stitches are bunched together, increase the stitch length. Continuing to sew with the stitches bunched together may result in the needle bending or breaking.

2

Useful Functions

Functions useful in improving sewing efficiency are described below.

Automatically sewing reverse/reinforcement stitches

The sewing machine can be set to automatically sew reverse or reinforcement stitches at the beginning and end of the stitching. Whether reverse stitches or reinforcement stitches are sewn depends on the stitch that is selected. For details, refer to "Stitch Settings" (page 64).

1 Turn on the sewing machine.

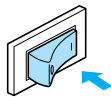



- ▶ The LCD comes on.

2 Select a stitch.

- For details on selecting a stitch, refer to "Selecting stitching" (page 45).

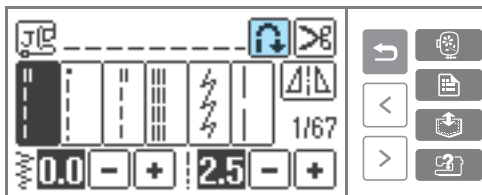
3 Press on the LCD.



- ▶ It turns to , and the sewing machine is set for automatic reverse/reinforcement stitching.

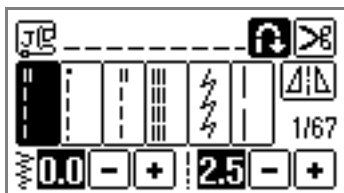

- To turn automatic reverse/reinforcement stitching off, press .
- When the sewing machine is turned off, the automatic reverse/reinforcement stitching setting is cancelled.

4 Position the fabric under the presser foot, and then press (Start/stop button) once.

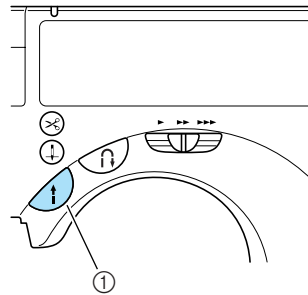

- ① Start/stop button

- ▶ After reverse/reinforcement stitches are sewn, the machine starts sewing.

5 After reaching the end of the stitching, press (Reverse/reinforcement stitch button) once.

This step is not necessary if a stitch such as those for sewing buttonholes and bar tacks is selected where reinforcement stitches are automatically sewn.

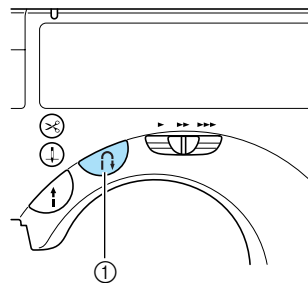

- ① Reverse/reinforcement stitch button

- ▶ After reverse/reinforcement stitches are sewn, the sewing machine stops.

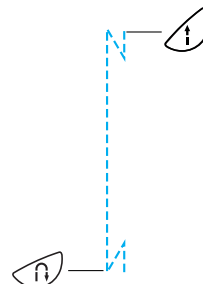



Memo

- Reverse/reinforcement stitches will not be sewn if the start/stop button is pressed at the end of the stitching. Be sure to press the reverse/reinforcement stitch button at the end of the stitching.

Automatically cutting the thread

The sewing machine can be set to automatically cut the threads at the end of the stitching. This is called "programmed thread-cutting". If programmed thread-cutting is set, automatic reverse/reinforcement stitching is also set.

- 1 Turn on the sewing machine.

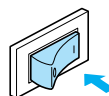



- ▶ The LCD comes on.

- 2 Select a stitch.

- For details on selecting a stitch, refer to "Selecting stitching" (page 45).

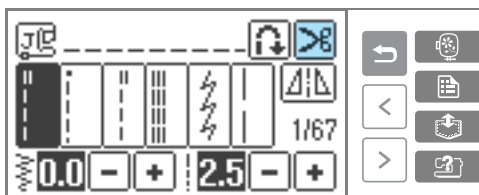
- 3 Press  on the LCD.



- ▶ You get  , and the sewing machine is set for programmed thread-cutting and automatic reverse/reinforcement stitching.

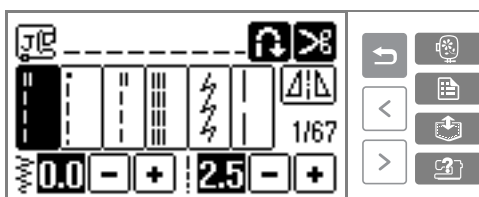

- To turn programmed thread cutting off, press .

- 4 Set the fabric in place, and press  (Start/stop button) once.

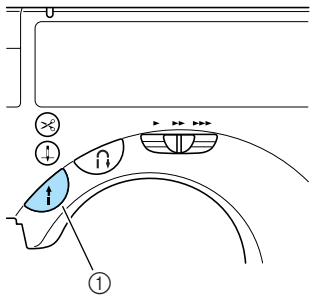

- ▶ Stitching starts after reverse stitching or reinforcement stitching.

- 5 Once you have reached the end of the stitching, press  (Reverse/reinforcement stitch button) once.

If stitching, such as buttonholes and bar tacking, that includes reinforcement stitching has been selected, this operation is unnecessary.

- ▶ After the reverse stitching or reinforcement stitching has been done, the sewing machine stops, and the thread is cut.

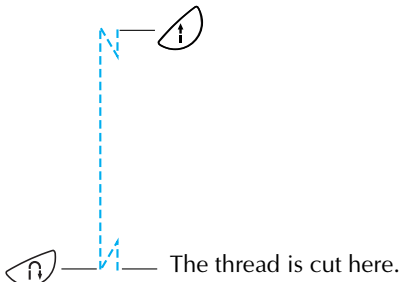

Memo

- Programmed thread-cutting will not be performed if the start/stop button is pressed while sewing. Press the reverse/reinforcement stitch button at the end of the stitching.
- If the power is turned off, programmed thread-cutting will be turned off.

Mirroring stitches

You can sew the mirror image of a stitch horizontally (left and right).

- 1 Turn on the sewing machine.

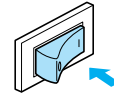



- ▶ The LCD comes on.

- 2 Select a stitch.

- For details on selecting a stitch, refer to "Selecting stitching" (page 45).

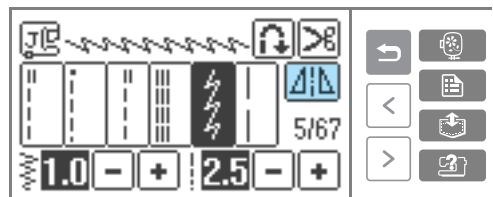
- 3 Press  on the LCD.



- ▶ It turns to , and the pattern is mirrored.

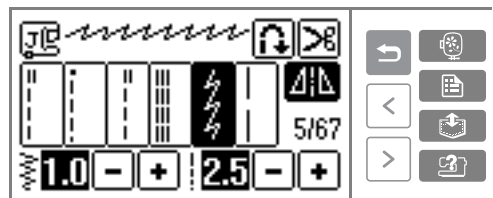

- To turn the mirrored stitching off, press .

Memo

- Mirroring is not possible for buttonholes and other stitches where  shows.
- When the sewing machine is turned off, the mirroring setting is cancelled.

Useful Sewing Tips

Various ways to achieve better results for your sewing projects are described below. Refer to these tips when sewing your project.

Trial sewing

After you have set up the machine with the thread and needle appropriate for the type of fabric being sewn, the machine automatically sets the thread tension and stitch length and width for the stitch that is selected. However, a trial piece of fabric should be sewn since, depending on the type of fabric and stitching being sewn, the desired results may not be achieved.

For the trial sewing, use a piece of fabric and thread that are the same as those used for your project, and check the thread tension and stitch length and width. Since the results differ depending on the type of stitching and the number of layers of fabric sewn, perform the trial sewing under the same conditions that will be used with your project.

Changing the sewing direction

1 When the stitching reaches a corner, stop the sewing machine.
Leave the needle lowered (in the fabric). If the needle remained up when the machine stopped sewing, press  (Needle position button) to lower the needle.

2 Raise the presser foot lever, and then turn the fabric.
Turn the fabric using the needle as a pivot.

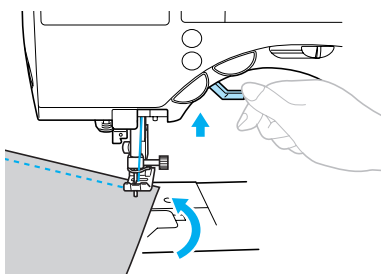

3 Lower the presser foot lever and continue sewing.

Sewing curves

Stop sewing, and then slightly change the sewing direction to sew around the curve. For details on sewing with an even seam allowance, refer to "Sewing an even seam allowance" (page 61).

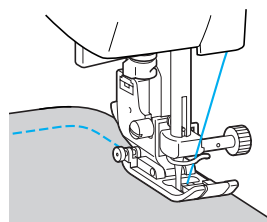

When sewing along a curve while using a zigzag stitch, select a shorter stitch length in order to obtain a finer stitch.

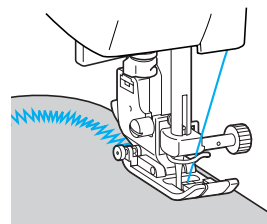

Sewing thick fabrics

■ If the fabric does not fit under the presser foot

If the fabric does not fit easily under the presser foot, raise the presser foot lever even higher to bring the presser foot to its highest position.

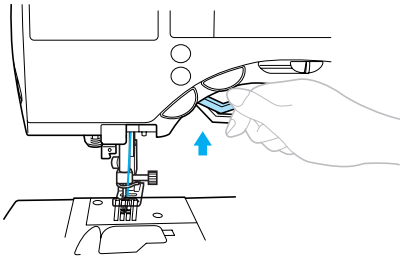

■ If thick seams are being sewn and the fabric does not feed at the beginning of stitching

Zigzag foot "J" is equipped with a feature that keeps the presser foot level.

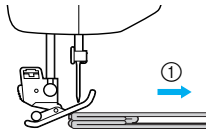

① Sewing direction

1 When you encounter a seam that is too thick to feed under the foot, raise the presser foot lever.

2 Press the black button (Presser foot holding pin) on the left side of zigzag foot "J". Keep the button held in and lower the presser foot.

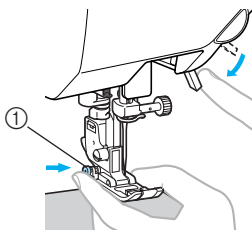

① Presser foot holding pin

▶ Release the button. The foot will lock in place level with the seam, allowing the fabric to feed.

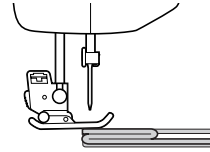

▶ Once the trouble spot has been passed, the foot will return to its normal position.

! CAUTION

● If fabric more than 6 mm (15/64 inch) thick is sewn or if the fabric is pushed with too much force, the needle may bend or break.

Sewing thin fabrics

When sewing thin fabrics, the stitching may become misaligned or the fabric may not feed correctly. If this occurs, place thin paper or stabilizer material under the fabric and sew it together with the fabric. When you have finished sewing, tear off any excess paper.

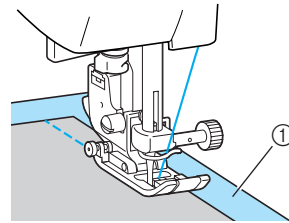

① Stabilizer material or paper

Sewing stretch fabrics

First, baste the pieces of fabric together, and then sew without stretching the fabric.

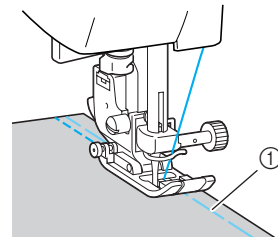

① Basting

Besides, using the stretch stitching or the thread for knits gives an attractive finishes.

Sewing an even seam allowance

To sew an even seam, start sewing so that the seam allowance is to the right of the presser foot, and the edge of the fabric is aligned with either the right edge of the presser foot or a marking on the needle plate.

■ Aligning the fabric with the presser foot

Sew while keeping the right edge of the presser foot a fixed distance from the edge of the fabric.

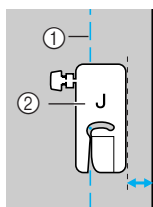

- ① Seam
- ② Presser foot

■ Aligning the fabric with a needle plate marking

The markings on the needle plate show the distance from the needle position of a seam sewn with the straight stitch (left needle position). Sew while keeping the edge of the fabric aligned with a marking in the needle plate. The distance between the markings in the upper scale is 1/8 inch (3 mm) and the distance between the markings in the grid is 5 mm (3/16 inch).

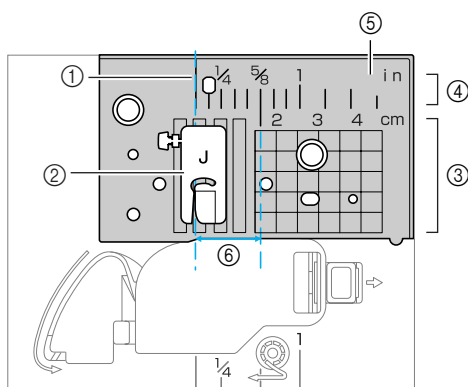

- ① Seam
- ② Presser foot
- ③ Centimeters
- ④ Inches
- ⑤ Needle plate
- ⑥ 16 mm (5/8 inch)



UTILITY STITCHES

















The various stitches and their applications are described in this chapter.

- Stitch Settings.....64**
- Overcasting Stitches.....69**
- Basic Stitching.....73**
- Blind Hem Stitching75**
- Buttonhole Stitching.....77**
- Zipper Insertion.....84**
- Sewing Stretch Fabrics and Elastic Tape.....89**
- Appliqué, Patchwork and Quilt Stitching91**
- Reinforcement Stitching98**
- Eyelet Stitching.....102**
- Decorative Stitching.....103**













Stitch Settings













Applications, stitch lengths and widths and whether the twin needle can be used are listed for utility stitches in the following table.





















Utility stitches







Stitch Name	Pattern	Presser Foot	Application	Stitch Width [mm (inch.)]		Stitch Length [mm (inch.)]		Twin Needle	Reverse/Reinforcement Stitching	Walking Foot	
				Auto	Manual	Auto	Manual				
Straight stitch	Left		J	Basic stitching, sewing gathers or pintucks, etc.	0.0 (0)	0.0–7.0 (0–1/4)	2.5 (3/32)	0.2–5.0 (1/64–3/16)	Yes	Reverse	No
			J	Basic stitching and sewing gathers or pintucks	0.0 (0)	0.0–7.0 (0–1/4)	2.5 (3/32)	0.2–5.0 (1/64–3/16)	Yes	Reinforcement	Yes
	Center		J/I	Attaching zippers, basic stitching, sewing gathers or pintucks, etc.	–	–	2.5 (3/32)	0.2–5.0 (1/64–3/16)	Yes	Reverse	Yes*
Triple stretch stitch		J	Attaching sleeves, sewing inseams, sewing stretch fabrics and decorative stitching	0.0 (0)	0.0–7.0 (0–1/4)	2.5 (3/32)	1.5–4.0 (1/16–3/16)	Yes	Reinforcement	No	
Stretch stitch		J	Sewing stretch fabrics and decorative stitching	1.0 (1/16)	1.0–3.0 (1/16–1/8)	2.5 (3/32)	1.0–4.0 (1/16–3/16)	Yes	Reinforcement	No	
Basting stitch		J	Temporarily securing	0.0 (0)	0.0–7.0 (0–1/4)	–	–	No	Reinforcement	No	
Zigzag stitch	Center		J	Overcasting and attaching appliques	3.5 (1/8)	0.0–7.0 (0–1/4)	1.4 (1/16)	0.0–4.0 (0–3/16)	Yes	Reverse	No
	Right		J	Beginning sewing from the right needle position	3.5 (1/8)	2.5–5.0 (3/32–3/16)	1.4 (1/16)	0.3–4.0 (1/64–3/16)	Yes	Reinforcement	Yes
2-point zigzag stitch		J	Overcasting on mediumweight or stretch fabrics, attaching elastic, darning, etc.	5.0 (3/16)	1.5–7.0 (1/16–1/4)	1.0 (1/16)	0.2–4.0 (1/64–3/16)	Yes	Reinforcement	Yes	
3-point zigzag stitch		J	Overcasting on mediumweight or stretch fabrics, attaching elastic, darning, etc.	5.0 (3/16)	1.5–7.0 (1/16–1/4)	1.0 (1/16)	0.2–4.0 (1/64–3/16)	Yes	Reinforcement	No	
Overcasting stitch		G	Overcasting on thin or mediumweight fabrics	3.5 (1/8)	2.5–5.0 (3/32–3/16)	2.0 (1/16)	1.0–4.0 (1/16–3/16)	No	Reinforcement	No	
		G	Overcasting on thick fabrics	5.0 (3/16)	2.5–5.0 (3/32–3/16)	2.5 (3/32)	1.0–4.0 (1/16–3/16)	No	Reinforcement	No	
		G	Overcasting on thick fabrics and decorative stitching	5.0 (3/16)	3.5–5.0 (1/8–3/16)	2.5 (3/32)	1.0–4.0 (1/16–3/16)	No	Reinforcement	No	
		J	Overcasting on stretch fabrics	5.0 (3/16)	0.0–7.0 (0–1/4)	2.5 (3/32)	0.5–4.0 (1/32–3/16)	Yes	Reinforcement	No	
		J	Overcasting on thick or stretch fabrics	5.0 (3/16)	0.0–7.0 (0–1/4)	2.5 (3/32)	0.5–4.0 (1/32–3/16)	Yes	Reinforcement	No	
		J	Overcasting on stretch fabrics and decorative stitching	4.0 (3/16)	0.0–7.0 (0–1/4)	4.0 (3/16)	1.0–4.0 (1/16–3/16)	Yes	Reinforcement	No	

* Do not use reverse stitching.

Stitch Name	Pattern	Presser Foot	Application	Stitch Width [mm (inch.)]		Stitch Length [mm (inch.)]		Twin Needle	Reverse/Reinforcement Stitching	Walking Foot
				Auto	Manual	Auto	Manual			
Blind hem stitch		R	Blind hem stitching on mediumweight fabrics	0.0 (0)	3← - 3→	2.0 (1/16)	1.0-3.5 (1/16-1/8)	No	Reinforcement	No
		R	Blind hem stitching on stretch fabrics	0.0 (0)	3← - 3→	2.0 (1/16)	1.0-3.5 (1/16-1/8)	No	Reinforcement	No
Appliqué stitch		J	Appliqué stitching	3.5 (1/8)	2.5-5.0 (3/32-3/16)	2.5 (3/32)	1.6-4.0 (1/16-3/16)	Yes	Reinforcement	No
Shell tuck stitch		J	Shell tuck stitching	4.0 (3/16)	0.0-7.0 (0-1/4)	2.5 (3/32)	0.2-4.0 (1/64-3/16)	Yes	Reinforcement	No
Satin scallop stitch		N	Scallop stitching	5.0 (3/16)	2.5-7.0 (3/32-1/4)	0.5 (1/32)	0.1-1.0 (1/64-1/16)	Yes	Reinforcement	No
Joining stitch		J	Patchwork stitching and decorative stitching	4.0 (3/16)	0.0-7.0 (0-1/4)	1.2 (1/16)	0.2-4.0 (1/64-3/16)	Yes	Reinforcement	No
		J	Patchwork stitching, decorative stitching and sewing overcasting on both pieces of fabric, such as with tricot	5.0 (3/16)	2.5-7.0 (3/32-1/4)	2.5 (3/32)	1.0-4.0 (1/16-3/16)	Yes	Reinforcement	No
		J	Patchwork stitching and decorative stitching	5.0 (3/16)	0.0-7.0 (0-1/4)	1.2 (1/16)	0.2-4.0 (1/64-3/16)	Yes	Reinforcement	No
Smocking stitch		J	Smocking stitching and decorative stitching	5.0 (3/16)	0.0-7.0 (0-1/4)	1.6 (1/16)	1.0-4.0 (1/16-3/16)	Yes	Reinforcement	No
Fagoting stitch		J	Fagoting and decorative stitching	5.0 (3/16)	0.0-7.0 (0-1/4)	2.5 (3/32)	1.0-4.0 (1/16-3/16)	Yes	Reinforcement	No
		J	Fagoting and decorative stitching	5.0 (3/16)	2.5-7.0 (3/32-1/4)	2.5 (3/32)	1.0-4.0 (1/16-3/16)	Yes	Reinforcement	No
Elastic-attaching stitch		J	Attaching elastic to stretch fabrics	4.0 (3/16)	0.0-7.0 (0-1/4)	1.0 (1/16)	0.2-4.0 (1/64-3/16)	Yes	Reinforcement	No

Stitch Name	Pattern	Presser Foot	Application	Stitch Width [mm (inch.)]		Stitch Length [mm (inch.)]		Twin Needle	Reverse/Reinforcement Stitching	Walking Foot
				Auto	Manual	Auto	Manual			
Decorative stitch		J	Decorative stitching	4.0 (3/16)	0.0–7.0 (0–1/4)	3.0 (1/8)	2.0–4.0 (1/16–3/16)	No	Reinforcement	No
		J	Decorative stitching	4.0 (3/16)	0.0–7.0 (0–1/4)	2.5 (3/32)	1.0–4.0 (1/16–3/16)	Yes	Reinforcement	No
		J	Decorative stitching	5.5 (7/32)	0.0–7.0 (0–1/4)	1.6 (1/16)	1.0–4.0 (1/16–3/16)	Yes	Reinforcement	No
		N	Decorative stitching and elastic-attaching	5.0 (3/16)	1.5–7.0 (1/16–1/4)	1.0 (1/16)	0.2–4.0 (1/64–3/16)	Yes	Reinforcement	No
		N	Lace sewing, decorative hemming, heirloom stitching, etc.	3.5 (1/8)	1.5–7.0 (1/16–1/4)	2.5 (3/32)	1.6–4.0 (1/16–3/16)	No	Reinforcement	No
		N	Decorative hemming, heirloom stitching, etc.	6.0 (15/64)	1.5–7.0 (1/16–1/4)	3.0 (1/8)	1.5–4.0 (1/16–3/16)	No	Reinforcement	No
		N	Decorative hemming on thin, mediumweight and plain weave fabrics, heirloom stitching, etc.	5.0 (3/16)	1.5–7.0 (1/16–1/4)	3.5 (1/8)	1.5–4.0 (1/16–3/16)	No	Reinforcement	No
		N	Decorative hemming on thin, mediumweight and plain weave fabrics, heirloom stitching, etc.	5.0 (3/16)	1.5–7.0 (1/16–1/4)	4.0 (3/16)	1.5–4.0 (1/16–3/16)	Yes	Reinforcement	No
		N	Decorative hemming on thin, mediumweight and plain weave fabrics, heirloom stitching, etc.	5.0 (3/16)	1.5–7.0 (1/16–1/4)	2.5 (3/32)	1.5–4.0 (1/16–3/16)	Yes	Reinforcement	No
		N	Decorative hemming on thin, mediumweight and plain weave fabrics, heirloom stitching, etc.	5.0 (3/16)	1.5–7.0 (1/16–1/4)	2.0 (1/16)	1.5–4.0 (1/16–3/16)	Yes	Reinforcement	No
		N	Decorative hemming, ribbon threading, heirloom stitching, etc.	5.0 (3/16)	1.5–7.0 (1/16–1/4)	3.0 (1/8)	1.5–4.0 (1/16–3/16)	Yes	Reinforcement	No
		N	Decorative stitching, smocking stitching, heirloom stitching, etc.	6.0 (15/64)	1.5–7.0 (1/16–1/4)	1.6 (1/16)	1.0–4.0 (1/16–3/16)	No	Reinforcement	No
		N	Decorative stitching, smocking stitching, heirloom stitching, etc.	5.0 (3/16)	1.5–7.0 (1/16–1/4)	1.6 (1/16)	1.0–4.0 (1/16–3/16)	No	Reinforcement	No

Stitch Name	Pattern	Presser Foot	Application	Stitch Width [mm (inch.)]		Stitch Length [mm (inch.)]		Twin Needle	Reverse/Reinforcement Stitching	Walking Foot
				Auto	Manual	Auto	Manual			
Buttonhole stitch		A	Horizontal buttonholes on thin and mediumweight fabrics	5.0 (3/16)	3.0–5.0 (1/8–3/16)	0.4 (1/64)	0.2–1.0 (1/64–1/16)	No	Automatic reinforcement	No
		A	Horizontal buttonholes on areas that are subject to strain	5.0 (3/16)	3.0–5.0 (1/8–3/16)	0.4 (1/64)	0.2–1.0 (1/64–1/16)	No	Automatic reinforcement	No
		A	Horizontal buttonholes on thick fabrics	5.0 (3/16)	3.0–5.0 (1/8–3/16)	0.4 (1/64)	0.2–1.0 (1/64–1/16)	No	Automatic reinforcement	No
		A	Secured buttonholes for fabrics that have backings	5.0 (3/16)	3.0–5.0 (1/8–3/16)	0.4 (1/64)	0.2–1.0 (1/64–1/16)	No	Automatic reinforcement	No
		A	Buttonholes for stretch or knit fabrics	6.0 (15/64)	3.0–6.0 (1/8–15/64)	1.0 (1/16)	0.5–2.0 (1/32–1/16)	No	Automatic reinforcement	No
		A	Buttonholes for stretch fabrics	6.0 (15/64)	3.0–6.0 (1/8–15/64)	1.5 (1/16)	1.0–3.0 (1/16–1/8)	No	Automatic reinforcement	No
		A	Bound buttonholes	5.0 (3/16)	0.0–6.0 (0–15/64)	2.0 (1/16)	0.2–4.0 (1/64–3/16)	No	Automatic reinforcement	No
		A	Keyhole buttonholes for thick or furry fabrics	7.0 (1/4)	3.0–7.0 (1/8–1/4)	0.5 (1/32)	0.3–1.0 (1/64–1/16)	No	Automatic reinforcement	No
		A	Keyhole buttonholes for mediumweight and thick fabrics	7.0 (1/4)	3.0–7.0 (1/8–1/4)	0.5 (1/32)	0.3–1.0 (1/64–1/16)	No	Automatic reinforcement	No
		A	Horizontal buttonholes for thick or furry fabrics	7.0 (1/4)	3.0–7.0 (1/8–1/4)	0.5 (1/32)	0.3–1.0 (1/64–1/16)	No	Automatic reinforcement	No
Darning stitch		A	Darning mediumweight fabrics	7.0 (1/4)	2.5–7.0 (3/32–1/4)	2.0 (1/16)	0.4–2.5 (1/64–3/32)	No	Automatic reinforcement	No
		A	Darning thick fabrics	7.0 (1/4)	2.5–7.0 (3/32–1/4)	2.0 (1/16)	0.4–2.5 (1/64–3/32)	No	Automatic reinforcement	No
Bar tack stitch		A	Reinforcing openings and areas where the seam easily comes loose	2.0 (1/16)	1.0–3.0 (1/16–1/8)	0.4 (1/64)	0.3–1.0 (1/64–1/16)	No	Automatic reinforcement	No
Button-sewing stitch		M	Button sewing	3.5 (1/8)	2.5–4.5 (3/32–3/16)	–	–	No	Reinforcement	No
Eyelet stitch		N	Sewing eyelets, for example, on belts	7.0 (1/4)	7.0, 6.0, 5.0 (1/4, 15/64, 3/16)	7.0 (1/4)	7.0, 6.0, 5.0 (1/4, 15/64, 3/16)	No	Automatic reinforcement	No
Piecing straight stitch		J	Piecing straight stitching (with a seam allowance of 6.5 mm from the right edge of the presser foot)	5.5 (7/32)	0.0–7.0 (0–1/4)	1.6 (1/16)	0.2–5.0 (1/64–3/16)	No	Reinforcement	Yes
		J	Piecing straight stitching (with a seam allowance of 6.5 mm from the left edge of the presser foot)	1.5 (1/16)	0.0–7.0 (0–1/4)	1.6 (1/16)	0.2–5.0 (1/64–3/16)	No	Reinforcement	Yes
Straight stitch that looks hand-sewn (for quilting)		J	Straight stitch quilting that looks hand-sewn	0.0 (0)	0.0–7.0 (0–1/4)	2.5 (3/32)	1.0–4.0 (1/16–3/16)	No	Reinforcement	No
Zigzag stitch (for quilting)		J	Appliqué quilting, free-motion quilting, satin stitching	3.5 (1/8)	0.0–7.0 (0–1/4)	1.4 (1/16)	0.0–4.0 (0–3/16)	No	Reinforcement	Yes
Appliqué stitch (for quilting)		J	Attaching appliques and binding	1.5 (1/16)	0.5–5.0 (1/32–3/16)	1.2 (1/16)	1.0–4.0 (1/16–3/16)	No	Reinforcement	No

Stitch Name	Pattern	Presser Foot	Application	Stitch Width [mm (inch.)]		Stitch Length [mm (inch.)]		Twin Needle	Reverse/ Reinforcement Stitching	Walking Foot
				Auto	Manual	Auto	Manual			
Quilting stitch (for stippling)		J	Quilting background stitching (stippling)	7.0 (1/4)	1.0–7.0 (1/16–1/4)	1.6 (1/16)	1.0–4.0 (1/16–3/16)	No	Reinforcement	No
Side cutter		S	Sewing straight stitches while cutting the fabric	0.0 (0)	0.0–2.5 (0–3/32)	2.5 (3/32)	0.2–5.0 (1/64–3/16)	No	Reinforcement	No
		S	Sewing zigzag stitches while cutting the fabric	3.5 (1/8)	3.5–5.0 (1/8–3/16)	1.4 (1/16)	0.0–4.0 (0–3/16)	No	Reinforcement	No
		S	Overcasting on thin and mediumweight fabrics while cutting the fabric	3.5 (1/8)	3.5–5.0 (1/8–3/16)	2.0 (1/16)	1.0–4.0 (1/16–3/16)	No	Reinforcement	No
		S	Overcasting on thick fabrics while cutting the fabric	5.0 (3/16)	3.5–5.0 (1/8–3/16)	2.5 (3/32)	1.0–4.0 (1/16–3/16)	No	Reinforcement	No
		S	Overcasting on mediumweight and thick fabrics while cutting the fabric	5.0 (3/16)	3.5–5.0 (1/8–3/16)	2.5 (3/32)	1.0–4.0 (1/16–3/16)	No	Reinforcement	No

Overcasting Stitches

Sew overcasting stitches along the edges of cut fabric to prevent them from fraying. Fifteen stitches are available for overcasting. The procedure for sewing overcasting stitch is explained according to the presser foot that is used.

Sewing overcasting stitches using overcasting foot "G"

Three stitches can be used to sew overcasting with overcasting foot "G".

Stitch Name	Pattern	Application	Stitch Width [mm (inch.)]		Stitch Length [mm (inch.)]		Presser Foot
			Auto	Manual	Auto	Manual	
Overcasting stitch	11	Preventing fraying in medium weight and thin fabrics	3.5 (1/8)	2.5–5.0 (3/32–3/16)	2.0 (1/16)	1.0–4.0 (1/16–3/16)	G
	12	Preventing fraying in thick fabrics and fabrics that fray easily	5.0 (3/16)	2.5–5.0 (3/32–3/16)	2.5 (3/32)	1.0–4.0 (1/16–3/16)	
	13		5.0 (3/16)	3.5–5.0 (1/8–3/16)	2.5 (3/32)	1.0–4.0 (1/16–3/16)	

1 Attach overcasting foot "G".

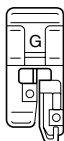

- For details, refer to "Replacing the presser foot" (page 38).

2 Select a stitch.

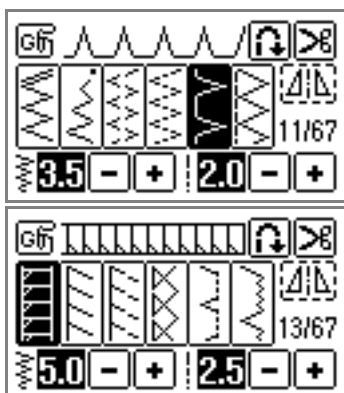

- For details, refer to "Selecting stitching" (page 45).

3 Position the fabric with the edge of the fabric against the guide of the presser foot, and then lower the presser foot lever.

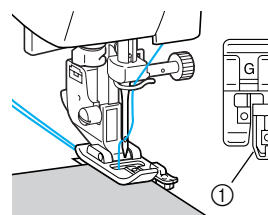

- ① Guide

4 Sew with the edge of the fabric against the presser foot guide.

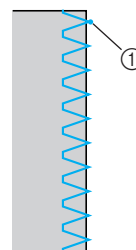

- ① Needle drop point

Sewing overcasting stitches using zigzag foot "J"

Seven stitches can be used to sew overcasting stitches with zigzag foot "J".

Stitch Name	Pattern	Application	Stitch Width [mm (inch.)]		Stitch Length [mm (inch.)]		Presser Foot
			Auto	Manual	Auto	Manual	
Zigzag stitch (center needle position)		Preventing fraying (center baseline/reverse stitching)	3.5 (1/8)	0.0-7.0 (0-1/4)	1.4 (1/16)	0.0-4.0 (0-3/16)	J
Zigzag stitch (right needle position)		Preventing fraying (right baseline/reinforcement stitching)	3.5 (1/8)	2.5-5.0 (3/32-3/16)	1.4 (1/16)	0.3-4.0 (1/64-3/16)	
2-point zigzag stitch		Preventing fraying in thick fabrics and stretch fabrics	5.0 (3/16)	1.5-7.0 (1/16-1/4)	1.0 (1/16)	0.2-4.0 (1/64-3/16)	
3-point zigzag stitch			5.0 (3/16)	1.5-7.0 (1/16-1/4)	1.0 (1/16)	0.2-4.0 (1/64-3/16)	
Overcasting stitch		Preventing fraying in stretch fabrics	5.0 (3/16)	0.0-7.0 (0-1/4)	2.5 (3/32)	0.5-4.0 (1/32-3/16)	
		Preventing fraying in thick fabrics and stretch fabrics	5.0 (3/16)	0.0-7.0 (0-1/4)	2.5 (3/32)	0.5-4.0 (1/32-3/16)	
		Preventing fraying in stretch fabrics	4.0 (3/16)	0.0-7.0 (0-1/4)	4.0 (3/16)	1.0-4.0 (1/16-3/16)	

1 Attach zigzag foot "J".

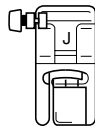

- For details, refer to "Replacing the presser foot" (page 38).

2 Select a stitch.

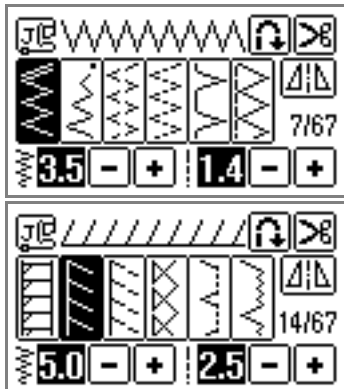

- For details, refer to "Selecting stitching" (page 45).

3 Sew along the edge of the fabric with the needle dropping off the edge at the right.

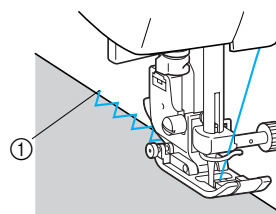



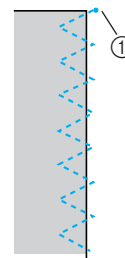

① Needle drop point



① Needle drop point

Sewing overcasting stitches using the optional side cutter

Using the optional side cutter, seam allowances can be finished while the edge of the fabric is cut off. Five stitches can be used to sew overcasting stitches with the side cutter.

Stitch Name	Pattern	Application	Stitch Width [mm (inch.)]		Stitch Length [mm (inch.)]		Presser Foot
			Auto	Manual	Auto	Manual	
Overcasting stitch	63 	Sewing straight stitches while cutting the fabric	0.0 (0)	0.0–2.5 (0–3/32)	2.5 (3/32)	0.2–5.0 (1/64–3/16)	S
	64 	Sewing zigzag stitches while cutting the fabric	3.5 (1/8)	3.5–5.0 (1/8–3/16)	1.4 (1/16)	0.0–4.0 (0–3/16)	
	65 	Preventing fraying in thin and mediumweight fabrics while cutting the fabric	3.5 (1/8)	3.5–5.0 (1/8–3/16)	2.0 (1/16)	1.0–4.0 (1/16–3/16)	
	66 	Preventing fraying in thick fabrics while cutting the fabric	5.0 (3/16)	3.5–5.0 (1/8–3/16)	2.5 (3/32)	1.0–4.0 (1/16–3/16)	
	67 	Preventing fraying in thick fabrics while cutting the fabric	5.0 (3/16)	3.5–5.0 (1/8–3/16)	2.5 (3/32)	1.0–4.0 (1/16–3/16)	

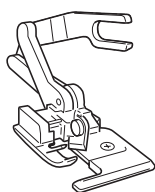

1 Remove the presser foot.

- For details, refer to "Replacing the presser foot" (page 38).

2 Hook the connecting fork of the side cutter onto the needle clamp screw.

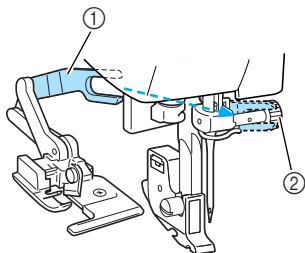

- ① Connecting fork
- ② Needle clamp screw

3 Position the side cutter so that side cutter pin is aligned with the notch in the presser foot holder, and then slowly lower the presser foot lever.

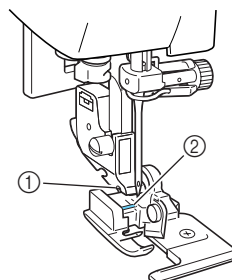

- ① Notch in presser foot holder
- ② Pin

► The side cutter is attached.

4 Raise the presser foot lever to check that the side cutter is securely attached.

! CAUTION

- If the thread cassette is to be installed with the side cutter attached, be sure to lower the presser foot lever. If the presser foot lever remains raised, the needle threader will hit the presser foot, which may result in damages.

- 5** Pass the upper thread under the side cutter, and then pull it out toward the rear of the sewing machine.

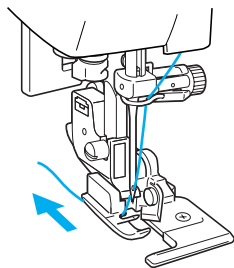

- 6** Select a stitch.

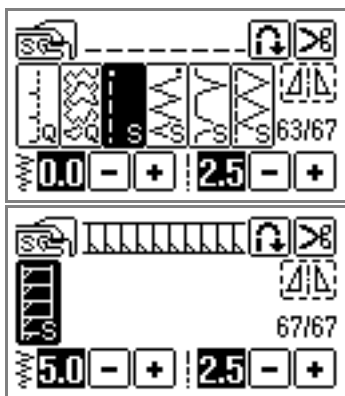

- For details, refer to "Selecting stitching" (page 45).

- 7** Make a cut of about 2 cm (3/4 inch) long in the fabric at the beginning of the stitching.

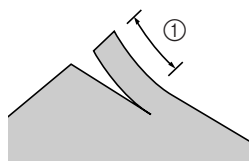

① 2 cm (3/4 inch)

- 8** Position the fabric in the side cutter. The cut in the fabric should be positioned over the guide plate of the side cutter.

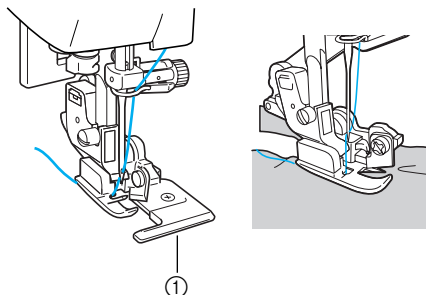

① Guide plate

- If the fabric is not positioned correctly, the fabric will not be cut.

- 9** Lower the presser foot lever, and then start sewing.

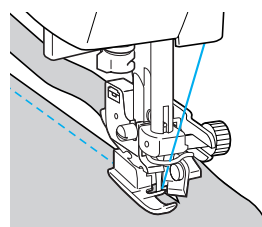

- ▶ A seam allowance is cut while the stitching is sewn.

- If the stitching is sewn in a straight line ⁶³ , the seam allowance will be about 5 mm (3/16 inch).

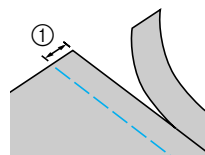





① 5 mm (3/16 inch)

Memo

- The side cutter can cut as much as one layer of 13-oz. denim.
- After using the side cutter, clean it by removing any lint or dust.
- If the side cutter can no longer cut fabric, use a rag to apply a small amount of oil to the cutting edge of the cutter.

Basic Stitching

Straight stitches are used for sewing plain seams. Five stitches are available for basic stitching.

Stitch Name	Pattern	Application	Stitch Width [mm (inch.)]		Stitch Length [mm (inch.)]		Presser Foot
			Auto	Manual	Auto	Manual	
Basting stitch		Temporarily securing	0.0 (0)	0.0–7.0 (0–1/4)	–	–	J
Straight stitch (left needle position)		Basic stitching and sewing gathers or pintucks (left baseline/reverse stitching)	0.0 (0)	0.0–7.0 (0–1/4)	2.5 (3/32)	0.2–5.0 (1/64–3/16)	
		Basic stitching and sewing gathers or pintucks (left baseline/reinforcement stitching)	0.0 (0)	0.0–7.0 (0–1/4)	2.5 (3/32)	0.2–5.0 (1/64–3/16)	
Straight stitch (center needle position)		Basic stitching and sewing gathers or pintucks (center baseline/reverse stitching)	–	–	2.5 (3/32)	0.2–5.0 (1/64–3/16)	
Triple stretch stitch		Reinforcing seams and sewing stretch fabrics	0.0 (0)	0.0–7.0 (0–1/4)	2.5 (3/32)	1.5–4.0 (1/16–3/16)	

Basting

Sew basting with a stitch length between 5 mm (3/16 inch).

1 Attach zigzag foot "J".

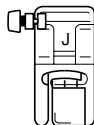

- For details, refer to "Replacing the presser foot" (page 38).

2 Select stitch .



- For details, refer to "Selecting stitching" (page 45).

3 Start sewing.

- For details, refer to "Starting to sew" (page 47).

Basic stitching

1 Baste or pin together the fabric pieces.

2 Attach zigzag foot "J".

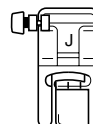

- For details, refer to "Replacing the presser foot" (page 38).

3 Select a stitch.

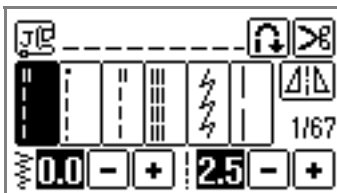

- For details, refer to "Selecting stitching" (page 45).

4 Lower the needle into the fabric at the beginning of the stitching.

5 Start sewing.

- For details, refer to "Starting to sew" (page 47).
- For details on sewing reverse/reinforcement stitches, refer to "Securing the stitching" (page 49).

6 When sewing is finished, cut the thread.

- For details, refer to "Cutting the thread" (page 50).



■ Changing the needle position

The needle position used as the baseline is different for the straight stitch (left needle position) and the straight stitch (center needle position).

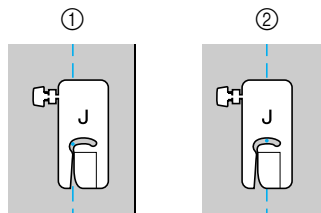

- ① Straight stitch (left needle position)
- ② Straight stitch (center needle position)

When the stitch width of the straight stitch (left needle position) is set to its standard setting (0.0 mm), the distance from the needle position to the right side of the presser foot is 12 mm (1/2 inch). If the stitch width is changed (between 0 and 7.0 mm (1/4 inch)), the needle position will also change. By changing the stitch width and sewing with the right side of the presser foot aligned with the edge of the fabric, a seam allowance can be sewn with a fixed width.

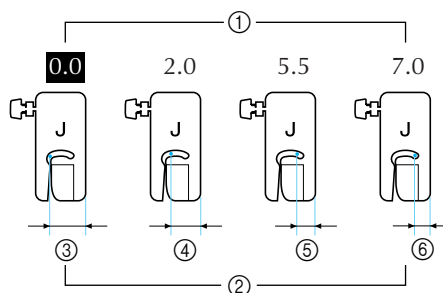

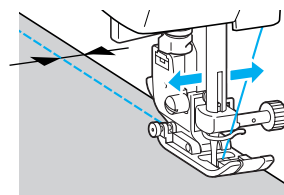

- ① Stitch width
- ② Distance from the needle position to the right side of the presser foot
- ③ 12.0 mm (1/2 inch)
- ④ 10.0 mm (3/8 inch)
- ⑤ 6.5 mm (1/4 inch)
- ⑥ 5.0 mm (3/16 inch)



- For details, refer to "Adjusting the stitch width" (page 54).

Blind Hem Stitching

Secure the bottoms of skirts and pants with a blind hem. Two stitches are available for blind hem stitching.

Stitch Name	Pattern	Application	Stitch Width [mm (inch.)]		Stitch Length [mm (inch.)]		Presser Foot
			Auto	Manual	Auto	Manual	
Blind hem stitch	17 	Blind hem stitching on mediumweight fabrics	0.0 (0)	3← - 3→	2.0 (1/16)	1.0-3.5 (1/16-1/8)	R
	18 	Blind hem stitching on stretch fabrics	0.0 (0)	3← - 3→	2.0 (1/16)	1.0-3.5 (1/16-1/8)	

Sew a blind hem according to the following procedure.

- 1 Fold the fabric along the desired edge of the hem, and then baste it about 5 mm (3/16 inch) from the edge of the fabric.

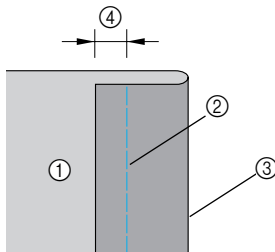

- ① Wrong side of fabric
- ② Basting stitching
- ③ Desired edge of hem
- ④ 5 mm (3/16 inch)

- 2 Fold back the fabric along the basting, and then position the fabric with the wrong side facing up.

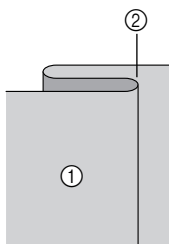

- ① Wrong side of fabric
- ② Basting

- 3 Attach blind hem foot "R".

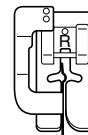

- For details, refer to "Replacing the presser foot" (page 38).

- 4 Select a stitch.

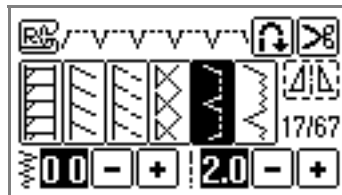

- For details, refer to "Selecting stitching" (page 45).

- 5 Position the fabric with the edge of the folded hem against the guide of the presser foot, and then lower the presser foot lever.

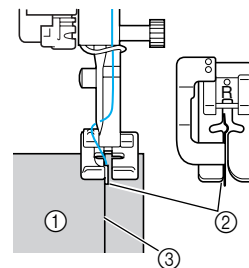

- ① Wrong side of fabric
- ② Fold of hem
- ③ Guide

6 Adjust the stitch width until the needle slightly catches the fold of the hem.

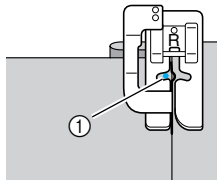

① Needle drop point

When you change the needle drop point, raise the needle, and then change the stitch width.

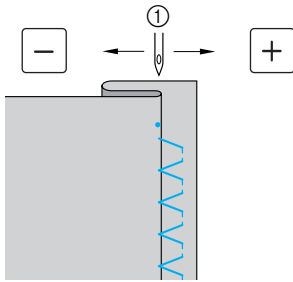

① Stitch width

■ If the needle catches too much of the hem fold

The needle is too far to the left.

Press **+** to decrease the stitch width so that the needle slightly catches the fold of the hem.

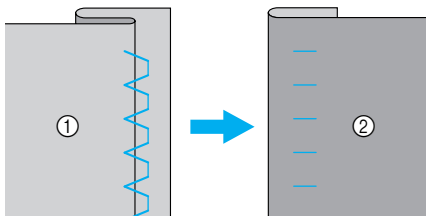

① Wrong side of fabric
② Right side of fabric

■ If the needle does not catch the hem fold

The needle is too far to the right.

Press **-** to increase the stitch width so that the needle slightly catches the fold of the hem.

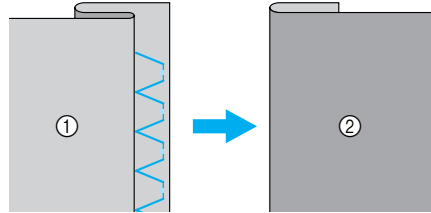

① Wrong side of fabric
② Right side of fabric

• For details, refer to "Adjusting the stitch width" (page 54).

7 Sew with the fold of the hem against the presser foot guide.



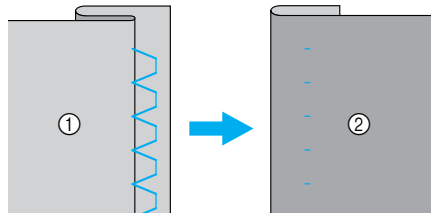







8 Remove the basting stitching.



① Wrong side of fabric
② Right side of fabric

Buttonhole Stitching

Buttonholes can be sewn and buttons can be sewn on. Ten stitches are available for sewing one-step buttonholes, one for sewing on buttons.

Stitch Name	Pattern	Application	Stitch Width [mm (inch.)]		Stitch Length [mm (inch.)]		Presser Foot
			Auto	Manual	Auto	Manual	
Buttonhole stitch	42 	Horizontal buttonholes on thin and mediumweight fabrics	5.0 (3/16)	3.0–5.0 (1/8–3/16)	0.4 (1/64)	0.2–1.0 (1/64–1/16)	A
	43 	Horizontal buttonholes on areas that are subject to strain	5.0 (3/16)	3.0–5.0 (1/8–3/16)	0.4 (1/64)	0.2–1.0 (1/64–1/16)	
	44 	Horizontal buttonholes on thick fabrics	5.0 (3/16)	3.0–5.0 (1/8–3/16)	0.4 (1/64)	0.2–1.0 (1/64–1/16)	
	45 	Buttonholes with bar tacks on both ends for stabilized fabrics	5.0 (3/16)	3.0–5.0 (1/8–3/16)	0.4 (1/64)	0.2–1.0 (1/64–1/16)	
	46 	Buttonholes for stretch or knit fabrics	6.0 (15/64)	3.0–6.0 (1/8–15/64)	1.0 (1/16)	0.5–2.0 (1/32–1/16)	
	47 	Buttonholes for stretch fabrics	6.0 (15/64)	3.0–6.0 (1/8–15/64)	1.5 (1/16)	1.0–3.0 (1/16–1/8)	
	48 	Bound buttonholes	5.0 (3/16)	0.0–6.0 (0–15/64)	2.0 (1/16)	0.2–4.0 (1/64–3/16)	
	49 	Keyhole buttonholes for thick or plush fabrics	7.0 (1/4)	3.0–7.0 (1/8–1/4)	0.5 (1/32)	0.3–1.0 (1/64–1/16)	
	50 	Keyhole buttonholes for mediumweight and thick fabrics	7.0 (1/4)	3.0–7.0 (1/8–1/4)	0.5 (1/32)	0.3–1.0 (1/64–1/16)	
	51 	Horizontal buttonhole for thick or plush fabrics	7.0 (1/4)	3.0–7.0 (1/8–1/4)	0.5 (1/32)	0.3–1.0 (1/64–1/16)	
Button-sewing stitch	55 	Button sewing	3.5 (1/8)	2.5–4.5 (3/32–3/16)	–	–	M

Buttonhole sewing

The maximum buttonhole length is about 28 mm (1-1/8 inch) (diameter + thickness of the button). Buttonholes are sewn from the front of the presser foot to the back, as shown below.

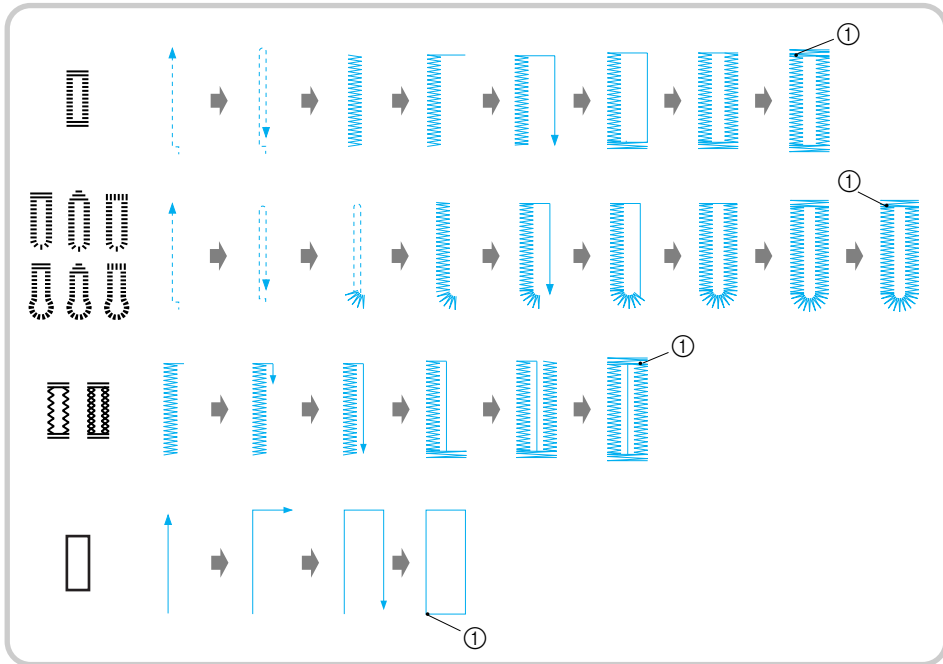

① Reinforcement stitching

The names of parts of buttonhole foot "A", which is used for sewing buttonholes, are indicated below.

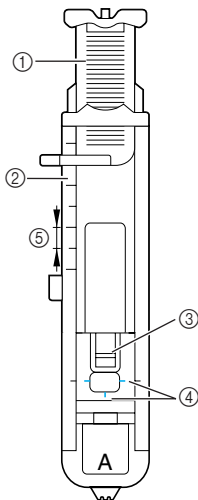

- ① Button guide plate
- ② Presser foot scale
- ③ Pin
- ④ Marks on buttonhole foot
- ⑤ 5 mm (3/16 inch)

1 Use chalk to mark on the fabric the position and length of the buttonhole.

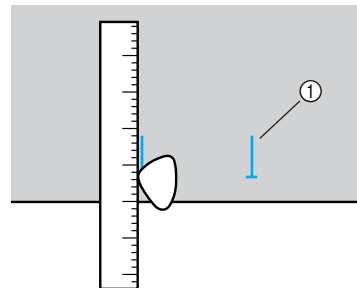

① Marks on fabric

2 Pull out the button guide plate of buttonhole foot "A", and then insert the button that will be put through the buttonhole.

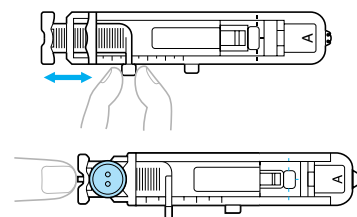

■ **If the button does not fit in the button guide plate**

Add together the diameter and thickness of the button, and then set the button guide plate to the calculated length. (The distance between the markings on the presser foot scale is 5 mm (3/16 inch).)

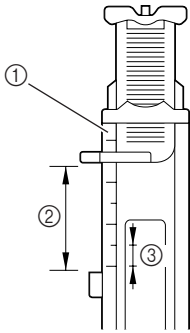

- ① Presser foot scale
- ② Length of buttonhole (Diameter + thickness of button)
- ③ 5 mm (3/16 inch)

Example: For a button with a diameter of 15 mm (9/16 inch) and a thickness of 10 mm (3/8 inch), the button guide plate should be set to 25 mm (1 inch) on the scale.

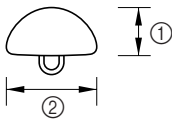

- ① 10 mm (3/8 inch)
- ② 15 mm (9/16 inch)

▶ The size of the buttonhole is set.

3 Attach buttonhole foot "A".

- For details, refer to "Replacing the presser foot" (page 38).

4 Select a stitch.

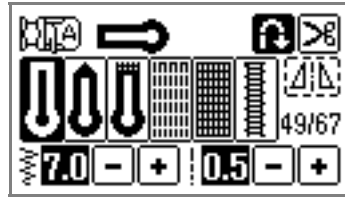
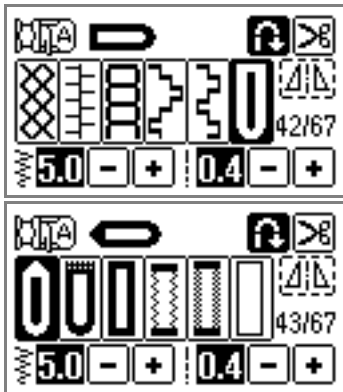

- For details, refer to "Selecting stitching" (page 45).

5 Position the fabric with the front end of the buttonhole mark aligned with the red marks on the sides of the buttonhole foot, and then lower the presser foot lever.

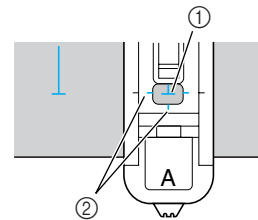

- ① Mark on fabric (front)
- ② Red marks on buttonhole foot

Pass the upper thread down through the hole in the presser foot.

- When lowering the presser foot, do not push in the front of the presser foot.

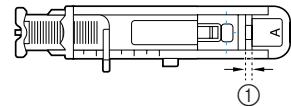
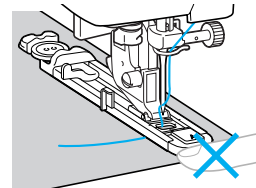

- ① Do not reduce the gap.

6 Pull down the buttonhole lever as far as possible.

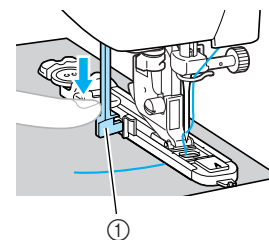

- ① Buttonhole lever

The buttonhole lever is positioned behind the bracket on the buttonhole foot.

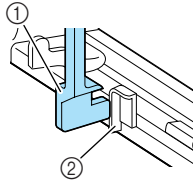

- ① Buttonhole lever
- ② Bracket

7 Gently hold the end of the upper thread in your left hand, and then start sewing.

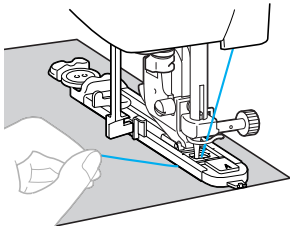

▶ Once sewing is completed, the machine automatically sews reinforcement stitches, then stops.

8 Raise the presser foot lever, remove the fabric, and then cut the thread.

9 Raise the buttonhole lever to its original position.

10 Insert a pin along the inside of one bar tack at the end of the buttonhole stitching to prevent the stitching from being cut.

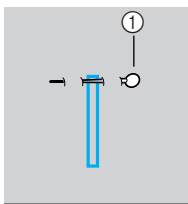

- ① Pin

11 Use the seam ripper to cut towards the pin and open the buttonhole.

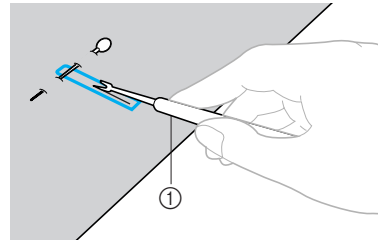

- ① Seam ripper

For keyhole buttonholes, use the eyelet punch to make a hole in the rounded end of the buttonhole, and then use the seam ripper to cut open the buttonhole.

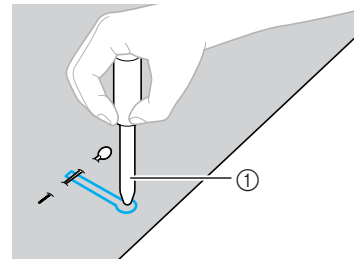

- ① Eyelet punch

- When using the eyelet punch, place thick paper or some other protective sheet under the fabric before punching the hole in the fabric.

CAUTION

- When opening the buttonhole with the seam ripper, do not place your hands in the cutting direction, otherwise injuries may result if the seam ripper slips.

■ Changing the density of the stitching

Adjust the stitch length.

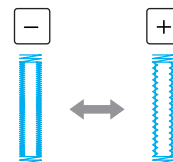

- For details, refer to "Adjusting the stitch length" (page 55).
- If the fabric does not feed (for example, if it is too thick), decrease the density of the stitching.

■ Changing the stitch width

Adjust the stitch width.

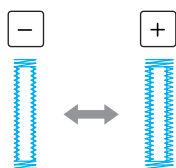

- For details, refer to "Adjusting the stitch width" (page 54).



Memo

- Before sewing buttonholes, check the stitch length and width by sewing a trial buttonhole on a scrap piece of fabric.

■ Sewing buttonholes on stretch fabrics

When sewing buttonholes on stretch fabrics, use a gimp thread.

- 1 Hook the gimp thread onto the part of buttonhole foot "A" shown in the illustration.

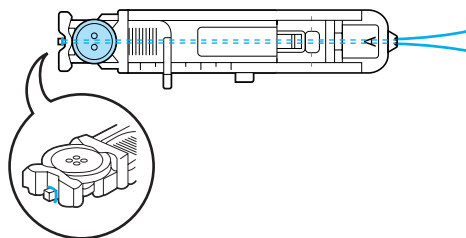

- 2 It fits into the grooves, and then loosely tie it.

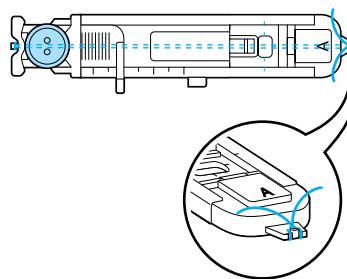

- 3 Attach buttonhole foot "A".

- For details, refer to "Replacing the presser foot" (page 38).

- 4 Select stitch 46  or 47 .

- 5 Adjust the stitch width to the thickness of the gimp thread.

- 6 Lower the presser foot lever and the buttonhole lever, and then start sewing.

- 7 When sewing is finished, gently pull the gimp thread to remove any slack.

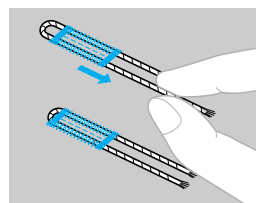



- 8 Use a handsewing needle to pull the gimp thread to the wrong side of the fabric, and then tie it.

Button sewing

Buttons can be sewn on with the sewing machine. Buttons with 2 or with 4 holes can be attached.

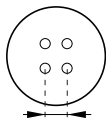
- 1 Measure the distance between the holes in the button to be attached.



- 2 Raise the presser foot lever, and then slide the drop feed lever, located at the rear of the machine on the base, to  (to the left as seen from the rear of the machine).

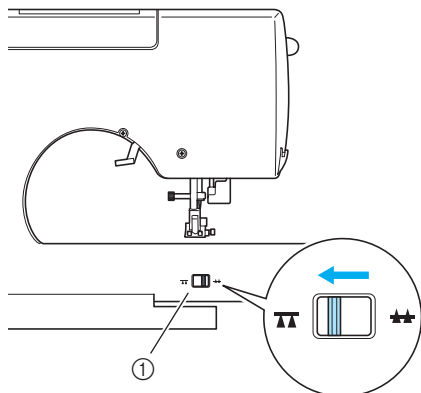

- 1 Drop feed lever (as seen from the rear of the machine)

▶ The feed dogs are lowered.

- 3 Attach button-sewing foot "M".

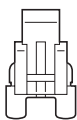

- For details, refer to "Replacing the presser foot" (page 38).

- 4 Select stitch  55.

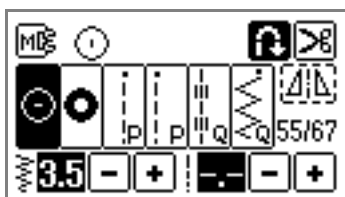

- For details, refer to "Selecting stitching" (page 45).
- Since the end of the thread will be tied off later, do not set the sewing machine for programmed-thread cutting.

- 5 Adjust the stitch width so that it is the same as the distance between the holes in the button.

- 6 Place the button in the position where it will be sewn, and lower the presser foot lever.

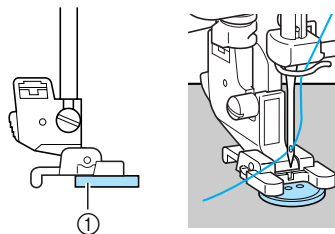

- 1 Button

▶ The button is held in place.

- When attaching four-hole buttons, first sew the two holes closest to you. Then, slide the button so that the needle goes into the two holes toward the rear of the sewing machine, and then sew them in the same way.

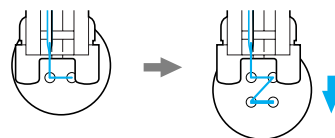

- 7 Turn the balance wheel toward you to check that the needle correctly goes into the two holes of the button.

Adjust the stitch width to the distance between the button holes.

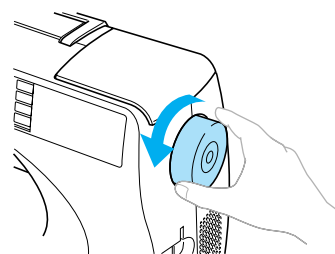

! CAUTION

- When sewing, be sure that the needle does not touch the button, otherwise the needle may bend or break.

- 8 Start sewing.**
Set the sewing speed controller to the left (so that the speed will be slow).

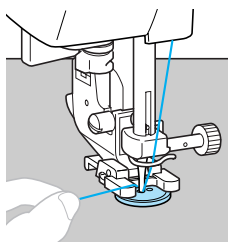

- ▶ The sewing machine automatically stops after sewing reinforcement stitches.
- Do not press the thread cutter button.

- 9 Pull the upper thread at the end of the stitching to the wrong side of the fabric, and then tie it with the bobbin thread.**
Use scissors to cut the upper thread and the bobbin thread at the beginning of the stitching.

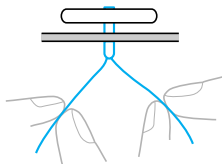

- 10 When you are finished attaching the button, slide the drop feed lever to  (to the right as seen from the rear of the machine) to raise the feed dogs.**



Memo

- The feed dog position switch is normally set to the right side.
- The feed dogs come up when you start sewing again.

Zipper Insertion

A zipper can be sewn in place.

Stitch Name	Pattern	Application	Stitch Width [mm (inch.)]		Stitch Length [mm (inch.)]		Presser Foot
			Auto	Manual	Auto	Manual	
Straight stitch (center needle position)		Attaching zippers Sewing concealed seams and pintucks	–	–	2.5 (3/32)	0.2–5.0 (1/64–3/16)	I

There are many methods for inserting zippers. The procedures for inserting a centered zipper and a side zipper are described below.

Inserting a centered zipper

Stitching is sewn on both pieces of fabric butted against each other.

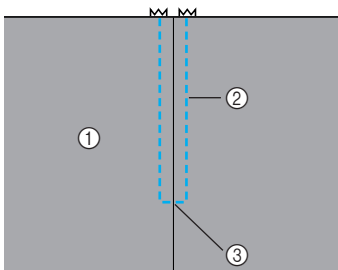

- ① Right side of fabric
- ② Stitching
- ③ End of zipper opening

- 1 Attach zigzag foot "J".**
- 2 Sew straight stitches up to the zipper opening.** With the right sides of the fabric facing each other, sew reverse stitches after reaching the zipper opening.
 - For details, refer to "Basic stitching" (page 73).

- 3 Using a basting stitch, continue sewing to the edge of the fabric.**

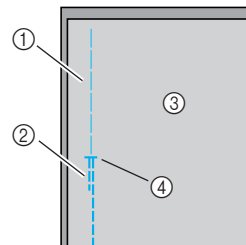

- ① Basting stitching
- ② Reverse stitches
- ③ Wrong side of fabric
- ④ End of zipper opening

- 4 Press open the seam allowance from the wrong side of the fabric.**

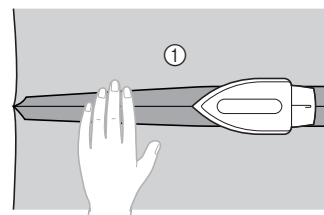

- ① Wrong side of fabric

- 5 Align the seam with the center of the zipper, and then baste the zipper in place.

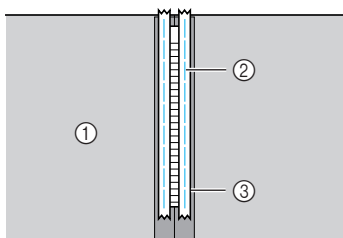

- ① Wrong side of fabric
- ② Basting stitching
- ③ Zipper

- 6 Remove about 5 cm (2 inch) from the end of the basting on the outside.

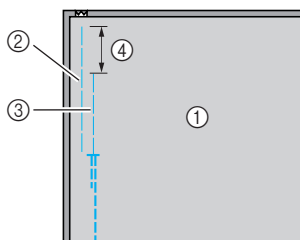

- ① Wrong side of fabric
- ② Zipper basting
- ③ Outside basting
- ④ 5 mm (2 inch)

- 7 Attach the presser foot holder to the right pin of zipper foot "I".

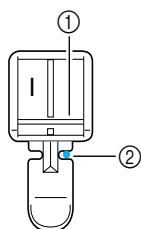

- ① Pin on the right side
- ② Needle drop point

- For details, refer to "Replacing the presser foot" (page 38).

- 8 Select stitch 3.

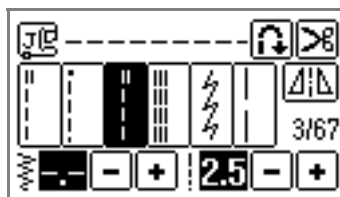

- For details, refer to "Selecting stitching" (page 45).

CAUTION

- When using zipper foot "I", be sure to select the straight stitch (center needle position), and slowly turn the balance wheel toward you to check that the needle does not touch the presser foot. If a different stitch is selected or the needle hits the presser foot, the needle may bend or break.

- 9 Topstitch around the zipper.

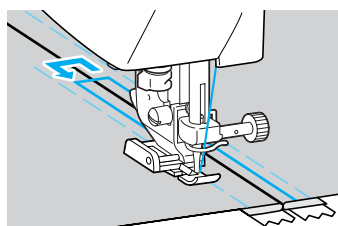
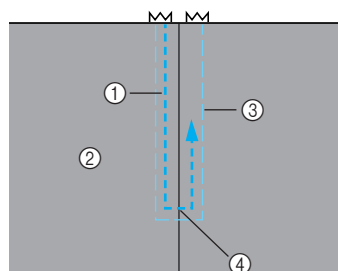

- ① Stitching
- ② Right side of fabric
- ③ Basting stitching
- ④ End of zipper opening

CAUTION

- When sewing, be sure that the needle does not touch the zipper, otherwise the needle may bend or break.

- 10 Remove the basting stitching.

Inserting a side zipper

Stitching is sewn on only one piece of fabric. Use this type of zipper for side openings and back openings.

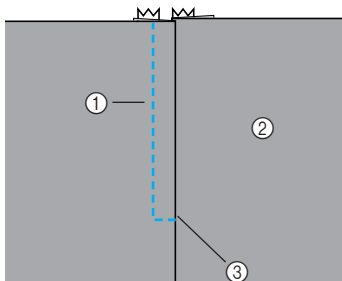

- ① Stitching
- ② Right side of fabric
- ③ End of zipper opening

The following procedure will describe how to stitch on the left side, as shown in the illustration.

- 1 Attach zigzag foot "J".**
- 2 Sew straight stitches up to the zipper opening.** With the right sides of the fabric facing each other, sew reverse stitches after reaching the zipper opening.
 - For details, refer to "Basic stitching" (page 73).
- 3 Using a basting stitch, continue sewing to the edge of the fabric.**

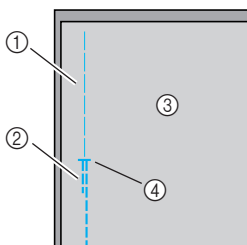

- ① Basting stitching
- ② Reverse stitches
- ③ Wrong side of fabric
- ④ End of zipper opening

- 4 Press open the seam allowance from the wrong side of the fabric.**

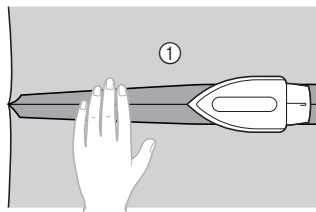

- ① Wrong side of fabric

- 5 Press the seam allowance so that the right side (the side that will not be stitched) has an extra 3 mm (1/8 inch).**

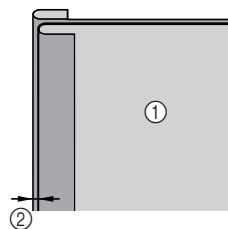

- ① Wrong side of fabric
- ② 3 mm (1/8 inch)

- 6 Align the zipper teeth with the pressed edge of the fabric having the extra 3 mm (1/8 inch), and then baste or pin the zipper in place.**

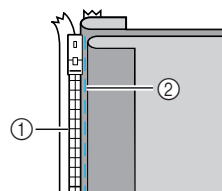

- ① Zipper teeth
- ② Basting stitching

- 7 Attach the presser foot holder to the right pin of zipper foot "I".**

If the stitching will be sewn on the right side, attach the presser foot holder to the left pin of the zipper foot.

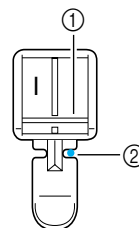

- ① Pin on the right side
- ② Needle drop point

- For details, refer to "Replacing the presser foot" (page 38).

- 8 Select stitch .

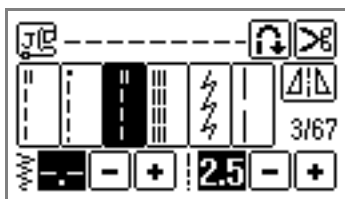

- For details, refer to "Selecting stitching" (page 45).

CAUTION

- When using zipper foot "I", be sure to select the straight stitch (center needle position), and slowly turn the balance wheel toward you to check that the needle does not touch the presser foot. If a different stitch is selected or the needle hits the presser foot, the needle may bend or break.

- 9 Sew the zipper to the piece of fabric with the extra 3 mm (1/8 inch), starting from the base of the zipper.

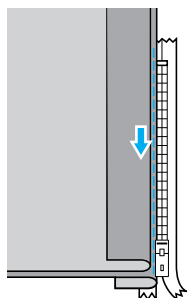

CAUTION

- When sewing, be sure that the needle does not touch the zipper, otherwise the needle may bend or break.

- 10 When you are about 5 cm (2 inch) from the end of the zipper, stop the sewing machine with the needle lowered (in the fabric), raise the presser foot lever.

- 11 Open the zipper and continue sewing.

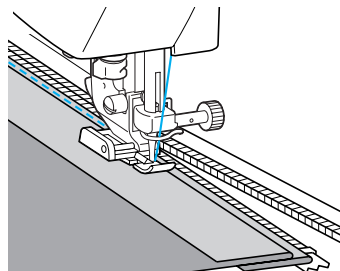

- 12 Close the zipper, turn over the fabric, and then baste the other side of the zipper to the fabric.

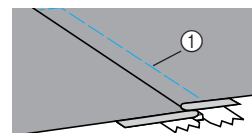
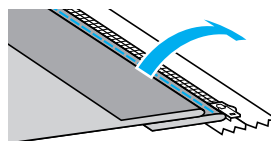

- ① Basting stitching

- 13 Attach the presser foot holder to the other pin of zipper foot "I".

If the presser foot holder was attached to the right pin in step 7, change it to the left pin.

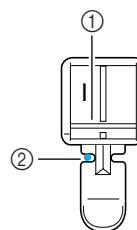

- ① Pin on the left side
② Needle drop point

- 14 Topstitch around the zipper.**
Sew reverse stitches at the end of the zipper opening and align the zipper teeth with the side of the presser foot.

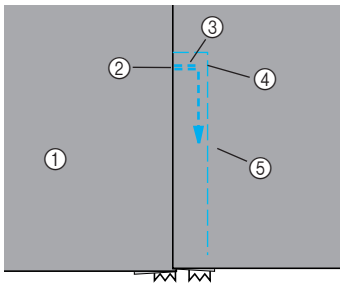

- ① Right side of fabric
- ② End of zipper opening
- ③ Reverse stitches
- ④ Beginning of stitching
- ⑤ Basting stitching

! CAUTION



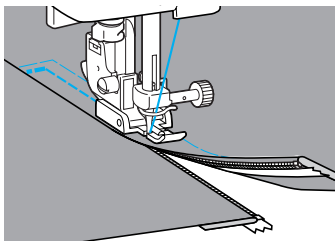

- When sewing, be sure that the needle does not touch the zipper, otherwise the needle may bend or break.

- 15** When you are about 5 cm (2 inch) from the end of the zipper, stop the sewing machine with the needle lowered (in the fabric), and then raise the presser foot lever.
- 16** Remove the basting stitching, open the zipper, and then continue sewing.



Sewing Stretch Fabrics and Elastic Tape

Stretch fabrics can be sewn and elastic tape can be attached.

Stitch Name	Pattern	Application	Stitch Width [mm (inch.)]		Stitch Length [mm (inch.)]		Presser Foot
			Auto	Manual	Auto	Manual	
Stretch stitch	5 	Stretch fabrics	1.0 (1/16)	1.0–3.0 (1/16–1/8)	2.5 (3/32)	1.0–4.0 (1/16–3/16)	J
2-point zigzag stitch	9 	Attaching elastic	5.0 (3/16)	1.5–7.0 (1/16–1/4)	1.0 (1/16)	0.2–4.0 (1/64–3/16)	
3-point zigzag stitch	10 		5.0 (3/16)	1.5–7.0 (1/16–1/4)	1.0 (1/16)	0.2–4.0 (1/64–3/16)	
Elastic-attaching stitch	28 	Attaching elastic to stretch fabrics	4.0 (3/16)	0.0–7.0 (0–1/4)	1.0 (1/16)	0.2–4.0 (1/64–3/16)	

Observe the corresponding precautions when performing each of the following stitching operations.

Stretch stitching

- 1 Attach zigzag foot "J".

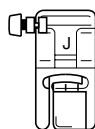

- For details, refer to "Replacing the presser foot" (page 38).

- 2 Select stitch 5 .

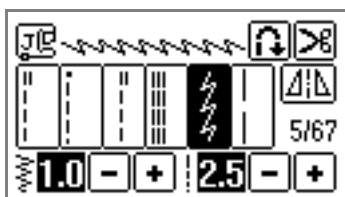

- For details, refer to "Selecting stitching" (page 45).

- 3 Sew the fabric without stretching it.

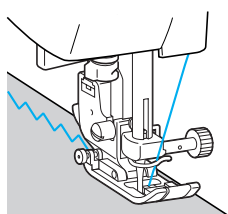

Elastic attaching

When elastic tape is attached to the cuff or waist of a piece of clothing, the finished dimensions will be that of the stretched elastic tape. Therefore, it is necessary that a suitable length of the elastic tape be used.

- 1 Pin the elastic tape to the wrong side of the fabric.

Pin the elastic tape to the fabric at a few points to make sure that the tape is uniformly positioned on the fabric.

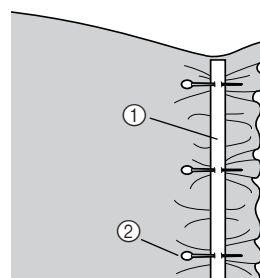

- ① Elastic tape
- ② Pin

- 2 Attach zigzag foot "J".

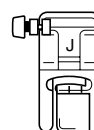

- For details, refer to "Replacing the presser foot" (page 38).

3 Select a stitch.

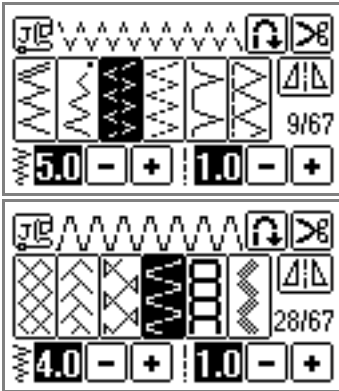

- For details, refer to "Selecting stitching" (page 45).

4 Sew the elastic tape to the fabric while stretching the tape so that it is the same length as the fabric.

While pulling the fabric behind the presser foot with your left hand, pull the fabric at the pin nearest the front of the presser foot with your right hand.

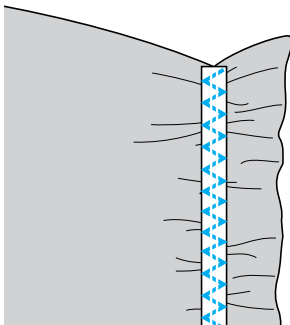
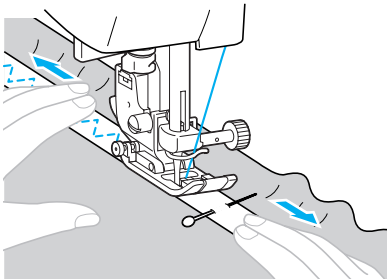











! CAUTION

- When sewing, be sure that the needle does not touch any pins, otherwise the needle may bend or break.

Appliqué, Patchwork and Quilt Stitching

The stitches that can be used for sewing appliques, patchwork and quilts are described below.

Stitch Name	Pattern	Application	Stitch Width [mm (inch.)]		Stitch Length [mm (inch.)]		Presser Foot
			Auto	Manual	Auto	Manual	
Zigzag stitch	7 	Attaching appliques (center baseline/reverse stitching)	3.5 (1/8)	0.0–7.0 (0–1/4)	1.4 (1/16)	0.0–4.0 (0–3/16)	J
	60 	Appliqué quilting, free-motion quilting, satin stitching	3.5 (1/8)	0.0–7.0 (0–1/4)	1.4 (1/16)	0.0–4.0 (0–3/16)	
Appliqué stitch	19 	Attaching appliques	3.5 (1/8)	2.5–5.0 (3/32–3/16)	2.5 (3/32)	1.6–4.0 (1/16–3/16)	
	61 	Attaching appliques and binding	1.5 (1/16)	0.5–5.0 (1/32–3/16)	1.2 (1/16)	1.0–4.0 (1/16–3/16)	
Piecing straight stitch	57 	Piecing straight stitching (with a seam allowance of 7 mm from the right edge of the presser foot)	5.5 (7/32)	0.0–7.0 (0–1/4)	1.6 (1/16)	0.2–5.0 (1/64–3/16)	
	58 	Piecing straight stitching (with a seam allowance of 7 mm from the left edge of the presser foot)	1.5 (1/16)	0.0–7.0 (0–1/4)	1.6 (1/16)	0.2–5.0 (1/64–3/16)	
Joining stitch	22 	Patchwork stitching	4.0 (3/16)	0.0–7.0 (0–1/4)	1.2 (1/16)	0.2–4.0 (1/64–3/16)	
	23 		5.0 (3/16)	2.5–7.0 (3/32–1/4)	2.5 (3/32)	1.0–4.0 (1/16–3/16)	
	24 		5.0 (3/16)	0.0–7.0 (0–1/4)	1.2 (1/16)	0.2–4.0 (1/64–3/16)	
Mock hand quilting stitch	59 	Straight stitch quilting that looks hand quilting	0.0 (0)	0.0–7.0 (0–1/4)	2.5 (3/32)	1.0–4.0 (1/16–3/16)	
Quilting stippling	62 	Stippling	7.0 (1/4)	1.0–7.0 (1/16–1/4)	1.6 (1/16)	1.0–4.0 (1/16–3/16)	



Memo

- Patterns showing a "Q" on the LCD are for quilting and those showing a "P" are for piecing.

Appliqué stitching

- 1 Cut out the appliqué, leaving a seam allowance of between 3 and 5 mm (1/8 and 3/16 inch).

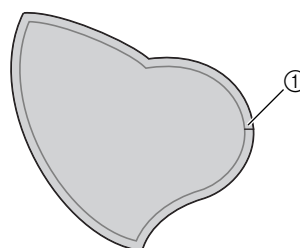

① Seam allowance

- 2** Place a pattern made of thick paper on the back of the appliqué, and then fold over the seam allowance using an iron.

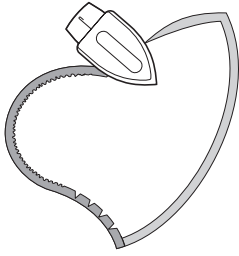

- After ironing the appliqué, remove the thick paper pattern.

- 3** Turn the fabric over, and then baste or fuse it onto the fabric that it will be attached to.

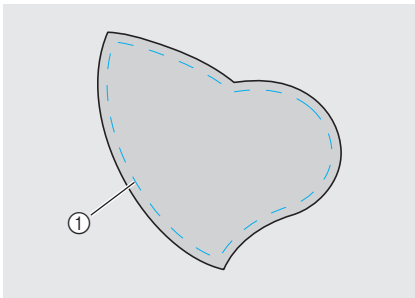

① Basting stitching

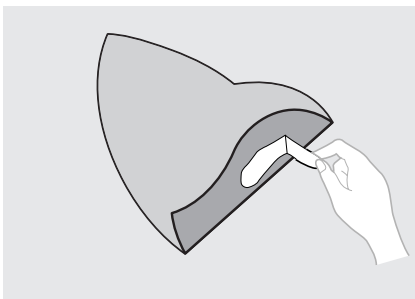

- 4** Attach zigzag foot "J".

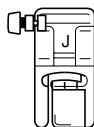

- For details, refer to "Replacing the presser foot" (page 38).

- 5** Select a stitch.

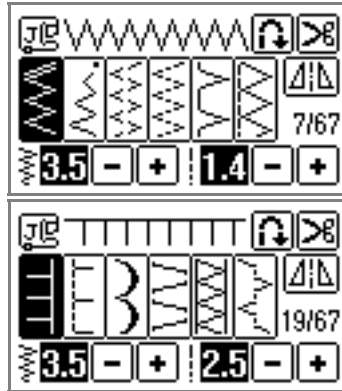

- For details, refer to "Selecting stitching" (page 45).

- 6** Turn the balance wheel toward you, and then begin sewing around the edge of the appliqué, making sure that the needle drops just outside of the appliqué.

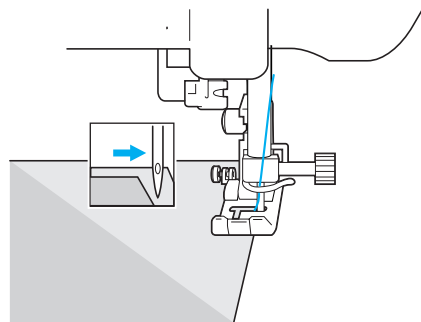

When sewing around corners, stop the machine with the needle in the fabric just outside of the appliqué, raise the presser foot lever, and then turn the fabric as needed to change the sewing direction.

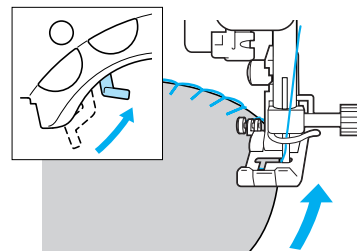

Patchwork (crazy quilt) stitching

- 1 Fold the edge of the top piece of fabric and place it over the lower piece.
- 2 Sew the two pieces of fabric together so the pattern spans over both pieces.

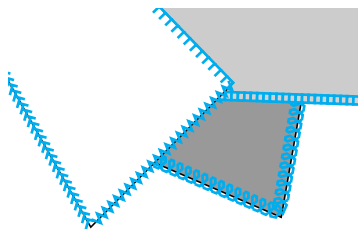
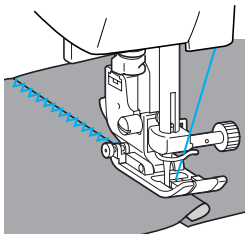

Piecing

Sewing together two pieces of fabric is called "piecing". The fabric pieces should be cut with a 7 mm (1/4 inch) seam allowance. Sew a piecing straight stitch 7 mm (1/4 inch) from either the right side or the left side of the presser foot.

- 1 Baste or pin along the seam allowance of the fabric that you wish to piece together.
- 2 Attach zigzag foot "J".

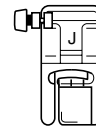

- For details, refer to "Replacing the presser foot" (page 38).

- 3 Select stitch 57  or 58 .

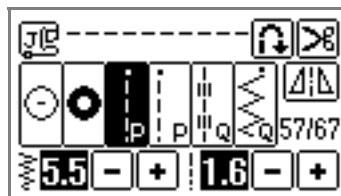

- For details, refer to "Selecting stitching" (page 45).
- The piecing straight stitch shows a "P" on the LCD.

- 4 Sew with the side of the presser foot aligned with the edge of the fabric.

■ For a seam allowance on the right side

Align the right side of the presser foot with the edge of the fabric, and sew using stitch 57 .

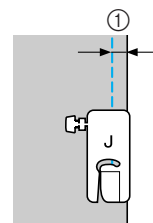

- ① 7 mm (1/4 inch)

■ For a seam allowance on the left side

Align the left side of the presser foot with the edge of the fabric, and sew using stitch 58 .

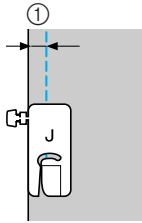

① 7 mm (1/4 inch)



Memo

- To change the width of the seam allowance (The needle position), adjust the stitch width. For details, refer to "Adjusting the stitch width" (page 54).

Quilting

Sandwiching batting between the top and bottom layers of fabric is called "quilting". Quilts can easily be sewn using the optional walking foot and the optional quilting guide.

- 1 **Baste the fabric to be quilted.**
- 2 **Remove the presser foot holder.**
 - For details, refer to "Removing the presser foot holder" (page 40).
- 3 **Hook the connecting fork of the walking foot onto the needle clamp screw.**

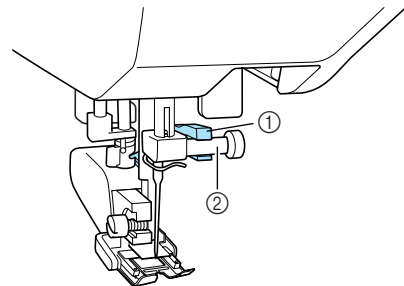

- ① Connecting fork
- ② Needle clamp screw

- 4 **Lower the presser foot lever, insert the presser foot holder screw, and then tighten the screw with the screwdriver.**

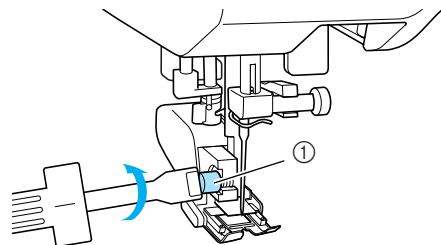

- ① Presser foot holder screw
- ▶ The walking foot is attached.

CAUTION

- Be sure to securely tighten the screws with the screwdriver, otherwise the needle may touch the presser foot, causing it to bend or break.
- Before starting to sew, slowly turn the balance wheel toward you and check that the needle does not touch the presser foot. If the needle hits the presser foot, the needle may bend or break.

5 Select a stitch.

- For details, refer to "Selecting stitching" (page 45).

6 Place one hand on each side of the presser foot, and then evenly guide the fabric while sewing.

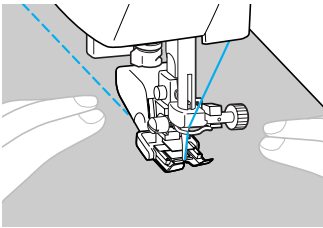

Note

- When sewing with the walking foot, sew at a speed between slow and medium.
- When quilting, use a 90/14 home sewing machine needle.

■ Using the optional quilting guide

Use the quilting guide to sew parallel stitches that are equally spaced.

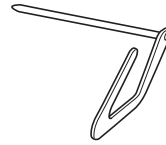

1 Insert the stem of the quilting guide into the hole at the rear of the walking foot or presser foot holder.

- Walking foot

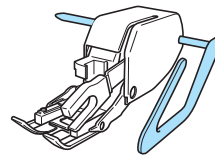

- Presser foot holder

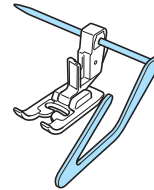

2 Adjust the stem of the quilting guide so that the quilt guide aligns with the seam that has already been sewn.

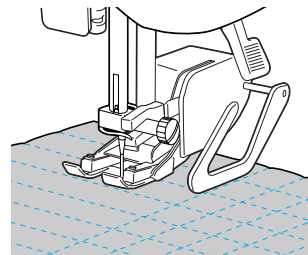

Free-motion quilting

With free-motion quilting, the feed dogs can be lowered (using the drop feed lever) so that the fabric can be moved freely in any direction. When using free-motion quilting, use the optional quilting foot or the embroidery foot "Q".



1 Remove the presser foot and the presser foot holder.

- Refer to "Removing the presser foot holder" (page 40).

2 Secure the quilting foot with the presser foot folder screw.

The pin on the quilting foot should be positioned over the needle clamp screw.

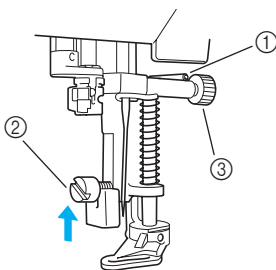

- ① Pin on quilting foot
- ② Presser foot holder screw
- ③ Needle clamp screw

3 Hold the quilting foot in place with your right hand, and then tighten the presser foot holder screw using the screwdriver in your left hand.

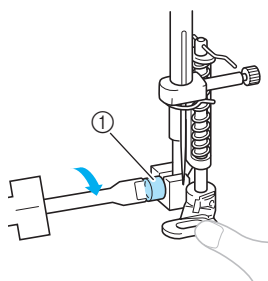

- ① Presser foot holder screw

CAUTION

- Be sure to securely tighten the screws with the screwdriver, otherwise the needle may touch the presser foot, causing it to bend or break.

4 Slide the drop feed lever, located at the rear of the machine on the base, to (to the left as seen from the rear of the machine).

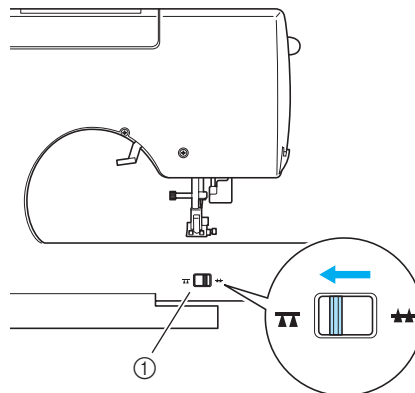

- ① Feed dog position switch (as seen from the rear of the machine)

▶ The feed dogs are lowered.

5 Turn on the sewing machine, and then select a stitch.

- For details, refer to "Selecting stitching" (page 45).

6 Use both hands to hold the fabric taut, and then move the fabric to follow the pattern.

Reinforcement stitches are sewn at the beginning and end of sewing.

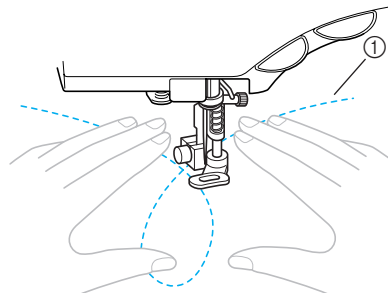

- ① Pattern

7 After sewing is finished, slide the drop feed lever to (to the right as seen from the rear of the machine) to raise the feed dogs.

- Normally, the drop feed lever is positioned at the right.

Satin stitching

A decorative stitch can be sewn by changing the stitch width of a satin stitch. If the sewing machine is set so that the stitch width can be adjusted using the sewing speed controller, the stitch width can quickly and easily be adjusted. In this case, the sewing speed is adjusted with the foot controller.

1 Connect the foot controller.

- For details, refer to "Starting to sew" (page 47).

2 Attach zigzag foot "J".

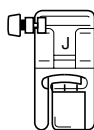

- For details, refer to "Replacing the presser foot" (page 38).

3 Turn on the sewing machine, and then press (Settings key) in the operation panel.



- ▶ The settings screen appears.

4 Press (Next page key) until "WIDTH CONTROL" is on LCD screen, and the press ON for stitch width control setting.



- ▶ The machine is now set so that the stitch width can be controlled with the sewing speed controller.

5 Press (Back key).



- ▶ The initial screen appears again.

6 Select stitch .

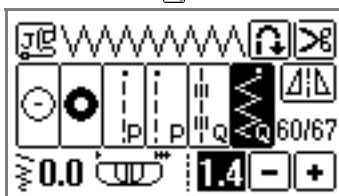

- For details, refer to "Selecting stitching" (page 45).

7 While sewing, slide the sewing speed controller to adjust the stitch width.

Slide the controller to the left to make the width narrower. Slide the controller to the right to make the width wider.

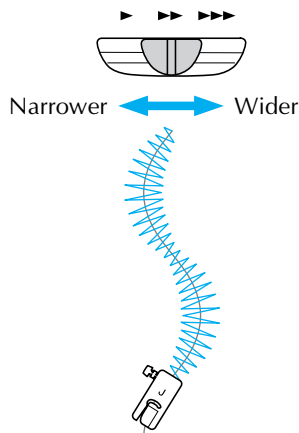

- Adjust the sewing speed with the foot controller.





8 When you are finished sewing, set the stitch width control setting back to OFF.

Memo

- Although the stitching result differs depending on the type of fabric being sewn and the thickness of the thread being used, for best results, adjust the stitch length to between 0.3 and 0.5 mm (1/64 and 1/32 inch).

Reinforcement Stitching

Reinforce points that will be subject to strain, such as sleeve holes, inseams and pocket corners.

Stitch Name	Pattern	Application	Stitch Width [mm (inch.)]		Stitch Length [mm (inch.)]		Presser Foot
			Auto	Manual	Auto	Manual	
Triple stretch stitch	4 	Reinforcing the seams of sleeves and inseams	0.0 (0)	0.0–7.0 (0–1/4)	2.5 (3/32)	1.5–4.0 (1/16–3/16)	J
Bar tack stitch	54 	Reinforcing the ends of openings, such as the corners of pockets	2.0 (1/16)	1.0–3.0 (1/16–1/8)	0.4 (1/64)	0.3–1.0 (1/64–1/16)	A
Darning stitch	52 	Darning mediumweight fabrics	7.0 (1/4)	2.5–7.0 (3/32–1/4)	2.0 (1/16)	0.4–2.5 (1/64–3/32)	
	53 	Darning thick fabrics	7.0 (1/4)	2.5–7.0 (3/32–1/4)	2.0 (1/16)	0.4–2.5 (1/64–3/32)	

Triple stretch stitching

Use triple stretch stitching to reinforce sleeve holes and inseams.

1 Attach zigzag foot "J".

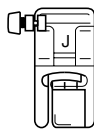

- For details, refer to "Replacing the presser foot" (page 38).

2 Select stitch 4 .

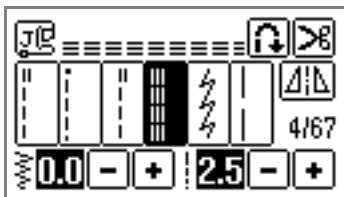

- For details, refer to "Selecting stitching" (page 45).

3 Start sewing.

- For details, refer to "Starting to sew" (page 47).

Bar tack stitching

Bar tacks are used to reinforce points subject to strain, such as pocket corners and openings.

As an example, the procedure for sewing bar tacks at pocket corners is described below.

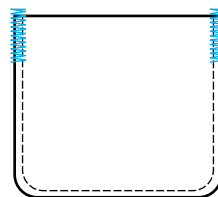

- #### 1 Determine the desired length of the bar tack.
- Set the button guide plate on buttonhole foot "A" to the desired length. (The distance between the markings on the presser foot scale is 5 mm (3/16 inch).)

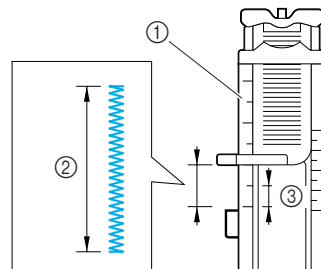

- ① Presser foot scale
- ② Length of bar tack
- ③ 5 mm (3/16 inch)

- A bar tack with a maximum length of about 28 mm (1–1/8 inch) can be sewn.

2 Attach buttonhole foot "A".

- For details, refer to "Replacing the presser foot" (page 38).

3 Select stitch ⁵⁴.



- For details, refer to "Selecting stitching" (page 45).

4 Position the fabric so that the opening of the pocket faces toward you, and then lower the presser foot lever so that the needle drops 2 mm (1/16 inch) in front of the pocket opening.

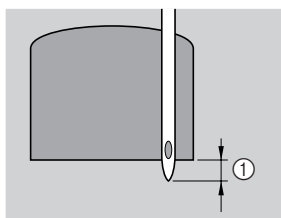

- ① 2 mm (1/16 inch)

Pass the upper thread down through the hole in the presser foot.

- When lowering the presser foot, do not push in the front of the presser foot, otherwise the bar tack will not be sewn with the correct size.

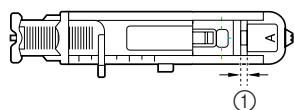
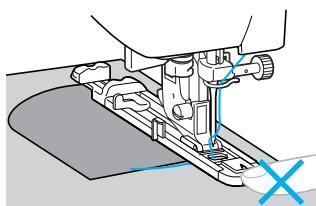

- ① Do not reduce the gap.

5 Pull down the buttonhole lever as far as possible.

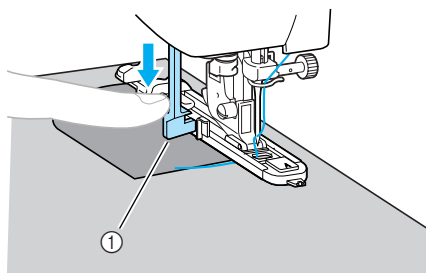

- ① Buttonhole lever

The buttonhole lever is positioned behind the bracket on the buttonhole foot.

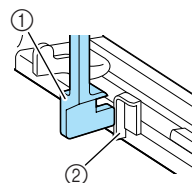

- ① Buttonhole lever
② Bracket

6 Gently hold the end of the upper thread in your left hand, and then start sewing.

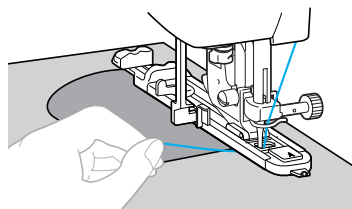

- Once sewing is completed, the machine automatically sews reinforcement stitches, then stops.

7 Raise the presser foot lever, remove the fabric, and then cut the threads.

8 Raise the buttonhole lever to its original position.

Memo

- If the fabric does not feed, for example, because it is too thick, increase the stitch length. For details, refer to "Adjusting the stitch length" (page 55).

Darning

Fabric that has been torn can be darned.
Darning is sewn as shown below.

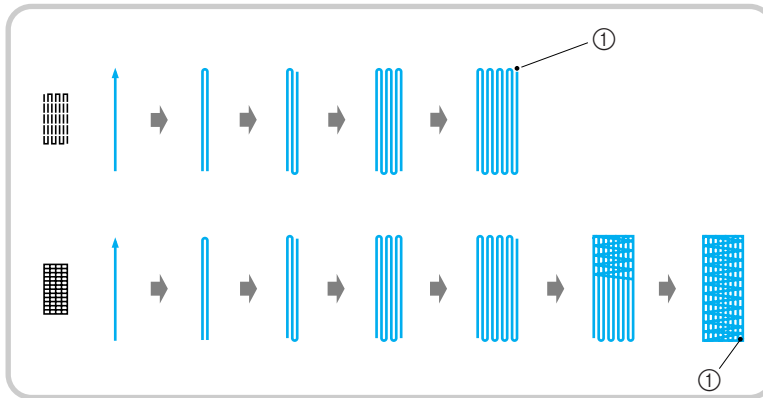

① Reinforcement stitching

- 1 Determine the desired length of the darning.**
Set the button guide plate on buttonhole foot "A" to the desired length. (The distance between the markings on the presser foot scale is 5 mm (3/16 inch).)

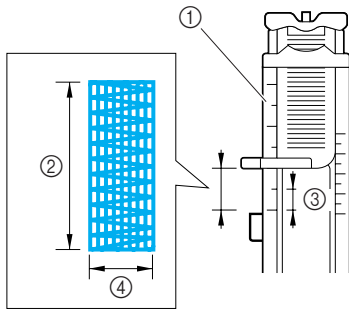

- ① Presser foot scale
- ② Length of darning
- ③ 5 mm (3/16 inch)
- ④ 7 mm (1/4 inch)

- A bar tack with a maximum length of about 28 mm (1-1/8 inch) can be sewn.

- 2 Attach buttonhole foot "A".**

- For details, refer to "Replacing the presser foot" (page 38).

- 3 Select stitch 52 or 53.**

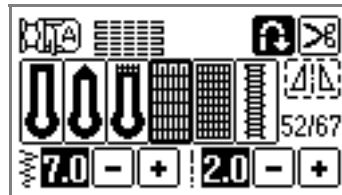

- For details, refer to "Selecting stitching" (page 45).

- 4 Position the fabric so that the needle is 2 mm (1/16 inch) in front of the area to be darned, and then lower the presser foot lever.**

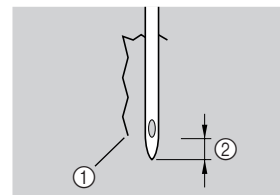

- ① Tear
- ② 2 mm (1/16 inch)

Pass the upper thread down through the hole in the presser foot.

- When lowering the presser foot, do not push in the front of the presser foot, otherwise the darning will not be sewn with the correct size.

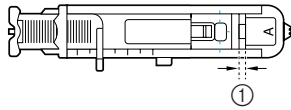
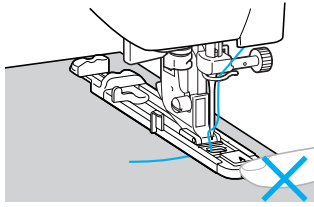

① Do not reduce the gap.

5 Pull down the buttonhole lever as far as possible.

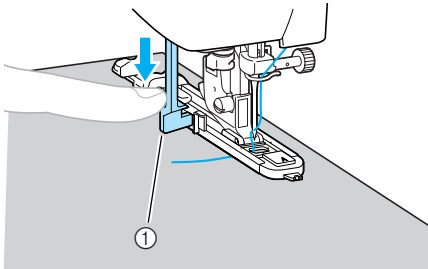

① Buttonhole lever

The buttonhole lever is positioned behind the bracket on the buttonhole foot.

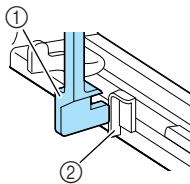

① Buttonhole lever
② Bracket

6 Gently hold the end of the upper thread in your left hand, and then start sewing.

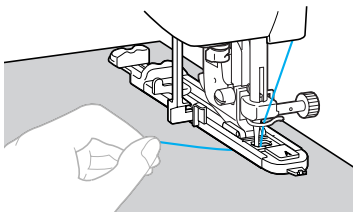

▶ Once sewing is completed, the machine automatically sews reinforcement stitches, then stops.

7 Raise the presser foot lever, remove the fabric, and then cut the threads.

8 Raise the buttonhole lever to its original position.



Memo

- If the fabric does not feed, for example, because it is too thick, increase the stitch length. For details, refer to "Adjusting the stitch length" (page 55).

Eyelet Stitching

Eyelets, such as those on belts, can be sewn. Three sizes of eyelets are possible: 7 mm, 6 mm and 5 mm (1/4, 15/64 and 3/16 inch).

Stitch Name	Pattern	Application	Stitch Width [mm (inch.)]		Stitch Length [mm (inch.)]		Presser Foot
			Auto	Manual	Auto	Manual	
Eyelet stitch	56 	Sewing eyelets, for example, on belts	7.0 (1/4)	7.0, 6.0 or 5.0 (1/4, 15/64 or 3/16)	7.0 (1/4)	7.0, 6.0 or 5.0 (1/4, 15/64 or 3/16)	N

1 Attach monogramming foot "N".

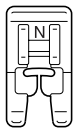

- For details, refer to "Replacing the presser foot" (page 38).

2 Select stitch 56 .

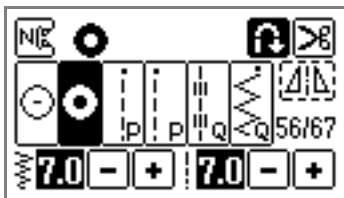

- For details, refer to "Selecting stitching" (page 45).

3 Adjust either the stitch width or the stitch length to select the desired eyelet size.

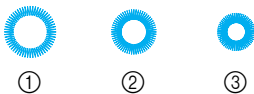

- ① 7mm
- ② 6mm
- ③ 5mm

- For details, refer to "Adjusting the Stitch Width and Length" (page 54).

4 Lower the needle into the fabric at the beginning of the stitching, and then lower the presser foot lever.

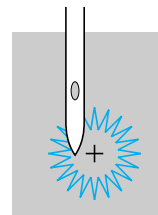

5 Start sewing.

- ▶ Once sewing is completed, the machine automatically sews reinforcement stitches, then stops.

6 Use the eyelet punch to cut a hole in the center of the eyelet.

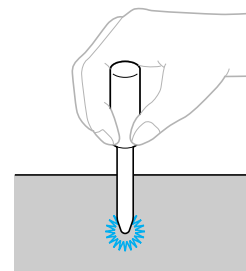

















- When using the eyelet punch, place thick paper or some other protective sheet under the fabric before punching the hole in the fabric.

Memo

- If thin thread is used, the stitching may be too open. If this occurs, sew the eyelet twice before removing the fabric, one on top of the other.

Decorative Stitching

The utility stitch group contains the following decorative stitches.

Stitch Name	Pattern	Application	Stitch Width [mm (inch.)]		Stitch Length [mm (inch.)]		Presser Foot	
			Auto	Manual	Auto	Manual		
Fagoting stitch	26 	Sewing two pieces of fabric together across an open seam	5.0 (3/16)	0.0–7.0 (0–1/4)	2.5 (3/32)	1.0–4.0 (1/16–3/16)	J	
	27 		5.0 (3/16)	2.5–7.0 (3/25–1/4)	2.5 (3/32)	1.0–4.0 (1/16–3/16)		
Joining stitch	22 	Decorative bridging stitches	4.0 (3/16)	0.0–7.0 (0–1/4)	1.2 (1/16)	0.2–4.0 (1/64–3/16)		
	23 		5.0 (3/16)	2.5–7.0 (3/32–1/4)	2.5 (3/32)	1.0–4.0 (1/16–3/16)		
	24 		5.0 (3/16)	0.0–7.0 (0–1/4)	1.2 (1/16)	0.2–4.0 (1/64–3/16)		
Shell tuck stitch	20 	Shell tuck stitching on collars and curves	4.0 (3/16)	0.0–7.0 (0–1/4)	2.5 (3/32)	0.2–4.0 (1/64–3/16)		
Smocking stitch	25 	Smocking fabrics to add texture and elasticity	5.0 (3/16)	0.0–7.0 (0–1/4)	1.6 (1/16)	1.0–4.0 (1/16–3/16)		
	26 		5.0 (3/16)	0.0–7.0 (0–1/4)	2.5 (3/32)	1.0–4.0 (1/16–3/16)		
	27 		5.0 (3/16)	2.5–7.0 (3/32–1/4)	2.5 (3/32)	1.0–4.0 (1/16–3/16)		
Scallop stitch	21 	Satin scallop stitching	5.0 (3/16)	2.5–7.0 (3/32–1/4)	0.5 (1/32)	0.1–1.0 (1/64–1/16)		
Decorative stitch	33 	Lace sewing, decorative hemming, heirloom stitching, etc.	3.5 (1/8)	1.5–7.0 (1/16–1/4)	2.5 (3/32)	1.6–4.0 (1/16–3/16)		N
	34 		6.0 (15/64)	1.5–7.0 (1/16–1/4)	3.0 (1/8)	1.5–4.0 (1/16–3/16)		
	35 	Decorative hemming and heirloom stitching, etc. on thin, mediumweight and plain weave fabrics	5.0 (3/16)	1.5–7.0 (1/16–1/4)	3.5 (1/8)	1.5–4.0 (1/16–3/16)		
	36 		5.0 (3/16)	1.5–7.0 (1/16–1/4)	4.0 (3/16)	1.5–4.0 (1/16–3/16)		
	37 		5.0 (3/16)	1.5–7.0 (1/16–1/4)	2.5 (3/32)	1.5–4.0 (1/16–3/16)		
	38 		5.0 (3/16)	1.5–7.0 (1/16–1/4)	2.0 (1/16)	1.5–4.0 (1/16–3/16)		
	39 	Decorative hemming, ribbon threading, heirloom stitching, etc.	5.0 (3/16)	1.5–7.0 (1/16–1/4)	3.0 (1/8)	1.5–4.0 (1/16–3/16)		

Stitch Name	Pattern	Application	Stitch Width [mm (inch.)]		Stitch Length [mm (inch.)]		Presser Foot
			Auto	Manual	Auto	Manual	
Decorative stitch	40	Heirloom stitching, etc.	6.0 (15/64)	1.5-7.0 (1/16-1/4)	1.6 (1/16)	1.0-4.0 (1/16-3/16)	N
	41		5.0 (3/16)	1.5-7.0 (1/16-1/4)	1.6 (1/16)	1.0-4.0 (1/16-3/16)	
	29	Decorative stitching	4.0 (3/16)	0.0-7.0 (0-1/4)	3.0 (1/8)	2.0-4.0 (1/16-3/16)	J
	30		4.0 (3/16)	0.0-7.0 (0-1/4)	2.5 (3/32)	1.0-4.0 (1/16-3/16)	
	31		5.5 (7/32)	0.0-7.0 (0-1/4)	1.6 (1/16)	1.0-4.0 (1/16-3/16)	
	32		5.0 (3/16)	1.5-7.0 (1/16-1/4)	1.0 (1/16)	0.2-4.0 (1/64-3/16)	

Fagoting

Stitching across an open seam is called "fagoting". It is used on blouses and children's clothing. This stitch is more decorative when thicker thread is used.

- Use an iron to fold the two pieces of fabric along their seams.
- Baste the two pieces of fabric, separated by about 4 mm (3/16 inch), onto thin paper or a sheet of water-soluble stabilizer. If you draw a line down the middle of the thin paper or water-soluble stabilizer, sewing is easier.

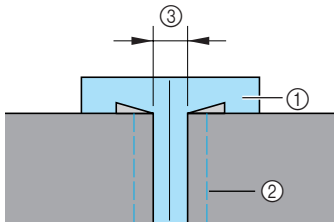

- ① Thin paper or water soluble stabilizer
- ② Basting stitching
- ③ 4 mm (3/16 inch)

- Attach zigzag foot "J".

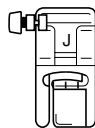

- For details, refer to "Replacing the presser foot" (page 38).

- Select stitch 26 or 27 .



- For details, refer to "Selecting stitching" (page 45).

- Set the stitch width to 7.0 mm (1/4 inch).

- For details, refer to "Adjusting the stitch width" (page 54).

- Sew with the center of the presser foot aligned along the center of the two pieces of fabric.

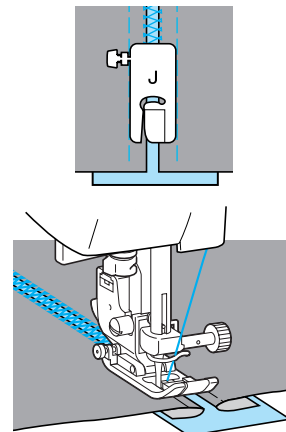

- After sewing is finished, remove the paper.

Scallop stitching

The wave-shaped repeating pattern that looks like shells is called "scalloping". It is used on the collars of blouses and to decorate the edges of projects.

1 Attach monogramming foot "N".

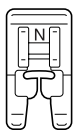

- For details, refer to "Replacing the presser foot" (page 38).

2 Select stitch ²¹ 3.

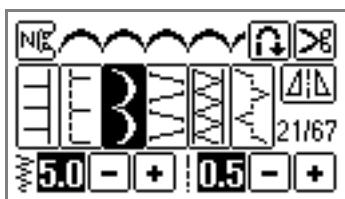

- For details, refer to "Selecting stitching" (page 45).

3 Stitch along the edge of the fabric, making sure not to sew directly on the edge of the fabric.

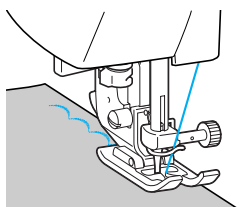

- For better results, apply spray starch onto the fabric and press with a hot iron before it is sewn.

4 Trim along the stitches.

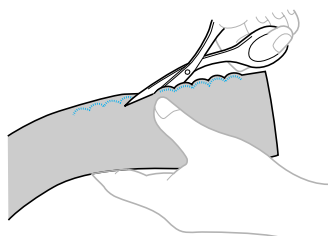

- Be careful not to cut the stitches.

Smocking

The decorative stitch created by stitching or embroidering over gathers is called "smocking". It is used to decorate the front of blouses or cuffs. The smocking stitch adds texture and elasticity to fabric.

1 Attach zigzag foot "J".

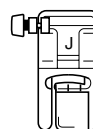

- For details, refer to "Replacing the presser foot" (page 38).

2 Select the straight stitch, and then adjust the stitch length to 4.0 mm (3/16 inch) and loosen the thread tension.

- For details, refer to "Adjusting the stitch length" (page 55) and "Thread tension" (page 52).
- Pull up the bobbin thread. For details, refer to "Pulling up the bobbin thread" (page 31).

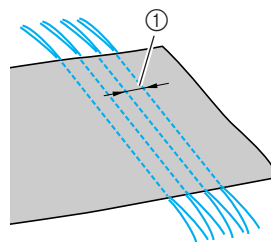

3 Sew parallel stitching at intervals of 1 cm (3/8 inch).

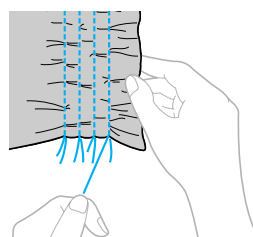

- ① 1 cm (3/8 inch)
- Do not use reverse/reinforcement stitching or thread cutting.
- At the end of the stitching, the thread is pulled out about 5 cm (2 inch).

4 Pull the bobbin threads to create gathers. Smooth the gathers by ironing them.



- 5 Select stitch ,  or .

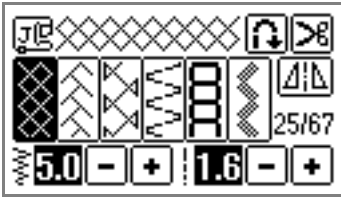

- For details, refer to "Selecting stitching" (page 45).

- 6 Stitch between the straight stitches.

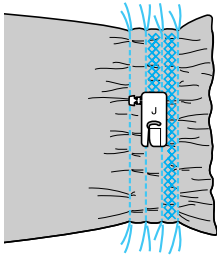

- 7 Pull out the threads for the straight stitches.

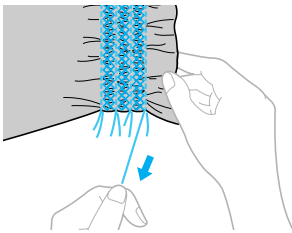

Shell tuck stitching

The gathers that look like shells are called "shell tucks". They are used to decorate trims, the front of blouses or cuffs made of thin fabrics.

- 1 Fold the fabric along the bias.

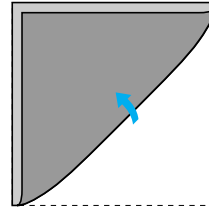

- 2 Attach zigzag foot "J".

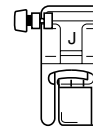

- For details, refer to "Replacing the presser foot" (page 38).

- 3 Select stitch , and then increase the thread tension.

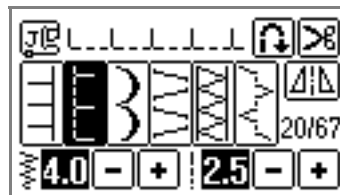

- For details, refer to "Selecting stitching" (page 45) and "Changing the upper thread tension" (page 53).

- 4** Sew while making sure that the needle drops slightly off the edge of the fabric.

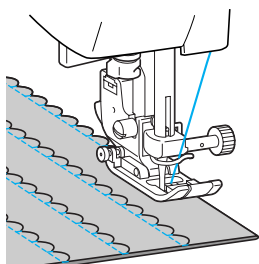
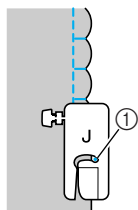

① Needle drop point

- 5** Unfold the fabric, and then iron the tucks down to one side.

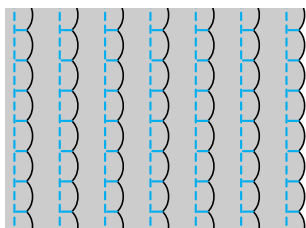

Joining

Decorative bridging stitches can be sewn over the seam allowance of joined fabrics. This is used when making a crazy quilt.

- 1** Attach zigzag foot "J".

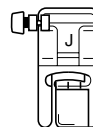

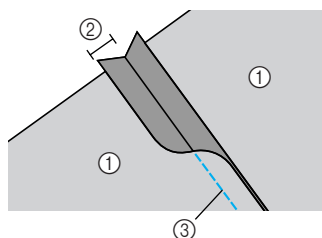

- For details, refer to "Replacing the presser foot" (page 38).

- 2** Sew together the right sides of the two pieces of fabric, and then open up the seam allowances.



- ① Wrong side of fabric
- ② 7 mm (1/4 inch) seam allowance
- ③ Straight stitch

- 3** Select stitch ²² , ²³  or ²⁴ .



- For details, refer to "Selecting stitching" (page 45).

- 4** Turn the fabric over so that the right side faces up, and then sew over the seam with the center of the presser foot aligned with the seam.

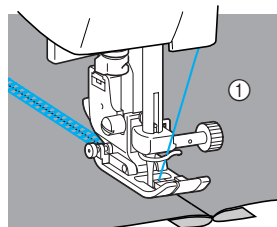

① Right side of fabric

Heirloom stitching

When sewing with the wing needle, the needle holes are enlarged, creating a lace-like decorative stitch. This is used to decorate hems and tablecloths on thin or mediumweight fabrics in addition to plain weave fabrics.

1 Install the wing needle.







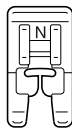



- Use a 130/705H 100/16 wing needle.
- For details on installing a needle, refer to "Replacing the needle" (page 35).
- The needle threader cannot be used with the wing needle, otherwise the sewing machine may be damaged. Manually pass the thread through the eye of the needle from the front to the back.
For details, refer to "Thread the needle manually (without using the needle threader)" (page 28).

2 Attach monogramming foot "N".



- For details, refer to "Replacing the presser foot" (page 38).

3 Select a stitch.

The stitches that can be used are ³³, ³⁴, ³⁵, ³⁶, ³⁷, ³⁸, ³⁹, ⁴⁰ or ⁴¹.



- For details, refer to "Selecting stitching" (page 45).
- When sewing with the wing needle, select a stitch width of 6.0 mm (15/64 inch) or less.

4 Start sewing.

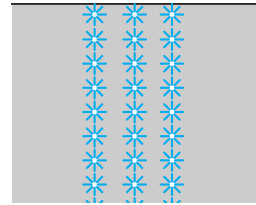

CAUTION

- When sewing with the wing needle, select a stitch width of 6.0 mm (15/64 inch) or less, otherwise the needle may bend or break.
- After adjusting the stitch width, slowly turn the balance wheel toward you and check that the needle does not touch the presser foot. If the needle hits the presser foot, the needle may bend or break.

Partially removing threads is called "drawnwork". This gives a beautiful result with fabrics that have a loose weave. Two ways to create drawnwork are described below.

■ Drawnwork (Example 1)

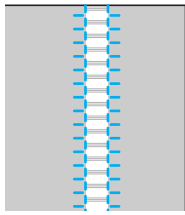

- ① Pull out several threads from the fabric.

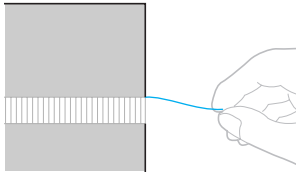

- ② Attach monogramming foot "N".

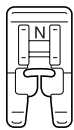

- For details, refer to "Replacing the presser foot" (page 38).

- ③ Select stitch ³³ [E].

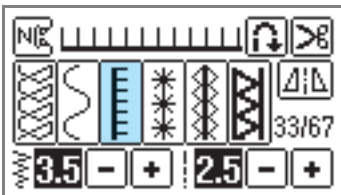

- For details, refer to "Selecting stitching" (page 45).

- ④ With the right side of the fabric facing up, sew along the right edge of the frayed section.

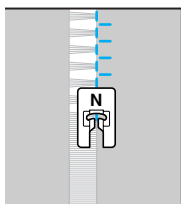

- ⑤ Press [Δ/Δ] on the LCD.

▶ The pattern is flipped.

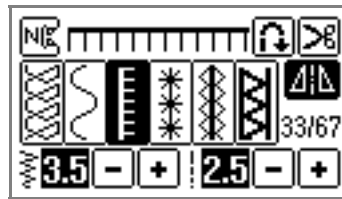

- ⑥ Sew along the other edge of the frayed section so that it looks like the previous stitching.

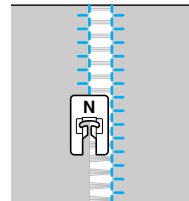

- ⑦ Press [Δ/Δ], and set the horizontal mirror image key back to OFF.

■ Drawwork (Example 2)

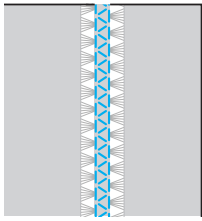

- 1 Pull out several threads from two sections of the fabric, separated by an unfrayed section of about 4 mm (3/16 inch).

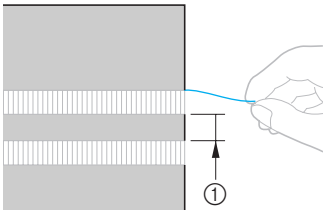

① 4 mm (3/16 inch)

- 2 Attach monogramming foot "N".

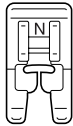

- For details, refer to "Replacing the presser foot" (page 38).

- 3 Select stitch .



- For details, refer to "Selecting stitching" (page 45).

- 4 Sew along the center of the unfrayed section.

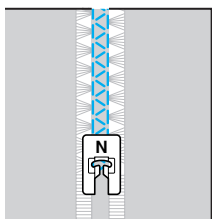



4

EMBROIDERY

The steps for embroidering will be explained here.

Embroidering neatly	112
Attaching the embroidery foot	115
Attaching the embroidery unit	118
Preparing the fabric.....	122
Attaching the embroidery frame	126
Selecting embroidery patterns.....	128
Embroidering.....	134
Convenient Functions.....	138

Embroidering neatly

What is necessary before embroidering will be explained here.

What to prepare

The following is necessary for embroidering.

■ Fabric

Prepare the fabric for embroidery. Prepare a piece of fabric a little larger than the embroidery frame that matches the size of the pattern you want to sew.



Note

- Always use stabilizer when sewing embroidery projects, especially when embroidering on lightweight or stretch fabrics. Not using a stabilizer may result in poor quality embroidery designs.
- When embroidering on large pieces of fabric, arrange the fabric so that it does not hang off the table where the sewing machine is placed. If embroidery is done with the fabric hanging off, the embroidery unit movement may be impaired, this could cause the pattern to sew incorrectly.



CAUTION

- **Do not embroider fabrics that are too thick. To check the fabric thickness, attach the embroidery frame to the embroidery unit, and use the "Needle Position" button to raise the needle. If there is space between the presser foot and the fabric, the fabric can be embroidered. If there is not space, do not embroider the fabric. Otherwise, the needle may break, resulting in injury.**
- **Be careful when sewing overlapping patterns. The needle may not easily pierce the fabric, causing the needle to break.**

■ Stabilizer material

Attach a stabilizer material for embroidery to the fabric to prevent poor quality embroidery designs.



We recommend stabilizer material for embroidery. Use a water soluble sheet on thin materials like organza and fabrics with a nap like towels.

■ Embroidery thread

For the upper thread, use the embroidery thread or country thread.

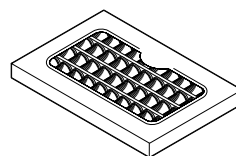

For the bobbin thread, use the embroidery bobbin thread.



Note

- For good quality embroidery designs be sure to use embroidery thread designed for embroidery machines.
- Before starting to sew, be sure there is enough bobbin thread. If you continue embroidering when the bobbin thread is low, the thread may become tangled.



Memo

- Two thread cassettes for setting up embroidery thread are included. It is convenient if the next color to embroider is set up in another embroidery thread cassette while the one is embroidering.

■ Needle

Use a 75/11 home sewing machine needle. When embroidering on thick fabrics such as denim, use a 90/14 home sewing machine needle.



Memo

- A 75/11 needle is already installed when the sewing machine is purchased.
- When replacing the needle, refer to "Replacing the needle" (page 35).



CAUTION

- **Since ball point needles (gold colored) are needles for fabrics where stitches are easily skipped, such as pattern stitching and stretch fabrics, be absolutely sure not to use them for embroidery. The needle may be broken or bent.**

Embroidery step by step

The basic steps for embroidery are as follows.

1	Presser foot attachment	Attach the embroidery foot "Q". For details on attaching the embroidery foot, refer to "Attaching the embroidery foot" (on the next page)
↓		
2	Checking the needle	Use a needle matched to the fabric. For details on replacing the needle, refer to "Replacing the needle" (page 35).
↓		
3	Embroidery unit attachment	Attach the embroidery unit. For details on attaching the embroidery unit, refer to "Attaching the embroidery unit" (page 118).
↓		
4	Bobbin thread setup	For the bobbin thread, wind embroidery bobbin thread and set it in place. For details on setting up the bobbin thread, refer to "Winding/Installing the Bobbin" (page 16).
↓		
5	Fabric preparation	Attach a stabilizer material to the fabric, and hoop it in an embroidery frame. For details on preparing the fabric, refer to "Preparing the fabric" (page 122).
↓		
6	Embroidery frame attachment	Attach the embroidery frame to the embroidery unit. For details on attaching the embroidery frame, refer to "Attaching the embroidery frame" (page 126).
↓		
7	Pattern selection	Turn the power on, and select an embroidery pattern. For details on selecting embroidery patterns, refer to "Selecting embroidery patterns" (page 128).
↓		
8	Checking the layout	Check and adjust the size and position of the embroidery. For details on adjusting the layout, refer to "Adjusting the layout" (page 138).
↓		
9	Embroidery thread setup	Set up embroidery thread according to the pattern. For details on the thread setup steps, refer to "Upper Threading" (page 21).

Attaching the embroidery foot

Attachment of the embroidery foot is explained here.

Attaching the embroidery foot

Attach the embroidery foot when embroidering. Have the included embroidery foot "Q" and a screwdriver ready.

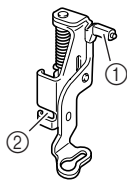

- ① Embroidery foot bar
- ② Caught by the presser foot holder

CAUTION

- Always use the embroidery foot "Q" when embroidering. If the wrong presser foot is used, the needle may hit the presser foot and break or bend.

- 1 Press  (Needle position button) once or twice to raise the needle.

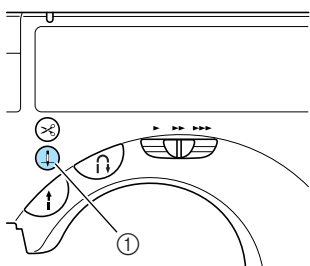

- ① The needle goes up.

- 2 Turn off the sewing machine.

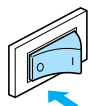

CAUTION

- Before replacing the presser foot, be sure to turn off the sewing machine, otherwise injuries may occur if the start/stop button is accidentally pressed and the machine starts sewing.

- 3 Raise the presser foot lever.

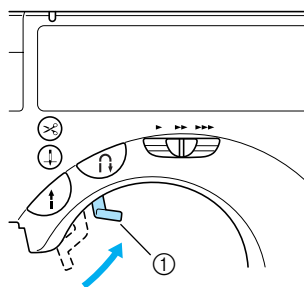

- ▶ The presser foot is raised.

- At the time of purchase, the presser foot lever is up.

- 4 Press and hold the black button on the back of the presser foot holder to release it.

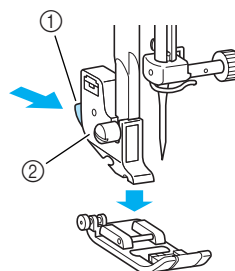

- ① Black button
- ② Presser foot holder

- ▶ Detach the presser foot from the presser foot holder.

5 Loosen the presser foot holder screw and remove the presser foot holder.

Turn the screwdriver toward the back.

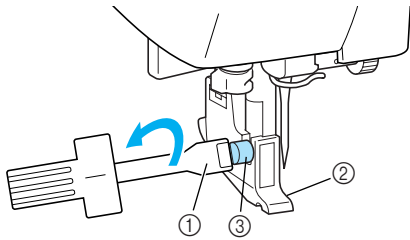

- ① Screwdriver
- ② Presser foot holder
- ③ Presser foot holder screw

▶ Remove the presser foot holder.

6 Set the bar on the embroidery foot onto the needle clamp screw bar.

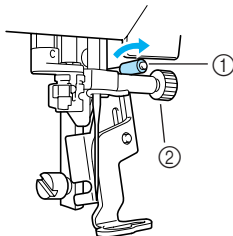

- ① Embroidery foot bar
- ② Needle clamp screw

7 Secure the embroidery foot with the presser foot holder screw.

Set the embroidery foot perpendicular.

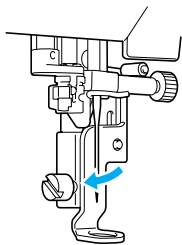

8 Tighten the presser foot holder screw.

Turn the screwdriver toward the front.

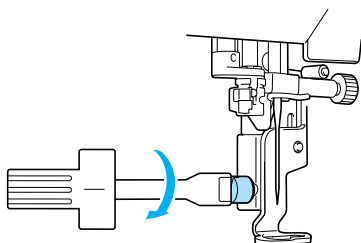

! CAUTION

- Do not hit the needle with your finger or the embroidery foot "Q" when attaching it. The needle might break or cause injury.
- Be sure to tighten the screw with the included screwdriver. If the screw is loose, the needle might hit the presser foot and break or bend.
- Before sewing, always turn the balance wheel toward you slowly, and check to be sure that the needle does not hit the presser foot. The needle could be broken or bent.

Removing the embroidery foot

- 1 Press \updownarrow (Needle position button) once or twice to raise the needle.

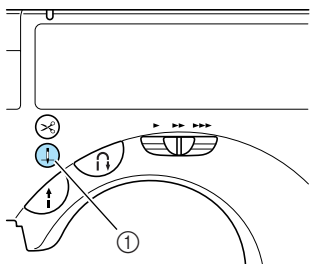

► The needle is raised.

- 2 Turn off the sewing machine.

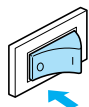

- 3 Raise the presser foot lever.

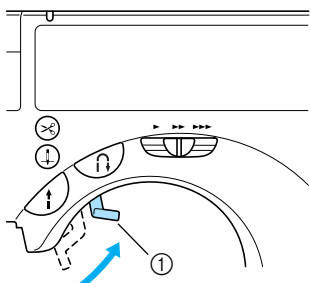

① Presser foot lever

► The presser foot is raised.

- 4 Loosen the presser foot holder screw and remove the embroidery foot "Q".

Turn the screwdriver toward the back.

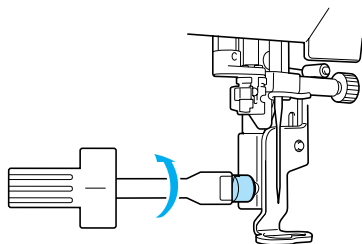

- 5 Attach the presser foot holder.

- For details, refer to "Attaching the presser foot holder" (page 40).

Attaching the embroidery unit

Attach the embroidery unit for embroidering.

Embroidery unit precautions

Cautions for the embroidery unit will be explained here.

CAUTION

- Do not move the sewing machine with the embroidery unit in place. The embroidery unit may be dropped and cause injury.
- Do not bring your hands or anything else close when the embroidery carriage and embroidery frame are moving. It could cause injury.



Note

- Do not touch the connector in the embroidery unit connector slot. The connector could be damaged, and it could be a cause of malfunctions.
- Do not lift up on the embroidery carriage, and do not forcefully move it. It could be the cause of malfunctions.

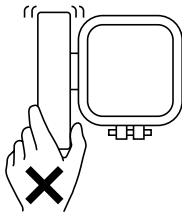

- Put the cover on the embroidery unit for storage.

Attaching the embroidery unit

Get the included embroidery unit ready.

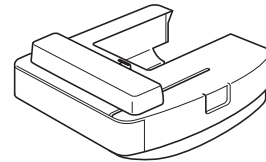

- 1 Turn off the sewing machine.

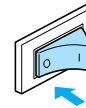

- 2 Pull the flap to the left and remove it.

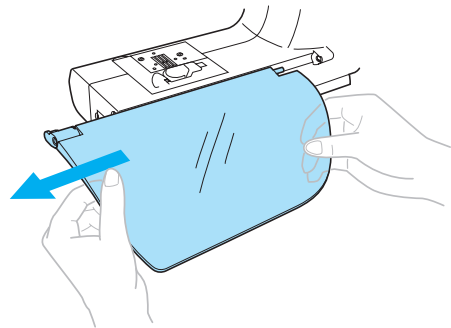

3 Open the cover of the embroidery unit connector slot, which is on the left side of the sewing machine arm.

Pull the cover open toward you and then push it all the way back into the slot.

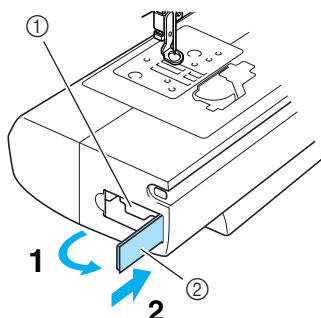

- ① Embroidery unit connector slot
- ② Cover

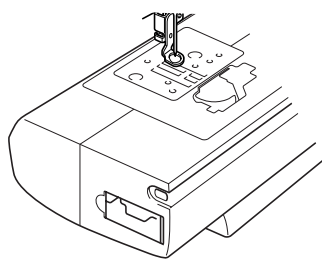

CAUTION

- Push the cover all the way back into the slot. If the embroidery unit is attached without the cover being pushed all the way in, it could be the cause of malfunctions.

4 Slide the embroidery unit onto the sewing machine arm.

Push it in until it clicks and stops.

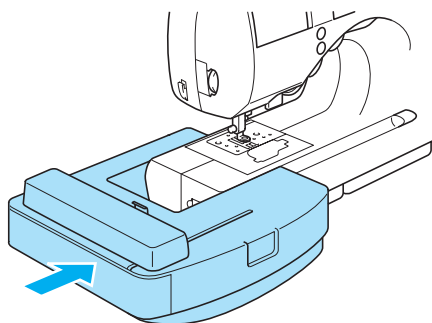

▶ The embroidery unit is attached.

5 Turn on the sewing machine.

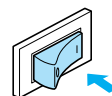

▶ A message will be displayed on the LCD.

6 Be sure that no objects or hands are near the embroidery unit and touch **OK** on the LCD.

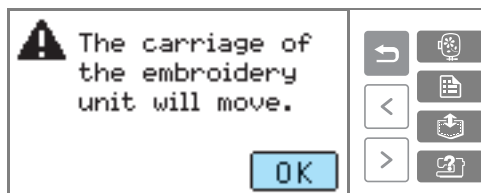

- When an animation is displayed on the LCD, the message above will be displayed if you touch the LCD with your finger.

▶ The embroidery unit carriage moves to its initial position.

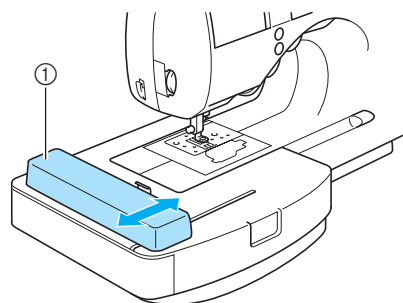

① Carriage

CAUTION

- Do not put your hands or anything else near the carriage. It could cause injury.



Note

- If the initial settings are made with hands or objects near the carriage, the LCD may return to the initial display. In such a case, turn the power on again after removing whatever is near the carriage.

- ▶ The screen for selecting the embroidery pattern group is displayed.

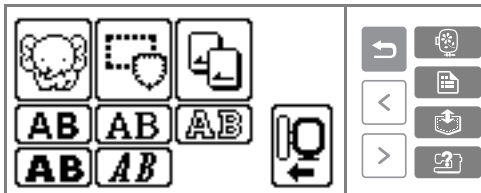

- For details on Embroidery patterns, refer to "Selecting embroidery patterns" (page 128).



Memo

- Utility stitches cannot be selected when the embroidery unit is attached.

Removing the embroidery unit

After removing the embroidery frame, turn off the machine and remove the embroidery unit.

- 1 Be sure that the sewing machine is stopped.

- 2 Remove the embroidery frame.
 - For details on removing the embroidery frame, refer to "Removing the embroidery frame" (page 127).

- 3 Press  on the LCD.

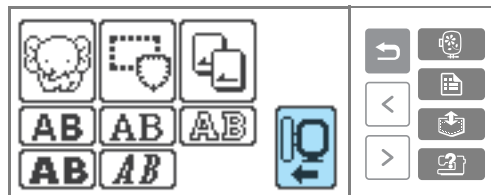

- ▶ The embroidery carriage moves into a position where it can be stored.

- 4 Turn off the sewing machine.

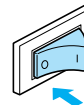

CAUTION

- Always turn off the sewing machine before removing the embroidery unit. It could cause malfunctions if removed when the machine was turned on.

- 5** Hold the removal lever on the bottom left of the embroidery unit, and slowly pull the embroidery unit to the left.

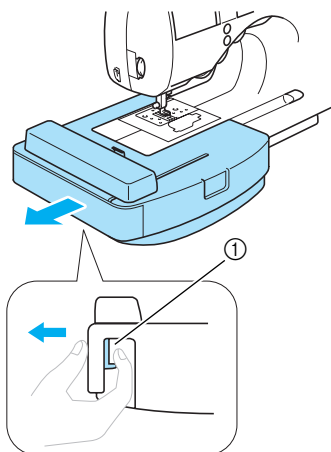

① Removal lever

- ▶ The embroidery unit separates from the sewing machine.

- 6** Close the cover on the embroidery unit connector slot on the sewing machine. After the cover is pulled out, snap it shut.

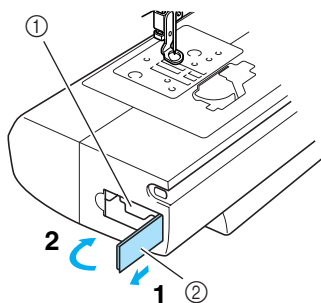

① Embroidery unit connector slot
② Cover

- 7** Install the flap back to its original position.

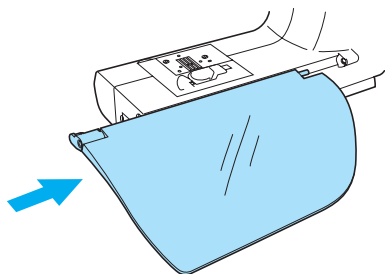

Memo

- The embroidery unit can be stored with embroidery frame (medium) or (small) attached.

Preparing the fabric

After attaching a stabilizer material to the embroidery fabric, it is stretched on an embroidery frame.

Attaching a stabilizer material to the fabric

Attach a stabilizer material for embroidery to the fabric to prevent poor quality embroidery designs.

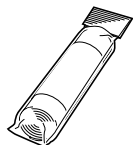

Memo

- We recommend the stabilizer material for embroidery. Use a water soluble stabilizer on thin materials like organdy and fabrics with a nap like towels.



Note

- Always use stabilizer material for embroidery with stretch fabrics, thin fabrics, fabrics with a loose weave and fabrics where stitches easily contract.



CAUTION

- Always use stabilizer material when sewing embroidery projects. The needle may break or bend if you embroider without using a stabilizer material for thin fabrics or stretch fabrics. Furthermore, the pattern may be sewn incorrectly.

- 1 Prepare stabilizer material that is larger than the embroidery frame being used.

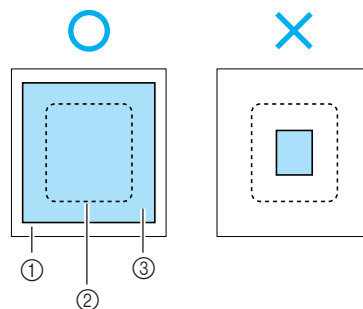

- ① Fabric
- ② Size of embroidery frame
- ③ Stabilizer material

- 2 If you are using stabilizers with adhesive, place the adhesive surface of the stabilizer material against the back of the fabric, and iron it with a steam iron.

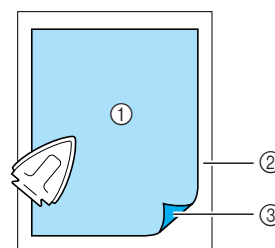

- ① Stabilizer material
- ② Fabric (reverse side)
- ③ Attached surface

- When it cannot be ironed or placed in the hoop.

For fabrics, such as towels, which cannot be ironed or for embroidering in places where ironing is difficult, place the stabilizer material under the fabric, and stretch it on the embroidery frame without attaching it.

Setting the fabric in the embroidery frame

The fabric is stretched on the embroidery frame. If the fabric is loose, the quality of the embroidery pattern may be poor. Put the fabric in the frame without slack following the steps below. Have a fabric with a stabilizer material attached and the embroidery frame (medium), (small) and (large) ready.

■ Embroidery set (medium)

Patterns with a height of up to 10 cm (4 inch) and a width of up to 10 cm (4 inch) can be sewn.

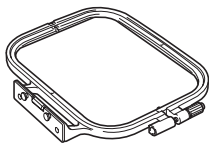

■ Embroidery frame (small) (optional)

Patterns with a height of up to 2 cm (1 inch) and a width of up to 6 cm (2-1/2 inch) can be sewn. This is used for letters and other small embroidery.

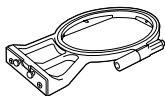

- There are patterns for which embroidery frame (small) cannot be used.

■ Embroidery frame (large) (optional)

Embroidery can be done in an area with a height of up to 17 cm (6-7/10 inch) and a width of up to 10 cm (4 inch). This is used to embroider multiple patterns without changing the fabric position in the frame.

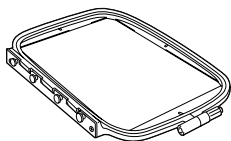

! CAUTION

- Use the embroidery frame that matches the size of the pattern being embroidered. If the wrong size embroidery frame is used, the embroidery frame may be hit by the presser foot and cause injury or needle breakage.

- 1 Loosen the embroidery frame adjustment screw and remove the inner and outer frames, placing the outer frame on a flat surface. Separate the inner and outer frame by removing inner frame upward.

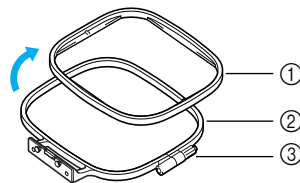

- ① Inner frame
- ② Outer frame
- ③ Adjustment screw

- 2 Place the fabric with the stabilizer material on top of the outer frame.

Have the front side of the cloth up.

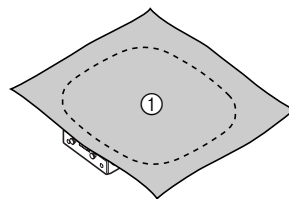

- ① Front

- 3 Press the inner frame in from the top of the fabric.

Line up \triangle on the inner frame and ∇ on outer frame.

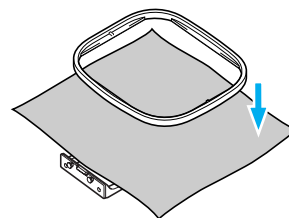

- 4 Tighten the adjustment screw by hand just enough to secure the fabric.

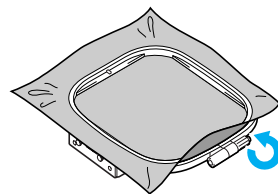

- 5 Gently remove the fabric from the frame without loosening the adjustment screw.

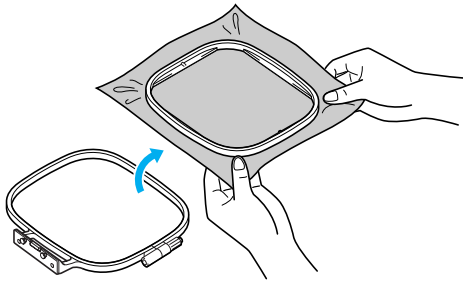

Memo

- This precautionary step will help reduce pattern distortion while embroidering.

- 6 Press the inner frame in from the top of the fabric again, lining up \triangle on the inner frame and ∇ on outer frame.

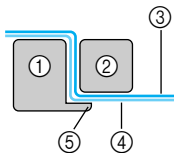
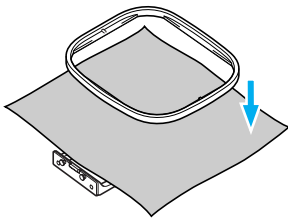

- ① Outer frame
- ② Inner frame
- ③ Fabric (front)
- ④ Stabilizer material
- ⑤ Ledge of outer frame

- Press down firmly until the inner frame is securely pressed against the ledge of the outer frame.

- 7 Tighten the adjustment screw while removing any slack in the fabric by hand. The goal is to have a drum-like sound when the stretched fabric is struck lightly.

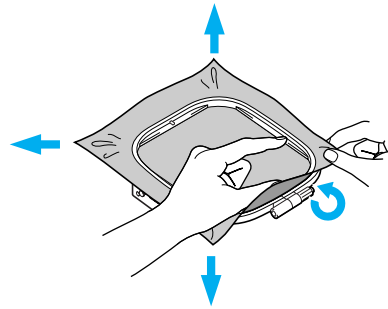

■ Using embroidery sheets

If the embroidery sheet attached to the embroidery frame is used, the embroidery can be sewn in exactly the right position on the fabric.

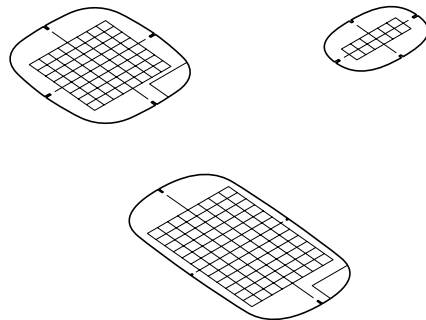

- ① Make a mark with a chalk pen at the center of the position for the pattern to be embroidered.

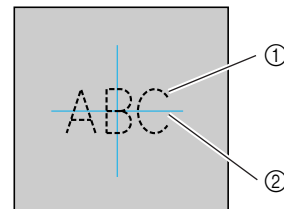

- ① Embroidery pattern
- ② Mark

2 Place the embroidery sheet on the inner frame.

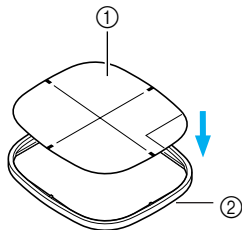

- ① Embroidery sheet
- ② Inner frame

3 Line the mark on the fabric up with the base line on the embroidery sheet.

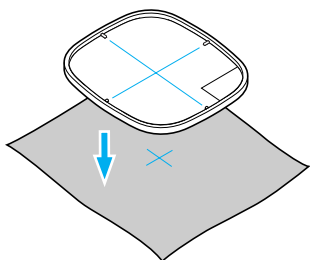

4 Place the inner frame with the fabric on the outer frame and stretch the fabric.

- For details, refer to page 123.

5 Remove the embroidery sheet.

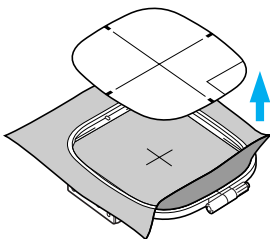

■ **Embroidery on fabrics that cannot be stretched on an embroidery frame**

When small pieces of fabric that cannot be stretched on an embroidery frame or thin pieces like ribbon are being embroidered, use stabilizer material as a base to stretch on the frame. We recommend stabilizer material for embroidery.

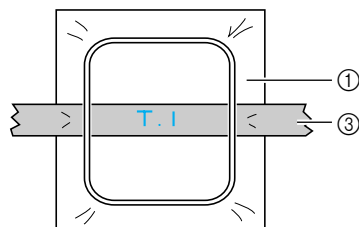
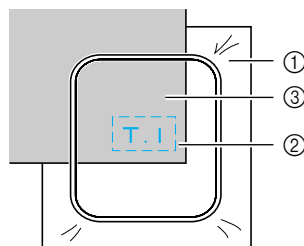
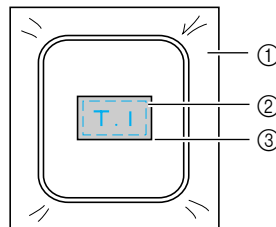

- ① Stabilizer material
- ② Tack or spray glue
- ③ Fabric

After completing the embroidery, remove the stabilizer material carefully.

Attaching the embroidery frame

The embroidery frame with the stretched fabric is attached to the embroidery unit.

Attaching the embroidery frame

1 Wind the embroidery bobbin thread onto the bobbin and set it into the shuttle.

- For details, refer to "Winding/Installing the Bobbin" (page 16).

2 Raise the presser foot lever.

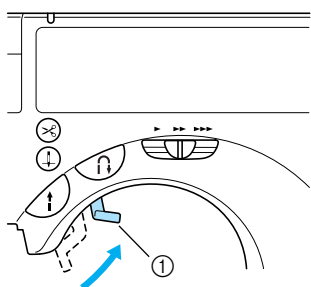

① Presser foot lever

3 Pass the embroidery frame under the presser foot while raising the presser foot lever even further.

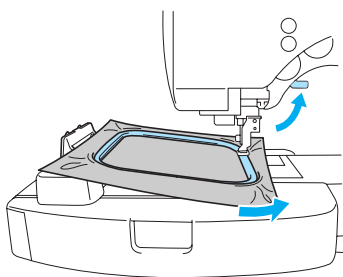

! CAUTION

- Do not hit the needle with your finger or the embroidery frame. It could result in injury or the breaking of the needle.

4 Firmly insert the embroidery frame guide into the embroidery carriage frame holder from the top.

Line up the embroidery frame guide tabs and the embroidery carriage frame holder slots and push in until it clicks and stops.

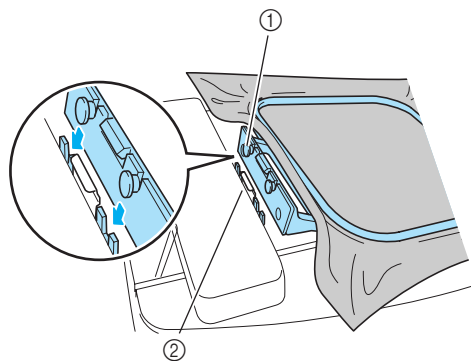

- ① Embroidery frame guide tabs
- ② Embroidery carriage frame holder slots

▶ The embroidery frame is attached.

! CAUTION

- Correctly set the embroidery frame into the embroidery frame holder. If it is not set in correctly, the presser foot may hit the embroidery frame, resulting in injury.

Removing the embroidery frame

- 1 Be sure that the sewing machine is stopped.
- 2 Raise the presser foot lever.

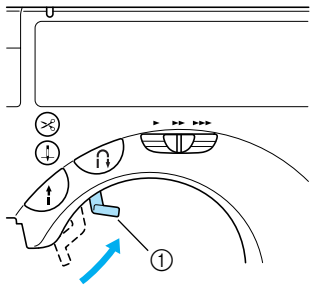

① Presser foot lever

- 3 Press the part of the embroidery frame holder in the figure to the left side, and raise the embroidery frame.

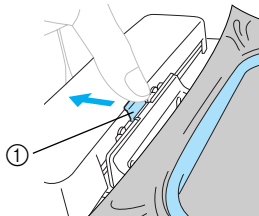

① Press here to remove

- ▶ The embroidery frame will separate from the embroidery frame holder.

- 4 Pass the embroidery frame under the presser foot while raising the presser foot lever even further.

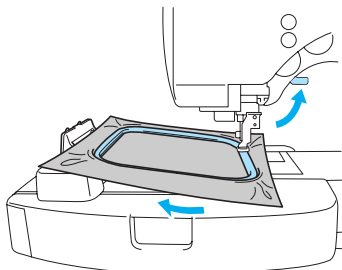

- ▶ Remove the embroidery frame.

! CAUTION

- Do not hit the needle with your finger or the embroidery frame. It could result in injury or the breaking of the needle.

Selecting embroidery patterns

The pattern for the embroidery is selected.

Copyright Information

The patterns stored in the sewing machine and embroidery cards are intended for private use only. Any public or commercial use of copyrighted patterns is an infringement of copyright law and is strictly prohibited.

Embroidery pattern types

These are the following groups of patterns.

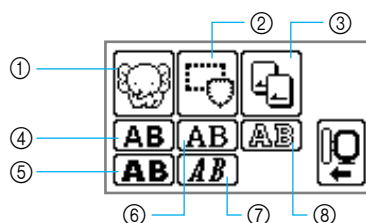

- ① Embroidery patterns
- ② Frame patterns
- ③ Embroidery card
- ④ Character (sans serif)
- ⑤ Character (bold)
- ⑥ Character (serif)
- ⑦ Character (italics)
- ⑧ Character (outline style)

■ Character pattern (sans serif/serif/bold/italics/outline style)

There are uppercase/lowercase/numbers/symbols (11 characters)/European characters. 25 continuous characters can be specified.

- For details, refer to "Selecting characters" (page 130).

■ Embroidery patterns

There are 70 patterns from fruit to animals, etc. The patterns are completed by changing the upper thread according to the instructions displayed on the LCD.

- For details, refer to "Selecting embroidery patterns" (page 131).

■ Frame patterns

Ten shapes, such as squares and circles, can be combined with 12 stitch types.

- For details, refer to "Selecting a frame pattern" (page 132).

■ Embroidery card

Press when selecting patterns from an embroidery card.

- For details, refer to "Using an embroidery card" (page 133).

LCD (liquid crystal display) operation

The LCD (liquid crystal display) is operated using the operation keys on the display panel. The use of the keys for embroidery will be explained here.

■ Operation keys



- Returns to the previous screen.
- When there are patterns that are not displayed on the screen (when < or > is displayed), the previous patterns/subsequent patterns are displayed.
- When it is in embroidery, returns to the initial embroidery screen.
- Under embroidery, information to be displayed on the LCD can be selected from thread color/thread number/needle count/time to embroider (after **TIME** is pressed).



- NAME OF COLOR: Typical color name
 - EMBROIDERY: Embroidery thread color number
 - COUNTRY: Country thread color number
- When one of above two settings is selected, number of the next thread will be also displayed when embroidering. (example; 001 → **800**)
- NEEDLE COUNT: Needle progress number

■ LCD button

- CHECK** When a specific pattern is selected, touch this key and then, press to switch the display. The sewing settings such as the specified character string and color are confirmed.



- TIME** When an embroidery pattern has been selected, the time to completion of the embroidery and the elapsed time can be checked.

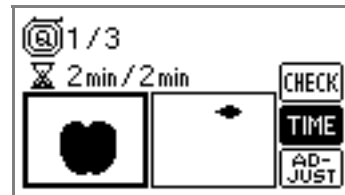

- DENSITY** The characters and frame pattern density can be changed.

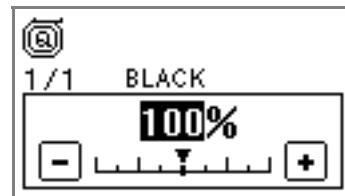

- When the density of the pattern cannot be changed, **DENSITY** is not displayed.

- ADJUST** There are **CHECK**, **MULTI COLOR** (for character patterns), **V-4**, and **LAY-OUT** keys.





Press when you want to change the color character by character in character embroidery. Since the sewing machine stops at the end of each character, the upper thread is changed as you sew.

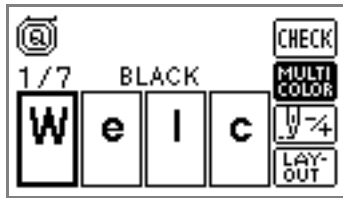

The needle progresses one color or one stitch (if pressed continuously, 9 stitches to 20 stitches) at a time and changes the position for starting the embroidery. This is used when a specific color is not sewn or when restarting the sewing machine after power has been turned off in the middle of the operation.

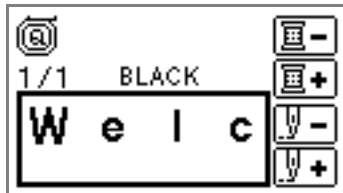

- Back one color Forward one color
- Back one stitch Forward one stitch

• For details, refer to "Resewing" (page 141).



The position of the pattern within the embroidery frame can be checked, and the size and angle can be changed.

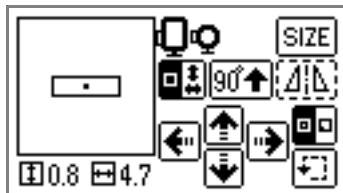

• For details, refer to "Adjusting the layout" (page 138).



Memo

- When an LCD button has dashed lines around it (i.e.:) that button cannot be selected.

Selecting characters

Specify the characters for embroidery. A maximum of 25 continuous characters from the same group can be combined.



Memo

- When "The pattern is too large for the embroidery frame." is displayed, no more characters can be input.
- Characters from different groups (sans serif and serif, etc.) cannot be combined.

1 Select the type of characters.

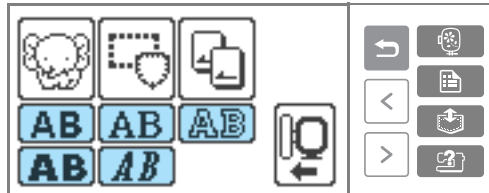

2 Select the characters for embroidery.

If a character is pressed by mistake, press .

- Example:** Welcome



Switch between uppercase/lowercase



Switch among large/medium/small sizes



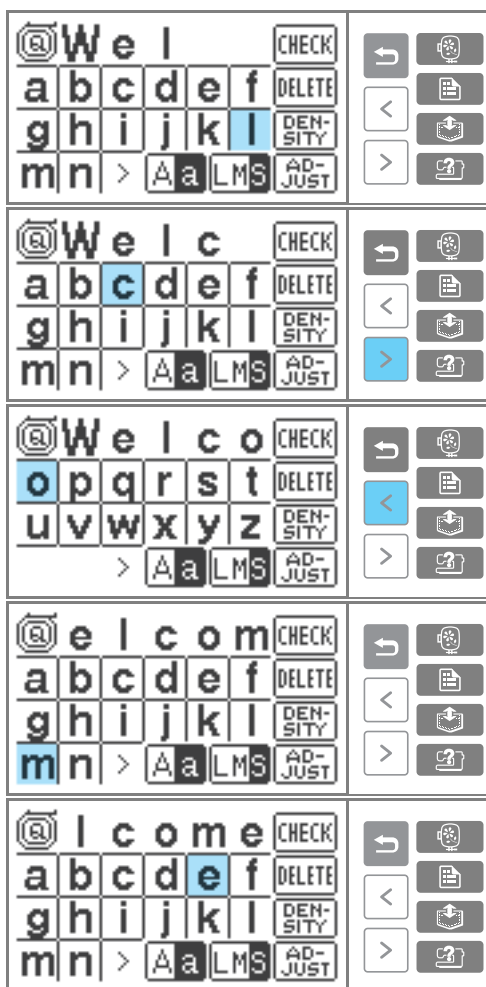

Memo

- The characters you entered can be stored for later use. For details, refer to "Storing characters" (page 139).

Selecting embroidery patterns

There are 70 embroidery patterns, such as fruit and animals, stored in the machine's computer memory.

Memo

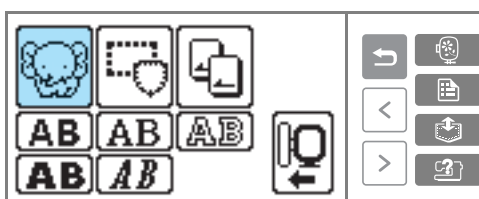

- Refer to "Embroidery Pattern Color Change Table" in the Quick reference guide for samples of completed patterns and the thread used.

1 Press embroidery pattern.



▶ The pattern selection screen is displayed.

2 Select the pattern.

Switch screens using  (Previous page key) and  (Next page key).

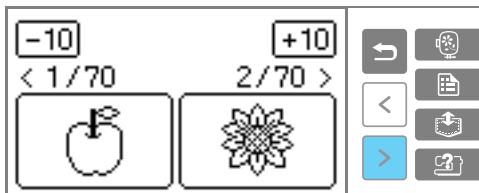

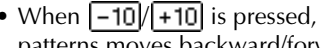
- When  is pressed, the display of patterns moves backward/forward 10 patterns.

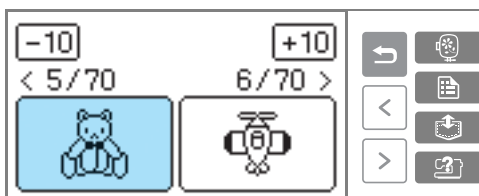

▶ If a pattern is selected, it can be embroidered.



Selecting a frame pattern

Ten shapes, such as squares and circles, can be combined with 12 stitch types.



Memo

- Refer to "Frame patterns" in the Quick reference guide for frame pattern shapes and stitches.

1 Press the frame pattern.

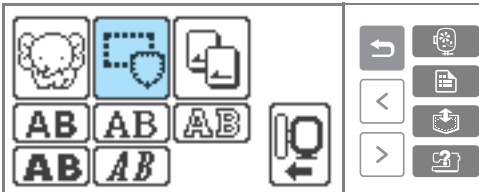

- ▶ The frame shape selection screen is displayed.

2 Select the frame shape.

Switch the screen using (Previous page key) (Next page key), and select from the ten types.

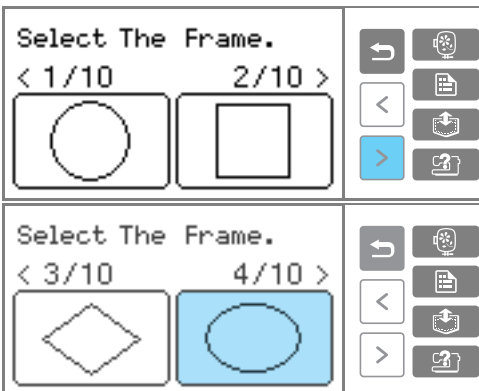

- ▶ The stitch selection screen is displayed.

3 Select the stitch.

Switch the screen using (Previous page key) (Next page key), and select from the 12 stitches.

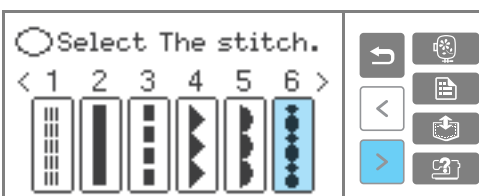

- ▶ If a stitch is selected, it can be embroidered.

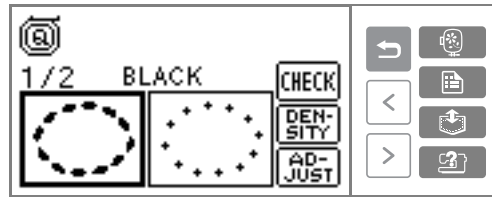

Using an embroidery card

If an embroidery card is used, you can embroider patterns other than the patterns stored in the sewing machine. There are various cards with different themes.



Note

- Always turn off the sewing machine to insert and remove embroidery cards.
- Insert the embroidery card into the embroidery card slot, facing it in the right direction.
- Do not put anything other than an embroidery card in the embroidery card slot.
- When embroidery cards are not in use, keep them in their storage cases.
- Use only embroidery cards manufactured for this machine. Using unauthorized cards may cause your machine to operate incorrectly.
- Embroidery cards purchased in foreign countries may not work with your machine.

1 Turn off the sewing machine.

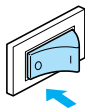

2 Insert the embroidery card in the embroidery card slot on the right side of the sewing machine.

Face the arrow on the embroidery card toward you, and insert it in the direction of the arrow.

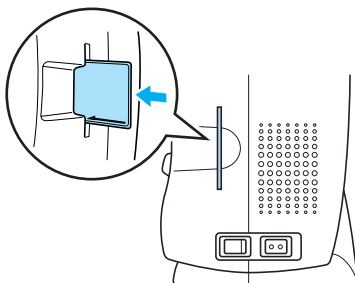

3 Turn on the sewing machine.

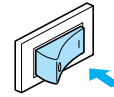

4 Press the embroidery card on the LCD.



▶ The selection screen for the patterns stored in the card is displayed.

5 Select a pattern.

The operation is the same as in "Selecting embroidery patterns" (page 131).

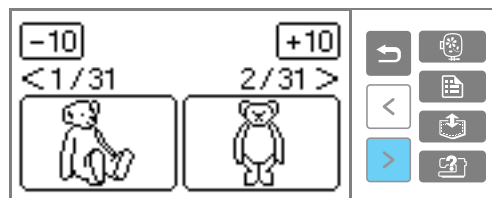

Embroidering

After the preparations are done, you can try embroidering. An example of the steps for an embroidery pattern will be given here.

Embroidering a pattern

Embroidery patterns are embroidered with a change of thread after each color.

1 Prepare embroidery thread of the color shown on the LCD.

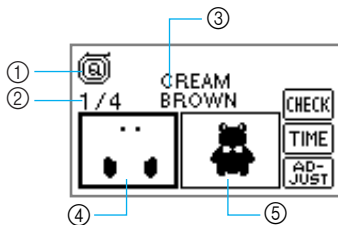

- ① Embroidery foot "Q" (recommended presser foot)
- ② Current color step/Number of colors in design
- ③ Current name of color
- ④ Current color part
- ⑤ Next color part

- Typical color names, embroidery thread/country thread color number, needle count, and time to sew (after **TIME** is pressed) can be displayed on the LCD. When switching the display, press **[Settings]** (Settings key) to change it. Refer to "LCD (liquid crystal display) operation" (page 129).



- **Example:** Embroidery thread number selected

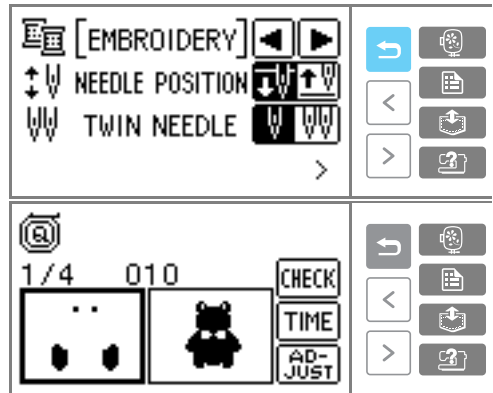

2 Set the embroidery thread in the thread cassette, and thread the needle.

- Refer to "Loading the spool into the thread cassette" (page 22) and "Threading the needle" (page 25).

3 Pass the thread through the embroidery foot hole, and hold it gently in your left hand. Give the thread a little slack.

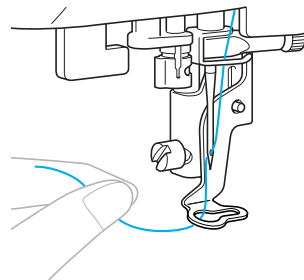

CAUTION

- If the thread is pulled too tight, the needle may break or bend.
- Do not let hands or objects hit the carriage while sewing. The pattern may misalign.

4 Lower the presser foot lever.

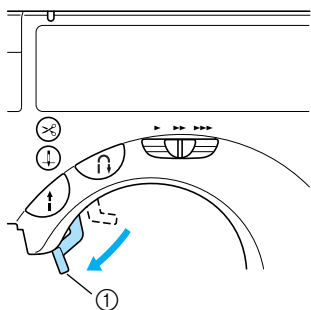

① Presser foot lever

5 Press  (Start/stop button).

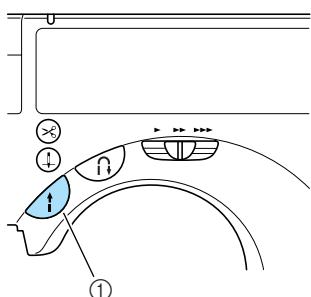

① Start/stop button

6 After progressing 5-6 stitches, press  (Start/stop button), and the sewing machine will stop.

7 Use scissors to cut the thread at the beginning of the stitching.

Cut the thread at the edge of the stitching.

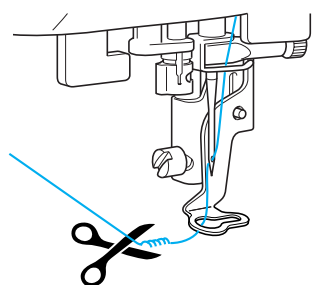

- If the thread is left at the beginning of the stitching, it will be sewn into the pattern, and it cannot be taken care of neatly. Take care of the thread at the beginning of the stitch for each color.

8 Press  (Start/stop button) again.

- ▶ The embroidery begins again.
- ▶ Stitching stops automatically with reinforcement after one color has been completed. When automatic thread cutting is set, the thread is cut.

9 Remove the thread cassette.

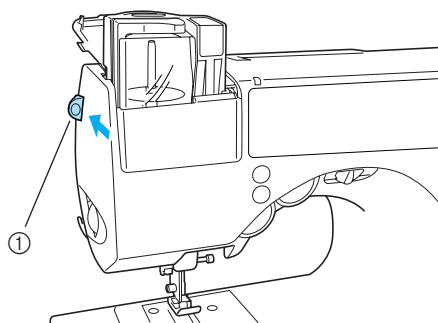

① Thread cassette eject lever

10 Set up embroidery thread for the next color, and repeat steps  - .

- ▶ When the final color is complete, it returns to the initial screen.

11 Cut the excess thread.

 **Memo**

- It is convenient if the next color is set up in another thread cassette while the sewing is going on.
- For the automatic cutting setting, refer to "Changing the Machine Settings" (page 13).

Appliquéing

With embroidery patterns that display "APPLIQUE", you can appliqué. Prepare the base fabric and the appliqué fabric (appliqué piece).

1 Select an appliqué pattern.

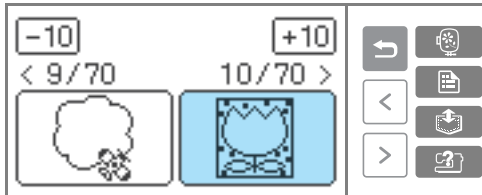

2 When "APPLIQUE MATERIAL" is displayed on the LCD, apply the stabilizer material to the back of the appliqué piece fabric, and stretch it on the embroidery frame.

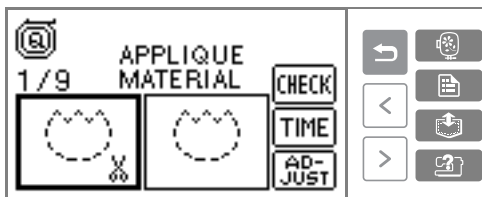

3 Lower the presser foot lever, and press (Start/stop button).

- ▶ The cut-out for the appliqué piece is sewn, and the sewing machine stops.

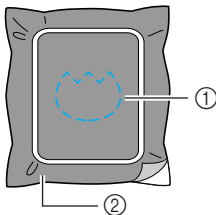

- ① Cut-out line
- ② Appliqué piece fabric

- ▶ "APPLIQUE POSITION" will be displayed on the LCD.

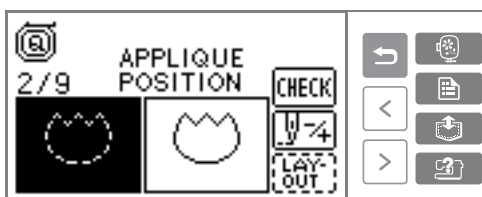

4 Remove the fabric from the embroidery frame, and cut it out along the stitching.

Cut carefully along the stitching and remove the thread.

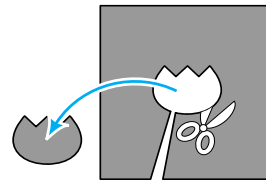

- If it is not cut right on the stitching, it will not be finished neatly.

5 Stretch the base fabric on the embroidery frame.

6 Set up the thread for appliquéing.

7 Lower the presser foot lever, and press (Start/stop button).

- ▶ The position for the appliqué is stitched, and the sewing machine stops.

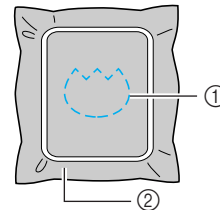

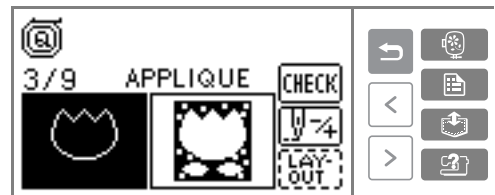

- ① Appliqué position
- ② Base fabric

- ▶ "APPLIQUE" will be displayed on the LCD.

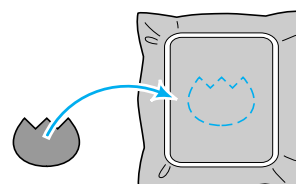

8 Apply a thin layer of fabric glue or spray adhesive to the back of the appliqué piece, and attach it in the appliqué position.



- 9 Lower the presser foot lever, and press  (Start/stop button).

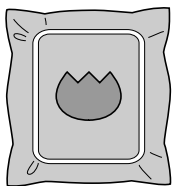

- 10 Follow the instructions on the LCD, and change thread colors as you sew.

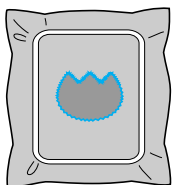

Convenient Functions

Ways for fixing problems when there are mistakes in adjustments and colors for the pattern and convenient functions will be explained here.

Adjusting the layout

The pattern is normally positioned in the center of the embroidery frame.

You can check the layout before starting embroidery and change the position and the size.

1 After selecting the embroidery pattern, press

AD-JUST.



▶ The screen for changing the pattern is displayed.

2 Press **LAY-OUT**.

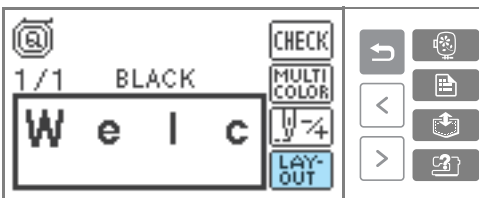

▶ The layout screen is displayed.

3 Check and adjust the layout.

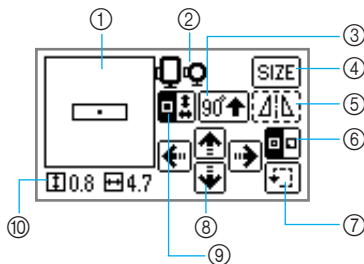

- ① Layout within the frame
- ② Embroidery frame (M/S) used
- ③ 90 degree rotation key
- ④ Size key
- ⑤ Horizontal mirror image key
- ⑥ Stitch beginning key
- ⑦ Trial key
- ⑧ Change position key
- ⑨ Pattern size/position switching key
- ⑩ Embroidery size (cm)



Embroidery frame size

The size of embroidery frame that can be used is displayed. When the smaller mark is grayed out in the display, embroidery frame (small) cannot be used.



Size key

Increases/decreases the size of the embroidery. If **LAY-OUT** is pressed, it returns to the previous screen.

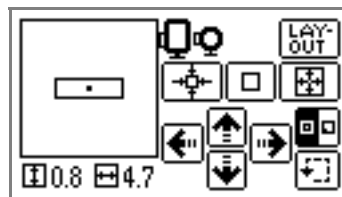

Decrease size





Return to original size



Increase size



Pattern size/position switching key

Switches between pattern size and position displays. When it is , the pattern size is displayed in the lower left (Example: **0.8 4.7**). When it is , the distance moved is displayed (Example: **-1.25 ++1.25**).



Change position key

Moves the embroidery position up, down, left and right.



Return to center position (when the pattern was moved with the change position key)

- If you make a note of the values in the lower left when you change the size and position, you can sew with the same size and layout even if you have to turn the power back on in the middle of your work.

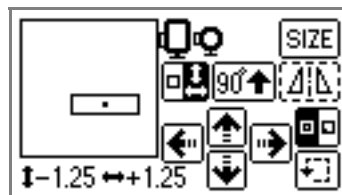

90 degree rotation key

Rotates the embroidery 90° each time. The direction of the arrow points to the top of design.



Horizontal mirror image key
Mirrors the embroidery left and right.
When it is it cannot be used.



Stitch beginning key
Switches the position for beginning stitching between center/lower left of the design.



Trial key
Moves the embroidery unit carriage, and checks the embroidery range.

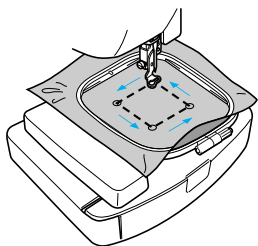

CAUTION

- Never lower the needle when the embroidery frame is moving. The needle could be broken or bent.
- If the movement for the stitching position exceeds the range where embroidery can be done, you can not use that size embroidery frame. Check the display for a frame that can be used and use it. If a frame other than the ones displayed is used, it could result in injury.

- 4 Press (Back key) to return to the original screen.

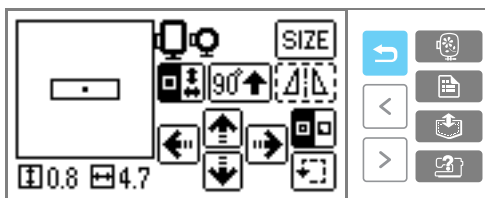

Memo

- When the power is turned off, the layout returns to the original setting.

Storing characters

The characters you entered can be stored in the sewing machine memory. Since the stored characters will not be erased when the power is turned off, you can always recall them for embroidery. This is convenient for storing names and the like. You can store up to five groups.

■ Storing characters

- 1 After inputting the characters to be stored, press (Memory key).



- ▶ The screen for selecting the storage location (pocket) is displayed.

- 2 Select the pocket for storage from pockets 1 - 5. indicates an empty pocket. indicates a pocket where a character is already stored.



- ▶ The selected pocket is shown in reverse highlighting.

- 3 Press .



- ▶ "Saving..." appears while the character is being stored in the pocket.
- Do not turn off the sewing machine while a character is being stored, otherwise the character data may be lost.



Memo

- If new characters or blanks are saved to a pocket where characters are already stored, the previously stored characters are erased.

■ Recalling stored characters.



Recall stored characters.

- 1** Press  (Memory key). This can be pressed no matter what screen is being displayed.





▶ The pocket selection screen is displayed.

- 2** Select the pocket (1 - 5) where the characters you wish to recall are stored.

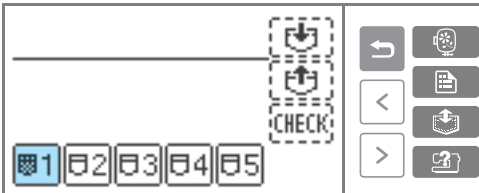
 indicates an empty pocket.  indicates a pocket where a character is already stored.



▶ The selected pocket is shown in reverse highlighting, and the stored characters are displayed.

- 3** After checking the content, press . Press  to check a pattern that is not displayed completely.



- ▶ The stored characters are recalled.
- ▶ The screen for inputting characters appears, and you can embroider the recalled characters.



Note

- Only characters (not designs) can be stored in the machine memory.
- Characters saved from an embroidery card must have the embroidery card inserted in the machine in order to retrieve the memory saved from the embroidery card.

Adjusting the thread tension

If embroidery fails, it is difficult to undo the thread and the fabric may be damaged. Before embroidering, use a scrap of the same fabric to check the adjustment of the thread tension, etc. Thread tension adjustment will be explained here. The upper thread tension is changed using the thread tension dial on the left side of the sewing machine.

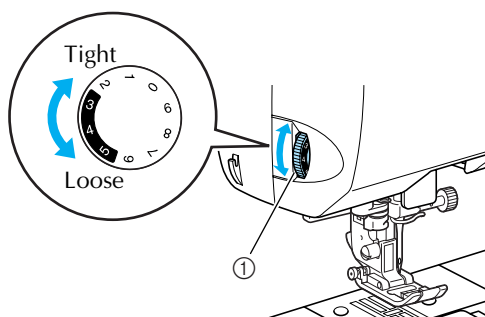

① Thread tension dial

■ Correct thread tension

The thread tension is correct when upper thread is just visible on back of the fabric.



① right side
② wrong side

■ Upper thread is too tight

The lower thread will be visible on the front of the fabric. In this instance, decrease the upper thread tension.



① right side
② wrong side

■ Upper thread is too loose

The upper thread has slack. In this instance, increase the upper thread tension.

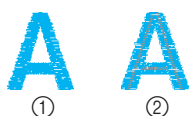

① right side
② wrong side

Resewing

When the wrong color upper thread has been sewn, it can be resewn with the correct color.

1 Press (Start/stop button) to stop the sewing machine.

2 Press .

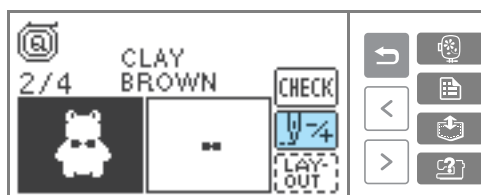

3 Press (Back one color) to return to the beginning of the mistaken color. Press one more time to go to previous color.



4 Set up the correct color for the upper thread.

4

Thread runs out partway through a design

When the upper thread or the bobbin thread runs out while sewing, the sewing machine stops. Move the needle back about ten stitches and resume sewing.

1 Set up the upper or bobbin thread.

2 Press .

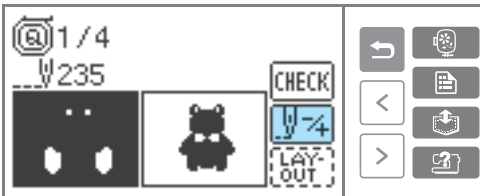

3 Press (Back one stitch) to move the needle back about 10 stitches.

(Forward one stitch) increases the stitch number.

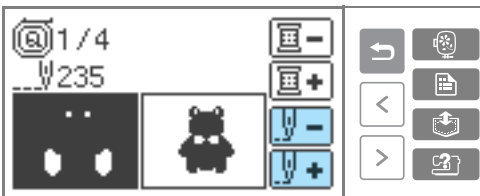

4 Restart the embroidery.



Stopping while embroidering

If the embroidery is stopped before it is complete, check the current needle count before turning off the sewing machine.

Memo

- When the sewing machine is turned off, the embroidery size and layout return to the original setting.

1 Press (Start/stop button) to stop the sewing machine.

2 Check the current needle count on the LCD and make a note of it.

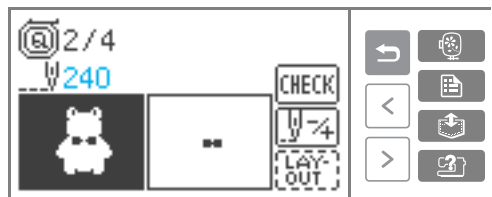

If the needle count is not displayed, press (Settings key) to switch the display.

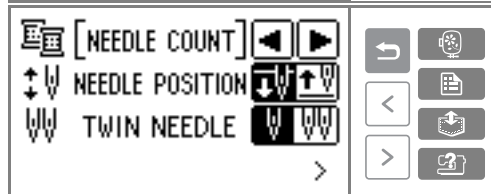

Press (Back key) to return to the embroidery screen.

3 Press (Embroidery key).

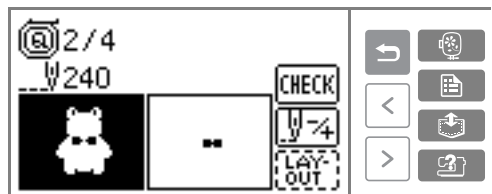

- ▶ The screen for checking the pattern is displayed.

4 Press **OK**.

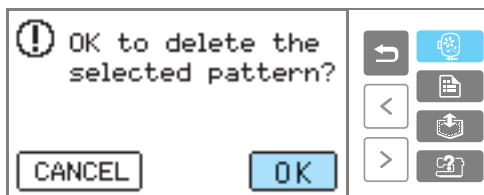

▶ The selected pattern is turned off, and it returns to the initial embroidery screen.

5 Turn off the sewing machine.

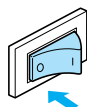

• Always detach the embroidery unit when you move the sewing machine.

6 Turn on the sewing machine and select the pattern.

7 Press **ADJUST**.

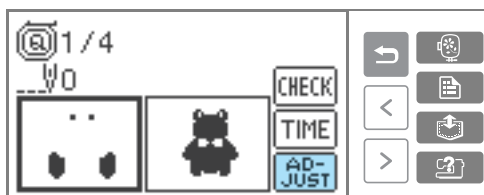

8 Press **1/4**.

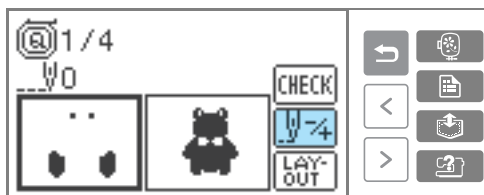

9 Press **1/4** (Forward one color) to move to the beginning of the color you want to sew.



10 Press **1/4** (Forward one stitch) to increase the needle count.

If **1/4** is pressed continuously, it moves forward 1 → 9 → 20 stitches.



Move forward to about ten stitches before the total number of stitches confirmed in 2.

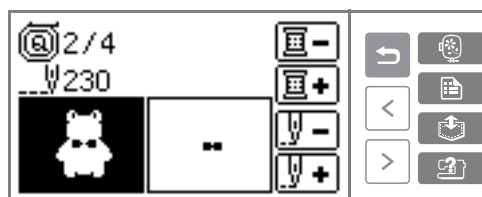

11 Restart the embroidery.



APPENDIX

The various maintenance and troubleshooting procedures are described in this chapter.

Maintenance.....	146
Troubleshooting	148
Index	157

Maintenance

Simple sewing machine maintenance operations are described below.

Cleaning the machine surface

If the surface of the machine is dirty, lightly soak a cloth in neutral detergent, squeeze it out firmly, and then wipe the surface of the machine. After cleaning it once with a wet cloth, wipe it again with a dry cloth.

! CAUTION

- Unplug the power supply cord before cleaning the machine, otherwise injuries or an electric shock may occur.

Cleaning the shuttle

Sewing performance will suffer if dust collects in the shuttle; therefore, it should be cleaned periodically.

- 1 Turn off the sewing machine.

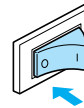

- 2 Unplug the power cord from the power supply jack on the right side of the sewing machine.

! CAUTION

- Unplug the power supply cord before cleaning the machine, otherwise injuries or an electric shock may occur.

- 3 Grasp both sides of the needle plate cover, and then slide it toward you.

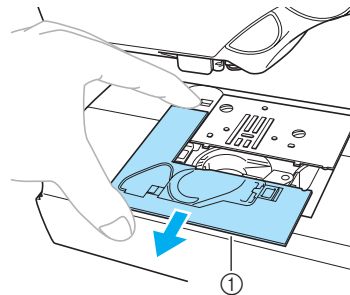

① Needle plate cover

▶ The needle plate cover is removed.

- 4 Remove the shuttle.**
Grasp the shuttle, and then pull it out.

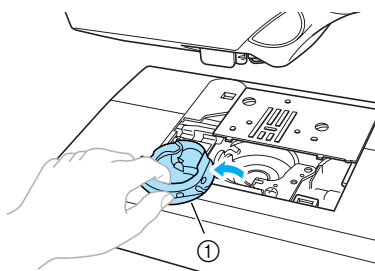

① Shuttle

- 5 Use the cleaning brush or a vacuum cleaner to remove any lint and dust from the race and its surrounding area.**

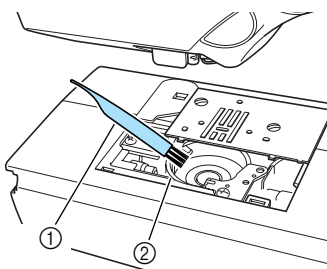

① Cleaning brush
② Shuttle race

- Do not apply oil to the shuttle.

- 6 Insert the shuttle so that the projection on the shuttle aligns with the spring.**

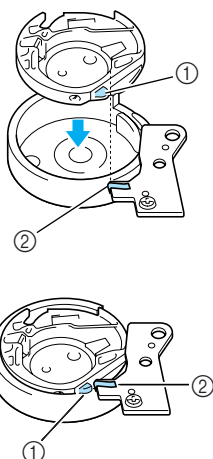

① Projection
② Spring

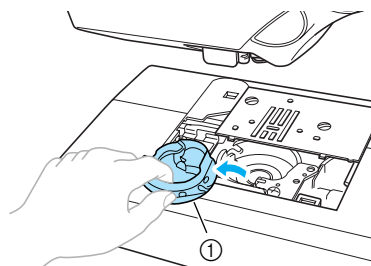

① Shuttle

- 7 Insert the tabs on the needle plate cover into the needle plate, and then slide the cover back on.**

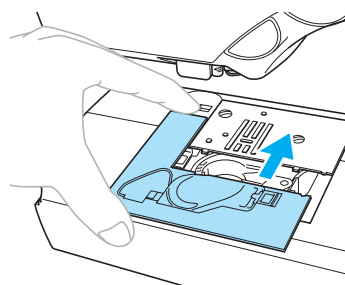

CAUTION

- Never use a shuttle that is scratched, otherwise the upper thread may become tangled, the needle may break or sewing performance may suffer. For a new shuttle (part code: XC3153-051), contact your nearest authorized service center.
- Be sure that the shuttle is correctly installed, otherwise the needle may break.

Troubleshooting

If the machine stops operating correctly, check the following possible problems before requesting service. If the problem persists, contact your retailer or the nearest authorized service center.

Symptom	Probable Cause	Remedy	Reference
The sewing machine does not operate.	The machine is not turned on.	Turn on the machine.	page 11
	The start/stop button was not pressed.	Press the start/stop button.	page 47
	The presser foot lever is raised.	Lower the presser foot lever.	page 46
	The start/stop button was pressed, even though the foot controller is connected.	Do not use the start/stop button when the foot controller is connected. To use the start/stop button, disconnect the foot controller.	page 47
The needle breaks.	The needle is incorrectly installed.	Correctly install the needle.	page 35
	The needle clamp screw is loose.	Use the screwdriver to firmly tighten the screw.	
	The needle is bent or blunt.	Replace the needle.	
	The combination of fabric, thread and needle is not correct.	Select a thread and needle that are appropriate for the type of fabric being sewn.	page 34
	The presser foot that is used is not appropriate for the type of stitch that you wish to sew.	Attach the presser foot that is appropriate for the type of stitch that you wish to sew.	page 64
	The upper thread tension is too tight.	Loosen the upper thread tension.	page 52
	The fabric is pulled too much.	Lightly guide the fabric.	–
	The spool is incorrectly installed.	Correctly install the spool.	page 21
	The area around the hole in the needle plate is scratched, or has a burr on it.	Replace the needle plate. Contact your retailer or the nearest authorized service center.	–
	The area around the hole in the presser foot is scratched, or has a burr on it.	Replace the presser foot. Contact your retailer or the nearest authorized service center.	–
	The shuttle is scratched, or has a burr on it.	Replace the shuttle. Contact your retailer or the nearest authorized service center.	–
A bobbin designed specifically for this machine is not used.	Incorrect bobbins will not work properly. Only use a bobbin designed specifically for this machine.	page 16	

Symptom	Probable Cause	Remedy	Reference
The upper thread breaks.	The upper thread was not threaded correctly (for example, the spool is not installed correctly, the spool cap is too big for the spool being used, or the thread has come out of the needle bar thread hook).	Correct the upper threading.	page 21
	There are knots or tangles in the thread.	Remove any knots or tangles.	–
	The selected needle is not appropriate for the thread being used.	Select a needle that is appropriate for the type of thread being used.	page 34
	The upper thread tension is too tight.	Loosen the upper thread tension.	page 52
	The thread is tangled, for example, in the shuttle.	Remove the tangle thread. If the thread is tangled in the shuttle, clean the shuttle.	page 146
	The needle is bent or blunt.	Replace the needle.	page 35
	The needle is incorrectly installed.	Correctly install the needle.	
	The area around the hole in the needle plate is scratched, or has a burr on it.	Replace the needle plate. Contact your retailer or the nearest authorized service center.	–
	The area around the hole in the presser foot is scratched, or has a burr on it.	Replace the presser foot. Contact your retailer or the nearest authorized service center.	–
	The shuttle is scratched, or has a burr on it.	Replace the shuttle. Contact your retailer or the nearest authorized service center.	–
	A bobbin designed specifically for this machine is not used.	Incorrect bobbins will not work properly. Only use a bobbin designed specifically for this machine.	page 16
Bobbin thread does not wind neatly on the bobbin.	Bobbin winder cover is not open.	Open the bobbin winder cover until it clicks.	page 16
	Spool pin has not been raised.	Raise the spool pin until it stops.	page 16
	The thread that was pulled out was not wound onto the bobbin correctly.	Wind the thread that was pulled off around the bobbin five or six times clockwise.	page 18
	Bobbin spins slowly.	Move the sewing speed controller to the right (so that the speed will be fast).	page 18



















Symptom	Probable Cause	Remedy	Reference
The lower thread is tangled or breaks.	The bobbin thread is incorrectly installed.	Correctly install the bobbin thread.	page 19
	The bobbin is scratched or does not rotate smoothly, or has a burr on it.	Replace the bobbin.	–
	The thread is tangled.	Remove the tangled thread and clean the shuttle.	page 146
	A bobbin designed specifically for this machine is not used.	Incorrect bobbins will not work properly. Only use a bobbin designed specifically for this machine.	page 16
The thread tension is incorrect.	The upper thread was not threaded correctly.	Correct the upper threading.	page 21
	The bobbin thread is incorrectly installed.	Correctly install the bobbin thread.	page 19
	The combination of fabric, thread and needle is not correct.	Select a thread and needle that are appropriate for the type of fabric being sewn.	page 34
	The presser foot holder is incorrectly installed.	Correctly install the presser foot holder.	page 40
	The thread tension is incorrect.	Adjust the tension of the upper thread.	page 52
	A bobbin designed specifically for this machine is not used.	Incorrect bobbins will not work properly. Only use a bobbin designed specifically for this machine.	page 16
The fabric is wrinkled.	The upper thread was not threaded correctly, or the bobbin is incorrectly installed.	Correctly thread the upper thread and correctly install the bobbin thread.	page 19, page 21
	The spool is incorrectly installed.	Correctly install the spool.	page 21
	The combination of fabric, thread and needle is not correct.	Select a thread and needle that are appropriate for the type of fabric being sewn.	page 34
	The needle is bent or blunt.	Replace the needle.	page 35
	If thin fabrics are being sewn, the stitch is too coarse.	Shorten the stitch length or sew with stabilizer material under the fabric.	page 55
	The thread tension is incorrect.	Adjust the tension of the upper thread.	page 52

Symptom	Probable Cause	Remedy	Reference
Stitches are skipped.	The upper thread was not threaded correctly.	Correct the upper threading.	page 21
	The combination of fabric, thread and needle is not correct.	Select a thread and needle that are appropriate for the type of fabric being sewn.	page 34
	The needle is bent or blunt.	Replace the needle.	page 35
	The needle is incorrectly installed.	Correctly install the needle.	page 35
	Dust has accumulated under the needle plate or in the shuttle.	Remove the needle plate cover and clean the shuttle.	page 146
A high-pitched noise is made while sewing.	Dust has accumulated in the feed dogs or in the shuttle.	Clean the shuttle.	page 146
	The upper thread was not threaded correctly.	Correct the upper threading.	page 21
	The shuttle is scratched, or has a burr on it.	Replace the shuttle. Contact your retailer or the nearest authorized service center.	–
	A bobbin designed specifically for this machine is not used.	Incorrect bobbins will not work properly. Only use a bobbin designed specifically for this machine.	page 16
The thread does not pass through the eye of the needle.	The needle has not been raised to the correct position. The thread cassette indicator is lit in red.	Press the needle position button. The thread cassette indicator lights up in green.	page 25
	The needle is incorrectly installed.	Correctly install the needle.	page 35
The stitch is not sewn correctly.	The presser foot that is used is not appropriate for the type of stitch that you wish to sew.	Attach the presser foot that is appropriate for the type of stitch that you wish to sew.	page 64
	The thread tension is incorrect.	Adjust the tension of the upper thread.	page 52
	The thread is tangled, for example, in the shuttle.	Remove the tangle thread. If the thread is tangled in the shuttle, clean the shuttle.	page 146
The fabric does not feed.	The feed dogs are lowered.	Slide the drop feed lever to the left.	page 96
	The stitch is too fine.	Lengthen the stitch length.	page 55
	The presser foot that is used is not appropriate for the type of stitch that you wish to sew.	Attach the presser foot that is appropriate for the type of stitch that you wish to sew.	page 64
	The thread is tangled, for example, in the shuttle.	Remove the tangle thread. If the thread is tangled in the shuttle, clean the shuttle.	page 146
The sewing lamp does not come on.	The sewing lamp is damaged.	Contact your retailer or the nearest authorized service center.	–

Symptom	Probable Cause	Remedy	Reference
Nothing appears in the LCD.	The brightness of the LCD is either too light or too dark.	Adjust the brightness of the LCD.	page 155
Machine does not operate when button is pressed.	An animation is displayed on the LCD.	Touch the LCD with your finger, and the animation will disappear.	page 18, page 38
Embroidery unit does not move.	No pattern selected.	Select a pattern.	page 128
	The embroidery unit is not set up correctly.	Set the embroidery unit up correctly.	page 118
The embroidery unit cannot be attached.	The flap is still attached.	Remove the flap.	page 118
	The embroidery unit connector slot is closed.	Pull the embroidery unit connector slot cover toward you and then push it all the way in.	page 119
Embroidery not neatly done.	The fabric is not fully stretched on the embroidery frame. The fabric is loose.	Stretch the fabric properly on the embroidery frame.	page 123
	No stabilizer material is attached.	Always use stabilizer material for embroidery with stretch fabrics, thin fabrics, fabrics with a loose weave and fabrics where stitches easily contract.	page 122
	The thread is tangled and the shuttle, etc., is plugged up.	Remove the tangled thread. When the shuttle is plugged up, clean it out.	page 146
	The thread tension is incorrect.	Adjust the tension of the upper thread.	page 52
	Objects are placed near the carriage or embroidery frame.	If the embroidery unit carriage or embroidery frame bumps into objects, the pattern will be messed up. Do not place objects within the range of embroidery frame motion.	page 119
	Material coming out of the embroidery frame is causing problems.	Stretch the fabric on the frame once again so that the material coming out of the embroidery frame does not cause problems, rotate the pattern and embroider.	–
	A heavy fabric is being embroidered, and the fabric is hanging off the table.	If embroidery is done with the fabric hanging off the table, the embroidery unit movement will be impaired. Fix it so the fabric does not hang off.	–
	The fabric is catching. It is pinched.	Stop the sewing machine and set the fabric up correctly.	–
	The carriage was moved while the embroidery frame was being removed or attached during embroidery.	If the carriage is moved during the process, the pattern may be messed up. Be careful when removing or attaching the embroidery frame.	–

Error messages

When erroneous operations are performed messages and advice on operation will be displayed on the LCD. Follow what is displayed.

Error Message	Probable Cause
 The safety device has been activated.	The upper thread has become tangled around the shuttle, and the needle is bent and hitting the needle plate, etc., so the sewing machine stops (refer to page 148).
 Insert thread cassette.	The start/stop button, reverse/reinforcement stitch button or the thread cutter button was pressed while no thread cassette was installed.
 Check and rethread the upper thread.	Upper thread broken. Upper thread not set up correctly. Upper thread has run out.
 Lower presser foot lever.	The start/stop button, reverse/reinforcement stitch button or thread cutter button was pressed while the presser foot was raised.
 Press the  key to return to the screen to sew.	Either the start/stop button or the reverse/reinforcement stitch button was pushed at a screen other than the sewing screen.
Winding bobbin thread.	The bobbin winder is winding the bobbin.
 Return bobbin winding shaft to left.	The reverse/reinforcement stitch button, needle position button or thread cutter button was pressed while the bobbin winder shaft is moved to the right.
 Disconnect foot control.	The start/stop button was pressed while the foot controller was connected. You tried to use the foot controller for embroidery.
 Lift buttonhole lever.	A stitch other than the buttonhole, bar tack or darning stitch was selected and the start/stop button was pressed while the buttonhole lever is lowered.
 Lower buttonhole lever.	The buttonhole, bar tack or darning stitch was selected and the start/stop button was pressed while the buttonhole lever is raised.
 Change to single needle mode.  → 	The twin needle setting is selected while a pattern that cannot be sewn with the twin needle is selected.
 Twin needles can not be used for this pattern.	A twin needle was set up with a pattern where a twin needle cannot be selected.
 Change speed controller mode to "OFF".	The start/stop button was pressed without connecting the foot controller while the setting for adjusting the stitch width using the sewing speed controller is set to [ON]. You have selected a pattern for which width control cannot be used.
 The carriage of the embroidery unit will move.	When the embroidery unit is attached.
 Delete the selected pattern.  Cancel 	You pressed the Back key or the Embroidery key while a pattern was selected.

Error Message	Probable Cause
① Select pattern.	The start/stop button or reverse/reinforcement stitch button was pressed when no pattern is selected.
① This button does not operate when the embroidery unit is not attached.	The Embroidery key or the Settings key was pressed while the embroidery unit is not attached.
① This button does not operate when the embroidery unit is attached.	You tried a function that cannot be used when the embroidery unit is attached.
① Press needle position button to raise needle.	You tried to select an embroidery pattern or change the layout when the needle was down. You tried to start sewing while the needle is lowered without the thread cassette.
① The pattern is too large for the embroidery frame.	You tried to set a number of characters that will not fit within the frame.
① No more stitches can be combined.	You tried to combine more than 25 character patterns.
① The bobbin thread is running out.	Bobbin thread has run out. Little bobbin thread remains.
① This embroidery pattern can not be used on this machine.	You tried to select a pattern that cannot be used with this sewing machine.
Saving...	A pattern is being stored.
Calculating the time required... Please wait.	The time for completion of the embroidery is being calculated.
① Turn off the power and insert an embroidery card.	[Card] on the LCD was pressed when no card was inserted.
☒ Saved on an embroidery card.	You tried to recall a saved card pattern without having the embroidery card in place.
① This embroidery card can not be used on this machine.	A card that cannot be used with this product has been inserted, and you tried to select a pattern from the card.
☒ Saved on another embroidery card.	You tried to recall a pattern not saved on the card with an embroidery card in place.

Nothing appears in the LCD

If nothing appears in the LCD when the sewing machine is turned on, the brightness of the LCD is either too light or too dark. If this is the case, perform the following operation.

- 1 Turn off the sewing machine.

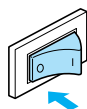

- 2 Turn the power on while pressing any of the display panel buttons.



- 3 Press [-] or [+].



- 4 Turn off the sewing machine, then turn it on again.

Operation beep

Each time a key is pressed or an incorrect operation is performed, a beep is sounded.

- **For a correct operation**
One beep is sounded.
- **If an incorrect operation is performed**
Two or four beeps are sounded.
- **If the machine locks up, for example, because the thread is tangled**
The sewing machine continues to beep for four seconds. The machine automatically stops. Be sure to check for the cause of the error, and correct it before continuing to sew.

Canceling the operation beep

When the sewing machine is purchased, it is set to beep each time an operation panel key is pressed. This setting can be changed so that the machine does not beep.

- 1 Turn on the sewing machine.

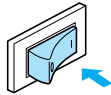

▶ The LCD comes on.

- 2 Press  (Settings key) in the operation panel.



▶ The settings screen appears.

- 3 Press  (Next page key).

- 4 Press OFF for the buzzer.



▶ The screen for changing the beep setting appears.

- 5 Press  (Back key).

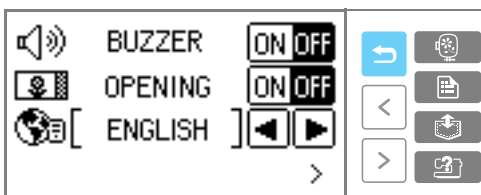

▶ The initial stitch screen appears again.

Index

- A**
- accessories Cover A
 - accessory bag Cover A
 - adjusting layout 138
 - adjusting stitch length 55
 - adjusting stitch width 54
 - adjusting thread tension 52
 - air vent Cover C
 - appliqué 91
 - appliqué pattern selection 136
 - appliqué stitch 91
 - attaching presser foot holder 40
 - attaching stabilizer material 122
 - attributes 13
 - automatic reverse/reinforcement stitches 56
 - automatic thread cutting 57
- B**
- back key Cover E
 - balance wheel Cover C, 46, 82
 - bar tack stitch 98
 - basic sewing 44
 - basic stitching 73
 - basting stitch 73
 - beep 155
 - blind hem stitch 75
 - bobbin Cover A
 - bobbin installation 19
 - bobbin shuttle Cover C
 - bobbin storage compartment Cover B
 - bobbin thread spool pin 16
 - bobbin thread, pulling up 31
 - bobbin threading 20
 - bobbin winder Cover B
 - bobbin winding 16
 - bobbin winding thread guide 18
 - button guide plate 79
 - button sewing 82
 - buttonhole lever Cover C
 - buttonhole sewing 78
 - buttonhole stitching 77
 - buzzer 155
- C**
- changing sewing direction 59
 - character storage 139
 - characters, recalling 140
 - checking needle 35
 - cleaning brush Cover A
 - cleaning machine surface 146
 - cleaning shuttle 146
 - concealed seams 84
 - crazy quilt stitching 93
 - cuffs 41
 - curve sewing 59
- cutting thread 50
- cutting thread automatically 57
- cylindrical pieces 41
- D**
- darning 100
 - darning stitch 98
 - decorative stitches 103
- E**
- eject lever Cover B
 - eject lever, thread cassette 23
 - elastic tape 89
 - embroidering 112, 134
 - embroidering pattern 134
 - embroidering steps 114
 - embroidery bobbin thread Cover A
 - embroidery card slot Cover C
 - embroidery cards 133
 - embroidery character selection 130
 - embroidery fabric preparation 122
 - embroidery foot installation 115
 - embroidery foot removal 117
 - embroidery frame Cover A, 123
 - embroidery frame installation 126
 - embroidery frame removal 127
 - embroidery key Cover E
 - embroidery pattern selection 128, 131
 - embroidery pattern types 128
 - embroidery sheets 124
 - embroidery threads 112
 - embroidery unit connector slot Cover B
 - embroidery unit installation 118
 - embroidery unit removal 120
 - error messages 153
 - even seam allowance 61
 - extra spool pin 27, 29
 - eyelet punch Cover A
 - eyelet stitching 102
- F**
- fabric positioning 46
 - fagoting 104
 - fagoting stitch 103
 - feed dog position switch Cover C
 - feed dogs Cover C
 - foot controller Cover A, 47
 - foot controller jack Cover C
 - frame pattern selection 132
 - fraying, preventing 69
 - free-arm sewing 41
 - free-motion quilting 96
 - front view Cover B

- G**
-
- general sewing procedures 44
- H**
-
- handle Cover C
 heirloom stitching 108
 help key Cover E, 15
- I**
-
- inserting thread cassette 26
 installing bobbin 19
- J**
-
- joining 107
 joining stitch 91, 103
- L**
-
- layout adjustment 138
 LCD Cover E
 LCD button 129
 LCD messages 153
 LCD operation 12, 129
 legs 41
 loading spool 22
- M**
-
- machine surface cleaning 146
 main power switch Cover C, 11
 maintenance 146
 manual needle threading 28
 memory key Cover E
 mirroring stitches 58
- N**
-
- needle bar thread hooks Cover C
 needle condition 35
 needle plate Cover C
 needle plate marking 61
 needle position button Cover D
 needle position, changing 74
 needle replacement 35
 needle set Cover A
 needle threader 25
 needle threading 21, 25
 needle types, sizes & uses 34
 needle-changing tool Cover A, 36
 needles 33
 next page key Cover E
- O**
-
- operation beep 155
 operation buttons Cover B, 47
 operation controls Cover D
 operation keys 129
 operation keys & panel Cover E
- operation manual Cover A
 operation panel Cover B
 operation problems 148
 operations 15
 overcasting stitches 69
- P**
-
- pant legs 41
 parallel stitches 29
 part names & functions Cover B
 patchwork 91, 93
 pattern embroidery 134
 piecing 93
 piecing straight stitch 91
 plain seams 73
 plug 11
 positioning fabric 46
 power cord, jack, switch & supply 11
 power supply jack Cover C
 power switch Cover C
 preparations for embroidering 112
 presser foot Cover C
 presser foot holder installation 40
 presser foot holder removal & installation 40
 presser foot lever Cover D
 presser foot replacement 38
 previous page key Cover E
 problem-solving 148
 pulling up bobbin thread 31
- Q**
-
- quick reference guide Cover A
 quilt stitching 91
 quilting 94
 quilting guide 95
 quilting stippling 91
 quilting stitch 91
- R**
-
- recalling stored characters 140
 reinforcement stitching 49, 98
 removing presser foot holder 40
 replacing needle 35
 replacing presser foot 38
 resewing 141
 reverse stitching 49
 reverse/reinforcement stitch button Cover D, 49
 reverse/reinforcement stitches, automatic 56
- S**
-
- safety instructions 5
 satin stitching 97
 scallop stitch 103
 scallop stitching 105
 scissors Cover A
 screwdriver Cover A
 seam allowance, even 61
 seam ripper Cover A, 80
 securing stitching 49

selecting embroidery patterns	128
selecting stitches	45
settings key	Cover E
settings, changing	13
sewing basics	44
sewing direction change	59
sewing speed controller	Cover D, 47
shell tuck stitch	103, 106
shuttle	20
shuttle cleaning	146
shuttle removal	147
side cutter	71
sleeve cuffs	41
sliding leg	Cover B, 41
smocking	105
smocking stitch	103
soft cover	Cover A
solving operation problems	148
spool cap	Cover A, 17, 19
spool loading	22
spool net	Cover A, 18
spool of thread	21
spool pin	Cover A, 23, 27, 29
stabilizer material	122
start/stop button	Cover D, 47
stippling	91
stitch length adjustment	55
stitch selection	45
stitch settings	64
stitch width adjustment	54
stopping embroidering	142
storing characters	139
straight stitch	64, 73, 84
stretch fabrics	60, 89
stretch stitch	89

T

thick fabrics	60
thin fabrics	60
thread cassette	Cover A, 22
thread cassette compartment & cover	Cover B
thread cassette eject lever	Cover B, 23
thread cassette indicator	Cover D, 25
thread cutter	Cover B, 51
thread cutter button	Cover D, 50
thread cutting	50
thread cutting, automatic	57
thread guide for bobbin winding	Cover B, 18
thread spools	21
thread tension adjustment	52, 141
thread tension dial	Cover B, 53
threading bobbin	20
threading needle	21, 25
threading needle manually	28
tips	59
touch panel	Cover E
trial sewing	59
triple stretch stitch	73, 98
troubleshooting	148
turning machine on/off	11
twin needle	Cover A, 29
two threads	29

U

upper thread	21
upper thread spool	23
upper thread tension	52
utility stitch selection screen	12
utility stitches	103

W

winding bobbin	16
wing needle	108

Z

zigzag stitches	70, 89, 91
zigzag width adjustment	54
zipper sewing	84

Free Manuals Download Website

<http://myh66.com>

<http://usermanuals.us>

<http://www.somanuals.com>

<http://www.4manuals.cc>

<http://www.manual-lib.com>

<http://www.404manual.com>

<http://www.luxmanual.com>

<http://aubethermostatmanual.com>

Golf course search by state

<http://golfingnear.com>

Email search by domain

<http://emailbydomain.com>

Auto manuals search

<http://auto.somanuals.com>

TV manuals search

<http://tv.somanuals.com>