



Electronic lockstitch button holer

HE-800A

- 21 built-in patterns plus original patterns
- Adjustable presser foot lifter height makes insertion and removal of the material easier
- Quick and accurate double position cutter operation
- PD-8000 Programmer uses easy-to-use icon display (Optional product)



HE-800A



PD-8000

Electronic operation provides a much greater number of pattern variations and a dramatic improvement in sewing quality

21 built-in sewing patterns plus original patterns

Program selection is as easy as pressing a button. 90 separate programs can be stored in memory. Furthermore, you can add up to 9 original patterns with programming software for electronic pattern sewer (optional product).

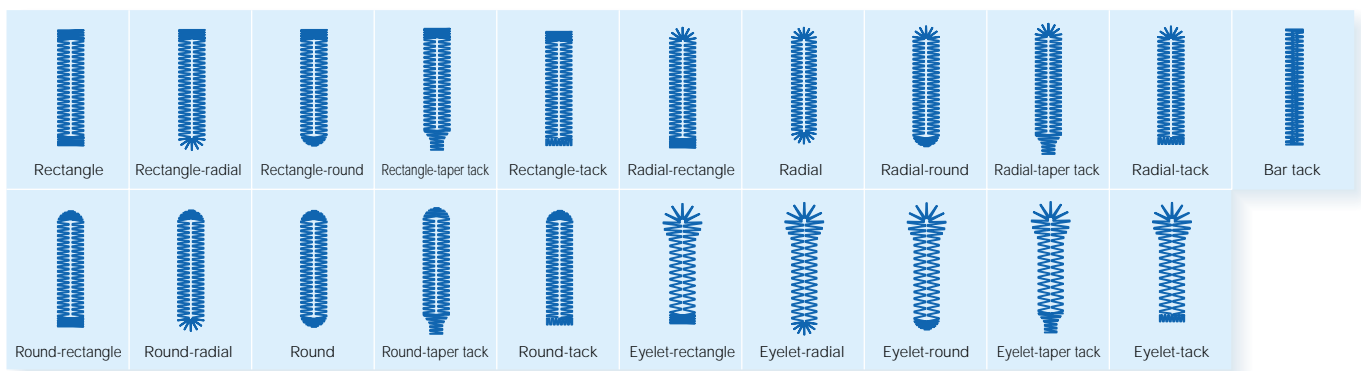

Easy operation

Easy positioning

- The presser foot lifter is driven by a pulse motor, so that the height can be adjusted as desired (standard function) for when the pedal is at the neutral position and when it is depressed forward (two stages) and backward. This makes insertion and removal of the material easier and reduces working fatigue.
- The presser foot rises only by the height necessary, so that the time needed for it to rise and drop can be shortened.



Easy operation

No need for adjustments such as replacing cutter cams when changing number of stitches

The cutter vertical movements is driven by a double position solenoid. If not using a cutter, the cutter operation can be deactivated at the press of a key. The cutter operates without slowing down the sewing machine, and the cutter response time is also fast, so that cycle time is reduced and productivity is increased.

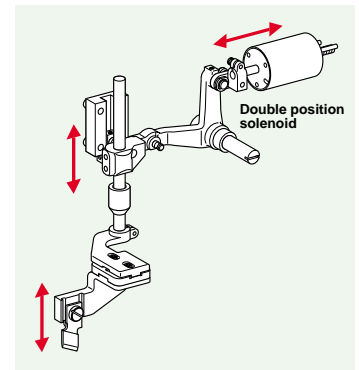

Simple and easy-to-use operation panel

There is a program memo pocket provided on the back of the panel. This lets the operator keep necessary information such as a parameter table, program notes and an error code table on hand for easy reference. The operator can select panel position whichever above or below the work table.



Purl stitch / Whip stitch

The upper thread tension is controlled by a solenoid, so that setting between purl stitches and whip stitches can be done simply by selecting them on the operation panel. Fine adjustments to the upper thread tension are made using a thread tension nut. The same method that operators have become used to allows the optimum thread tension to be easily obtained.

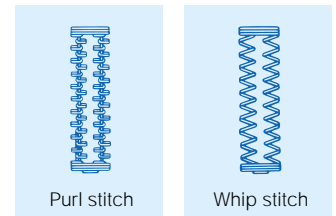

Ideal for sewing vertical buttonholes

A wider operating area is available when the machine head is positioned horizontally on the work table.

Quiet operating environment

Adoption of a clutchless mechanism ensures quieter operating environment and increased durability.

Easy threading

The needle bar can be moved to the right as a matter of course, and this makes threading much easier.

Accurate home position detection

The home position sensor incorporates a non-optical proximity sensor, so the sensor is not subject to operating errors from oil or dust, and cleaning oil and dust from the sensor are also unnecessary.

Thread trimming speed can be set

The lower thread trimming mechanism operates in conjunction with the presser foot lifter mechanism, and is driven by a pulse motor. As a result, the thread trimmer driving speed can also be changed at the operation panel.

Gives perfect sewing finishes

Wide sewing range

The thread take-up, rotary hook and thread path mechanisms provide ideal balance, so that attractive buttonholes can be sewn in a variety of different materials under a variety conditions.

Accurate cutter operation

The cutter vertical movements is driven by a double position solenoid, so that the material is cut more accurately.

Clean finish with no upper thread trailing length

Attractive finishes are obtained with no upper thread trailing at the sewing end. This ensures a stable and consistent high-quality sewing finish is always obtained.

Better stitches at the sewing start

Adoption of a bobbin presser prevents the bobbin from spinning free when the lower thread is trimmed. This makes lower thread feeding more stable and produces better stitches at the sewing start. And the lower thread holding device holds the lower thread at the sewing start to ensure that the thread end is sewn into the seam properly.

Gives perfect sewing finishes

Stable zigzag seams even at high speed

A new needle zigzag mechanism (patent pending) reduces the effect of vibration from upper shaft rotation on the needle bar, so that stable and accurate needle zigzagging is obtained even at high speeds. When sewing speed has been changed, a knife is not used to trim the thread. The cutter space does not change, further making sure that the finish is attractive.

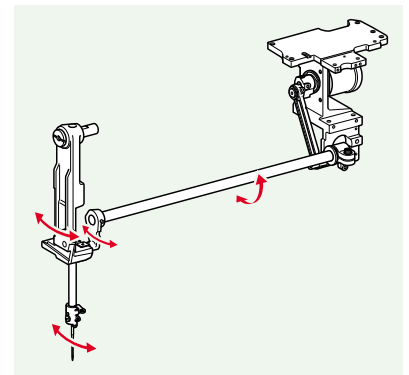

Adjustment of zigzag width balance is possible

The left and right stitch width ratio for buttonholes can be set on the operation panel.

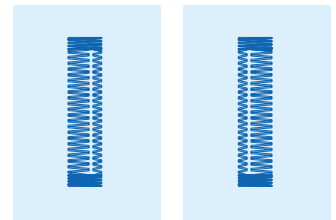

Under lay

Up to four pattern can be combined and sewn together.

Rectangle

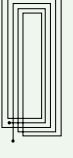

- Effective for preventing material from stretching.
- If the seam is hidden and the width seems small, sew 2-3 underlays to make the material look more voluminous.
- Because the material can be move slightly up to five times, the seam flexibility is maintained and the button hole strength can also be increased.

Saw shape

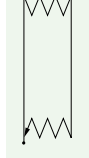

- This is useful for preventing dimples from forming during bar tacking.
- It is also effective for strengthening the buttonholes to stop the seam from unravelling, which can often happen with materials with coarse weaves.

Sew together



- If the cutter has operated before the seam has been formed, the hole made by the cutter is sewn up beforehand.
- The pile of fluffy fabric is pressed down before sewing, so that the buttonhole finish looks more attractive.

Zigzag

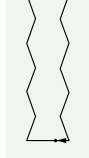

- Effective for preventing seam from unravelling.

Selectable cutter operation

The operation of the cutter can be set to one of four timings (front knife, center knife, rear knife and front + center knife). When the front knife setting is used, the rough edges are hemmed by the buttonhole stitches after cutting, thus providing a more attractive finish. When "Feeding when cutter operating" is set, only the feed mechanism operates after sewing and the cutter moves to the specified position, so that the button hole can be cut right up to the front backtacking.

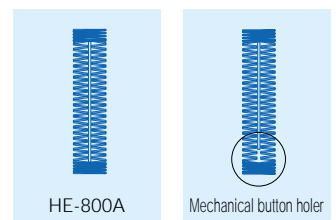

Two-cycle sewing

When set to two-cycle cross sewing, the zigzag stitches sewn during the first and second cycles do not overlap with each other, so that the sewing pitch appears finer and the finish looks even more attractive.

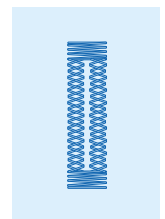

Prevents dimples at the rear tack

Selectable rear tack vector shape prevents dimples at the rear tack section when not using an underlay.

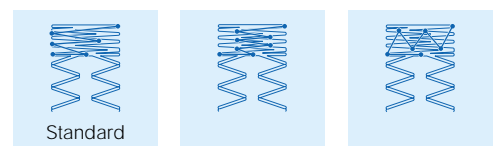

Zigzag sewing pitch

The zigzag pitch setting range has been made even finer. You can now select intermediate pitches which were previously impossible.

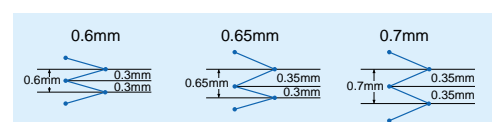

Options

Needle plate set, RB

The elasticity of rubber is used to make cutting more accurate by stopping the cutter from getting stuck in the material and not returning.

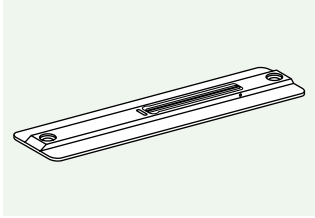

Tape guard winder

For materials which stretch extremely easily, such as all types of knitted materials, stronger buttonholes can be sewn if tape is attached to the underside of the article being sewn.

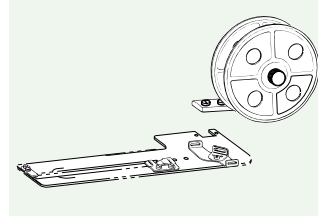

Ruler

This makes buttonhole positioning quicker and more accurate.

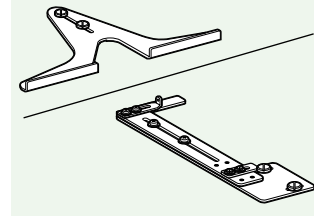





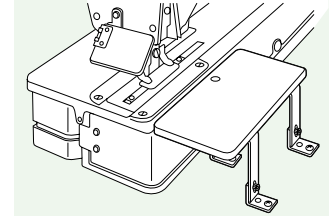

Sub-table

Increases ease of working when setting the material.



Specifications

Model	 Lock Stitch	 Button holing	 1-needle	 Thread trimmer	 Automatic presser foot lifter	 Max. sewing speed
HE-800A	★	★	★	★	13 mm	4,000 rpm

Zigzag mechanism	Pulse motor
Feed mechanism	Pulse motor
Presser foot lifter mechanism	Pulse motor (standard equipment)
Cutter mechanism	Double position solenoid
Lower thread holding device	Standard equipment
Bobbin presser	Standard equipment
Standard sewing pattern	21
Memory pattern	90
Max. number of stitch	700 stitches / program
Needle	Schmetz Nm 134
Data storage method	P-ROM (Custom made pattern can be added by PS-3000)
Power supply	Single-phase : 110V, 220V, 230V, 600VA Three-phase : 220V, 380V, 400V
Cutter length	4.0 - 32mm
Buttonhole size	Max.sewing width : 6mm Max.buttonhole length : 40mm

Motor specification for HE-800A is MD-611-H.

HE-800A-

Application	
2	Woven articles such as shirts, blouses, work clothes and ladies' attire
3	Knitted article such as underwear, sweaters, cardigans and jerseys

Peripheral equipment



PS-3000 Programming software for electronic pattern sewer

This is a software package which lets you create new patterns using a personal computer. It can be used to program any patterns other than those patterns which have been pre-programmed. (A P-ROM writer is required.)

Optional product



PD-8000 Programmer

You can set parameters simply by selecting an icon, so that sewing data can be created easily. In addition, the programmer can be disconnected from one sewing machine and connected to another one, so that program data can be copied between machines. A single programmer can thus be used to create programs for several machines.

Product specifications are subject to change for improvement without notice. Please read instruction manual before using the machine for safety operation.

brother[®]
BROTHER INDUSTRIES, LTD.

15-1, Naeshiro-cho, Mizuho-ku, Nagoya 467-8561, Japan.
Phone: 81-52-824-2177 Fax: 81-52-811-7789 <http://www.brother.com/>

Free Manuals Download Website

<http://myh66.com>

<http://usermanuals.us>

<http://www.somanuals.com>

<http://www.4manuals.cc>

<http://www.manual-lib.com>

<http://www.404manual.com>

<http://www.luxmanual.com>

<http://aubethermostatmanual.com>

Golf course search by state

<http://golfingnear.com>

Email search by domain

<http://emailbydomain.com>

Auto manuals search

<http://auto.somanuals.com>

TV manuals search

<http://tv.somanuals.com>