

brother[®]

Operation Manual

Computerized Sewing Machine

Read before use.

1 GETTING READY

2 SEWING BASICS

3 UTILITY STITCHES

Read when additional information is required.

4 APPENDIX

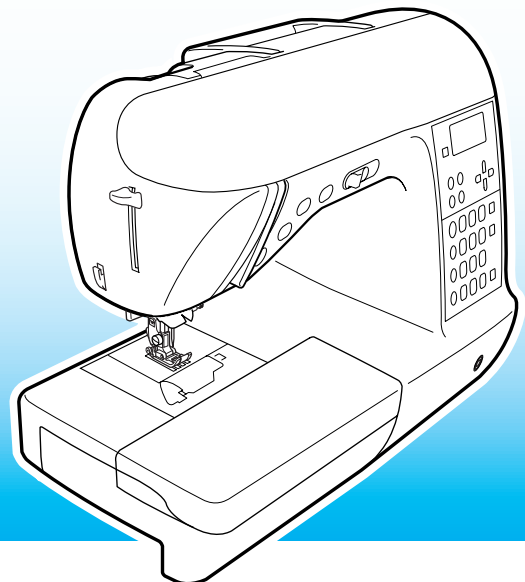

Important Safety Instructions

Please read these safety instructions before attempting to use the machine.
This machine is intended for household use.

DANGER - To reduce the risk of electric shock:

1 Always unplug the machine from the electrical outlet immediately after using, when cleaning, when making any user servicing adjustments mentioned in this manual, or if you are leaving the machine unattended.

WARNING - To reduce the risk of burns, fire, electric shock, or injury to persons.

2 Always unplug the machine from the electrical outlet when removing covers, lubricating, or when making any adjustments mentioned in the instruction manual:

- To unplug the machine, switch the machine to the symbol "O" position to turn it off, then grasp the plug and pull it out of the electrical outlet. **Do not** pull on the cord.
- Plug the machine directly into the electrical outlet. Do not use an extension cord.
- **Always** unplug your machine if the power is cut.

3 Never operate this machine if it has a damaged cord or plug, if it is not working properly, if it has been dropped or damaged, or water is spilled on the unit. Return the machine to the nearest authorized dealer or service center for examination, repair, electrical or mechanical adjustment. While the machine is stored or in use if you notice anything unusual, such as an odor, heat, discoloration or deformation, stop using the machine and immediately unplug the power cord.

4 Always keep your work area clear:

- Never operate the machine with any air openings blocked. Keep ventilation openings of the sewing machine and foot control free from the build up of lint, dust, and loose cloth.
- **Do not** store objects on the foot controller.
- **Do not** use extension cords. Plug the machine directly into the electrical outlet.
- **Never** drop or insert **any** object into **any** opening.
- **Do not** operate where aerosol (spray) products are being used or where oxygen is being administered.
- **Do not** use the machine near a heat source, such as a stove or iron; otherwise, the machine, power cord or garment being sewn may ignite, resulting in fire or an electric shock.

5 Special care is required when sewing:

- **Always** pay close attention to the needle. Do not use bent or damaged needles.
- Keep fingers away from **all** moving parts. Special care is required around the machine needle.
- Switch the sewing machine to the symbol "O" position to turn it off when making any adjustments in the needle area.
- **Do not** use a damaged or incorrect needle plate, as it could cause the needle to break.
- **Do not** push or pull the fabric when sewing, and follow careful instruction when freehand stitching so that you do not deflect the needle and cause it to break.

6 This machine is **not** a toy:

- Your close attention is necessary when the machine is used by or near children.
- Do not use outdoors.

7 For a longer service life:

- When storing this machine, avoid direct sunlight and high humidity locations. Do not use or store the machine near a space heater, iron, halogen lamp, or other hot objects.
- Use only neutral soaps or detergents to clean the case. Benzene, thinner, and scouring powders can damage the case and machine, and should never be used.
- Always consult the operation manual when replacing or installing any assemblies, the presser feet, needle, or other parts to assure correct installation.

8 For repair or adjustment:

- If the Light unit (light-emitting diode) is damaged, it must be replaced by authorized dealer.
- In the event a malfunction occurs or adjustment is required, first follow the troubleshooting table in the back of the operation manual to inspect and adjust the machine yourself. If the problem persists, please consult your local authorized Brother dealer.

Use this machine only for its intended use as described in this manual.

Use accessories recommended by the manufacturer as contained in this manual.

Save these instructions.

The contents of this manual and specifications of this product are subject to change without notice.

For additional product information, visit our web site at www.brother.com

FOR USERS IN THE UK, EIRE, MALTA AND CYPRUS ONLY

IMPORTANT

- In the event of replacing the plug fuse, use a fuse approved by ASTA to BS 1362, i.e. carrying the  mark, rating as marked on plug.
- Always replace the fuse cover. Never use plugs with the fuse cover omitted.
- If the available electrical outlet is not suitable for the plug supplied with this equipment, you should contact your authorized dealer to obtain the correct lead.

FOR USERS IN AUSTRALIA AND NEW ZEALAND

This sewing machine is not intended to be used by young children, and assistance may be required if used by a person with a disability.

Contents

Important Safety Instructions	1
Introduction	7
Sewing Machine Features	7
Accessories	8
Included accessories	8
Optional accessories	9
Names of Machine Parts and Their Functions	10
Front view	10
Needle and presser foot section	11
Right-side/rear view	11
Operation buttons	12
Operation panel	13

GETTING READY 15

Turning the Machine On/Off.....	16
Power supply precautions	16
Turning on the machine	17
Turning off the machine	17
Understanding the LCD Screens.....	18
Changing the Machine Settings	19
Changing the settings	19
Adjusting the brightness of the LCD	21
Changing the screen language.....	21
Winding/Installing the Bobbin.....	22
Bobbin precautions	22
Winding the bobbin	22
Installing the bobbin	26
Upper Threading	28
Threading the upper thread	28
Threading the needle	31
Threading the needle manually (without using the needle threader)	33
Using the twin needle	33
Pulling up the bobbin thread.....	36
Replacing the Needle	37
Needle precautions	37
Needle types and their uses.....	38
Checking the needle	39
Replacing the needle.....	39
Replacing the Presser Foot	41
Presser foot precautions	41
Replacing the presser foot	41
Adjusting the pressure of the presser foot	43
Removing the presser foot holder	43
Using the walking foot	44
Sewing Cylindrical or Large Pieces.....	46
Stitching cylindrical pieces.....	46
Sewing large pieces of fabric.....	46

Sewing	50
General sewing procedure	50
Positioning the fabric	51
Starting to sew.....	52
Securing the stitching.....	54
Cutting the thread	55
Adjusting the Thread Tension	57
Changing the tension of the upper thread.....	57
Adjusting the Stitch Width and Length	58
Adjusting the stitch width.....	58
Adjusting the stitch length	59
Useful Functions	60
Changing the needle stop position	60
Automatically sewing reverse/reinforcement stitches.....	60
Automatically cutting the thread	62
Saving stitch settings	63
Hands-free raising and lowering of the presser foot	64
Useful Sewing Tips	65
Trial sewing	65
Changing the sewing direction.....	65
Sewing curves.....	65
Sewing thick fabrics	66
Sewing thin fabrics.....	66
Sewing stretch fabrics.....	66
Sewing leathers or vinyl fabrics	67
Sewing an even seam allowance.....	67

UTILITY STITCHES

Selecting Stitching	70
Selecting stitch types and patterns	70
Selecting stitching	72
Overcasting Stitches	76
Sewing overcasting stitches using overcasting foot "G"	76
Sewing overcasting stitches using zigzag foot "J"	77
Sewing overcasting stitches using the optional side cutter	78
Basic Stitching	80
Basting	80
Basic stitching.....	81
Blind Hem Stitching	82
Buttonhole Stitching/Button Sewing	84
Buttonhole sewing	85
Button sewing	89
Zipper Insertion	91
Inserting a centered zipper.....	91
Inserting a side zipper	93
Zipper/piping Insertion	96
Inserting a centered zipper.....	96
Inserting a piping	97
Sewing Stretch Fabrics and Elastic Tape	98
Stretch stitching.....	98
Elastic attaching	98

Appliqué, Patchwork and Quilt Stitching	100
Appliqué stitching	101
Patchwork (crazy quilt) stitching	102
Piecing	102
Quilting	103
Free-motion quilting	104
Satin stitching using the sewing speed controller	105
Reinforcement Stitching	107
Triple stretch stitching	107
Bar tack stitching	107
Darning	109
Eyelet Stitching	111
Decorative Stitching	112
Fagoting	113
Scallop stitching	114
Smocking	114
Shell tuck stitching	115
Joining	116
Heirloom stitching	116
Sewing the Various Built-In Decorative Patterns	119
Sewing beautiful patterns	119
Sewing patterns	119
Combining patterns	120
Repeat sewing patterns	121
Checking the selected pattern	121
Changing the pattern size	122
Changing the stitch density	123
Changing the pattern length	124
Mirror imaging the pattern	125
Saving patterns	126
Retrieving a pattern	126
Realigning the pattern	127
Designing a Pattern	129
Drawing a sketch of the pattern	129
Entering the pattern data	130
Examples of designs	132

APPENDIX

133

Stitch Settings	134
Utility stitches	134
Other stitches	138
Care and Maintenance	142
Cleaning the machine surface	142
Cleaning the race	142
Troubleshooting	144
Error messages	148
Nothing appears in the LCD	149
Operation beep	149
Cancelling the operation beep	149
Index	151

Introduction

Thank you for purchasing this sewing machine. Before using this sewing machine, carefully read the "Important Safety Instructions" (page 1), and then study this manual for the correct operation of the various functions. In addition, after you have finished reading this manual, store it where it can quickly be accessed for future reference.

Sewing Machine Features

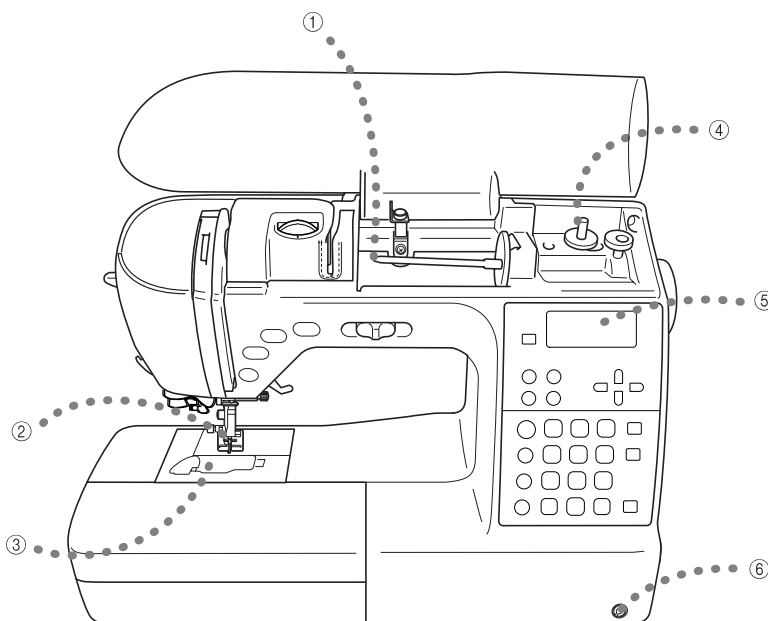

- ① **Easy upper threading**
Since the spool can be installed at the front of the sewing machine, the upper thread can easily be threaded. In addition, the needle can be threaded with a simple operation (page 28).
- ② **Automatic thread-cutting**
The sewing machine can be set to automatically cut the thread at the end of the stitching (page 62).
- ③ **One-touch lower threading**
You can start sewing without pulling up the bobbin thread (page 26).
- ④ **Simple bobbin-winding**
The bobbin can quickly and easily be wound with thread (page 22).
- ⑤ **Built-in stitches**
You can select from the built-in stitches available, including utility stitches, character stitches and decorative stitches.
- ⑥ **Knee lifter**
Use the knee lifter to raise and lower the presser foot with your knee, leaving both hands free to handle the fabric (page 64).

Accessories

After opening the box, check that the following accessories are included. If any item is missing or damaged, contact your dealer.

Included accessories

The following items should also be included in the box.

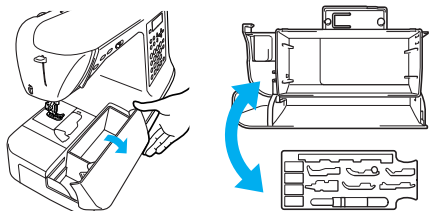

Note

(For U.S.A. only)

- Foot controller: Model N5V
This foot controller can be used on this machine model NX-450.
- The screw for the presser foot holder is available through your authorized dealer.
(Part code: XA4813-051)
- The organized accessory tray is available through your authorized dealer.
(Part code: XC4489-051)

■ Attaching the stitch pattern plate

The stitch pattern plate shows the stitch numbers and the patterns available with each stitch mode. Attach the stitch pattern plate to the handle as shown in the illustration below.

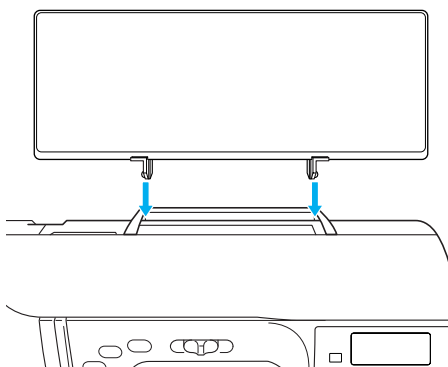

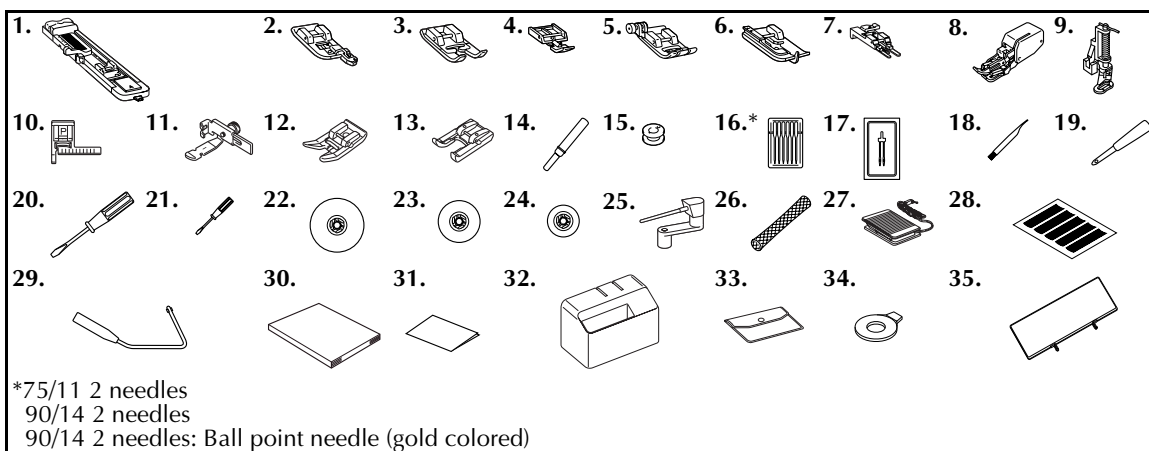

No.	Part Name	Part Code		No.	Part Name	Part Code	
		U.S.A./Canada	Others			U.S.A./Canada	Others
1	Buttonhole foot "A"		XC2691-053	19	Eyelet punch		135793-001
2	Overcasting foot "G"		XC3098-051	20	Screwdriver (large)		XC8349-051
3	Monogramming foot "N"		X53840-351	21	Screwdriver (small)		X55468-051
4	Zipper foot "I"		X59370-051	22	Spool cap (large)		130012-054
5	Zigzag foot "J" (on machine)		XC3021-051	23	Spool cap (medium)(2)		X55260-153
6	Blind stitch foot "R"		X56409-051	24	Spool cap (small)		130013-154
7	Button fitting foot "M"		130489-001	25	Extra spool pin		XC4654-051
8	Walking foot	SA140	F033N (XC2214-002)	26	Spool net		XA5523-050
9	Quilting foot	SA129	F005N (XC1948-002)	27	Foot controller		XD0496-051 (EU area) XC6651-151 (other areas)
10	Stitch guide foot "P"	SA160	F035 (XC1969-002)	28	Grid sheet set	SA527	GS4 (XC4549-050)
11	Adjustable zipper/piping foot	SA161	F036N (XC1970-002)	29	Knee lifter		XA6941-052
12	Non stick foot	SA114	F007N (XC1949-002)	30	Operation manual		XE0403-001
13	Open toe foot	SA147	F027N (XC1964-002)	31	Quick reference guide		XE0404-001
14	Seam ripper		X54243-051	32	Hard case		XC9701-052
15	Bobbin (4)	SA156	SFB (XA5539-151)	33	Accessory bag		XC4487-051
17	Twin needle		X59296-151	34	Disc-shaped screwdriver		XC1074-051
18	Cleaning brush		X59476-051	35	Stitch pattern plate		XE0539-001

Optional accessories

The following are available as optional accessories.

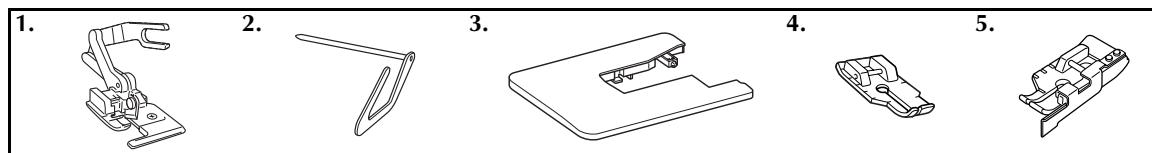

1. **Side cutter** Part code: SA177, F054(XC3879-002)
2. **Quilting guide** Part code: SA132, F016N(XC2215-002)
3. **Wide table** Part code: SA551, WT5(XC9567-152)
4. **1/4 inch quilting foot** Part code: SA125, F001N(XC1944-052)
5. **1/4 inch quilting foot with guide** Part code: SA185, F057(XC7416-252)



Memo

- To obtain optional accessories or parts, contact your sales representative or the nearest authorized service center.

Names of Machine Parts and Their Functions

The names of the various parts of the sewing machine and their functions are described below. Before using the sewing machine, carefully read these descriptions to learn the names of the machine parts.

Front view

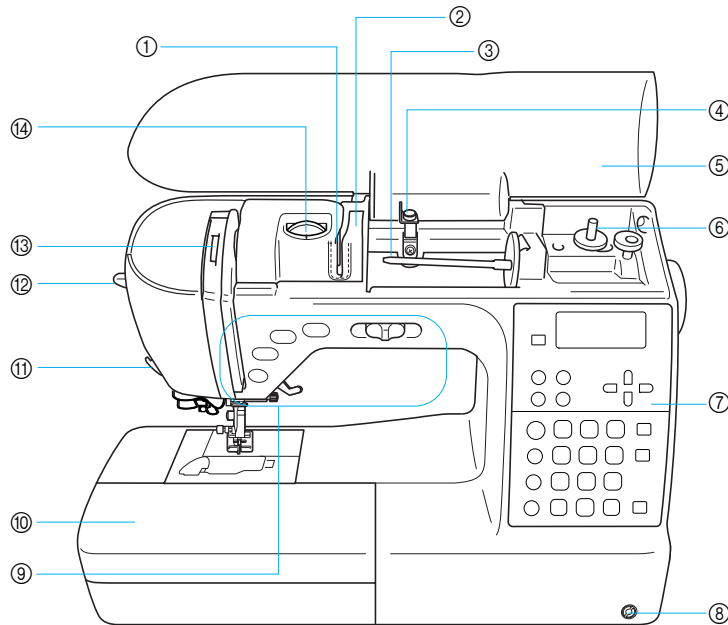

- ① **Thread guide plate**
Pass the thread under the thread guide plate.
- ② **Thread guide cover**
Pass the thread behind the thread guide cover when threading the upper thread.
- ③ **Spool pin**
Place a spool of thread on the spool pin.
- ④ **Bobbin winding thread guide and pretension disk**
Pass the thread under this thread guide and around the pretension disk when winding the bobbin thread.
- ⑤ **Top cover**
Open the top cover to place the spool of thread on the spool pin.
- ⑥ **Bobbin winder**
Use the bobbin winder when winding the bobbin.
- ⑦ **Operation panel**
Use for stitch selection and various stitch functions. (page 13)
- ⑧ **Knee lifter mounting slot**
Insert the knee lifter into the knee lifter mounting slot.
- ⑨ **Operation buttons and sewing speed controller**
Use these buttons and the slide to operate the sewing machine. (page 12)
- ⑩ **Flat bed attachment with accessory compartment**
Store presser feet and bobbins in the accessory compartment of the flat bed attachment. When sewing cylindrical pieces, remove the flat bed attachment.
- ⑪ **Thread cutter**
Pass the threads through the thread cutter to cut them.
- ⑫ **Needle threader lever**
Use the needle threader to thread the needle.
- ⑬ **Thread take-up lever check window**
Look through the window to check the position of the take-up lever.
- ⑭ **Thread tension dial**
Use the thread tension dial to adjust the tension of the upper thread.

Needle and presser foot section

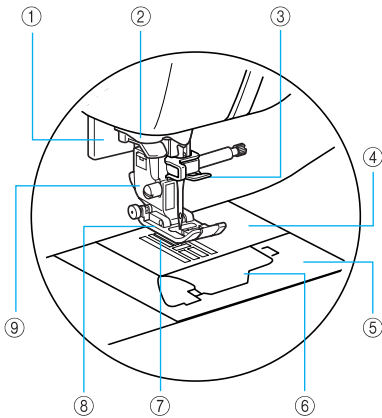

- ① **Buttonhole lever**
The buttonhole lever is used with the one-step buttonhole foot to create buttonholes.
- ② **Thread guide disk**
Pass the thread through the thread guide disk when using the needle threader to thread the needle.
- ③ **Needle bar thread guide**
Pass the upper thread through the needle bar thread guide.
- ④ **Needle plate**
The needle plate is marked with guides to help sew straight seams.
- ⑤ **Needle plate cover**
Remove the needle plate cover to clean the bobbin case and race.
- ⑥ **Bobbin cover**
Open the bobbin cover to set the bobbin.
- ⑦ **Feed dogs**
The feed dogs feed the fabric in the sewing direction.
- ⑧ **Presser foot**
The presser foot applies pressure consistently on the fabric as sewing takes place. Attach the appropriate presser foot for the selected stitch.
- ⑨ **Presser foot holder**
The presser foot is attached onto the presser foot holder.

Right-side/rear view

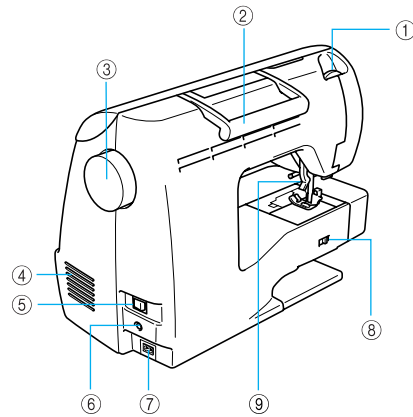

- ① **Presser foot dial**
Use the presser foot dial to adjust the amount of pressure that the presser foot applies to the fabric.
- ② **Handle**
Carry the sewing machine by its handle when transporting the machine.
- ③ **Handwheel**
Turn the handwheel toward you to raise and lower the needle. The handwheel should be turned towards you (counterclockwise).
- ④ **Air vent**
The air vent allows the air surrounding the motor to circulate. Do not cover the air vent while the sewing machine is being used.
- ⑤ **Main power switch**
Use the main power switch to turn the sewing machine ON and OFF.
- ⑥ **Foot controller jack**
Insert the plug on the end of the foot controller cable into the foot controller jack.
- ⑦ **Power supply jack**
Insert the plug on the power cord into the power supply jack.
- ⑧ **Feed dog position switch**
Use the feed dog position switch to lower the feed dogs.
- ⑨ **Presser foot lever**
Raise and lower the presser foot lever to raise and lower the presser foot.



Memo

- Refer to pages 9 through 12 while you are learning to use your machine.

Operation buttons

The operation buttons help you to easily perform various basic sewing machine operations.

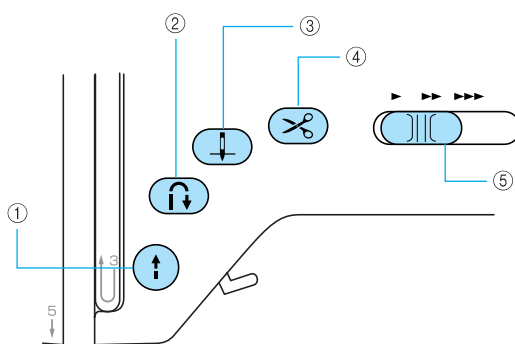

① “Start/Stop” button (↑)

Press the “Start/Stop” button to start or stop sewing. The machine sews at a slow speed at the beginning of sewing while the button is depressed. When sewing is stopped, the needle is lowered in the fabric. For details, refer to “Starting to sew” (page 52).

The button lights up in green, red or orange, depending on how the sewing machine is being operated.

Green: When the machine is ready to start sewing or while it is sewing

Red: When the machine is not ready to start sewing

Orange: When the bobbin winder shaft is moved to the right for winding the bobbin thread onto the bobbin

② “Reverse/Reinforcement Stitch” button (↕)

Press the “Reverse/Reinforcement Stitch” button to sew reverse stitches or reinforcement stitches. Reverse stitches are sewn by keeping the button pressed down to sew in the opposite direction. Reinforcement stitches are sewn by sewing 3 to 5 stitches on top of each other. For details, refer to “Securing the stitching” (page 54).

③ “Needle Position” button (↑↓)

Press the “Needle Position” button to raise or lower the needle. Pressing the button twice sews one stitch.

④ “Thread Cutter” button (✂)

Press the “Thread Cutter” button after stopping sewing to cut both the upper and the bobbin threads. For details, refer to “Cutting the thread” (page 55).

⑤ Sewing speed controller

Slide the sewing speed controller to adjust the sewing speed.

⚠ CAUTION

- Do not press (✂) (“Thread Cutter” button) after the threads have already been cut, otherwise the needle may break, the threads may become tangled or damage to the machine may occur.









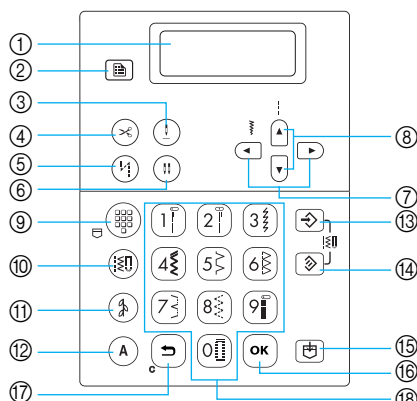











⚡ Note

- Do not press (✂) (“Thread Cutter” button) if there is no fabric under the presser foot or while the machine is sewing, otherwise damage to the machine may occur.
- When cutting thread thicker than #30, nylon thread or other special threads, use the thread cutter on the side of the machine. For details, refer to “Cutting the thread” (page 55).

Operation panel

The operation panel, located on the front at the right of the sewing machine, consists of the LCD (liquid crystal display) and keys for specifying various sewing settings.



- ① **LCD (liquid crystal display)**
Settings for the selected stitch and error messages for incorrect operations appear in the LCD. Use keys ② and ⑦ through ⑱, described below, to display various items and select the settings. For details, refer to "Understanding the LCD Screens" (page 18).
- ② **Settings key** 
Press this key to select sewing settings, such as for left/right mirror imaging, or other settings such as the operation beep.
- ③ **Needle stop position key** 
Press this key to select where the needle is positioned when the sewing machine is stopped.
- ④ **Automatic thread cutting key** 
Press this key to select the automatic thread cutting setting. Press this key again to cancel the setting.
- ⑤ **Automatic reverse/reinforcement stitch key** 
Press this key to select the automatic reverse/reinforcement stitching setting. Press this key again to cancel the setting.
- ⑥ **Needle mode selection key (single/twin)** 
Press this key to select the twin needle sewing setting. Each time this key is pressed, the setting switches between that for single needle sewing and for twin needle sewing.
- ⑦ **Stitch width keys**
Press  or  to adjust the stitch width setting.
- ⑧ **Stitch length keys**
Press  or  to adjust the stitch length setting.
- **Stitch mode keys (⑨-⑱)**
- ⑨ **Preset utility stitch/saved pattern key** 
Press this key to select the utility stitch assigned to a numeric key or to retrieve a pattern that has been saved. Each time this key is pressed, the machine switches between the preset utility stitch mode and the saved pattern mode.
- ⑩ **Utility stitch key** 
Press this key to select a straight stitch, zigzag stitch, buttonhole, blind hem stitch, or other stitches commonly used in garment sewing. Use the numeric keys to type in the number of the desired stitch.
- ⑪ **Decorative stitch key** 
Press this key to select a decorative stitch, satin stitch, cross-stitch or decorative satin stitch. Each time this key is pressed, the stitch group switches between  and .
- ⑫ **Character stitch key** 
Press this key to select a character stitch. Each time this key is pressed, the font switches to one of the three available.
- ⑬ **Manual memory key** 
Press this key to save the adjusted stitch width and length settings.
- ⑭ **Reset key** 
Press this key to reset the selected stitch to its original settings.
- ⑮ **Memory key** 
Press this key to save stitch patterns, such as combined patterns and My Custom Stitch patterns, in the sewing machine's memory.
- ⑯ **OK key** 
Press this key to apply the selection or perform the operation.
- ⑰ **Cancel/clear key** 
Press this key to cancel the operation and return to the previous screen.
In addition, pressing this key removes the last pattern added when combining characters or decorative stitches.
- ⑱ **Numeric keys**
Use these keys to quickly select one of the ten most often used stitches. When selecting other stitches, use these keys to type in the number of the desired stitch.

1

GETTING READY

The various preparations required before starting to sew are described in this chapter.

Turning the Machine On/Off.....	16
Power supply precautions	16
Turning on the machine	17
Turning off the machine	17
Understanding the LCD Screens.....	18
Changing the Machine Settings	19
Changing the settings	19
Adjusting the brightness of the LCD	21
Changing the screen language	21
Winding/Installing the Bobbin.....	22
Bobbin precautions	22
Winding the bobbin	22
Installing the bobbin	26
Upper Threading	28
Threading the upper thread.....	28
Threading the needle.....	31
Threading the needle manually (without using the needle threader).....	33
Using the twin needle	33
Pulling up the bobbin thread.....	36
Replacing the Needle	37
Needle precautions	37
Needle types and their uses.....	38
Checking the needle.....	39
Replacing the needle	39
Replacing the Presser Foot	41
Presser foot precautions	41
Replacing the presser foot.....	41
Adjusting the pressure of the presser foot	43
Removing the presser foot holder	43
Using the walking foot	44
Sewing Cylindrical or Large Pieces.....	46
Stitching cylindrical pieces.....	46
Sewing large pieces of fabric.....	46

Turning the Machine On/Off

This section explains how to turn the sewing machine on and off.

Power supply precautions

Be sure to observe the following precautions concerning the power supply.

WARNING

- Use only regular household electricity for the power source. Using other power sources may result in fire, electric shock, or damage to the machine.
 - Make sure that the plugs on the power cord are firmly inserted into the electrical outlet and the power supply jack on the machine.
 - Do not insert the plug on the power cord into an electrical outlet that is in poor condition.
- Turn off the main power and remove the plug in the following circumstances:
 - When you are away from the machine
 - After using the machine
 - When the power fails during use
 - When the machine does not operate correctly due to a bad connection or a disconnection
 - During electrical storms

CAUTION

- Use only the power cord included with this machine.
- Do not use extension cords or multi-plug adapters with many other appliances plugged in to them. Fire or electric shock may result.
- Do not touch the plug with wet hands. Electric shock may result.
- When unplugging the machine, always turn off the main power first. Always grasp the plug to remove it from the outlet. Pulling on the cord may damage the cord, or lead to fire or electric shock.
- Do not allow the power cord to be cut, damaged, modified, forcefully bent, pulled, twisted, or bundled. Do not place heavy objects on the cord. Do not subject the cord to heat. These things may damage the cord and cause fire or electric shock. If the cord or plug is damaged, take the machine to your authorized dealer for repairs before continuing use.
- Unplug the power cord if the machine is not to be used for a long period of time. Otherwise a fire may result.

Turning on the machine

Prepare the included power cord.

- 1 Make sure that the sewing machine is turned off (the main power switch is set to “○”), and then plug the power cord into the power supply jack on the right side of the machine.
- 2 Insert the plug of the power cord into a household electrical outlet.

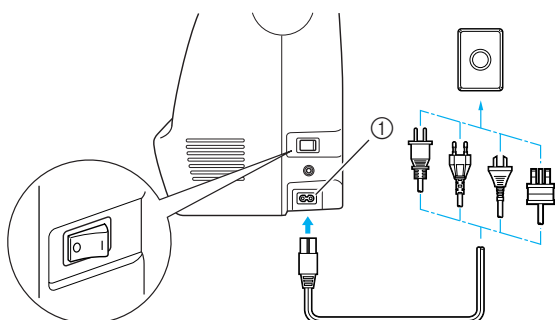

① Power supply jack

- 3 Press the right side of the main power switch on the right side of the machine (set it to “I”).

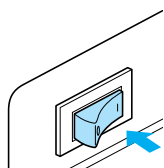

- ▶ The sewing lamp and the LCD come on when the machine is turned on.

Turning off the machine

When you are finished using the sewing machine, turn it off. In addition, before transporting the sewing machine to another location, be sure to turn it off.

- 1 Make sure that the machine is not sewing.
- 2 Press the left side of the main power switch on the right side of the machine (set it to “○”).

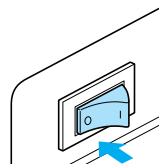

- ▶ The sewing lamp and the LCD go off when the machine is turned off.

- 3 Unplug the power cord from the electrical outlet.
Grasp the plug when unplugging the power cord.
- 4 Unplug the power cord from the power supply jack.

Note

- If a power outage occurs while the sewing machine is being operated, turn off the sewing machine and unplug the power cord. When restarting the sewing machine, follow the necessary procedure to correctly operate the machine.
(For U.S.A. only)
- This appliance has a polarized plug (one blade wider than the other). To reduce the risk of electrical shock, this plug is intended to fit in a polarized outlet only one way. If the plug does not fit fully in the outlet, reverse the plug. If it still does not fit, contact a qualified electrician to install the proper outlet. Do not modify the plug in any way.

Understanding the LCD Screens

The LCD screen, located on the front at the right of the sewing machine, displays the settings for the selected stitch and error messages if operations are performed incorrectly. When the sewing machine is turned on, the LCD comes on and the following screen appears.

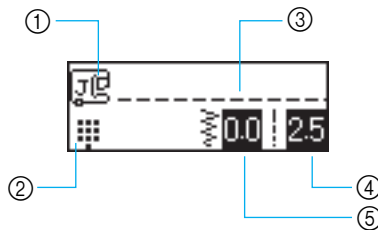

- ① Presser foot that should be used
- ② Stitch mode
- ③ Selected stitch
- ④ Stitch length (mm)
- ⑤ Stitch width (mm)



Memo

- For details on the error messages that appear when an operation is performed incorrectly, refer to “Error messages” (page 148).

Changing the Machine Settings

Various sewing machine operations and sewing settings can be changed.

Changing the settings

The general procedure for changing machine settings is described below.

- 1 Turn on the sewing machine.

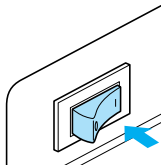



▶ The LCD comes on.

- 2 Press  (Settings key) in the operation panel.

▶ The settings screen appears.



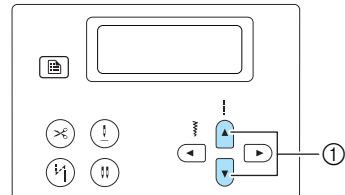

- 3 Press  or  (Stitch length keys) until the stitch or machine attribute that you wish to set is displayed.



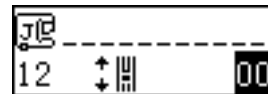
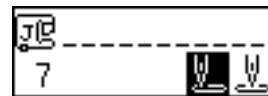

① Stitch length keys

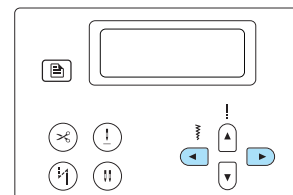

- 4 Press  or  (Stitch width keys) until the desired setting is selected.













▶ The setting is changed.

- 5 Press  (OK key) or  (Cancel/clear key).

▶ The initial stitch screen appears again.

■ List of stitch or machine attributes

The stitch or machine attributes that can be set are listed below. For details on each attribute, refer to the corresponding reference page.

Attribute	Icon	Details	Reference
Check pattern		Allows combined patterns to be checked.	page 121
Mirror imaging		Mirror images patterns along a vertical axis.	page 125
Pattern length		Adjusts the length of satin stitches.	page 124
Pattern size		Sets the size of patterns to be large or small.	page 122
Repeated/ single sewing		Specifies whether the pattern will be sewn once or repeatedly.	page 121
Stitching density		Specifies the sewing density of the stitching.	page 123
Initial needle position		Select the straight stitch that is automatically selected when the machine is turned on.	-
Stitch width control		Allows the stitch width to be adjusted with the sewing speed controller.	page 105
Language	ENGLISH	Allows the language used in the screens to be changed.	page 21
Buzzer		Specifies whether or not a beep is sounded with each operation.	page 149
LCD brightness		Adjusts the brightness of the LCD.	page 21
Vertical pattern adjustment		Adjusts the up and down position of the pattern.	page 127







Memo

- The icon shown highlighted above is the default setting.
- The default display language is English.

Adjusting the brightness of the LCD

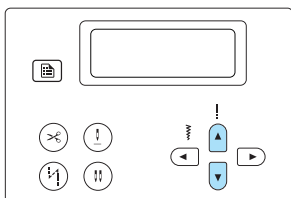

The brightness of the LCD can be adjusted.

- 1 Press  (Settings key) in the operation panel, and then press  or  (Stitch length keys) until  is displayed.

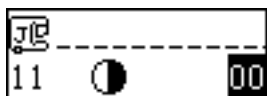

- ▶ The screen for changing the brightness of the LCD appears.



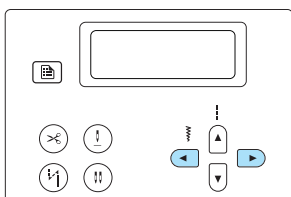

- 2 To make the LCD brighter, press  (Stitch width key). To make the LCD darker, press  (Stitch width key).

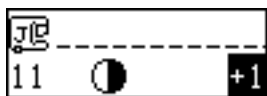

- ▶ The brightness of the LCD is changed.





- 3 Press  (OK key) or  (Cancel/clear key).

- ▶ The initial stitch screen appears again.

Changing the screen language

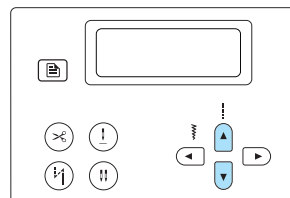

The language used in the screens that are displayed can be changed to one of the many available.

- 1 Press  (Settings key) in the operation panel, and then press  or  (Stitch length keys) until the language is displayed.

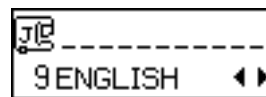

- ▶ The screen for changing the language of the screens appears.



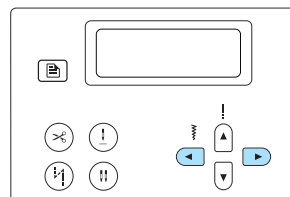

- 2 Press  or  (Stitch width keys) until the desired language is selected.

The language can be changed to one of the available: English, French, German, Dutch, Spanish, Italian, Danish, Norwegian, Finnish, Swedish, Portuguese, Russian, Japanese, Korean or others.

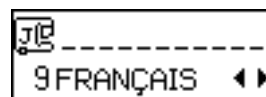

- ▶ The language of the screens is changed.



- 3 Press  (OK key) or  (Cancel/clear key).

- ▶ The initial stitch screen appears again.

Winding/Installing the Bobbin

This section describes how to wind the thread onto the bobbin, and then insert the bobbin thread.

Bobbin precautions

Be sure to observe the following precautions concerning the bobbin.

! CAUTION

- Only use the bobbin (part code: SA156, SFB(XA5539-151)) designed specifically for this sewing machine. Use of any other bobbin may result in injuries or damage to the machine.
- The included bobbin was designed specifically for this sewing machine. If bobbins from other models are used, the machine will not operate correctly. Use only the included bobbin or bobbins of the same type (part code: SA156, SFB(XA5539-151)).

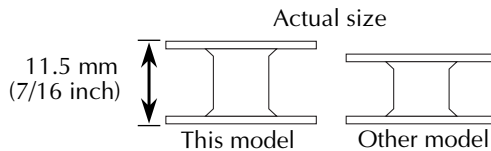

Winding the bobbin

Wind the thread around the bobbin to prepare the bobbin thread.

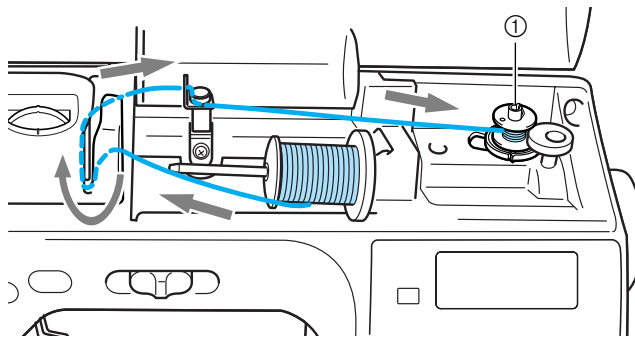

① Bobbin winder



Memo

- The order that the machine should be threaded for winding the bobbin is indicated by a broken line on the sewing machine. Be sure to thread the machine as indicated.

- 1 Turn on the sewing machine.

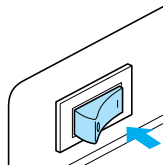

- 2 Open the top cover.

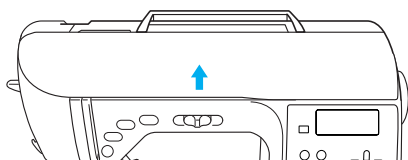

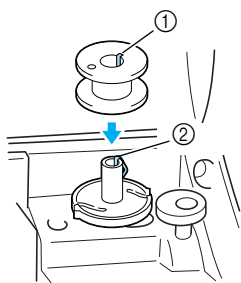

- 3 Place the bobbin on the bobbin winder shaft so that the spring on the shaft fits into the notch in the bobbin. Press down on the bobbin until it snaps into place.

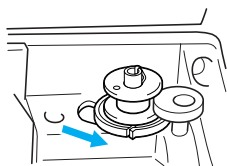

- ① Notch
② Bobbin winder shaft spring

- 4 Slide the bobbin winder in the direction of the arrow until it snaps into place.



-  ("Start/Stop" button) lights up in orange.

- 5 Remove the spool cap that is inserted onto the spool pin.

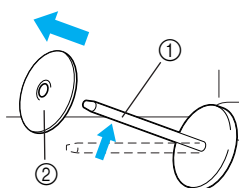

- ① Spool pin
② Spool cap

- 6 Place the spool of thread for the bobbin onto the spool pin.

Slide the spool onto the pin so that the spool is horizontal and the thread unwinds to the front at the bottom.

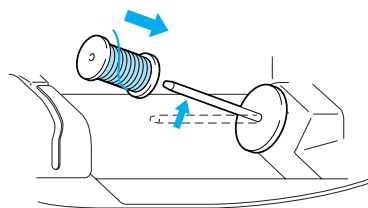

- If the spool is not positioned so that the thread unwinds correctly, the thread may become tangled around the spool pin.

- 7 Slide the spool cap onto the spool pin.

Slide the spool cap as far as possible to the right, as shown, with the rounded side on the left.

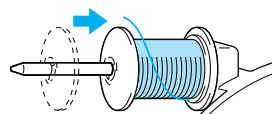

! CAUTION

- If the spool or the spool cap is not positioned correctly, the thread may become tangled around the spool pin and the needle may break.
- Three spool cap sizes are available (large, medium and small), allowing you to choose a spool cap that best fits the size of spool being used. If the spool cap is too small for the spool being used, the thread may catch on the slit in the spool and the needle may break.

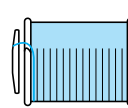
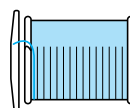

**Memo**

- When sewing with fine, cross-wound thread, use the small spool cap, and leave a small space between the cap and the spool.

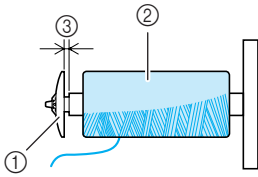

- ① Spool cap (small)
- ② Spool (cross-wound thread)
- ③ Space

- When using thread that winds off quickly, such as transparent nylon thread or metallic thread, place the spool net over the spool before placing the spool of thread onto the spool pin.

If the spool net is too long, fold it to fit the size of the spool.

When the spool net is used, the tension of the upper thread will slightly increase. Be sure to check the thread tension. For details, refer to "Adjusting the Thread Tension" (page 57).

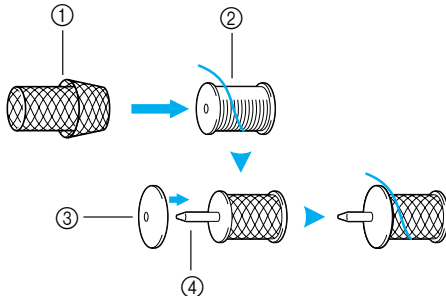

- ① Spool net
- ② Spool
- ③ Spool cap
- ④ Spool pin

- 8 While holding the thread near the spool with your right hand, as shown, pull the thread with your left hand, and then pass the thread behind the thread guide cover and to the front.

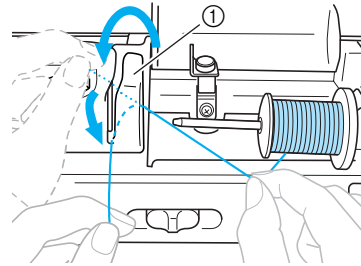

- ① Thread guide cover

- 9 Pass the thread under the thread guide plate, and then pull it to the right.

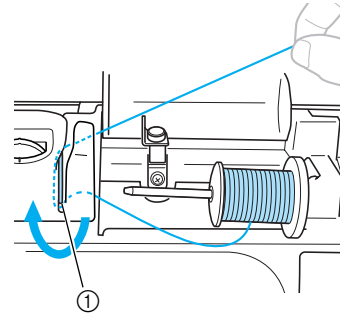

- ① Thread guide plate

- 10 Pass the thread under the hook on the thread guide, and then wind it counterclockwise under the pretension disk.

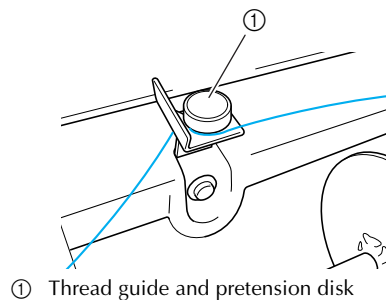
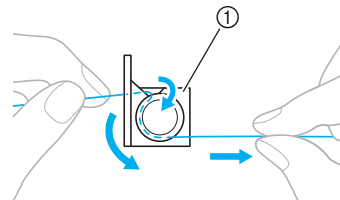

- ① Thread guide and pretension disk

Note

- Make sure that the thread passes under the pretension disk.

- 11 While holding the thread with your left hand, wind the thread that was pulled out clockwise around the bobbin five or six times with your right hand.

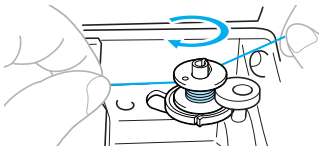

Note

- Make sure that the thread between the spool and the bobbin is pulled tight.
- Be sure to wind the thread clockwise around the bobbin, otherwise the thread will become wrapped around the bobbin winder shaft.

- 12 Pass the end of the thread through the guide slit in the bobbin winder seat, and then pull the thread to the right to cut it.

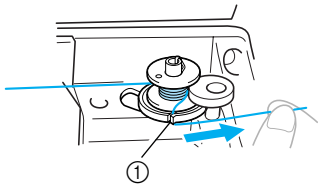

- ① Guide slit in bobbin winder seat (with built-in cutter)

▶ The thread is cut to a suitable length.



CAUTION

- Be sure to cut the thread as described. If the bobbin is wound without cutting the thread using the cutter built into the slit in the bobbin winder seat, the thread may become tangled in the bobbin and the needle may bend or break when the bobbin thread starts to run out.

- 13 Slide the sewing speed controller to the right to increase the bobbin winding speed and slide to left to decrease.

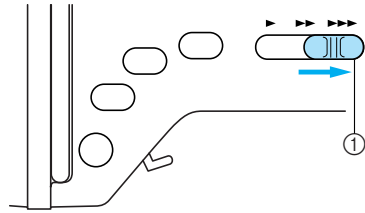

- ① Sewing speed controller

- 14 Press (“Start/Stop” button) once.

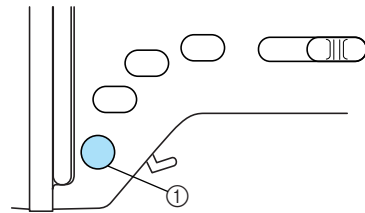

- ① “Start/Stop” button

- When the bobbin winding becomes slow, press (“Start/Stop” button) once to stop the machine.



CAUTION

- When the bobbin winding becomes slow, stop the machine, otherwise the sewing machine may be damaged.

- 15 Use scissors to cut the end of the thread wound around the bobbin.

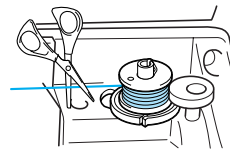

- 16 Slide the bobbin winder shaft to the left.

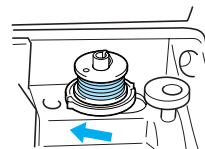

17 Remove the bobbin from the shaft.

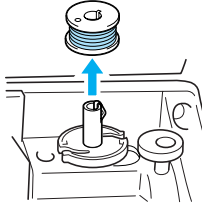

Memo

- When the sewing machine is started or the handwheel is turned after winding the bobbin, the machine will make a clicking sound; this is not a malfunction.

Installing the bobbin

Install the bobbin wound with thread.



CAUTION

- Use a bobbin that has been correctly wound with thread, otherwise the needle may break or the thread tension will be incorrect.

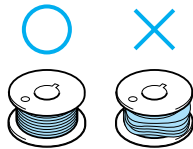

- The bobbin was designed specifically for this sewing machine. If bobbins from other models are used, the machine will not operate correctly. Use only the included bobbin or bobbins of the same type (part code: SA156, SFB(XA5539-151)).

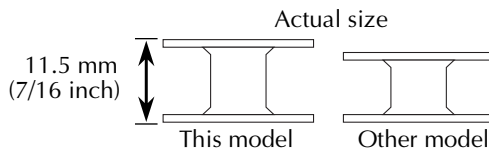

Memo

- The order that the bobbin thread should be passed through the bobbin case is indicated by marks around the bobbin case. Be sure to thread the machine as indicated.

1 Slide the bobbin cover latch to the right.

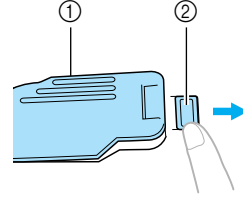

- ① Bobbin cover
- ② Latch

▶ The bobbin cover opens.

2 Remove the bobbin cover.

3 Hold the bobbin with your right hand and hold the end of the thread with your left.

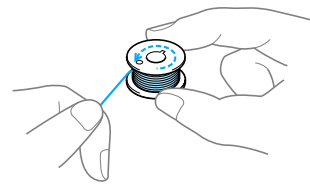

- Be careful not to drop the bobbin.

4 Insert the bobbin into the bobbin case so that the thread unrolls to the left.

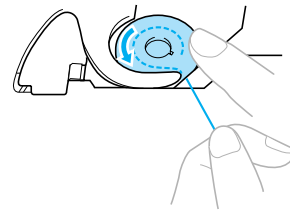

- Be sure to insert the bobbin correctly.



CAUTION

- Be sure to install the bobbin so that the thread unwinds in the correct direction, otherwise the thread may break or the thread tension will be incorrect.



Memo

- The order that the bobbin thread should be passed through the bobbin case is indicated by marks around the bobbin case. Be sure to thread the machine as indicated. The marks around the bobbin case differ depending on the model.

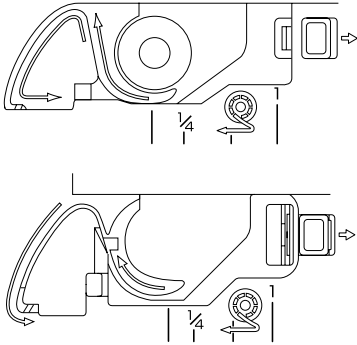

- 5** Lightly hold down the bobbin with your right hand, and then guide the thread as shown with your left hand.

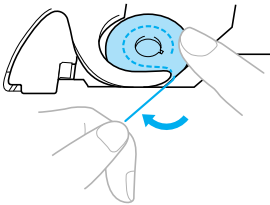

CAUTION

- When installing the bobbin, be sure to hold it down with your finger. If the bobbin is not correctly installed, the thread tension will be incorrect.

- 6** Pass the thread through the slot as shown, and then pull the thread out toward the front.

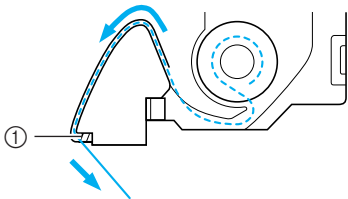

① Cutter

- ▶ The cutter cuts the thread.



Note

- Make sure that the thread is correctly inserted through the tension-adjusting spring of the bobbin case. If it is not inserted correctly, reinsert the thread.

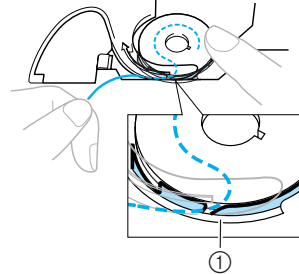

① Tension-adjusting spring

- 7** Reattach the bobbin cover.

Insert the tab in the lower-left corner of the bobbin cover, and then lightly press down on the right side.

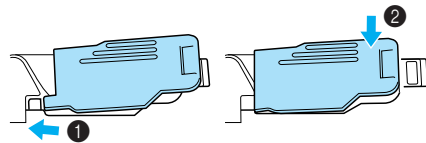

- ▶ The lower threading is finished.

Next, thread the upper thread. Continue with the procedure in “Upper Threading” (page 28).



Memo

- You can begin sewing without pulling up the bobbin thread. If you wish to pull up the bobbin thread before starting to sew, pull up the thread according to the procedure in “Pulling up the bobbin thread” (page 36).

Upper Threading

In this section, the procedures for positioning the spool for the upper thread and threading the needle are described.

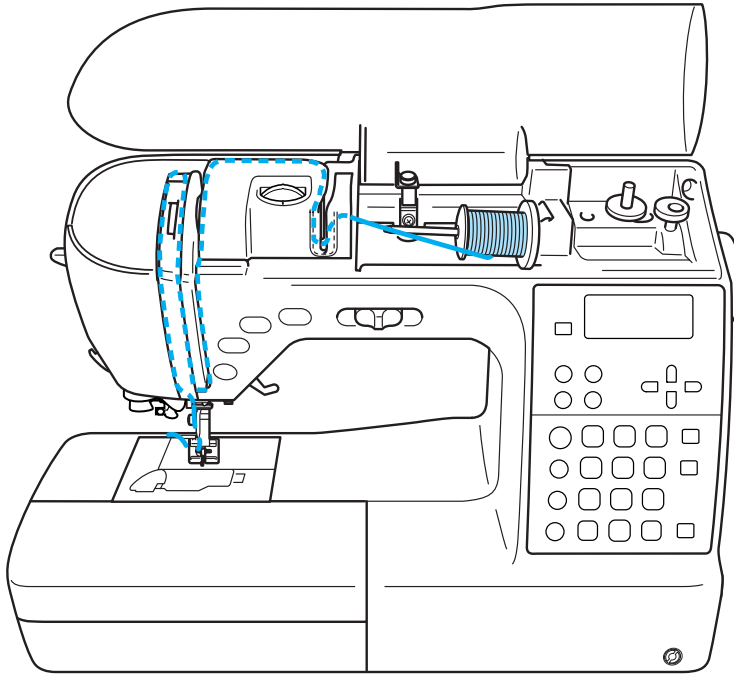

CAUTION

- When threading the upper thread, carefully follow the instructions. If the upper threading is not correct, the thread may become tangled and the needle may bend or break.



Memo

- The order that the machine should be threaded is indicated by a solid line on the sewing machine. Be sure to thread the machine as indicated.

Threading the upper thread

Set the spool of thread on the spool pin, and then thread the machine.

- 1 Turn on the sewing machine.

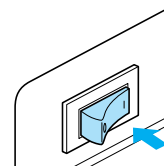

- 2 Raise the presser foot lever to raise the presser foot.

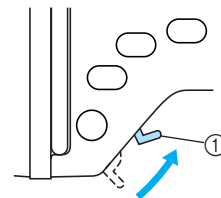

① Presser foot lever

Note

- If the presser foot is not raised, the sewing machine cannot be threaded.

- 3 Press  ("Needle Position" button) once or twice to raise the needle.

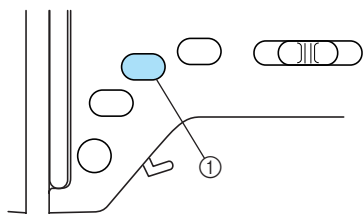

① "Needle Position" button

- ▶ The needle is correctly raised when the mark on the handwheel is at the top, as shown below. Check the handwheel and, if this mark is not at this position, press  ("Needle Position" button) until it is.

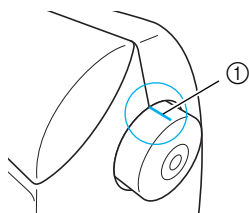

① Mark on handwheel

- 4 Open the top cover.

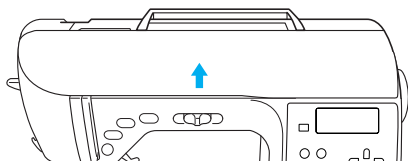

- 5 Remove the spool cap that is inserted onto the spool pin.

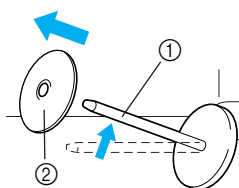

① Spool pin
② Spool cap

- 6 Place the spool of thread onto the spool pin. Slide the spool onto the pin so that the spool is horizontal and the thread unwinds to the front at the bottom.

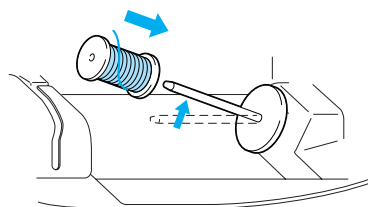

! CAUTION

- If the spool or the spool cap is not positioned correctly, the thread may become tangled around the spool pin and the needle may break.

- 7 Slide the spool cap onto the spool pin. Slide the spool cap as far as possible to the right, as shown, with the rounded side on the left.

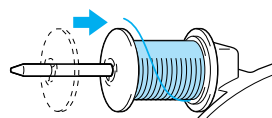

! CAUTION

- If the spool or the spool cap is not positioned correctly, the thread may become tangled around the spool pin and the needle may break.
- Three spool cap sizes are available (large, medium and small), allowing you to choose a spool cap that best fits the size of spool being used. If the spool cap is too small for the spool being used, the thread may catch on the slit in the spool and the needle may break.

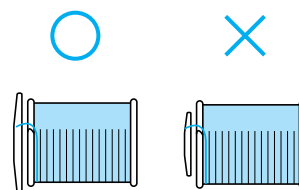

- 8** While holding the thread lightly with your right hand, pull the thread with your left hand, and then pass the thread behind the thread guide cover and to the front.

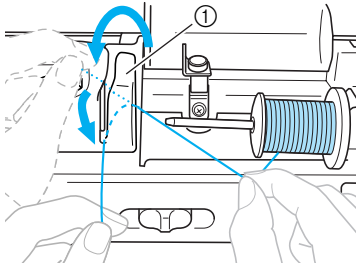

① Thread guide cover

- 9** Pass the thread under the thread guide plate, and then pull it up.

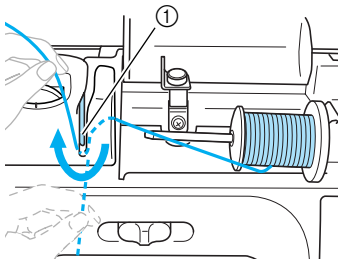

① Thread guide plate

- 10** While using your right hand to lightly hold the thread passed under the thread guide plate, pass the thread through the thread path in the order shown below.

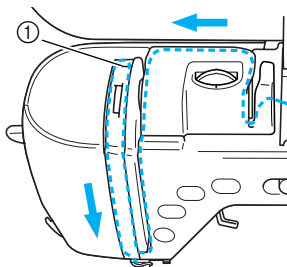

① Shutter

Note

- If the presser foot has been lowered and the shutter is closed, the machine cannot be threaded. Be sure to raise the presser foot and open the shutter before threading the machine. In addition, before removing the upper thread, be sure to raise the presser foot and open the shutter.
- This machine is equipped with a window that allows you to check the position of the take-up lever. Look through this window and check that the thread is correctly fed through the take-up lever.

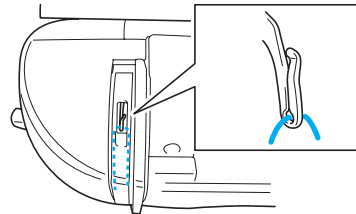

- 11** Pass the thread behind the needle bar thread guide.

The thread can easily be passed behind the needle bar thread guide by holding the thread in your left hand, then feeding the thread with your right hand, as shown.

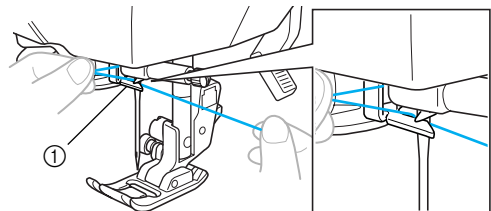

① Needle bar thread guide

Next, use the needle threader to thread the needle. Continue with the procedure in "Threading the needle" (page 31).

Threading the needle

This section describes how to thread the needle.



Memo

- The needle threader can be used with sewing machine needles 75/11 through 100/16.
- Thread with a thickness of 130/20 or thicker cannot be used with the needle threader.
- The needle threader cannot be used with the wing needle or the twin needle.
- If the needle threader cannot be used, refer to “Threading the needle manually (without using the needle threader)” (page 33).

1

Pull the end of the thread passed through the needle bar thread guide to the left, and then pass the thread through the thread guide disk from the front.

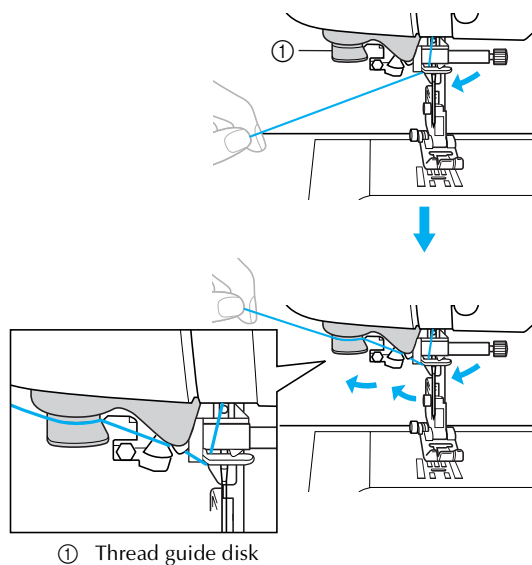

2

Cut the thread with the thread cutter on the left side of the machine.

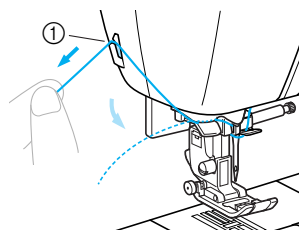

① Thread cutter



Note

- If the thread is pulled through and cannot be cut correctly, lower the presser foot so that the thread is held in place before cutting the thread. If this operation is performed, skip step 3.
- When using thread that quickly winds off the spool, such as metallic thread, it may be difficult to thread the needle if the thread is cut.

Therefore, instead of using the thread cutter, pull out about 80 mm (approx. 3 inches) of thread after passing it through the thread guide disks (marked “7”).

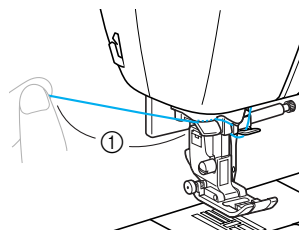

① 80 mm (3 inches) or more

3

Lower the presser foot lever to lower the presser foot.

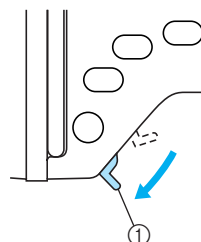

① Presser foot lever

- 4** Lower the needle threader lever on the left side of the machine until it clicks, and then slowly return the lever to its original position.

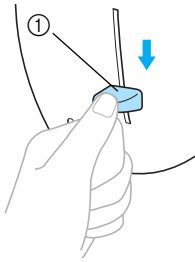

① Needle threader lever

- ▶ The thread is passed through the eye of the needle.



Note

- If the needle was not completely threaded, but a loop in the thread was formed in the eye of the needle, carefully pull the loop through the eye of the needle to pull out the end of the thread.

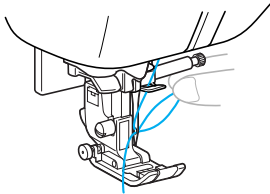

CAUTION

- When pulling out the thread, do not pull it with extreme force, otherwise the needle may break or bend.

- 5** Raise the presser foot lever, pass the end of the thread through the presser foot, and then pull out about 5 cm (2 inches) of thread toward the rear of the machine.

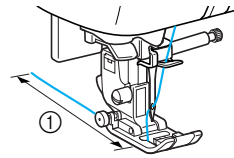

① 5 cm (2 inches)

- ▶ The upper threading is finished. Now that the upper threading and the lower threading are finished, you are ready to begin sewing.



Note

- If the needle is not raised, the needle threader cannot thread the needle. Be sure to press  ("Needle Position" button) to raise the needle before using the needle threader.

Threading the needle manually (without using the needle threader)

When using special thread, thread with a thickness of 130/20 or thicker, the wing needle or the twin needle which cannot be used with the needle threader, thread the needle as described below.

1 Thread the machine to the needle bar thread guide.

- For details, refer to "Upper Threading" (page 28).

2 Lower the presser foot lever.

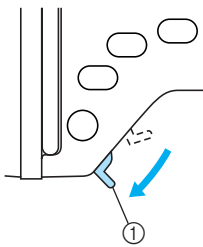

① Presser foot lever

3 Pass the thread through the eye of the needle from front to back.

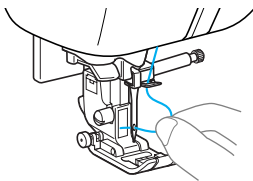

4 Raise the presser foot lever, pass the end of the thread through the eye of the needle from front to back.

Using the twin needle

With the twin needle, you can sew two parallel lines of the same stitch with two different threads. Both upper threads should have the same thickness and quality. Be sure to use the twin needle, the extra spool pin and the spool cap.

For details on the stitches that can be sewn with the twin needle, refer to "Stitch Settings" (page 134).

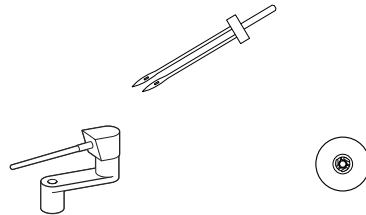

! CAUTION

- Only use the twin needle (part code: X59296-151). Use of any other needle may bend the needle or damage the machine.
- Never use bent needles. Bent needles can easily break, possibly resulting in injuries.

1 Install the twin needle.

- For details on installing a needle, refer to "Replacing the needle" (page 39).

2 Thread the upper thread for the left needle eye.

- For details, refer to steps ① through ⑪ of "Threading the upper thread" (page 28).

3 Manually thread the left needle with the upper thread.

Pass the thread through the eye of the needle from the front.

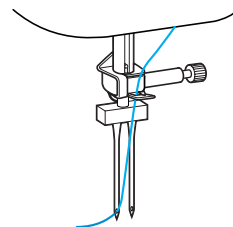

- The needle threader cannot be used with the twin needle. If the needle threader is used with the twin needle, the sewing machine may be damaged.

4 Insert the extra spool pin onto the bobbin winder shaft.

Insert the extra spool pin so that it is perpendicular to the bobbin winder shaft.

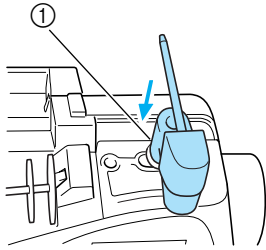

① Bobbin winder shaft

5 Swing down the spool pin so that it is horizontal.

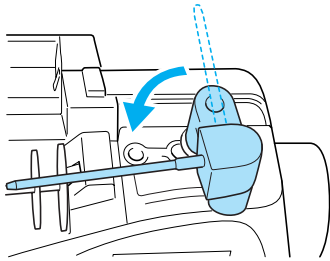

6 Place the upper thread spool for the needle on the right side onto the extra spool pin, and then secure it with the spool cap.

The thread should unroll from the top front of the spool.

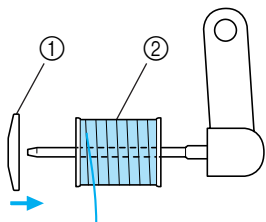

① Spool cap
② Spool

7 Thread the upper thread for the right side in the same way that the upper thread for the left side was threaded.

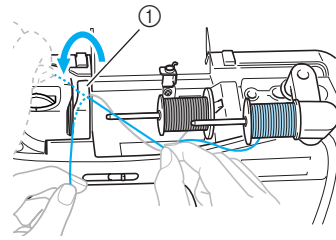

① Thread guide cover

- For details, refer to step 8 through 10 of "Threading the upper thread" (page 28).

8 Without passing the thread through the needle bar thread guide, manually thread the right needle.

Pass the thread through the eye of the needle from the front.

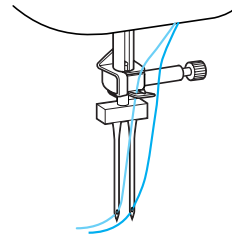

- The needle threader cannot be used with the twin needle. If the needle threader is used with the twin needle, the sewing machine may be damaged.

9 Attach zigzag foot "J".

- For details on changing the presser foot, refer to "Replacing the presser foot" (page 41).

! CAUTION

- When using the twin needle, be sure to attach zigzag foot "J", otherwise the needle may break or the machine may be damaged.

10 Turn on the sewing machine.

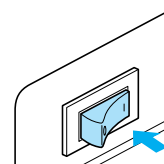

▶ The LCD comes on.

11 Select a stitch.

- For details on selecting a stitch, refer to “Selecting stitching” (page 72).
- For details on the stitches that can be sewn with the twin needle, refer to “Stitch Settings” (page 134).

! CAUTION

- After adjusting the stitch width, slowly turn the handwheel toward you (counterclockwise) and check that the needle does not touch the presser foot. If the needle hits the presser foot, the needle may bend or break.

12 Press (Needle mode selection key).

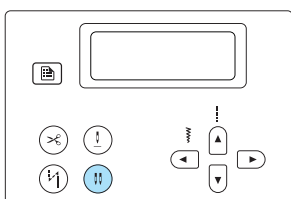

- ▶  (Needle mode selection key) lights up, and the twin needle can now be used.

- To return to single needle sewing, press  (Needle mode selection key) until the key is no longer lit.
- Even after the sewing machine is turned off, the twin needle setting is not cancelled.

! CAUTION

- When using the twin needle, be sure to select the twin needle setting, otherwise the needle may break or the machine may be damaged.

13 Start sewing.

- For details on starting to sew, refer to “Starting to sew” (page 52).
- ▶ Two lines of stitching are sewn parallel to each other.

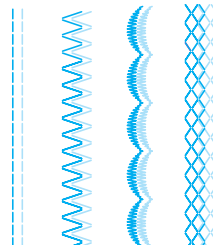

! CAUTION

- When changing the sewing direction, press  (“Needle Position” button) to raise the needle from the fabric, and then raise the presser foot lever and turn the fabric. Otherwise the needle may break or the machine may be damaged.
- Do not try turning the fabric with the twin needle left down in the fabric, otherwise the needle may break or the machine may be damaged.

Pulling up the bobbin thread

When making gathers or before free-motion quilting, first pull up the bobbin thread as described below.

- 1 **Insert the bobbin into the bobbin case.**
 - Refer to steps 1 through 5 of “Installing the bobbin” (page 26).
- 2 **Pass the bobbin thread through the slot.**
Do not cut the thread with the cutter.

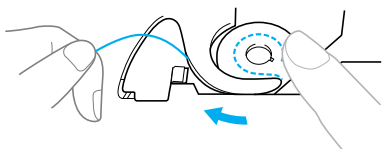

- 3 **While lightly holding the upper thread with your left hand with the needle in the up-position, press \oplus (“Needle Position” button) twice to lower and raise the needle.**

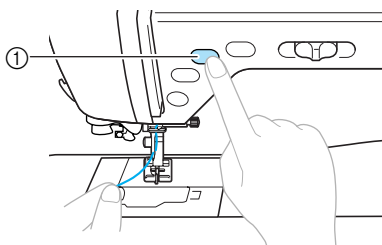

- 1 “Needle Position” button
- ▶ The bobbin thread is looped around the upper thread and can be pulled up.

- 4 **Carefully pull the upper thread upward to pull out the end of the bobbin thread.**

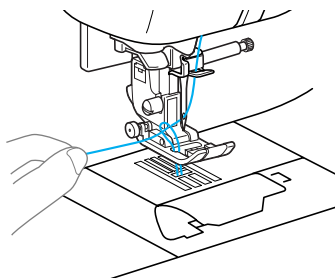

- 5 **Pull out about 10-15 cm (4-5 inches) of the bobbin thread under the presser foot toward the rear of the machine.**

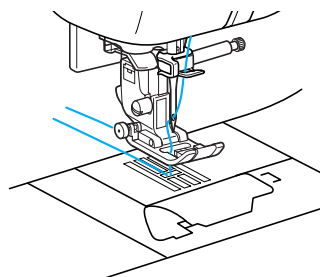

- 6 **Reattach the bobbin cover.**
Insert the tab in the lower-left corner of the bobbin cover, and then lightly press down on the right side.

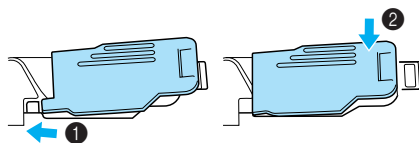

Replacing the Needle

This section provides information on sewing machine needles.

Needle precautions

Be sure to observe the following precautions concerning the handling of the needle. Failure to observe these precautions is extremely dangerous, for example, if the needle breaks and fragments are dispersed. Be sure to read and carefully follow the instructions below.



CAUTION

- **Only use home sewing machine needles. Use of any other needle may bend the needle or damage the machine.**
- **Never use bent needles. Bent needles can easily break, possibly resulting in injuries.**

Needle types and their uses

The sewing machine needle that should be used depends on the fabric and thread thickness. Refer to the following table when choosing the thread and needle appropriate for the fabric that you wish to sew.

Fabric Type/Application		Thread		Size of Needle
		Type	Weight	
Medium weight fabrics	Broadcloth	Cotton thread	60–80	75/11–90/14
	Taffeta	Synthetic thread		
	Flannel, Gabardine	Silk thread	50	
Thin fabrics	Lawn	Cotton thread	60–80	65/9–75/11
	Georgette	Synthetic thread		
	Challis, Satin	Silk thread	50	
Thick fabrics	Denim	Cotton thread	30–50	90/14–100/16
	Corduroy	Synthetic thread	50	
	Tweed	Silk thread		
Stretch fabrics	Jersey	Thread for knits	50–60	Ball point needle (golden colored) 75/11–90/14
	Tricot			
Easily frayed fabrics		Cotton thread	50–80	65/9–90/14
		Synthetic thread		
		Silk thread	50	
For top-stitching		Synthetic thread	30	90/14–100/16
		Silk thread		



Memo

- The smaller the thread number, the thicker the thread, and the larger the needle number, the thicker the needle.
- Use the ball point needle when sewing on stretch fabrics or fabrics where skipped stitches easily occur.
- Use a 90/14 to 100/16 needle with transparent nylon threads, regardless of the fabric being sewn.
- A 75/11 needle is already installed when the sewing machine is purchased.



CAUTION

- **The appropriate fabric, thread and needle combinations are shown in the table above. If the combination of the fabric, thread and needle is not correct, particularly when sewing thick fabrics (such as denim) with thin needles (such as 65/9 to 75/11), the needle may bend or break. In addition, the stitching may be uneven or puckered or there may be skipped stitches.**

Checking the needle

Sewing with a bent needle is extremely dangerous since the needle may break while the machine is being operated.

Before using the needle, place the flat side of the needle on a flat surface and check that the distance between the needle and the flat surface is even.

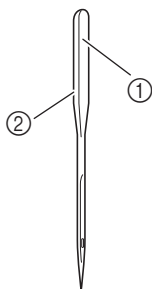

- ① Flat side
- ② Needle type marking

■ Correct needle

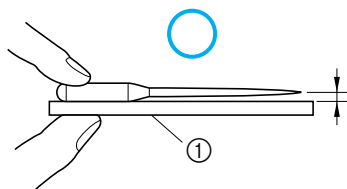

- ① Flat surface

■ Incorrect needle

If the distance between the needle and the flat surface is not even, the needle is bent. Do not use a bent needle.

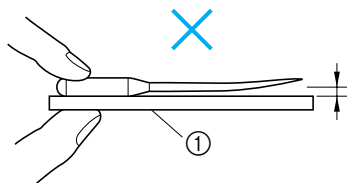

- ① Flat surface

Replacing the needle

Replace the needle as described below. Use the screwdriver and a needle that has been determined to be straight according to the instructions in "Checking the needle".

- 1 Press ("Needle Position" button) once or twice to raise the needle.

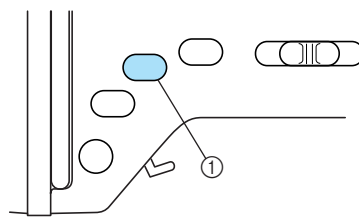

- ① "Needle Position" button

- 2 Turn off the sewing machine.

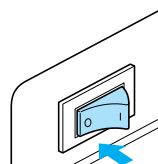

! CAUTION

- Before replacing the needle, be sure to turn off the sewing machine, otherwise injuries may occur if ("Start/Stop" button) is accidentally pressed and the machine starts sewing.

- 3 Place fabric or paper under the presser foot to cover the hole in the needle plate.

⚡ Note

- Before replacing the needle, cover the hole in the needle plate with fabric or paper to prevent the needle from falling into the machine.

- 4** Lower the presser foot lever.

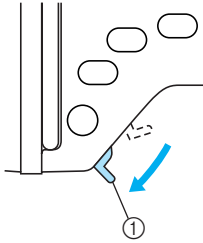

① Presser foot lever

- 5** Hold the needle with your left hand, and then use a screwdriver to turn the needle clamp screw toward you (counterclockwise) to remove the needle.

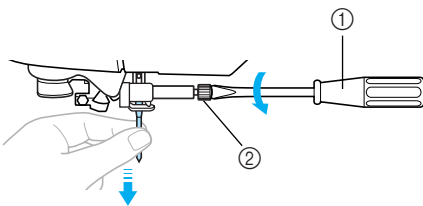

① Screwdriver
② Needle clamp screw

- Do not apply a strong force when loosening or tightening the needle clamp screw, otherwise certain parts of the sewing machine may be damaged.

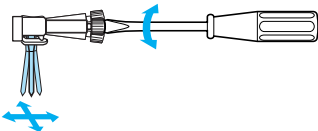

- 6** With the flat side of the needle toward the rear of the machine, insert the needle until it touches the needle stopper.

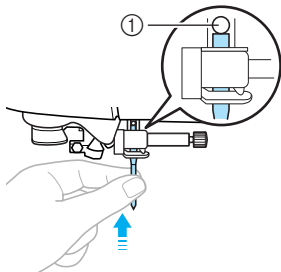

① Needle stopper

- 7** While holding the needle with your left hand, use the screwdriver to tighten the needle clamp screw.

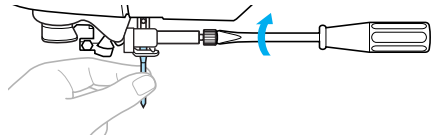

Install the twin needle in the same way.

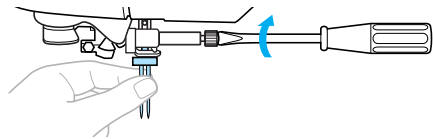

! CAUTION

- Be sure to insert the needle until it touches the needle stopper and securely tighten the needle clamp screw with the screwdriver, otherwise the needle may break or damage may result.

Replacing the Presser Foot

The presser foot presses down on the fabric.

Presser foot precautions

Be sure to observe the following precautions concerning the presser feet.

CAUTION

- Use the presser foot appropriate for the type of stitch that you wish to sew, otherwise the needle may hit the presser foot, causing the needle to bend or break.
- Only use presser feet designed specifically for this sewing machine. Use of any other presser foot may result in injuries or damage to the machine.

Replacing the presser foot

Replace the presser foot as described below. For details on using the side cutter "S", refer to "Sewing overcasting stitches using the optional side cutter" (page 78).

- 1 Press  ("Needle Position" button) once or twice to raise the needle.

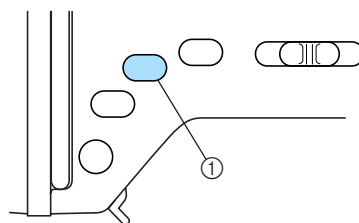

- ① "Needle Position" button
▶ The needle is raised.

- 2 Turn off the sewing machine.

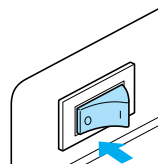

CAUTION

- Before replacing the presser foot, be sure to turn off the sewing machine, otherwise injuries may occur if  ("Start/Stop" button) is accidentally pressed and the machine starts sewing.

- 3 Raise the presser foot lever.

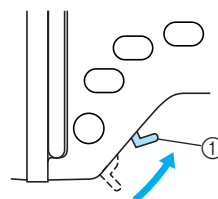

- ① Presser foot lever
▶ The presser foot is raised.

- 4** Press the black button at the back of the presser foot holder.

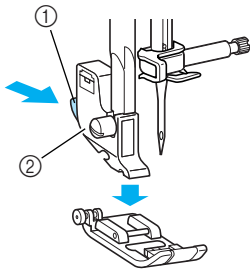

- ① Black button
② Presser foot holder

▶ The presser foot holder releases the presser foot.

- 5** Place a different presser foot below the holder so that the presser foot pin is aligned with the notch in the holder.

Position the presser foot so the letter indicating the presser foot type (A, G, I, J, M, N or R) is positioned to be read.

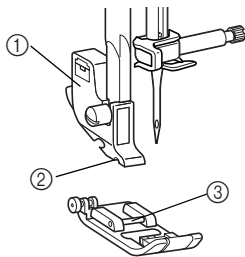

- ① Presser foot holder
② Notch
③ Pin

- 6** Slowly lower the presser foot lever so that the presser foot pin snaps into the notch in the presser foot holder.

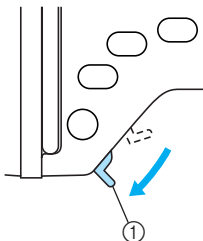

- ① Presser foot lever

▶ The presser foot is attached.

- 7** Raise the presser foot lever to check that the presser foot is securely attached.

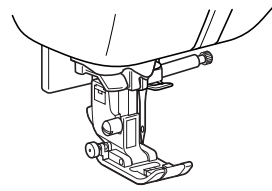

Note

- When a stitch is selected, the icon for the presser foot that should be used appears in the screen. Check that the correct presser foot is attached before starting to sew. If the wrong presser foot is installed, turn off the sewing machine, attach the correct presser foot, and then select the desired stitch again.



Buttonhole foot "A"



Overcasting foot "G"



Zigzag foot "J"



Button fitting foot "M"



Monogramming foot "N"



Blind stitch foot "R"



Side cutter "S"

- For details on the presser foot that should be used with the selected stitch, refer to "Stitch Settings" (page 134).

Adjusting the pressure of the presser foot

The presser foot pressure (the amount of pressure applied to the fabric by the presser foot) can be adjusted. For best results, increase the pressure when sewing thin fabrics, and decrease the pressure when sewing thick fabrics.

1 Lower the presser foot lever.

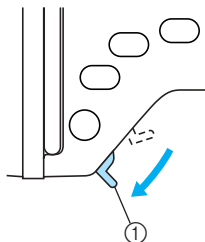

① Presser foot lever

2 Turn the presser foot pressure dial at the back of the machine to adjust the pressure of the presser foot.

The presser foot pressure can be set to one of four levels (between 1 and 4). The larger the setting, the stronger the pressure. Use setting 1 or 2 for thick fabrics, use setting 3 or 4 for thinner fabrics.

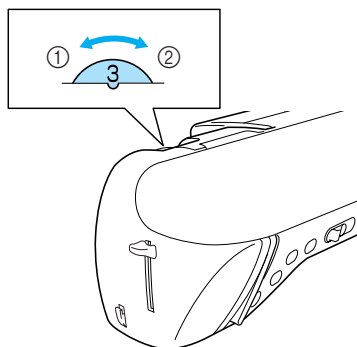

- ① Strong
- ② Weak

3 When you are finished sewing, reset the dial to 3 (standard).

Removing the presser foot holder

Remove the presser foot holder when cleaning the sewing machine or when installing a presser foot that does not use the presser foot holder, such as the quilting foot. Use the screwdriver to remove the presser foot holder.

■ Removing the presser foot holder

1 Remove the presser foot.

- For details, refer to “Replacing the presser foot” (page 41).

2 Use the screwdriver to loosen the presser foot holder screw.

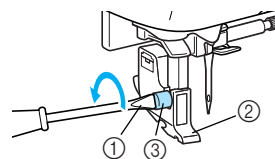

- ① Screwdriver
- ② Presser foot holder
- ③ Presser foot holder screw

■ Attaching the presser foot holder

1 Align the presser foot holder with the lower-left side of the presser bar.

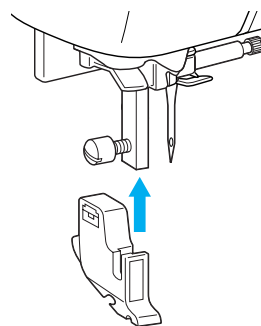

2 Hold the presser foot holder in place with your right hand, and then tighten the screw using the screwdriver in your left hand.

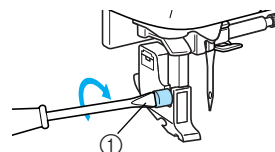

- ① Screwdriver

Note

- If the presser foot holder is not correctly installed, the thread tension will be incorrect.

Using the walking foot

With the walking foot, both pieces of fabric are fed evenly by the feed dogs and the teeth on the presser foot. This is useful when sewing fabrics that are hard to feed such as vinyl and leather and when sewing fabrics that easily slip such as velvets or when quilting.

Use the screwdriver to attach the walking foot.

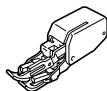

■ Attaching the walking foot

1 Remove the presser foot holder.

- For details, refer to "Removing the presser foot holder" (page 43).

2 Hook the connecting fork of the walking foot onto the needle clamp screw.

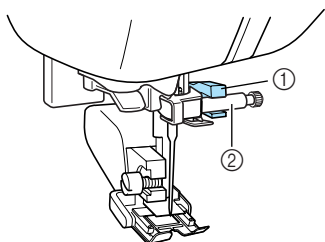

- ① Connecting fork
- ② Needle clamp screw

3 Lower the presser foot lever, insert the presser foot holder screw, and then tighten the screw with the screwdriver.

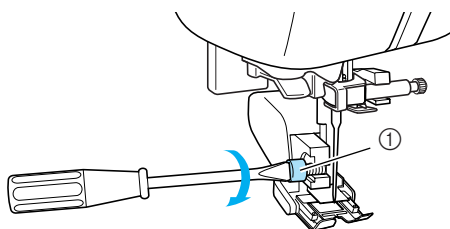

- ① Presser foot holder screw

! CAUTION

- Be sure to securely tighten the screw with the screwdriver, otherwise the needle may touch the presser foot, causing it to bend or break.
- Before starting to sew, slowly turn the handwheel toward you (counterclockwise) and check that the needle does not touch the presser foot. If the needle hits the presser foot, the needle may bend or break.

⚡ Note

- When sewing with the walking foot, sew at a speed between slow and medium.

■ Removing the walking foot

1 Press \oplus ("Needle Position" button) once or twice to raise the needle.

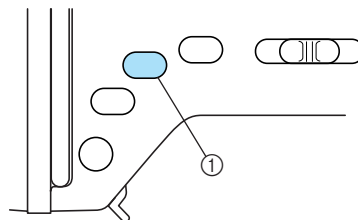

- ① "Needle Position" button

▶ The needle is raised.

2 Turn off the sewing machine.

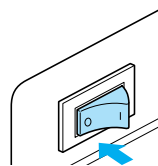

3 Raise the presser foot lever.

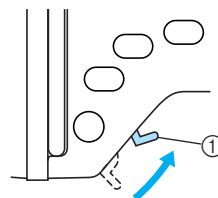

- ① Presser foot lever

▶ The presser foot is raised.

4 With a screwdriver, loosen the presser foot holder screw, and then remove the walking foot.

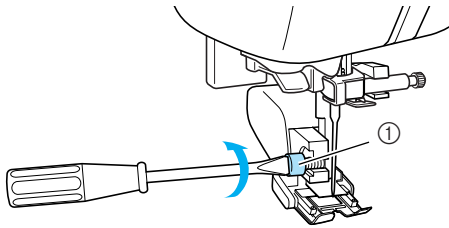

① Presser foot holder screw

5 Attach the presser foot holder.

- For details, refer to “Removing the presser foot holder” (page 43).



Memo

- Only the straight stitch (with reinforcement stitching) and the zigzag stitch can be used with the walking foot. For details on the stitches, refer to “Stitch Settings” (page 134).

Sewing Cylindrical or Large Pieces

When sewing cylindrical or large pieces of fabric, remove the flat bed attachment.

Stitching cylindrical pieces

Removing the flat bed attachment makes it easier to sew cylindrical pieces such as cuffs and pant legs.

- 1 Pull the flat bed attachment off to the left.

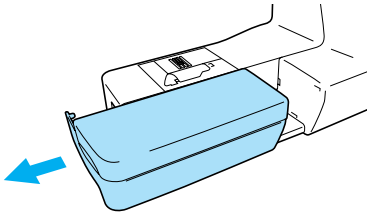

- ▶ With the flat bed attachment removed, free-arm sewing is possible.

- 2 Slide the part that you wish to sew onto the arm, and then sew from the top.

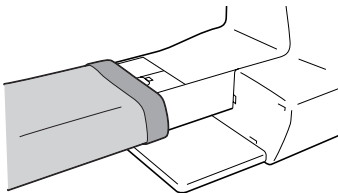

- 3 When you are finished with free-arm sewing, install the flat bed attachment back in its original position.

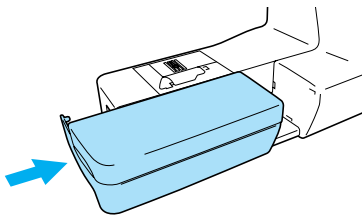

Sewing large pieces of fabric

The optional wide table makes sewing large pieces of fabric easier.

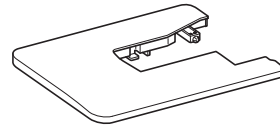

- 1 Open up the legs at the bottom of the wide table. Pull out the four legs until they snap into place.

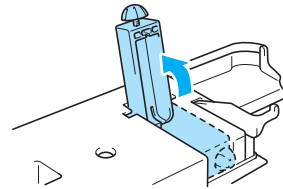

- 2 Pull the flat bed attachment off to the left.

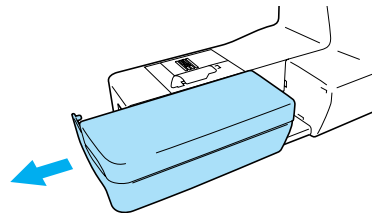

- ▶ With the flat bed attachment removed, free-arm sewing is possible.

- 3 Install the wide table.**
Keeping the wide table level, fully slide it into place. The lower right corner section of the wide table extends over the front section of the sewing machine bed.

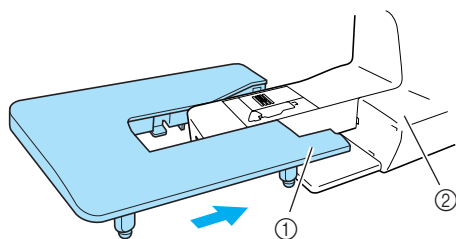

- ① Lower right corner
② Sewing machine bed



Note

- The optional wide table is available through your brother dealer.

- 4 Turn the screw at the bottom of each leg to adjust their height so the wide table will be level with the sewing machine bed.**

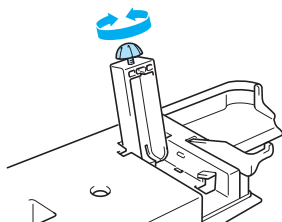

CAUTION

- Do not move the sewing machine while the wide table is attached, otherwise damage or injuries may occur.

- 5 When you are finished using the wide table, remove it.**
While slightly lifting up the wide table, pull it off to the left.

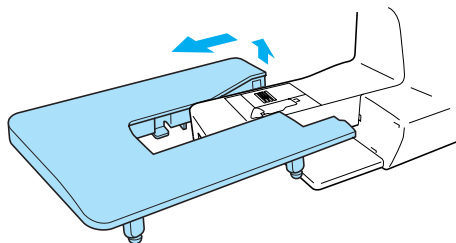

- 6 Install the flat bed attachment back in its original position.**



Memo

- With the legs folded up, the wide table can be stored attached to the hard case.

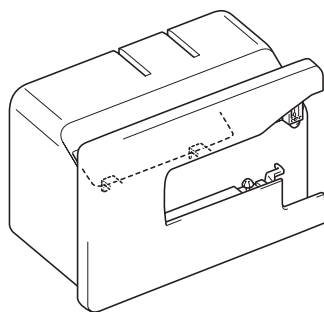

- The knee lifter can be attached to the bottom of the wide table.

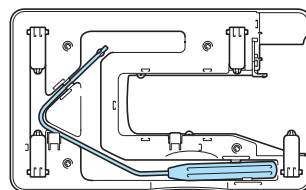



2 SEWING BASICS

The necessary preparations for sewing are described in this chapter.

- Sewing.....50
 - General sewing procedure50
 - Positioning the fabric51
 - Starting to sew52
 - Securing the stitching.....54
 - Cutting the thread55
- Adjusting the Thread Tension.....57
 - Changing the tension of the upper thread57
- Adjusting the Stitch Width and Length.....58
 - Adjusting the stitch width58
 - Adjusting the stitch length.....59
- Useful Functions.....60
 - Changing the needle stop position60
 - Automatically sewing reverse/reinforcement stitches60
 - Automatically cutting the thread.....62
 - Saving stitch settings63
 - Hands-free raising and lowering of the presser foot.....64
- Useful Sewing Tips65
 - Trial sewing.....65
 - Changing the sewing direction65
 - Sewing curves65
 - Sewing thick fabrics66
 - Sewing thin fabrics.....66
 - Sewing stretch fabrics66
 - Sewing leathers or vinyl fabrics.....67
 - Sewing an even seam allowance67

Sewing

Basic sewing operations are described below.

Before operating the sewing machine, read the following precautions.



CAUTION

- While the machine is in operation, pay special attention to the needle location. In addition, keep your hands away from all moving parts such as the needle and handwheel, otherwise injuries may occur.
- Do not pull or push the fabric too hard while sewing, otherwise injuries may occur or the needle may break.
- Never use bent needles. Bent needles can easily break, possibly resulting in injuries.
- Make sure that the needle does not strike basting pins, otherwise the needle may break or bend.

General sewing procedure

Follow the basic procedures below to sew.

1	Turn on the machine.	Turn on the sewing machine. For details on turning on the machine, refer to "Turning on the machine" (page 17).
↓		
2	Select the stitch.	Select the stitch appropriate for the area to be sewn. For details on selecting a stitch, refer to "Selecting stitching" (page 72).
↓		
3	Attach the presser foot.	Attach the presser foot appropriate for the stitch. For details on replacing the presser foot, refer to "Replacing the presser foot" (page 41).
↓		
4	Position the fabric.	Place the area to be sewn under the presser foot. Be sure that the fabric pieces are sewn in the correct order and that the right and wrong sides of the fabric are aligned correctly. For details on positioning the fabric, refer to "Positioning the fabric" (page 51).
↓		
5	Start sewing.	Start sewing. For details on starting to sew, refer to "Starting to sew" (page 52).
↓		
6	Cut the thread.	Cut the thread at the end of sewing. The thread may also be cut automatically. For details on cutting the thread, refer to "Cutting the thread" (page 55).

Positioning the fabric

Be sure that the fabric pieces are sewn in the correct order and that the right and wrong sides of the fabric are aligned correctly.

1 Turn on the sewing machine.

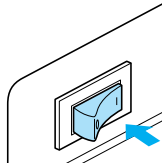

The straight stitch (left needle position) is automatically selected.

2 Press (“Needle Position” button) once or twice to raise the needle.

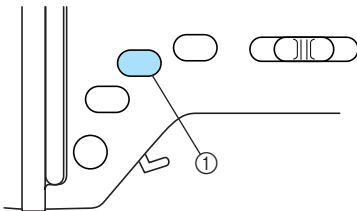

① “Needle Position” button

3 Place the fabric under the presser foot.

- If the seam allowance is positioned on the right side, sewing in a straight line is easier and the extra fabric does not get in the way.

4 While holding the end of the thread and the fabric with your left hand, turn the handwheel toward you (counterclockwise) with your right hand to lower the needle to the starting point of the stitching.

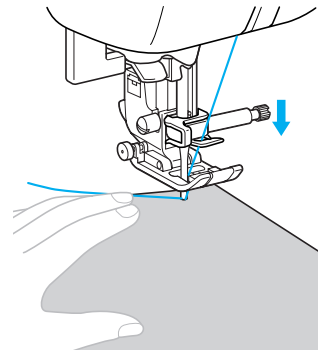
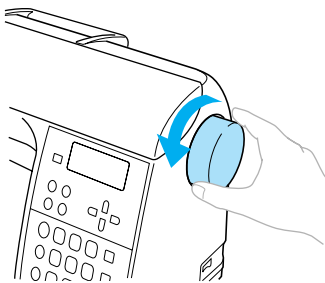

5 Lower the presser foot lever.

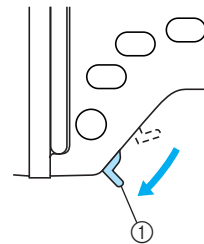

① Presser foot lever

► The fabric is now positioned to be sewn.

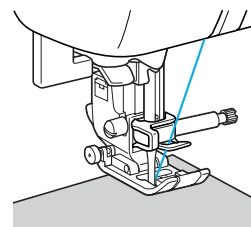

Memo

- To adjust the pressure that the presser foot applies to the fabric, refer to “Adjusting the pressure of the presser foot” (page 43).

Starting to sew

Once you are ready to start sewing, you can start the sewing machine. The sewing speed can be adjusted using either the sewing speed controller or the foot controller.



Note

Important:

- When the foot controller is plugged in,  (“Start/Stop” button) cannot be used to start or stop sewing.

■ Using the operation buttons

Sewing can be started and stopped using the operation button  (“Start/Stop” button).

① Slide the sewing speed controller to the left or right to select the desired sewing speed.

Slide the sewing speed controller to the left to sew at a slower speed, or slide the speed controller to the right to sew at a faster speed.

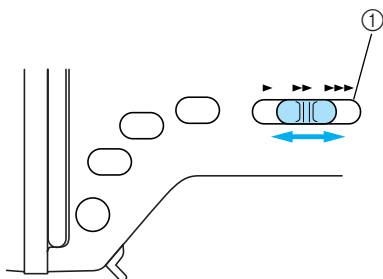

① Sewing speed controller

② Press (“Start/Stop” button) once.

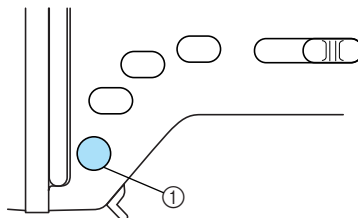

① “Start/Stop” button

- ▶ The machine starts sewing.

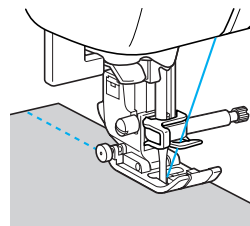

- If you continue to hold  (“Start/Stop” button) pressed immediately after the sewing starts, the machine will sew at a slow speed.

③ When the end of the stitching is reached, press (“Start/Stop” button) once.

- ▶ The machine stops sewing with the needle down (in the fabric).

④ When you are finished sewing, raise the needle, and then cut the threads.

- ▶ For details, refer to “Cutting the thread” (page 55).

■ Using the foot controller

Sewing can be started and stopped using the foot controller.

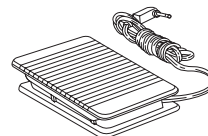

① Turn off the sewing machine.

When connecting the foot controller, be sure to turn off the sewing machine in order to prevent the machine from accidentally being started.

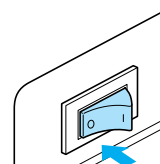

- ② Insert the foot controller plug into its jack on the side of the sewing machine.

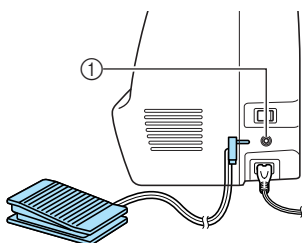

① Foot controller jack



Note

(For U.S.A. only)

- Foot controller: Model N5V
This foot controller can be used on this machine model NX-450.

- ③ Turn on the sewing machine.

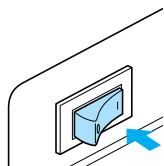

- ④ Slide the sewing speed controller to the left or right to select the desired sewing speed.

Slide the sewing speed controller to the left to sew at a slower speed, or slide the speed controller to the right to sew at a faster speed.

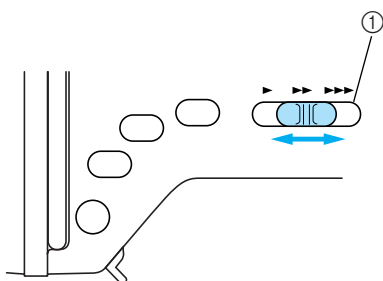

① Sewing speed controller

- The speed set using the sewing speed controller will be the foot controller's maximum sewing speed.

- ⑤ Once you are ready to start sewing, slowly press down on the foot controller.

Pressing down on the foot controller increases the sewing speed; releasing the pressure on the foot controller decreases the sewing speed.

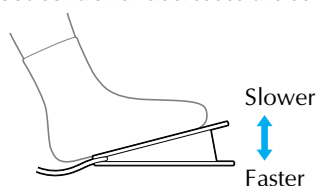

- Slowly press down on the foot controller. Pressing it down hard starts sewing too quickly.

▶ The machine starts sewing.

- ⑥ When the end of the stitching is reached, completely release the foot controller.

▶ The machine stops sewing with the needle lowered (in the fabric).

- ⑦ When you are finished sewing, raise the needle, and then cut the threads.

- For details, refer to "Cutting the thread" (page 55).



Memo

- When the foot controller is plugged in, (ⓘ) ("Start/Stop" button) cannot be used to start or stop sewing.
- When sewing is stopped, the needle remains lowered (in the fabric). The machine can be set so that the needle will stay up when sewing is stopped. For details on setting the machine so that the needle stays up when sewing is stopped, refer to "Changing the needle stop position" (page 60).

CAUTION

- Do not allow thread or dust to accumulate in the foot controller, otherwise a fire or an electric shock may occur.
- Do not place objects on the foot controller, otherwise damage to the machine or injuries may occur.
- If the machine is not to be used for a long period of time, unplug the foot controller, otherwise a fire or an electric shock may occur.

Securing the stitching

When sewing with the straight stitch, for example, at the end of an opening or where seams do not overlap, use reverse stitching or reinforcement stitching to secure the end of the thread.

- 1 Lower the needle into the fabric at the beginning of the stitching, and then lower the presser foot lever.

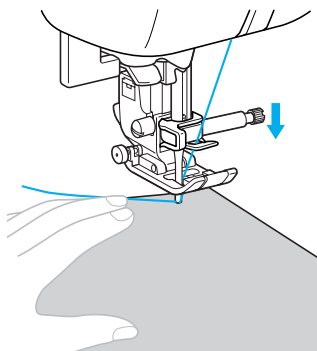

- 2 Press  ("Start/Stop" button) or press down on the foot controller.

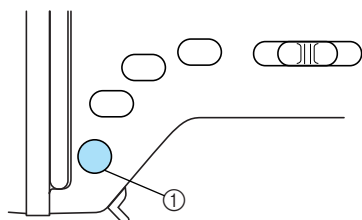

At this time, if  ("Start/Stop" button) is held down, the machine sews at a low speed.



① "Start/Stop" button

- For details, refer to "Starting to sew" (page 52).

▶ The machine starts sewing.

- 3 After sewing 3 to 5 stitches, press  ("Reverse/Reinforcement Stitch" button). Keep  ("Reverse/Reinforcement Stitch" button) held down until you reach the beginning of the stitching.

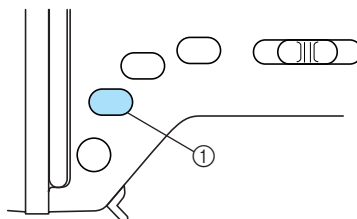

① "Reverse/Reinforcement Stitch" button

▶ While  ("Reverse/Reinforcement Stitch" button) is held down, reverse stitches are sewn.



- 4 After sewing back to the beginning of the stitching, release  ("Reverse/Reinforcement Stitch" button).

▶ The machine stops sewing.

- 5 Press  ("Start/Stop" button), or press down on the foot controller.

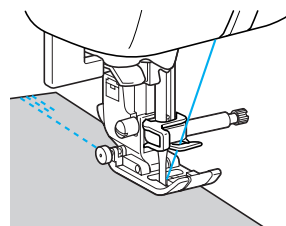
▶ The machine starts sewing in the normal sewing direction



- 6 When the end of the stitching is reached, press  ("Reverse/Reinforcement Stitch" button). Keep  ("Reverse/Reinforcement Stitch" button) held down until 3 to 5 reverse stitches are sewn.

▶ While  ("Reverse/Reinforcement Stitch" button) is held down, reverse stitches are sewn.

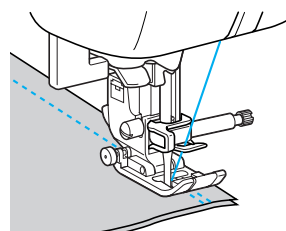

- 7** After 3 to 5 reverse stitches have been sewn, release  (“Reverse/Reinforcement Stitch” button).

▶ The machine stops sewing.

- 8** Press  (“Start/Stop” button), or press down on the foot controller.

At this time, if  (“Start/Stop” button) is held down, the machine sews at a slow speed.

▶ The machine starts sewing in the normal sewing direction.

- 9** After sewing to the end of the stitching, the sewing machine stops.

Press  (“Start/Stop” button) or release foot controller.

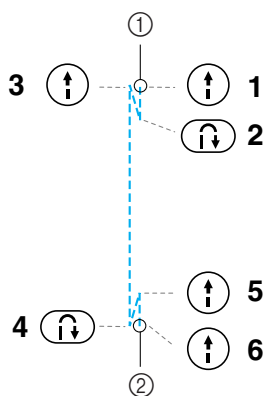

- ① Beginning of stitching
② End of stitching

■ Sewing reinforcement stitches

When sewing stitches other than straight or zigzag stitches that are secured with reverse stitching, pressing  (“Reverse/Reinforcement Stitch” button) sews reinforcement stitches, 3 to 5 stitches on top of each other.

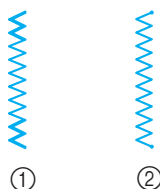

- ① Reverse stitching
② Reinforcement stitching



Memo

- Whether reverse stitches or reinforcement stitches are sewn depends on the stitch that is selected. For details, refer to “Stitch Settings” (page 134).

Cutting the thread

When you have finished sewing, cut the threads. The threads can be cut in either of two ways.

■ Using (“Thread Cutter” button)

- 1** When you wish to finish the stitching, press  (“Thread Cutter” button) once.

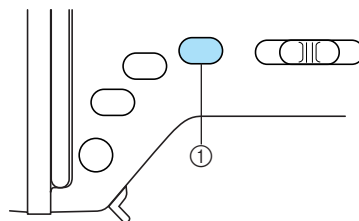

- ① “Thread Cutter” button

▶ The threads are cut and the needle is raised.

- 2** Raise the presser foot lever.

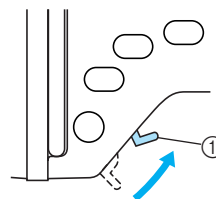

- ① Presser foot lever

! CAUTION

- Do not press  (“Thread Cutter” button) after the threads have already been cut, otherwise the needle may break, the threads may become tangled or damage to the machine may occur.



Note

- Do not press  (“Thread Cutter” button) if there is no fabric under the presser foot or while the machine is sewing, otherwise damage to the machine may occur.



Memo

- The machine can be set so that the threads will be cut when sewing is finished. For details on setting the machine so that the threads are cut automatically, refer to “Automatically cutting the thread” (page 62).

■ Using the manual thread cutter

When sewing with thread thicker than #30, nylon or metallic threads, or other special threads, use the thread cutter on the side of the machine to cut the threads.

- ① When you wish to finish the stitching and the sewing machine is stopped, press  (“Needle Position” button) once to raise the needle.

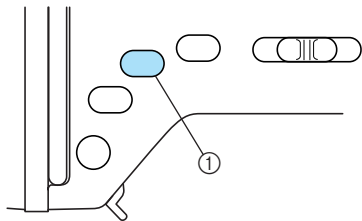

① “Needle Position” button

▶ The needle is raised.

- ② Raise the presser foot lever.

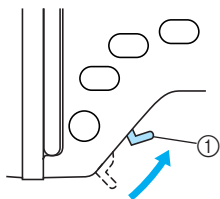

① Presser foot lever

- ③ Pull the fabric to the left side of the machine, and then pass the threads through the thread cutter to cut them.

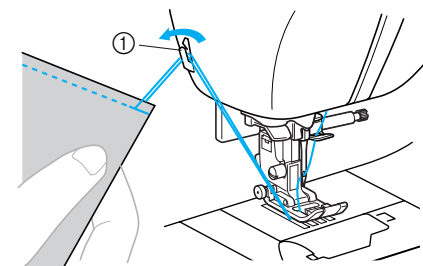

① Thread cutter

Adjusting the Thread Tension

The tensions of the upper thread and of the bobbin thread (thread tension) should be adjusted so that they are equal.

Changing the tension of the upper thread

You may need to change the thread tension, depending on the fabric and thread being used.

■ Correct thread tension

The upper thread and the bobbin thread should cross near the center of the fabric. Only the upper thread should be visible from the right side of the fabric, and only the bobbin thread should be visible from the wrong side of the fabric.

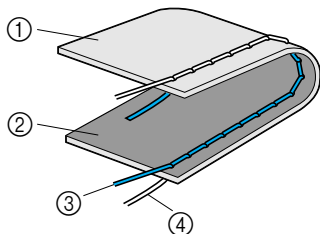

- ① Wrong side of fabric
- ② Right side of fabric
- ③ Upper thread
- ④ Bobbin thread

■ Upper thread is too tight

If the bobbin thread is visible from the right side of the fabric, the upper thread is too tight.

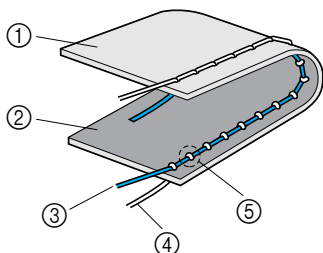

- ① Wrong side of fabric
- ② Right side of fabric
- ③ Upper thread
- ④ Bobbin thread
- ⑤ The bobbin thread is visible from the right side of the fabric.

Turn the thread tension dial to the left to loosen the upper thread.

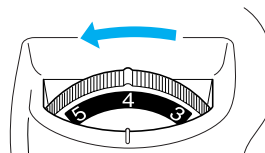

■ Upper thread is too loose

If the upper thread is visible from the wrong side of the fabric, the upper thread is too loose.

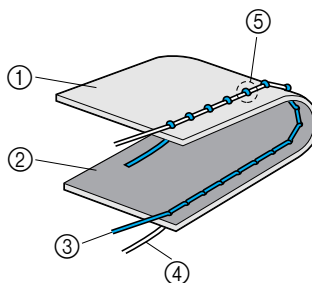

- ① Wrong side of fabric
- ② Right side of fabric
- ③ Upper thread
- ④ Bobbin thread
- ⑤ The upper thread is visible from the wrong side of the fabric.

Turn the thread tension dial to the right to tighten the upper thread.

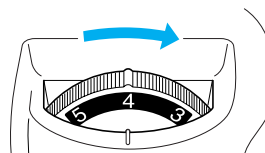

Note

- If the upper thread is not threaded correctly or the bobbin is not installed correctly, it may not be possible to set the correct thread tension. If the correct thread tension cannot be achieved, rethread the upper thread and insert the bobbin correctly.

Adjusting the Stitch Width and Length

The zigzag width (pattern width) and stitch length of utility stitches can be adjusted. Normally, when a stitch is selected, the appropriate width and length are automatically selected. For details on the range of values within which the width and length can be set, refer to “Stitch Settings” (page 134).

Adjusting the stitch width

The stitch width (zigzag width) can be adjusted to make the stitch wider or narrower.

1 Turn on the sewing machine.

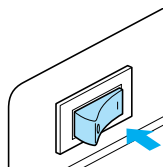

- ▶ The LCD comes on.

2 Select a stitch.

- ▶ A screen containing settings for the selected stitch appears.



- For details on selecting a stitch, refer to “Selecting stitching” (page 72).
- Immediately after the stitch is selected, the standard settings (highlighted) appear.

3 To make the stitch width narrower, press ◀ (Stitch width key). To make the stitch width wider, press ▶ (Stitch width key).

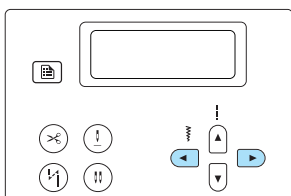

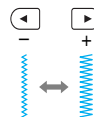
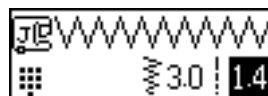

- ▶ The stitch width is changed.



- If the setting is changed, the highlighted value is erased.



Memo

- To reset the stitch width to its standard setting, select the same stitch again or change the setting to the highlighted value.
- Press  (Reset key) to return the stitch width, stitch length to their default settings.
- If the straight stitch (left needle position or triple stretch stitch) was selected, changing the stitch width changes the needle position. Increasing the width moves the needle to the right; reducing the width moves the needle to the left.
- The settings can be saved so that they will always be specified each time the utility stitch is selected. For details, refer to “Saving stitch settings” (page 63).
- The sewing machine can be set so that the stitch width can easily be changed with the sewing speed controller. For details, refer to “Satin stitching using the sewing speed controller” (page 105).
-  indicates that the setting cannot be adjusted.

CAUTION

- After adjusting the stitch width, slowly turn the handwheel toward you and check that the needle does not touch the presser foot. If the needle hits the presser foot, the needle may bend or break.

Adjusting the stitch length

The stitch length can be adjusted to make the stitch longer or shorter.

1 Turn on the sewing machine.

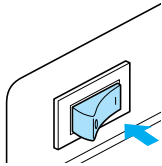

▶ The LCD comes on.

2 Select a stitch.

▶ A screen containing settings for the selected stitch appears.



- For details on selecting a stitch, refer to “Selecting stitching” (page 72).
- Immediately after the stitch is selected, the standard settings (highlighted) appear.

3 To make the stitch length shorter, press (Stitch length key). To make the stitch length longer, press (Stitch length key).

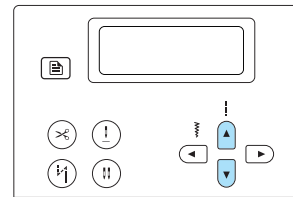

▶ The stitch length is changed.

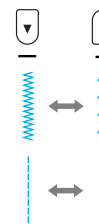

- If the setting is changed, the highlighted value is erased.



Memo

- To reset the stitch length to its standard setting, select the same stitch again or change the setting to the highlighted value.
- Press (Reset key) to return the stitch width, stitch length to their default settings.
- The settings can be saved so that they will always be specified each time the utility stitch is selected. For details, refer to “Saving stitch settings” (page 63).
- indicates that the setting cannot be adjusted.

CAUTION

- If the stitches are bunched together, increase the stitch length. Continuing to sew with the stitches bunched together may result in the needle bending or breaking.

Useful Functions

Functions useful in improving sewing efficiency are described below.

Changing the needle stop position

When the sewing machine is purchased, it is set to leave the needle lowered in the fabric when sewing is stopped. However, the machine can be set to instead leave the needle raised when sewing is stopped.

1 Turn on the sewing machine.

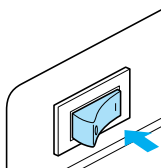

▶ The LCD comes on.

2 Press (Needle stop position key).

▶  (Needle stop position key) lights up, and the machine is now set to stop with the needle in the raised position.

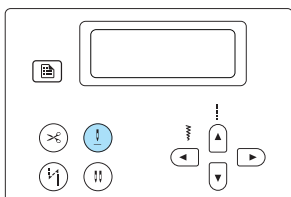

- To return the machine to the setting where the needle is stopped in the lowered position, press  (Needle stop position key) until the key is no longer lit.
- Even after the sewing machine is turned off, the needle stop position setting is not cancelled.

Automatically sewing reverse/reinforcement stitches

The sewing machine can be set to automatically sew reverse or reinforcement stitches at the beginning and end of the stitching. Whether reverse stitches or reinforcement stitches are sewn depends on the stitch that is selected. For details, refer to “Stitch Settings” (page 134).

1 Turn on the sewing machine.

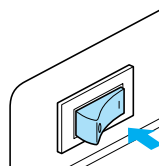

▶ The LCD comes on.

2 Select a stitch.





- For details on selecting a stitch, refer to “Selecting stitching” (page 72).

3 Press  (Automatic reverse/reinforcement stitch key).

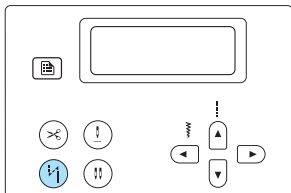
This step is not necessary if a stitch such as those for sewing buttonholes and bar tacks is selected where reinforcement stitches are automatically sewn.



▶  (Automatic reverse/reinforcement stitch key) lights up, and the sewing machine is set for automatic reverse/reinforcement stitching.

- To turn automatic reverse/reinforcement stitching off, press  (Automatic reverse/reinforcement stitch key) until the key is no longer lit.
- When the sewing machine is turned off, the automatic reverse/reinforcement stitching setting is cancelled.

4 Position the fabric under the presser foot, and then press  (“Start/Stop” button) once.

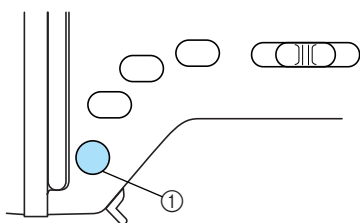

① “Start/Stop” button

▶ After reverse/reinforcement stitches are sewn, the machine starts sewing.

5 After reaching the end of the stitching, press  (“Reverse/Reinforcement Stitch” button) once.

This step is not necessary if a stitch such as those for sewing buttonholes and bar tacks is selected where reinforcement stitches are automatically sewn.

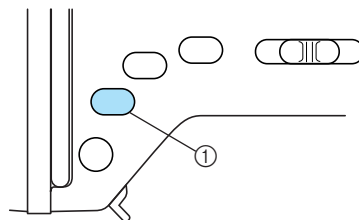

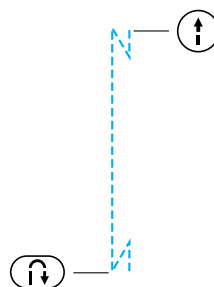

① “Reverse/Reinforcement Stitch” button

▶ After reverse/reinforcement stitches are sewn, the sewing machine stops.



 **Memo**

- Reverse/reinforcement stitches **WILL NOT** be sewn until  (“Reverse/Reinforcement Stitch” button) is pressed.  (“Start/Stop” button) may be pressed to stop stitching when needed such as for pivoting corners.

Automatically cutting the thread

The sewing machine can be set to automatically cut the threads at the end of the stitching. This is called “programmed thread-cutting”. If programmed thread-cutting is set, automatic reverse/reinforcement stitching is also set. This setting is convenient if a stitch for sewing buttonholes or bar tacks is selected.

1 Turn on the sewing machine.

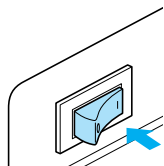

▶ The LCD comes on.



2 Select a stitch.

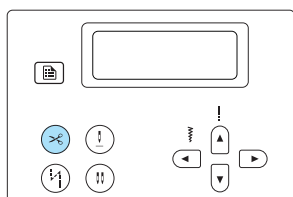

• For details on selecting a stitch, refer to “Selecting stitching” (page 72).

3 Press (Automatic thread cutting key).



▶  (Automatic thread cutting key) and  (Automatic reverse/reinforcement stitch key) light up, and the sewing machine is set for programmed thread-cutting and automatic reverse/reinforcement stitching.

- To turn off programmed thread-cutting, press  (Automatic thread cutting key) until the key is no longer lit.
- When the sewing machine is turned off, the programmed thread-cutting setting is cancelled.

4 Position the fabric under the presser foot, and then press (“Start/Stop” button) once.

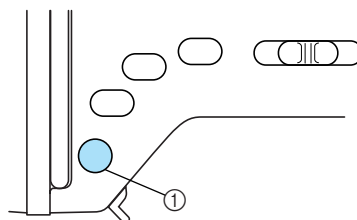

① “Start/Stop” button

▶ After reverse/reinforcement stitches are sewn, the machine starts sewing.

5 After reaching the end of the stitching, press (“Reverse/Reinforcement Stitch” button) once.

This step is not necessary if a stitch such as those for sewing buttonholes and bar tacks is selected where reinforcement stitches are automatically sewn.

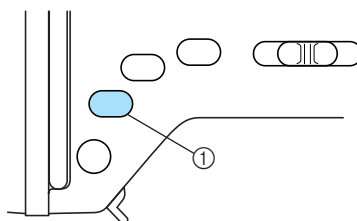

① “Reverse/Reinforcement Stitch” button

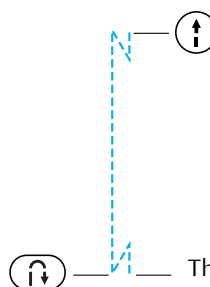

▶ After reverse/reinforcement stitches are sewn, the sewing machine stops and cuts the thread.



 The thread is cut here.



Memo

- Reverse/reinforcement stitches **WILL NOT** be sewn and the thread will not automatically be cut until  (“Reverse/Reinforcement Stitch” button) is pressed.  (“Start/Stop” button) may be pressed to stop stitching when needed such as for pivoting corners.

Saving stitch settings

Adjusted stitch width and length settings can be saved so that they will be specified each time the stitch is selected. The various settings can be saved for each utility stitch.

1 Select the stitch, and then adjust the stitch width and length.

To adjust the stitch width, press ◀ or ▶ (Stitch width keys). To adjust the stitch length, press ▲ or ▼ (Stitch length keys).

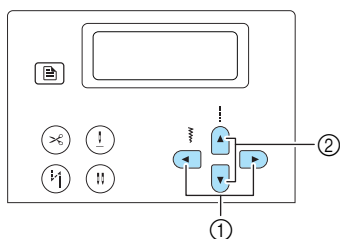

- ① Stitch width keys
- ② Stitch length keys

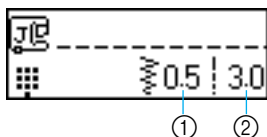

- ① Stitch width (mm)
- ② Stitch length (mm)

- For details on selecting a stitch, refer to “Selecting stitching” (page 72).
- ▶ The stitch width and length are changed.

2 Press ◀▶ (Manual memory key).

- ▶ “Saving...” appears while the settings for the stitch width and stitch length are being saved.
- ▶ After the settings for the stitch width and stitch length are saved, the initial stitch screen appears again.
- The next time that the stitch is selected, the saved settings are the first ones that are displayed.
- To clear the saved settings and return the stitch width and length to their default settings, press ◻◻ (Reset key).
To use the default settings the next time that the stitch is selected, press ◀▶ (Manual memory key) to save the settings.

Hands-free raising and lowering of the presser foot

Using the knee lifter, you can raise and lower the presser foot with your knee, leaving both hands free to handle the fabric.



■ Installing the knee lifter

- 1 Turn off the sewing machine.

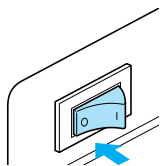

- 2 Insert the knee lifter into its jack on the front of the sewing machine in the lower-right corner.

Align the tabs on the knee lifter with the notches in the jack, and then insert the knee lifter as far as possible.

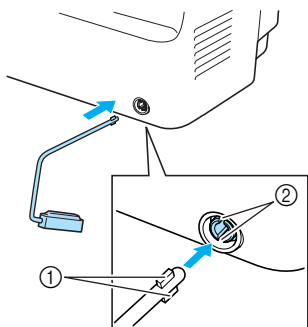

- 1 Tabs
- 2 Notches



Note

- If the knee lifter is not fully inserted into its jack, it may fall out while the sewing machine is operating.

■ Using the knee lifter

- 1 Stop the sewing machine.
 - Do not use the knee lifter while the sewing machine is operating.
- 2 With your knee, press the knee lifter to the right.
 - Keep the knee lifter pressed to the right.

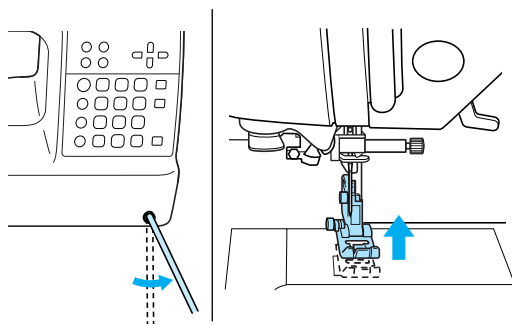

- ▶ The presser foot is raised.

- 3 Release the knee lifter.
 - ▶ The presser foot is lowered.

! CAUTION

- While sewing, keep your knee away from the knee lifter. If the knee lifter is pressed while the sewing machine is operating, the needle may break or the machine may be damaged.

Useful Sewing Tips

Various ways to achieve better results for your sewing projects are described below. Refer to these tips when sewing your project.

Trial sewing

After you have set up the machine with the thread and needle appropriate for the type of fabric being sewn, the machine automatically sets the thread tension and stitch length and width for the stitch that is selected. However, a trial piece of fabric should be sewn since, depending on the type of fabric and stitching being sewn, the desired results may not be achieved.

For the trial sewing, use a piece of fabric and thread that are the same as those used for your project, and check the thread tension and stitch length and width. Since the results differ depending on the type of stitching and the number of layers of fabric sewn, perform the trial sewing under the same conditions that will be used with your project.

Changing the sewing direction

1 When the stitching reaches a corner, stop the sewing machine.

Leave the needle lowered (in the fabric). If the needle remained up when the machine stopped sewing, press  ("Needle Position" button) to lower the needle.

2 Raise the presser foot lever, and then turn the fabric.

Turn the fabric using the needle as a pivot.

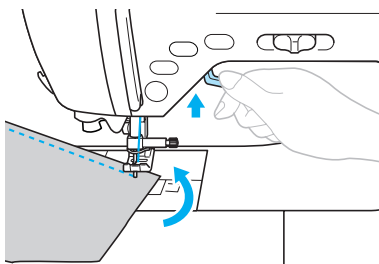

3 Lower the presser foot lever and continue sewing.

Sewing curves

Stop sewing, and then slightly change the sewing direction to sew around the curve. For details on sewing with an even seam allowance, refer to "Sewing an even seam allowance" (page 67).

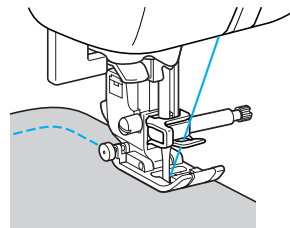

When sewing along a curve while using a zigzag stitch, select a shorter stitch length in order to obtain a finer stitch.

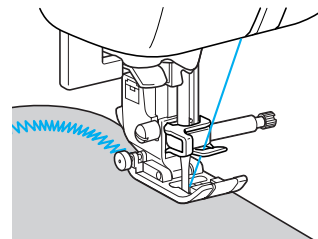

Sewing thick fabrics

■ If the fabric does not fit under the presser foot

If the fabric does not fit easily under the presser foot, raise the presser foot lever even higher to bring the presser foot to its highest position.

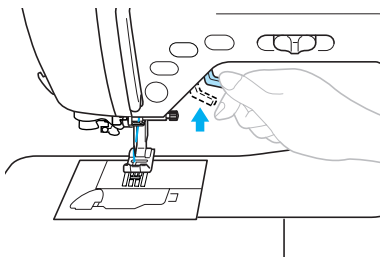

■ If thick seams are being sewn and the fabric does not feed at the beginning of stitching

Zigzag foot "J" is equipped with a feature that keeps the presser foot level.

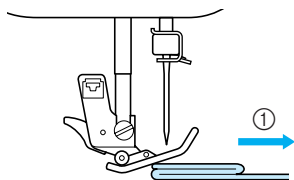

① Sewing direction

① When you encounter a seam that is too thick to feed under the foot, raise the presser foot lever.

② Press the black button (presser foot holding pin) on the left side of zigzag foot "J". Keep the button held in and lower the presser foot.

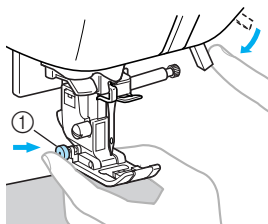

① Presser foot holding pin



Note

- The presser foot needs to be in a level position before pressing the black button (presser foot holding pin) on the left side of zigzag foot "J".

③ Release the button. The foot will lock in place level with the seam, allowing the fabric to feed.

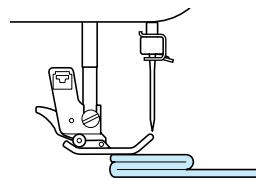

► Once the trouble spot has been passed, the foot will return to its normal position.

! CAUTION

- If fabric more than 6 mm (15/64 inch) thick is sewn or if the fabric is pushed with too much force, the needle may bend or break.

Sewing thin fabrics

When sewing thin fabrics, the stitching may become misaligned or the fabric may not feed correctly. If this occurs, place thin paper or stabilizer material under the fabric and sew it together with the fabric. When you have finished sewing, tear off any excess paper.

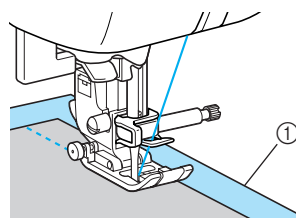

① Stabilizer material or paper

Sewing stretch fabrics

First, baste the pieces of fabric together, and then sew without stretching the fabric.

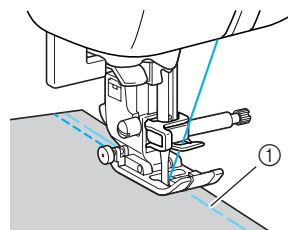

① Basting

Sewing leathers or vinyl fabrics

When sewing the fabrics that may stick to the presser foot such as leathers or coated fabrics, change the presser foot to the non stick foot.

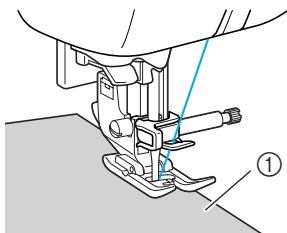

① Leather

Sewing an even seam allowance

To sew an even seam, start sewing so that the seam allowance is to the right of the presser foot, and the edge of the fabric is aligned with either the right edge of the presser foot or a marking on the needle plate.

■ Aligning the fabric with the presser foot

Sew while keeping the right edge of the presser foot a fixed distance from the edge of the fabric.

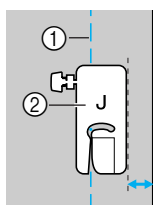

① Seam
② Presser foot

■ Aligning the fabric with the stitch guide foot

Sew while keeping the right edge of the fabric aligned with a desired position of markings on the stitch guide foot.

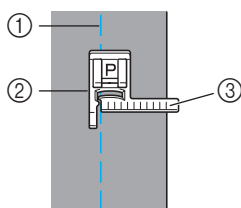

① Seam
② Stitch guide foot
③ Markings

■ Aligning the fabric with a needle plate marking

The markings on the needle plate show the distance from the needle position of a seam sewn with the straight stitch (left needle position). Sew while keeping the edge of the fabric aligned with a marking in the needle plate. The distance between the markings in the upper scale is 1/8 inch (3 mm) and the distance between the markings in the grid is 5 mm (3/16 inch).

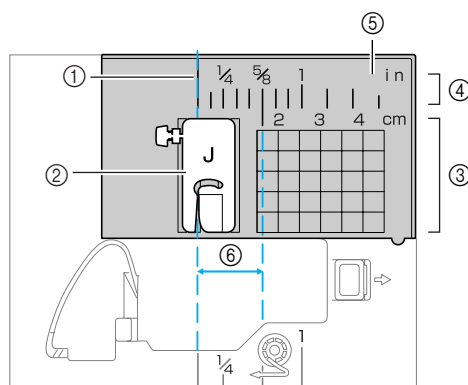

① Seam
② Presser foot
③ Centimeters
④ Inches
⑤ Needle plate
⑥ 16 mm (5/8 inch)

3

UTILITY STITCHES

The various stitches and their applications are described in this chapter.

Selecting Stitching	70	Reinforcement Stitching	107
Selecting stitch types and patterns.....	70	Triple stretch stitching.....	107
Selecting stitching	72	Bar tack stitching.....	107
Overcasting Stitches.....	76	Darning	109
Sewing overcasting stitches		Eyelet Stitching.....	111
using overcasting foot "G"	76	Decorative Stitching.....	112
Sewing overcasting stitches		Fagoting.....	113
using zigzag foot "J"	77	Scallop stitching	114
Sewing overcasting stitches		Smocking.....	114
using the optional side cutter	78	Shell tuck stitching	115
Basic Stitching.....	80	Joining.....	116
Basting	80	Heirloom stitching.....	116
Basic stitching	81	Sewing the Various Built-In	
Blind Hem Stitching	82	Decorative Patterns.....	119
Buttonhole Stitching/Button Sewing....	84	Sewing beautiful patterns	119
Buttonhole sewing.....	85	Sewing patterns.....	119
Button sewing	89	Combining patterns	120
Zipper Insertion.....	91	Repeat sewing patterns.....	121
Inserting a centered zipper	91	Checking the selected pattern	121
Inserting a side zipper	93	Changing the pattern size.....	122
Zipper/piping Insertion	96	Changing the stitch density	123
Inserting a centered zipper	96	Changing the pattern length	124
Inserting a piping	97	Mirror imaging the pattern.....	125
Sewing Stretch Fabrics		Retrieving a pattern.....	126
and Elastic Tape.....	98	Realigning the pattern	127
Stretch stitching	98	Designing a Pattern	129
Elastic attaching	98	Drawing a sketch of the pattern ...	129
Appliqué, Patchwork		Entering the pattern data.....	130
and Quilt Stitching	100	Examples of designs.....	132
Appliqué stitching	101		
Patchwork (crazy quilt) stitching.....	102		
Piecing	102		
Quilting.....	103		
Free-motion quilting.....	104		
Satin stitching using the sewing			
speed controller	105		

Selecting Stitching

You can select any of the various types of stitching available.











Selecting stitch types and patterns

A stitch can be selected from the following types available.

Stitch patterns can be selected through either direct select (by pressing the key for a specific stitch) or number selection (by entering the number for the stitch pattern).

For details on the types of stitches available, refer to "Stitch Settings" (page 134).

■ Direct selection

After pressing  (Preset utility stitch/saved pattern key) to select the stitch mode, press the numeric key assigned with the desired stitch. With direct selection, there are two stitch modes: preset utility stitch mode  and saved pattern mode . When the machine is turned on or when the  (Preset utility stitch/saved pattern key) is pressed, the machine enters preset utility stitch mode, indicated by  in the lower-left corner of the screen. To enter saved pattern mode, indicated by  in the lower-left corner of the screen, press the  (Preset utility stitch/saved pattern key). Each press of  (Preset utility stitch/saved pattern key) switches the mode between the preset utility stitch mode  and saved pattern mode .

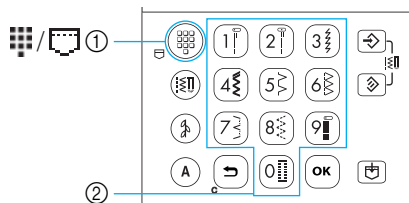



- ① Preset utility stitch/saved pattern key
- ② Numeric keys



□ Preset utility stitch

 The most frequently used utility stitches have been assigned to the numeric keys. These stitches can be selected simply by pressing the key.

□ Saved patterns

 Frequently used patterns and combined patterns can be saved on the machine's memory and easily retrieved using  (Preset utility stitch/saved pattern key) and the numeric keys. For details, refer to "Saving patterns" (page 126).

■ Number selection

After pressing  (Utility stitch key),  (Decorative stitch key) or  (Character stitch key) to select the stitch mode, use the numeric keys to type in the number for the desired stitch.

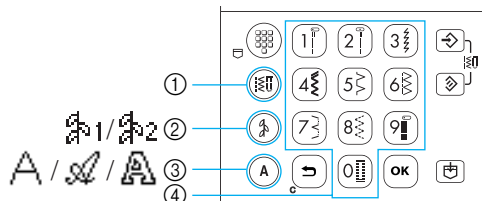









- ① Utility stitch key
- ② Decorative stitch key
- ③ Character stitch key
- ④ Numeric keys

□ Utility stitches (No.01-67)

 There are 67 utility stitches, including straight stitches, overcasting stitches and buttonhole stitches.

□ **Decorative stitches**

There are two decorative stitch modes: decorative stitch 1 mode  and decorative stitch 2 mode .

If  (Decorative stitch key) is pressed once, decorative stitch 1 mode  is selected. If  (Decorative stitch key) is pressed twice, decorative stitch 2 mode  is selected. Each press of  (Decorative stitch key) switches the mode between decorative stitch 1 mode  and decorative stitch 2 mode .

Decorative stitches (No.01-31)

There are 31 decorative stitches, including hearts, leaves and flowers.

Satin stitches (No.32-47)

There are 16 satin stitches.

Cross-stitches (No.48-52)

There are 5 types of cross-stitches.

Decorative satin stitches (No.53-62)

There are 10 decorative satin stitches.



My Custom Stitch (No.99)











You can design original stitches. (For details, refer to "Designing a Pattern" (page 129).)

Utility decorative stitches (No.01-39)

Some utility stitches can be used as decorative stitches. There are 39 of these stitches.

□ **Character stitches**

There are three character stitch modes: Gothic font mode , Script font mode  and outline style mode .

If  (Character stitch key) is pressed once, Gothic font mode  is selected. If  (Character stitch key) is pressed twice, Script font mode  is selected. If  (Character stitch key) is pressed three times, outline style mode  is selected. Each press of  (Character stitch key) switches the mode between the Gothic font mode , Script font mode  and outline style mode .

Gothic font (No.01-55)

There are 55 characters, including letters, symbols and numbers, in the Gothic font.

Script font (No.01-55)

There are 55 characters, including letters, symbols and numbers, in the Script font.

Outline style (No.01-55)

There are 55 characters, including letters, symbols and numbers, in the outline style.

Selecting stitching

Using the operation panel keys, select the desired stitch. Ten of the most often used utility stitches can quickly be selected with the numeric keys.

Right after turning the power on, the straight stitch (left needle position) is selected.

The machine can also be set to select the straight stitch (center needle position). For details, refer to "Changing the settings" (page 19).

1 Determine the stitch that you wish to use.

- For the numbers of the various stitches, refer to the stitch pattern plate and "Stitch Settings" (page 134).

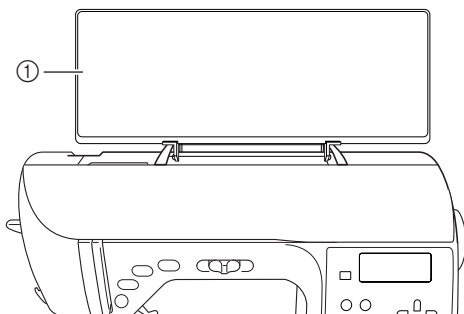

① Stitch pattern plate

2 Determine which presser foot should be used with the selected stitch.

The presser feet are stored in the accessory compartment.

- For details on the stitches that can be sewn with the twin needle, refer to "Stitch Settings" (page 134).

3 Attach the presser foot.

- For details, refer to "Replacing the presser foot" (page 41).

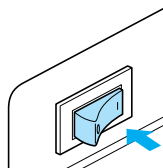

4 Turn on the sewing machine.



- The straight stitch (left needle position) is shown selected in the LCD.

5 After selecting the stitch mode, select the stitch pattern.



With direct selection

With direct selection, there are two stitch modes: preset utility stitch mode  and saved pattern mode .

1 Press (Preset utility stitch/saved pattern key) to select the stitch mode.



: Preset utility stitch

The 10 stitch patterns printed on the numeric keys can be selected directly.

When  appears in the lower-left corner of the screen when the machine is turned on or when the  (Preset utility stitch/saved pattern key) is pressed.

: Saved patterns

The 10 stitch patterns saved with the numeric keys can be selected directly.

When  appears in the lower-left corner of the screen when  (Preset utility stitch/saved pattern key) is pressed.

- ▶ When a direct selection mode is selected,  (Preset utility stitch/saved pattern key) lights up.

- ▶ After the icon for the selected stitch mode appears in the center of the screen, a screen for selecting the stitch appears with the icon for the stitch mode in the lower-left corner. However, when the machine is turned on,  appears only in the lower-left corner of the screen and does not appear in the center of the screen.

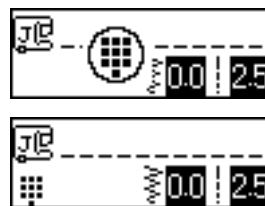

- Example: preset utility stitch









2 Press the key assigned with the stitch to select the stitch.

- Continue with step 6 (on page 74).

■ With number selection

There are three modes of stitches that can be selected by number: utility stitch mode , decorative stitch mode  and character stitch mode .

In addition, there are two decorative stitch modes

 : decorative stitch 1 mode ₁ and decorative stitch 2 mode ₂. There are three character stitch modes  : Gothic font mode , Script font mode  and outline style mode .

1 Press the stitch mode key for the stitch that you wish to use.

Utility stitches

 : 67 utility stitches are available.

Decorative stitches

₁: 62 stitches, including decorative stitches, satin stitches, step patterns, cross stitch and decorative satin stitches, are available.

When  (Decorative stitch key) is pressed once.

₂: 39 utility decorative stitches are available.

When  (Decorative stitch key) is pressed twice.

Character stitches

 : Gothic font
55 letter, symbol and numbers are available.

When  (Character stitch key) is pressed once.

 : Script font
55 letter, symbol and numbers are available.

When  (Character stitch key) is pressed twice.

 : Outline style
55 letter, symbol and numbers are available.

When  (Character stitch key) is pressed three times.

- ▶ A pressed key lights up.
- ▶ After the icon for the selected stitch mode appears in the center of the screen, a screen for selecting the stitch appears with the icon for the stitch mode in the lower-left corner.

- Example: decorative stitches ₁



Memo

- When pressing a stitch mode key multiple times, continue pressing the key after the icon for the stitch mode appears in the lower-left corner of the screen.

2 Use the numeric keys to type in the two-digit number for the desired stitch.

For stitches 01 through 09, the stitch can also be selected by using the numeric keys to type in a one-digit number, then pressing **OK** (OK key).

▶ After the entered number appears in the center of the screen, the stitch is selected.

□ Example

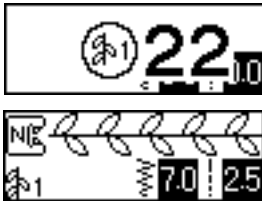

- For the numbers of the various stitches, refer to the stitch pattern plate and “Stitch Settings” (page 134).
- If the first number (tens when entering two-digit numbers, ones when entering one-digit numbers) was incorrectly entered, press **↵** (Cancel/clear key) to erase the entered number.
- If an incorrect two-digit number was entered, an error beep is sounded, and the entered number is cleared.

6 If necessary, specify the setting for automatic reverse/reinforcement stitching and adjust the stitch length, etc.

- For details on sewing with each of the utility stitches, begin on page 76.

Note

- When a stitch is selected, the icon for the presser foot that should be used appears in the screen. Check that the correct presser foot is attached before starting to sew. If the wrong presser foot is installed, turn off the sewing machine, attach the correct presser foot, and then select the desired stitch again.

Memo

- For details on adjusting the stitch width and length, refer to “Adjusting the Stitch Width and Length” (page 58).

■ To select a different stitch

Check the icon in the lower-left corner of the screen for the current mode.



The current mode is indicated.

- To select a stitch in the same mode as the current one
 - In the utility stitch mode, simply type in the number for the desired stitch.
 - In the decorative stitch mode and character stitch mode, press **↵** (Cancel/clear key) to cancel the stitch, and then type in the number for the desired stitch.
 - However, if the currently selected stitch was sewn at least one time, typing in a stitch number switches to the new stitch, even if the previous stitch was not canceled.



Memo

- Patterns can be combined by selecting a different decorative stitch while a stitch is selected. For details, refer to “Saving patterns” (page 126).

- To select a stitch in a different mode as the current one
 - After selecting a different mode, type in the number for the desired stitch. (Refer to steps 5 on pages 72 through 74.)

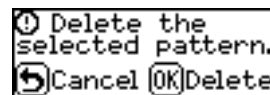
When switching from the utility stitch mode to the decorative stitch or character stitch mode or the other way around, all stitches that have been selected are erased so that a new stitch can be selected. In order to prevent stitches from incorrectly being erased, the following confirmation message appears.



- To erase the stitch and select a different one, press  (OK key), and then change the stitch mode.
- To stop the current stitch from being erased, press  (Cancel/clear key) to return to the previous screen.



Memo

- After changing stitch settings such as the stitch length and width or after combining patterns, the stitch pattern can be saved with its current settings. For details, refer to “Saving patterns” (page 126).
-

Overcasting Stitches

Sew overcasting stitches along the edges of cut fabric to prevent fabric from fraying. Fifteen stitches are available for overcasting. The procedure for sewing overcasting stitch is explained according to the presser foot that is used.

Sewing overcasting stitches using overcasting foot “G”

Three stitches can be used to sew overcasting with overcasting foot “G”.

Stitch Name	Pattern	Numeric Key	Application	Stitch Width [mm (inch)]		Stitch Length [mm (inch)]		Presser Foot
				Auto	Manual	Auto	Manual	
Overcasting stitch	11	5	Preventing fraying in medium weight and thin fabrics	3.5 (1/8)	2.5–5.0 (3/32–3/16)	2.0 (1/16)	1.0–4.0 (1/16–3/16)	G
	12	6	Preventing fraying in thick fabrics and fabrics that fray easily	5.0 (3/16)	2.5–5.0 (3/32–3/16)	2.5 (3/32)	1.0–4.0 (1/16–3/16)	
	13	–		5.0 (3/16)	3.5–5.0 (1/8–3/16)	2.5 (3/32)	1.0–4.0 (1/16–3/16)	

1 Attach overcasting foot “G”.

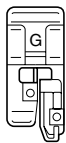

- For details, refer to “Replacing the presser foot” (page 41).

2 Select a stitch.

- For details, refer to “Selecting stitching” (page 72).

3 Position the fabric with the edge of the fabric against the guide of the presser foot, and then lower the presser foot lever.

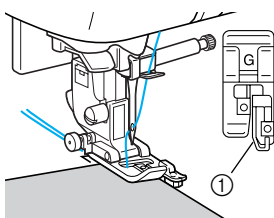

① Guide

4 Sew with the edge of the fabric against the presser foot guide.

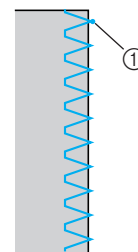

① Needle drop point

CAUTION

- After adjusting the stitch width, slowly turn the handwheel toward you (counterclockwise) and check that the needle does not touch the presser foot. If the needle hits the presser foot, the needle may bend or break.

Sewing overcasting stitches using zigzag foot “J”

Seven stitches can be used to sew overcasting stitches with zigzag foot “J”.

Stitch Name	Pattern	Numeric Key	Application	Stitch Width [mm (inch)]		Stitch Length [mm (inch)]		Presser Foot
				Auto	Manual	Auto	Manual	
Zigzag stitch (center needle position)	07	4	Preventing fraying (center baseline/reverse stitching)	3.5 (1/8)	0.0–7.0 (0–1/4)	1.4 (1/16)	0.0–4.0 (0–3/16)	J
Zigzag stitch (right needle position)	08	–	Preventing fraying (right baseline/reinforcement stitching)	3.5 (1/8)	2.5–5.0 (3/32–3/16)	1.4 (1/16)	0.3–4.0 (1/64–3/16)	
2-point zigzag stitch	09	–	Preventing fraying in thick fabrics and stretch fabrics	5.0 (3/16)	1.5–7.0 (1/16–1/4)	1.0 (1/16)	0.2–4.0 (1/64–3/16)	
3-point zigzag stitch	10	8		5.0 (3/16)	1.5–7.0 (1/16–1/4)	1.0 (1/16)	0.2–4.0 (1/64–3/16)	
Overcasting stitch	14	–	Preventing fraying in stretch fabrics	5.0 (3/16)	0.0–7.0 (0–1/4)	2.5 (3/32)	0.5–4.0 (1/32–3/16)	
	15	–	Preventing fraying in thick fabrics and stretch fabrics	5.0 (3/16)	0.0–7.0 (0–1/4)	2.5 (3/32)	0.5–4.0 (1/32–3/16)	
	16	–	Preventing fraying in stretch fabrics	4.0 (3/16)	0.0–7.0 (0–1/4)	4.0 (3/16)	1.0–4.0 (1/16–3/16)	

1 Attach zigzag foot “J”.

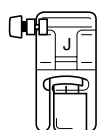

- For details, refer to “Replacing the presser foot” (page 41).

2 Select a stitch.

- For details, refer to “Selecting stitching” (page 72).

3 Sew along the edge of the fabric with the needle dropping off the edge at the right.

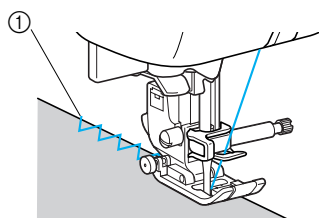

- ① Needle drop point

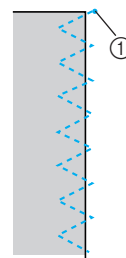







- ① Needle drop point

Memo

- For best results when sewing stretch fabrics, decrease the pressure of the presser foot. For details, refer to “Adjusting the pressure of the presser foot” (page 43).

Sewing overcasting stitches using the optional side cutter

Using the side cutter, seam allowances can be finished while the edge of the fabric is cut off. Five stitches can be used to sew overcasting stitches with the side cutter.

Stitch Name	Pattern 	Application	Stitch Width [mm (inch)]		Stitch Length [mm (inch)]		Presser Foot
			Auto	Manual	Auto	Manual	
Overcasting stitch	63 	Sewing straight stitches while cutting the fabric	0.0 (0)	0.0–2.5 (0–3/32)	2.5 (3/32)	0.2–5.0 (1/64–3/16)	S
	64 	Sewing zigzag stitches while cutting the fabric	3.5 (1/8)	3.5–5.0 (1/8–3/16)	1.4 (1/16)	0.0–4.0 (0–3/16)	
	65 	Preventing fraying in thin and medium weight fabrics while cutting the fabric	3.5 (1/8)	3.5–5.0 (1/8–3/16)	2.0 (1/16)	1.0–4.0 (1/16–3/16)	
	66 	Preventing fraying in thick fabrics while cutting the fabric	5.0 (3/16)	3.5–5.0 (1/8–3/16)	2.5 (3/32)	1.0–4.0 (1/16–3/16)	
	67 	Preventing fraying in thick fabrics while cutting the fabric	5.0 (3/16)	3.5–5.0 (1/8–3/16)	2.5 (3/32)	1.0–4.0 (1/16–3/16)	

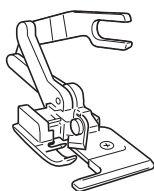

- 1 Remove the presser foot.**
 - For details, refer to “Replacing the presser foot” (page 41).
- 2 Lower the presser foot lever, and then manually thread the needle.**
 - The needle threader cannot be used. If the needle threader is used with the side cutter, the sewing machine may be damaged.
- 3 Raise the presser foot lever.**

- 4 Hook the connecting fork of the side cutter onto the needle clamp screw.**

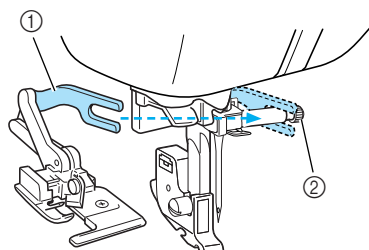

- ① Connecting fork
- ② Needle clamp screw

- 5 Position the side cutter so that side cutter pin is aligned with the notch in the presser foot holder, and then slowly lower the presser foot lever.**

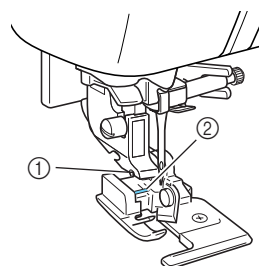

- ① Notch in presser foot holder
- ② Pin

▶ The side cutter is attached.

6 Raise the presser foot lever to check that the side cutter is securely attached.

7 Pass the upper thread under the side cutter, and then pull it out toward the rear of the sewing machine.

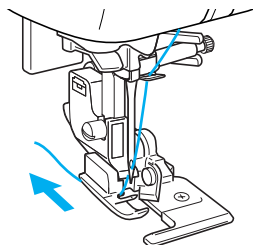

8 Select a stitch.

- For details, refer to “Selecting stitching” (page 72).

CAUTION

- After adjusting the stitch width, slowly turn the handwheel toward you (counterclockwise) and check that the needle does not touch the presser foot. If the needle hits the presser foot, the needle may bend or break.

9 Make a cut of about 2 cm (3/4 inch) long in the fabric at the beginning of the stitching.

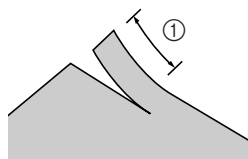

① 2 cm (3/4 inch)

10 Position the fabric in the side cutter. The cut in the fabric should be positioned over the guide plate of the side cutter.

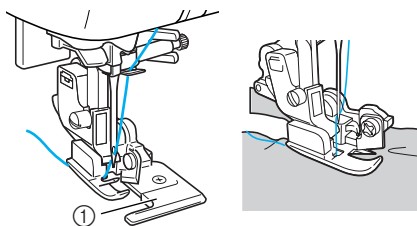

① Guide plate

- If the fabric is not positioned correctly, the fabric will not be cut.

11 Lower the presser foot lever, and then start sewing.

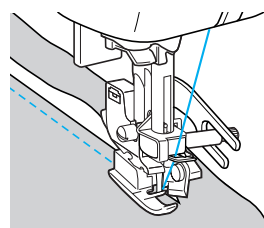

- ▶ A seam allowance is cut while the stitching is sewn.
- If the stitching is sewn in a straight line, the seam allowance will be about 5 mm (3/16 inch).

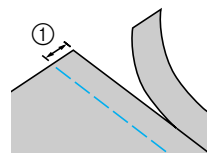









① 5 mm (3/16 inch)

Memo

- The side cutter can cut as much as one layer of 13-oz. denim.
- After using the side cutter, clean it by removing any lint or dust.
- If the side cutter can no longer cut fabric, use a rag to apply a small amount of oil to the cutting edge of the cutter.
- The optional side cutter is available through your brother dealer.

Basic Stitching

Straight stitches are used for sewing plain seams. Five stitches are available for basic stitching.

Stitch Name	Pattern	Numeric Key	Application	Stitch Width [mm (inch)]		Stitch Length [mm (inch)]		Presser Foot
				Auto	Manual	Auto	Manual	
Basting stitch	06 	—	Temporarily securing	0.0 (0)	0.0–7.0 (0–1/4)	—	—	J
Straight stitch (left needle position)	01 		Basic stitching and sewing gathers or pintucks (left baseline/reverse stitching)	0.0 (0)	0.0–7.0 (0–1/4)	2.5 (3/32)	0.2–5.0 (1/64–3/16)	
	02 	—	Basic stitching and sewing gathers or pintucks (left baseline/reinforcement stitching)	0.0 (0)	0.0–7.0 (0–1/4)	2.5 (3/32)	0.2–5.0 (1/64–3/16)	
Straight stitch (center needle position)	03 		Basic stitching and sewing gathers or pintucks (center baseline/reverse stitching)	3.5 (1/8)	0.0–7.0 (0–1/4)	2.5 (3/32)	0.2–5.0 (1/64–3/16)	
Triple stretch stitch	04 		Reinforcing seams and sewing stretch fabrics	0.0 (0)	0.0–7.0 (0–1/4)	2.5 (3/32)	1.5–4.0 (1/16–3/16)	

Basting

Sew basting with a stitch length between 5 mm (3/16 inch).

1 Attach zigzag foot “J”.

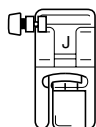

- For details, refer to “Replacing the presser foot” (page 41).

2 Select stitch 06 .

- For details, refer to “Selecting stitching” (page 72).

3 Start sewing.

- For details, refer to “Starting to sew” (page 52).

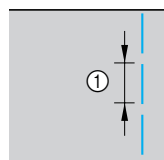

① 5 mm (3/16 inch)

Basic stitching

1 Baste or pin together the fabric pieces.

2 Attach zigzag foot “J”.

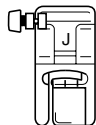

- For details, refer to “Replacing the presser foot” (page 41).

3 Select a stitch.

- For details, refer to “Selecting stitching” (page 72).

4 Lower the needle into the fabric at the beginning of the stitching.

5 Start sewing.

- For details, refer to “Starting to sew” (page 52).
- For details on sewing reverse/reinforcement stitches, refer to “Securing the stitching” (page 54).

6 When sewing is finished, cut the thread.

- For details, refer to “Cutting the thread” (page 55).

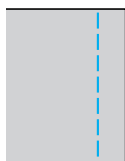

Changing the needle position

The needle position used as the baseline is different for the straight stitch (left needle position) and the straight stitch (center needle position).

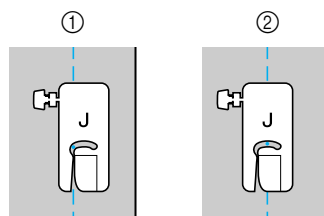

- ① Straight stitch (left needle position)
- ② Straight stitch (center needle position)

When the stitch width of the straight stitch (left needle position) is set to its standard setting (0.0 mm), the distance from the needle position to the right side of the presser foot is 12 mm (1/2 inch). If the stitch width is changed (between 0 and 7.0 mm (1/4 inch)), the needle position will also change. By changing the stitch width and sewing with the right side of the presser foot aligned with the edge of the fabric, a seam allowance can be sewn with a fixed width.

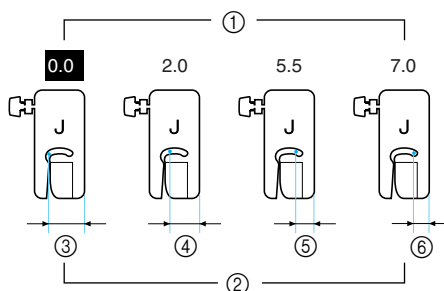

- ① Stitch width setting
- ② Distance from the needle position to the right side of the presser foot
- ③ 12.0 mm (1/2 inch)
- ④ 10.0 mm (3/8 inch)
- ⑤ 6.5 mm (1/4 inch)
- ⑥ 5.0 mm (3/16 inch)

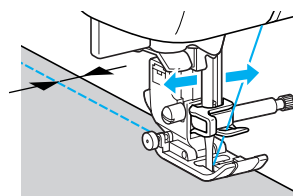

- For details, refer to “Adjusting the stitch width” (page 58).

Blind Hem Stitching

Secure the bottoms of skirts and pants with a blind hem. Two stitches are available for blind hem stitching.

Stitch Name	Pattern	Numeric Key	Application	Stitch Width [mm (inch)]		Stitch Length [mm (inch)]		Presser Foot
				Auto	Manual	Auto	Manual	
Blind hem stitch	17 		Blind hem stitching on medium weight fabrics	00 (0)	3← - 3→	2.0 (1/16)	1.0-3.5 (1/16-1/8)	R
	18 	-	Blind hem stitching on stretch fabrics	00 (0)	3← - 3→	2.0 (1/16)	1.0-3.5 (1/16-1/8)	

Sew a blind hem according to the following procedure.

- 1** Fold the fabric along the desired edge of the hem, and then baste it about 5 mm (3/16 inch) from the edge of the fabric.

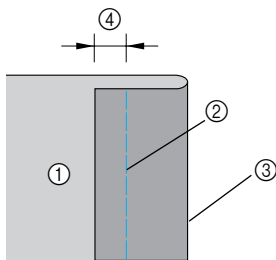

- ① Wrong side of fabric
- ② Basting stitching
- ③ Desired edge of hem
- ④ 5 mm (3/16 inch)

- 2** Fold back the fabric along the basting, and then position the fabric with the wrong side facing up.

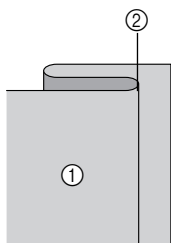

- ① Wrong side of fabric
- ② Basting

- 3** Attach blind hem foot "R".

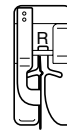

- For details, refer to "Replacing the presser foot" (page 41).

- 4** Select a stitch.

- For details, refer to "Selecting stitching" (page 72).

- 5** Position the fabric with the edge of the folded hem against the guide of the presser foot, and then lower the presser foot lever.

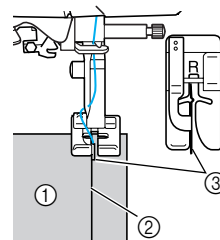

- ① Wrong side of fabric
- ② Fold of hem
- ③ Guide

6 Adjust the stitch width until the needle slightly catches the fold of the hem.

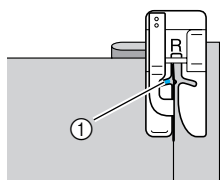

① Needle drop point

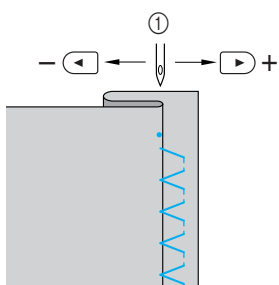
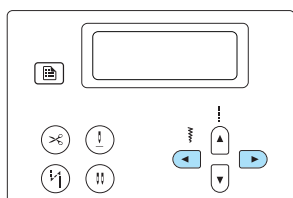

① Stitch width

■ **If the needle catches too much of the hem fold**

The needle is too far to the left. Press **▶** (of the Stitch width keys) to decrease the stitch width so that the needle slightly catches the fold of the hem.

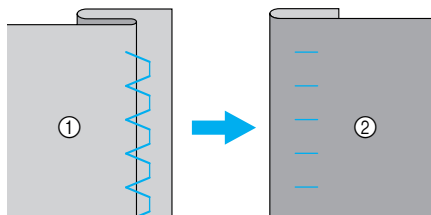
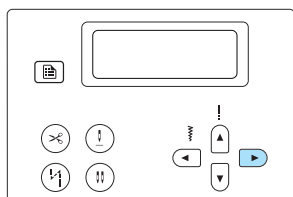

① Wrong side of fabric
② Right side of fabric

■ **If the needle does not catch the hem fold**

The needle is too far to the right. Press **◀** (of the Stitch width keys) to increase the stitch width so that the needle slightly catches the fold of the hem.

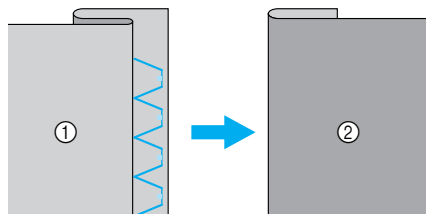
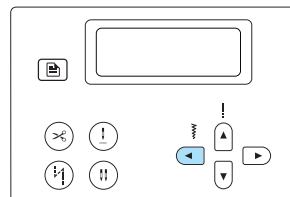

① Wrong side of fabric
② Right side of fabric

• For details on changing the stitch width, refer to “Adjusting the Stitch Width and Length” (page 58).

7 Sew with the fold of the hem against the presser foot guide.

8 Remove the basting stitching.

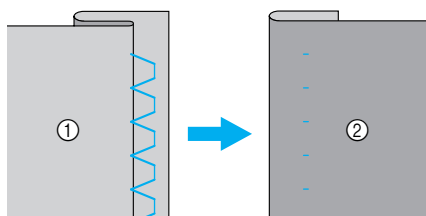

① Wrong side of fabric
② Right side of fabric















Memo

● For best results when sewing stretch fabrics, decrease the pressure of the presser foot. For details, refer to “Adjusting the pressure of the presser foot” (page 43).

3

Buttonhole Stitching/Button Sewing

Buttonholes can be sewn and buttons can be sewn on. Eleven stitches are available for sewing one-step buttonholes and one stitch for sewing on buttons.

Stitch Name	Pattern	Numeric Key	Application	Stitch Width [mm (inch)]		Stitch Length [mm (inch)]		Presser Foot
				Auto	Manual	Auto	Manual	
Buttonhole stitch	48 	—	Horizontal buttonholes on thin and medium weight fabrics	5.0 (3/16)	3.0–5.0 (1/8–3/16)	0.4 (1/64)	0.2–1.0 (1/64–1/16)	A
	49 	—	Horizontal buttonholes on areas that are subject to strain	5.0 (3/16)	3.0–5.0 (1/8–3/16)	0.4 (1/64)	0.2–1.0 (1/64–1/16)	
	50 	—	Horizontal buttonholes on thick fabrics	5.0 (3/16)	3.0–5.0 (1/8–3/16)	0.4 (1/64)	0.2–1.0 (1/64–1/16)	
	51 		Buttonholes with bar tacks on both ends for stabilized fabrics	5.0 (3/16)	3.0–5.0 (1/8–3/16)	0.4 (1/64)	0.2–1.0 (1/64–1/16)	
	52 	—	Buttonholes for stretch or knit fabrics	6.0 (15/64)	3.0–6.0 (1/8–15/64)	1.0 (1/16)	0.5–2.0 (1/32–1/16)	
	53 	—	Buttonholes for stretch fabrics	6.0 (15/64)	3.0–6.0 (1/8–15/64)	1.5 (1/16)	1.0–3.0 (1/16–1/8)	
	54 	—	Bound buttonholes	5.0 (3/16)	0.0–6.0 (0–15/64)	2.0 (1/16)	0.2–4.0 (1/64–3/16)	
	55 	—	Keyhole buttonholes for thick or plush fabrics	7.0 (1/4)	3.0–7.0 (1/8–1/4)	0.5 (1/32)	0.3–1.0 (1/64–1/16)	
	56 	—	Keyhole buttonholes for medium weight and thick fabrics	7.0 (1/4)	3.0–7.0 (1/8–1/4)	0.5 (1/32)	0.3–1.0 (1/64–1/16)	
	57 	—	Horizontal buttonhole for thick or plush fabrics	7.0 (1/4)	3.0–7.0 (1/8–1/4)	0.5 (1/32)	0.3–1.0 (1/64–1/16)	
Button-sewing stitch	61 	—	Button sewing	3.5 (1/8)	2.5–4.5 (3/32–3/16)	—	—	M

Buttonhole sewing

The maximum buttonhole length is about 28 mm (1-1/8 inches) (diameter + thickness of the button). Buttonholes are sewn from the front of the presser foot to the back, as shown below.

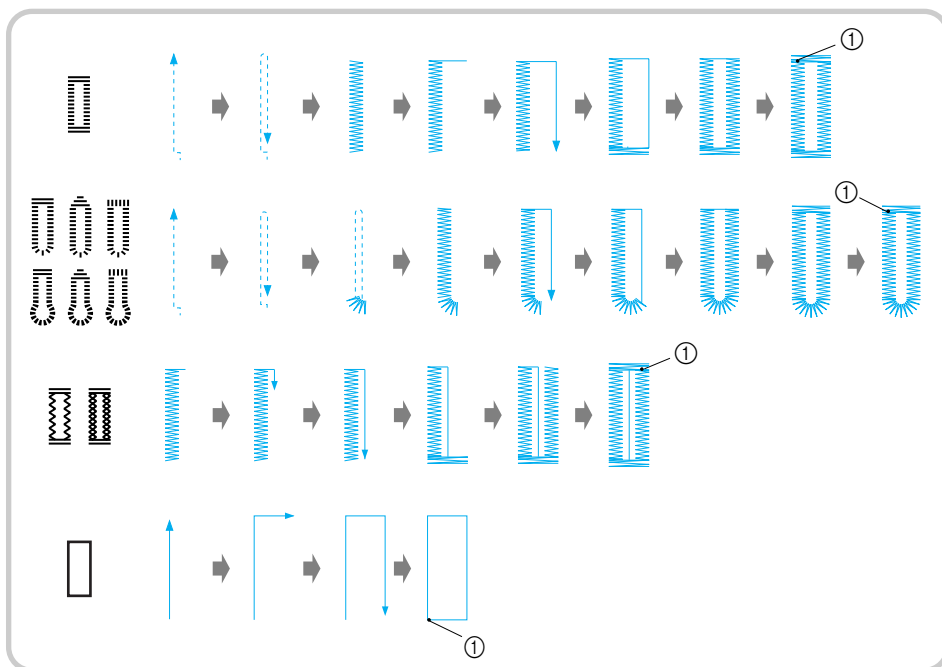

① Reinforcement stitching

The names of parts of buttonhole foot "A", which is used for sewing buttonholes, are indicated below.

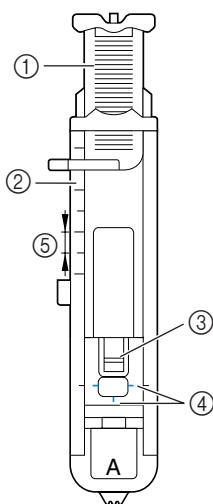

- ① Button guide plate
- ② Presser foot scale
- ③ Pin
- ④ Marks on buttonhole foot
- ⑤ 5 mm (3/16 inch)

1 Use chalk to mark on the fabric the position and length of the buttonhole.

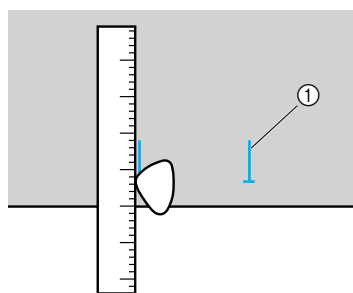

① Marks on fabric

2 Pull out the button guide plate of buttonhole foot "A", and then insert the button that will be put through the buttonhole.

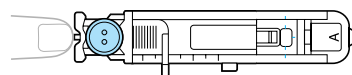

■ If the button does not fit in the button guide plate

Add together the diameter and thickness of the button, and then set the button guide plate to the calculated length. (The distance between the markings on the presser foot scale is 5 mm (3/16 inch).)

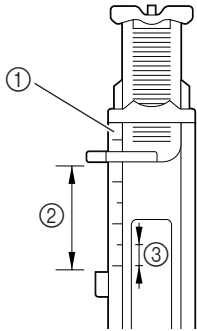

- ① Presser foot scale
- ② Length of buttonhole (Diameter + thickness of button)
- ③ 5 mm (3/16 inch)

Example: For a button with a diameter of 15 mm (9/16 inch) and a thickness of 10 mm (3/8 inch), the button guide plate should be set to 25 mm (1 inch) on the scale.

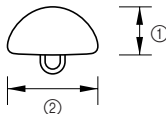

- ① 10 mm (3/8 inch)
- ② 15 mm (9/16 inch)

▶ The size of the buttonhole is set.

3 Attach buttonhole foot "A".

- For details, refer to "Replacing the presser foot" (page 41).

4 Select a stitch.

- For details, refer to "Selecting stitching" (page 72).

5 Position the fabric with the front end of the buttonhole mark aligned with the red marks on the sides of the buttonhole foot, and then lower the presser foot lever.

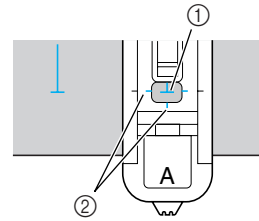

- ① Mark on fabric
- ② Red marks on buttonhole foot

Pass the upper thread down through the hole in the presser foot.

- When lowering the presser foot, do not push in the front of the presser foot, otherwise the buttonhole will not be sewn with the correct size.

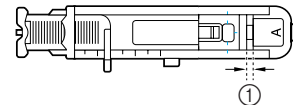
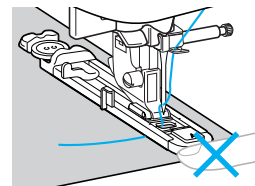

- ① Do not reduce the gap.

6 Pull down the buttonhole lever as far as possible.

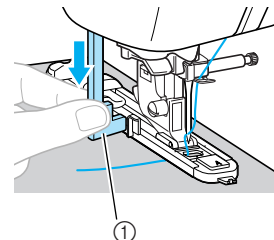

- ① Buttonhole lever

The buttonhole lever is positioned behind the bracket on the buttonhole foot.

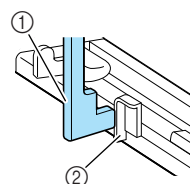

- ① Buttonhole lever
- ② Bracket

- 7** Gently hold the end of the upper thread in your left hand, and then start sewing.

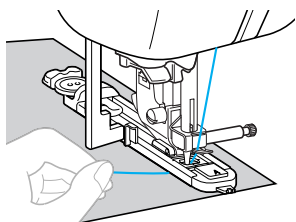

- ▶ Once sewing is completed, the machine automatically sews reinforcement stitches, then stops.

- 8** Cut the threads, raise the presser foot lever, and then remove the fabric.

- 9** Raise the buttonhole lever to its original position.

- 10** Insert a pin along the inside of one bar tack at the end of the buttonhole stitching to prevent the stitching from being cut.

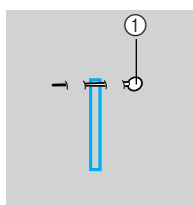

① Pin

- 11** Use the seam ripper to cut towards the pin and open the buttonhole.

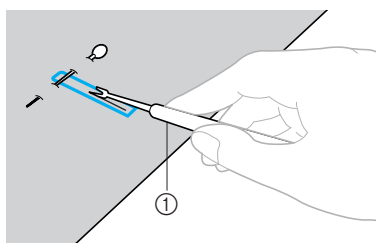

① Seam ripper

For keyhole buttonholes, use the eyelet punch to make a hole in the rounded end of the buttonhole, and then use the seam ripper to cut open the buttonhole.

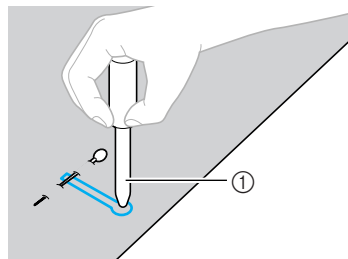

① Eyelet punch

- When using the eyelet punch, place thick paper or some other protective sheet under the fabric before punching the hole in the fabric.

CAUTION

- When opening the buttonhole with the seam ripper, do not place your hands in the cutting direction, otherwise injuries may result if the seam ripper slips.

Changing the density of the stitching

Adjust the stitch length.

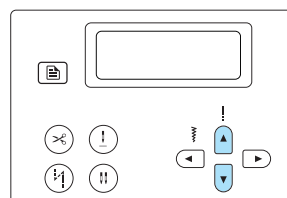
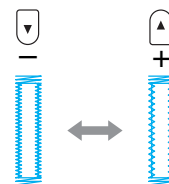

- For details, refer to “Adjusting the stitch length” (page 59).
- If the fabric does not feed (for example, if it is too thick), decrease the density of the stitching.

■ **Changing the stitch width**

Adjust the stitch width.

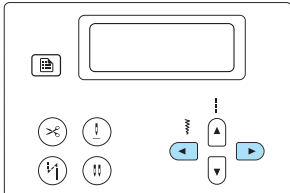
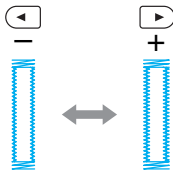

- For details, refer to “Adjusting the stitch width” (page 58).



Memo

- Before sewing buttonholes, check the stitch length and width by sewing a trial buttonhole on a scrap piece of fabric.

■ **Sewing buttonholes on stretch fabrics**

When sewing buttonholes on stretch fabrics, use a gimp thread.

- 1 **Hook the gimp thread onto the part of buttonhole foot “A” shown in the illustration so that it fits into the grooves, and then loosely tie it.**

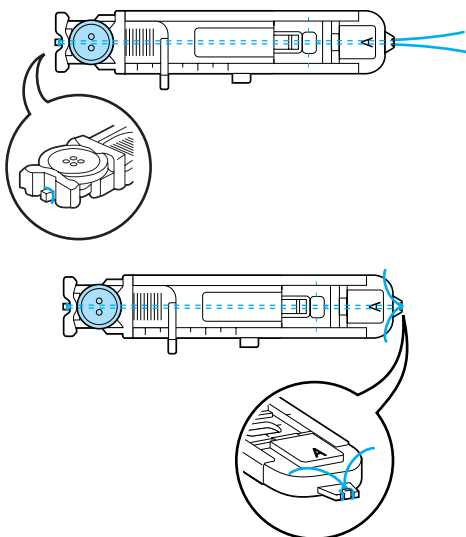

- 2 **Attach buttonhole foot “A”.**

- For details, refer to “Replacing the presser foot” (page 41).

- 3 **Select stitch 52 or 53.**

- 4 **Adjust the stitch width to the thickness of the gimp thread.**

- 5 **Lower the presser foot lever and the buttonhole lever, and then start sewing.**

- 6 **When sewing is finished, gently pull the gimp thread to remove any slack.**

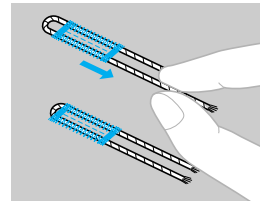

- 7 **Use a handsewing needle to pull the gimp thread to the wrong side of the fabric, and then tie it.**

- 8 **With a seam ripper, cut the middle part of the gimp thread remaining at the top end of the buttonhole.**

Trim off any excess of the gimp thread.

Button sewing

Buttons can be sewn on with the sewing machine. Buttons with 2 or with 4 holes can be attached.

- 1 Measure the distance between the holes in the button to be attached.

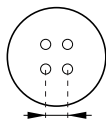

- 2 Raise the presser foot lever, and then slide the drop feed lever, located at the rear of the machine on the base, to  (to the left as seen from the rear of the machine).

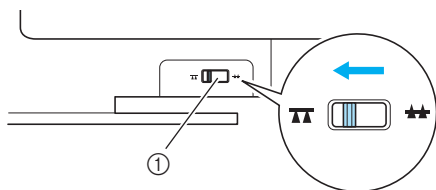

- 1 Drop feed lever (as seen from the rear of the machine)

- ▶ The feed dogs are lowered.

- 3 Attach button-sewing foot “M”.

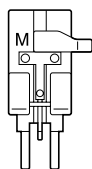

- For details, refer to “Replacing the presser foot” (page 41).

- 4 Select stitch .

- For details, refer to “Selecting stitching” (page 72).
- Since the end of the thread will be tied off later, do not set the sewing machine for programmed-thread cutting.

- 5 Adjust the stitch width so that it is the same as the distance between the holes in the button.

- 6 Place the button into button-sewing foot “M”.

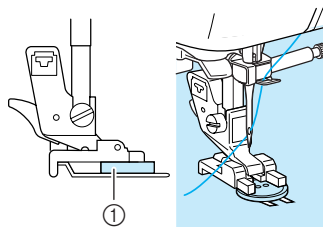

- 1 Button

- ▶ The button is held in place.

- When attaching four-hole buttons, first sew the two holes closest to you. Then, slide the button so that the needle goes into the two holes toward the rear of the sewing machine, and then sew them in the same way.

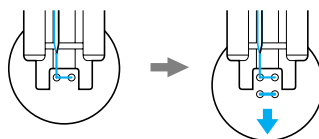

- 7 Turn the handwheel toward you (counterclockwise) to check that the needle correctly goes into the two holes of the button.

If it seems as if the needle will hit the button, remeasure the distance between the holes in the button. Adjust the stitch width to the distance between the button holes.

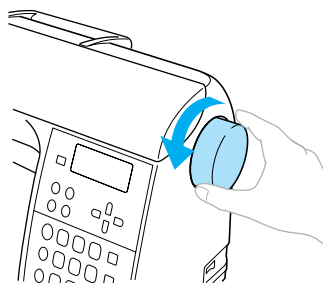

CAUTION

- When sewing, be sure that the needle does not touch the button, otherwise the needle may bend or break.

- 8 Start sewing.**
Set the sewing speed controller to the left (so that the speed will be slow).

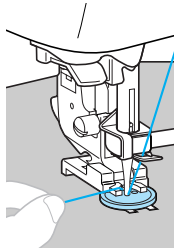

- ▶ The sewing machine automatically stops after sewing reinforcement stitches.
- If additional strength is needed to secure the button, perform the button-sewing operation twice.
- Do not press  (“Thread Cutter” button).

- 9 Use scissors to cut the upper thread and the bobbin thread at the beginning of the stitching.**
Pull the upper thread at the end of the stitching to the wrong side of the fabric, and then tie it with the bobbin thread.

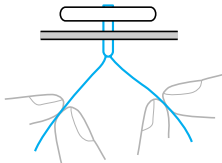

- 10 When you are finished attaching the button, slide the drop feed lever to  (to the right as seen from the rear of the machine) to raise the feed dogs.**

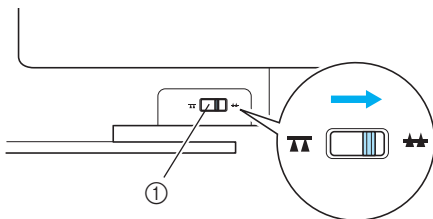

- ① Drop feed lever (as seen from the rear of the machine)



Memo

- The feed dog position switch is normally set to the right side (as seen from the rear of machine).
- The feed dogs come up when you start sewing again.

Attaching a shank to a button

To sew the button with a shank, attach the button with space between it and the fabric, and then wind the thread by hand. This attaches the button securely.

- 1 Place the button into button-sewing foot “M”, and then pull the shank lever toward you.**

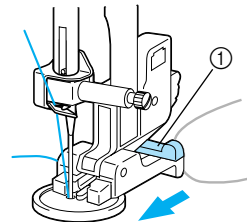

- ① Shank lever

- 2 After sewing is finished, cut the upper thread with plenty of excess, wind it around the thread between the button and the fabric, and then tie it to the upper thread at the beginning of the stitching.**

Tie together the ends of the bobbin thread at the end and at the beginning of the stitching on the wrong side of the fabric.



- 3 Cut off any excess thread.**

Zipper Insertion

A zipper can be sewn in place.

Stitch Name	Pattern	Numeric Key	Application	Stitch Width [mm (inch)]		Stitch Length [mm (inch)]		Presser Foot
				Auto	Manual	Auto	Manual	
Straight stitch (center needle position)			Attaching zippers Sewing concealed seams and pintucks	3.5 (1/8)	0.0–7.0 (0–1/4)	2.5 (3/32)	0.2–5.0 (1/64–3/16)	

There are many methods for inserting zippers. The procedures for inserting a centered zipper and a side zipper are described below.

Inserting a centered zipper

Stitching is sewn on both pieces of fabric butted against each other.

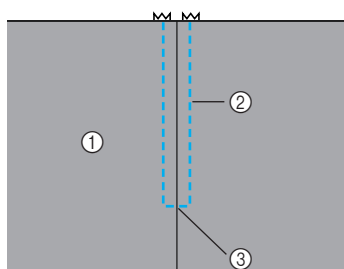

- ① Right side of fabric
- ② Stitching
- ③ End of zipper opening

1 Attach zigzag foot “J” and sew straight stitches up to the zipper opening.

With the right sides of the fabric facing each other, sew reverse stitches after reaching the zipper opening.

- For details, refer to “Basic stitching” (page 81).

2 Using a basting stitch, continue sewing to the edge of the fabric.

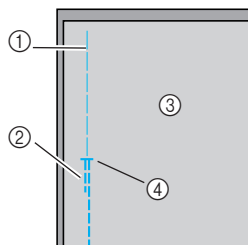

- ① Basting stitching
- ② Reverse stitches
- ③ Wrong side of fabric
- ④ End of zipper opening

3 Press open the seam allowance from the wrong side of the fabric.

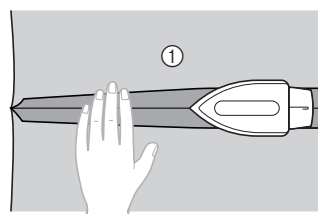

- ① Wrong side of fabric

4 Align the seam with the center of the zipper, and then baste the zipper in place.

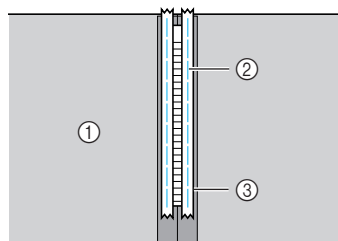

- ① Wrong side of fabric
- ② Basting stitching
- ③ Zipper

- 5** Attach the presser foot holder to the right pin of zipper foot “I”.

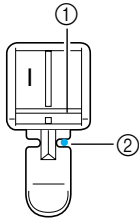

- ① Pin on the right side
- ② Needle drop point

- For details, refer to “Replacing the presser foot” (page 41).

- 6** Select stitch ⁰³ .

- For details, refer to “Selecting stitching” (page 72).

! CAUTION

- When using zipper foot “I”, be sure to select the straight stitch (center needle position), and slowly turn the handwheel toward you (counterclockwise) to check that the needle does not touch the presser foot. If a different stitch is selected or the needle hits the presser foot, the needle may bend or break.

- 7** Topstitch around the zipper.

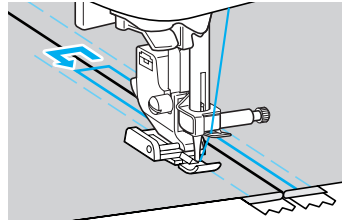
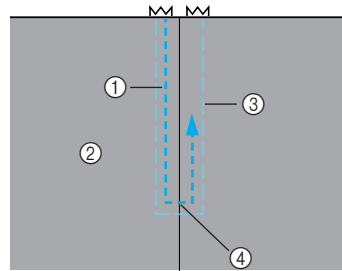

- ① Stitching
- ② Right side of fabric
- ③ Basting stitching
- ④ End of zipper opening

! CAUTION

- When sewing, be sure that the needle does not touch the zipper, otherwise the needle may bend or break.

- 8** Remove the basting stitching.

Inserting a side zipper

Stitching is sewn on only one piece of fabric. Use this type of zipper application for side openings and back openings.

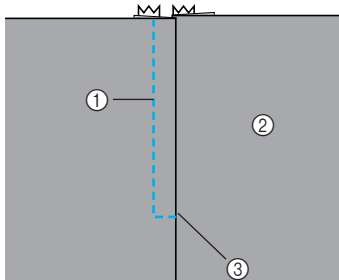

- ① Stitching
- ② Right side of fabric
- ③ End of zipper opening

The following procedure will describe how to stitch on the left side, as shown in the illustration.

1 Attach zigzag foot "J" and sew straight stitches up to the zipper opening.

With the right sides of the fabric facing each other, sew reverse stitches after reaching the zipper opening.

- For details, refer to "Basic stitching" (page 81).

2 Using a basting stitch, continue sewing to the edge of the fabric.

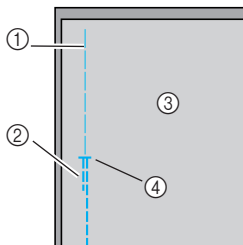

- ① Basting stitching
- ② Reverse stitches
- ③ Wrong side of fabric
- ④ End of zipper opening

3 Press open the seam allowance from the wrong side of the fabric.

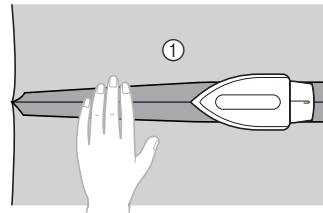

- ① Wrong side of fabric

4 Press the seam allowance so that the right side (the side that will not be stitched) has an extra 3 mm (1/8 inch).

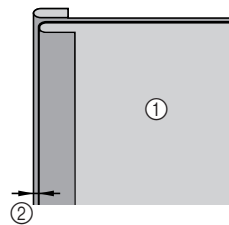

- ① Wrong side of fabric
- ② 3 mm (1/8 inch)

5 Align the zipper teeth with the pressed edge of the fabric having the extra 3 mm (1/8 inch), and then baste or pin the zipper in place.

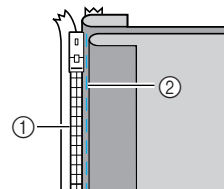

- ① Zipper teeth
- ② Basting stitching

6 Attach the presser foot holder to the right pin of zipper foot "I".

If the stitching will be sewn on the right side, attach the presser foot holder to the left pin of the zipper foot.

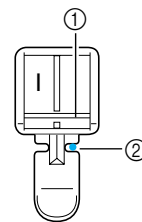

- ① Pin on the right side
- ② Needle drop point

- For details, refer to "Replacing the presser foot" (page 41).

7 Select stitch ⁰³ .

- For details, refer to “Selecting stitching” (page 72).

CAUTION

● When using zipper foot “I”, be sure to select the straight stitch (center needle position), and slowly turn the handwheel toward you (counterclockwise) to check that the needle does not touch the presser foot. If a different stitch is selected or the needle hits the presser foot, the needle may bend or break.

8 Sew the zipper to the piece of fabric with the extra 3 mm (1/8 inch), starting from the base of the zipper.

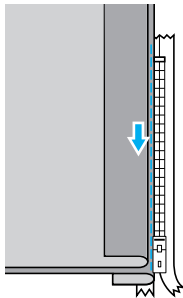

CAUTION

● When sewing, be sure that the needle does not touch the zipper, otherwise the needle may bend or break.

9 When you are about 5 cm (2 inches) from the end of the zipper, stop the sewing machine with the needle lowered (in the fabric), raise the presser foot lever, and then open the zipper and continue sewing.

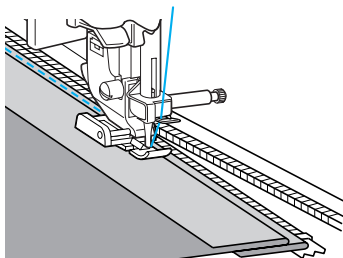

10 Close the zipper, turn over the fabric, and then baste the other side of the zipper to the fabric.

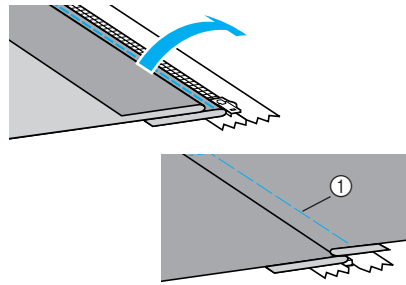

① Basting stitching

11 Attach the presser foot holder to the other pin of zipper foot “I”.

If the presser foot holder was attached to the right pin in step 6, change it to the left pin.

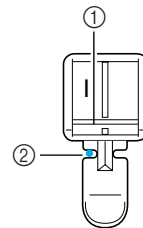

① Pin on the left side
② Needle drop point

12 Topstitch around the zipper.

Sew reverse stitches at the end of the zipper opening and align the zipper teeth with the side of the presser foot.

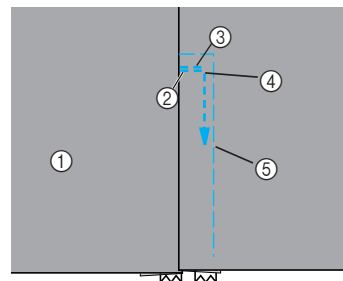

① Right side of fabric
② End of zipper opening
③ Reverse stitches
④ Beginning of stitching
⑤ Basting stitching

CAUTION

● When sewing, be sure that the needle does not touch the zipper, otherwise the needle may bend or break.

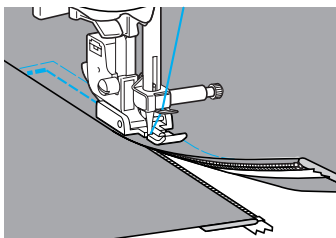

13 When you are about 5 cm (2 inches) from the end of the zipper, stop the sewing machine with the needle lowered (in the fabric), raise the presser foot lever, and then open the zipper and continue sewing.

14 Remove the basting stitching.



Zipper/piping Insertion

A zipper and piping can be sewn in place.

Stitch Name	Pattern	Numeric Key	Application	Stitch Width [mm (inch)]		Stitch Length [mm (inch)]		Presser Foot
				Auto	Manual	Auto	Manual	
Straight stitch (left needle position)	01 		Attaching zippers Sewing concealed seams and piping	0.0 (0)	0.0–7.0 (0–1/4)	2.5 (3/32)	0.2–5.0 (1/64–3/16)	

There are many methods for inserting zippers and pipings. The procedures for inserting a centered zipper and a piping are described below, with the adjustable zipper/piping foot.

Inserting a centered zipper

- 1 Refer to step 1–4 of “Inserting a centered zipper” (page 91).
- 2 Remove the presser foot and presser foot holder (page 43) to attach the screw-on adjustable zipper/piping foot.

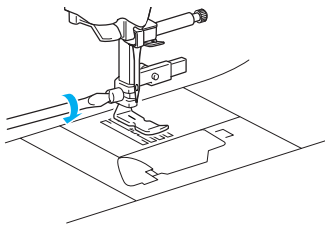

Note

- Use a screw driver to securely tighten the screw that holds the presser foot. If the screw is loose, the needle may break and cause injuries.

- 3 Select stitch 01 .
- 4 Loosen the positioning screw on the back of the presser foot.

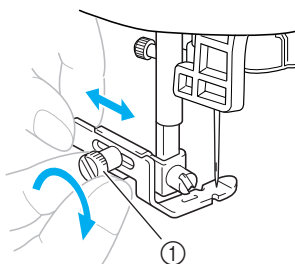

① Positioning screw

- 5 Slide the presser foot over either the left or right feed dog.

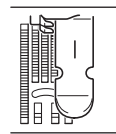
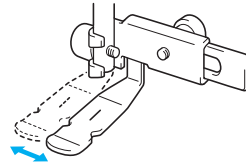

Left sewing position

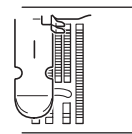

Right sewing position

- 6 Change the needle position so that the needle does not touch the presser foot. For details, refer to “Adjusting the stitch width” (page 58).

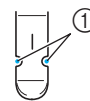

① Needle drop point

CAUTION

- After adjusting the needle position, slowly turn the handwheel toward you and check the needle does not touch the presser foot. If the needle hits the presser foot, the needle may bend or break.

- Securely tighten the positioning screw with a screwdriver.

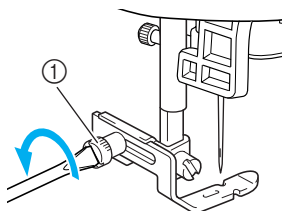

① Positioning screw

- Topstitch around the zipper.

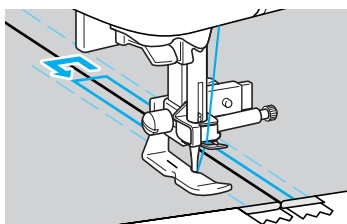
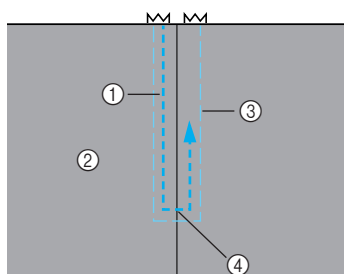

① Stitching
② Right side of fabric
③ Basting stitching
④ End of zipper opening

CAUTION

- When sewing, be sure that the needle does not touch the zipper, otherwise the needle may bend or break.

- Remove the basting stitching.

Inserting a piping

- Place the piping between two fabric pieces turned inside out, as shown below.

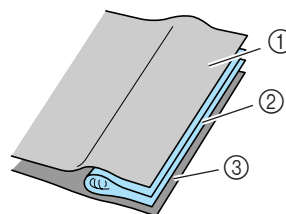

① Fabric
② Piping
③ Fabric

- Refer to the steps of attaching the adjustable zipper/piping foot (page 96).

- Sew along the piping.

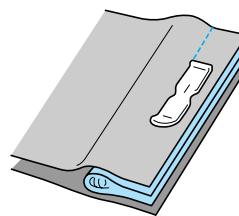



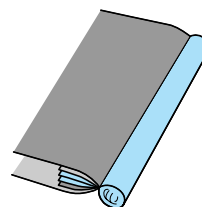



- After sewing, turn fabric pieces.



Sewing Stretch Fabrics and Elastic Tape

Stretch fabrics can be sewn and elastic tape can be attached.

Stitch Name	Pattern	Numeric Key	Application	Stitch Width [mm (inch)]		Stitch Length [mm (inch)]		Presser Foot
				Auto	Manual	Auto	Manual	
Stretch stitch	05 	3 	Stretch fabrics	1.0 (1/16)	1.0–3.0 (1/16–1/8)	2.5 (3/32)	1.0–4.0 (1/16–3/16)	J
2-point zigzag stitch	09 	–	Attaching elastic	5.0 (3/16)	1.5–7.0 (1/16–1/4)	1.0 (1/16)	0.2–4.0 (1/64–3/16)	
3-point zigzag stitch	10 	8 		5.0 (3/16)	1.5–7.0 (1/16–1/4)	1.0 (1/16)	0.2–4.0 (1/64–3/16)	
Elastic-attaching stitch	34 	–	Attaching elastic to stretch fabrics	4.0 (3/16)	0.0–7.0 (0–1/4)	1.0 (1/16)	0.2–4.0 (1/64–3/16)	

Observe the corresponding precautions when performing each of the following stitching operations.

Stretch stitching

1 Attach zigzag foot “J”.

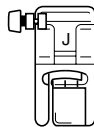

- For details, refer to “Replacing the presser foot” (page 41).

2 Select stitch 05 .

- For details, refer to “Selecting stitching” (page 72).

3 Sew the fabric without stretching it.

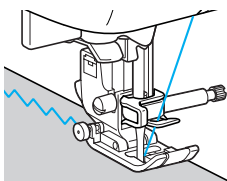

Elastic attaching

When elastic tape is attached to the cuff or waist of a piece of clothing, the finished dimensions will be that of the stretched elastic tape. therefore, it is necessary that a suitable length of the elastic tape be used.

1 Pin the elastic tape to the wrong side of the fabric.

Pin the elastic tape to the fabric at a few points to make sure that the tape is uniformly positioned on the fabric.

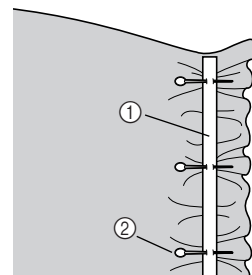

- ① Elastic tape
- ② Pin

2 Attach zigzag foot “J”.

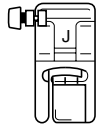

- For details, refer to “Replacing the presser foot” (page 41).

3 Select a stitch.

- For details, refer to “Selecting stitching” (page 72).

4 Sew the elastic tape to the fabric while stretching the tape so that it is the same length as the fabric.

While pulling the fabric behind the presser foot with your left hand, pull the fabric at the pin nearest the front of the presser foot with your right hand.

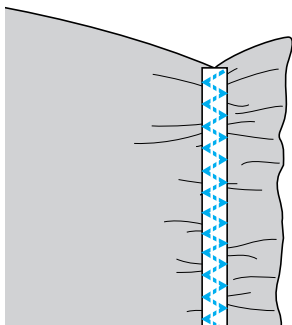
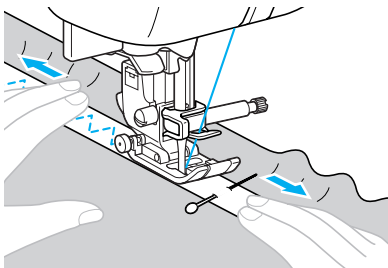













CAUTION

- When sewing, be sure that the needle does not touch any pins, otherwise the needle may bend or break.

Appliqué, Patchwork and Quilt Stitching

The stitches that can be used for sewing appliques, patchwork and quilts are described below.

Stitch Name	Pattern	Numeric Key	Application	Stitch Width [mm (inch)]		Stitch Length [mm (inch)]		Presser Foot
				Auto	Manual	Auto	Manual	
Zigzag stitch	07 		Attaching appliques (center baseline/reverse stitching)	3.5 (1/8)	0.0–7.0 (0–1/4)	1.4 (1/16)	0.0–4.0 (0–3/16)	J
	24 	–	Appliqué quilting, free-motion quilting, satin stitching	3.5 (1/8)	0.0–7.0 (0–1/4)	1.4 (1/16)	0.0–4.0 (0–3/16)	
Appliqué stitch	19 	–	Attaching appliques	3.5 (1/8)	2.5–7.0 (3/32–1/4)	2.5 (3/32)	1.6–4.0 (1/16–3/16)	
	25 	–	Attaching appliques and binding	1.5 (1/16)	0.5–5.0 (1/32–3/16)	1.8 (1/16)	1.0–4.0 (1/16–3/16)	
Piecing straight stitch	21 	–	Piecing straight stitching (with a seam allowance of 6.5 mm (1/4 inch) from the right edge of the presser foot)	5.5 (7/32)	0.0–7.0 (0–1/4)	2.0 (1/16)	0.2–5.0 (1/64–3/16)	
	22 	–	Piecing straight stitching (with a seam allowance of 6.5 mm (1/4 inch) from the left edge of the presser foot)	1.5 (1/16)	0.0–7.0 (0–1/4)	2.0 (1/16)	0.2–5.0 (1/64–3/16)	
Joining stitch	28 	–	Patchwork stitching	4.0 (3/16)	0.0–7.0 (0–1/4)	1.2 (1/16)	0.2–4.0 (1/64–3/16)	
	29 	–		5.0 (3/16)	2.5–7.0 (3/32–1/4)	2.5 (3/32)	1.0–4.0 (1/16–3/16)	
	30 	–		5.0 (3/16)	0.0–7.0 (0–1/4)	1.2 (1/16)	0.2–4.0 (1/64–3/16)	
Mock hand quilting stitch	23 	–	Straight stitch quilting that looks hand quilting	0.0 (0)	0.0–7.0 (0–1/4)	2.5 (3/32)	1.0–4.0 (1/16–3/16)	
Quilting stippling	26 	–	Stippling	7.0 (1/4)	1.0–7.0 (1/16–1/4)	1.6 (1/16)	1.0–4.0 (1/16–3/16)	

Appliqué stitching

For best results, use the included open toe foot.

- 1 Cut out the appliqué, leaving a seam allowance of between 3 and 5 mm (1/8 and 3/16 inch).

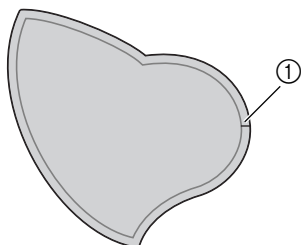

① Seam allowance

- 2 Place a pattern made of thick paper or stabilizer on the back of the appliqué, and then fold over the seam allowance using an iron.

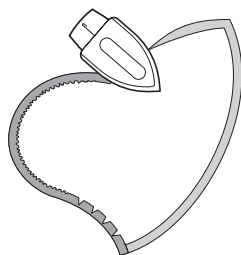

- Remove the thick paper after pressing the seam allowance.

- 3 Turn the fabric over, and then baste or pin it onto the fabric that it will be attached to.

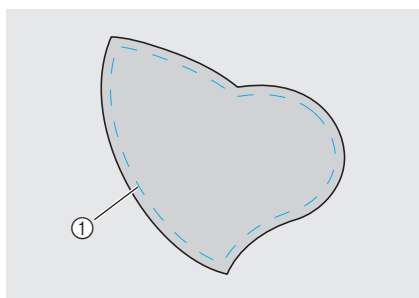

① Basting stitching

- 4 Attach the open toe foot.

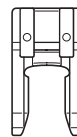

- For details, refer to “Replacing the presser foot” (page 41).

- 5 Select a stitch.

- For details, refer to “Selecting stitching” (page 72).

- 6 Turn the handwheel toward you (counterclockwise), and then begin sewing around the edge of the appliqué, making sure that the needle drops just outside of the appliqué.

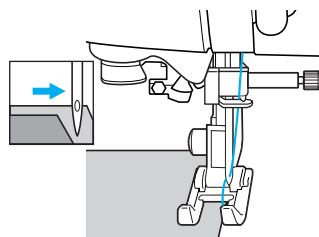

When sewing around corners, stop the machine with the needle in the fabric just outside of the appliqué, raise the presser foot lever, and then turn the fabric as needed to change the sewing direction.

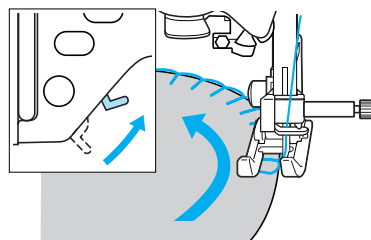

Patchwork (crazy quilt) stitching

- 1 Fold the edge of the top piece of fabric and place it over the lower piece.
- 2 Sew the two pieces of fabric together so the pattern spans over both pieces.

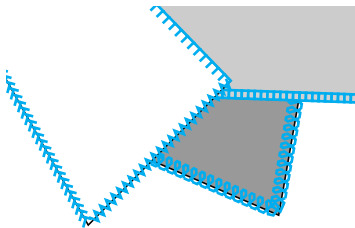
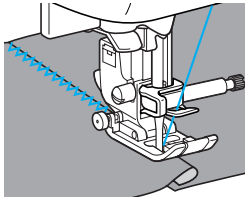

Piecing

Sewing together two pieces of fabric is called "piecing". The fabric pieces should be cut with a 6.5 mm (1/4 inch) seam allowance. Sew a piecing straight stitch 6.5 mm (1/4 inch) from either the right side or the left side of the presser foot.

- 1 Baste or pin along the seam allowance of the fabric that you wish to piece together.
- 2 Attach zigzag foot "J".

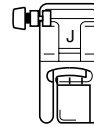

- For details, refer to "Replacing the presser foot" (page 41).

- 3 Select stitch ²¹ or ²².

- For details, refer to "Selecting stitching" (page 72).

- 4 Sew with the side of the presser foot aligned with the edge of the fabric.

■ For a seam allowance on the right side

Align the right side of the presser foot with the edge of the fabric, and sew using stitch

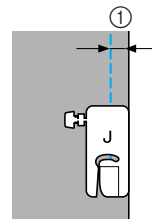

- ① 6.5 mm (1/4 inch)

■ For a seam allowance on the left side

Align the left side of the presser foot with the edge of the fabric, and sew using stitch

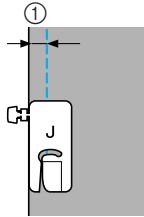

① 6.5 mm (1/4 inch)



Memo

- To change the width of the seam allowance (the needle position), adjust the stitch width.

Quilting

Sandwiching batting between the top and bottom layers of fabric is called “quilting”. Quilts can easily be sewn using the walking foot and the optional quilting guide.

- 1 **Baste the fabric to be quilted.**
- 2 **Attach the walking foot.**
 - For details, refer to “Using the walking foot” (page 44).
- 3 **Select a stitch.**
 - For details, refer to “Selecting Stitching” (page 70).
- 4 **Place one hand on each side of the presser foot, and hold fabric taut while sewing.**

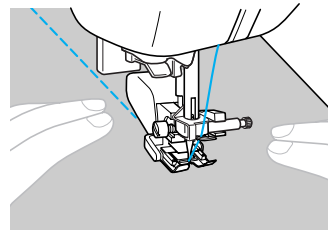

Note

- When sewing with the walking foot, sew at a speed between slow and medium.

■ Using the optional quilting guide

Use the quilting guide to sew parallel stitches that are equally spaced.

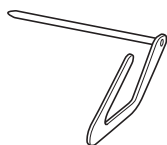

- 1 Insert the stem of the quilting guide into the hole at the rear of the walking foot or presser foot holder.

- Walking foot

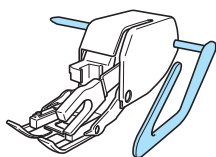

- Presser foot holder

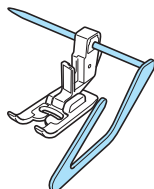

- 2 Adjust the stem of the quilting guide so that the guide aligns with the seam that has already been sewn.

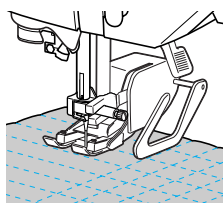

Note

- The optional quilting guide is available through your dealer.

Free-motion quilting

With free-motion quilting, lower the feed dogs (using the drop feed lever) so that the fabric can be moved freely in any direction.

The quilting foot is needed for free-motion quilting.

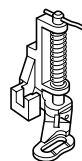

- 1 Remove the presser foot and the presser foot holder.

- Refer to "Removing the presser foot holder" (page 43).

- 2 Secure the quilting foot with the presser foot holder screw.

The pin on the quilting foot should be positioned over the needle clamp screw.

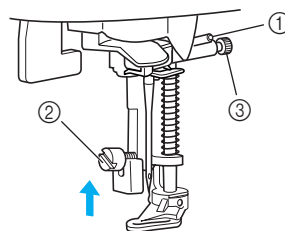

- ① Pin on quilting foot
- ② Presser foot holder screw
- ③ Needle clamp screw

- 3 Hold the quilting foot in place with your right hand, and then tighten the presser foot holder screw using the screwdriver in your left hand.

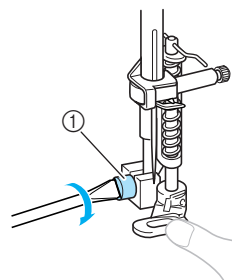

- ① Presser foot holder screw

! CAUTION

- Be sure to securely tighten the screws with the screwdriver, otherwise the needle may touch the presser foot, causing it to bend or break.

- 4** Slide the drop feed lever, located at the rear of the machine on the base, to  (to the left as seen from the rear of the machine).

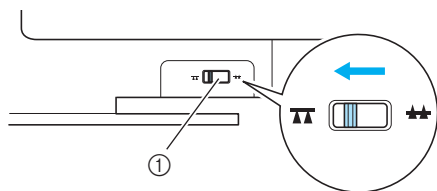

- ① Feed dog position switch (as seen from the rear of the machine)

▶ The feed dogs are lowered.

- 5** Turn on the sewing machine, and then select a stitch.

- For details, refer to “Selecting stitching” (page 72).

- 6** Use both hands to hold the fabric taut, and then move the fabric to follow the pattern.

Reinforcement stitches are sewn at the beginning and end of sewing.

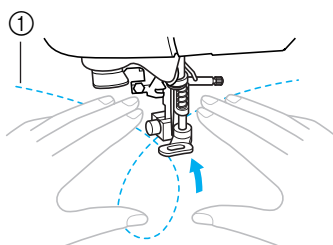

- ① Pattern

- 7** After sewing is finished, slide the drop feed lever to  (to the right as seen from the rear of the machine) to raise the feed dogs.

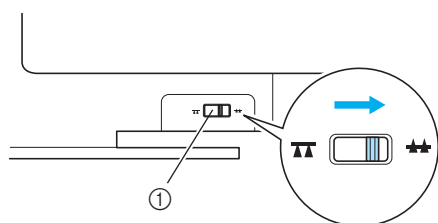

- ① Drop feed lever (as seen from the rear of the machine)

- Normally, the drop feed lever is positioned at the right.

Satin stitching using the sewing speed controller

A decorative stitch can be sewn by changing the stitch width of a satin stitch. If the sewing machine is set so that the stitch width can be adjusted using the sewing speed controller, the stitch width can quickly and easily be adjusted. In this case, the sewing speed is adjusted with the foot controller.

- 1** Connect the foot controller.

- For details, refer to “Starting to sew” (page 52).

- 2** Attach zigzag foot “J”.

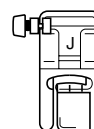

- For details, refer to “Replacing the presser foot” (page 41).

- 3** Turn on the sewing machine, and then press  (Settings key) in the operation panel.

▶ The settings screen appears.



- 4** Press  or  (Stitch length keys) until  is displayed.

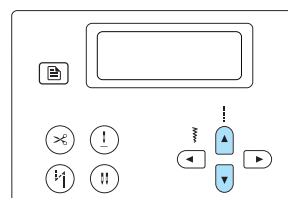

▶ The screen for specifying that the stitch width can be controlled with the sewing speed controller appears.



- 5 Press or (Stitch width keys) to select ON.

To return to OFF, press or (Stitch width keys).

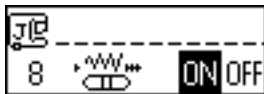
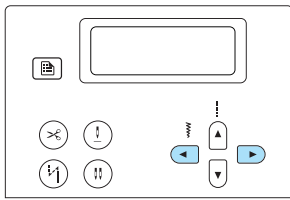

- ▶ The machine is now set so that the stitch width can be controlled with the sewing speed controller.

- 6 Press (OK key) or (Cancel/clear key).

- ▶ The initial stitch screen appears again.

- 7 Select stitch ²⁴ .

- For details, refer to “Selecting stitching” (page 72).

- 8 While sewing, slide the sewing speed controller to adjust the stitch width.

Slide the controller to the left to make the width narrower. Slide the controller to the right to make the width wider.

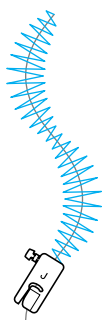
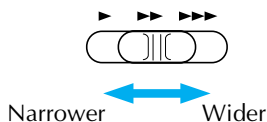

- Adjust the sewing speed with the foot controller.

- 9 When you are finished sewing, set the stitch width control setting back to OFF.







Memo

- Although the stitching result differs depending on the type of fabric being sewn and the thickness of the thread being used, for best results, adjust the stitch length to between 0.3 and 0.5 mm (1/64 and 1/32 inch).

Reinforcement Stitching

Reinforce points that will be subject to strain, such as sleeve holes, inseams and pocket corners.

Stitch Name	Pattern	Numeric Key	Application	Stitch Width [mm (inch)]		Stitch Length [mm (inch)]		Presser Foot
				Auto	Manual	Auto	Manual	
Triple stretch stitch	04 		Reinforcing the seams of sleeves and inseams	0.0 (0)	0.0–7.0 (0–1/4)	2.5 (3/32)	1.5–4.0 (1/16–3/16)	J
Bar tack stitch	60 	–	Reinforcing the ends of openings, such as the corners of pockets	2.0 (1/16)	1.0–3.0 (1/16–1/8)	0.4 (1/64)	0.3–1.0 (1/64–1/16)	A
Darning stitch	58 	–	Darning medium weight fabrics	7.0 (1/4)	2.5–7.0 (3/32–1/4)	2.0 (1/16)	0.4–2.5 (1/64–3/32)	
		59 	–	Darning thick fabrics	7.0 (1/4)	2.5–7.0 (3/32–1/4)	2.0 (1/16)	0.4–2.5 (1/64–3/32)

Triple stretch stitching

Use triple stretch stitching to reinforce sleeve holes and inseams.

1 Attach zigzag foot “J”.

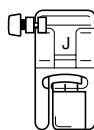

- For details, refer to “Replacing the presser foot” (page 41).

2 Select stitch 04 .

- For details, refer to “Selecting stitching” (page 72).

3 Start sewing.

- For details, refer to “Starting to sew” (page 52).

Bar tack stitching

Bar tacks are used to reinforce points subject to strain, such as pocket corners and openings.

As an example, the procedure for sewing bar tacks at pocket corners is described below.

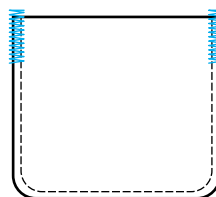

1 Determine the desired length of the bar tack.

Set the button guide plate on buttonhole foot “A” to the desired length. (The distance between the markings on the presser foot scale is 5 mm (3/16 inch).)

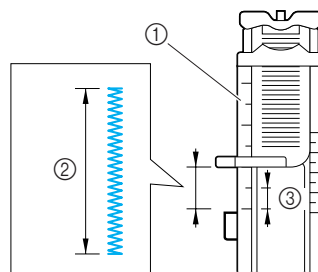

- 1 Presser foot scale
- 2 Length of bar tack
- 3 5 mm (3/16 inch)

- A bar tack with a maximum length of about 28 mm (1–1/8 inches) can be sewn.

2 Attach buttonhole foot "A".

- For details, refer to "Replacing the presser foot" (page 41).

3 Select stitch ⁶⁰ .

- For details, refer to "Selecting stitching" (page 72).

4 Position the fabric so that the opening of the pocket faces toward you, and then lower the presser foot lever so that the needle drops 2 mm (1/16 inch) in front of the pocket opening.

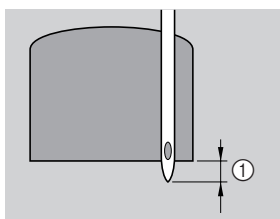

① 2 mm (1/16 inch)

Pass the upper thread down through the hole in the presser foot.

- When lowering the presser foot, do not push in the front of the presser foot, otherwise the bar tack will not be sewn with the correct size.

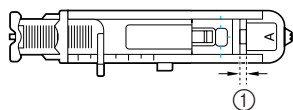
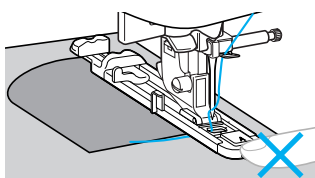

① Do not reduce the gap.

5 Pull down the buttonhole lever as far as possible.

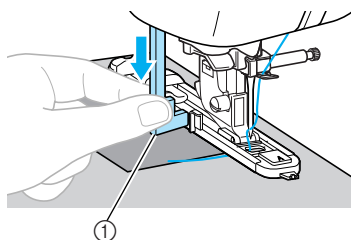

① Buttonhole lever

The buttonhole lever is positioned behind the bracket on the buttonhole foot.

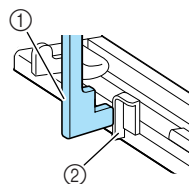

① Buttonhole lever

② Bracket

6 Gently hold the end of the upper thread in your left hand, and then start sewing.

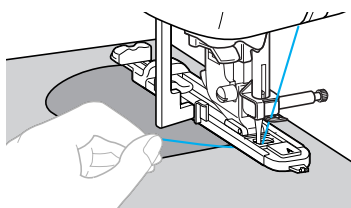

- ▶ Once sewing is completed, the machine automatically sews reinforcement stitches, then stops.

7 Cut the threads, raise the presser foot lever, and then remove the fabric.

8 Raise the buttonhole lever to its original position.



Memo

- If the fabric does not feed, for example, because it is too thick, increase the stitch length. For details, refer to "Adjusting the stitch length" (page 59).

Darning

Fabric that has been torn can be darned.
Darning is sewn as shown below.

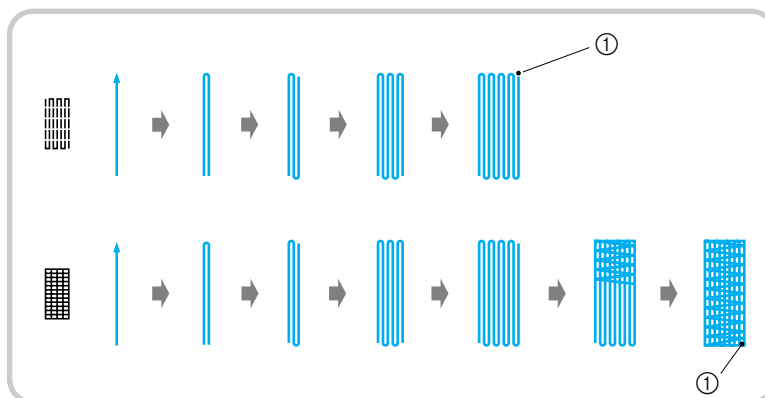

① Reinforcement stitching

- 1 Determine the desired length of the darning.**
Set the button guide plate on buttonhole foot “A” to the desired length. (The distance between the markings on the presser foot scale is 5 mm (3/16 inch).)

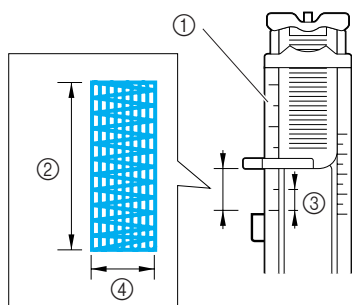

- ① Presser foot scale
- ② Length of darning
- ③ 5 mm (3/16 inch)
- ④ 7 mm (1/4 inch)

- 2 Attach buttonhole foot “A”.**

- For details, refer to “Replacing the presser foot” (page 41).

- 3 Select stitch 58 or 59.**

- For details, refer to “Selecting stitching” (page 72).

- 4 Position the fabric so that the needle is 2 mm (1/16 inch) in front of the area to be darned, and then lower the presser foot lever.**

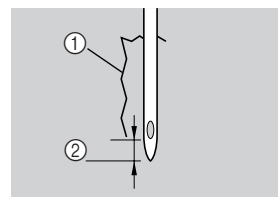

- ① Tear
- ② 2 mm (1/16 inch)

Pass the upper thread down through the hole in the presser foot.

- When lowering the presser foot, do not push in the front of the presser foot, otherwise the darning will not be sewn with the correct size.

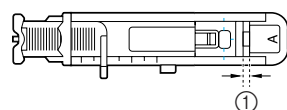
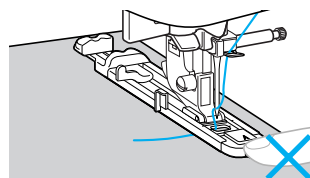

- ① Do not reduce the gap.

- 5 Pull down the buttonhole lever as far as possible.**

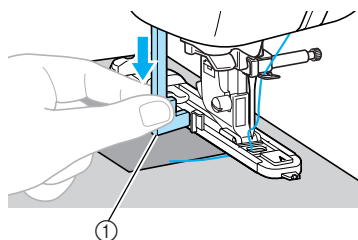

- ① Buttonhole lever

The buttonhole lever is positioned behind the bracket on the buttonhole foot.

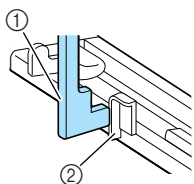

- ① Buttonhole lever
② Bracket

- 6 Gently hold the end of the upper thread in your left hand, and then start sewing.**

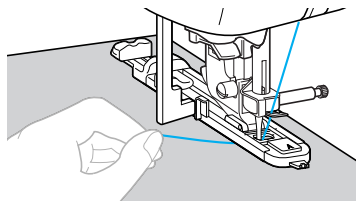

- ▶ Once sewing is completed, the machine automatically sews reinforcement stitches, then stops.

- 7 Cut the threads, raise the presser foot lever, and then remove the fabric.**

- 8 Raise the buttonhole lever to its original position.**





Memo

- If the fabric does not feed, for example, because it is too thick, increase the stitch length. For details, refer to "Adjusting the stitch length" (page 59).

Eyelet Stitching

Eyelets, such as those on belts, can be sewn. Three sizes of eyelets are possible: 7 mm, 6 mm and 5 mm (1/4, 15/64 and 3/16 inch).

Stitch Name	Pattern 	Application	Stitch Width [mm (inch)]		Stitch Length [mm (inch)]		Presser Foot
			Auto	Manual	Auto	Manual	
Eyelet stitch	62 	Sewing eyelets, for example, on belts	7.0 (1/4)	7.0, 6.0 or 5.0 (1/4, 15/64 or 3/16)	–	–	N

1 Attach monogramming foot "N".

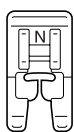

- For details, refer to "Replacing the presser foot" (page 41).

2 Select stitch 62 .

- For details, refer to "Selecting stitching" (page 72).

3 Adjust either the stitch width or the stitch length to select the desired eyelet size.



- For details, refer to "Adjusting the stitch width" (page 58).

4 Lower the needle into the fabric at the beginning of the stitching, and then lower the presser foot lever.

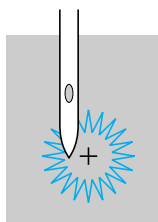

5 Start sewing.

- ▶ Once sewing is completed, the machine automatically sews reinforcement stitches, then stops.

6 Use the eyelet punch to cut a hole in the center of the eyelet.

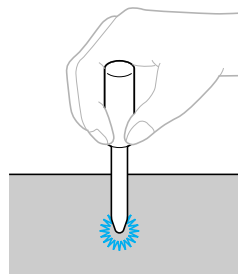

- When using the eyelet punch, place thick paper or some other protective sheet under the fabric before punching the hole in the fabric.



























Memo

- If light weight thread is used, the stitching may be sparse. If this occurs, sew the eyelet twice before removing the fabric, one on top of the other.

Decorative Stitching

Various decorative stitches can be sewn with this sewing machine.

Stitch Name	Pattern 	Application	Stitch Width [mm (inch)]		Stitch Length [mm (inch)]		Presser Foot
			Auto	Manual	Auto	Manual	
Fagoting stitch	32 	Sewing two pieces of fabric together across an open seam	5.0 (3/16)	0.0–7.0 (0–1/4)	2.5 (3/32)	1.0–4.0 (1/16–3/16)	J
	33 		5.0 (3/16)	2.5–7.0 (3/25–1/4)	2.5 (3/32)	1.0–4.0 (1/16–3/16)	
Joining stitch	28 	Decorative bridging stitches	4.0 (3/16)	0.0–7.0 (0–1/4)	1.2 (1/16)	0.2–4.0 (1/64–3/16)	
	29 		5.0 (3/16)	2.5–7.0 (3/32–1/4)	2.5 (3/32)	1.0–4.0 (1/16–3/16)	
	30 		5.0 (3/16)	0.0–7.0 (0–1/4)	1.2 (1/16)	0.2–4.0 (1/64–3/16)	
Shell tuck stitch	20 	Shell tuck stitching on collars and curves	4.0 (3/16)	0.0–7.0 (0–1/4)	2.5 (3/32)	0.2–4.0 (1/64–3/16)	
Smocking stitch	31 	Smocking fabrics to add texture and elasticity	5.0 (3/16)	0.0–7.0 (0–1/4)	1.6 (1/16)	1.0–4.0 (1/16–3/16)	
	32 		5.0 (3/16)	0.0–7.0 (0–1/4)	2.5 (3/32)	1.0–4.0 (1/16–3/16)	
	33 		5.0 (3/16)	2.5–7.0 (3/32–1/4)	2.5 (3/32)	1.0–4.0 (1/16–3/16)	
Scallop stitch	27 	Satin scallop stitching	5.0 (3/16)	2.5–7.0 (3/32–1/4)	0.5 (1/32)	0.1–1.0 (1/64–1/16)	
Hemstitching	39 	Lace sewing, decorative hemming, heirloom stitching, etc.	3.5 (1/8)	1.5–7.0 (1/16–1/4)	2.5 (3/32)	1.6–4.0 (1/16–3/16)	
	40 		6.0 (15/64)	1.5–7.0 (1/16–1/4)	3.0 (1/8)	1.5–4.0 (1/16–3/16)	
	41 	Decorative hemming and heirloom stitching, etc. on thin, medium weight and plain weave fabrics	5.0 (3/16)	1.5–7.0 (1/16–1/4)	3.5 (1/8)	1.5–4.0 (1/16–3/16)	
	42 		5.0 (3/16)	1.5–7.0 (1/16–1/4)	4.0 (3/16)	1.5–4.0 (1/16–3/16)	
	43 		5.0 (3/16)	1.5–7.0 (1/16–1/4)	2.5 (3/32)	1.5–4.0 (1/16–3/16)	
	44 		5.0 (3/16)	1.5–7.0 (1/16–1/4)	2.0 (1/16)	1.5–4.0 (1/16–3/16)	
45 	Decorative hemming, ribbon threading, heirloom stitching, etc.	5.0 (3/16)	1.5–7.0 (1/16–1/4)	3.0 (1/8)	1.5–4.0 (1/16–3/16)		

Stitch Name	Pattern	Application	Stitch Width [mm (inch)]		Stitch Length [mm (inch)]		Presser Foot
			Auto	Manual	Auto	Manual	
Hemstitching	46 	Heirloom stitching, etc.	6.0 (15/64)	1.5–7.0 (1/16–1/4)	1.6 (1/16)	1.0–4.0 (1/16–3/16)	N
	47 		5.0 (3/16)	1.5–7.0 (1/16–1/4)	1.6 (1/16)	1.0–4.0 (1/16–3/16)	
Ladder stitch	35 	Decorative stitching	4.0 (3/16)	0.0–7.0 (0–1/4)	3.0 (1/8)	2.0–4.0 (1/16–3/16)	J
Rick-rack stitch	36 		4.0 (3/16)	0.0–7.0 (0–1/4)	2.5 (3/32)	1.0–4.0 (1/16–3/16)	
Decorative stitch	37 		5.5 (7/32)	0.0–7.0 (0–1/4)	1.6 (1/16)	1.0–4.0 (1/16–3/16)	
Serpentine stitch	38 		5.0 (3/16)	1.5–7.0 (1/16–1/4)	1.0 (1/16)	0.2–4.0 (1/64–3/16)	

Fagoting

Stitching across an open seam is called “fagoting”. It is used on blouses and children's clothing. This stitch is more decorative when thicker thread is used.

- Use an iron to fold the two pieces of fabric along their seams.
- Baste the two pieces of fabric, separated by about 4 mm (3/16 inch), onto thin paper or a sheet of water-soluble stabilizer.
If you draw a line down the middle of the thin paper or water-soluble stabilizer, sewing is easier.

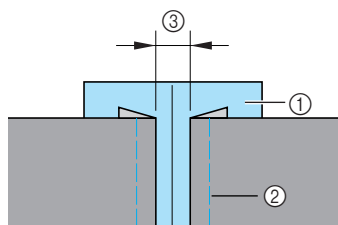

- Thin paper or water soluble stabilizer
- Basting stitching
- 4 mm (3/16 inch)

- Attach zigzag foot “J”.

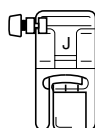

- For details, refer to “Replacing the presser foot” (page 41).

- Select stitch ³²  or ³³ .

- For details, refer to “Selecting stitching” (page 72).

- Set the stitch width to 7.0 mm (1/4 inch).

- For details, refer to “Adjusting the stitch width” (page 58).

- Sew with the center of the presser foot aligned along the center of the two pieces of fabric.

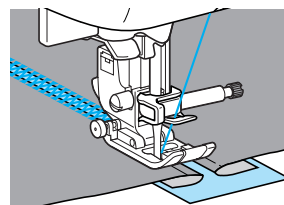
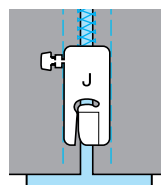

- After sewing is finished, remove the paper.

Scallop stitching

The wave-shaped repeating pattern that looks like shells is called “scalloping”. It is used on the collars of blouses and to decorate the edges of handkerchiefs.

1 Attach monogramming foot “N”.

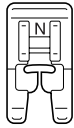

- For details, refer to “Replacing the presser foot” (page 41).

2 Select stitch ²⁷ .

- For details, refer to “Selecting stitching” (page 72).

3 Stitch along the edge of the fabric, making sure not to sew directly on the edge of the fabric.

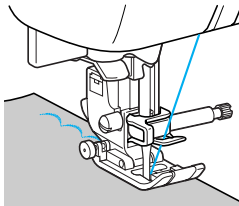

- For better results, apply spray starch to the fabric and press with a hot iron before it is sewn.

4 Trim along the stitches.

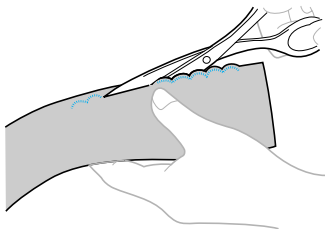

- Be careful not to cut the stitches.

Smocking

The decorative stitch created by stitching or embroidering over gathers is called “smocking”. It is used to decorate the front of blouses or cuffs.

The smocking stitch adds texture and elasticity to fabric.

1 Attach zigzag foot “J”.

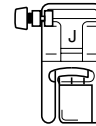

- For details, refer to “Replacing the presser foot” (page 41).

2 Select the straight stitch, and then adjust the stitch length to 4.0 mm (3/16 inch) and loosen the thread tension.

- For details, refer to “Adjusting the stitch length” (page 59) and “Changing the tension of the upper thread” (page 57).

3 Sew parallel stitching at intervals of 1 cm (3/8 inch).

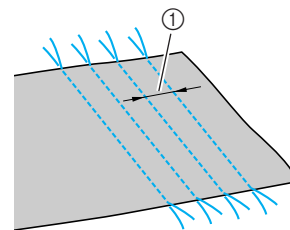



① 1 cm (3/8 inch)

- It is not necessary to sew reverse/reinforcement stitches or cut the thread.
- At the end of the stitching, the thread is pulled out about 5 cm (2 inches).

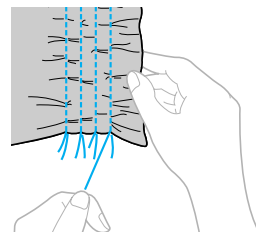
4 Pull the bobbin threads to create gathers. Smooth the gathers by ironing them.



5 Select stitch ³¹ , ³²  or ³³ .

- For details, refer to “Selecting stitching” (page 72).

6 Stitch between the straight stitches.

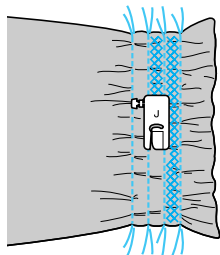

7 Pull out the threads for the straight stitches.

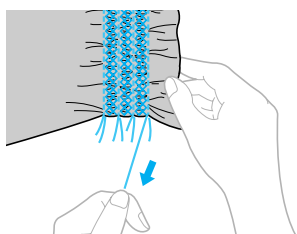

Shell tuck stitching

The gathers that look like shells are called “shell tucks”. They are used to decorate trims, the front of blouses or cuffs made of thin fabrics.

1 Fold the fabric along the bias.

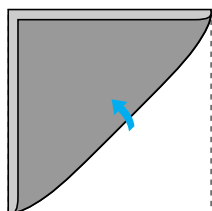

2 Attach zigzag foot “J”.

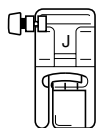

- For details, refer to “Replacing the presser foot” (page 41).

3 Select stitch ²⁰ , and then increase the thread tension.

- For details, refer to “Selecting stitching” (page 72).

4 Sew while making sure that the needle drops slightly off the edge of the fabric.

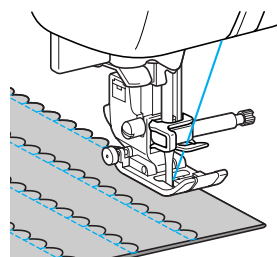
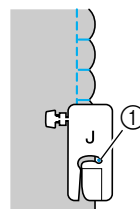

① Needle drop point

5 Unfold the fabric, and then iron the tucks down to one side.

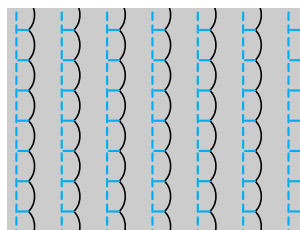

Joining

Decorative bridging stitches can be sewn over the seam allowance of joined fabrics. This is used when making a crazy quilt.

1 Attach zigzag foot "J".

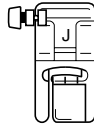

- For details, refer to "Replacing the presser foot" (page 41).

2 Sew together the right sides of the two pieces of fabric, and then open up the seam allowances.

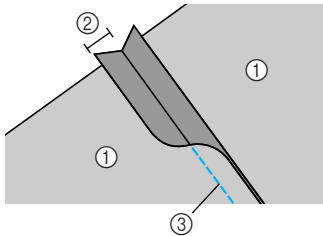

- ① Wrong side of fabric
- ② 6.5 mm (1/4 inch) seam allowance
- ③ Straight stitch

3 Select stitch ²⁸ , ²⁹ or ³⁰ .

- For details, refer to "Selecting stitching" (page 72).

4 Turn the fabric over so that the right side faces up, and then sew over the seam with the center of the presser foot aligned with the seam.

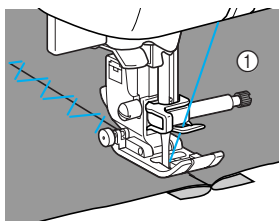

- ① Right side of fabric

Heirloom stitching

When sewing with the wing needle, the needle holes are enlarged, creating a lace-like decorative stitch.

This is used to decorate hems and tablecloths on thin or medium weight fabrics in addition to plain weave fabrics.

Note

- If the thread becomes tangled, use stabilizer material.

1 Install the wing needle.

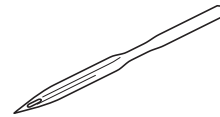

- Use a 130/705H 100/16 wing needle.
- For details on installing a needle, refer to "Replacing the needle" (page 39).
- The needle threader cannot be used with the wing needle, otherwise the sewing machine may be damaged. Manually pass the thread through the eye of the needle from the front to the back.

2 Attach monogramming foot "N".

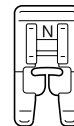

- For details, refer to "Replacing the presser foot" (page 41).

3 Select a stitch.

The stitches that can be used are ³⁹ , ⁴⁰

⁴¹ , ⁴² , ⁴³ , ⁴⁴ , ⁴⁵ , ⁴⁶ or ⁴⁷ .

- For details, refer to "Selecting stitching" (page 72).
- Select a stitch width of 6.0 mm (15/64 inch) or less.

4 Start sewing.

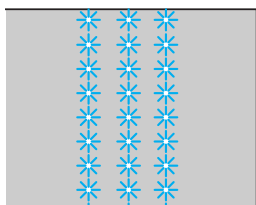

CAUTION

- Select a stitch width of 6.0 mm (15/64 inch) or less, otherwise the needle may bend or break.
- After adjusting the stitch width, slowly turn the handwheel toward you (counterclockwise) and check that the needle does not touch the presser foot. If the needle hits the presser foot, the needle may bend or break.

Partially removing threads is called “drawnwork”. This gives a beautiful result with fabrics that have a loose weave. Two ways to create drawnwork are described below.

■ Drawnwork (Example 1)

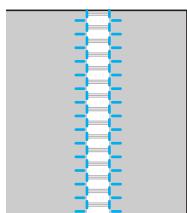

1 Pull out several threads from the fabric.

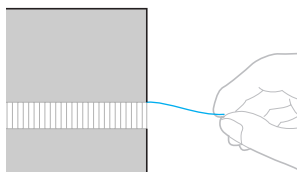

2 Attach monogramming foot “N”.

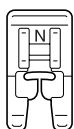

- For details, refer to “Replacing the presser foot” (page 41).

3 Select stitch 39



- For details, refer to “Selecting stitching” (page 72).

4 With the right side of the fabric facing up, sew along the right edge of the frayed section.

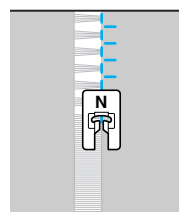

5 Press  (Settings key) in the operation panel.

- ▶ The settings screen appears.

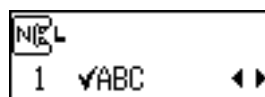

6 Press  or  (Stitch length keys) until  is displayed.

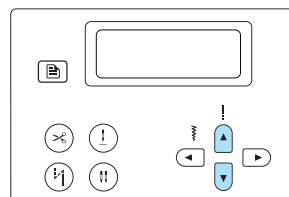

- ▶ The screen for mirror imaging the pattern appears.

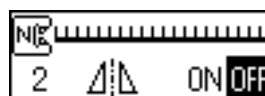

- 7 Press ◀ or ▶ (Stitch width keys) to select **ON**.

To return to **OFF**, press ◀ or ▶ (Stitch width keys).

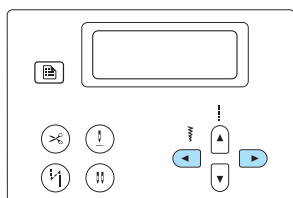

▶ The pattern is flipped.



- 8 Press **OK** (OK key) or **↵** (Cancel/clear key).

▶ The initial stitch screen appears again.



- 9 Sew along the other edge of the frayed section so that it looks like the previous stitching.

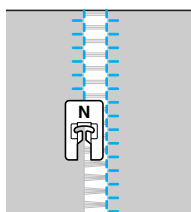

- 10 Set the mirror image pattern setting back to **OFF**.

■ Drawnwork (Example 2)

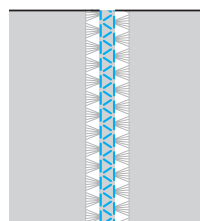

- 1 Pull out several threads from two sections of the fabric, separated by an unfrayed section of about 4 mm (3/16 inch).

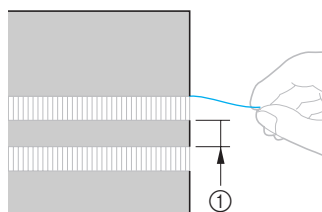

① 4 mm (3/16 inch)

- 2 Attach monogramming foot "N".

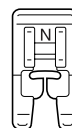

- For details, refer to "Replacing the presser foot" (page 41).

- 3 Select stitch 42 .

- For details, refer to "Selecting stitching" (page 72).

- 4 Sew along the center of the unfrayed section.

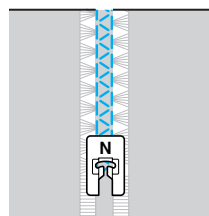

Sewing the Various Built-In Decorative Patterns

Satin stitches, cross-stitches and decorative satin stitches can be sewn. All are sewn with monogramming foot "N".

Sewing beautiful patterns

In order to sew the patterns correctly, the following must be considered.

■ Fabric

Before sewing stretch or thin fabrics or fabrics with a coarse weave, affix the optional stabilizer material to the wrong side of the fabric or place a thin sheet of paper, such as tracing paper, under the fabric. Since material puckering or bunched stitches may occur when satin stitches are sewn, be sure to affix stabilizer material to the fabric.

■ Needles and threads

When sewing thin, medium weight or stretch fabrics, use the ball point needle. When sewing thick fabrics, use a 90/14 home sewing machine needle. In addition, 75/11 to 90/14 thread should be used.

■ Trial sewing

Depending on the type and thickness of the fabric being sewn and whether or not stabilizer material is used, the desired result may not be achieved. Be sure to sew a trial piece of fabric before sewing your project. In addition, while sewing, be sure to guide the fabric with your hands in order to prevent the fabric from slipping.

Sewing patterns

1 Attach monogramming foot "N".

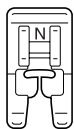

- For details, refer to "Replacing the presser foot" (page 41).

2 Select a stitch.

- For details, refer to steps 4 through 6 of "Selecting stitching" (page 72).

3 Start sewing.

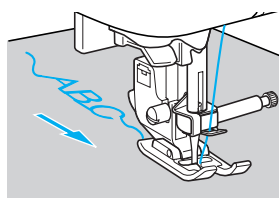
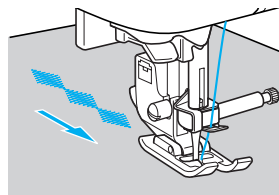

- The stitching is sewn in the direction indicated by the arrow.

4 Sew reinforcement stitches.

When sewing with a character stitch, reinforcement stitches are automatically sewn after each character.



- When sewing a pattern with a stitch other than a character stitch, it is useful to first set the automatic reverse/reinforcement stitching setting. For details, refer to "Automatically sewing reverse/reinforcement stitches" (page 60).

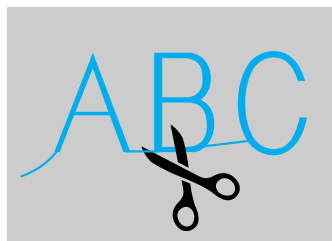

5 When you are finished sewing, use scissors to trim off any excess threads at the beginning of the stitching and between the patterns.



Combining patterns

Multiple patterns can be combined and sewn together.

Decorative stitches and character stitches (stitches selected with  and ) can be combined.

However, utility stitches (stitches selected with  and ) cannot be combined.

1 Select the first pattern.



- ▶ The first pattern is selected and appears in the LCD.



- When the sewing is started, the selected pattern is sewn repeatedly until the sewing machine is stopped.

2 Select the next pattern.

Use the numeric keys to type in the number for the desired stitch.

To change the stitch type, press  (Decorative stitch key) or  (Character stitch key). After the icon for the desired stitch mode appears in the lower-left corner of the screen, type in the number for the desired stitch.



- ▶ The combined patterns appear in the LCD.



- To remove a selected pattern, press  (Cancel/clear key) in the operation panel. The pattern that was selected last is removed.

3 Repeat steps 2.



4 After all of the desired patterns are selected, start sewing.



① Sewing direction

- ▶ The order that the patterns appear in the LCD is the order that they will be sewn.



Note

- When the combined pattern is sewn at least one time, sewing of the combined pattern is temporarily stopped. Typing in the number of a stitch after sewing clears the combined pattern and selects the new stitch, instead of adding the new stitch to the combined pattern.
- If you do not wish to clear the pattern, save it before typing in the number of the new stitch. For details on saving patterns, refer to "Saving patterns" (page 126).

Memo

- Up to 70 patterns can be combined.
- If multiple patterns have been combined, the sewing machine stops once all the selected patterns displayed in the LCD have been sewn. To repeatedly sew the combined pattern, refer to "Repeat sewing patterns".
- The combined pattern can be saved for later use. For details, refer to "Saving patterns" (page 126).

Repeat sewing patterns

To repeatedly sew the combined pattern, follow the procedure described below.

1 Select the pattern.

- For details, refer to “Combining patterns” (page 120).

2 Press (Settings key) in the operation panel.

- The settings screen appears.



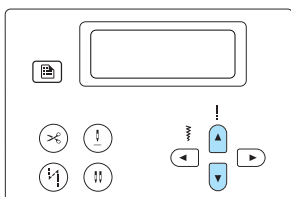

3 Press or (Stitch length keys) until is displayed.



- The screen for specifying repeat sewing appears.



4 Press or (Stitch width keys) to select (repeat sewing).

To return to  (single sewing), press  or  (Stitch width keys).

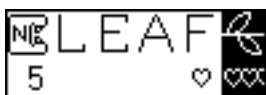
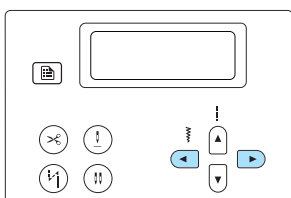

5 Press (OK key) or (Cancel/clear key).

- The initial stitch screen appears again, and the machine is set to repeatedly sew the selected pattern.

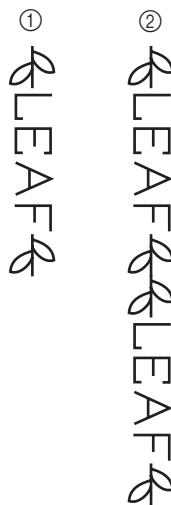

- ① Single
- ② Repeated

Note

- If repeated sewing is set, the pattern is repeatedly sewn until the sewing machine is stopped.
- If the sewing machine is turned off, the repeated/single sewing setting returns to its default setting.

Checking the selected pattern

Up to 70 patterns can be combined. If all of the selected patterns cannot be displayed in the LCD at the same time, the pattern can be checked according to the following procedure.

1 Press (Settings key) in the operation panel.

- The settings screen appears.

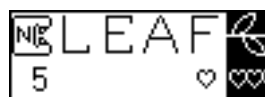

- 2 Press **▲** or **▼** (Stitch length keys) until **√ABC** is displayed.

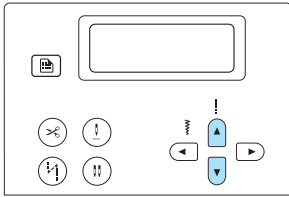

- ▶ The screen for checking the pattern appears.



- 3 Press **◀** or **▶** (Stitch width keys) to scroll through the pattern and check it.

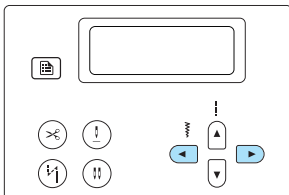

- Press **◀** to scroll through the pattern to the left. If the key is pressed while the leftmost (first) pattern is displayed, a beep sounds.
- Press **▶** to scroll through the pattern to the right. If the key is pressed while only the rightmost (last) pattern is displayed, a beep sounds.

- 4 Press **OK** (OK key) or **↵** (Cancel/clear key).

- ▶ The initial stitch screen appears again.

Changing the pattern size

The size of character stitches in the Gothic font (**A** selected with **Ⓐ**) and outline style (**▣** selected with **Ⓐ**) can be switched between large and small. However, the size of other patterns cannot be changed. For details on the stitch patterns whose size can be changed, refer to "Other stitches" (page 138).

- 1 Select a stitch.
Select a pattern whose size can be changed.

- 2 Press **Ⓔ** (Settings key) in the operation panel.

- ▶ The settings screen appears.



- 3 Press **▲** or **▼** (Stitch length keys) until **Ⓐ** **▣** is displayed.

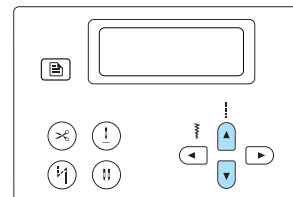

- ▶ The screen for changing the pattern size appears.

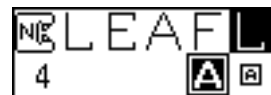

- 4 Press or (Stitch width keys) until the desired size is selected.

Select for the small size or select for the large size.

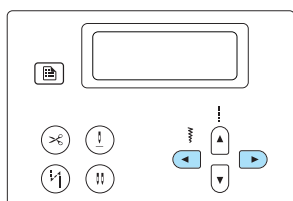

▶ The pattern size is changed.

- 5 Press (OK key) or (Cancel/clear key).

▶ The initial stitch screen appears again.

- 6 Repeat steps 1 through 5.



LEAFLEAF



Memo

- The large pattern size is the default. If the small pattern size is selected, small patterns can be combined and connected.
- If multiple patterns have been combined, the size of each selected pattern can be specified.

Changing the stitch density

If a decorative satin stitch has been selected, the stitch density can be changed.

- 1 Select a decorative satin stitch (No. 53–62 of 1, selected with).



- 2 Press (Settings key) in the operation panel.

▶ The settings screen appears.

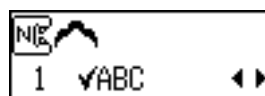

- 3 Press or (Stitch length keys) until is displayed.

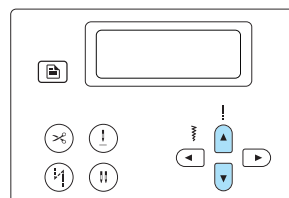

▶ The screen for specifying the stitching density of the decorative satin stitch appears.

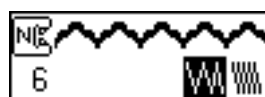

- 4 Press or (Stitch width keys) until the desired density is selected.
Select for sparse stitching or select for compact stitching.

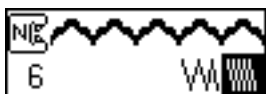
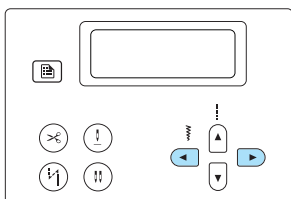

- 5 Press (OK key) or (Cancel/clear key).
▶ The initial stitch screen appears again, and the stitching density is changed.

CAUTION

- If the stitching density is too compacted, depending on the needle, the stitches may be bunched together, causing the needle to break.

Changing the pattern length

The length of one part of a satin stitch can be set to one of five sizes.

- 1 Select a satin stitch (No. 32–47 of 1, selected with).



- 2 Press (Settings key) in the operation panel.
▶ The settings screen appears.



- 3 Press or (Stitch length keys) until is displayed.

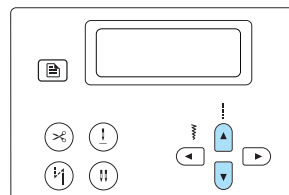

- ▶ The screen for changing the length of a satin stitch appears.



- 4 Press or (Stitch width keys) until the desired ratio is selected.
The length can be set within the range of $\times 1$ and $\times 5$.

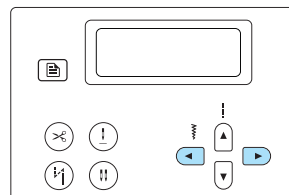

- Press to reduce the length. If the key is pressed while the smallest setting ($\times 1$) is displayed, a beep sounds.
- Press to increase the length. If the key is pressed while the largest setting ($\times 5$) is displayed, a beep sounds.



- ▶ The satin stitch length is changed.

- 5 Press (OK key) or (Cancel/clear key).
▶ The initial stitch screen appears again.



Mirror imaging the pattern

The pattern can be mirror imaged along a vertical axis.

1 Select a stitch.

2 Press  (Settings key) in the operation panel.

▶ The settings screen appears.



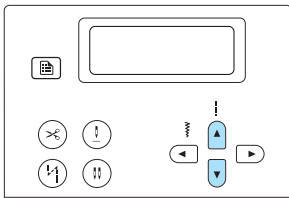

3 Press  or  (Stitch length keys) until  is displayed.



▶ The screen for mirror imaging the pattern appears.



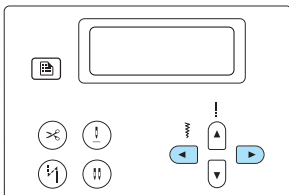

4 Press  or  (Stitch width keys) to select ON.

To return to OFF, press  or  (Stitch width keys).



▶ The pattern is mirror imaged.



5 Press  (OK key) or  (Cancel/clear key).

▶ The initial stitch screen appears again.

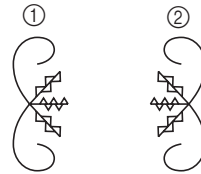

- ① Normal
- ② Mirror-imaged



Memo

- Some of the utility stitches, most of the decorative stitches, and all of the character stitches can be mirror imaged.
- Mirror imaged patterns can also be combined with other patterns.



Saving patterns

Combined patterns can be saved for later use. Since saved patterns are not lost after the sewing machine is turned off, they can be retrieved at any time. This is convenient for patterns, such as names, that will be used often. Utility stitches can also be saved. Up to ten patterns can be saved.

1 Create the combined pattern that you wish to save. Otherwise, display the pattern to be saved.

- For details, refer to “Combining patterns” (page 120).



2 Press (Memory key) in the operation panel.

- The machine enters pattern memory mode, and  appears in the upper-left corner of the screen.



3 Press the numeric key (0 through 9) for the pocket where the pattern is to be saved.

- The saved contents of the pocket for the selected number are displayed.
- If nothing has been saved, nothing appears in the bottom of the screen.



- If the pocket contains a pattern, the pattern is displayed. To leave this pattern in the pocket, select a different pocket.



4 Check the contents, and then press (OK key).

The contents saved in the selected pocket are overwritten.

- “Saving...” appears while the pattern is being saved in the pocket.
- After the pattern is saved, a beep is sounded, and the initial stitch screen appears again.

Note



- Do not turn off the sewing machine while a pattern is being saved, otherwise the pattern data may be lost.

Memo

- The pattern saved in the pocket can be erased by performing the save operation with no pattern selected.

Retrieving a pattern

1 Press (Preset utility stitch/saved pattern key) in the operation panel.

- After  appears in the center of the screen, the machine enters retrieve pattern mode, and  appears in the lower-left corner of the screen.



Memo

- Each time  (Preset utility stitch/saved pattern key) is pressed, the machine switches between the preset utility stitch mode and the saved pattern mode. (For details on the preset utility stitch mode, refer to “Selecting stitch types and patterns” (page 70).

2 Press the numeric key (0 through 9) for the pocket where the pattern is saved.

- ▶ The saved contents of the pocket for the selected number are retrieved.



- If nothing was saved in the selected pocket, a beep is sounded, and the screen displayed before the numeric key was pressed appears again.
- To select a different pocket, use the numeric keys to type in the number of a different pocket.

Memo

- After a decorative stitch or character stitch pattern is retrieved, press (Decorative stitch key) or (Character stitch key) to combine additional patterns with it or edit it.

Realigning the pattern

The pattern may not be sewn correctly, depending on the type of fabric being sewn or the sewing speed. If this occurs, adjust the pattern while sewing on a piece of scrap fabric that is the same as that used for your project.

1 Attach monogramming foot "N".

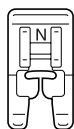

- For details, refer to "Replacing the presser foot" (page 41).

2 Select (No. 31 of 1, selected with).

Press (Decorative stitch key), and then use the numeric keys to type in "31".

- ▶ The pattern alignment stitch is selected.

3 Start sewing.



- ▶ The pattern for making the adjustment is sewn.
- ▶ The sewing machine stops after it has finished sewing the pattern.

4 Check the sewn pattern.

If the part of the pattern indicated in the illustration is sewn uniformly, the pattern is correctly aligned.

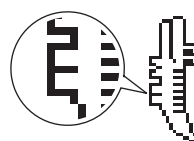

If the pattern is not sewn correctly, follow the steps below to adjust the sewing.

5 Press (Settings key) in the operation panel.

- ▶ The settings screen appears.



6 Press or (Stitch length keys) until is displayed.

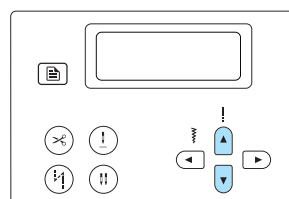

- ▶ The screen for adjusting the pattern appears.



- 7** Press ◀ or ▶ (Stitch width keys).

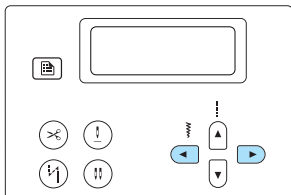

- ▶ Make the necessary adjustments according to how the pattern is sewn.

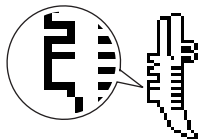

Press ▶ (Stitch width key) to increase the adjustment setting.

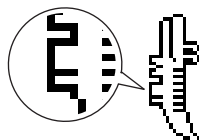

Press ◀ (Stitch width key) to decrease the adjustment setting.



- 8** **Start sewing again, and then check the pattern.**
Continue adjusting the pattern until it is sewn correctly.
- 9** **When the pattern is sewn correctly, press** **OK** (OK key) or **↵** (Cancel/clear key).
- ▶ The initial stitch screen appears again.

Designing a Pattern

With the My Custom Stitch function, you can sew stitch patterns that you design yourself.

Drawing a sketch of the pattern

Prepare a grid sheet set.

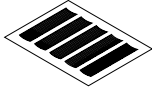

- 1 Draw a sketch of the pattern on the grid sheet set.

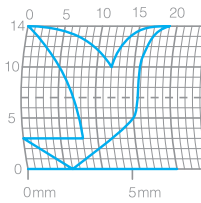

Draw the pattern as one continuous line and with the start point and the end point of the design at the same height.



- 2 If the pattern will be repeated, determine the space between the repeating patterns.

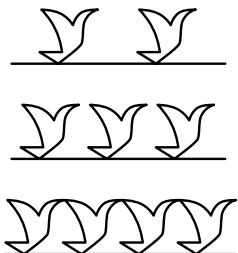
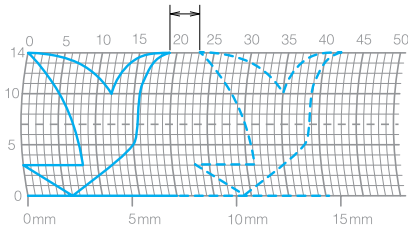

- 3 Mark the points in the pattern that are positioned at intersections in the grid, and then link those points with a continuous straight line.

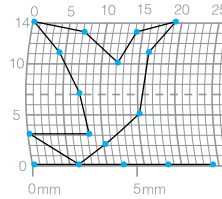

- 4 Determine the sewing order.

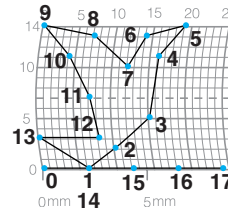

For a more attractive stitch, close the pattern by intersecting the line.

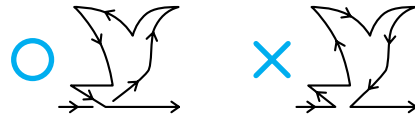

Entering the pattern data

Follow the pattern drawn on the grid sheet and program the pattern into the sewing machine.

1 Attach monogramming foot "N".

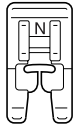

- For details, refer to "Replacing the presser foot" (page 41).

2 Turn on the sewing machine.

3 Select (No. 99 of , selected with).

Press  (Decorative stitch key), and then use the numeric keys to type in "99".





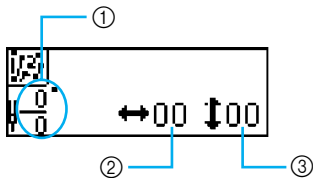

▶ The screen for entering a pattern appears.



- ① Number of the current point/Total number of points
- ② Horizontal coordinate (0-79)
- ③ Vertical coordinate (0-14)

4 Check the grid sheet set, and specify the coordinates of the first point.

Press  and  (Stitch width keys) to select the horizontal coordinate and press  and  (Stitch length keys) to select the vertical coordinate, and then press  (OK key).

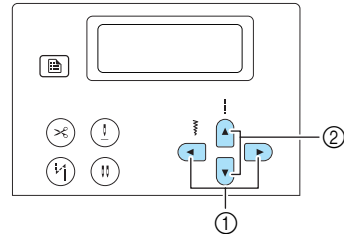

- ① Stitch width keys
- ② Stitch length keys

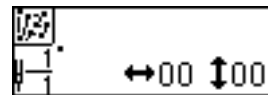



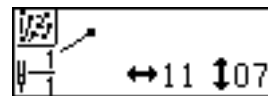

5 Specify the coordinates of the second point, and then press (OK key).



▶ A screen appears, allowing you to specify the settings for the stitching between the two points.

6 Specify whether single stitching or triple stitching will be sewn between the points.

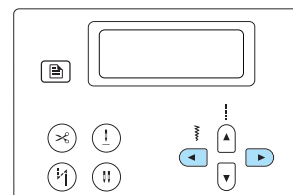

Press  and  (Stitch width keys) to select  for single stitching or  for triple stitching, and then press  (OK key).



▶ A screen for selecting the next operation appears.

- 7 Select , and then press **OK** (OK key).



- If you make a mistake while specifying a point, press **↵** (Cancel/clear key) so that the point changes from  to , and then move (edit) the position of the point.



▶ A screen for specifying the next point appears.

- 8 Repeat steps 5 through 7 to specify each point.

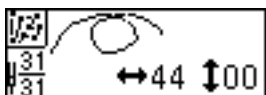

Up to 99 points can be entered.



■ **To edit the position of a point.**

The position of a point can be edited (moved) if **↵** (Cancel/clear key) is pressed while  is displayed in the screen so that the point changes from  to . Each time **↵** (Cancel/clear key) is pressed, the previous point is selected. To select the next point, press **OK** (OK key).

■ **To delete a point**

The last point can be deleted by pressing **0** (0 key) while a point appears as  in the screen where  is displayed. Each press of the key deletes the last point in the pattern.

- 9 After all points in the pattern have been specified, select  in the screen that appears in step 7, and then press **OK** (OK key).

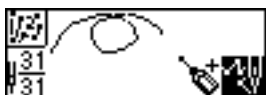

▶ The sewing screen appears.

- 10 Specify the various stitching settings, such as reverse/reinforcement stitching, in the same way as with other stitches.



- With this screen displayed, pressing **↵** (Cancel/clear key) displays the screen where points can be edited so that points can be added or removed.



Memo

- To save the entered pattern data, save it from the sewing screen. For details, refer to “Saving patterns” (page 126).
- The pattern in the LCD will appear different from the pattern drawn in the grid sheet set and the actual sewn stitch. Also, refer to these when entering the design.

Examples of designs

Enter each of the points indicated in the table to sew the sample stitch.

					
Point	↔	↑↓	Point	↔	↑↓
0	0	0	20	38	13
1	12	0	21	35	14
2	18	3	22	32	13
3	22	6	23	30	10
4	23	10	24	32	6
5	21	13	25	35	3
6	17	14	26	41	0
7	14	13	27	45	0
8	12	11	28	47	4
9	9	13	29	44	7
10	6	14	30	45	11
11	3	13	31	47	13
12	1	10	32	50	14
13	3	6	33	54	13
14	6	3	34	56	10
15	12	0	35	55	6
16	41	0	36	51	3
17	43	4	37	45	0
18	40	7	38	70	0
19	41	11			

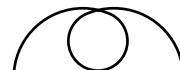
					
Point	↔	↑↓	Point	↔	↑↓
0	0	0	20	16	10
1	3	5	21	18	12
2	5	8	22	21	13
3	8	11	23	25	14
4	12	13	24	28	14
5	17	14	25	33	13
6	20	14	26	37	11
7	24	13	27	41	8
8	27	12	28	43	5
9	29	11	29	44	0
10	31	9			
11	32	6			
12	30	3			
13	27	1			
14	24	0			
15	21	0			
16	18	1			
17	16	3			
18	15	5			
19	15	8			

					
Point	↔	↑↓	Point	↔	↑↓
0	0	0	20	10	11
1	30	0	21	12	10
2	32	1	22	8	9
3	32	7	23	12	8
4	32	10	24	7	6
5	33	12	25	12	6
6	35	11	26	6	3
7	35	8	27	10	2
8	37	12	28	5	0
9	35	14	29	10	2
10	32	14	30	16	1
11	30	11	31	19	0
12	30	5	32	23	0
13	29	3	33	22	6
14	26	8	34	17	10
15	24	10	35	22	6
16	18	13	36	23	0
17	13	14	37	19	0
18	12	14	38	42	0
19	13	12			

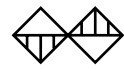
					
Point	↔	↑↓	Point	↔	↑↓
0	0	7	20	20	11
1	5	7	21	21	7
2	4	3	22	24	7
3	5	7	23	23	14
4	8	7	24	24	7
5	7	0	25	27	7
6	8	7	26	27	11
7	11	7	27	27	7
8	11	3	28	32	7
9	11	7	29	27	11
10	16	7	30	23	14
11	11	3	31	20	11
12	7	0	32	16	7
13	4	3	33	20	3
14	0	7	34	23	0
15	4	11	35	27	3
16	7	14	36	32	7
17	11	11			
18	16	7			
19	21	7			



4 APPENDIX















The various maintenance and troubleshooting procedures are described in this chapter.













- Stitch Settings..... 134**
 - Utility stitches 134
 - Other stitches..... 138
- Care and Maintenance 142**
 - Cleaning the machine surface..... 142
 - Cleaning the race 142
- Troubleshooting 144**
 - Error messages 148
 - Nothing appears in the LCD 149
 - Operation beep 149
 - Cancelling the operation beep..... 149
- Index 151**



















Stitch Settings



















Applications, stitch lengths and widths and whether the twin needle can be used are listed for utility stitches in the following table.

Utility stitches

Stitch Name	Pattern 	Presser Foot	Application	Stitch Width [mm (inch)]		Stitch Length [mm (inch)]		Twin Needle	Reverse/Reinforcement Stitching	Programmed Thread-Cutting	Walking Foot	
				Auto	Manual	Auto	Manual					
Straight stitch	Left 	01	J	Basic stitching, sewing gathers or pintucks, etc.	0.0 (0)	0.0–7.0 (0–1/4)	2.5 (3/32)	0.2–5.0 (1/64–3/16)	Yes (J)	Reverse	Reverse + thread-cutting	No
		02	J	Basic stitching and sewing gathers or pintucks	0.0 (0)	0.0–7.0 (0–1/4)	2.5 (3/32)	0.2–5.0 (1/64–3/16)	Yes (J)	Reinforcement	Reinforcement + thread-cutting	Yes
	Center 	J/I	Attaching zippers, basic stitching, sewing gathers or pintucks, etc.	3.5 (1/8)	0.0–7.0 (0–1/4)	2.5 (3/32)	0.2–5.0 (1/64–3/16)	Yes (J)	Reverse	Reverse + thread-cutting	No	
Triple stretch stitch		J	Attaching sleeves, sewing inseams, sewing stretch fabrics and decorative stitching	0.0 (0)	0.0–7.0 (0–1/4)	2.5 (3/32)	1.5–4.0 (1/16–3/16)	Yes (J)	Reinforcement	Reinforcement + thread-cutting	No	
Stretch stitch		J	Sewing stretch fabrics and decorative stitching	1.0 (1/16)	1.0–3.0 (1/16–1/8)	2.5 (3/32)	1.0–4.0 (1/16–3/16)	Yes (J)	Reinforcement	Reinforcement + thread-cutting	No	
Basting stitch		J	Temporarily securing	0.0 (0)	0.0–7.0 (0–1/4)	–	–	No	Reinforcement	Reinforcement + thread-cutting	No	
Zigzag stitch	Center 	J	Overcasting and attaching appliques	3.5 (1/8)	0.0–7.0 (0–1/4)	1.4 (1/16)	0.0–4.0 (0–3/16)	Yes (J)	Reverse	Reverse + thread-cutting	No	
	Right 	J	Beginning sewing from the right needle position	3.5 (1/8)	2.5–5.0 (3/32–3/16)	1.4 (1/16)	0.3–4.0 (1/64–3/16)	Yes (J)	Reinforcement	Reinforcement + thread-cutting	Yes	
2-point zigzag stitch		J	Overcasting on medium weight or stretch fabrics, attaching elastic, darning, etc.	5.0 (3/16)	1.5–7.0 (1/16–1/4)	1.0 (1/16)	0.2–4.0 (1/64–3/16)	Yes (J)	Reinforcement	Reinforcement + thread-cutting	Yes	
3-point zigzag stitch		J	Overcasting on medium weight or stretch fabrics, attaching elastic, darning, etc.	5.0 (3/16)	1.5–7.0 (1/16–1/4)	1.0 (1/16)	0.2–4.0 (1/64–3/16)	Yes (J)	Reinforcement	Reinforcement + thread-cutting	No	
Overcasting stitch		G	Overcasting on thin or medium weight fabrics	3.5 (1/8)	2.5–5.0 (3/32–3/16)	2.0 (1/16)	1.0–4.0 (1/16–3/16)	No	Reinforcement	Reinforcement + thread-cutting	No	
		G	Overcasting on thick fabrics	5.0 (3/16)	2.5–5.0 (3/32–3/16)	2.5 (3/32)	1.0–4.0 (1/16–3/16)	No	Reinforcement	Reinforcement + thread-cutting	No	
		G	Preventing fraying in thick fabrics and fabrics that fray easily	5.0 (3/16)	3.5–5.0 (1/8–3/16)	2.5 (3/32)	1.0–4.0 (1/16–3/16)	No	Reinforcement	Reinforcement + thread-cutting	No	
		J	Overcasting on stretch fabrics	5.0 (3/16)	0.0–7.0 (0–1/4)	2.5 (3/32)	0.5–4.0 (1/32–3/16)	Yes (J)	Reinforcement	Reinforcement + thread-cutting	No	
		J	Overcasting on thick or stretch fabrics	5.0 (3/16)	0.0–7.0 (0–1/4)	2.5 (3/32)	0.5–4.0 (1/32–3/16)	Yes (J)	Reinforcement	Reinforcement + thread-cutting	No	

Stitch Name	Pattern 	Presser Foot	Application	Stitch Width [mm (inch)]		Stitch Length [mm (inch)]		Twin Needle	Reverse/ Reinforcement Stitching	Programmed Thread-Cutting	Walking Foot
				Auto	Manual	Auto	Manual				
Overcasting stitch	16 	J	Overcasting on stretch fabrics and decorative stitching	4.0 (3/16)	0.0–7.0 (0–1/4)	4.0 (3/16)	1.0–4.0 (1/16–3/16)	Yes (J)	Reinforcement	Reinforcement + thread-cutting	No
Blind hem stitch	17 	R	Blind hem stitching on medium weight fabrics	00 (0)	3← – 3→	2.0 (1/16)	1.0–3.5 (1/16–1/8)	No	Reinforcement	Reinforcement + thread-cutting	No
	18 	R	Blind hem stitching on stretch fabrics	00 (0)	3← – 3→	2.0 (1/16)	1.0–3.5 (1/16–1/8)	No	Reinforcement	Reinforcement + thread-cutting	No
Appliqué stitch	19 	J	Appliqué stitching	3.5 (1/8)	2.5–7.0 (3/32–1/4)	2.5 (3/32)	1.6–4.0 (1/16–3/16)	Yes (J)	Reinforcement	Reinforcement + thread-cutting	No
Shell tuck stitch	20 	J	Shell tuck stitching	4.0 (3/16)	0.0–7.0 (0–1/4)	2.5 (3/32)	0.2–4.0 (1/64–3/16)	Yes (J)	Reinforcement	Reinforcement + thread-cutting	No
Piecing straight stitch	21 	J	Piecing straight stitching (with a seam allowance of 6.5 mm(1/4 inch) from the right edge of the presser foot)	5.5 (7/32)	0.0–7.0 (0–1/4)	2.0 (1/16)	0.2–5.0 (1/64–3/16)	No	Reinforcement	Reinforcement + thread-cutting	No
	22 	J	Piecing straight stitching (with a seam allowance of 6.5 mm(1/4 inch) from the left edge of the presser foot)	1.5 (1/16)	0.0–7.0 (0–1/4)	2.0 (1/16)	0.2–5.0 (1/64–3/16)	No	Reinforcement	Reinforcement + thread-cutting	Yes
Straight stitch that looks hand-sewn (for quilting)	23 	J	Straight stitch quilting that looks hand-sewn	0.0 (0)	0.0–7.0 (0–1/4)	2.5 (3/32)	1.0–4.0 (1/16–3/16)	No	Reinforcement	Reinforcement + thread-cutting	No
Zigzag stitch (for quilting)	24 	J	Appliqué quilting, free-motion quilting, satin stitching	3.5 (1/8)	0.0–7.0 (0–1/4)	1.4 (1/16)	0.0–4.0 (0–3/16)	No	Reinforcement	Reinforcement + thread-cutting	Yes
Appliqué stitch (for quilting)	25 	J	Attaching appliqués and binding	1.5 (1/16)	0.5–5.0 (1/32–3/16)	1.8 (1/16)	1.0–4.0 (1/16–3/16)	No	Reinforcement	Reinforcement + thread-cutting	No
Quilting stitch (for stippling)	26 	J	Quilting background stitching (stippling)	7.0 (1/4)	1.0–7.0 (1/16–1/4)	1.6 (1/16)	1.0–4.0 (1/16–3/16)	No	Reinforcement	Reinforcement + thread-cutting	No
Satin scallop stitch	27 	N	Scallop stitching	5.0 (3/16)	2.5–7.0 (3/32–1/4)	0.5 (1/32)	0.1–1.0 (1/64–1/16)	Yes (J)	Reinforcement	Reinforcement + thread-cutting	No
Joining stitch	28 	J	Patchwork stitching and decorative stitching	4.0 (3/16)	0.0–7.0 (0–1/4)	1.2 (1/16)	0.2–4.0 (1/64–3/16)	Yes (J)	Reinforcement	Reinforcement + thread-cutting	No
	29 	J	Patchwork stitching, decorative stitching and sewing overcasting on both pieces of fabric, such as with tricot	5.0 (3/16)	2.5–7.0 (3/32–1/4)	2.5 (3/32)	1.0–4.0 (1/16–3/16)	Yes (J)	Reinforcement	Reinforcement + thread-cutting	No
	30 	J	Patchwork stitching and decorative stitching	5.0 (3/16)	0.0–7.0 (0–1/4)	1.2 (1/16)	0.2–4.0 (1/64–3/16)	Yes (J)	Reinforcement	Reinforcement + thread-cutting	No
Smocking stitch	31 	J	Smocking stitching and decorative stitching	5.0 (3/16)	0.0–7.0 (0–1/4)	1.6 (1/16)	1.0–4.0 (1/16–3/16)	Yes (J)	Reinforcement	Reinforcement + thread-cutting	No

Stitch Name	Pattern 	Presser Foot	Application	Stitch Width [mm (inch)]		Stitch Length [mm (inch)]		Twin Needle	Reverse/ Reinforcing Stitching	Programmed Thread-Cutting	Walking Foot
				Auto	Manual	Auto	Manual				
Fagoting stitch		J	Fagoting and decorative stitching	5.0 (3/16)	0.0–7.0 (0–1/4)	2.5 (3/32)	1.0–4.0 (1/16–3/16)	Yes (J)	Reinforcement	Reinforcement + thread-cutting	No
		J	Fagoting and decorative stitching	5.0 (3/16)	2.5–7.0 (3/32–1/4)	2.5 (3/32)	1.0–4.0 (1/16–3/16)	Yes (J)	Reinforcement	Reinforcement + thread-cutting	No
Elastic-attaching stitch		J	Attaching elastic to stretch fabrics	4.0 (3/16)	0.0–7.0 (0–1/4)	1.0 (1/16)	0.2–4.0 (1/64–3/16)	Yes (J)	Reinforcement	Reinforcement + thread-cutting	No
Ladder stitch		J	Decorative stitching	4.0 (3/16)	0.0–7.0 (0–1/4)	3.0 (1/8)	2.0–4.0 (1/16–3/16)	No	Reinforcement	Reinforcement + thread-cutting	No
Rick-rack stitch		J	Decorative stitching	4.0 (3/16)	0.0–7.0 (0–1/4)	2.5 (3/32)	1.0–4.0 (1/16–3/16)	Yes (J)	Yes (J)	Reinforcement + thread-cutting	No
Decorative stitch		J	Decorative stitching	5.5 (7/32)	0.0–7.0 (0–1/4)	1.6 (1/16)	1.0–4.0 (1/16–3/16)	Yes (J)	Yes (J)	Reinforcement + thread-cutting	No
Serpentine stitch		N	Decorative stitching and elastic-attaching	5.0 (3/16)	1.5–7.0 (1/16–1/4)	1.0 (1/16)	0.2–4.0 (1/64–3/16)	Yes (J)	Yes (J)	Reinforcement + thread-cutting	No
Hem-stitching		N	Lace sewing, decorative hemming, heirloom stitching, etc.	3.5 (1/8)	1.5–7.0 (1/16–1/4)	2.5 (3/32)	1.6–4.0 (1/16–3/16)	No	Reinforcement	Reinforcement + thread-cutting	No
		N	Decorative hemming, heirloom stitching, etc.	6.0 (15/64)	1.5–7.0 (1/16–1/4)	3.0 (1/8)	1.5–4.0 (1/16–3/16)	No	Reinforcement	Reinforcement + thread-cutting	No
		N	Decorative hemming on thin, medium weight and plain weave fabrics, heirloom stitching, etc.	5.0 (3/16)	1.5–7.0 (1/16–1/4)	3.5 (1/8)	1.5–4.0 (1/16–3/16)	No	Reinforcement	Reinforcement + thread-cutting	No
		N	Decorative hemming on thin, medium weight and plain weave fabrics, heirloom stitching, etc.	5.0 (3/16)	1.5–7.0 (1/16–1/4)	4.0 (3/16)	1.5–4.0 (1/16–3/16)	No	Reinforcement	Reinforcement + thread-cutting	No
		N	Decorative hemming on thin, medium weight and plain weave fabrics, heirloom stitching, etc.	5.0 (3/16)	1.5–7.0 (1/16–1/4)	2.5 (3/32)	1.5–4.0 (1/16–3/16)	No	Reinforcement	Reinforcement + thread-cutting	No
		N	Decorative hemming on thin, medium weight and plain weave fabrics, heirloom stitching, etc.	5.0 (3/16)	1.5–7.0 (1/16–1/4)	2.0 (1/16)	1.5–4.0 (1/16–3/16)	No	Reinforcement	Reinforcement + thread-cutting	No
		N	Decorative hemming, ribbon threading, heirloom stitching, etc.	5.0 (3/16)	1.5–7.0 (1/16–1/4)	3.0 (1/8)	1.5–4.0 (1/16–3/16)	No	Reinforcement	Reinforcement + thread-cutting	No
		N	Decorative stitching, smocking stitching, heirloom stitching, etc.	6.0 (15/64)	1.5–7.0 (1/16–1/4)	1.6 (1/16)	1.0–4.0 (1/16–3/16)	No	Reinforcement	Reinforcement + thread-cutting	No
Buttonhole stitch		N	Decorative stitching, smocking stitching, heirloom stitching, etc.	5.0 (3/16)	1.5–7.0 (1/16–1/4)	1.6 (1/16)	1.0–4.0 (1/16–3/16)	No	Reinforcement	Reinforcement + thread-cutting	No
		A	Horizontal buttonholes on thin and medium weight fabrics	5.0 (3/16)	3.0–5.0 (1/8–3/16)	0.4 (1/64)	0.2–1.0 (1/64–1/16)	No	Automatic reinforcement	Thread-cutting	No
		A	Horizontal buttonholes on areas that are subject to strain	5.0 (3/16)	3.0–5.0 (1/8–3/16)	0.4 (1/64)	0.2–1.0 (1/64–1/16)	No	Automatic reinforcement	Thread-cutting	No

Stitch Name	Pattern 	Presser Foot	Application	Stitch Width [mm (inch)]		Stitch Length [mm (inch)]		Twin Needle	Reverse/Reinforcing Stitching	Programmed Thread-Cutting	Walking Foot
				Auto	Manual	Auto	Manual				
Buttonhole stitch		A	Horizontal buttonholes on thick fabrics	5.0 (3/16)	3.0–5.0 (1/8–3/16)	0.4 (1/64)	0.2–1.0 (1/64–1/16)	No	Automatic reinforcement	Thread-cutting	No
		A	Secured buttonholes for fabrics that have backings	5.0 (3/16)	3.0–5.0 (1/8–3/16)	0.4 (1/64)	0.2–1.0 (1/64–1/16)	No	Automatic reinforcement	Thread-cutting	No
		A	Buttonholes for stretch or knit fabrics	6.0 (15/64)	3.0–6.0 (1/8–15/64)	1.0 (1/16)	0.5–2.0 (1/32–1/16)	No	Automatic reinforcement	Thread-cutting	No
		A	Buttonholes for stretch fabrics	6.0 (15/64)	3.0–6.0 (1/8–15/64)	1.5 (1/16)	1.0–3.0 (1/16–1/8)	No	Automatic reinforcement	Thread-cutting	No
		A	Bound buttonholes	5.0 (3/16)	0.0–6.0 (0–15/64)	2.0 (1/16)	0.2–4.0 (1/64–3/16)	No	Automatic reinforcement	Thread-cutting	No
		A	Keyhole buttonholes for thick or furry fabrics	7.0 (1/4)	3.0–7.0 (1/8–1/4)	0.5 (1/32)	0.3–1.0 (1/64–1/16)	No	Automatic reinforcement	Thread-cutting	No
		A	Keyhole buttonholes for medium weight and thick fabrics	7.0 (1/4)	3.0–7.0 (1/8–1/4)	0.5 (1/32)	0.3–1.0 (1/64–1/16)	No	Automatic reinforcement	Thread-cutting	No
		A	Horizontal buttonholes for thick or furry fabrics	7.0 (1/4)	3.0–7.0 (1/8–1/4)	0.5 (1/32)	0.3–1.0 (1/64–1/16)	No	Automatic reinforcement	Thread-cutting	No
Darning stitch		A	Darning medium weight fabrics	7.0 (1/4)	2.5–7.0 (3/32–1/4)	2.0 (1/16)	0.4–2.5 (1/64–3/32)	No	Automatic reinforcement	Thread-cutting	No
		A	Darning thick fabrics	7.0 (1/4)	2.5–7.0 (3/32–1/4)	2.0 (1/16)	0.4–2.5 (1/64–3/32)	No	Automatic reinforcement	Thread-cutting	No
Bar tack stitch		A	Reinforcing openings and areas where the seam easily comes loose	2.0 (1/16)	1.0–3.0 (1/16–1/8)	0.4 (1/64)	0.3–1.0 (1/64–1/16)	No	Automatic reinforcement	Thread-cutting	No
Button-sewing stitch		M	Button sewing	3.5 (1/8)	2.5–4.5 (3/32–3/16)	–	–	No	Automatic reinforcement	Reinforcement + thread-cutting	No
Eyelet stitch		N	Sewing eyelets, for example, on belts	7.0 (1/4)	7.0, 6.0, 5.0 (1/4, 15/64, 3/16)	7.0 (1/4)	7.0, 6.0, 5.0 (1/4, 15/64, 3/16)	No	Automatic reinforcement	Thread-cutting	No
Side cutter		S	Sewing straight stitches while cutting the fabric	0.0 (0)	0.0–2.5 (0–3/32)	2.5 (3/32)	0.2–5.0 (1/64–3/16)	No	Reinforcement	Reinforcement + thread-cutting	No
		S	Sewing zigzag stitches while cutting the fabric	3.5 (1/8)	3.5–5.0 (1/8–3/16)	1.4 (1/16)	0.0–4.0 (0–3/16)	No	Reinforcement	Reinforcement + thread-cutting	No
		S	Overcasting on thin and medium weight fabrics while cutting the fabric	3.5 (1/8)	3.5–5.0 (1/8–3/16)	2.0 (1/16)	1.0–4.0 (1/16–3/16)	No	Reinforcement	Reinforcement + thread-cutting	No
		S	Overcasting on thick fabrics while cutting the fabric	5.0 (3/16)	3.5–5.0 (1/8–3/16)	2.5 (3/32)	1.0–4.0 (1/16–3/16)	No	Reinforcement	Reinforcement + thread-cutting	No
		S	Overcasting on medium weight and thick fabrics while cutting the fabric	5.0 (3/16)	3.5–5.0 (1/8–3/16)	2.5 (3/32)	1.0–4.0 (1/16–3/16)	No	Reinforcement	Reinforcement + thread-cutting	No



Other stitches

Stitch Type	Pattern										Presser Foot	Twin Needle	Pattern Size	Adjustable Stitching Density	Adjustable Pattern Length/width	Left/Right Flipping
	01	02	03	04	05	06	07	08	09	10						
Decorative stitches	11	12	13	14	15	16	17	18	19	20	N	No	Large	No	Yes	Yes
	21	22	23	24	25	26	27	28	29	30						
	31*															
Satin stitches	32	33	34	35	36	37	38	39	40	41	N	Yes (J)	Large	No	Yes	Yes
	42	43	44	45	46	47										
Cross-stitches	48	49	50	51	52						N	No	Large	No	Yes	Yes
Decorative satin stitches	53	54	55	56	57	58	59	60	61	62	N	No	Large	Yes	Yes	Yes

* Pattern for making adjustment



Memo



- To select , press  (Decorative stitch key) once.



Stitch Type	Pattern										Presser Foot	Twin Needle	Pattern Size	Adjustable Stitching Density	Adjustable Pattern Length/width	Left/Right Flipping	
	01	02	03	04	05	06	07	11	12	13							
Utility decorative stitches	16	17	18*	20	21	22	23	24	25	26	J**	Yes (*Not possible) (j)	No	No	Yes	No	
	27*	28	29														
	08	09	10														G**
	14	15									R**	No					No
	19*	30*	31	32	33	34	35	36	37	38	N	No (*Not impossible)	No	No	Yes	Yes	
	39																

** Use monogramming foot "N" when combined with other pattern



Memo



- To select , press  (Decorative stitch key) twice.

Stitch Type	Pattern										Presser Foot	Twin Needle	Pattern Size	Adjustable Stitching Density	Adjustable Pattern Length/width	Left/Right Flipping
	 															
Character stitches (Gothic font)	01	02	03	04	05	06	07	08	09	10	N	No	Large, Small	No	No	Yes
	A	B	C	D	E	F	G	H	I	J						
	11	12	13	14	15	16	17	18	19	20						
	K	L	M	N	O	P	Q	R	S	T						
	21	22	23	24	25	26	27	28	29	30						
	U	V	W	X	Y	Z	&	?	!	_						
31	32	33	34	35	36	37	38	39	40							
0	1	2	3	4	5	6	7	8	9							
41	42	43	44	45	46	47	48	49	50							
'	,	.	()	-	Ä	Å	Æ	Ñ							
51	52	53	54	55												
Ö	Ø	Ç	Ü	ß												





Memo



- To select  (Gothic font), press  (Character stitch key) once.

Stitch Type	Pattern										Presser Foot	Twin Needle	Pattern Size	Adjustable Stitching Density	Adjustable Pattern Length/width	Left/Right Flipping
	 															
Character stitches (Script font)	01	02	03	04	05	06	07	08	09	10	N	No	Large	No	No	Yes
	<i>A</i>	<i>B</i>	<i>C</i>	<i>D</i>	<i>E</i>	<i>F</i>	<i>G</i>	<i>H</i>	<i>I</i>	<i>J</i>						
	11	12	13	14	15	16	17	18	19	20						
	<i>K</i>	<i>L</i>	<i>M</i>	<i>N</i>	<i>O</i>	<i>P</i>	<i>Q</i>	<i>R</i>	<i>S</i>	<i>T</i>						
	21	22	23	24	25	26	27	28	29	30						
	<i>U</i>	<i>V</i>	<i>W</i>	<i>X</i>	<i>Y</i>	<i>Z</i>	<i>&</i>	<i>?</i>	<i>!</i>	<i>_</i>						
31	32	33	34	35	36	37	38	39	40							
<i>0</i>	<i>1</i>	<i>2</i>	<i>3</i>	<i>4</i>	<i>5</i>	<i>6</i>	<i>7</i>	<i>8</i>	<i>9</i>							
41	42	43	44	45	46	47	48	49	50							
<i>'</i>	<i>,</i>	<i>.</i>	<i>(</i>	<i>)</i>	<i>-</i>	<i>Ä</i>	<i>Å</i>	<i>Æ</i>	<i>Ñ</i>							
51	52	53	54	55												
<i>Ö</i>	<i>Ø</i>	<i>Ç</i>	<i>Ü</i>	<i>ß</i>												



Memo

- To select  (Script font), press  (Character stitch key) twice.

Stitch Type	Pattern										Presser Foot	Twin Needle	Pattern Size	Adjustable Stitching Density	Adjustable Pattern Length/width	Left/Right Flipping
	 															
Character stitches (Outline style)	01	02	03	04	05	06	07	08	09	10	N	No	Large, Small	No	No	Yes
	A	B	C	D	E	F	G	H	I	J						
	11	12	13	14	15	16	17	18	19	20						
	K	L	M	N	O	P	Q	R	S	T						
	21	22	23	24	25	26	27	28	29	30						
	U	V	W	X	Y	Z	&	?	!	—						
31	32	33	34	35	36	37	38	39	40							
0	1	2	3	4	5	6	7	8	9							
41	42	43	44	45	46	47	48	49	50							
'	,	.	()	-	Ä	À	Æ	Ñ							
51	52	53	54	55												
ö	ø	ç	ü	ß												



Memo

- To select  (Outline style), press  (Character stitch key) three times.

Care and Maintenance

Simple sewing machine maintenance operations are described below.

Cleaning the machine surface

If the surface of the machine is dirty, lightly soak a cloth in neutral detergent, squeeze it out firmly, and then wipe the surface of the machine. After cleaning it once with a wet cloth, wipe it again with a dry cloth.

CAUTION

- Unplug the power cord before cleaning the machine, otherwise injuries or an electric shock may occur.

Cleaning the race

Sewing performance will suffer if dust collects in the bobbin case; therefore, it should be cleaned periodically.

- 1 Turn off the sewing machine.

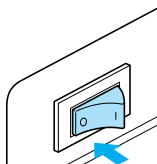

- 2 Unplug the power cord from the power supply jack on the right side of the sewing machine.

CAUTION

- Unplug the power cord before cleaning the machine, otherwise injuries or an electric shock may occur.

- 3 Remove the flat bed attachment.

- 4 Remove the needle plate cover. The needle plate cover is removed differently depending on the model.

- If there is a screw in the needle plate cover

- 1 Use the disc-shaped screwdriver to remove the screw in the needle plate cover.

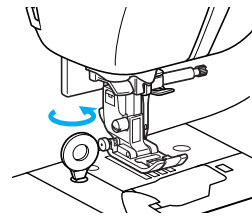

- 2 Grasp both sides of the needle plate cover, and then slide it toward you.

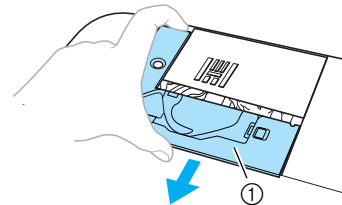

① Needle plate cover

▶ The needle plate cover is removed.

- If there is no screw in the needle plate cover

- 1 Grasp both sides of the needle plate cover, and then slide it toward you.

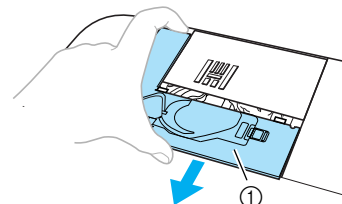

① Needle plate cover

▶ The needle plate cover is removed.

- 5 Remove the bobbin case.**
Grasp the bobbin case, and then pull it out.

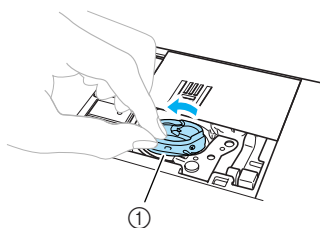

① Bobbin case

- 6 Use the cleaning brush or a vacuum cleaner to remove any lint and dust from the race and its surrounding area.**

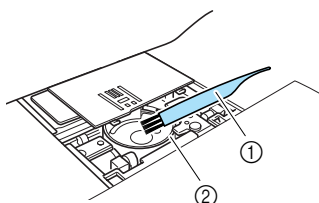

① Cleaning brush
② Race

- Do not apply oil to the bobbin case.

- 7 Insert the bobbin case so that the projection on the bobbin case aligns with the spring.**

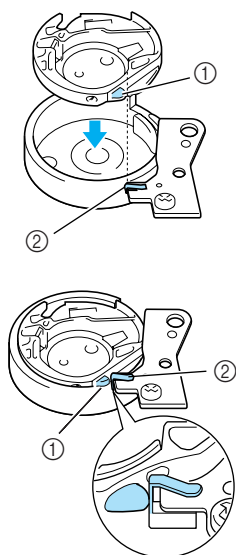

① Projection
② Spring

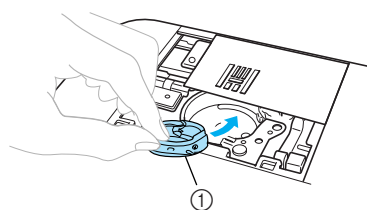

① Bobbin case

- 8 Install the needle plate cover.**
The needle plate cover is installed differently depending on the model.

- If there is a screw in the needle plate cover

- 1** Insert the tabs on the needle plate cover into the needle plate, and then slide the cover back on.

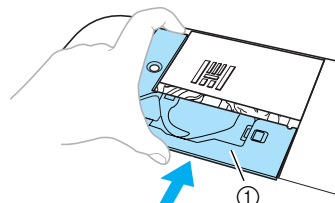

① Needle plate cover

- 2** Use the disc-shaped screwdriver to tighten the screw in the needle plate cover.

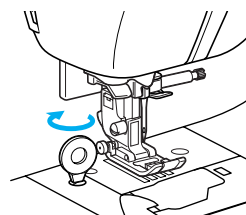

- If there is no screw in the needle plate cover

- 1** Insert the tabs on the needle plate cover into the needle plate, and then slide the cover back on.

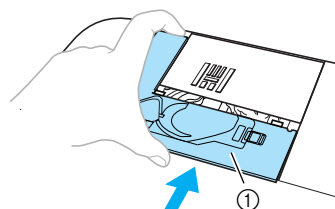

① Needle plate cover

- 9** Install the flat bed attachment in its original position.

! CAUTION

- Never use a bobbin case that is scratched, otherwise the upper thread may become tangled, the needle may break or sewing performance may suffer. For a new bobbin case (part code: XC3153-151), contact your nearest authorized service center.
- Be sure that the bobbin case is correctly installed, otherwise the needle may break.

Troubleshooting

If the machine stops operating correctly, check the following possible problems before requesting service. If the problem persists, contact your dealer or the nearest authorized service center.



Symptom	Probable Cause	Remedy	Reference
The sewing machine does not operate.	The machine is not turned on.	Turn on the machine.	page 17
	The "Start/Stop" button was not pressed.	Press the "Start/Stop" button.	page 52
	The presser foot lever is raised.	Lower the presser foot lever.	–
	The "Start/Stop" button was pressed, even though the foot controller is connected.	Do not use the "Start/Stop" button when the foot controller is connected. To use the "Start/Stop" button, disconnect the foot controller.	page 52
The needle breaks.	The needle is incorrectly installed.	Correctly install the needle.	page 39
	The needle clamp screw is loose.	Use the screwdriver to firmly tighten the screw.	
	The needle is bent or blunt.	Replace the needle.	
	The combination of fabric, thread and needle is not correct.	Select a thread and needle that are appropriate for the type of fabric being sewn.	page 38
	The presser foot that is used is not appropriate for the type of stitch that you wish to sew.	Attach the presser foot that is appropriate for the type of stitch that you wish to sew.	page 134
	The upper thread tension is too tight.	Loosen the upper thread tension.	page 57
	The fabric is pulled too much.	Lightly guide the fabric.	–
	The spool is incorrectly installed.	Correctly install the spool.	page 28
	The area around the hole in the needle plate is scratched, or has a burr on it.	Replace the needle plate. Contact your dealer or the nearest authorized service center.	–
	The area around the hole in the presser foot is scratched, or has a burr on it.	Replace the presser foot. Contact your dealer or the nearest authorized service center.	–
	The bobbin case is scratched, or has a burr on it.	Replace the bobbin case. Contact your dealer or the nearest authorized service center.	–
	A bobbin designed specifically for this machine is not used.	Incorrect bobbins will not work properly. Only use a bobbin designed specifically for this machine.	page 22















Symptom	Probable Cause	Remedy	Reference
The upper thread breaks.	The upper thread was not threaded correctly (for example, the spool is not installed correctly, the spool cap is too big for the spool being used, or the thread has come out of the needle bar thread guide).	Correct the upper threading.	page 28
	There are knots or tangles in the thread.	Remove any knots or tangles.	–
	The selected needle is not appropriate for the thread being used.	Select a needle that is appropriate for the type of thread being used.	page 38
	The upper thread tension is too tight.	Loosen the upper thread tension.	page 57
	The thread is tangled, for example, in the bobbin case.	Remove the tangle thread. If the thread is tangled in the bobbin case, clean the race.	page 142
	The needle is bent or blunt.	Replace the needle.	page 39
	The needle is incorrectly installed.	Correctly install the needle.	
	The area around the hole in the needle plate is scratched, or has a burr on it.	Replace the needle plate. Contact your dealer or the nearest authorized service center.	–
	The area around the hole in the presser foot is scratched, or has a burr on it.	Replace the presser foot. Contact your dealer or the nearest authorized service center.	–
	The bobbin case is scratched, or has a burr on it.	Replace the bobbin case. Contact your dealer or the nearest authorized service center.	–
A bobbin designed specifically for this machine is not used.	Incorrect bobbins will not work properly. Only use a bobbin designed specifically for this machine.	page 22	
The lower thread is tangled or breaks.	The bobbin thread is incorrectly installed.	Correctly install the bobbin thread.	page 26
	The bobbin is scratched or does not rotate smoothly, or has a burr on it.	Replace the bobbin.	–
	The thread is tangled.	Remove the tangled thread and clean the race.	page 142
	A bobbin designed specifically for this machine is not used.	Incorrect bobbins will not work properly. Only use a bobbin designed specifically for this machine.	page 22

Symptom	Probable Cause	Remedy	Reference
The thread tension is incorrect.	The upper thread was not threaded correctly.	Correct the upper threading.	page 28
	The bobbin thread is incorrectly installed.	Correctly install the bobbin thread.	page 26
	The combination of fabric, thread and needle is not correct.	Select a thread and needle that are appropriate for the type of fabric being sewn.	page 38
	The presser foot holder is incorrectly installed.	Correctly install the presser foot holder.	page 43
	The thread tension is incorrect.	Adjust the tension of the upper thread.	page 57
	A bobbin designed specifically for this machine is not used.	Incorrect bobbins will not work properly. Only use a bobbin designed specifically for this machine.	page 22
The fabric is wrinkled.	The upper thread was not threaded correctly, or the bobbin is incorrectly installed.	Correctly thread the upper thread and correctly install the bobbin thread.	page 26, page 28
	The spool is incorrectly installed.	Correctly install the spool.	page 28
	The combination of fabric, thread and needle is not correct.	Select a thread and needle that are appropriate for the type of fabric being sewn.	page 38
	The needle is bent or blunt.	Replace the needle.	page 39
	If thin fabrics are being sewn, the stitch is too long.	Shorten the stitch length or sew with stabilizer material under the fabric.	page 59
	The thread tension is incorrect.	Adjust the tension of the upper thread.	page 57
Stitches are skipped.	The upper thread was not threaded correctly.	Correct the upper threading.	page 28
	The combination of fabric, thread and needle is not correct.	Select a thread and needle that are appropriate for the type of fabric being sewn.	page 38
	The needle is bent or blunt.	Replace the needle.	page 39
	The needle is incorrectly installed.	Correctly install the needle.	page 39
	Dust has accumulated under the needle plate or in the bobbin case.	Remove the needle plate cover and clean the race.	page 142

Symptom	Probable Cause	Remedy	Reference
A high-pitched noise is made while sewing.	Dust has accumulated in the feed dogs or in the bobbin case.	Clean the race.	page 142
	The upper thread was not threaded correctly.	Correct the upper threading.	page 28
	The bobbin case is scratched, or has a burr on it.	Replace the bobbin case. Contact your dealer or the nearest authorized service center.	–
	A bobbin designed specifically for this machine is not used.	Incorrect bobbins will not work properly. Only use a bobbin designed specifically for this machine.	page 22
The needle threader cannot be used.	The needle has not been raised to the correct position.	Press the “Needle Position” button.	page 31
	The needle is incorrectly installed.	Correctly install the needle.	page 39
The stitch is not sewn correctly.	The presser foot that is used is not appropriate for the type of stitch that you wish to sew.	Attach the presser foot that is appropriate for the type of stitch that you wish to sew.	page 134
	The thread tension is incorrect.	Adjust the tension of the upper thread.	page 57
	The thread is tangled, for example, in the bobbin case.	Remove the tangle thread. If the thread is tangled in the bobbin case, clean the race.	page 142
The fabric does not feed.	The feed dogs are lowered.	Slide the drop feed lever to the right. (as seen from the rear of the machine)	page 104
	The stitch is too short.	Lengthen the stitch length.	page 59
	The presser foot that is used is not appropriate for the type of stitch that you wish to sew.	Attach the presser foot that is appropriate for the type of stitch that you wish to sew.	page 134
	The pressure of the presser foot is weak.	Turn the presser foot pressure dial to the left to increase the pressure of the presser foot.	page 43
	The thread is tangled, for example, in the bobbin case.	Remove the tangle thread. If the thread is tangled in the bobbin case, clean the race.	page 142
The sewing lamp does not come on.	The sewing lamp is damaged.	Contact your dealer or the nearest authorized service center.	–
Nothing appears in the LCD.	The brightness of the LCD is either too light or too dark.	Adjust the brightness of the LCD.	page 149

Error messages

If  ("Start/Stop" button) is pressed before the sewing machine is correctly set up or if an operation is performed incorrectly, an error message appears in the LCD. Follow the instructions that appear. The message will disappear if  (OK key) or  (Cancel/clear key) is pressed while the message is displayed.

Error Message	Probable Cause
 Can not change.	The selected setting cannot be changed with the selected pattern.
 Change speed controller mode to "OFF".	The "Start/Stop" button was pressed without connecting the foot controller while the setting for adjusting the stitch width using the sewing speed controller is set to [ON].
 Delete the selected pattern.  Cancel  Delete	The stitch mode was changed. This message appears when the current pattern is to be deleted.
 Disconnect foot control.	The "Start/Stop" button was pressed while the foot controller was connected.
 Lift buttonhole lever.	A stitch other than the buttonhole, bar tack or darning stitch was selected and the "Start/Stop" button was pressed while the buttonhole lever is lowered.
 Lower buttonhole lever.	The buttonhole, bar tack or darning stitch was selected and the "Start/Stop" button was pressed while the buttonhole lever is raised.
 Lower presser foot lever.	The "Start/Stop" button, "Reverse/Reinforcement Stitch" button or "Thread Cutter" button was pressed while the presser foot was raised.
 No more stitches can be combined.	You tried to combine more than 70 decorative stitches, stain stitches, cross stitches or combined utility stitches.
 Release twin needle setting.	The twin needle setting is selected while a pattern that cannot be sewn with the twin needle is selected.
 Return bobbin winding shaft to left.	The "Reverse/Reinforcement Stitch" button, "Needle Position" button or "Thread Cutter" button was pressed while the bobbin winder shaft is moved to the right.
Saving...	A pattern is being saved. Otherwise, the stitch settings are being saved.
 Select pattern.	The "Start/Stop" button or "Reverse/Reinforcement Stitch" button was pressed after a stitch has been deleted.
 The safety device has been activated.	The motor locked up because the thread is tangled.
Winding bobbin thread.	The bobbin winder is winding the bobbin.



Nothing appears in the LCD

If nothing appears in the LCD when the sewing machine is turned on, the brightness of the LCD is either too light or too dark. If this is the case, perform the following operation.

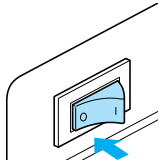
- 1 Turn off the sewing machine.



- 2 While pressing  (Cancel/clear key) in the operation panel, turn on the sewing machine.

- 3 Press  or  (Stitch width keys). Adjust the brightness of the LCD so that the screens can be seen.

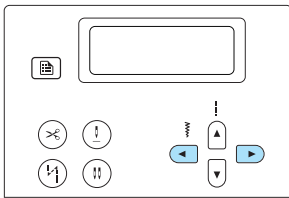

- 4 Turn off the sewing machine, then turn it on again.

Operation beep

Each time a key is pressed or an incorrect operation is performed, a beep is sounded.

■ For a correct operation

One beep is sounded.

■ If an incorrect operation is performed

Two or four beeps are sounded.

■ If the machine locks up, for example, because the thread is tangled

The sewing machine continues to beep for four seconds. The machine automatically stops.

Be sure to check for the cause of the error, and correct it before continuing to sew.

Cancelling the operation beep

When the sewing machine is purchased, it is set to beep each time an operation panel key is pressed. This setting can be changed so that the machine does not beep.

- 1 Turn on the sewing machine.

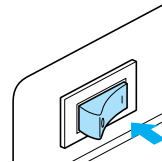

▶ The LCD comes on.

- 2 Press  (Settings key) in the operation panel.



▶ The settings screen appears.

- 3 Press  or  (Stitch length keys) until  is displayed.

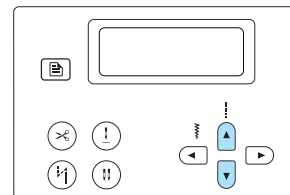

▶ The screen for changing the beep setting appears.

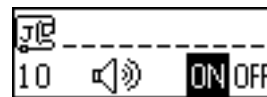

- 4** Press  or  (Stitch width keys) to select **OFF**.

To return to **ON**, press  or  (Stitch width keys).

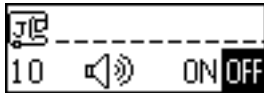
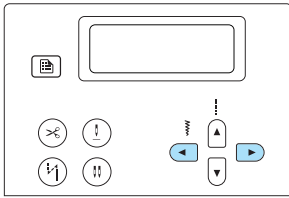

- ▶ The machine is now set so that it will not beep.

- 5** Press  (Cancel/clear key) or  (OK key).

- ▶ The initial stitch screen appears again.

Index

Numerics

1/4 inch quilting foot	9
1/4 inch quilting foot with guide	9
2-point zigzag stitch	77
3-point zigzag stitch	77

A

accessories	8
accessory bag	9
adjustable zipper/piping foot	9, 96
air vent	11
appliqué	101
automatic reinforcement stitching	60
automatic reverse stitching	60
automatic reverse/reinforcement stitch key	13
automatic thread cutting key	13
automatic thread-cutting	7, 62

B

bar tack	107
baseline	81
basic stitching	81
basting	80
blind hem stitch	82
blind stitch foot	9
bobbin	9, 26
bobbin case	26, 142
bobbin cover	11, 27
bobbin thread	26
pulling up	36
bobbin winder	10
bobbin winder shaft spring	23
bobbin winding thread guide and pretension disk ..	10, 24
bobbin-winding	7, 22
brightness	21
built-in stitches	7
button fitting foot	9
button sewing	84, 89
buttonhole foot	9, 88
buttonhole lever	11, 86, 108, 110
buttonhole stitching	84

C

cancel/clear key	13
care	142
changing machine settings	19
changing sewing direction	65
changing the settings	19
character stitch key	13
character stitches	71, 119, 140
checking patterns	121
cleaning	142
cleaning brush	9, 143
combining patterns	120

crazy quilt stitching	102
cross-stitch	119
cross-stitches	71, 119, 138
curves	65
cylindrical pieces	46

D

darning	109
decorative satin stitches	71, 119, 138
decorative stitch key	13
decorative stitches	71, 119, 138
decorative stitching	112
designing patterns	129
direct selection	70
disk-shaped screwdriver	9

E

elastic tape	98
electrical outlet	17
error messages	148
even seam allowance	67
extra spool pin	9, 34
eyelet	111
eyelet punch	9, 87, 111

F

fagoting	113
features	7
feed dog position switch	11, 105
feed dogs	11, 104
flat bed attachment	10
flipping	125
foot controller	9, 52
foot controller jack	11
free-arm sewing	46
free-motion quilting	104

G

grid sheet set	9
----------------------	---

H

handle	11
handwheel	11, 51
hard case	9
heirloom stitching	116

I

included accessories	8
Inserting a piping	97

J	
joining	116
joining stitch	100
K	
knee lifter	7, 9, 64
knee lifter mounting slot	10
L	
language	21
LCD	13, 18, 21, 149
brightness	21, 149
leather/vinyl fabrics	67
lower threading	7, 26
M	
machine settings	19
main power switch	11, 17
maintenance	142
manual memory key	13
memory key	13
mirror image	125
monogramming foot	9
My Custom Stitch	71, 129
N	
needle	37
needle bar thread guide	11
needle clamp screw	40
needle mode selection key	13
needle plate	11, 67
needle plate cover	11
needle position	58, 81
needle position button	12
needle set	9
needle stop position	60
needle stop position key	13
needle threader lever	10
needle threading	31
non stick foot	9, 67
number selection	70
numeric keys	13
O	
OK key	13
open toe foot	9
openings	107
operation beep	149
operation buttons	10, 12
operation manual	9
operation panel	10, 13
optional accessories	9
overcasting foot	8
overcasting stitches	76
P	
patchwork stitching	102
pattern length	124
pattern size	122
patterns	119
piecing	102
pipng inserting	97
pocket corners	107
positioning fabric	51
power supply	16
power supply jack	11, 17
preset utility stitch/saved pattern key	13
presser foot	11, 41
presser foot dial	11, 43
presser foot holder	11, 43
presser foot lever	11
presser foot pressure	43
programmed thread-cutting	62
Q	
quick reference guide	9
quilting	103
quilting foot	9, 104
quilting guide	9, 103
R	
race	142
realigning	127
realigning patterns	127
reinforcement stitching	54, 60, 107
repeat sewing	121
replacing the needle	37, 39
reset key	13
retrieving a pattern	126
reverse/reinforcement stitch button	12
S	
safety instructions	1
satin stitches	71, 119, 138
satin stitching	105
saving patterns	126
saving stitch settings	63
scallop stitching	114
screwdriver	9, 40
seam ripper	9, 87
selecting stitching	72
settings key	13, 19
sewing machine needles	37
sewing speed	52
sewing speed controller	12, 105
shell tuck stitch	115
side cutter	9, 78
size	122
sleeves	107
smocking	114
spool cap	9, 23, 29
spool net	9
spool pin	10, 23, 29
start/stop button	12, 52

starting to sew	52
stitch density	123
stitch guide foot	9, 67
stitch length	59
stitch length keys	13
stitch mode	70
stitch pattern plate	9
stitch settings	134
stitch width	58
controlling	105
stitch width keys	13
straight stitch	134
stretch fabrics	66, 98

T

thick fabrics	66
thin fabrics	66
thread cutter	10, 56
thread cutter button	12, 55
thread guide cover	10
thread guide disk	11
thread guide plate	10
thread tension	57
thread tension adjustment	57
thread tension dial	10, 57
top cover	10
trial sewing	65
triple stretch stitch	107
troubleshooting	144
twin needle	9, 33, 40

U

upper thread	28
upper thread tension	57
upper threading	7, 28
utility decorative stitches	71, 119, 139
utility stitch key	13
utility stitches	70, 134

W

walking foot	9, 44, 103
wide table	9, 46
wing needle	116

Z

zigzag foot	9
zipper foot	9
zipper stitching	91, 96

Free Manuals Download Website

<http://myh66.com>

<http://usermanuals.us>

<http://www.somanuals.com>

<http://www.4manuals.cc>

<http://www.manual-lib.com>

<http://www.404manual.com>

<http://www.luxmanual.com>

<http://aubethermostatmanual.com>

Golf course search by state

<http://golfingnear.com>

Email search by domain

<http://emailbydomain.com>

Auto manuals search

<http://auto.somanuals.com>

TV manuals search

<http://tv.somanuals.com>