

SEWING MACHINE

OPERATION MANUAL

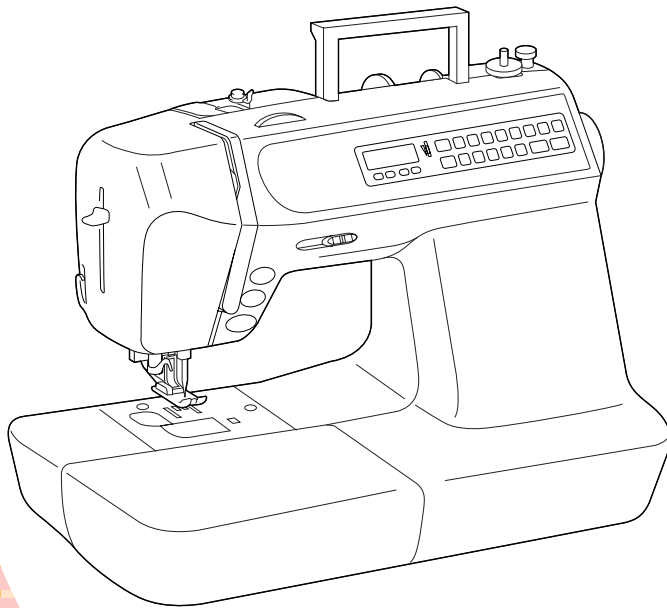

“IMPORTANT SAFETY INSTRUCTIONS”

When using a sewing machine, basic safety precautions should always be taken, including the following:

“Read all instructions before using.”

DANGER — To reduce the risk of electric shock.

1. The sewing machine should never be left unattended while plugged in. Always unplug the sewing machine from the electrical outlet immediately after using and before cleaning.
2. Always unplug before changing the light bulb. Replace bulb with same type rated 12V 5 watts.

WARNING — To reduce the risk of burns, fire, electric shock, or injury.

1. Do not allow this sewing machine to be used as a toy. Close attention is necessary when the sewing machine is used by or near children.
2. Use this sewing machine only for its intended use as described in this manual. Use only accessories recommended by the manufacturer as contained in this manual.
3. Never operate this sewing machine if it has a damaged cord or plug, if it is not working properly, if it has been dropped or damaged, or dropped into water. Return the sewing machine to the nearest authorized dealer or service center for examination, repair, electrical or mechanical adjustment.
4. Never operate the sewing machine with any air openings blocked. Keep ventilation openings of the sewing machine and foot control free from the accumulation of lint, dust, and loose cloth.
5. Never drop or insert any object into any opening.
6. Do not use outdoors.
7. Do not operate where aerosol (spray) products are being used or where oxygen is being administered.
8. To disconnect, turn the main switch to the symbol “O” position which represents off, then remove plug from outlet.
9. Do not unplug by pulling on cord. To unplug, grasp the plug, not the cord.
10. Keep fingers away from all moving parts. Special care is required around the sewing machine needle.
11. Always use the proper needle plate. The wrong plate can cause the needle to break.
12. Do not use bent needles.
13. Do not pull or push fabric while stitching. It may deflect the needle causing it to break.
14. Switch the sewing machine to the symbol “O” position when making any adjustments in the needle area, such as threading needle, changing needle, threading bobbin, or changing presser foot, and the like.
15. Always unplug the sewing machine from the electrical outlet when removing covers, lubricating, or when making any other user servicing adjustments mentioned in the instruction manual.
16. This sewing machine is not intended for use by young children or infirm persons without supervision.
17. Young children should be supervised to ensure that they do not play with this sewing machine.

“SAVE THESE INSTRUCTIONS”

“This sewing machine is intended for household use.”

FOR USERS IN THE UK, EIRE, MALTA AND CYPRUS ONLY.

If your sewing machine is fitted with a three-pin non-rewireable BS plug then please read the following.

IMPORTANT

If the available socket outlet is not suitable for the plug supplied with this equipment, it should be cut off and an appropriate three-pin plug fitted. With alternative plugs an approved fuse must be fitted in the plug.

NOTE

The plug severed from the main lead must be destroyed as a plug with bared flexible cords is hazardous if engaged in a live socket outlet. In the event of replacing the plug fuse, use a fuse approved by ASTA to BS 1362, i.e. carrying the  mark, rating as marked on plug.

Always replace the fuse cover, never use plugs with the fuse cover omitted.

WARNING

DO NOT CONNECT EITHER WIRE TO THE EARTH TERMINAL WHICH IS MARKED WITH THE LETTER 'E', BY THE EARTH SYMBOL \perp OR COLOURED GREEN OR YELLOW.

The wires in this main lead are coloured in accordance with the following code:

Blue	Neutral
Brown	Live

As the colours of the wiring in the main lead of this appliance may not correspond with the coloured markings identifying the terminals in your plug, proceed as follows.

The wire which is coloured blue must be connected to the terminal which is marked with the letter 'N' or coloured black or blue.

The wire which is coloured brown must be connected to the terminal which is marked with the letter 'L' or coloured red or brown.

CONGRATULATIONS ON CHOOSING A BROTHER COMPUTER SEWING MACHINE

Your machine is the most advanced computerized home use sewing machine available. To fully enjoy all the features incorporated into it, we suggest that you study this booklet.

PLEASE READ BEFORE USING YOUR SEWING MACHINE

For safe operation

1. Be sure to keep your eye on the needle while sewing. Do not touch the balance wheel, thread take-up, needle, or other moving parts.
2. Remember to turn off the power switch and unplug the cord when:
 - Operation is completed
 - Replacing or removing the needle or any other parts
 - A power failure occurs during use
 - Maintaining the machine
 - Leaving the machine unattended
3. Do not store anything on the foot controller.
4. Plug the machine directly into the wall. Do not use extension cords.

For a longer service life

1. When storing your sewing machine, avoid direct sunlight and high humidity locations. Do not store the sewing machine beside a space heater, iron, or other hot objects.
2. Use only neutral soaps or detergents to clean the case. Benzene, thinner, and scouring powders can damage the case and machine, and should never be used.
3. Do not drop or hit the machine.
4. Always consult the operation manual when replacing or installing any accessories, the presser feet, needle, or other parts to assure correct installation.

For repair or adjustment

In the event that a malfunction occurs or adjustment is required, first follow the troubleshooting table in the back of the operation manual to inspect and adjust the machine yourself. If the problem persists, please consult your nearest authorized Brother service center.

CONTENTS

CHAPTER 1

BEFORE USE







.....	4
PART NAMES	4
OTHER ENCLOSED ACCESSORIES	6
OPTIONAL ACCESSORIES	6
DISPLAY PANEL	7
OPERATION BUTTONS	8
Using the operation buttons	8
POWER SUPPLY	9
SCREEN	10
About the screen	10
Adjusting the brightness of the screen	10
LANGUAGE SELECTION KEY	11
Clearing the language selection	12
BOBBIN WINDING / BOBBIN THREAD SETTING	13
Winding the bobbin and setting the bobbin thread	13
Setting the bobbin	15
UPPER THREADING	16
Using the extra spool pin and the net	18
STARTING AND STOPPING SEWING	19
"START/STOP" button	19
Foot controller	19
SELECTING A STITCH (UTILITY STITCHES)	20
Using the "info" (information) key	20
Quick adjustment reference chart for stitch width and stitch length	21
THREAD TENSION	22
Correct upper thread tension	22
Loosening the upper thread tension	22
Tightening the upper thread tension	23
PRESSER FOOT	24
Changing the presser foot	24
Removing the presser foot holder (while cleaning, etc.)	24
FEED DOGS	25
NEEDLE	26
Checking the needle	26
Installing the needle securely	26
FABRIC/THREAD/NEEDLE COMBINATION CHART	27

CHAPTER 2

1. SEWING

.....	28
TRIAL SEWING	28
Sewing using a utility stitch	28
AUTOMATIC REINFORCEMENT STITCHING .	30
Cancelling automatic reinforcement stitching	30
STITCH WIDTH AND LENGTH	31
Adjusting the stitch width	31
Adjusting the stitch length	31
USEFUL SKILLS	32
Sewing corners	32
Sewing folded parts	32
Sewing curves	32
Sewing on thick fabric	33
Sewing on thin fabric	33
Using the needle plate	34
Free-arm sewing	34

2. UTILITY STITCHES

.....	35
STRAIGHT STITCHES	35
Sewing stretch fabrics	36
Changing the stitch length	36
Changing the needle position	36
ZIGZAG STITCHES	37
Overcasting (using a zigzag stitch)	37
Applique (using a zigzag stitch)	37
Patchwork (for crazy quilts)	37
OVERCASTING STITCHES	38
Sewing using stitch  ,  or 	38
Sewing using stitch  or 	38
OVERCASTING (WHEN USING THE OPTIONAL SIDE CUTTER)	39
BLIND HEM STITCHING	41
Adjusting the needle drop point	42
BUTTONHOLE STITCHING	43
Buttonhole sewing order	45
Sewing stretch fabrics ("  " and "  ")	45
Buttons that do not fit into the guide plate (Odd-shaped buttons)	46
Changing the stitch length	47
Changing the stitch width	47
BAR TACKING	48
Thick fabrics	49
Changing the bar tack stitch length	50
Changing the bar tack stitch width	50
DARNING	51
Changing the darning stitch length	52
Changing the darning stitch width	52
Darning stitch sewing order	53
EYELET STITCH	54
Size of eyelet (Actual size)	54
BUTTON SEWING	55
Attaching buttons with four holes	56
Attaching a shank to the button	56
ZIPPER INSERTION (CENTERED AND SIDE APPLICATIONS)	57
Centered application	57
Side application	58
DART SEAM	60
GATHERING	61
Pulling out the bobbin thread	62
PINTUCK	63
FLAT FELL SEAM	64
Finished flat fell seam	65
APPLIQUES	66
Sewing the applique around corners or curves	66
SCALLOP STITCH	67
SMOCKING STITCH	68
PATCHWORK STITCH	69
FAGOTING	70
DECORATIVE STITCHING	71
Decorative stitching	71
Shell tacking	71
HEM-STITCH (HEIRLOOM STITCH)	72
Hem-stitching 1	72
Hem-stitching 2	73
TWIN NEEDLE	74

3. FONTS AND DECORATIVE STITCHES

.....	76
FONT STITCHES	76
Combining characters	77
DECORATIVE STITCHES	78
Selecting a decorative stitch	79
Combining decorative stitches	79
CORRECTING A PATTERN COMBINATION	80
CHANGING THE SIZE	81
Changing the size of a decorative stitch	81
CHECKING A PATTERN COMBINATION	82
MEMORY	83
Saving a pattern combination	83
Checking a stored pattern combination	83
Recalling a stored pattern combination	84
SEWING	85
Sewing attractive finishes	85
Sewing	86
ADJUSTING STITCH PATTERNS	87

MAINTENANCE

.....	88
CLEANING	88
Cleaning the screen	88
Cleaning the sewing machine surface	88
Cleaning the shuttle	88
CHANGING THE LIGHT BULB	90

ERROR MESSAGES

.....	91
Warning messages	91
Messages	92
Alarm	92
Trouble with threads and stitches	93
Mechanical trouble	94

SEWING CHART

.....	95
-------	-----------

HOW TO USE WALKING FOOT (OPTIONAL ACCESSORY)

.....	97
-------	-----------

PATTERNS (PROGRAMMED IN MACHINE)

.....	98
Utility stitches	98
Character sewing	98
Decorative stitches	99

PART NAMES

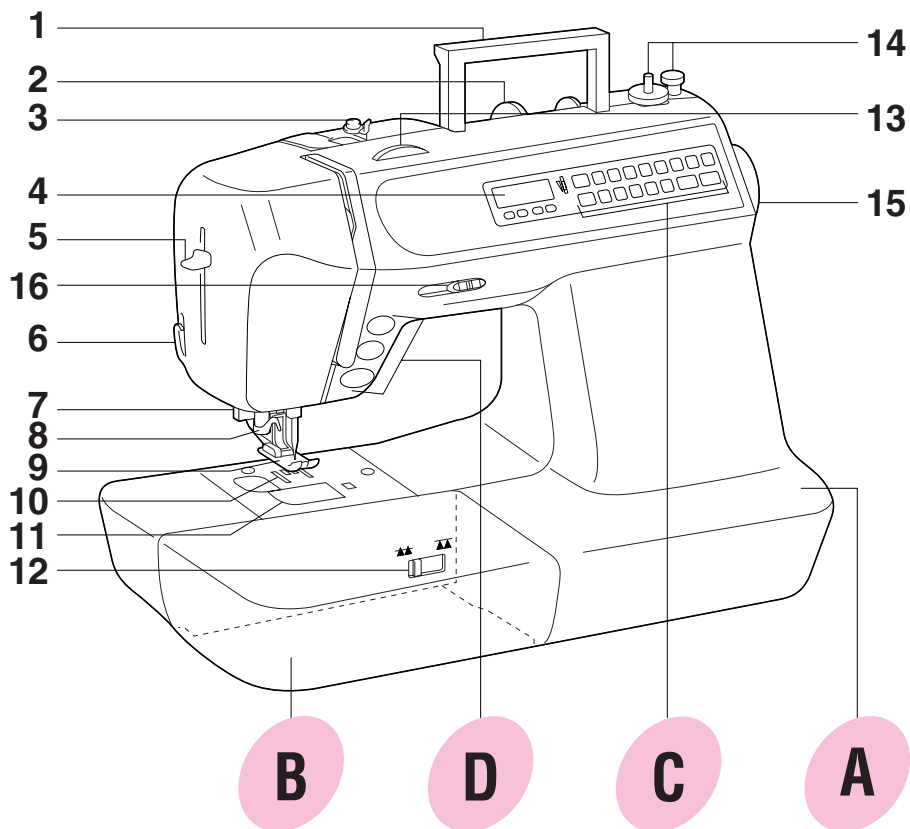

- 1- Handle
- 2- Spool cap
- 3- Thread guide for bobbin winding
- 4- LCD (liquid crystal display)
- 5- Needle threader lever
- 6- Thread cutter
- 7- Buttonhole sewing lever
- 8- Needle threader
- 9- Presser foot
- 10- Feed dog
- 11- Bobbin cover
- 12- Feed dog adjustment lever
- 13- Upper tension control dial
- 14- Bobbin winder device
- 15- Balance wheel
- 16- Speed range control lever

- A- Main power switch and connectors
- B- Accessory compartment
- C- Selection keys
- D- Operation buttons

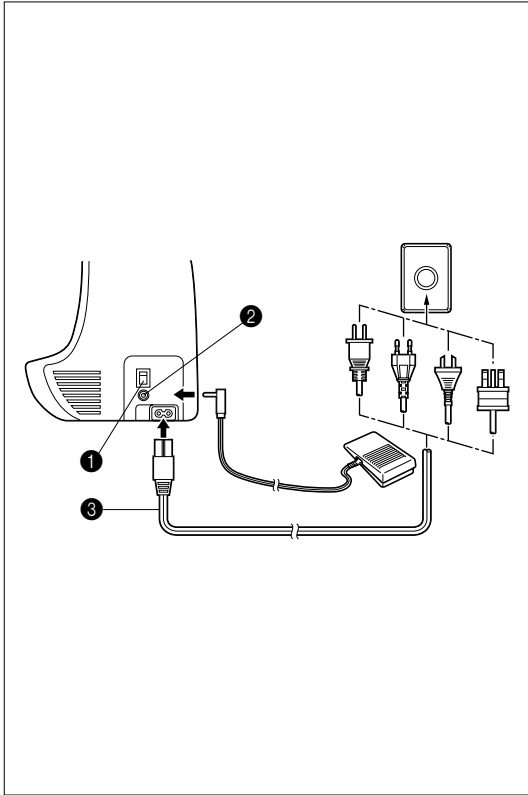

A. MAIN POWER SWITCH AND CONNECTORS

- ❶ **Main power switch**
Use to turn on/off the main power.
- ❷ **Foot controller jack**
Use to connect the foot controller.
- ❸ **Power cord**
Use to connect the machine to the power supply.

CAUTION

- When leaving the sewing machine unattended, the main switch of the machine must be switched off or the plug must be removed from the socket-outlet.
- When servicing the sewing machine, or when removing covers or changing bulbs, the machine or the electrical set must be unplugged.
- For U.S.A. only
This appliance has a polarized plug (one blade wider than the other). To reduce the risk of electric shock, this plug is intended to fit in a polarized outlet only one way. If the plug does not fit fully in the outlet, reverse the plug. If it still does not fit, contact a qualified electrician to install the proper outlet. Do not modify the plug in any way.

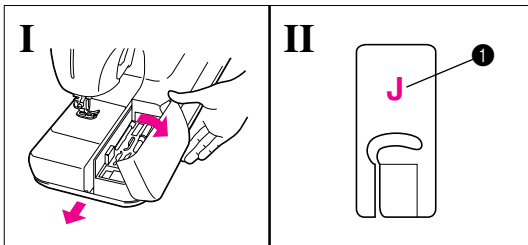

B. FLATBED ATTACHMENT WITH ACCESSORY COMPARTMENT

- I Tilt the lid of the accessory compartment toward you to open it.
- II Each presser foot can be identified by the symbol on it.
- ❶ **Presser foot symbol**
- III COMPARTMENT ACCESSORY LIST
The location of each accessory is shown in figure III.

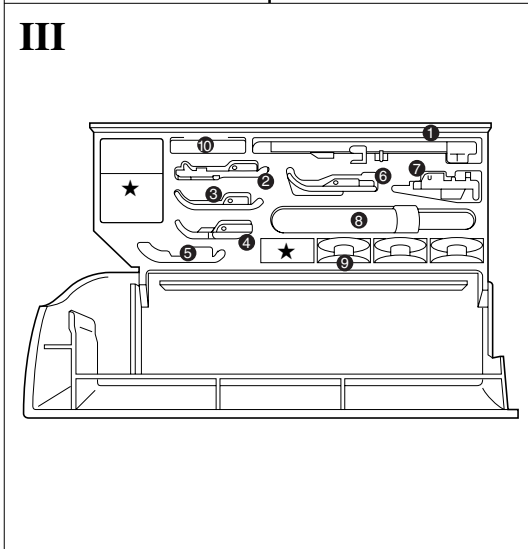

No.	Part Name	Part Code
❶	Buttonhole foot "A"	X57789-101
❷	Overcasting foot "G"	X51162-001
❸	Monogramming foot "N"	137988-101
❹	Zipper foot "I"	X59370-051
❺	Space for Zigzag foot "J"	137748-101
❻	Blind stitch foot "R"	X56409-001
❼	Button-sewing foot "M"	130489-001
❽	Seam ripper	X54243-001
❾	Bobbins	136492-151
❿	Needle set	X58358-001

- * The spaces marked with "★" are empty. No enclosed accessories fit in these spaces.
- * Always use the plastic bobbin which is supplied with the machine or in the accessory compartment.
- * Always use BROTHER accessories with this machine.

OTHER ENCLOSED ACCESSORIES

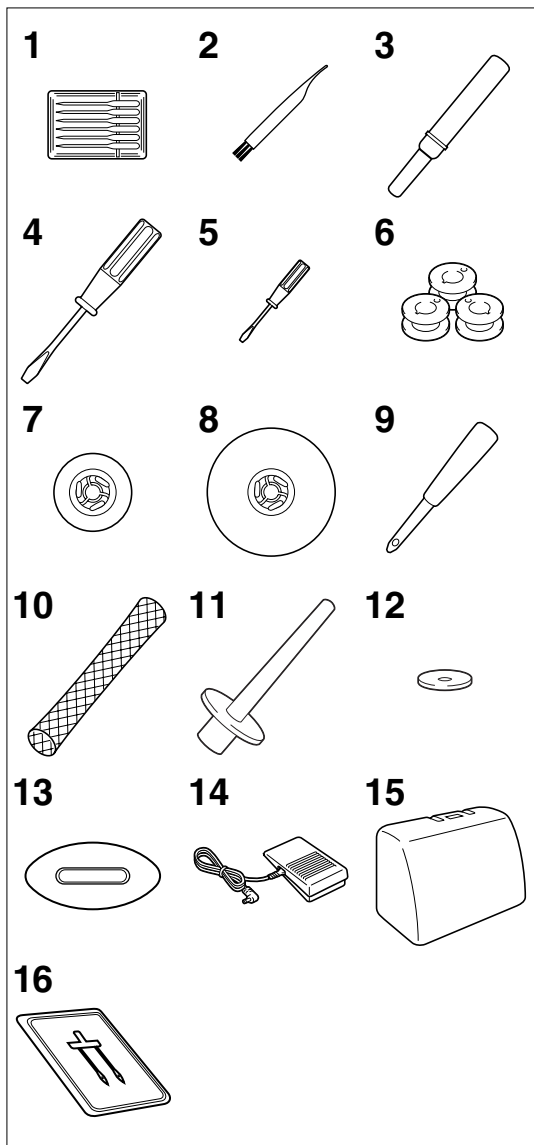

No.	Part Name	Part Code
1	Needle set 90/14: 14 Golden needle (for stretch fabrics):	4 pcs 2 pcs X58358-001
2	Cleaning brush	X59476-051
3	Seam ripper	X54243-001
4	Screwdriver (large)	X55467-051
5	Screwdriver (small)	X55468-051
6	Bobbin (3)	136492-151
7	Spool cap (small)	130013-053
8	Spool cap (large)	130012-053
9	Eyelet punch	135793-001
10	Net*	XA5523-050
11	Extra spool pin*	XA3336-051
12	Spool felt	X57045-051
13	Disc-shaped screwdriver	XA2005-051
14	Foot controller	XA3931-051
15	Hard case	XA2482-051
16	Twin needle	X59296-001

- * Always use a thread net with metallic threads.
- * When using special threads which quickly wind off the thread spool, place a net over the spool before sewing.
- * The extra spool pin, which is provided as an accessory, should be attached to the end of the bobbin winder shaft during use.

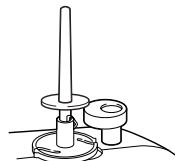

Note (For U.S.A. only)

Foot controller: Model N5V

This foot controller can be used for sewing machine model PC-3000.

OPTIONAL ACCESSORIES

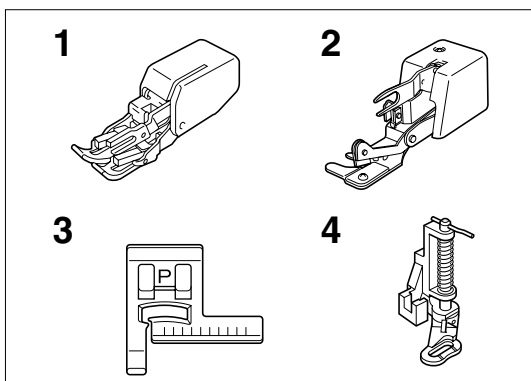

- 1- Walking foot*
Parts code: X81065-001
- 2- Side cutter
Parts code: X81028-001
- 3- Stitch guide foot "P"
Parts code: X51804-001
- 4- Quilting foot
Parts code: XA4322-001

- * If using the walking foot, please refer to page 97 for HOW TO USE WALKING FOOT (OPTIONAL ACCESSORY).

DISPLAY PANEL

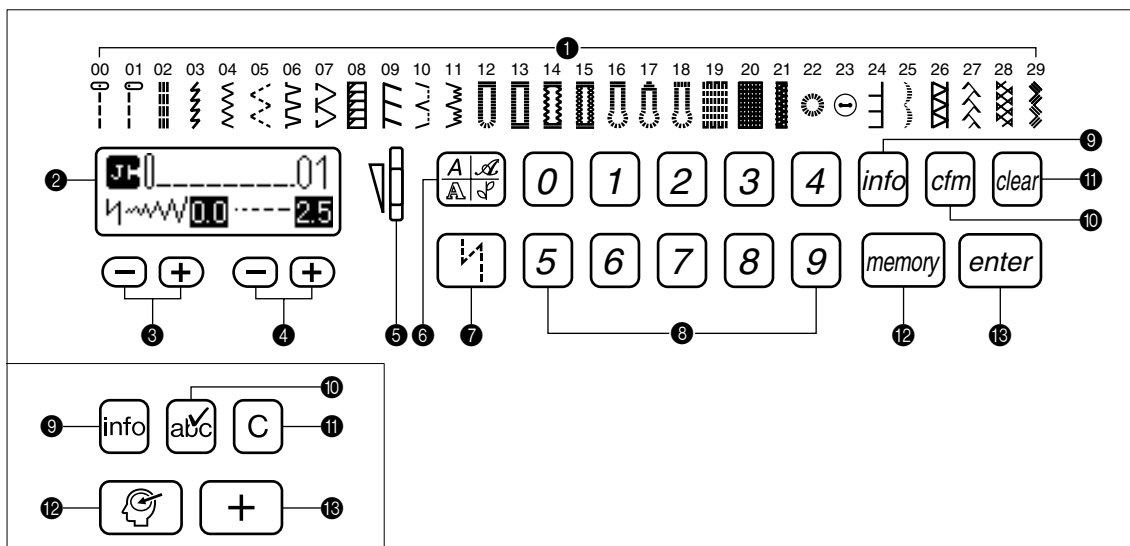

C. DISPLAY PANEL

- 1 Stitches and patterns**
The utility stitches (00 ~ 29).
- 2 Screen**
The number of the selected stitch, the patterns, suggested presser foot and any messages or errors are shown here.
- 3 Stitch width keys**
Touch this key to adjust the width of the zigzag stitch.
- 4 Stitch length keys**
Touch this key to adjust the length of the stitch.
- 5 Screen brightness control lever**
Slide this lever to adjust the brightness of the screen when messages are difficult to read.
- 6 Font/decorative stitch key**
Touch this key to select the decorative, block letter, script or outlined letter stitches.
- 7 Automatic reinforcement stitching key**
Before starting to sew, touch this key to sew reinforcement stitches automatically at the beginning and the end of the stitch.
- 8 Stitch selection keys**
Touch these keys to enter the number of the stitch that you wish to use. A two-digit number must be entered when selecting the stitch.
- 9 “info” (information) key**
Touch this key to display information on the selected stitch.
- 10 “cfm” (confirmation) key**
Touch this key to confirm that the characters selected for a pattern combination are correct.
- 11 “clear” key**
Touch this key when the wrong character is selected. Each press of this key erases one character.
- 12 “memory” key**
Touch this key to store the created pattern combination in the memory.
- 13 “enter” key**
Touch this key to combine patterns.

OPERATION BUTTONS

Using the operation buttons

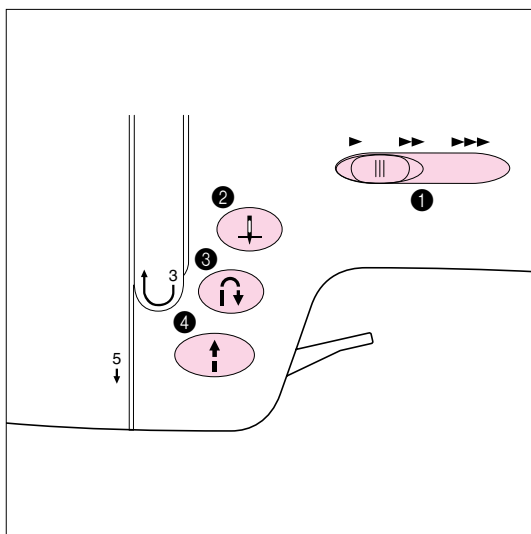
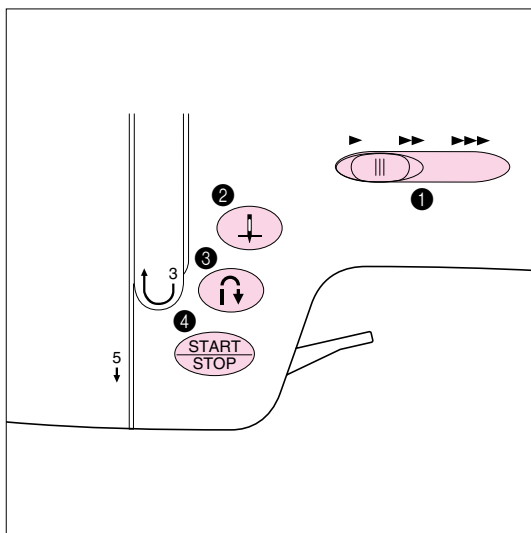

D. OPERATION BUTTONS

- ❶ **Speed range control lever**
Slide this lever to change the sewing speed.
- ❷ **“NEEDLE POSITION” button**
Press this button to move the needle either up or down.
- ❸ **“REVERSE STITCH” button**
Hold down this button to sew either backwards or in the same place at a slow speed. When sewing a reverse stitch, sewing is done in reverse. When sewing a reinforcement stitch, three stitches are sewn at the same position.
- ❹ **“START/STOP” button**
This lighted button changes to green when the machine is ready to start or while it is sewing. If the machine cannot be started, this button changes to red. In addition, this button lights up in orange while the bobbin thread is winding onto the bobbin (the bobbin winder shaft is moved to the right).

* Sewing continues at a slow speed while this button is pressed.

POWER SUPPLY

WARNING

- When leaving the sewing machine unattended or when it is not being used, turn off the main power switch of the machine or remove the plug from the wall outlet.

CAUTION

- Do not use this sewing machine with extension cords or multi-plug adaptors, otherwise a fire or an electric shock may occur.
- Do not remove the plug from the wall outlet with wet hands, otherwise an electric shock may occur.
- When unplugging the power cord, turn off the main power switch of the machine, then grasp the plug and pull to unplug the cord. Pulling on the cord may damage it or cause a fire or an electric shock.
- Do not allow the power cord to be cut, damaged, modified, forcefully bent, pulled, twisted or bundled. In addition, do not place heavy objects on the cord or subject it to heat, otherwise the cord may be damaged or a fire or an electric shock may occur.
If the power cord or plug are damaged, contact your nearest authorized Brother dealer or service center.
- If the sewing machine is not to be used for a long period of time, unplug the power cord, otherwise a fire may occur.

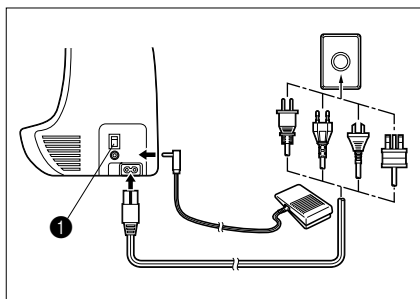

1. Insert the plug into a wall outlet.

❶ Main power switch

2. Set the main power switch to "I".
3. To turn off the sewing machine, set the main power switch to "O".

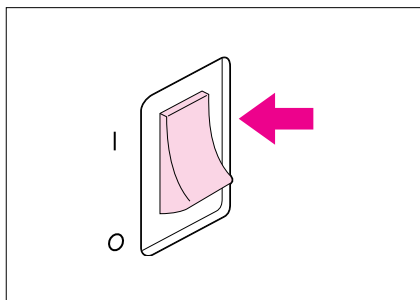

SCREEN

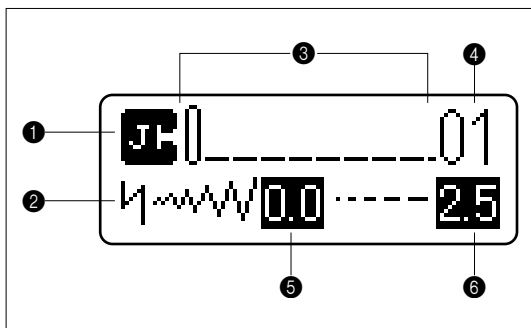

- 1 Shows the presser foot symbol.
- 2 Shows whether the automatic reinforcement stitching is turned on or off.
- 3 Displays an example of the selected stitch and any messages or errors.
- 4 Shows the number of the selected stitch.
- 5 Shows the width of the stitch.
Normally, the appropriate stitch width for the selected stitch is shown in white numbers on a black background. If the stitch width is manually adjusted, it will appear in black numbers with no background.
- 6 Shows the length of the stitch.
Normally, the appropriate stitch length for the selected stitch is shown in white numbers on a black background. If the stitch length is manually adjusted, it will appear in black numbers with no background.

Automatic/manual display

- 2.5** Automatic (standard value)
0.6 Manual (set value)

If no value is displayed, the setting cannot be adjusted.

About the screen

Note

- Some or all of the screen may become darker or lighter at times due to changes in the ambient temperature around the screen. This is normal and is not a sign of a malfunction. Adjust the screen if it is difficult to read. Please refer to instructions for adjusting the brightness of the screen.

Adjusting the brightness of the screen

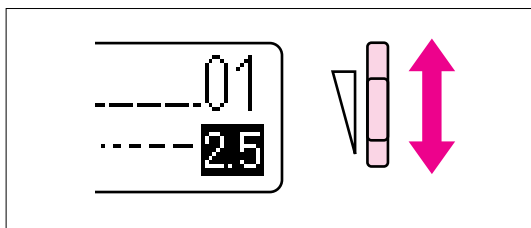

When the screen is hard to read, slide the screen brightness control lever to adjust the brightness of the screen. If the screen is too light, slide the lever up; if the screen is too dark, slide the lever down.

LANGUAGE SELECTION KEY

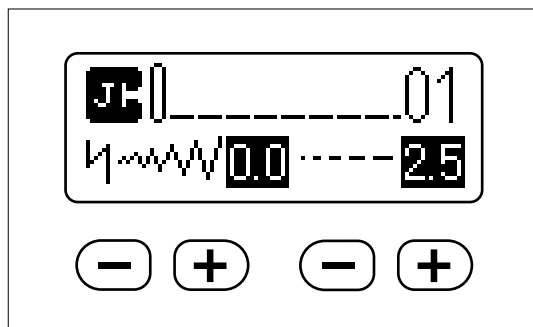
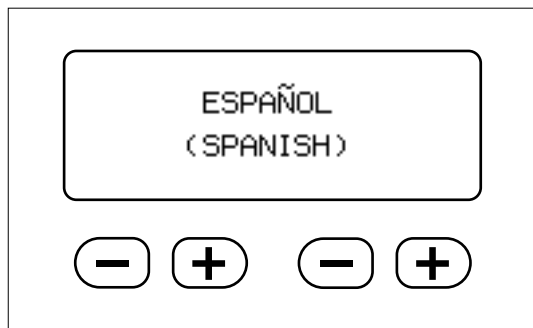
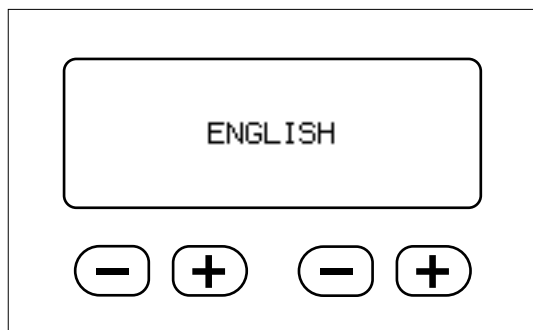

Example: To change the display language to Spanish.

1. Turn off the sewing machine, then while holding down the information key, turn the sewing machine on again.
2. Press the "⊕" stitch length key five times.
3. Press the enter key to change the display language.

Clearing the language selection

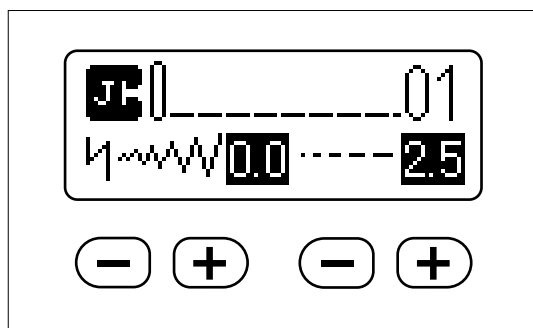
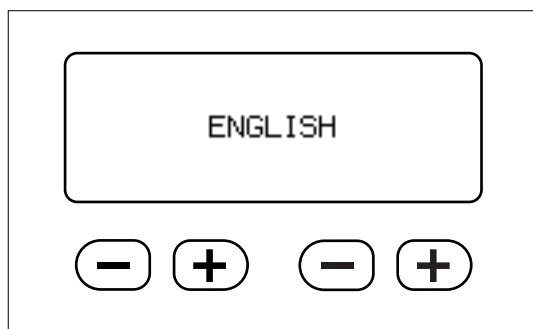

Example: To change the display language from Spanish back to English

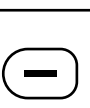
1. Turn off the sewing machine, then while holding down the information key, turn the sewing machine on again.
2. Press the “” stitch length key five times.
3. Press the enter key to change the display language.

CAUTION

- This function can not be used as a translation function.
- If the power supply is turned off, the current language setting will be retained and will not be cleared.

BOBBIN WINDING / BOBBIN THREAD SETTING

Winding the bobbin and setting the bobbin thread

CAUTION

Be sure to use the specified bobbin (part code 136492-151). Using a different bobbin may result in injuries or damage.

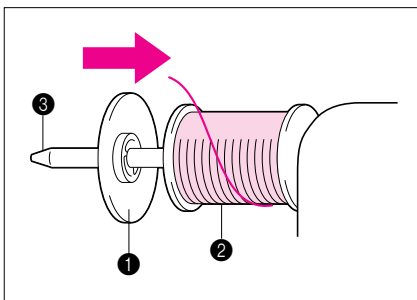
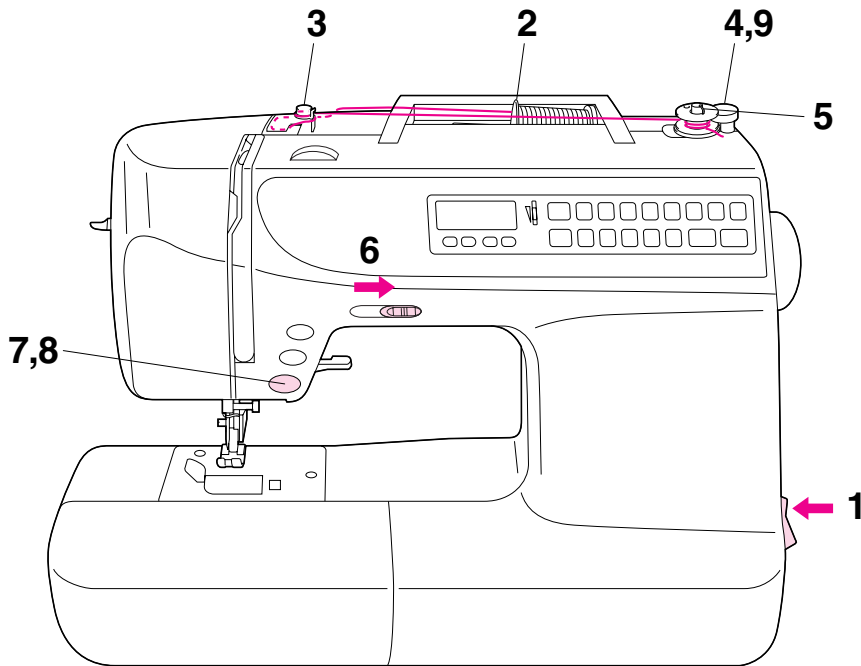

1. Connect the machine to the power supply and turn on the main power.
2. Place the spool of thread on the spool pin. The thread end should come from the bottom front of the spool. The spool cap closest to the thread spool size should be used to hold the spool securely on the spool pin.

- ① Spool cap
- ② Spool
- ③ Spool pin

* The spool cap should be pushed on as far as it will go.

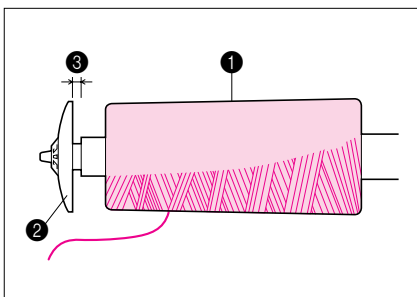

Note

If using a fine thread such as cross wound thread, slightly separate the spool cap (small) from the spool of thread before using it.

- ① Cross wound thread
- ② Spool cap (small)
- ③ Gap

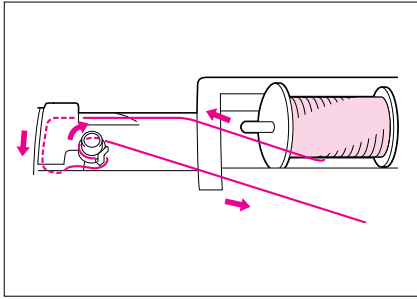

3. Pass the thread through the thread guide as shown by the arrows.

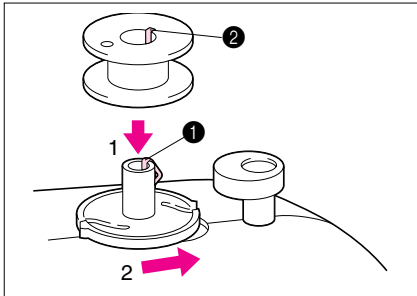

4. Align the groove in the bobbin with the spring on the shaft and place the bobbin on the bobbin winder shaft. Then, push the bobbin winder shaft to the right.

- ❶ Spring on the shaft
- ❷ Groove of the bobbin

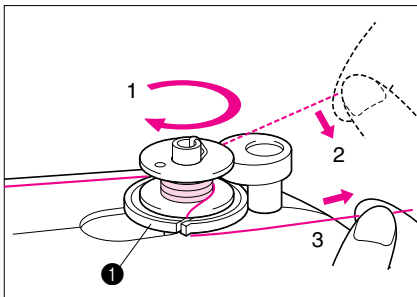

5. Wind the thread clockwise around the bobbin four or five times, pass the end of the thread through the slit in the bobbin winder seat, and then pull the thread in the direction shown in the illustration. Use the cutter to cut the thread.

- ❶ Bobbin winder seat

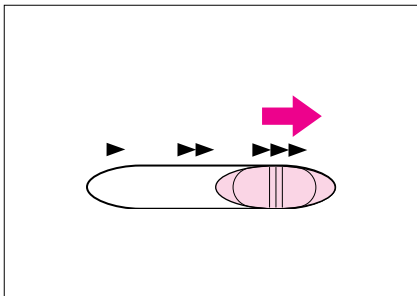

6. Slide the speed range control lever to its maximum (as far to the right as possible).
7. Press the "START/STOP" button. The machine will stop automatically when the bobbin is full.
8. After the bobbin has stopped moving, press the "START/STOP" button to stop the machine.
9. Cut the thread, slide the bobbin winder shaft to the left and remove the bobbin.

Note

Immediately after winding the bobbin, it is normal to hear the sound of the clutch engaging when beginning to sew or manually turning the balance wheel.

Setting the bobbin

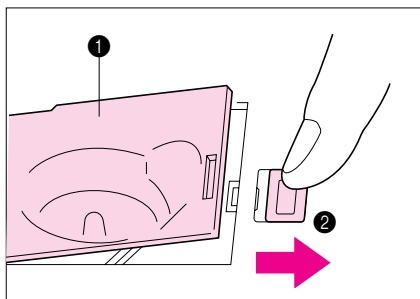

1. Slide open the bobbin cover.

- ❶ Bobbin cover
- ❷ Bobbin cover release button

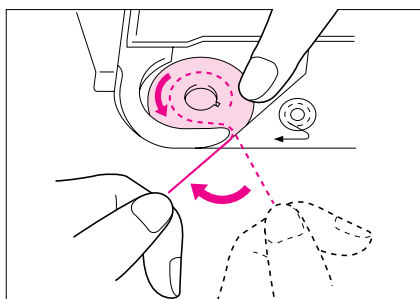

2. Insert the bobbin into the shuttle with the thread direction as shown in the diagram.

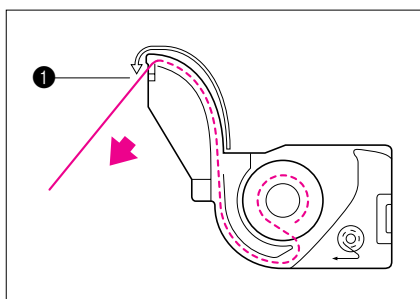

3. Guide the thread end through the slit, then pull the thread toward you to cut off any excess thread.

- ❶ Built-in thread cutter

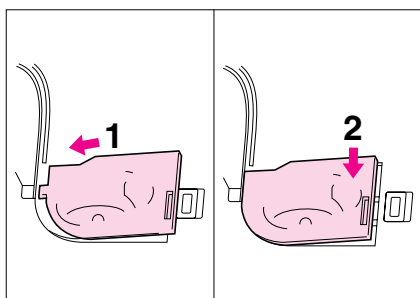

4. Close the bobbin cover by placing the left end in place and pressing down lightly on the right end so that it snaps into place.

* You can begin sewing immediately without drawing up the bobbin thread.

UPPER THREADING

Note

When threading the sewing machine, be sure that one of the presser foot mentioned in this Operation Manual is installed.

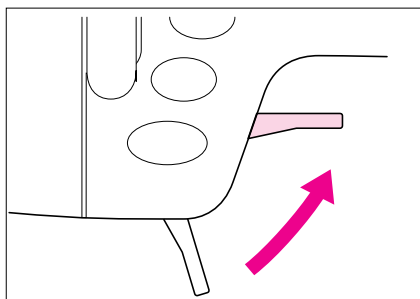
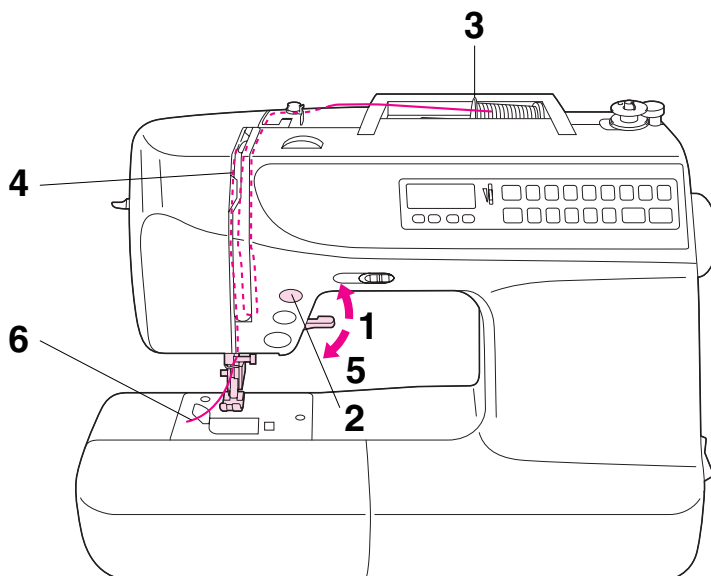

1. Raise the presser foot lever. (If the presser foot is not raised, the upper thread cannot be threaded.)

Note

In order to ensure that the upper threading is done correctly, this sewing machine is equipped with an upper threading shutter which prevents upper threading or needle threading while the presser foot is lowered.

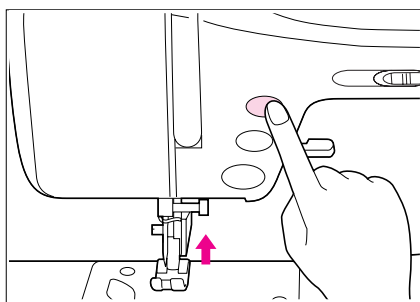

2. Press the "NEEDLE POSITION" button to raise the needle.

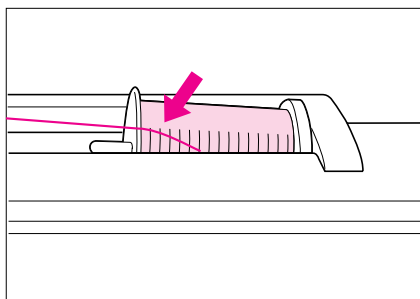

3. Place the spool of thread on the spool pin so that the thread comes from the front of the spool.

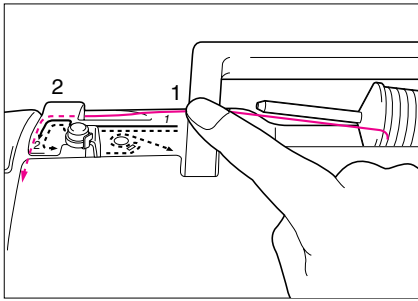

4. While holding the end of the thread with your left hand, pass the thread through the guides in the order shown by the numbers.

Note

- If the thread is pushed down at 1 to make it taut, it can be passed around the other thread guides more easily.
- Incorrectly feeding the thread will result in faulty sewing.

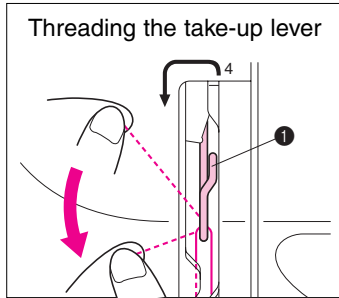
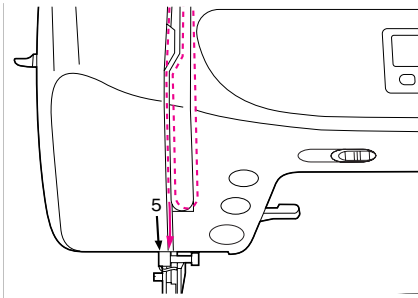

1 Thread take-up lever

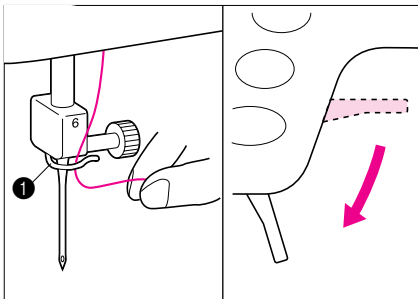

5. Lower the presser foot.
6. Guide the thread through the wire loop and thread through needle eye.

1 Wire loop

- * You do not need to pull the bobbin thread up before you start sewing.

7. Pass the thread underneath the presser foot and pull it out from the rear of the machine by about 5 cm.

Note

Always raise the presser foot before removing the upper thread from the machine or damage may occur to the auto thread tension unit.

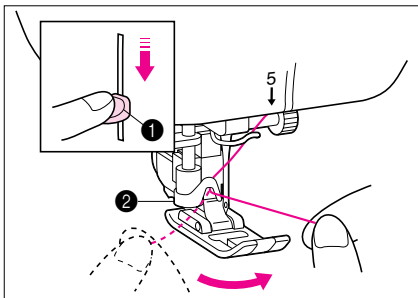

8. When using the auto-threading device, gently pull the thread towards you.

1 Needle threader lever

2 Guide (Large hook)

- * Lowering the presser foot will engage the automatic tension and will allow you to grip the thread as you proceed.

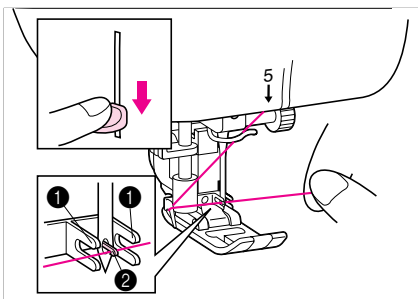

9. Lower the needle threader lever all the way down using your left index finger. Check that the thread is held by the guide (large hook) and that the third hook on the needle threader has passed through the eye of the needle.

1 Second set of hooks

2 Third hook

10. As you lower the needle threader lever, pull the thread to the left and catch it on the large hook. When the needle threader lever is in the lowest position, pull the thread in front of the needle's eye and catch it on the third hook.

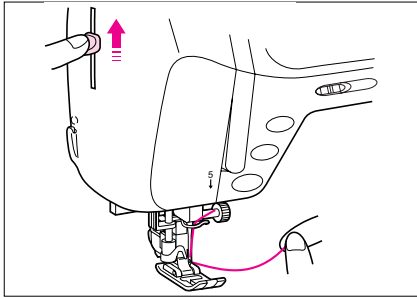

* Rotating your right hand slightly to check that the thread is engaged.

11. While gently holding the thread, raise the needle threader lever.

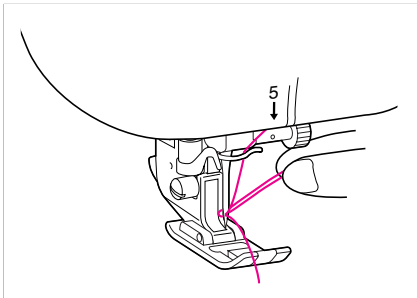

12. Pull the thread towards the rear to finish the upper threading.

13. Pass the thread underneath the presser foot and pull it out from the rear of the machine by about 5 cm.

Using the extra spool pin and the net

Extra spool pin

Use when embroidering with metallic thread.

1. Insert the extra spool pin onto the end of the bobbin winder shaft.
2. Install the spool felt and the thread spool in that order, and then thread the upper thread.

- 1** Insert the extra spool pin into the end of the bobbin winder shaft
- 2** Spool felt
- 3** Thread spool

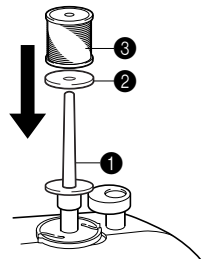

- * When setting the thread spool, set it so that the thread winds off from the front of the spool.
- * If using metallic thread, we recommend that you use a 90/14 home sewing machine needle.

Note

This method keeps the thread from twisting as it comes off the spool pin.

Net

If using special threads which wind quickly off the thread spool, attach a net to the spool before using.

- * Cut the net to match the size of the spool.

- 1** Net
- 2** Thread spool
- 3** Spool pin
- 4** Spool cap

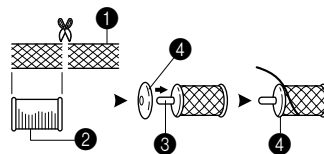

Depending on the model, the net may be available as an optional part.

Needle	Thread (cotton)
65/9	#30, 50, 60
75/11	#30
90/14	#30
100/16	#20

Note

The auto-threading device cannot be used with the combinations shown at left.

Transparent nylon thread can be used regardless of the chart providing needle used is 90/14 to 100/16.

STARTING AND STOPPING SEWING

“START/STOP” button

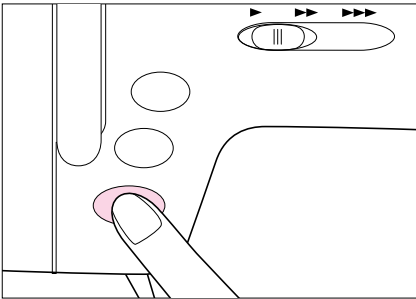

- 1 Place the fabric under the presser foot, lower the presser foot, and then press the “START/STOP” button. The sewing machine starts sewing.
 - * Slide the speed range control lever to adjust the sewing speed.
 - * Hold down the “START/STOP” button to sew at a slow speed.
2. Press the “START/STOP” button to stop the sewing machine.

Foot controller

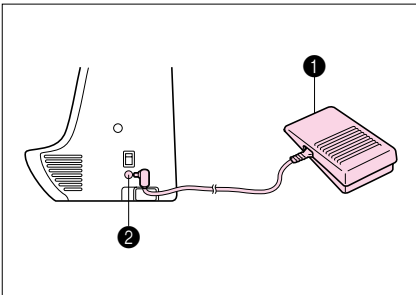

Note

Do not allow fabric pieces and dust to collect in the foot controller. Doing so could cause a fire or an electric shock.

1. With the sewing machine turned off, insert the foot controller plug into its jack on the sewing machine.

- ① Foot controller
- ② Foot controller jack

2. Turn on the sewing machine, then slowly depress the foot controller to start sewing.

* The speed set using the speed range control lever is the foot controller’s maximum sewing speed.

3. Release the foot controller to stop the sewing machine.

* When the foot controller is being used, the “START/STOP” button has no effect on the sewing.

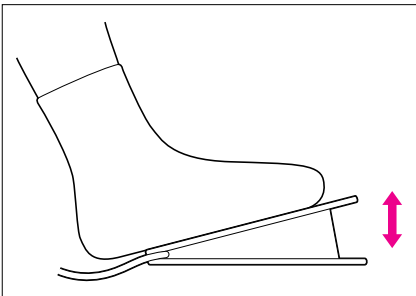

Note (For U.S.A. only)

Foot controller: Model N5V

This foot controller can be used for sewing machine model PC-3000.

SELECTING A STITCH (UTILITY STITCHES)

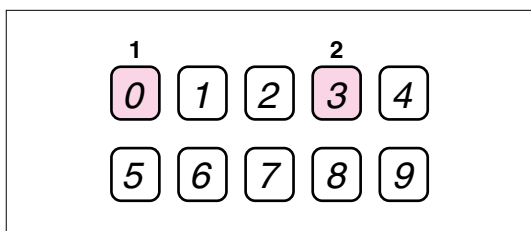

This sewing machine is equipped with 30 built-in utility stitches.

Use the stitch selection keys to enter the number of the stitch that you wish to use. A two-digit number must be entered when selecting the stitch. The selected stitch is shown on the screen.

Note

Before changing the stitch, press the “NEEDLE POSITION” button to raise the needle.

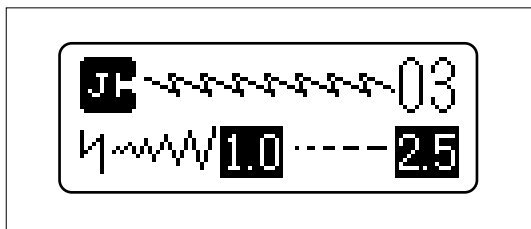

Using the “*info*” (information) key

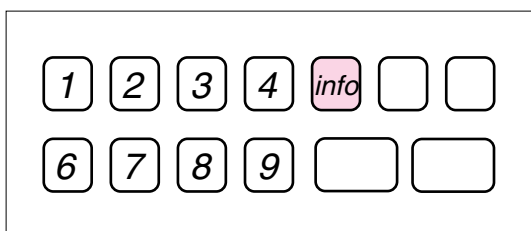































1. Touch “*info*” to display information on the selected stitch.



2. Information on the selected stitch is displayed.

Quick adjustment reference chart for stitch width and stitch length

STITCH		Stitch width [mm (in.)]		Stitch length [mm (in.)]		STITCH		Stitch width [mm (in.)]		Stitch length [mm (in.)]	
		Auto	Manual	Auto	Manual			Auto	Manual	Auto	Manual
Straight (Center)		—	—	2.5 (3/32)	0.2–5.0 (1/128–13/64)	Darning		7.0 (9/32)	2.5–7.0 (3/32–9/32)	2.0 (5/64)	0.4–2.5 (1/64–3/32)
	Straight (Left)		[0.0 (0.0)]	0.0–7.0 (0–9/32)	2.5 (3/32)		0.2–5.0 (1/128–13/64)				
Triple stitch			[0.0 (0.0)]	0.0–7.0 (0–9/32)	2.5 (3/32)	1.5–2.5 (1/16–3/32)	Bar tack		2.0 (5/64)	1.0–3.0 (3/64–1/8)	0.4 (1/64)
Stretch stitch		1.0 (3/64)	1.0–3.0 (3/64–1/8)	2.5 (3/32)	1.0–4.0 (3/64–5/32)	Eyelet		7.0 (9/32)	7.0, 6.0, 5.0 (9/32–13/64)	7.0 (9/32)	7.0, 6.0, 5.0 (9/32–13/64)
Zigzag		3.5 (1/8)	0.0–7.0 (0–9/32)	1.4 (1/16)	0.0–4.0 (0–5/32)	Button sewing		3.5 (1/8)	2.5–4.5 (3/32–3/16)	—	—
Elastic zigzag		5.0 (13/64)	1.5–7.0 (1/16–9/32)	1.0 (3/64)	0.2–4.0 (1/128–5/32)	Applique		3.5 (1/8)	2.5–5.0 (3/32–13/64)	2.5 (3/32)	1.6–2.5 (1/16–3/32)
Overcasting		3.5 (1/8)	2.5–5.0 (3/32–13/64)	2.0 (5/64)	1.0–4.0 (3/64–5/32)	Scallop		5.0 (13/64)	2.5–7.0 (3/32–9/32)	0.4 (1/64)	0.1–1.0 (1/192–3/64)
		5.0 (13/64)	2.5–5.0 (3/32–13/64)	2.5 (3/32)	1.0–4.0 (3/64–5/32)	Patchwork stitch		5.0 (13/64)	2.5–7.0 (3/32–9/32)	2.5 (3/32)	1.0–2.5 (3/64–3/32)
		5.0 (13/64)	3.5–5.0 (1/8–13/64)	2.5 (3/32)	1.0–4.0 (3/64–5/32)	Smocking		5.0 (13/64)	0.0–7.0 (0–9/32)	2.5 (3/32)	2.5–3.0 (3/32–1/8)
		5.0 (13/64)	0.0–7.0 (0–9/32)	2.5 (3/32)	0.5–3.0 (1/64–1/8)	Fagoting		5.0 (13/64)	2.5–7.0 (3/32–9/32)	2.5 (3/32)	1.0–2.5 (3/64–3/32)
Blind hem stitch		0.0 (0.0)	+3 – –3	2.0 (5/64)	1.0–3.5 (3/64–1/8)	Decorative stitch		4.0 (5/32)	0.0–7.0 (0–9/32)	2.5 (3/32)	1.0–4.0 (3/64–5/32)
											
Buttonhole		5.0 (13/64)	3.0–5.0 (1/8–13/64)	0.4 (1/64)	0.3–1.0 (1/64–3/64)						
		5.0 (13/64)	3.0–5.0 (1/8–13/64)	0.4 (1/64)	0.2–1.0 (1/128–3/64)						
		6.0 (1/4)	3.0–6.0 (1/8–1/4)	1.0 (3/64)	0.5–2.0 (1/64–5/64)						
		6.0 (1/4)	3.0–6.0 (1/8–1/4)	1.5 (1/16)	1.0–3.0 (3/64–1/8)						
											
		7.0 (9/32)	3.0–7.0 (1/8–9/32)	0.5 (1/64)	0.3–1.0 (1/64–3/64)						
											

—: Not adjustable

THREAD TENSION

Correct upper thread tension

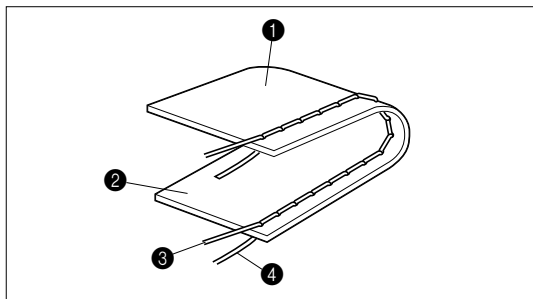
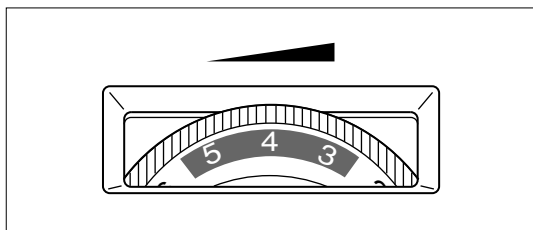

The thread tension is normally set on “4” for general sewing applications. (Refer to the FABRIC/THREAD/NEEDLE COMBINATION CHART on page 27.)

However, the thread tension dial can be used to adjust the tension of the upper thread in the following cases.

- * when using specialty threads or sewing on special fabric
- * when sewing gathers, shirring or shell tucks
- * when the normal settings do not give the desired result

The upper thread and the bobbin thread should cross at about the center of the fabric. If the thread tension is incorrectly set, flat attractive seams will not be sewn or the fabric will pucker.

- ① Reverse side
- ② Surface
- ③ Upper thread
- ④ Bobbin thread

Loosening the upper thread tension

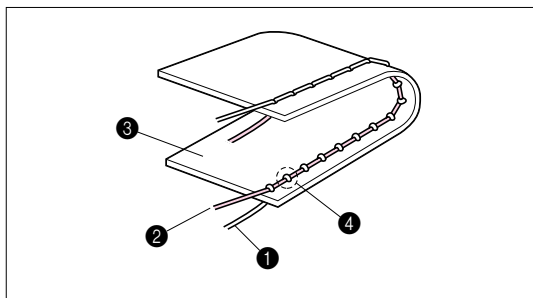
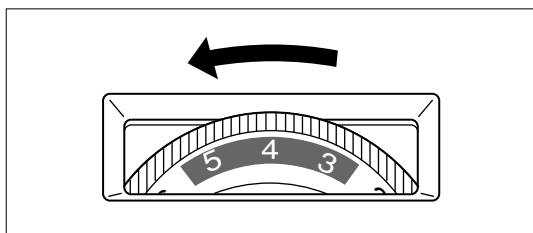

Turn the thread tension dial to the left to loosen the upper thread tension.

- ① Bobbin thread
- ② Upper thread
- ③ Surface
- ④ If the upper thread tension is too strong, locks appear on the surface of the fabric.

Tightening the upper thread tension

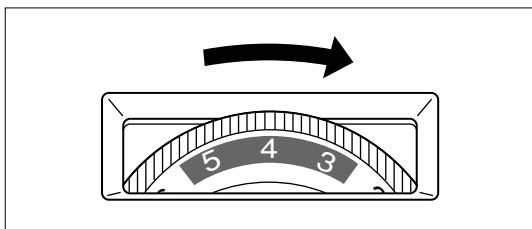

Turn the thread tension dial to the right to tighten the upper thread tension.

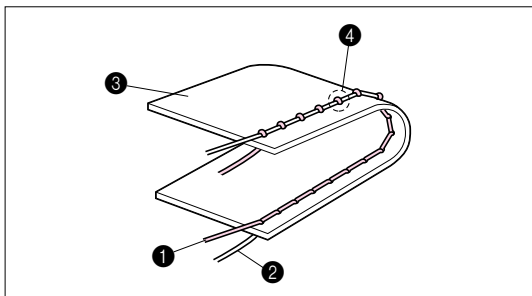

- ① Upper thread
- ② Bobbin thread
- ③ Reverse side
- ④ If the upper thread tension is too weak, locks appear on the reverse side of the fabric.

PRESSER FOOT

Changing the presser foot

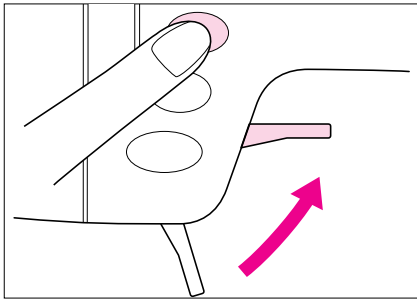

1. Press the “NEEDLE POSITION” button to raise the needle, and then turn off the power.
2. Raise the presser foot lever.

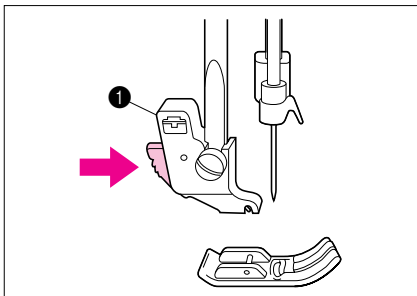

3. Press the black button located at the back of the presser foot holder to release the foot.

❶ Presser foot holder

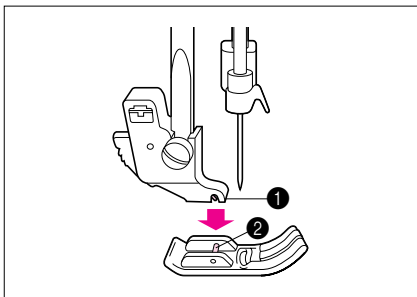

4. Place the presser foot pin directly below the holder-end and lower the presser foot lever to attach the presser foot.

❶ Holder-end

❷ Foot pin

Removing the presser foot holder (while cleaning, etc.)

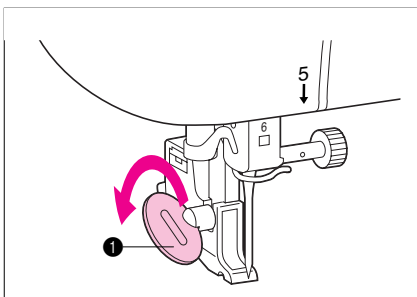

Loosen the presser foot holder screw, then pull the presser foot holder down to remove it.

Note

When reattaching the presser foot holder, first attach the presser foot to the presser foot holder. Then, lower the presser foot lever, install the presser foot holder and securely tighten the presser foot holder screw. The thread tension may be inaccurate if the presser foot holder is incorrectly attached.

❶ Disc-shaped screwdriver

FEED DOGS

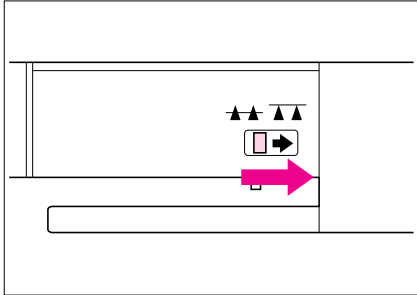

With the accessory compartment off the machine, the feed dog adjustment lever can be seen on the base of the sewing machine. Sliding the lever to the right will lower the feed dogs, for example during button sewing.

If you wish to continue sewing normally, slide the lever to the left in order to raise the feed dogs.

The feed dogs cannot be raised if the balance wheel does not turn, even if the lever is slid to the left.

NEEDLE

Checking the needle

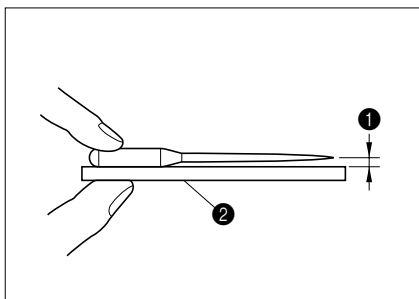

Place the needle on a flat surface and check whether the space between the needle and the flat surface is parallel or not.

If the space is not parallel then the needle is bent and should be thrown away to prevent damage to your project or to the machine.

- ❶ Space between the needle and the flat surface
- ❷ Flat surface (needle plate, glass, ruler, etc.)

Installing the needle securely

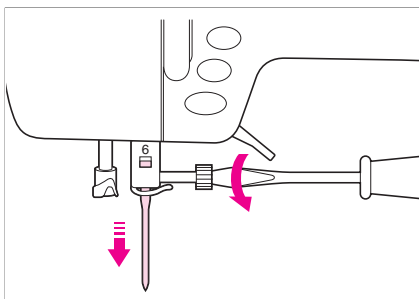

1. Press the “NEEDLE POSITION” button to raise the needle.
2. Turn off the power and lower the presser foot.
3. Loosen the needle clamp screw with a screwdriver.
4. Pull out the needle.

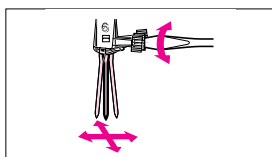

CAUTION
Do not loosen or tighten the needle clamp screw with a strong force, otherwise it may be damaged

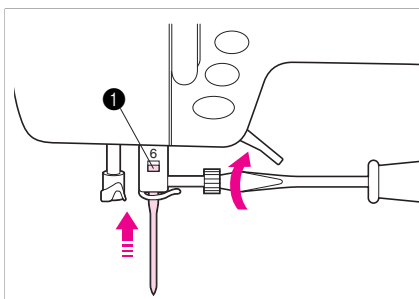

5. With the flat side of the needle facing the back, insert the needle as far as it will go up against the needle stopper. Fasten the screw securely with a screwdriver.
- ❶ Needle stopper
6. Turn the power on.

FABRIC/THREAD/NEEDLE COMBINATION CHART

Today there are many different types of needles to suit a variety of sewing needs. Be sure to select the correct needle for a specific sewing project. For example, there are needles for denim material and others for sewing with metallic threads.

Sewing fabrics		Thread		Needle size
		Type	Size	
Medium	Broad cloth	Cotton	60-80	11-14
	Taffeta	Synthetic mercerized	60-80	
	Flannel, Gabardine	Silk	50-80	
Thin	Lawn	Cotton	60-80	9-11
	Georgette	Synthetic mercerized	60-80	
	Challis, Satin	Silk	50-80	
Thick	Denim	Cotton	40-50	14-16
	Corduroy	Synthetic mercerized	50	
	Tweed	Silk	50	
Stretch	Jersey	Synthetic mercerized (Thread for knits)	50	Golden needle 11-14
	Tricot			
Easily frayed fabric		Cotton	50-80	9-14
		Synthetic mercerized	50-80	
		Silk	50-80	
For top stitching		Synthetic mercerized	30	14-16
		Silk	30	

- * Use the golden needle when sewing on stretch fabrics and fabrics where skipped stitches easily occur.
- * Use a needle with a size between 14 and 16 when sewing with transparent nylon thread.

TRIAL SEWING

Sewing using a utility stitch

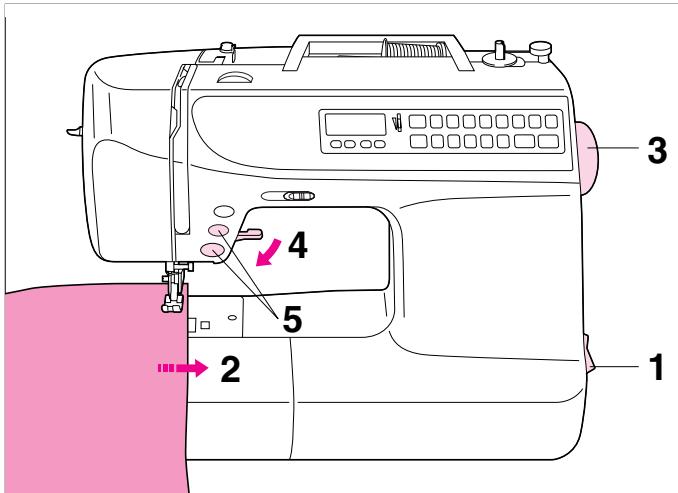

CAUTION

- Be aware of the needle at all times while sewing, and keep your hands away from all moving parts such as the needle, balance wheel and thread take-up lever, otherwise an injury may result.
- Do not pull or push the fabric too hard while sewing, otherwise injury may result.
- Never use bent needles. Such needles can easily break, which could result in injury.

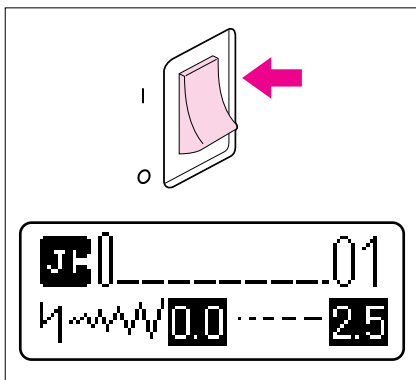

1. Turn on the sewing machine. The straight stitch (left) is selected.

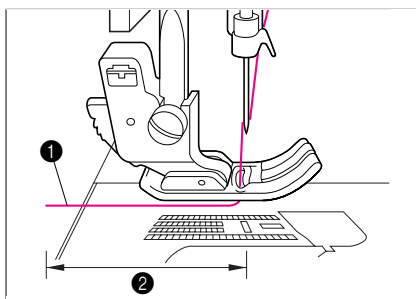

2. Place the fabric under the presser foot, then pull out about 5 cm (2") of the upper thread and pass it under the presser foot toward the rear of the machine.

- ① Upper thread
- ② 5 cm (2")

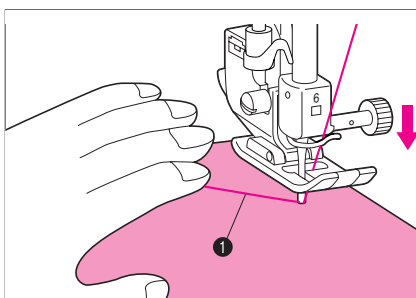

3. While pressing down on the thread and the fabric with your left hand, turn the balance wheel with your right hand to move the needle to the sewing start position.

- ① Thread

* You can begin sewing without drawing up the bobbin thread.

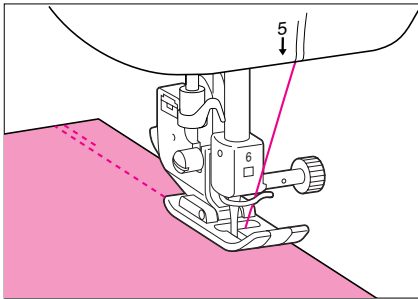

4. Lower the presser foot. Press the “REVERSE STITCH” button to sew a few reverse stitches, and then press the “START/STOP” button. The machine will start sewing at a slow speed.

* Reverse stitches are sewn while the “REVERSE STITCH” button is pressed.

* The sewing speed cannot be adjusted while reverse stitches are sewn.

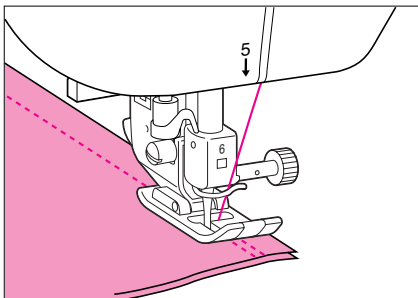

5. When sewing is completed, press the “REVERSE STITCH” button to sew a few reverse stitches.

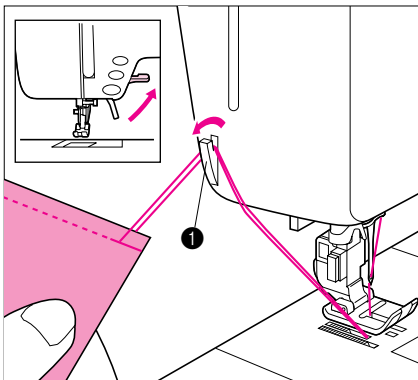

6. Raise the presser foot, remove the fabric and cut the thread.

① **Thread cutter**

AUTOMATIC REINFORCEMENT STITCHING

Before beginning to sew, touch this key to sew reinforcement stitches (reverse stitches if the straight stitch was selected) automatically at the beginning of the stitch when the “START/STOP” button is pressed and at the end of the stitch when the “REVERSE STITCH” button is pressed.

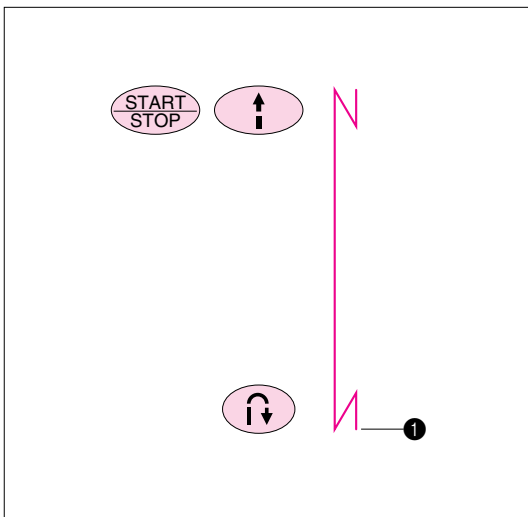
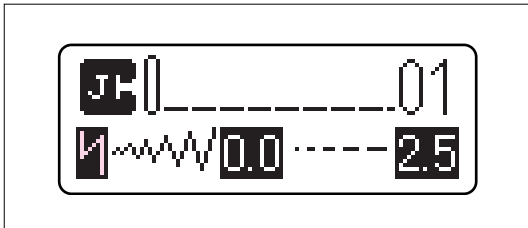
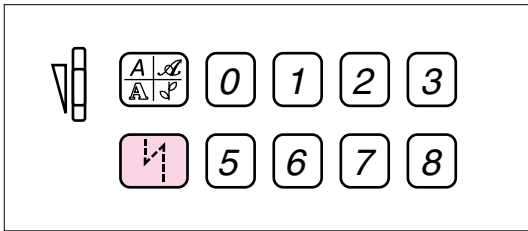

1. Select a stitch, then touch the automatic reinforcement stitching key to change it to black.

* The reinforcement stitching is automatically sewn when some stitches such as the buttonhole and bar tack are selected.

2. Press the “START/STOP” button to sew reinforcement stitches (reverse stitches if the straight stitch was selected) automatically, then start sewing.

* To pause sewing, press the “START/STOP” button. If the sewing is paused, the ending reinforcement stitches will not be sewn automatically.

3. To finish the stitch, press the “REVERSE STITCH” button to sew ending reinforcement stitches (reverse stitches if the straight stitch was selected) automatically before the machine stops.

❶ The machine automatically stops.

Cancelling automatic reinforcement stitching

Touch the automatic reinforcement stitching key to change it back to white.

STITCH WIDTH AND LENGTH

Adjusting the stitch width

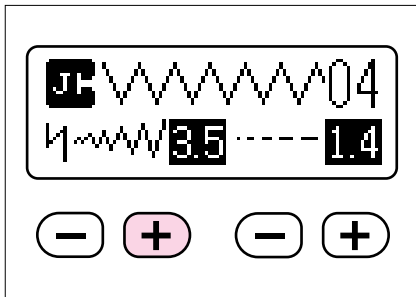

Making the stitch wider

Press the “+” stitch width key. Each press of the key increases the width of the stitch.

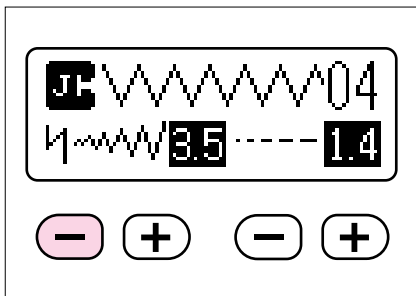
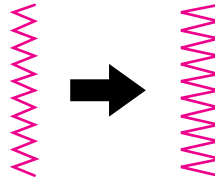

Making the stitch narrower

Press the “-” stitch width key. Each press of the key decreases the width of the stitch.

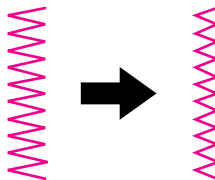

Adjusting the stitch length

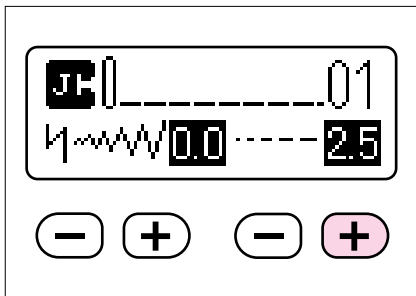

Making the stitch longer

Press the “+” stitch length key. Each press of the key increases the length of the stitch.

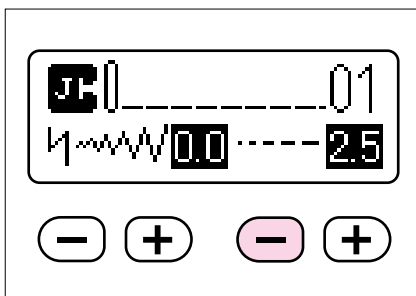
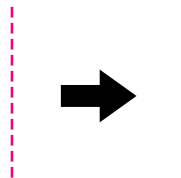

Making the stitch shorter

Press the “-” stitch length key. Each press of the key decreases the length of the stitch.

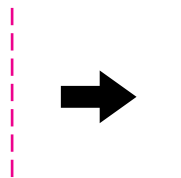

USEFUL SKILLS

Sewing corners

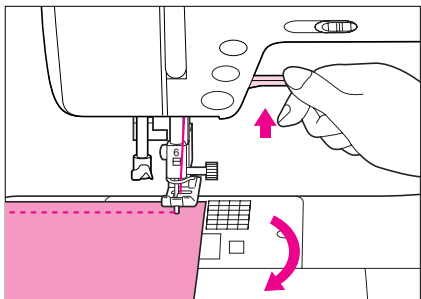

Stop the sewing machine with the needle in the fabric at the corner, then raise the presser foot and turn the fabric.

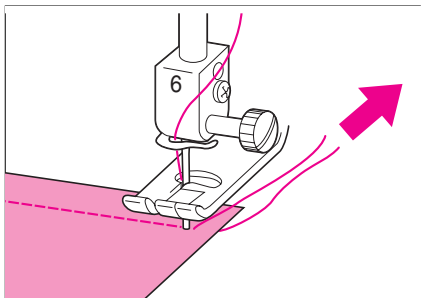

When sewing seams which are less than 5.0 mm (13/64" in width), baste the corner, then continue sewing while slowly changing the sewing direction and pulling the basting thread toward the rear of the machine.

Sewing folded parts

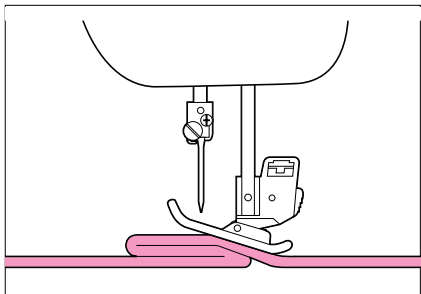

Support the fabric while feeding by hand and sew the fabric toward the folded side.

Sewing curves

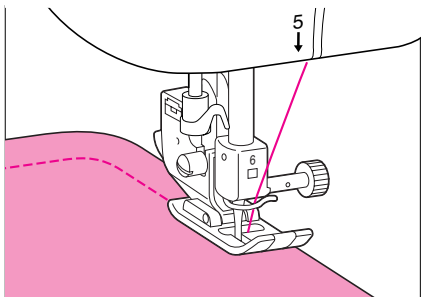

Sewing a curve with a straight stitch

Sew slowly while keeping the seam parallel to the fabric edge as you guide the fabric around the curve.

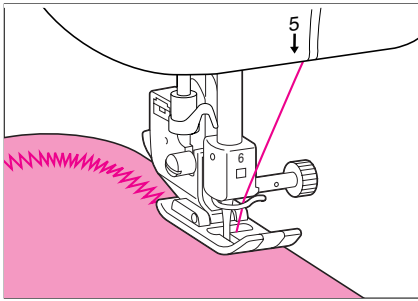

Sewing a curve with a zigzag stitch

Set the stitch length short in order to obtain a fine stitch. Sew slowly while keeping the seam parallel to the fabric edge as you guide the fabric around the curve.

- * For sharp corners, temporarily stop sewing with the needle in the material, then raise the presser foot and carefully turn the fabric while keeping it level with the presser foot. Lower the presser foot and continue sewing.

Sewing on thick fabric

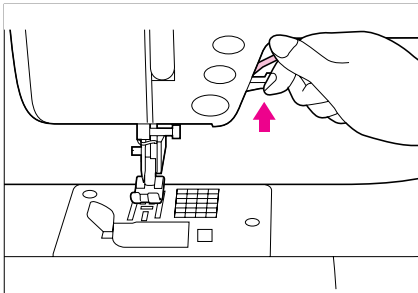

1. Raising the presser foot lever even further raises the presser foot to a higher position allowing you to sew on thicker fabrics. With the presser foot in the up position, raise the presser foot lever even higher to make room for thicker fabrics.

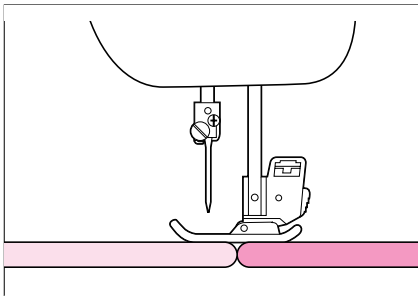

2. If the fabric will not feed at the beginning of sewing, place another piece of fabric with the same thickness at the back of the material.

Sewing on thin fabric

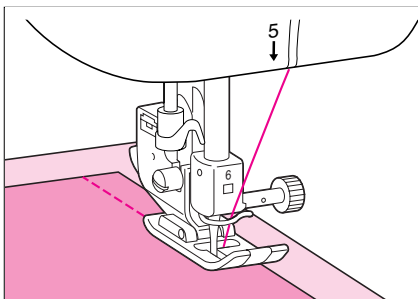

Place thin paper or stabilizer material under the fabric before sewing.

- * Use a straight stitch foot to eliminate any puckering. Remember to select the center needle position. Additional adjustment of stitch length and tension may be necessary.

Using the needle plate

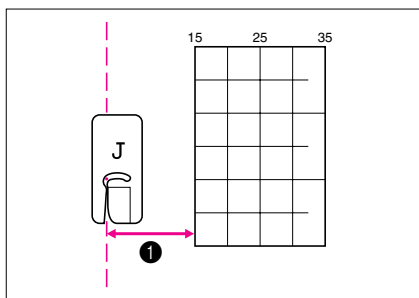

Align the edge of the fabric with a line on the needle plate to sew even seam allowances.

❶ 1.5 cm (19/32")

Free-arm sewing

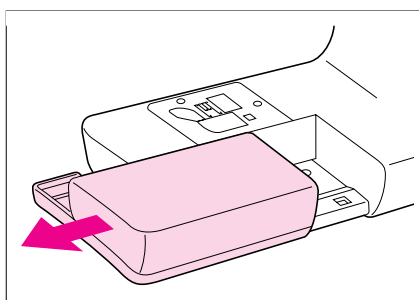

Free-arm sewing is convenient for sewing tubular areas such as pant hems and cuffs.

2. UTILITY STITCHES

STRAIGHT STITCHES



- 00: Straight stitch (center needle position) for normal sewing**
01: Straight stitch (left needle position) for normal sewing
02: For reinforced sewing
03: For stretch fabric

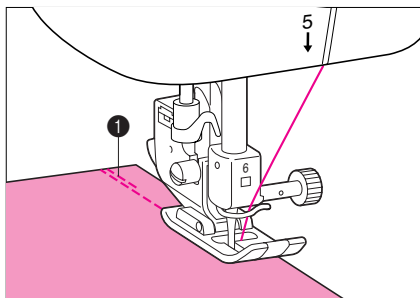

1. Baste or pin the fabrics together.
2. Attach presser foot "J", sew three or four reverse stitches at the beginning, then start sewing.

① 3 to 4 reverse stitches

- * Place the fabric under presser foot allowing enough space from the edge for reverse sewing.

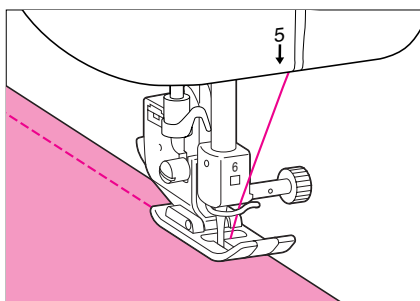

3. Sew at a slow speed as you approach the end of the sewing area, then press the "REVERSE STITCH" button to sew several reverse stitches and stop the machine.

- * Before sewing, touch the automatic reinforcement stitching key to sew reverse stitches or reinforcement stitches automatically at the beginning and at the end of the stitch.

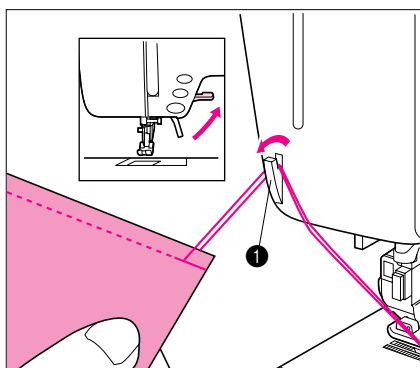

4. Raise the presser foot, remove the fabric and cut the thread.

① Thread cutter

Sewing stretch fabrics

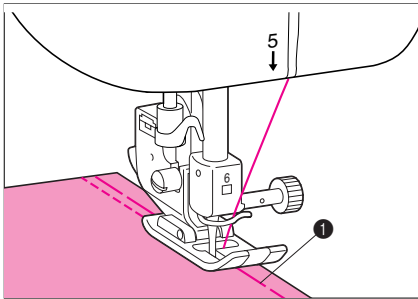

Baste the fabric pieces together, then sew along the basting without pulling the fabric.

* Do not pull the fabric while sewing.

1 Basting

Changing the stitch length

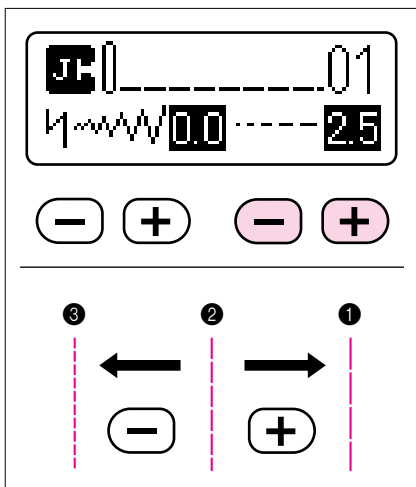

Touch the “**-**” or “**+**” stitch length keys to adjust the stitch length.

- 1 **+**: Longer
- 2 **Automatic stitch length setting: 2.5 mm (3/32")**
- 3 **-**: Shorter

* For thin material which is less than 1.0 mm (3/64") thick, the maximum stitch length will automatically be set to 4.0 mm (5/32") while sewing, even if the length is set to 5.0 mm (13/64").

Changing the needle position

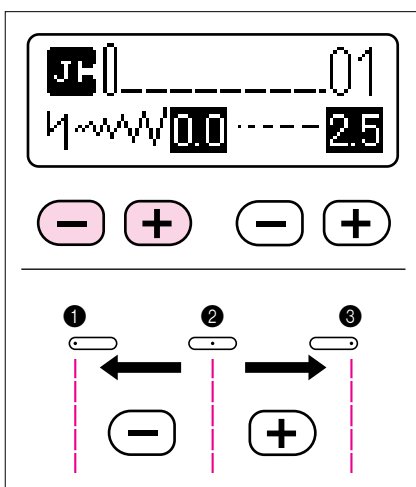

Touch the “**-**” and “**+**” stitch width keys to adjust the needle position.

- 1 **-**: 0 mm (0") [left needle position]
- 2 **Center needle position: 3.5 mm (1/8")**
- 3 **+**: 7.0 mm (9/32") [right needle position]

* The needle position cannot be changed in the straight stitch center needle position setting.



04



05



04: Zigzag stitch

05: Elastic zigzag stitch

Overcasting (using a zigzag stitch)

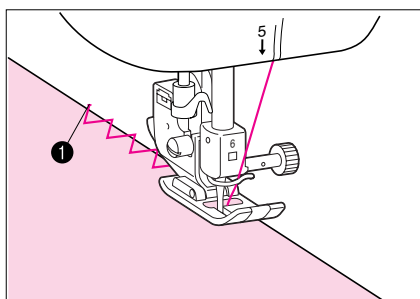

Sew the overcasting along the edge of the fabric so that the needle drops over the edge of the fabric on the right side.

- ❶ Needle drop point on the right side

Applique (using a zigzag stitch)

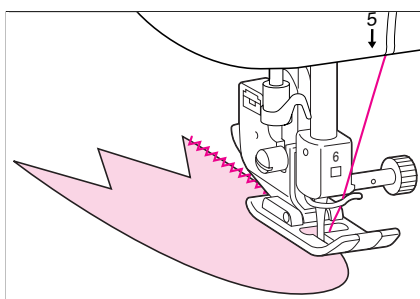

Attach the applique using adhesive or basting, then sew on the applique so that the needle drops over the edge of the applique on the right side.

Patchwork (for crazy quilts)

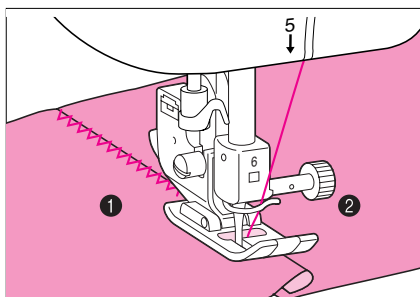

Fold back the desired width of fabric and position it over the lower fabric, then sew the fabric together so that the stitch extends over both pieces of fabric.

- ❶ Upper fabric
- ❷ Lower fabric

OVERCASTING STITCHES



- 05: For stretch fabric
- 06: For thin and medium fabric
- 07: For thick fabric
- 08: For medium, thick and easily frayed fabric
- 09: For stretch fabric

Sewing using stitch ⁰⁶ , ⁰⁷ or ⁰⁸

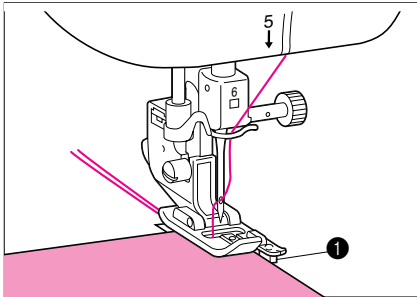

Sew the fabric with the fabric edge against the guide of presser foot "G".

1 Guide

* Before sewing, touch the automatic reinforcement stitching key to sew reinforcement stitches automatically at the beginning and at the end of the stitch.

CAUTION

After the stitch width has been adjusted, turn the balance wheel by hand and check that the needle does not touch the presser foot. If it does touch, the needle may break and cause an injury.

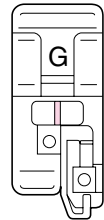

Sewing using stitch ⁰⁵ or ⁰⁹

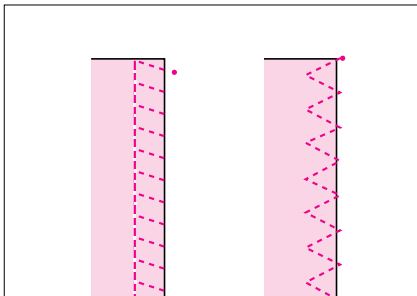

Attach presser foot "J" and let the needle drop slightly past the edge of the fabric before starting sewing.

* Before sewing, touch the automatic reinforcement stitching key to sew reinforcement stitches automatically at the beginning and at the end of the stitch.

OVERCASTING (WHEN USING THE OPTIONAL SIDE CUTTER)

00
—

05
~

06
W

07
W

08
▨

00: Normal sewing

05: Zigzag stitch

06: Thin and medium fabrics

07: Thick fabric

08: Thick and medium stretch fabrics

By using the side cutter, you can do overcasting while cutting the fabric.

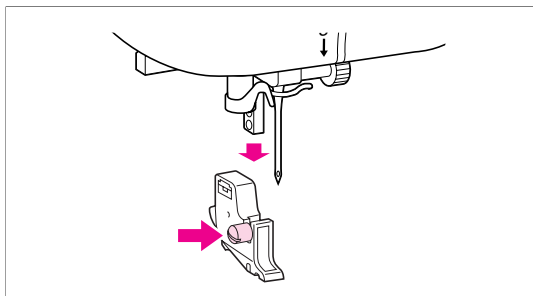

1. Push the “NEEDLE POSITION” button to raise the needle, and then turn off the power.

2. Raise the presser foot lever.

3. Unscrew screw on the presser foot holder and remove the presser foot holder.

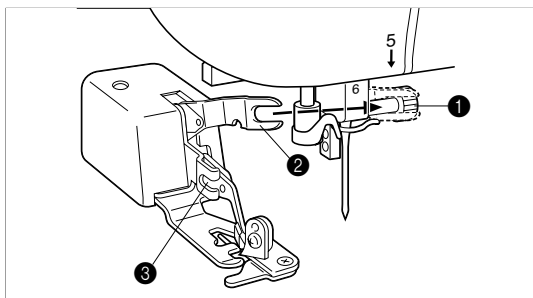

4. Set the screw of the needle into the fork of the operating lever.

① Screw of the needle

② Operating lever

③ Notch

* Make sure that the needle clamp screw is held firmly by the fork.

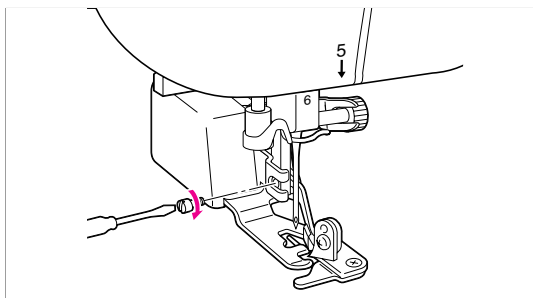

5. With the presser foot raised, align the presser foot holder screw hole directly with the notch in the side cutter, then insert the screw and lightly tighten it. Lower the presser foot lever and firmly tighten the screw.

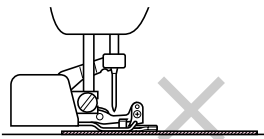
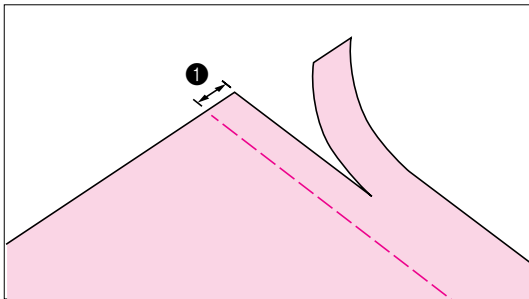
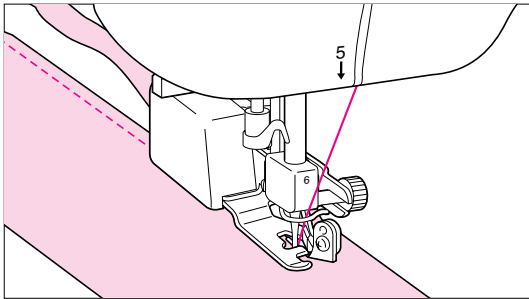
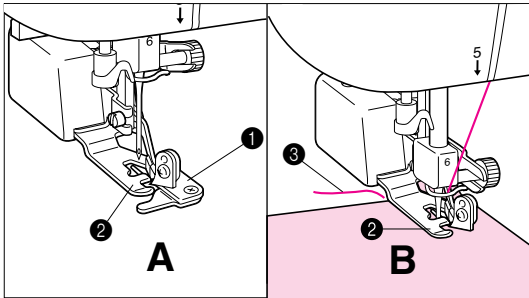
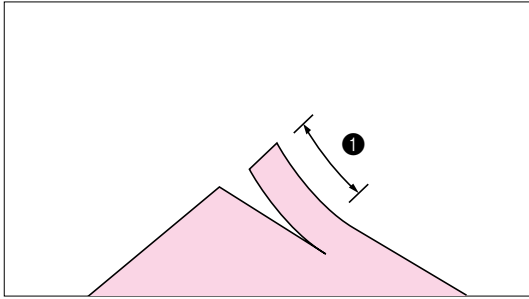

6. Make a cut of about 2 cm (13/16") in the fabric.

❶ 2 cm (13/16")

7. Place the fabric as shown left figure B.
 –Right side of cut: on top of the guide plate
 –Left side of cut: underneath of the presser foot

❶ Guide plate (lower knife)
 ❷ Presser foot

8. Thread the needle, and then pull out a long section of the upper thread, pass it below the presser foot and pull it out in the fabric feed direction. (See left figure B)

❷ Presser foot
 ❸ Upper thread

9. Lower the presser foot lever.

CAUTION

If the width has been adjusted, turn the balance wheel by hand to check that the needle does not touch the side cutter. If the needle touches the side cutter, it may cause the needle to break.

When sewing straight stitches only

The seam margin should be about 0.5 cm (13/64").

❶ Seam margin

- * Clean the side cutter after use, otherwise dust and scraps of thread will build up on it.
- * Add a small amount of oil as required to the cutting edge of the cutter.

Note

- The fabric will not be cut if the whole fabric is simply spread out underneath the presser foot guide plate. Set the fabric as explained in step 7. above, and start sewing.
- Check that the needle is raised when the presser foot lever is raised.
- One layer of 13-oz denim can be cut.



10

11

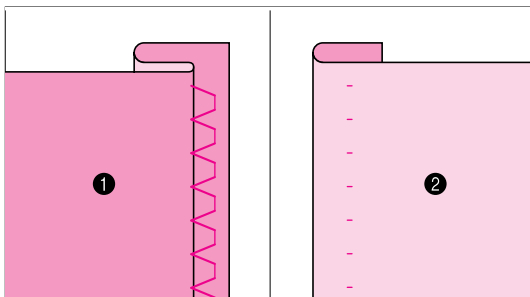
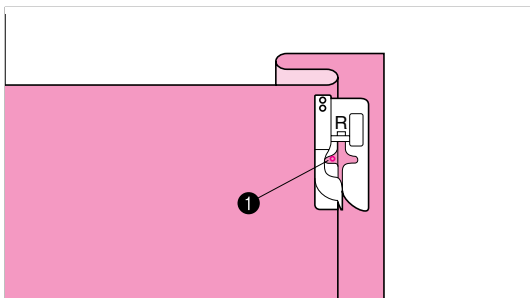
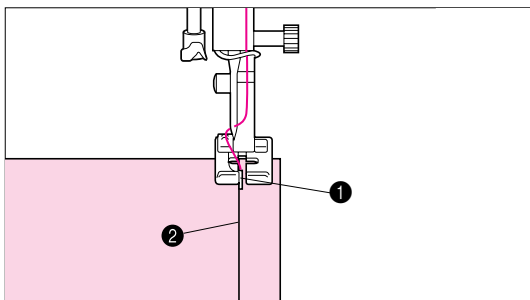
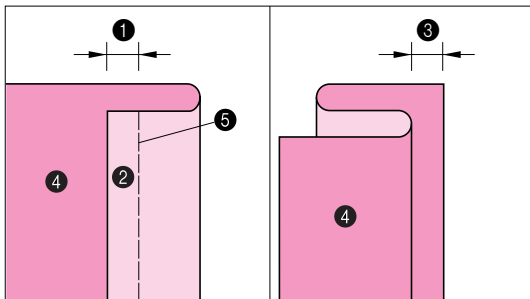

10: For other fabric
11: For stretch fabric

1. Fold the fabric and baste it as illustrated.

- ① 0.5 cm (13/64")
- ② Surface
- ③ 0.5 cm (13/64")
- ④ Reverse side
- ⑤ Basting

2. Attach presser foot "R". Lower the presser foot so that its guide aligns with the edge of the folded hem.

- ① Guide
- ② Folded hem

3. Adjust the needle position using the "⊖" and "⊕" stitch width keys so that needle slightly catches the fold of the hem, then sew the fabric.

- ① Needle drop point

* Before sewing, touch the automatic reinforcement stitching key to sew reinforcement stitches automatically at the beginning and at the end of the stitch.

4. Turn over the fabric and remove the basting stitch.

- ① Reverse side
- ② Surface

Adjusting the needle drop point

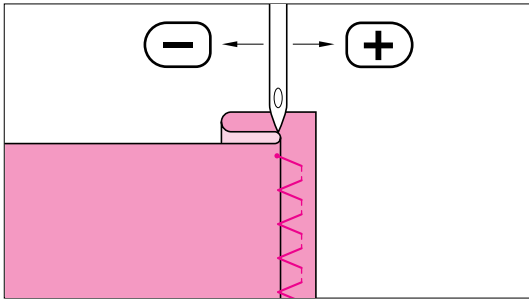

Touch the “-” and “+” stitch width keys to adjust the needle drop point so that the needle slightly catches the fold of the hem.

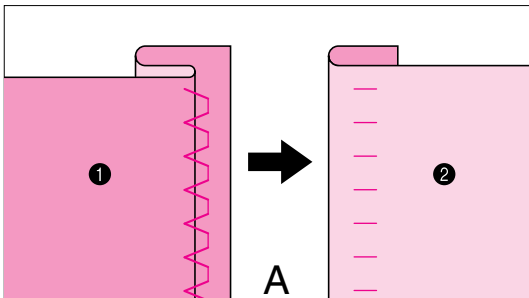

A- If the needle catches too much of the hem fold, touch the “+” stitch width key. This moves the needle away from the fold.

- 1 Reverse side
- 2 Surface

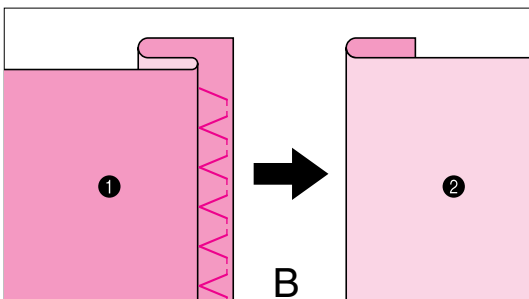

B- If the needle does not catch enough of the hem fold, touch the “-” stitch width key. This moves the needle closer to the fold.

- 1 Reverse side
- 2 Surface

BUTTONHOLE STITCHING



12



13



14



15



16



17



18



12: For horizontal holes on blouses or shirts made from thin or medium fabric

13: For thin or medium fabric

14: For jeans or stretch fabric with a coarse weave

15: For stretch fabric

16: For suits or overcoats

17: For jeans or trousers

18: For thick coats

Note

Before sewing a buttonhole on your project, practice on a scrap piece of the same type of fabric.

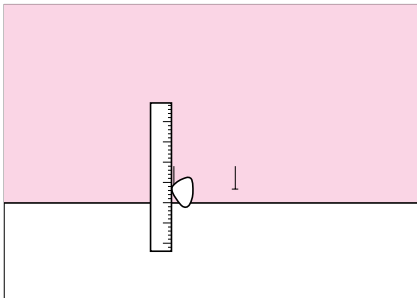

1. Mark the positions of the buttonholes on the fabric.

* The maximum buttonhole length is 3 cm (1-13/64") (total of diameter + thickness of button).

* Thick thread (#30) cannot be used with the "14" and "15" buttonhole styles.

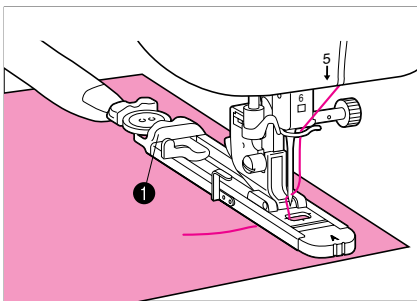

2. Attach presser foot "A", then pull out the button holder plate and insert the button.

1 Button holder plate

* The size of the buttonhole is determined by the button inserted in the button holder plate.

Note

The thread should be passed through the hole in the presser foot, then be placed under the foot.

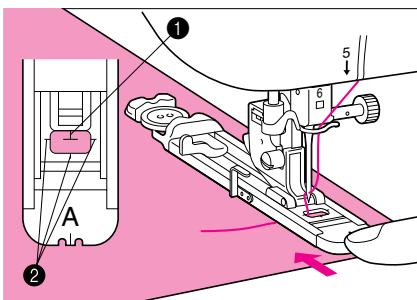

3. Raise the presser foot and adjust the fabric so that the red marks on the foot align with the starting mark for your buttonhole, then lower the presser foot.

1 Mark on fabric for buttonhole position

2 Red marks on presser foot

* After the presser foot lever has been lowered, adjust the presser foot so that there is no gap behind the section that is shaded in the illustration at the right. Otherwise, the size of the stitch will not be correct. To adjust the presser foot, push the presser foot towards the back of the machine as shown in the figure at the left.

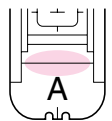

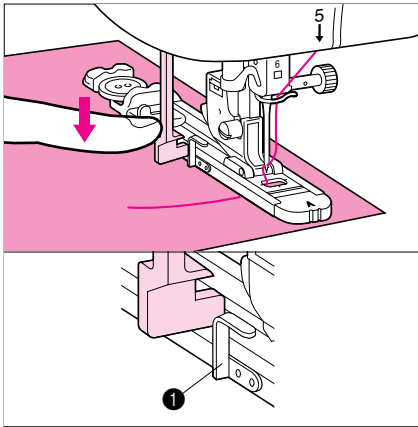

4. Lower the buttonhole lever and position it behind the metal bracket on the buttonhole foot.

1 Metal bracket on the buttonhole foot

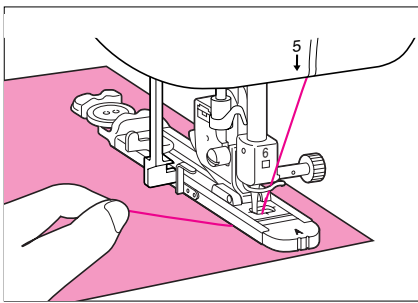

5. While lightly holding the end of the upper thread, press the "START/STOP" button to start sewing.

- * Gently feed the fabric by hand.
- * Before stopping, the machine will automatically sew a reinforcement stitch after the buttonhole is sewn.
- * If the fabric does not feed (for example, because the fabric is too thick), touch the "⊕" stitch length key to increase the stitch length.

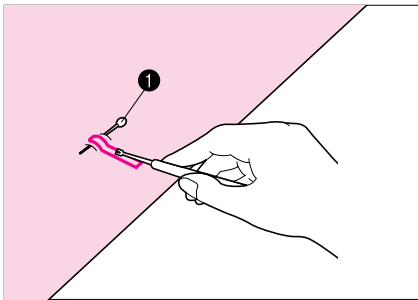

6. Open the buttonhole.

Normal buttonhole and rounded buttonhole

Insert a pin in front of the inside edge of both bar tacks. Insert the seam ripper into the center of the buttonhole and cut toward the first pin, then cut toward the other pin.

1 Pin

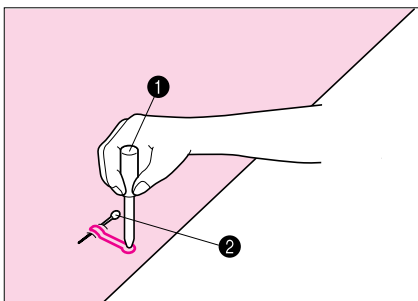

Keyhole buttonhole

Make a hole using the small eyelet punch in the key end, then insert a pin in front of the inside edge of the bar tacks. Insert a seam ripper into the hole made with the eyelet punch and cut towards the pin.

1 Small eyelet punch (accessory #9 on page 6)

2 Pin

Buttonhole sewing order

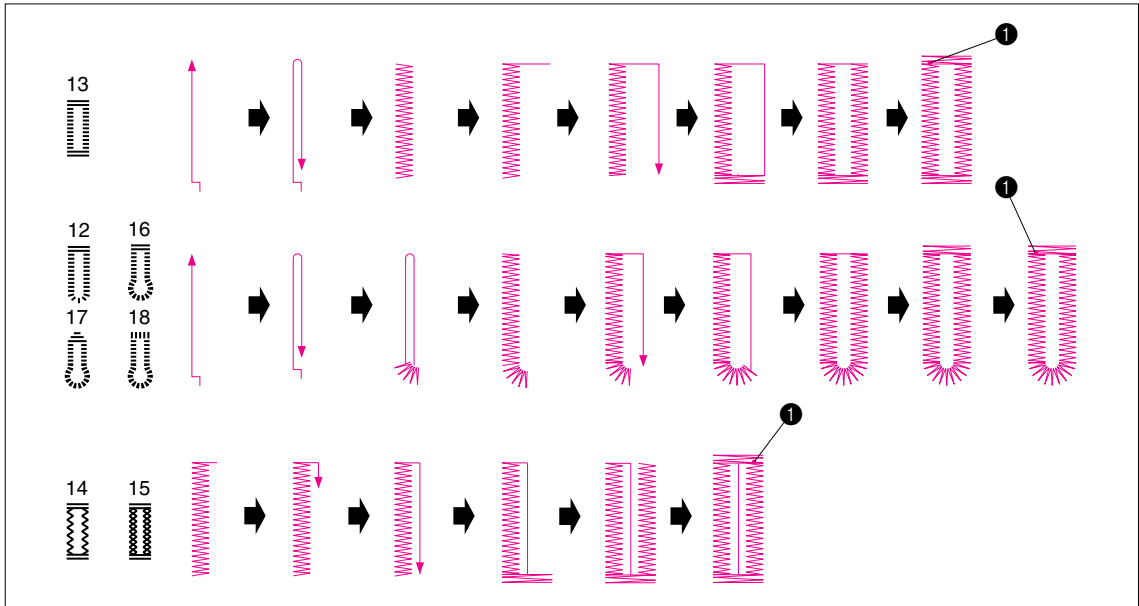

① Reinforcement stitch

Sewing stretch fabrics (“¹⁴” and “¹⁵”)

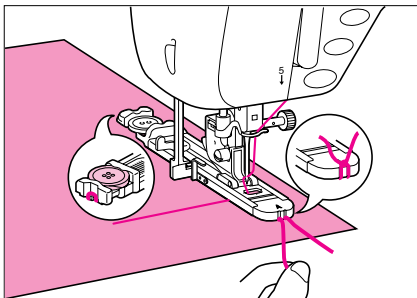

When sewing buttonholes on stretch fabric, insert a gimp thread under the buttonhole stitch.

1. Attach presser foot “A” and hook the gimp thread onto the back of the presser foot. Bring the two gimp thread ends to the front of the foot and insert them into the grooves, then temporarily tie them there.

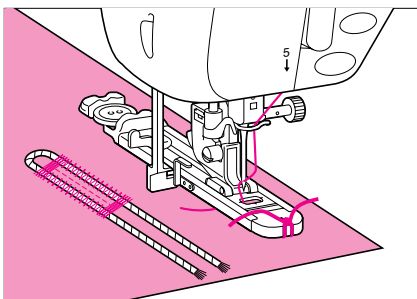

2. Lower the presser foot and start sewing.

* Set the stitch width to match the diameter of the gimp thread.

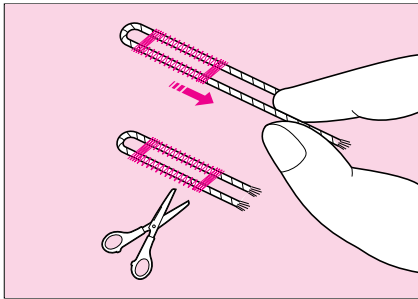

- Once sewing is completed, pull the gimp thread gently to remove any slack, then trim off any excess.

Buttons that do not fit into the guide plate (Odd-shaped buttons)

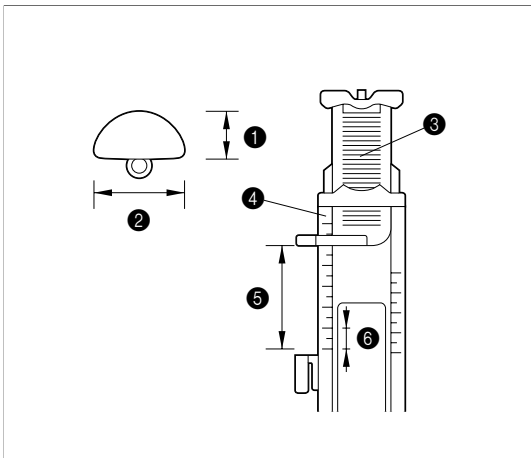

Measure the button diameter + thickness to set the plate.

Example:

For a button with a diameter of 1.5 cm (19/32") and a thickness of 1 cm (25/64"), the scale should be set at 2.5 cm (1")

- ① Thickness [1 cm (25/64")]
- ② Diameter [1.5 cm (19/32")]
- ③ Button holder plate
- ④ Scale
- ⑤ Diameter + thickness [2.5 cm (1")]
[0.5 cm (13/64") in one scale.]
- ⑥ 0.5 cm (13/64")

Changing the stitch length

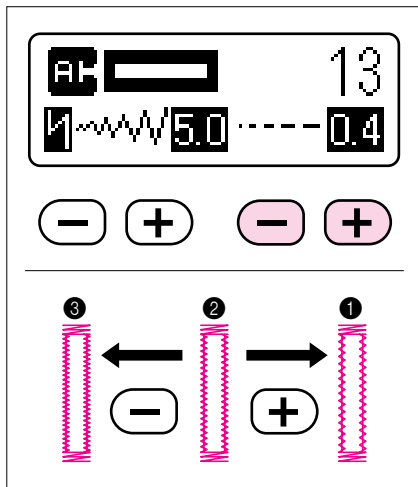

Touch the “+” or “-” stitch length key to select the desired length.

- ① (+): Longer
- ② Automatic stitch length setting: 0.4 mm (1/64")
- ③ (-): Shorter

* If the fabric does not feed (for example, because the fabric is too thick), touch the “+” stitch length key to increase the stitch length.

Changing the stitch width

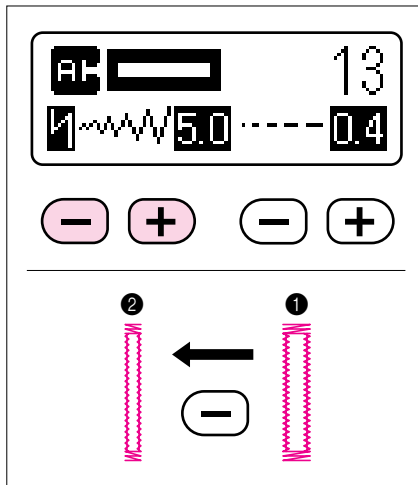

Touch the “+” or “-” stitch width key to select the desired width.

- ① Automatic stitch width setting: 5.0 mm (13/64")
- ② (-): Narrower



21

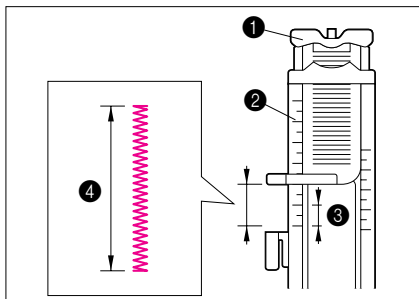

For reinforcing the openings of pockets, etc.

1. Measure the area to be bar tacked and set the length using the scale on presser foot "A". Pull on the end of the button holder plate to expand it. The finished size of the bar tack will be the space shown in the illustration.

- ❶ Button holder plate
- ❷ Scale on the presser foot
- ❸ 0.5 cm (13/64")
- ❹ Length of bar tack

* 0.5 to 3 cm (13/64" to 1-13/64") is suitable for bar tacking. 0.5 to 1 cm (13/64" to 25/64") is the normal size.

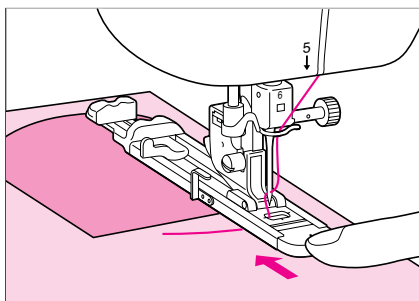

2. Position the pocket as illustrated with the top of the pocket facing you. Align the needle drop point with the corner of the pocket to be stitched and move the pocket back 2 mm (5/64") as shown below.

* After the presser foot lever has been lowered, adjust the presser foot so that there is no gap behind the section that is shaded in the illustration at the right. Otherwise, the size of the stitch will not be correct. To adjust the presser foot, push the presser foot towards the back of the machine as shown in the figure at the left.

* Pass the thread underneath the presser foot.

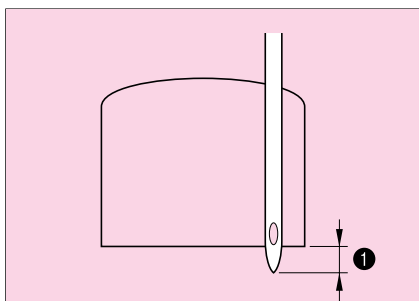
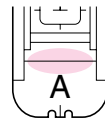

3. Check the first needle drop point, then lower the presser foot.

- ❶ 2 mm (5/64")

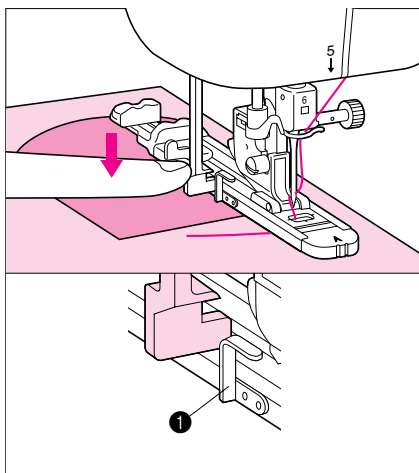

4. Lower the buttonhole lever and position it behind the metal bracket on the buttonhole foot.

- ❶ Metal bracket on buttonhole foot

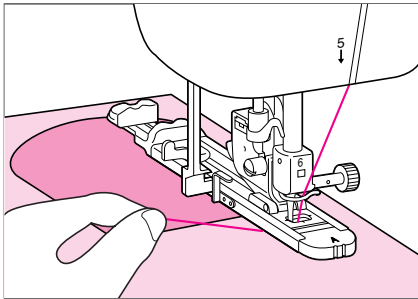

5. While lightly holding the upper thread, press the “START/STOP” button.

- * Before stopping, the machine will automatically sew a reinforcement stitch after the bar tack is sewn.
- * If the fabric does not feed (for example, because the fabric is too thick), touch the “+” stitch length key to increase the stitch length.

Thick fabrics

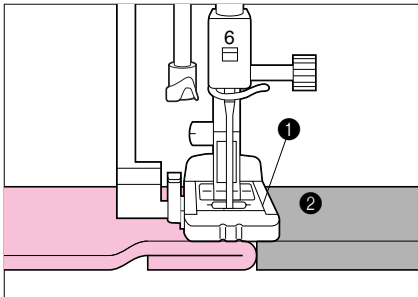

If the presser foot is not level, place a piece of cardboard or another piece of fabric with the same thickness under the open side of the presser foot.

- ① Presser foot
- ② Cardboard

Changing the bar tack stitch length

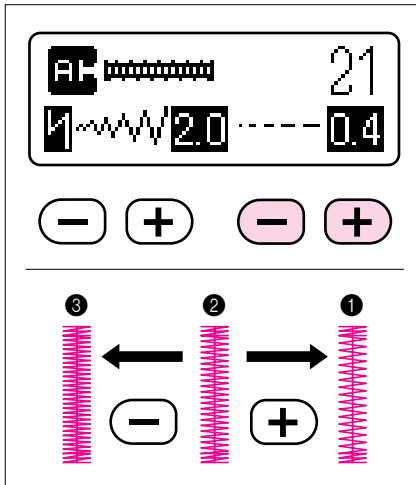

Touch the “+” or “-” stitch length key to select the desired length.

- ① (+): Longer
- ② Automatic stitch length setting: 0.4 mm (1/64")
- ③ (-): Shorter

Changing the bar tack stitch width

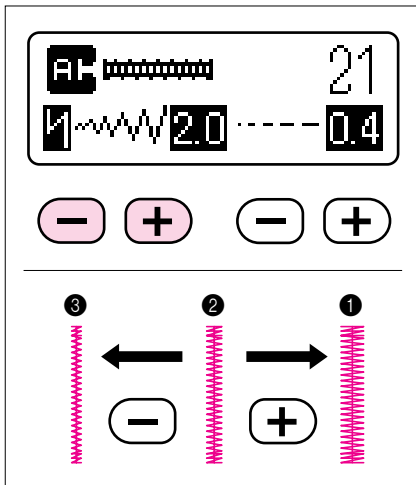

Touch the “+” or “-” stitch width key to select the desired width.

- ① (+): Wider
- ② Automatic stitch width setting: 2.0 mm (5/64")
- ③ (-): Narrower



19



20

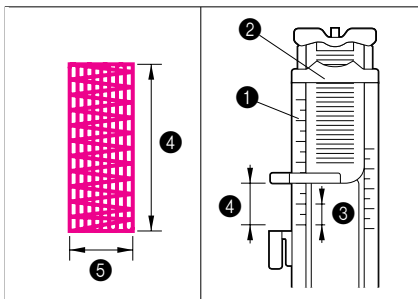

19: For medium fabric
20: For thick fabric

1. Set the stitch length using the scale on presser foot "A". Pull on the end of the button holder plate to expand it. The finished size of the bar tack will be the space shown in the illustration.

- ❶ Scale on the presser foot
- ❷ Button holder plate
- ❸ 0.5 cm (13/64")
- ❹ Length of darning
- ❺ Width [7 mm (9/32")]

* The maximum stitch length for darning is 3 cm (1-13/64").

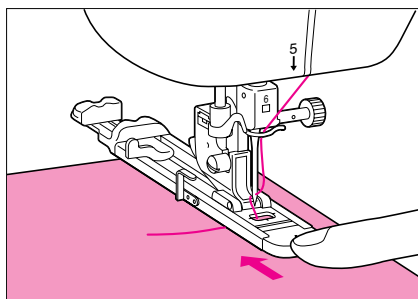

2. Check the needle drop point and then lower the presser foot.

- * After the presser foot lever has been lowered, adjust the presser foot so that there is no gap behind the section that is shaded in the illustration at the right. Otherwise, the size of the stitch will not be correct. To adjust the presser foot, push the presser foot towards the back of the machine as shown in the figure at the left.

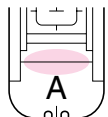

* Pass the thread underneath the presser foot.

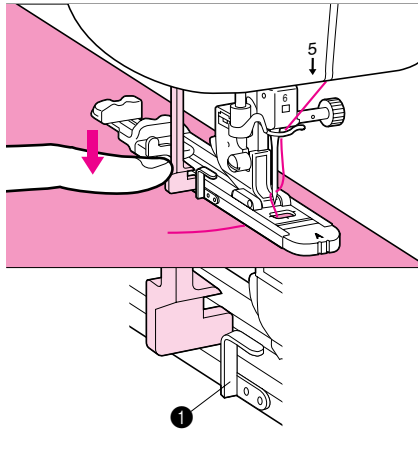

3. Lower the buttonhole lever and position it behind the metal bracket on the buttonhole foot.

❶ Metal bracket on the buttonhole foot

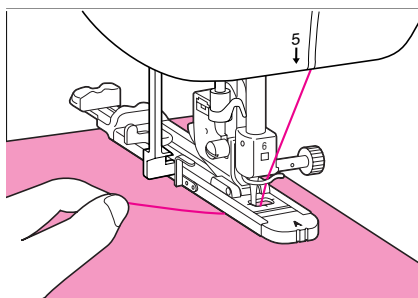

4. While lightly holding the upper thread, start sewing.

* Before stopping, the machine will automatically sew a reinforcement stitch after the darning is finished.

Changing the darning stitch length

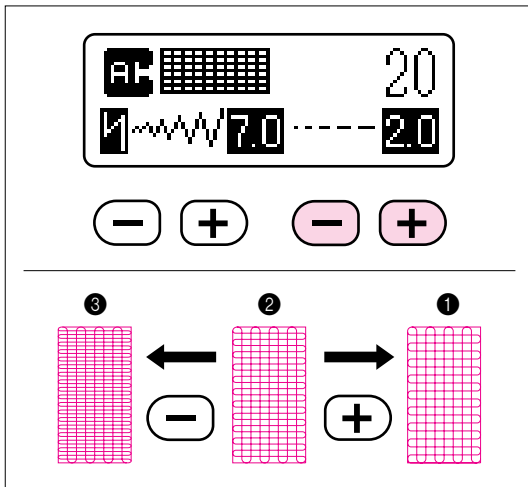

Touch the “+” or “-” stitch length key to select the desired length.

- ➊ (+): Longer (less dense)
- ➋ Automatic stitch length setting: 2.0 mm (5/64")
- ➌ (-): Shorter (more dense)

* If the fabric does not feed (for example, because the fabric is too thick), touch the “+” stitch length key to increase the stitch length.

Changing the darning stitch width

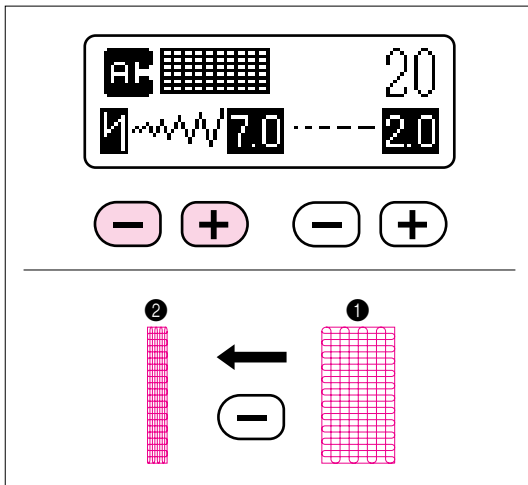

Touch the “+” or “-” stitch width key to select the desired width.

- ➊ Automatic stitch width setting: 7.0 mm (9/32")
- ➋ (-): Narrower

Darning stitch sewing order

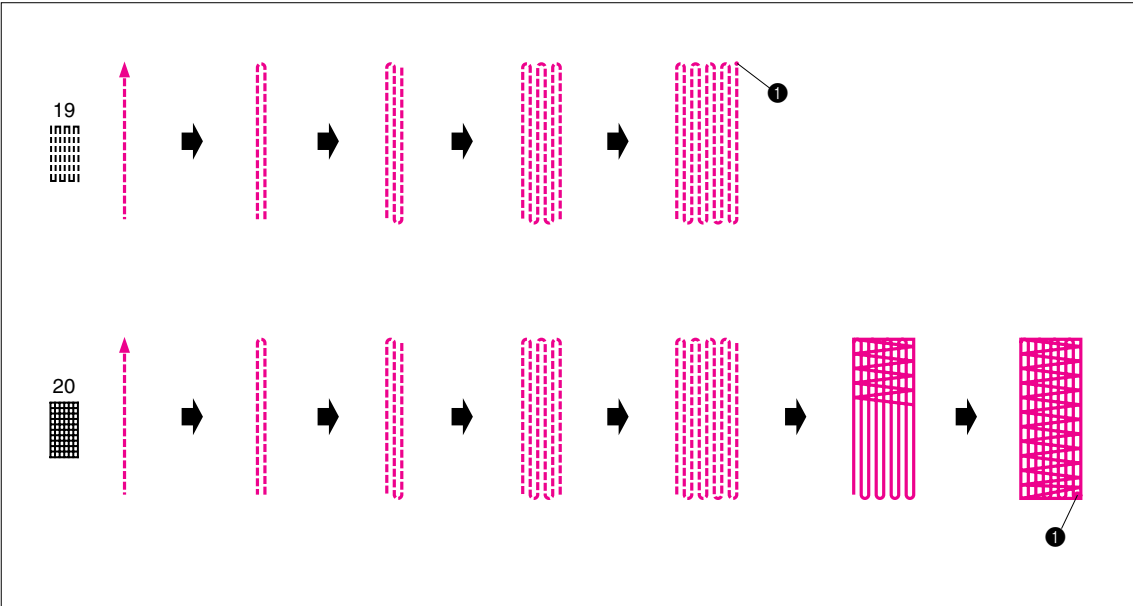

① Reinforcement stitch



22



For sewing eyelets on belts, etc.

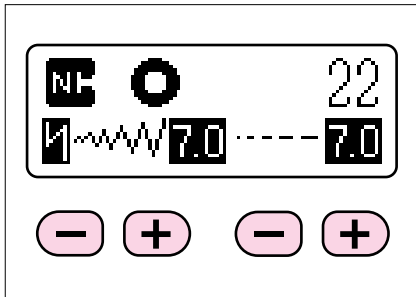

1. Touch the “+” or “-” stitch length or stitch width key to select the eyelet size.

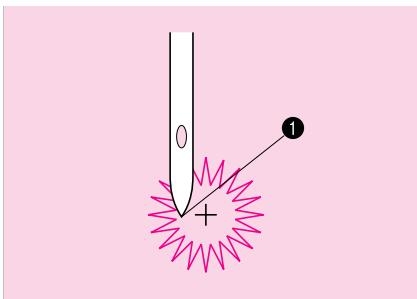

2. Attach presser foot “N”, check the needle drop point and lower the presser foot, then press the “START/STOP” button to start sewing.

* Before stopping, the machine will automatically sew a reinforcement stitch after the darning is finished.

① Needle drop point

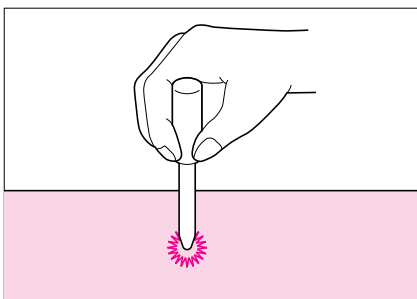

3. Make a hole at the center using the eyelet punch.

Size of eyelet (Actual size)

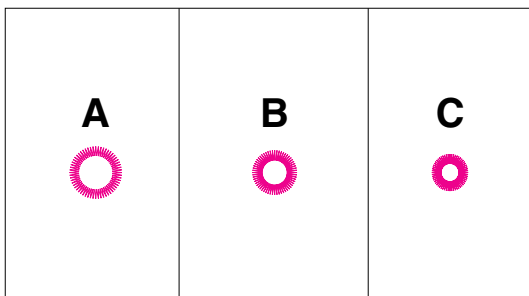

A– Large: 7.0 mm (9/32")
 B– Medium: 6.0 mm (1/4")
 C– Small: 5.0 mm (13/64")



For attaching buttons

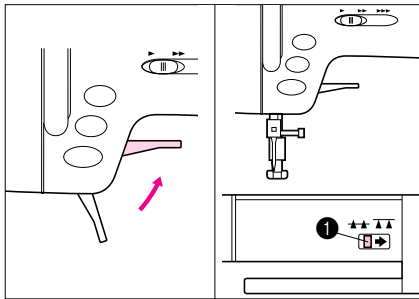

1. Raise the presser foot lever and slide the feed dog adjustment lever to the right in order to lower the feed dog.

① Feed dog adjustment lever (Slide off the accessory compartment to expose the lever.)

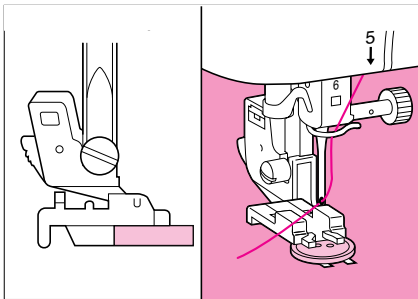

2. Attach button fitting foot "M", place the button into the presser foot, and then lower the presser foot.

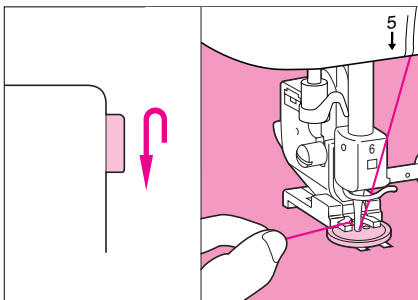

3. Turn the balance wheel to check that the needle goes into each of the holes in the button correctly, and then start sewing. To adjust the button sewing stitch width, touch the stitch width keys "+" or "-" to select the desired width. The sewing machine will stop automatically when the sewing is finished.

* If extra attachment strength is needed, carry out the button sewing operation twice.

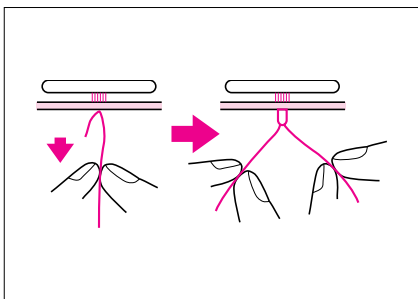

4. Once sewing is completed, return the feed dogs to their original position, pull on the bobbin thread at the end of the stitches to pull the upper thread through to the reverse side of the fabric, then tie the thread ends together.

Attaching buttons with four holes

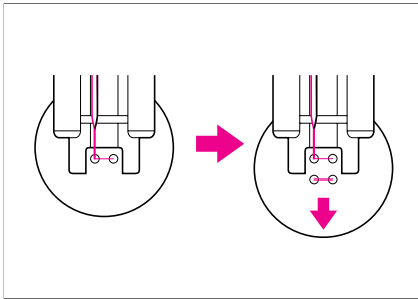

First, sew the two holes which are closest to you. Once they have been sewn, raise the presser foot, move the needle to the other two holes, and then sew them in the same way.

Attaching a shank to the button

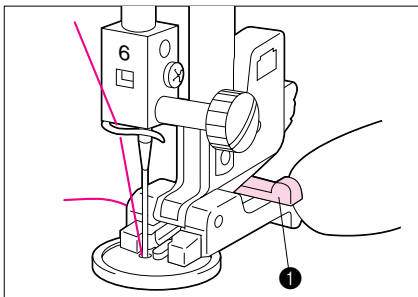

1. Pull the shank lever toward you, then start sewing.

① Shank lever

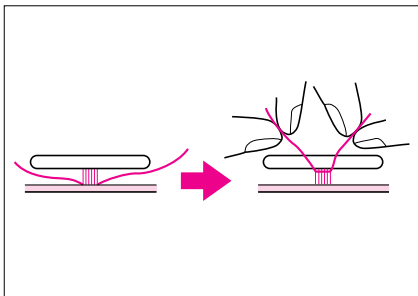

2. Hold the two ends of the upper thread, which are between the button and the fabric, wind them around the shank, and then securely tie them together.

3. Tie the ends of the bobbin thread together at the reverse side of the fabric.



For attaching zippers

Centered application

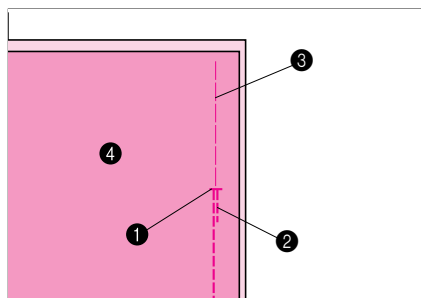

1. Attach presser foot “J”, then place the right sides of the fabric together and sew straight stitches up to the area where the zipper will be attached. Then, baste at opening (the zipper area).

- ① End of opening
- ② Reverse stitch
- ③ Basting
- ④ Reverse side

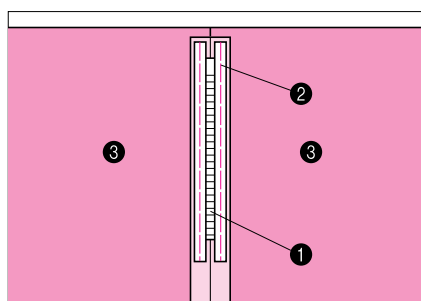

2. Press open the seam allowance, then attach the zipper with basting up the middle of the zipper tape.

- ① Zipper
- ② Basting
- ③ Reverse side

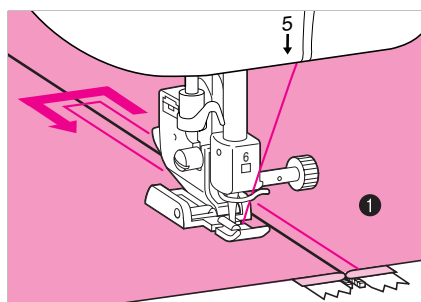

3. Attach the right pin of presser foot “I” to the presser foot holder and sew on the zipper with the right side of the fabric facing upward, then remove the basting stitches.

* When using presser foot “I”, adjust the thread tension to the thickness of the zipper.

- ① Right side of fabric

Side application

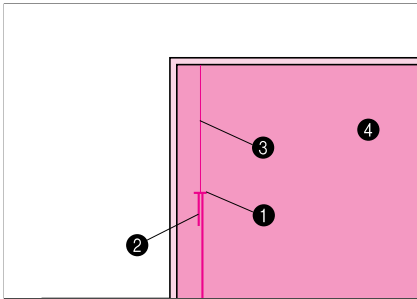

1. Attach presser foot "J", then place the right sides of the fabric together and sew straight stitches up to the area where the zipper will be attached. Then, baste at opening (the zipper area).

- ① End of opening
- ② Reverse stitch
- ③ Basting
- ④ Reverse side

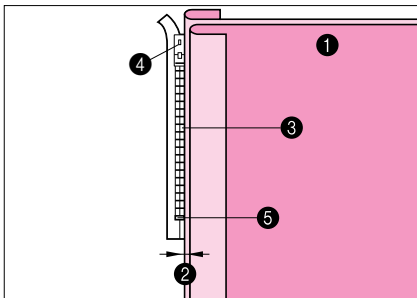

2. Press the seam allowance open and align the folded hem along the teeth of the zipper while allowing 3 mm (1/8") for the sewing space.

- ① Reverse side
- ② Allow 3 mm (1/8") for sewing
- ③ Teeth of zipper
- ④ Slider on head of zipper
- ⑤ Crotch end (base of zipper)

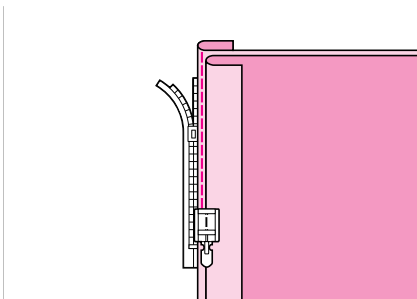

3. Attach the left pin of presser foot "I" to the presser foot holder, then sew the lower piece of fabric from the top to the bottom of the zipper.

* Before sewing, touch the automatic reinforcement stitching key to sew reinforcement stitches automatically at the beginning and at the end of the stitch.

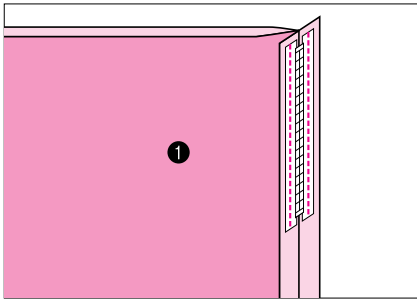

4. Close the zipper and turn over the fabric. Then sew the other side of the zipper onto the fabric.

1 Reverse side

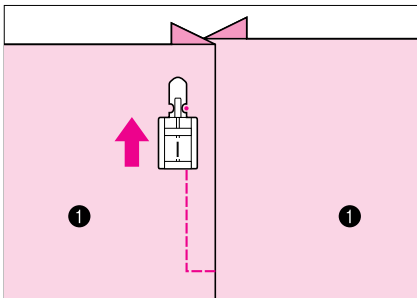

5. Turn over the fabric so that the right side faces up, sew straight stitches from the bottom to 5 cm (1-15/16) from the top, and then stop the machine.

1 Right side of fabric

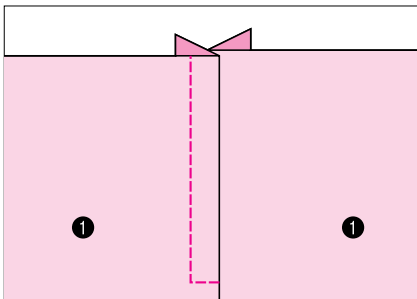

6. Lower the needle, raise the presser foot, and then remove the basting stitches.

7. Move the zipper pull tab out of the way and sew the remainder of the stitches.

1 Right side of fabric



01
- - - 0

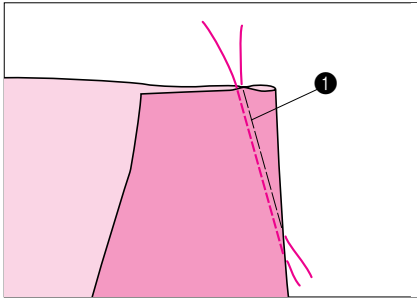

1. Attach presser foot "J", then sew a reverse stitch at the beginning of the dart and sew from the wide end to the narrow end without stretching the fabric.

❶ Basting

- * Before sewing, touch the automatic reinforcement stitching key to sew reinforcement stitches automatically at the beginning of the stitch.

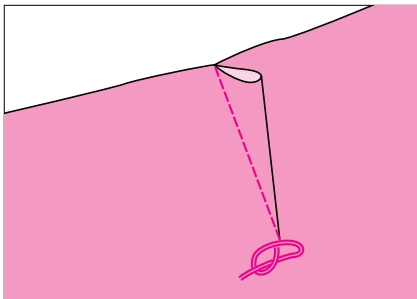

2. Do not sew a reinforcement stitch at the end. Cut the thread at the end leaving an excess 5 cm (2"), and then tie both ends together.

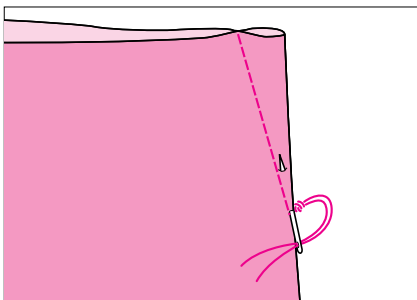

3. Insert the ends of the thread into the dart using a needle.

- * Alternate method: When you reach the narrow end of the dart; stop, lift the presser foot, slide your fabric towards you (19 mm). Touch the stitch length keys, reduce to 0.4 mm. Sew 3 stitches on the seam line. This will secure the thread ends, cut the thread.

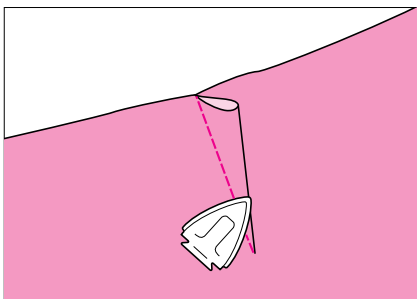

4. Iron the dart to one side so that it is flat.



01
—
—

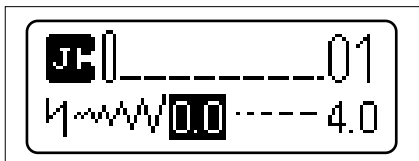

For the waists of skirts, the sleeve openings of shirts, etc.

1. Select a stitch length of 4.0 mm (5/32") and a weak thread tension.

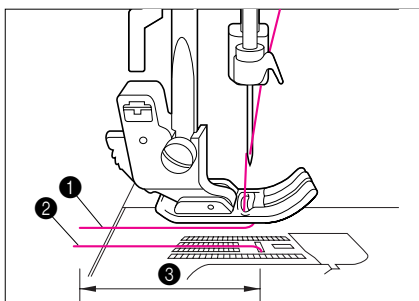

2. Attach presser foot "J", then pull out about 5 cm (2") of both the bobbin and upper threads.

- ① Upper thread
- ② Bobbin thread
- ③ About 5 cm (2")

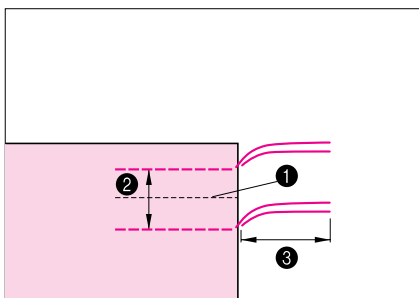

3. Sew two rows of straight stitches parallel to the seam line, then trim off the excess thread leaving 5 cm (2") .

- ① Seam line
- ② 1.0 to 1.5 cm (25/64" to 19/32")
- ③ About 5 cm (2")

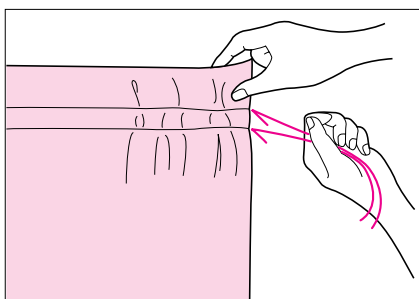

4. Pull the bobbin threads to obtain the desired amount of gather, then tie the threads to secure them.

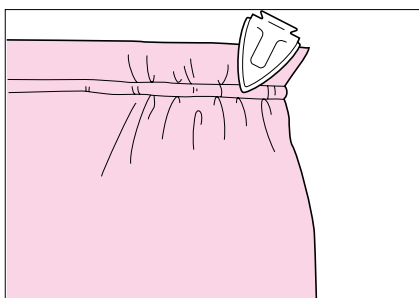

5. Smooth the gathers by ironing them.

Pulling out the bobbin thread

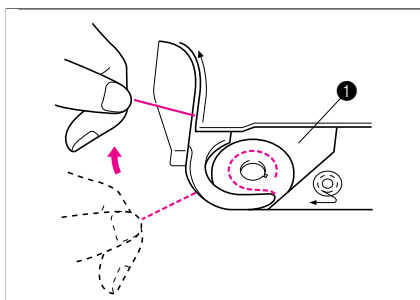

1. Pass the thread along the groove in the direction of the arrow, and leave it there without cutting it.

① Shuttle

* The bobbin cover should still be removed.

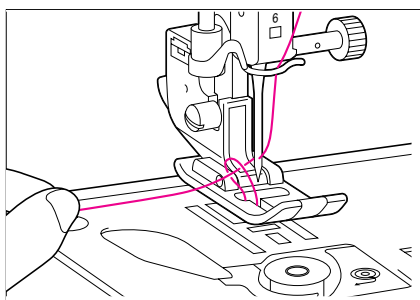

2. While holding the upper thread, press the "NEEDLE POSITION" button twice, and then pull out the bobbin thread.
3. Replace the bobbin cover.

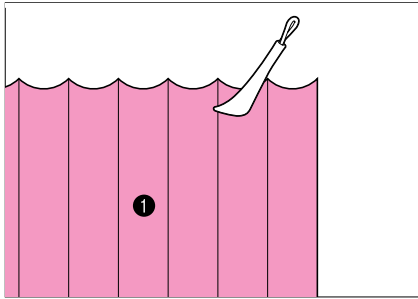

For decorating blouses, etc.

1. Mark along the folds on the reverse side of the fabric with a spatula.

① Reverse side

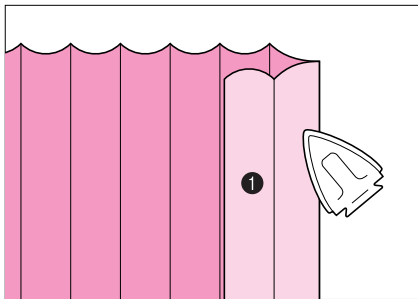

2. Fold the fabric so that the surface faces upward and iron only the folded parts.

① Right side of fabric

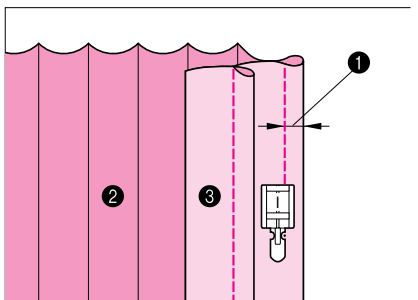

3. Attach the right pin of presser foot "I" to the holder, and sew a straight stitch along each fold.

① Width for pintuck

② Reverse side

③ Right side of fabric

* Before sewing, touch the automatic reinforcement stitching key to sew reinforcement stitches automatically at the beginning and at the end of the stitch.

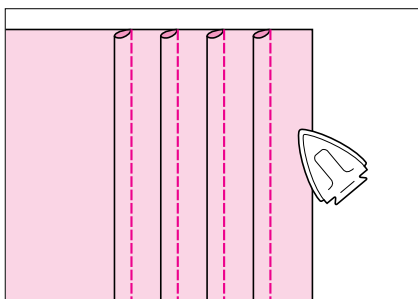

4. Iron all folds in the same direction.



For reinforcing seams and neatly finishing edges

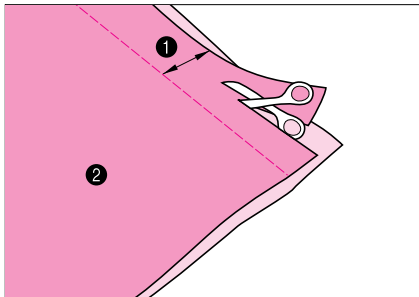

1. Attach presser foot "J". Sew the seam line, then cut half of the seam allowance from the side that the flat fell seam will lie against.

- ① About 1.2 cm (1/2")
- ② Reverse side

* Before sewing, touch the automatic reinforcement stitching key to sew reinforcement stitches automatically at the beginning and at the end of the stitch.

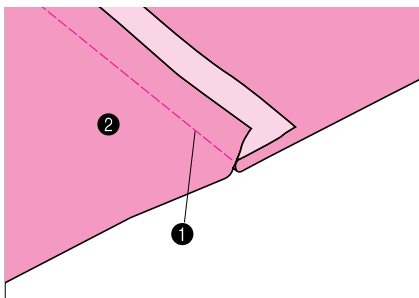

2. Spread out the fabric along the finish line.

- ① Finish line
- ② Reverse side

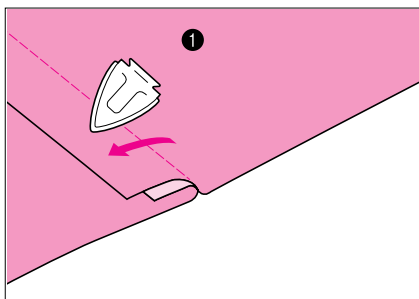

3. Lay both seam allowances to the shorter one's (cut one) side and iron them.

- ① Reverse side

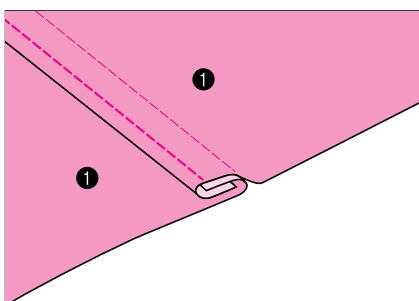

4. Fold the longer seam allowance around the shorter one, and sew the edge of the fold.

- ① Reverse side

Finished flat fell seam

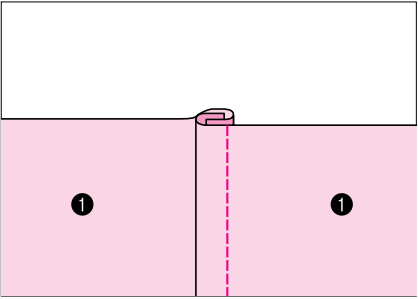

① Right side of fabric



04



24

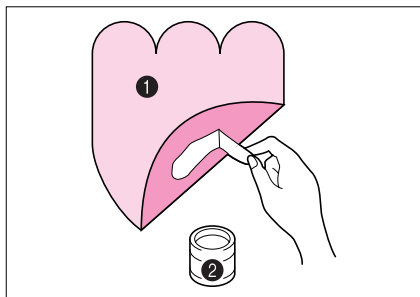

1. Attach the applique to the fabric with fabric glue or basting so that it will not move during sewing.

- ❶ Applique
- ❷ Fabric glue

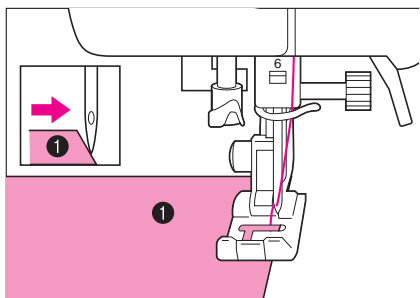

2. Attach presser foot "J". Make sure that the needle drops just outside the applique, then start sewing.

- ❶ Applique

- * Before sewing, touch the automatic reinforcement stitching key to sew reinforcement stitches automatically at the beginning and at the end of the stitch.

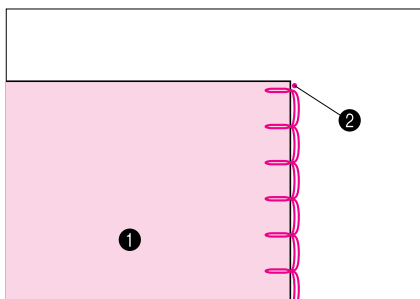

- ❶ Applique
- ❷ Needle drop point

Sewing the applique around corners or curves

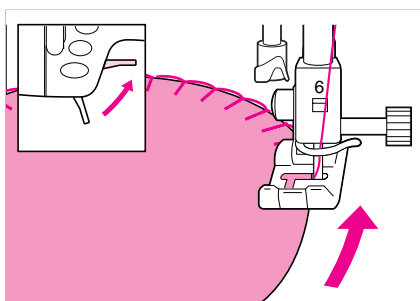

1. Stop the machine and position the needle just outside the applique.
2. Raise the presser foot and turn the fabric as needed to keep the correct needle position.

25

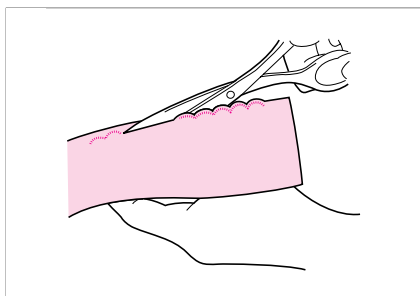
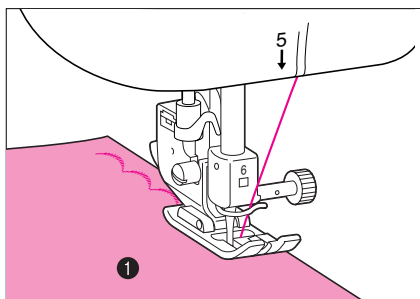

For decorating the collars of blouses, the edges of tablecloths, etc.

1. Attach presser foot "N", then sew the edge of the fabric so that the stitches are not right on the edge of the fabric.

1 Right side of fabric

- * Before sewing, touch the automatic reinforcement stitching key to sew reinforcement stitches automatically at the beginning and at the end of the stitch.

2. Trim along the stitches carefully so as not to cut the stitches.

- * There are products in the marketplace that will "seal" the trimmed areas. This will give a more finished appearance.



27
 >>>
 >>>

For making decorative smocking

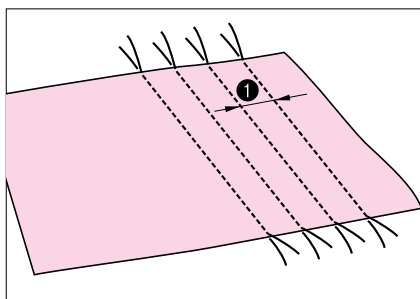

1. Select “ $\frac{00}{1}$ ”, set the stitch length to 4.0 mm (5/32”) and select a weak thread tension. Then, sew columns of straight stitches at intervals of 1 cm (25/64”).

1 About 1 cm (25/64”)

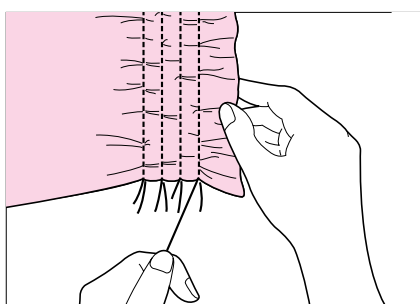

2. Pull the bobbin threads to obtain the desired amount of gather, and then smooth the gathers by ironing them.

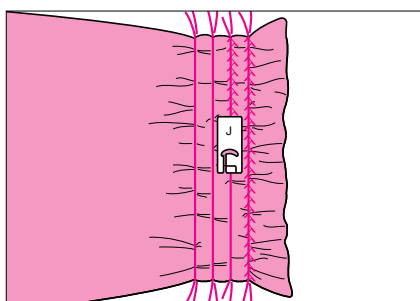

3. Attach presser foot “J” and select the decorative smocking stitch to sew over the top of the straight stitches.

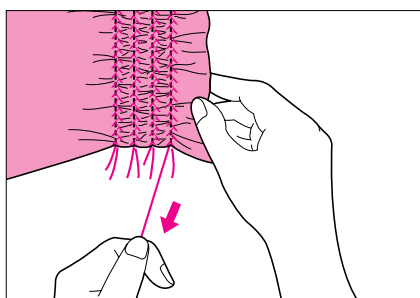

4. Pull out the straight stitch threads.



26

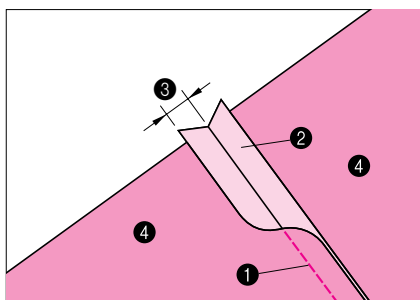

1. Match the fabric pieces with their surface sides facing each other and sew the pieces together with a straight stitch. Open the seam allowance [about 1 cm (25/64")] and press it flat.

- ① Straight stitch
- ② Seam allowance
- ③ 1 cm (25/64")
- ④ Reverse side

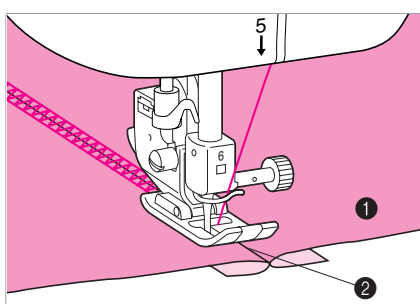

2. Attach presser foot "J". Set the center of the presser foot on the seam line of the joined fabrics and sew over the seam.

- ① Surface
- ② Seam



27



28



For fagoting, decorating, etc.

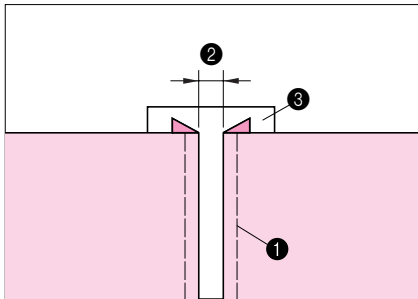

1. Separate the folded edges of the fabric pieces with a gap of 0.4 cm (5/32") and baste them onto a piece of thin paper or water-soluble stabilizer sheet.

- ❶ Basting
- ❷ 0.4 cm (5/32")
- ❸ Thin paper or stabilizer sheet

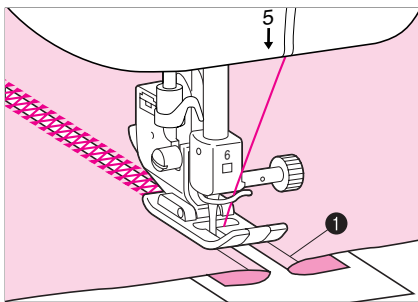

2. Attach presser foot "J". Align the center of the presser foot with the center of the two pieces of fabric and begin sewing.

- ❶ Basting
- * Use a heavier weight thread (for example, #30 topstitching or cotton thread for machine quilting).
- * After sewing, remove the paper.

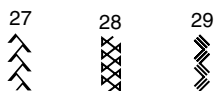

Other decorative stitches: 56 – 63

Decorative stitching

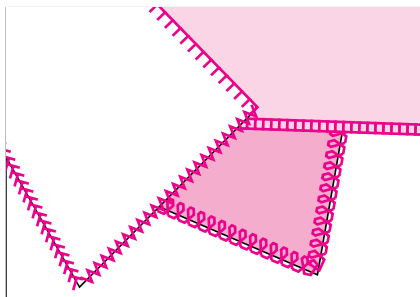

These stitches are used as decorative hem stitches or to decorate the seams of crazy quilts. Use a contrasting thread color or decorative embroidery thread.

Shell tacking

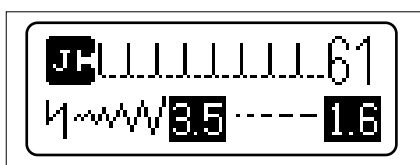

1. In decorative stitch mode, enter “61” to select the stitch for shell tacking.

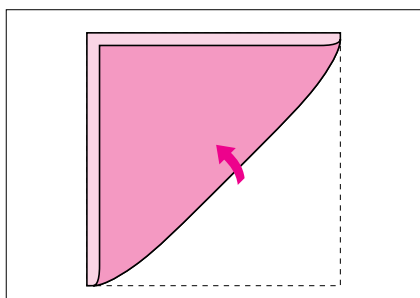

2. Fold the fabric diagonally in half.

* Use a thin fabric.

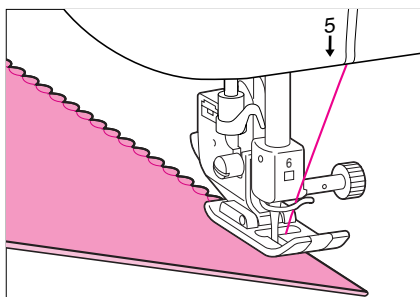

3. Drop the needle slightly outside the edge of the fabric and start tacking.

4. Unfold the fabric and iron the fold down to one side.

HEM-STITCH (HEIRLOOM STITCH)

Decorative stitches: 46 – 50

For sewing tablecloths, decorative hems on clothes and decorative stitching on shirtfronts.

A more attractive finish can be obtained if you use the “130/705H Wing” needle when sewing these patterns.

If using a wing needle and the stitch width has been set to manual, check that the needle will not touch the presser foot before starting sewing.

Hem-stitching 1

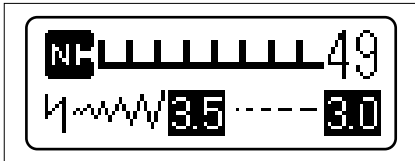

1. In decorative stitch mode, enter “49” to select the stitch for hem-stitching.

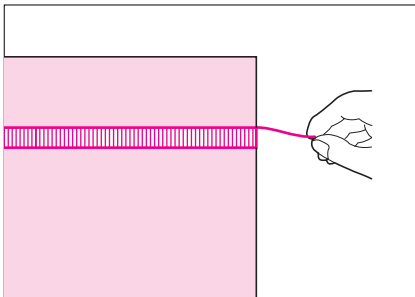

2. Pull out several threads from one area on a piece of fabric. This will leave the fabric frayed in this one area. About 5 or 6 threads will leave a 3 mm (1/8" area).

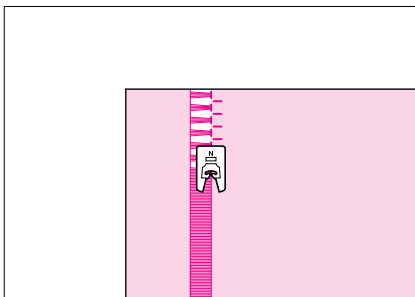

3. Attach presser foot “N”. With the reverse side of the fabric facing up, sew one edge of the frayed part.

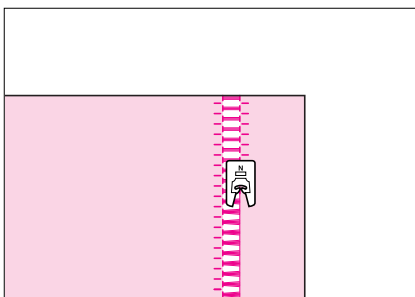

4. With the back side of the fabric continuing to face you, turn the fabric and sew the other edge of the frayed part, aligning the stitches so they are parallel.

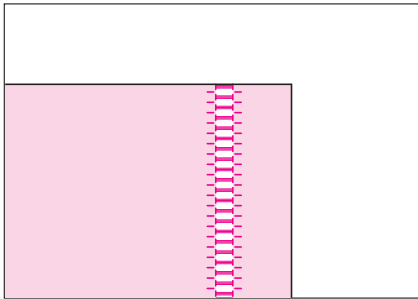

5. Illustration of finished product.

Hem-stitching 2

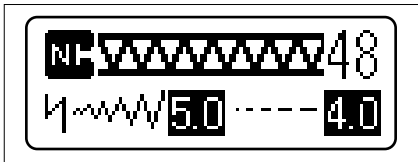

1. In decorative stitch mode, enter "48" to select the stitch for hem-stitching.

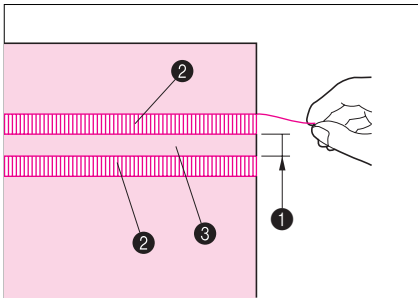

2. Pull out several threads from both sides of the 4 mm (5/32") part which is not yet frayed.
 [Pull out four threads, leave five threads and then pull out four threads, the width of five threads is approximately 4mm (5/32") or less.]

- ① Approx. 4.0 mm (5/32") or less.
- ② Four threads (Pull out)
- ③ Five threads (Leave)

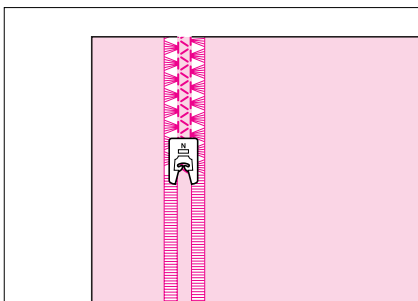

3. Sew the decorative stitch on the center of the five threads created above.

* Wing needle is an option.

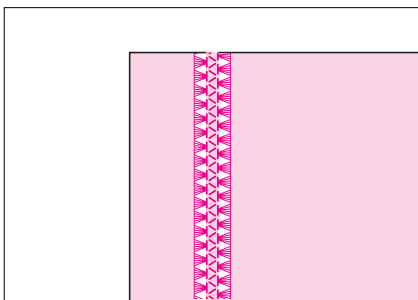

4. Illustration of finished product.



00
- - -

Decorative stitches where the zigzag width can be changed manually.

* When using twin needles, use the “J” presser foot regardless of what kind of sewing will be carried out.

1. Insert twin-needle.

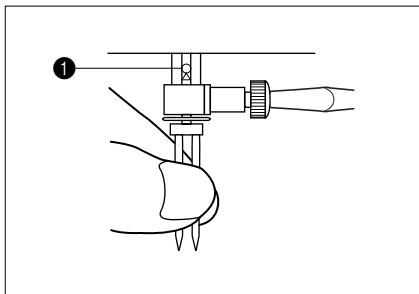

① Stopper

2. Follow the instructions for single-needle threading using the horizontal spool pin.

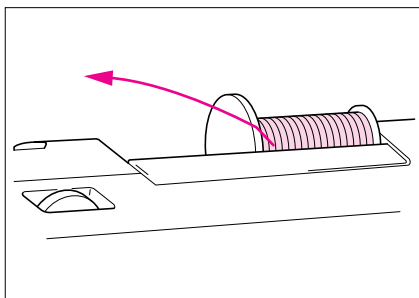

3. Thread through left eye of needle.

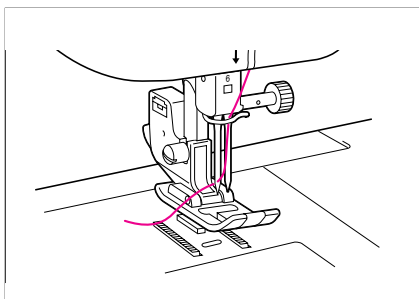

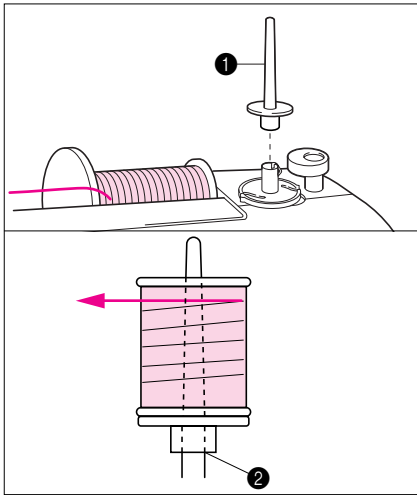

4. Set the extra spool pin into the hole on the end of the bobbin winder shaft on the top of the machine. Follow the instructions for single-needle threading.

- ① Extra spool pin for right needle threading.
- ② Push the spool pin securely into place.

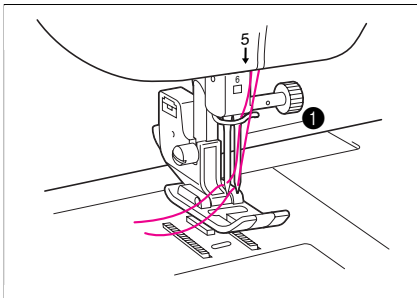

5. Thread through remaining points, making certain to omit the thread guide above the needle and pass thread through right eye of needle.

- ① The thread for the right needle should pass in front of thread guide.

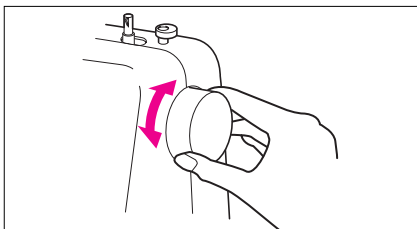

CAUTION

Stitch width

Adjust the stitch width. Turn the balance wheel to check the needle clearance, so that the needle does not hit the needle plate.

Stitch length

- Straight 2 mm min.
- Others 0.5 mm min.

Types of thread

Cotton thread or span thread are recommended because synthetic threads may break.

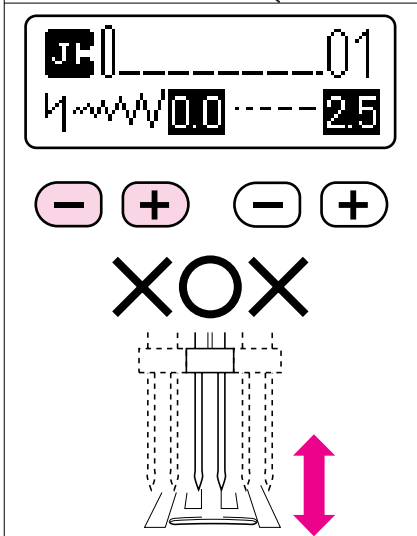

3. FONTS AND DECORATIVE STITCHES

FONT STITCHES

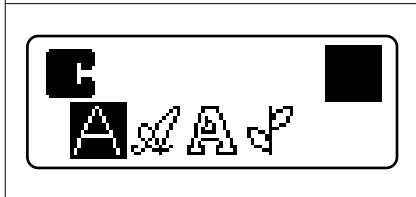
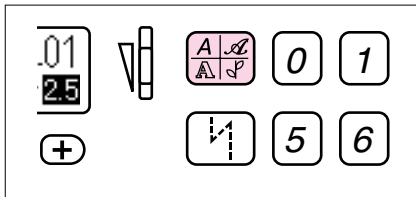

1. Touch “” until the cursor (“”) moves over the type of font that you want to sew.



Block font



Italic font



Outline font

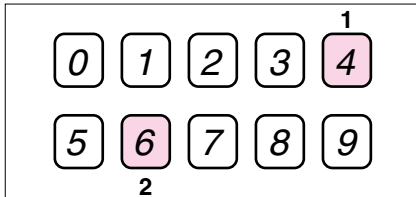

2. Use the stitch selection keys to enter the number of the desired character. The selected character appears on the screen.

* A two-digit number must be entered when selecting the stitch.

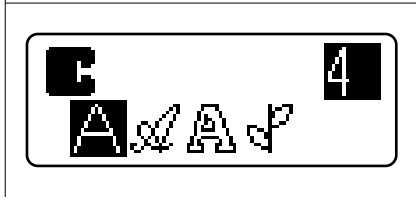

▼ 0.4 seconds later

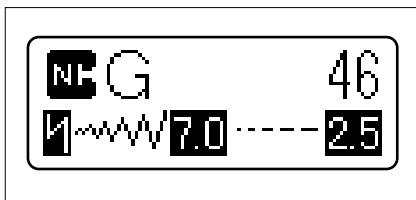

3. When combining characters, touch the enter key, then use the stitch selection keys to enter the number of the next character.

* Up to 70 characters can be combined into a single pattern.

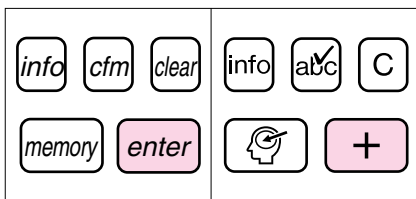

Combining characters

Example: To combine outline letters to create “BUS”

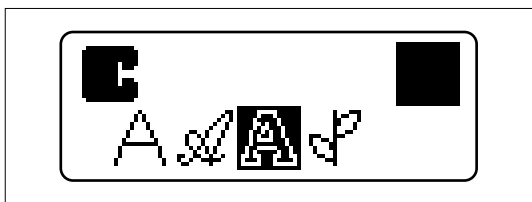

1. Touch “” until “” moves over “”.

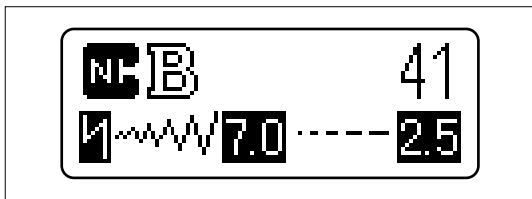

2. Touch “”, then “”, the stitch number for the letter “”.



3. Touch “”.

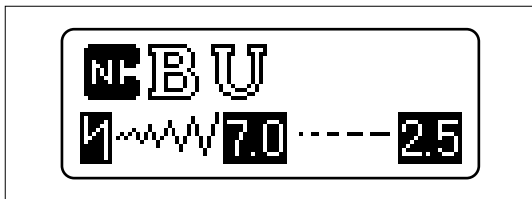

4. Touch “”, then “”, the stitch number for the letter “”.

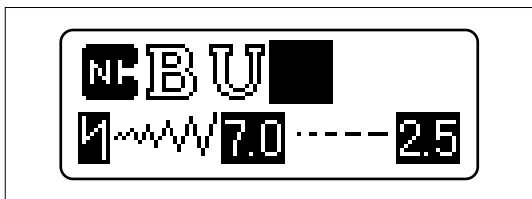

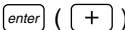

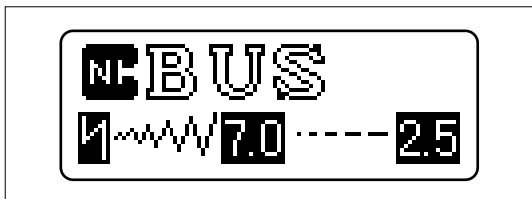
5. Touch “”.

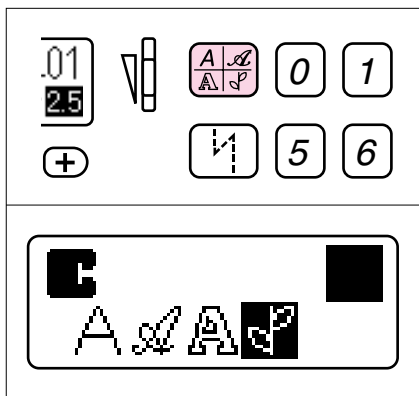

6. Touch “”, then “”, the stitch number for the letter “”.

DECORATIVE STITCHES



1. Touch “” until the cursor (“”) moves over “”.

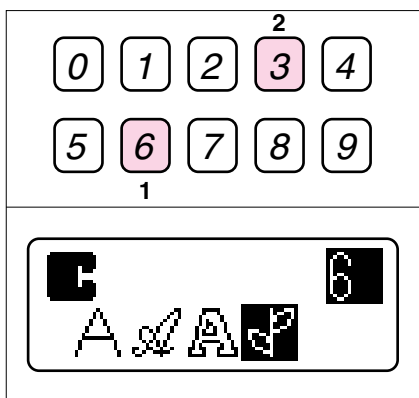

2. Use the stitch selection keys to enter the number of the desired decorative stitch. The selected decorative stitch appears on the screen.

* A two-digit number must be entered when selecting the decorative stitch.

▼ 0.4 seconds later

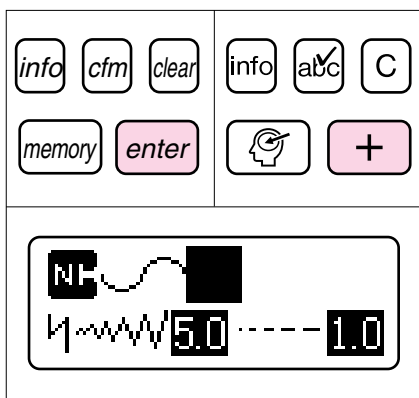
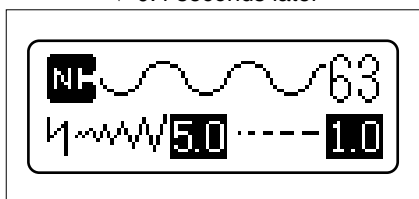

3. When combining decorative stitches, touch the enter key, then use the stitch selection keys to enter the number of the next decorative stitch.

* Up to 70 decorative stitches can be combined into a single pattern.

Selecting a decorative stitch

Example: To select the decorative stitch “ *rrr* ”

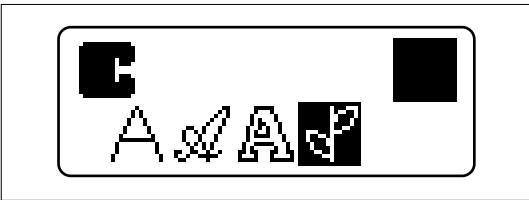

1. Touch “  ” until “  ” moves over “ *rrr* ”.

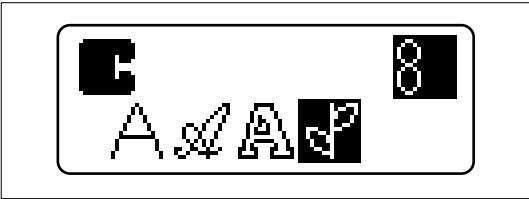

2. Touch “  ”, then “  ”, the stitch number for the stitch “ *rrr* ”.

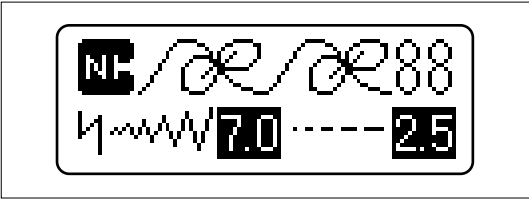

Combining decorative stitches

Example: To combine decorative stitches to create “ *rrr* & *rrr* ”

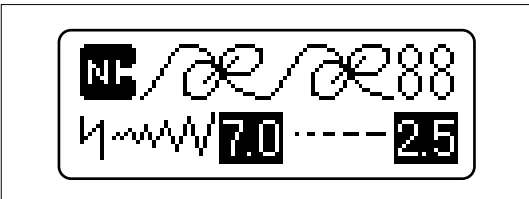

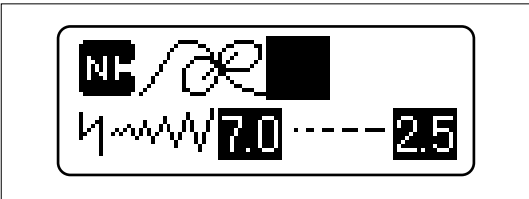

1. Select “ *rrr* ”.

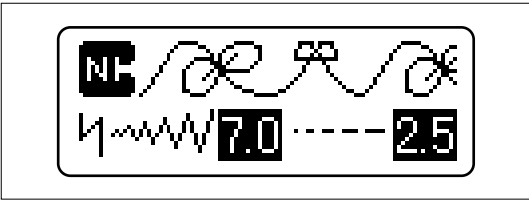

2. Touch “  () ”.





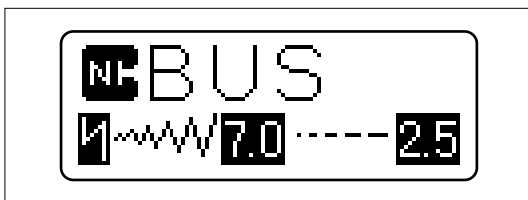
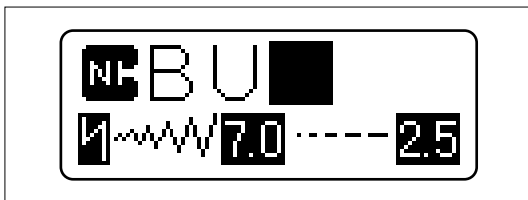
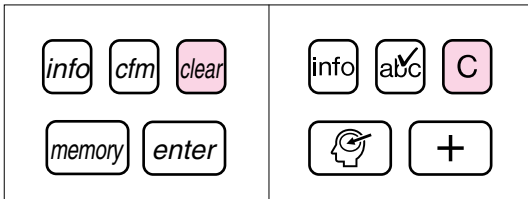
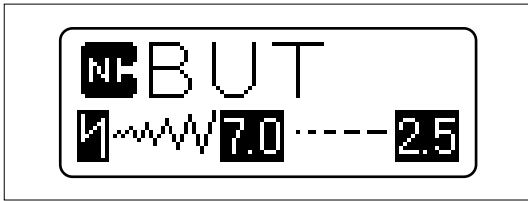

3. Touch “  ”, then “  ”, the stitch number for the stitch “ *rrr* ”.

CORRECTING A PATTERN COMBINATION

Example: To change “BUT” to “BUS”



1. Touch “ ()”.
(Touch “ ()” the same number of times as the number of characters that you wish to change.)

2. Touch “ ()”.

3. Use the stitch selection keys to enter the number of the desired characters.

CHANGING THE SIZE

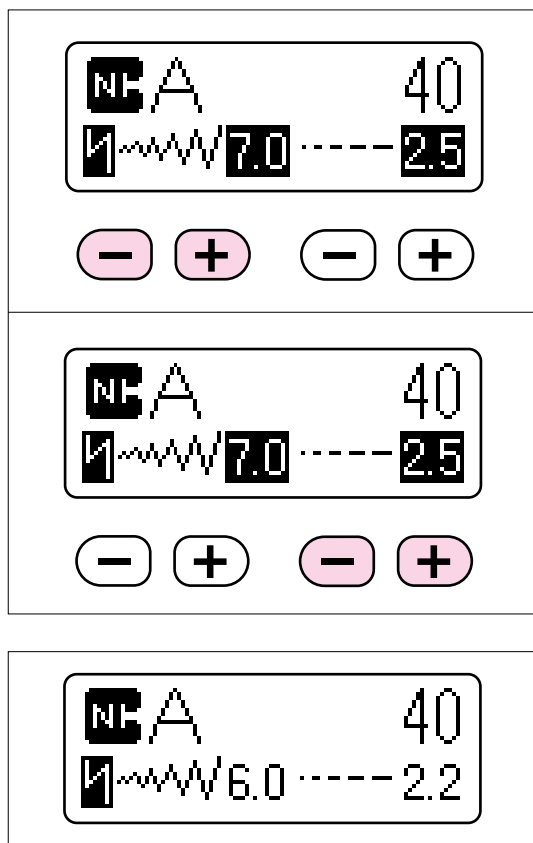

Touch the “+” or “-” stitch width key to adjust the zigzag stitch width or the “+” or “-” stitch length key to adjust the stitch length. However, when italic font is set, the size cannot be changed.

Two sizes are available:

A

7.0 mm

A

6.0 mm

* Depending on the types of fabric and thread used, the thread may become tangled if the smaller size is selected.

Changing the size of a decorative stitch

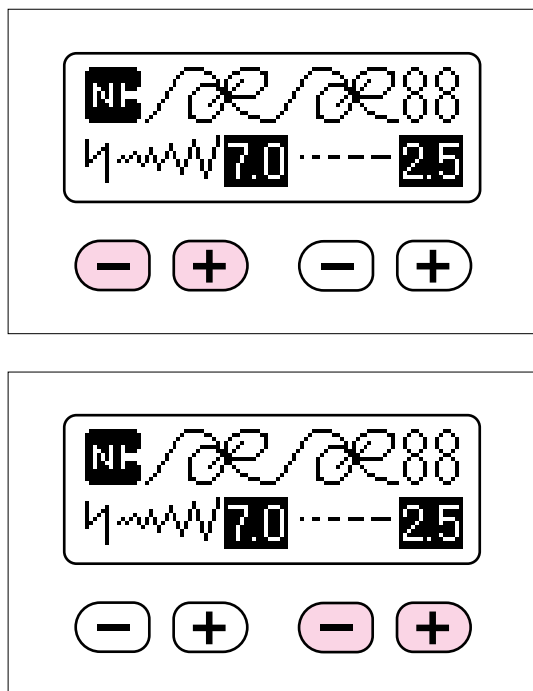

Use the stitch width or stitch length keys to adjust the zigzag stitch width and the stitch length.

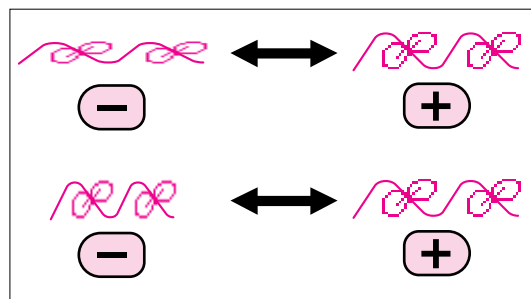



* Depending on the types of fabric and pattern used, the thread may become tangled if the pattern is very detailed.

CHECKING A PATTERN COMBINATION

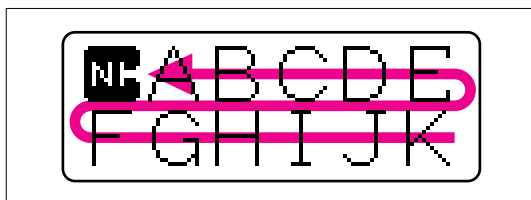
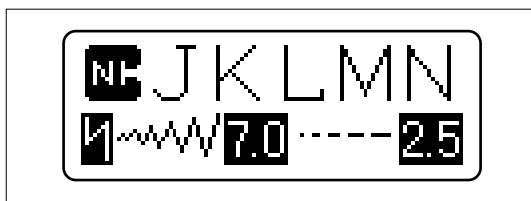
Example: To check the pattern combination “ ABCDEFGHIJKLMN ”



Touch the “  () ” key to scroll the pattern combination across the display from the beginning. “ABCDEFGHIJKLMN” is displayed.

MEMORY

Up to 70 pattern combinations can be stored in the memory under the five stitch numbers 95, 96, 97, 98 and 99.

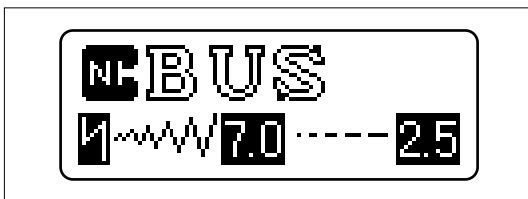
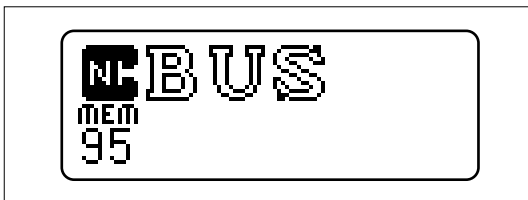
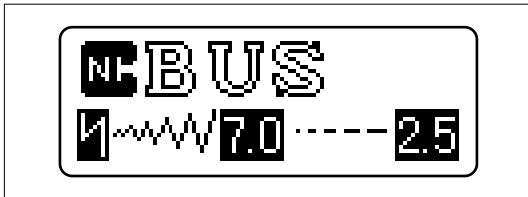

Saving a pattern combination

Example: To select the decorative stitch “BUS”



1. Combine characters to create the word “BUS”. (Refer to page 77 for more details.)

2. Touch “memory” ()”.

* Each touch of “memory” ()” changes the stitch number. For example, to store the pattern under stitch number 97, touch “memory” ()” three times.

If a pattern has already been stored under the selected stitch number, its contents are displayed in the bottom row.

3. Touch “enter” ()”.

CAUTION

- If a pattern is stored under a stitch number which already contains a pattern, the previous pattern will be deleted and the new pattern will be stored under the selected stitch number.
- Do not turn off the power while a pattern is being stored.

4. The pattern is stored.

Checking a stored pattern combination

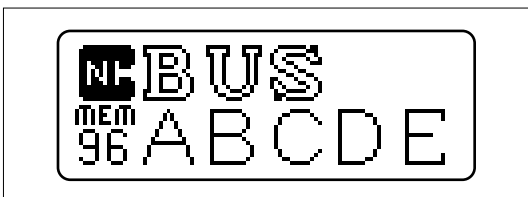

To see other parts of the pattern combination stored under the selected stitch number, touch “ctrl” ()” to scroll the pattern combination from the beginning.

The contents of the stored pattern can be seen in the bottom row.

Recalling a stored pattern combination

Example: To recall the pattern combination “  ”, stored under stitch number 96

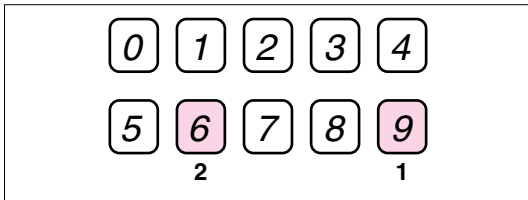

1. Use the stitch selection keys to enter the number of the desired pattern combination.

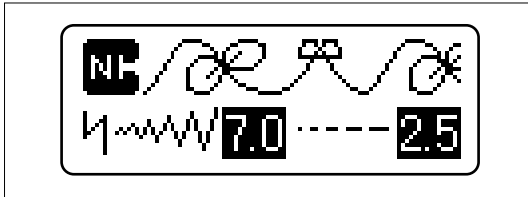

2. Press the “START/STOP” button.

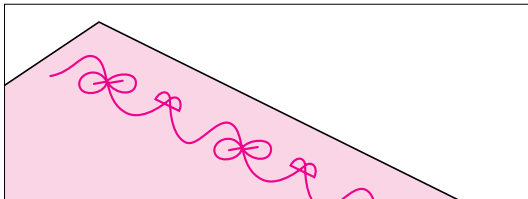

SEWING

Sewing attractive finishes

Refer to the table below and the “FABRIC/THREAD/NEEDLE COMBINATION CHART” for recommended fabrics, threads and needles to use in order to obtain attractive sewing finishes. Furthermore, pattern slippages may occur when using different fabric thicknesses or types of stabilizers. Be sure to carry out a test sewing beforehand to check.

FABRIC	When sewing thin or stretch fabrics, fabrics with coarse weaves, or characters/ decorative stitches stored in the machine; attach interfacing to the reverse side. If you do not wish to attach interfacing, place the fabric onto some thin paper such as tracing paper before starting to sew. This acts as a stabilizer.
THREAD	#50 – #60
NEEDLE	Thin and medium fabrics 75/11 Thick fabrics 90/14 Stretch fabrics #14 golden needle

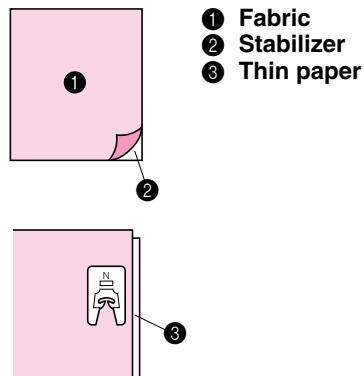

Sewing

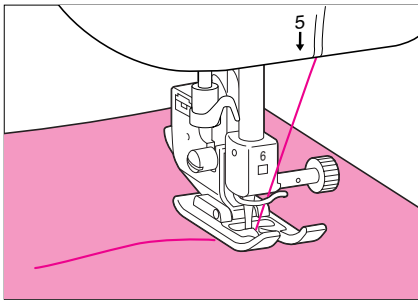

1. Attach presser foot "N".
2. Place the fabric under the presser foot, pull the upper thread out to the side and then lower the presser foot.

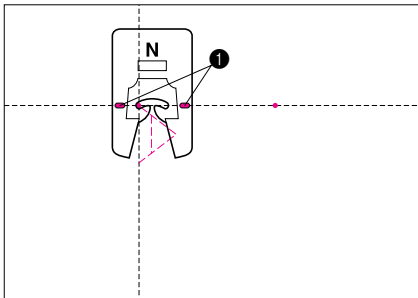

* Be sure that the material is positioned so that pattern will be sewn facing the correct direction.

① Needle hole reference line

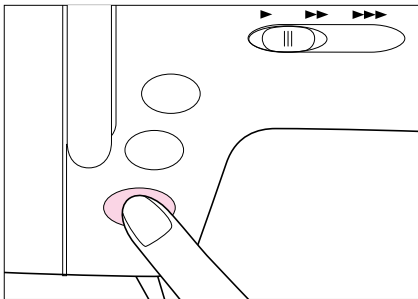

3. Push the "START/STOP" button to start sewing.

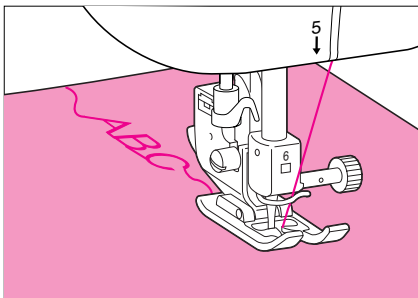

4. Once sewing of the font has been completed, the sewing machine will automatically sew reinforcement stitches, and then stop.

When sewing continuous patterns, push the "START/STOP" button to stop the sewing machine, then push the "REVERSE STITCH" button to sew reinforcement stitches.

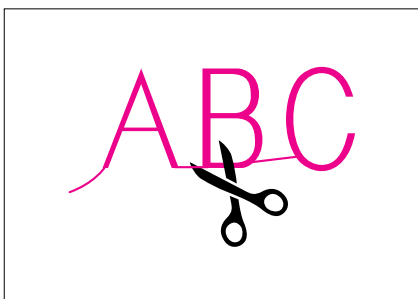

5. When sewing is completed, trim any excess thread.

ADJUSTING STITCH PATTERNS



A stitch pattern may get deformed due to the thread or cloth. It is a good idea to first make a trial stitching, and then make adjustments for each stitch pattern if necessary.

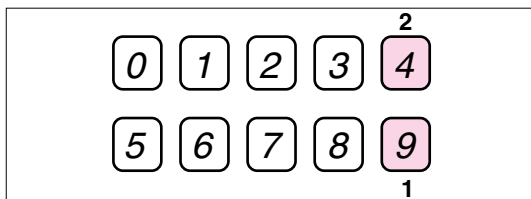

1. In decorative stitch mode, use the stitch selection keys to enter the number 94.

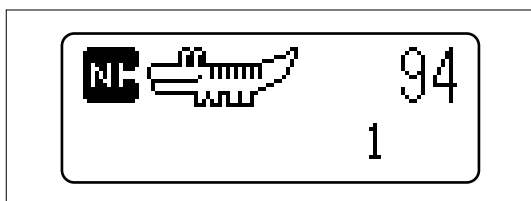

2. Attach presser foot "N" and then start embroidering. A trial pattern for adjustment purposes can then be embroidered. Adjust shape of stitch using the "+" and "-" stitch length keys.

* From -9 to +9

Stitch pattern	Remedy
	Correct shape

MAINTENANCE

CLEANING

Cleaning the screen

CAUTION

Disconnect the power cord from the wall socket before cleaning the screen, otherwise injury or electrical shock may result.

If the front panel is dirty, wipe it gently with a soft, dry cloth. Do not use any organic solvents or detergents.

Cleaning the sewing machine surface

CAUTION

Disconnect the power cord from the wall socket before cleaning the sewing machine surface, otherwise injury or electrical shock may result.

If the surface of the sewing machine is dirty, lightly soak a cloth in neutral detergent, squeeze it out firmly and then wipe the surface. After cleaning it once in this way, wipe the surface again with a dry cloth.

Cleaning the shuttle

CAUTION

Disconnect the power cord from the wall socket before cleaning the shuttle, otherwise injury or electrical shock may result.

Sewing performance will suffer and bobbin thread detection will become unreliable if dust collects in the shuttle. It should be kept clean at all times.

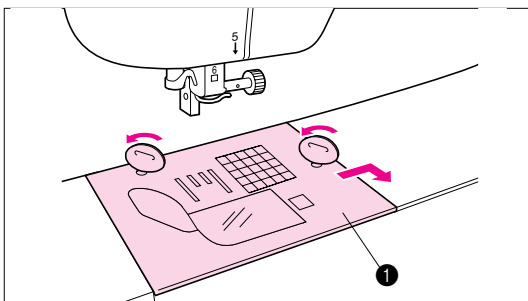
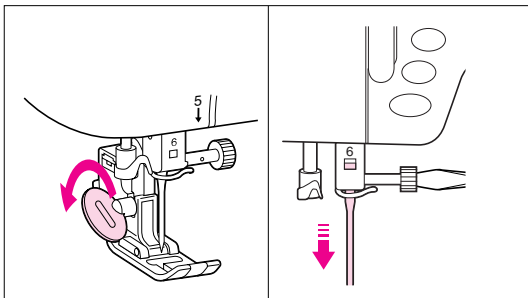

Always keep the machine clean.

1. Turn off the power and remove the presser foot holder and the needle.
2. Loosen the screws.
3. Remove the needle plate.

1 Needle plate

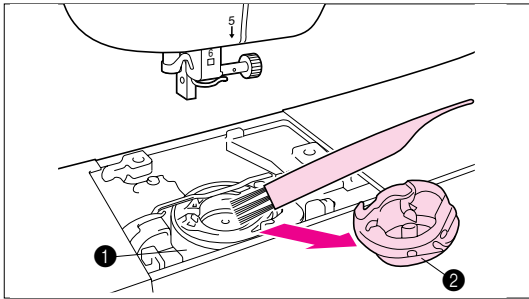

4. Take out the shuttle.
5. Remove accumulated lint and thread from the inner shuttle and race with a brush or a vacuum cleaner.

- ① Race
- ② Shuttle

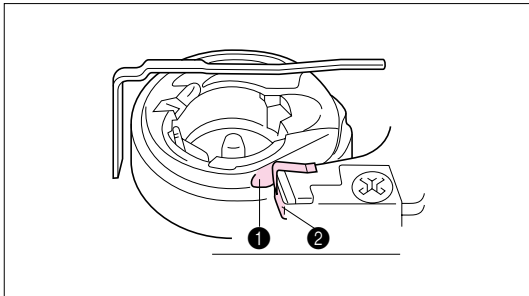

6. Set the shuttle by aligning the shuttle projection with spring of the stopper.

- ① Projection
- ② Spring

* Lint and dust accumulated in the race will sometimes cause poor stitching or malfunction of bobbin thread sensor.

CHANGING THE LIGHT BULB

When replacing the light bulb

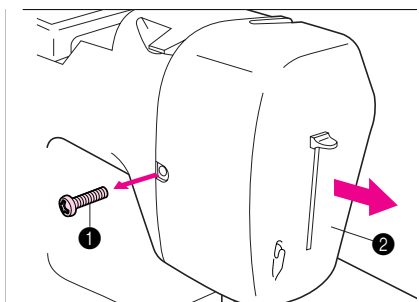

1. Turn the power off.
- * The power cord plug must be removed from the electric outlet prior to changing the bulb.
2. Loosen the screw on the reverse side of sewing head.
3. Remove the end cap.

- ① Screw
- ② End cap

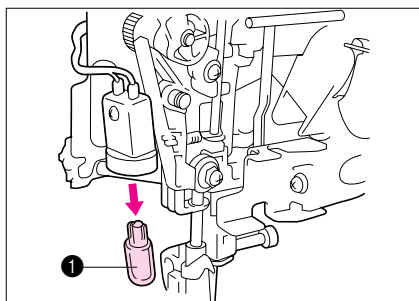

4. Replace the snap in the light bulb with a new one.

- ① Light bulb

- * Light bulbs are available through your dealer. (12V, 5W/ Parts code XA2037051)

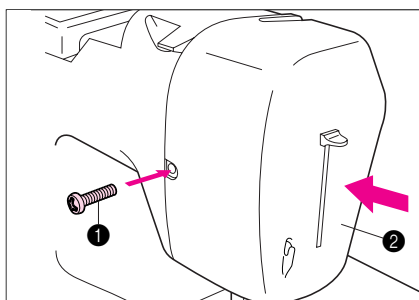

5. Set the end cap.
6. Tighten the screw.

- ① Screw
- ② End cap

ERROR MESSAGES

If the machine is not properly setup when the "START/STOP" or "REVERSE STITCH" button is pushed, or a correction of your operating procedure is necessary, the machine will not start and will instruct you with an alarm and warning message on the LCD.

Warning messages

Check if thread
is entangled.

This message is displayed when the motor is locked, such as when the thread becomes entangled.

Lower presser
foot lever.

This message is displayed when the "START/STOP" or "REVERSE STITCH" button is pushed, or when the foot controller is pressed down while the presser foot is raised.

This pattern
cannot be saved
in memory Page.

This message is displayed when the pattern that you tried to store could not be combined.

No more stitch
can be combined.

This message is displayed when you tried to combine more than 70 patterns.

Return bobbin
winding shaft
to left.

This message is displayed when the "REVERSE STITCH" or "NEEDLE POSITION" button is pushed while the bobbin winder shaft is at the right.

Disconnect
foot control.

This message is displayed when the "START/STOP" button is pushed while the foot controller is connected.

Lift
buttonhole lever

This message is displayed when a pattern other than a buttonhole is selected and the "START/STOP" or "REVERSE STITCH" button is pushed while the buttonhole lever is lowered.

Lower
buttonhole lever

This message is displayed when a buttonhole pattern is selected and the "START/STOP" or "REVERSE STITCH" button is pushed while the buttonhole lever is raised.

* In this case, the machine can only rotate once.

Select pattern.

This message appears when the "START/STOP" or "REVERSE STITCH" button is pushed, but no pattern has been selected.

This stitch can
not be combined.

This message appears when trying to combine stitches that cannot be combined.

No pattern is
memorized.

This message appears when a memory stitch number is entered, but no pattern has been stored under it.

Messages

Saving

This message appears when the "MEMORY" key is touched to store a pattern.

Winding
bobbin thread.

This message appears while the bobbin is winding.

Alarm

- When operating correctly : 1 beep
- When operating incorrectly : 2 beeps or 4 beeps

Trouble with threads and stitches

Before calling for service, check the following items. If the problem still persists, contact the place of purchase or your nearest authorized Brother dealer.

Symptom	Probable cause	Remedy
1. Upper thread breaks	1. Upper threading is not correct.	1. Re-thread upper thread.
	2. Upper thread is entangled.	2. Remove thread ends in the race or shuttle.
	3. Spool of thread is not correctly set.	3. Set spool of thread correctly.
	4. Correct needle is not used.	4. Change to proper needle.
	5. Shuttle is damaged.	5. Contact service center.
2. Bobbin thread breaks	1. Upper thread is entangled.	1. Remove thread ends in the race or inner shuttle.
	2. Bobbin is not threaded properly in the shuttle.	2. Set bobbin properly and pull out the bobbin thread.
3. Skipped stitches	1. Needle is not correctly inserted.	1. Insert needle properly.
	2. Correct needle is not used.	2. Change to proper needle.
	3. The combination of fabric, thread and needle is not correct.	3. Check the "FABRIC/THREAD/NEEDLE COMBINATION CHART" on page 27.
	4. Dust is clinging under the needle plate.	4. Remove dust by cleaning with a brush.
	5. Upper threading is not correct.	5. Re-thread upper thread.
4. Fabric puckers	1. Threading is not correct.	1. Re-thread upper and bobbin thread correctly.
	2. Correct needle is not used.	2. Change to proper needle.
	3. Combination of fabric, thread and needle is not correct.	3. Check the "FABRIC/THREAD/NEEDLE COMBINATION CHART" on page 27.
	4. Thread tension is too tight.	4. Refer to "THREAD TENSION" on page 22.
5. Inability to thread needle	1. Needle position is not correct.	1. Set needle at proper position using "NEEDLE POSITION" button.
	2. Hook of needle threader does not fit into the eye of the needle.	2. Set needle at proper position using "NEEDLE POSITION" button.
6. Inability for thread tension control	1. Upper threading is not correct.	1. Re-thread upper thread.
	2. Set of bobbin thread is not correct.	2. Set bobbin properly and pull out the bobbin thread.
	3. Combination of fabric, thread and needle is not correct.	3. Check the "FABRIC/THREAD/NEEDLE COMBINATION CHART" on page 27.
	4. Presser foot holder is not correctly installed.	4. Install the foot holder correctly.
7. Shifted sewing position of fonts and patterns	1. Pattern sewing position is not correctly adjusted.	1. Refer to "ADJUSTING STITCH PATTERNS" on page 87.

Mechanical trouble



Symptom	Probable cause	Remedy
1. Fabric is not fed properly	1. Feed dog is lowered.	1. Raise the feed dog with the feed dog adjustment lever.
	2. Stitch length is set at no feeding.	2. Set stitch length properly.
	3. The combination of selected stitch and presser foot is not correct.	3. Change presser foot to correct one.
	4. Correct needle is not being used.	4. Change to proper needle.
	5. Thread is entangled.	5. Remove thread-ends in the race or inner shuttle.
2. Needle breaks	1. Needle is not correctly inserted.	1. Set needle properly.
	2. Correct needle is not used.	2. Change to proper needle.
	3. The combination of fabric, thread and needle is not correct.	3. Check the "FABRIC/THREAD/NEEDLE COMBINATION CHART" on page 27.
	4. The fabric is pulled too much.	4. Guide the fabric allowing it to sew without pulling.
3. Machine does not start	1. "START/STOP" button is not pressed.	1. Press "START/STOP" button.
	2. Main power switch is in the off position.	2. Turn the power on.
	3. Presser foot is not lowered.	3. Lower the presser foot.
4. Display is hard to read	1. LCD contrast is not correct.	1. Adjust the LCD contrast with the screen brightness control lever.

Note

- If the power goes out while the sewing machine is being operated:
Turn off the sewing machine and unplug its power cord.
When the sewing machine is restarted, operate it correctly according to the operating procedure.

SEWING CHART

SELECT KEY	NAME OF PATTERN	PATTERN	TYPE OF PRESSER FOOT	USE	REINFORCEMENT STITCHING	STITCH ADJUSTMENT BY STITCH WIDTH KEYS	STITCH ADJUSTMENT BY STITCH LENGTH KEYS	AUTOMATIC REINFORCEMENT STITCHING	SELECT KEY	NAME OF PATTERN	PATTERN	TYPE OF PRESSER FOOT	USE	REINFORCEMENT STITCHING	STITCH ADJUSTMENT BY STITCH WIDTH KEYS	STITCH ADJUSTMENT BY STITCH LENGTH KEYS	AUTOMATIC REINFORCEMENT STITCHING				
UTILITY STITCH	STRAIGHT			General sewing, gathering, pintuck, etc.	R	-	★	T	UTILITY STITCH	DARNING STITCH			Darning of medium fabric		★	★	T				
					R	★	★	T					Darning of thick fabric		★	★	T				
	TRIPLE STITCH			General sewing for reinforcement	△	★	★	T		BAR TACK			Reinforcement at opening of pocket, etc.		★	★	T				
	STRETCH STITCH			Straight stitching (attaching sleeves, reinforcing, sewing stretch fabrics)	△	★	★	T						EYELET			For making eyelet on belt, etc.		★	★	T
	ZIGZAG			Overcasting, patchwork	R	★	★	T		BUTTON SEWING			Attaching buttons					△	★	-	T
	ELASTIC ZIGZAG			Overcasting (medium, thick and stretch fabrics) Tape attaching, darning	△	★	★	T						APPLIQUE			Appliques	△	★	★	T
	OVERCASTING STITCH			Reinforcing of thin and medium fabric	△	★	★	T		SCALLOP			Decorating collar of blouse, edge of handkerchief					△	★	★	T
				Reinforcing of thick fabric	△	★	★	T						PATCHWORK STITCH			Patchwork stitches, decorative stitching	△	★	★	T
				Reinforcing of medium, thick and easily-frayable fabric	△	★	★	T										SMOCKING			Smocking, decorative stitching
				Reinforcement of stretch fabric	△	★	★	T						FAGOTING			Fagoting, decorative stitching				
	BLIND HEM STITCH			Reinforcement of skirts	△	★	★	T		DECORATIVE STITCH			Decorative stitching for cuffs made from stretch fabric					△	★	★	T
				Reinforcement of skirts with stretch fabric	△	★	★	T						BUTTONHOLE STITCH		Buttonholes for blouses and shirts		★	★	T	
	Buttonholes for pajamas and shirts		★	★	T																
	Buttonholes for stretch fabric		★	★	T																
	Buttonholes for stretch		★	★	T																
	Buttonholes for suits and overalls		★	★	T																
	Buttonholes for jeans and trousers		★	★	T																
	Buttonholes for thick coats		★	★	T																

SELECT KEY	NAME OF PATTERN	TYPE OF PRESSER FOOT	USE	MEMORY	STITCH ADJUSTMENT BY STITCH WIDTH KEYS	STITCH ADJUSTMENT BY STITCH LENGTH KEYS	AUTOMATIC REINFORCEMENT STITCHING
CHARACTERS	ALPHABET		Character sewing	○	★	★	T
	DECORATIVE STITCH		Decorative stitching	○	★	★	T
	SATIN STITCH			○	★	★	T
	CROSS STITCH			○	-	-	T

R : The machine sews in reverse while the “REVERSE STITCH” button is pushed.

△ : The machine sews three reinforcement stitches and stops when the “REVERSE STITCH” button is pushed.

★ : Adjustments can be made.

- : Adjustments cannot be made.



T : Reverse stitches are automatically sewn at the beginning and end of sewing a pattern.

T : If “REVERSE STITCH” was set before sewing, reverse stitches are automatically sewn at the beginning of sewing and end of sewing.

○ : Can be combined and stored in the memory.

HOW TO USE WALKING FOOT (OPTIONAL ACCESSORY)

This foot is very useful for sewing materials such as vinyl cloth, synthetic leather, thin leather, etc. These materials are difficult to be fed when sewing but this foot can prevent such materials from crumpling, slipping or sticking between presser foot and materials thanks to even feeding upper and lower materials.

- You can use walking foot for sewing STRAIGHT STITCH ( · ) and ZIGZAG STITCH ().
- This can be used for only 7 mm (stitch width).

Note

You can not use this foot for sewing other patterns.

Please sew in slow to medium speed.

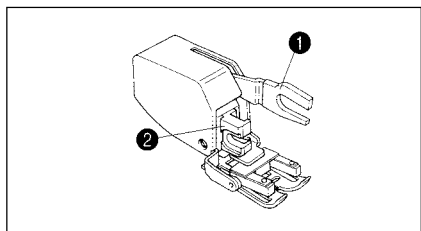

- ① Connecting lever
- ② Presser bar holder

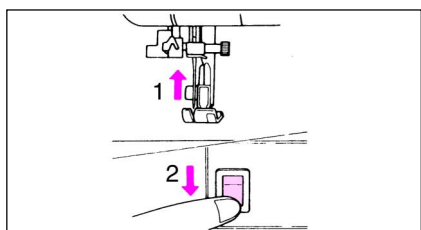

1. Raise the needle and turn the power off.

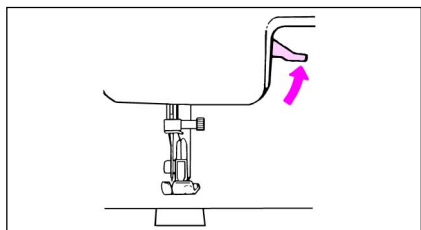

2. Raise the presser foot and remove the presser foot.

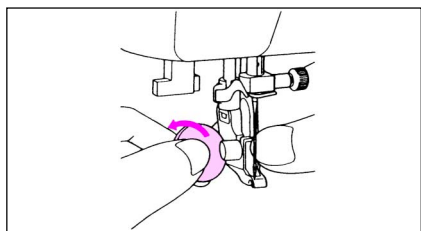

3. Loosen the presser foot holder screw and remove the presser foot holder.

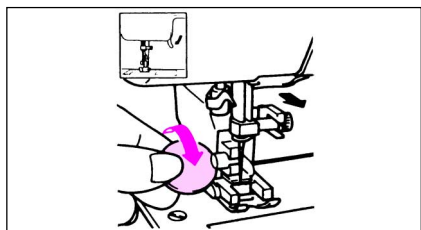

4. Position the connecting lever of Walking foot on the needle fixing screw and install Walking foot on to the presser bar. Lower the presser foot and tighten the presser foot holder screw.

PATTERNS (PROGRAMMED IN MACHINE)

Utility stitches

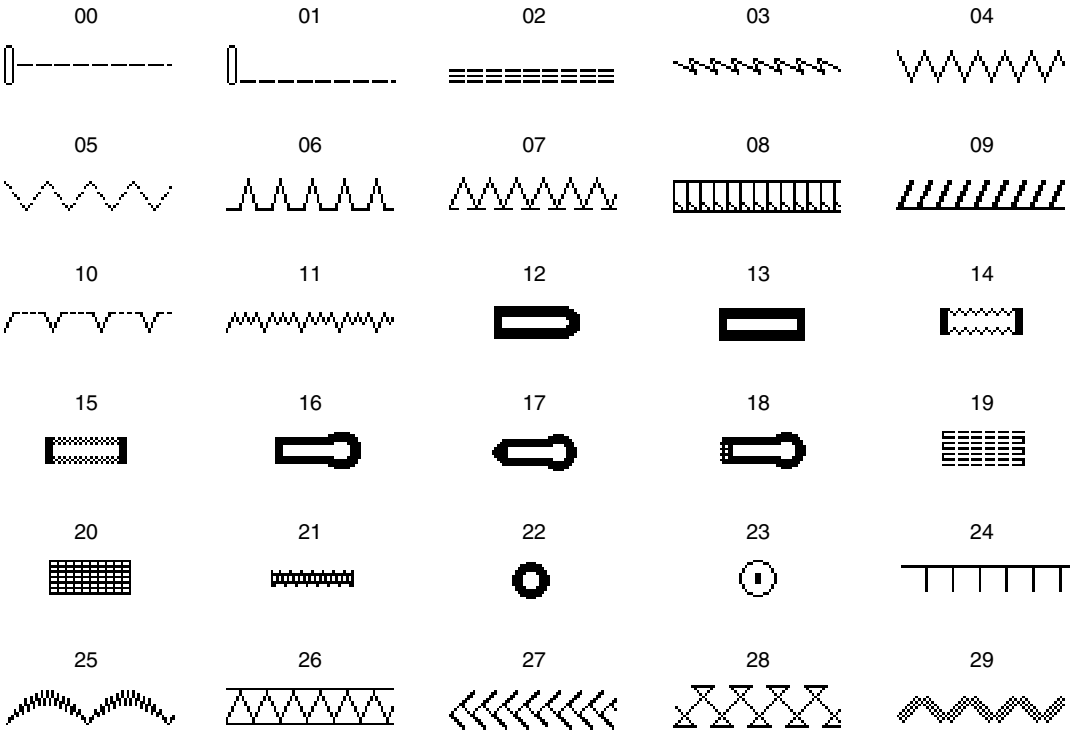

Character sewing

Alphabet (Block style)

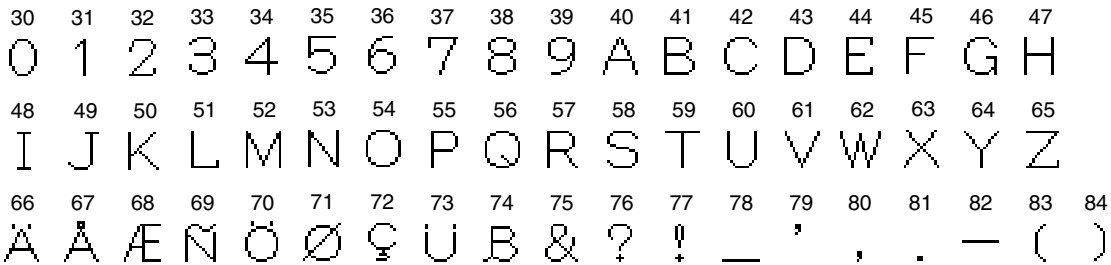

Alphabet (Italic style)

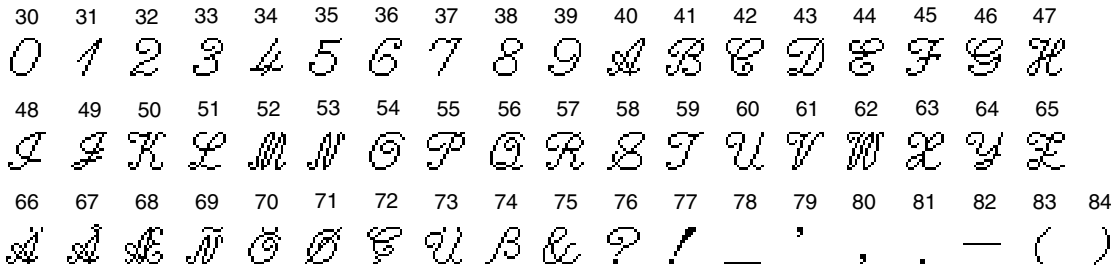

Alphabet (Outline style)



Decorative stitches

Satin stitches

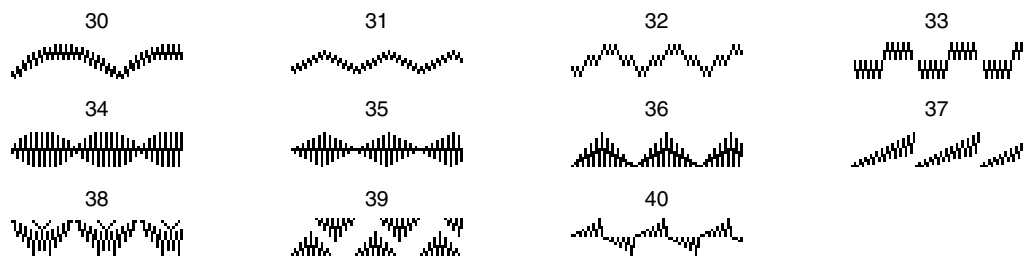

Cross stitches

Size cannot be changed.



Hairloom



Decorative stitch

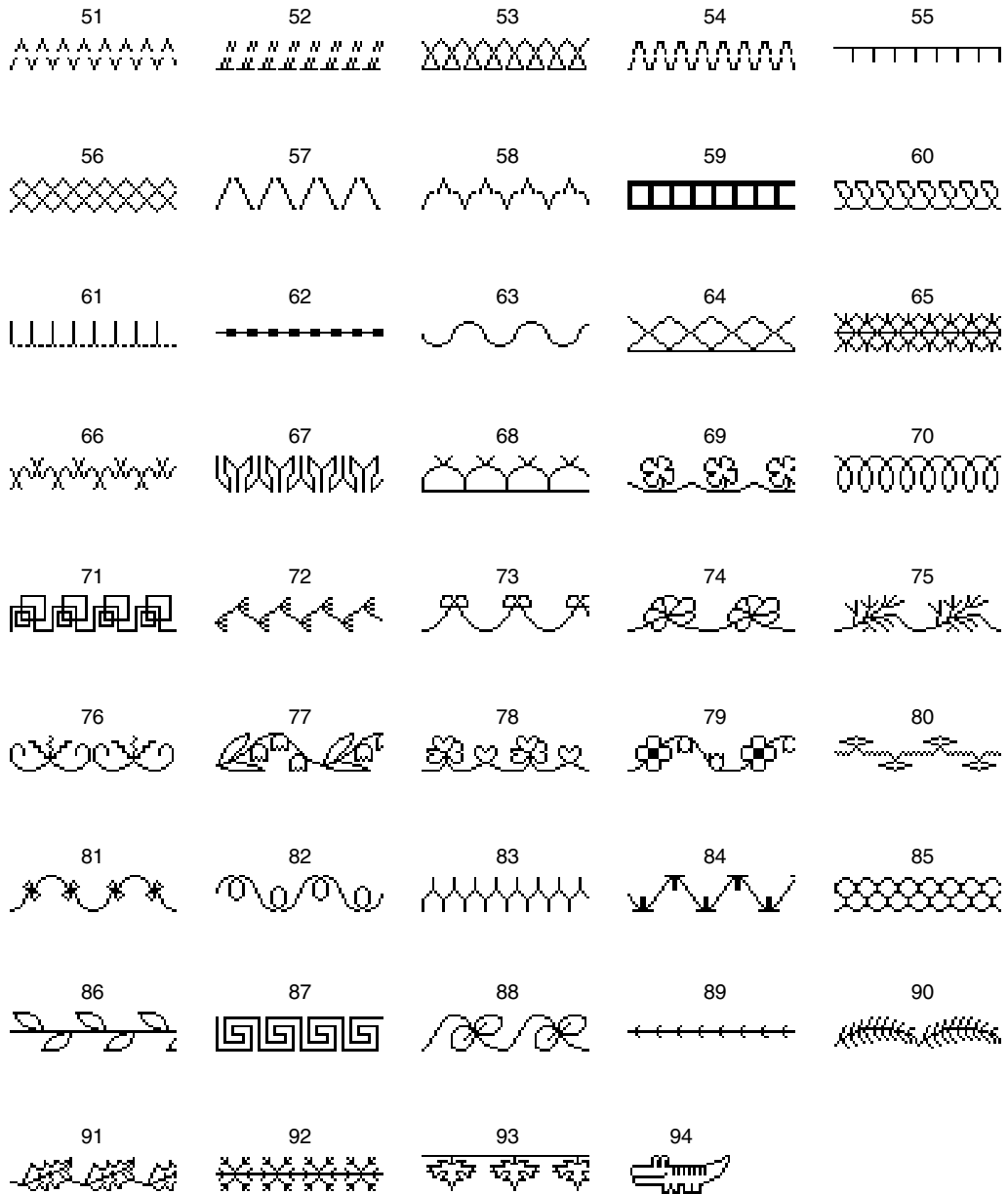

ENGLISH
882-955
194955-011
Printed in Taiwan

Free Manuals Download Website

<http://myh66.com>

<http://usermanuals.us>

<http://www.somanuals.com>

<http://www.4manuals.cc>

<http://www.manual-lib.com>

<http://www.404manual.com>

<http://www.luxmanual.com>

<http://aubethermostatmanual.com>

Golf course search by state

<http://golfingnear.com>

Email search by domain

<http://emailbydomain.com>

Auto manuals search

<http://auto.somanuals.com>

TV manuals search

<http://tv.somanuals.com>