

6H203-24 and 6H253-13 SmartSwitch 6000 Interface Modules Installation User's Guide



caption
systems



Only qualified personnel should perform installation procedures.

NOTICE

Cabletron Systems reserves the right to make changes in specifications and other information contained in this document without prior notice. The reader should in all cases consult Cabletron Systems to determine whether any such changes have been made.

The hardware, firmware, or software described in this manual is subject to change without notice.

IN NO EVENT SHALL CABLETRON SYSTEMS BE LIABLE FOR ANY INCIDENTAL, INDIRECT, SPECIAL, OR CONSEQUENTIAL DAMAGES WHATSOEVER (INCLUDING BUT NOT LIMITED TO LOST PROFITS) ARISING OUT OF OR RELATED TO THIS MANUAL OR THE INFORMATION CONTAINED IN IT, EVEN IF CABLETRON SYSTEMS HAS BEEN ADVISED OF, KNOWN, OR SHOULD HAVE KNOWN, THE POSSIBILITY OF SUCH DAMAGES.

Cabletron Systems, Inc.
35 Industrial Way
Rochester, NH 03867

© 2000 by Cabletron Systems, Inc.
All Rights Reserved
Printed in the United States of America

Order Number: 9033380 January 2000

Cabletron Systems, **QuickSET**, **SecureFast**, and **LANVIEW** are registered trademarks and **SmartSwitch** is a trademark of Cabletron Systems, Inc.

All other product names mentioned in this manual may be trademarks or registered trademarks of their respective companies.

FCC NOTICE

This device complies with Part 15 of the FCC rules. Operation is subject to the following two conditions: (1) this device may not cause harmful interference, and (2) this device must accept any interference received, including interference that may cause undesired operation.

NOTE: This equipment has been tested and found to comply with the limits for a Class A digital device, pursuant to Part 15 of the FCC rules. These limits are designed to provide reasonable protection against harmful interference when the equipment is operated in a commercial environment. This equipment uses, generates, and can radiate radio frequency energy and if not installed in accordance with the operator's manual, may cause harmful interference to radio communications. Operation of this equipment in a residential area is likely to cause interference in which case the user will be required to correct the interference at his own expense.

WARNING: Changes or modifications made to this device which are not expressly approved by the party responsible for compliance could void the user's authority to operate the equipment.

INDUSTRY CANADA NOTICE

This digital apparatus does not exceed the Class A limits for radio noise emissions from digital apparatus set out in the Radio Interference Regulations of the Canadian Department of Communications.

Le présent appareil numérique n'émet pas de bruits radioélectriques dépassant les limites applicables aux appareils numériques de la class A prescrites dans le Règlement sur le brouillage radioélectrique édicté par le ministère des Communications du Canada.

VCCI NOTICE

This is a Class A product based on the standard of the Voluntary Control Council for Interference by Information Technology Equipment (VCCI). If this equipment is used in a domestic environment, radio disturbance may arise. When such trouble occurs, the user may be required to take corrective actions.

この装置は、情報処理装置等電波障害自主規制協議会（VCCI）の基準



CABLETRON SYSTEMS, INC. PROGRAM LICENSE AGREEMENT

**IMPORTANT: THIS LICENSE APPLIES FOR USE OF PRODUCT IN THE FOLLOWING
GEOGRAPHICAL REGIONS:**

**CANADA
MEXICO
CENTRAL AMERICA
SOUTH AMERICA**

**BEFORE OPENING OR UTILIZING THE ENCLOSED PRODUCT, CAREFULLY READ
THIS LICENSE AGREEMENT.**

This document is an agreement (“Agreement”) between You, the end user, and Cabletron Systems, Inc. (“Cabletron”) that sets forth your rights and obligations with respect to the Cabletron software program (“Program”) in the package. The Program may be contained in firmware, chips or other media. UTILIZING THE ENCLOSED PRODUCT, YOU ARE AGREEING TO BECOME BOUND BY THE TERMS OF THIS AGREEMENT, WHICH INCLUDES THE LICENSE AND THE LIMITATION OF WARRANTY AND DISCLAIMER OF LIABILITY. IF YOU DO NOT AGREE TO THE TERMS OF THIS AGREEMENT, RETURN THE UNOPENED PRODUCT TO CABLETRON OR YOUR DEALER, IF ANY, WITHIN TEN (10) DAYS FOLLOWING THE DATE OF RECEIPT FOR A FULL REFUND.

IF YOU HAVE ANY QUESTIONS ABOUT THIS AGREEMENT, CONTACT CABLETRON SYSTEMS
+1- 603-332-9400. Attn: Legal Department.

1. LICENSE. You have the right to use only the one (1) copy of the Program provided in this package subject to the terms and conditions of this License Agreement.

You may not copy, reproduce or transmit any part of the Program except as permitted by the Copyright Act of the United States or as authorized in writing by Cabletron.

2. OTHER RESTRICTIONS. You may not reverse engineer, decompile, or disassemble the Program.

3. APPLICABLE LAW. This License Agreement shall be interpreted and governed under the laws and in the state and federal courts of New Hampshire. You accept the personal jurisdiction and venue of the New Hampshire courts.

4. EXPORT REQUIREMENTS. You understand that Cabletron and its Affiliates are subject to regulation by agencies of the U.S. Government, including the U.S. Department of Commerce, which prohibit export or diversion of certain technical products to certain countries, unless a license to export the product is obtained from the U.S. Government or an exception from obtaining such license may be relied upon by the exporting party.

If the Program is exported from the United States pursuant to the License Exception CIV under the U.S. Export Administration Regulations, You agree that You are a civil end user of the Program and agree that You will use the Program for civil end uses only and not for military purposes.

If the Program is exported from the United States pursuant to the License Exception TSR under the U.S. Export Administration Regulations, in addition to the restriction on transfer set forth in Sections 1 or 2 of this Agreement, You agree not to (i) reexport or release the Program, the source code for the Program or technology to a national of a country in Country Groups D:1 or E:2 (Albania, Armenia, Azerbaijan, Belarus, Bulgaria, Cambodia, Cuba, Estonia, Georgia, Iraq, Kazakhstan, Kyrgyzstan, Laos, Latvia, Libya, Lithuania, Moldova, North Korea, the People's Republic of China, Romania, Russia, Rwanda, Tajikistan, Turkmenistan, Ukraine, Uzbekistan, Vietnam, or such other countries as may be designated by the United States Government), (ii) export to Country Groups D:1 or E:2 (as defined herein) the direct product of the Program or the technology, if such foreign produced direct product is subject to national security controls as identified on the U.S. Commerce Control List, or (iii) if the direct product of the technology is a complete plant or any major component of a plant, export to Country Groups D:1 or E:2 the direct product of the plant or a major component thereof, if such foreign produced direct product is subject to national security controls as identified on the U.S. Commerce Control List or is subject to State Department controls under the U.S. Munitions List.

5. UNITED STATES GOVERNMENT RESTRICTED RIGHTS. The enclosed Product (i) was developed solely at private expense; (ii) contains "restricted computer software" submitted with restricted rights in accordance with section 52.227-19 (a) through (d) of the Commercial Computer Software-Restricted Rights Clause and its successors, and (iii) in all respects is proprietary data belonging to Cabletron and/or its suppliers. For Department of Defense units, the Product is considered commercial computer software in accordance with DFARS section 227.7202-3 and its successors, and use, duplication, or disclosure by the Government is subject to restrictions set forth herein.

6. EXCLUSION OF WARRANTY. Except as may be specifically provided by Cabletron in writing, Cabletron makes no warranty, expressed or implied, concerning the Program (including its documentation and media).

CABLETRON DISCLAIMS ALL WARRANTIES, OTHER THAN THOSE SUPPLIED TO YOU BY CABLETRON IN WRITING, EITHER EXPRESS OR IMPLIED, INCLUDING BUT NOT LIMITED TO IMPLIED WARRANTIES OF MERCHANTABILITY AND FITNESS FOR A PARTICULAR PURPOSE, WITH RESPECT TO THE PROGRAM, THE ACCOMPANYING WRITTEN MATERIALS, AND ANY ACCOMPANYING HARDWARE.

7. NO LIABILITY FOR CONSEQUENTIAL DAMAGES. IN NO EVENT SHALL CABLETRON OR ITS SUPPLIERS BE LIABLE FOR ANY DAMAGES WHATSOEVER (INCLUDING, WITHOUT LIMITATION, DAMAGES FOR LOSS OF BUSINESS, PROFITS, BUSINESS INTERRUPTION, LOSS OF BUSINESS INFORMATION, SPECIAL, INCIDENTAL, CONSEQUENTIAL, OR RELIANCE DAMAGES, OR OTHER LOSS) ARISING OUT OF THE USE OR INABILITY TO USE THIS CABLETRON PRODUCT, EVEN IF CABLETRON HAS BEEN ADVISED OF THE POSSIBILITY OF SUCH DAMAGES. BECAUSE SOME STATES DO NOT ALLOW THE EXCLUSION OR LIMITATION OF LIABILITY FOR CONSEQUENTIAL OR INCIDENTAL DAMAGES, OR IN THE DURATION OR LIMITATION OF IMPLIED WARRANTIES IN SOME INSTANCES, THE ABOVE LIMITATION AND EXCLUSIONS MAY NOT APPLY TO YOU.

CABLETRON SYSTEMS SALES AND SERVICE, INC. PROGRAM LICENSE AGREEMENT

IMPORTANT: THIS LICENSE APPLIES FOR USE OF PRODUCT IN THE UNITED STATES OF AMERICA AND BY UNITED STATES OF AMERICA GOVERNMENT END USERS.

BEFORE OPENING OR UTILIZING THE ENCLOSED PRODUCT, CAREFULLY READ THIS LICENSE AGREEMENT.

This document is an agreement (“Agreement”) between You, the end user, and Cabletron Systems Sales and Service, Inc. (“Cabletron”) that sets forth your rights and obligations with respect to the Cabletron software program (“Program”) in the package. The Program may be contained in firmware, chips or other media. **UTILIZING THE ENCLOSED PRODUCT, YOU ARE AGREEING TO BECOME BOUND BY THE TERMS OF THIS AGREEMENT, WHICH INCLUDES THE LICENSE AND THE LIMITATION OF WARRANTY AND DISCLAIMER OF LIABILITY. IF YOU DO NOT AGREE TO THE TERMS OF THIS AGREEMENT, RETURN THE UNOPENED PRODUCT TO CABLETRON OR YOUR DEALER, IF ANY, WITHIN TEN (10) DAYS FOLLOWING THE DATE OF RECEIPT FOR A FULL REFUND.**

IF YOU HAVE ANY QUESTIONS ABOUT THIS AGREEMENT, CONTACT CABLETRON SYSTEMS
+1-603-332-9400. Attn: Legal Department.

1. LICENSE. You have the right to use only the one (1) copy of the Program provided in this package subject to the terms and conditions of this License Agreement.

You may not copy, reproduce or transmit any part of the Program except as permitted by the Copyright Act of the United States or as authorized in writing by Cabletron.

2. OTHER RESTRICTIONS. You may not reverse engineer, decompile, or disassemble the Program.

3. APPLICABLE LAW. This License Agreement shall be interpreted and governed under the laws and in the state and federal courts of New Hampshire. You accept the personal jurisdiction and venue of the New Hampshire courts.

4. EXPORT REQUIREMENTS. You understand that Cabletron and its Affiliates are subject to regulation by agencies of the U.S. Government, including the U.S. Department of Commerce, which prohibit export or diversion of certain technical products to certain countries, unless a license to export the product is obtained from the U.S. Government or an exception from obtaining such license may be relied upon by the exporting party.

If the Program is exported from the United States pursuant to the License Exception CIV under the U.S. Export Administration Regulations, You agree that You are a civil end user of the Program and agree that You will use the Program for civil end uses only and not for military purposes.

If the Program is exported from the United States pursuant to the License Exception TSR under the U.S. Export Administration Regulations, in addition to the restriction on transfer set forth in Sections 1 or 2 of this Agreement, You agree not to (i) reexport or release the Program, the source code for the Program or technology to a national of a country in Country Groups D:1 or E:2 (Albania, Armenia, Azerbaijan, Belarus, Bulgaria, Cambodia, Cuba, Estonia, Georgia, Iraq, Kazakhstan, Kyrgyzstan, Laos, Latvia, Libya, Lithuania, Moldova, North Korea, the People’s Republic of China, Romania, Russia, Rwanda, Tajikistan, Turkmenistan, Ukraine, Uzbekistan, Vietnam, or such other countries as may be designated by the United States Government), (ii) export to Country Groups D:1 or E:2 (as defined herein) the direct product of the Program or the technology, if such foreign produced direct product is subject to national security controls as identified on the U.S. Commerce Control List, or (iii) if the direct product of the technology is a complete plant or any major component of a plant, export to Country Groups D:1 or E:2 the direct product of the plant or a major component thereof, if such foreign produced direct product is subject to national security controls as identified on the U.S. Commerce Control List or is subject to State Department controls under the U.S. Munitions List.

5. UNITED STATES GOVERNMENT RESTRICTED RIGHTS. The enclosed Product (i) was developed solely at private expense; (ii) contains “restricted computer software” submitted with restricted rights in accordance with section 52.227-19 (a) through (d) of the Commercial Computer Software-Restricted Rights Clause and its successors, and (iii) in all respects is proprietary data belonging to Cabletron and/or its suppliers. For Department of Defense units, the Product is considered commercial computer software in accordance with DFARS section 227.7202-3 and its successors, and use, duplication, or disclosure by the Government is subject to restrictions set forth herein.

6. EXCLUSION OF WARRANTY. Except as may be specifically provided by Cabletron in writing, Cabletron makes no warranty, expressed or implied, concerning the Program (including its documentation and media).

CABLETRON DISCLAIMS ALL WARRANTIES, OTHER THAN THOSE SUPPLIED TO YOU BY CABLETRON IN WRITING, EITHER EXPRESS OR IMPLIED, INCLUDING BUT NOT LIMITED TO IMPLIED WARRANTIES OF MERCHANTABILITY AND FITNESS FOR A PARTICULAR PURPOSE, WITH RESPECT TO THE PROGRAM, THE ACCOMPANYING WRITTEN MATERIALS, AND ANY ACCOMPANYING HARDWARE.

7. NO LIABILITY FOR CONSEQUENTIAL DAMAGES. IN NO EVENT SHALL CABLETRON OR ITS SUPPLIERS BE LIABLE FOR ANY DAMAGES WHATSOEVER (INCLUDING, WITHOUT LIMITATION, DAMAGES FOR LOSS OF BUSINESS, PROFITS, BUSINESS INTERRUPTION, LOSS OF BUSINESS INFORMATION, SPECIAL, INCIDENTAL, CONSEQUENTIAL, OR RELIANCE DAMAGES, OR OTHER LOSS) ARISING OUT OF THE USE OR INABILITY TO USE THIS CABLETRON PRODUCT, EVEN IF CABLETRON HAS BEEN ADVISED OF THE POSSIBILITY OF SUCH DAMAGES. BECAUSE SOME STATES DO NOT ALLOW THE EXCLUSION OR LIMITATION OF LIABILITY FOR CONSEQUENTIAL OR INCIDENTAL DAMAGES, OR IN THE DURATION OR LIMITATION OF IMPLIED WARRANTIES IN SOME INSTANCES, THE ABOVE LIMITATION AND EXCLUSIONS MAY NOT APPLY TO YOU.

CABLETRON SYSTEMS LIMITED PROGRAM LICENSE AGREEMENT

IMPORTANT: THIS LICENSE APPLIES FOR THE USE OF THE PRODUCT IN THE FOLLOWING GEOGRAPHICAL REGIONS:

**EUROPE
MIDDLE EAST
AFRICA
ASIA
AUSTRALIA
PACIFIC RIM**

BEFORE OPENING OR UTILIZING THE ENCLOSED PRODUCT, CAREFULLY READ THIS LICENSE AGREEMENT.

This document is an agreement (“Agreement”) between You, the end user, and Cabletron Systems Limited (“Cabletron”) that sets forth your rights and obligations with respect to the Cabletron software program (“Program”) in the package. The Program may be contained in firmware, chips or other media. **UTILIZING THE ENCLOSED PRODUCT, YOU ARE AGREEING TO BECOME BOUND BY THE TERMS OF THIS AGREEMENT, WHICH INCLUDES THE LICENSE AND THE LIMITATION OF WARRANTY AND DISCLAIMER OF LIABILITY. IF YOU DO NOT AGREE TO THE TERMS OF THIS AGREEMENT, RETURN THE UNOPENED PRODUCT TO CABLETRON OR YOUR DEALER, IF ANY, WITHIN TEN (10) DAYS FOLLOWING THE DATE OF RECEIPT FOR A FULL REFUND.**

IF YOU HAVE ANY QUESTIONS ABOUT THIS AGREEMENT, CONTACT CABLETRON SYSTEMS +1-603-332-9400. Attn: Legal Department.

1. LICENSE. You have the right to use only the one (1) copy of the Program provided in this package subject to the terms and conditions of this License Agreement.

You may not copy, reproduce or transmit any part of the Program except as permitted by the Copyright Act of the United States or as authorized in writing by Cabletron.

2. OTHER RESTRICTIONS. You may not reverse engineer, decompile, or disassemble the Program.

3. APPLICABLE LAW. This License Agreement shall be governed in accordance with English law. The English courts shall have exclusive jurisdiction in the event of any disputes.

4. EXPORT REQUIREMENTS. You understand that Cabletron and its Affiliates are subject to regulation by agencies of the U.S. Government, including the U.S. Department of Commerce, which prohibit export or diversion of certain technical products to certain countries, unless a license to export the product is obtained from the U.S. Government or an exception from obtaining such license may be relied upon by the exporting party.

If the Program is exported from the United States pursuant to the License Exception CIV under the U.S. Export Administration Regulations, You agree that You are a civil end user of the Program and agree that You will use the Program for civil end uses only and not for military purposes.

If the Program is exported from the United States pursuant to the License Exception TSR under the U.S. Export Administration Regulations, in addition to the restriction on transfer set forth in Sections 1 or 2 of this Agreement, You agree not to (i) reexport or release the Program, the source code for the Program or technology to a national of a country in Country Groups D:1 or E:2 (Albania, Armenia, Azerbaijan, Belarus, Bulgaria, Cambodia, Cuba, Estonia, Georgia, Iraq, Kazakhstan, Kyrgyzstan, Laos, Latvia, Libya, Lithuania, Moldova, North Korea, the People's Republic of China, Romania, Russia, Rwanda, Tajikistan, Turkmenistan, Ukraine, Uzbekistan, Vietnam, or such other countries as may be designated by the United States Government), (ii) export to Country Groups D:1 or E:2 (as defined herein) the direct product of the Program or the technology, if such foreign produced direct product is subject to national security controls as identified on the U.S. Commerce Control List, or (iii) if the direct product of the technology is a complete plant or any major component of a plant, export to Country Groups D:1 or E:2 the direct product of the plant or a major component thereof, if such foreign produced direct product is subject to national security controls as identified on the U.S. Commerce Control List or is subject to State Department controls under the U.S. Munitions List.

5. UNITED STATES GOVERNMENT RESTRICTED RIGHTS. The enclosed Product (i) was developed solely at private expense; (ii) contains "restricted computer software" submitted with restricted rights in accordance with section 52.227-19 (a) through (d) of the Commercial Computer Software-Restricted Rights Clause and its successors, and (iii) in all respects is proprietary data belonging to Cabletron and/or its suppliers. For Department of Defense units, the Product is considered commercial computer software in accordance with DFARS section 227.7202-3 and its successors, and use, duplication, or disclosure by the Government is subject to restrictions set forth herein.

6. EXCLUSION OF WARRANTY. Except as may be specifically provided by Cabletron in writing, Cabletron makes no warranty, expressed or implied, concerning the Program (including its documentation and media).

CABLETRON DISCLAIMS ALL WARRANTIES, OTHER THAN THOSE SUPPLIED TO YOU BY CABLETRON IN WRITING, EITHER EXPRESS OR IMPLIED, INCLUDING BUT NOT LIMITED TO IMPLIED WARRANTIES OF MERCHANTABILITY AND FITNESS FOR A PARTICULAR PURPOSE, WITH RESPECT TO THE PROGRAM, THE ACCOMPANYING WRITTEN MATERIALS, AND ANY ACCOMPANYING HARDWARE.

7. NO LIABILITY FOR CONSEQUENTIAL DAMAGES. IN NO EVENT SHALL CABLETRON OR ITS SUPPLIERS BE LIABLE FOR ANY DAMAGES WHATSOEVER (INCLUDING, WITHOUT LIMITATION, DAMAGES FOR LOSS OF BUSINESS, PROFITS, BUSINESS INTERRUPTION, LOSS OF BUSINESS INFORMATION, SPECIAL, INCIDENTAL, CONSEQUENTIAL, OR RELIANCE DAMAGES, OR OTHER LOSS) ARISING OUT OF THE USE OR INABILITY TO USE THIS CABLETRON PRODUCT, EVEN IF CABLETRON HAS BEEN ADVISED OF THE POSSIBILITY OF SUCH DAMAGES. BECAUSE SOME STATES DO NOT ALLOW THE EXCLUSION OR LIMITATION OF LIABILITY FOR CONSEQUENTIAL OR INCIDENTAL DAMAGES, OR IN THE DURATION OR LIMITATION OF IMPLIED WARRANTIES IN SOME INSTANCES, THE ABOVE LIMITATION AND EXCLUSIONS MAY NOT APPLY TO YOU.

DECLARATION OF CONFORMITY

Application of Council Directive(s): **89/336/EEC**
73/23/EEC

Manufacturer's Name: **Cabletron Systems, Inc.**

Manufacturer's Address: **35 Industrial Way**
PO Box 5005
Rochester, NH 03867

European Representative Name: **Mr. J. Solari**

European Representative Address: **Cabletron Systems Limited**
Nexus House, Newbury Business Park
London Road, Newbury
Berkshire RG14 2PZ, England

Conformance to Directive(s)/Product Standards: **EC Directive 89/336/EEC**
EC Directive 73/23/EEC
EN 55022
EN 50082-1
EN 60950

Equipment Type/Environment: **Networking Equipment, for use in a Commercial**
or Light Industrial Environment.

We the undersigned, hereby declare, under our sole responsibility, that the equipment packaged with this notice conforms to the above directives.

Manufacturer

Legal Representative in Europe

Mr. Ronald Fotino

Mr. J. Solari

Full Name

Full Name

Compliance Engineering Manager

Managing Director - E.M.E.A.

Title

Title

Rochester, NH, USA

Newbury, Berkshire, England

Location

Location

Contents

| | |
|--------------|------|
| Figures..... | xiii |
| Tables..... | xiv |

ABOUT THIS GUIDE

| | |
|------------------------------|-------|
| Using This Guide..... | xv |
| Structure of This Guide..... | xvi |
| Related Manuals..... | xvii |
| Document Conventions..... | xviii |

1

INTRODUCTION

| | | |
|--------|-------------------------------------|-----|
| 1.1 | Overview..... | 1-1 |
| 1.1.1 | Connectivity..... | 1-3 |
| 1.1.2 | Auto-Negotiation..... | 1-3 |
| 1.1.3 | Runtime IP Address Discovery..... | 1-3 |
| 1.1.4 | Full Duplex Switched Ethernet..... | 1-4 |
| 1.1.5 | SmartTrunk..... | 1-4 |
| 1.1.6 | Remote Monitoring (RMON)..... | 1-5 |
| 1.1.7 | Broadcast Suppression..... | 1-5 |
| 1.1.8 | Port/VLAN Redirect Functions..... | 1-5 |
| 1.1.9 | Rate Limiting..... | 1-5 |
| 1.1.10 | GARP Switch Operation..... | 1-6 |
| 1.1.11 | Flow Control..... | 1-6 |
| 1.1.12 | 802.1 Port Priority..... | 1-7 |
| 1.1.13 | Management..... | 1-7 |
| 1.1.14 | Switching Options..... | 1-7 |
| 1.1.15 | Distributed Chassis Management..... | 1-8 |
| 1.1.16 | Optional HSIMs and VHSIMs..... | 1-8 |
| 1.1.17 | Standards Compatibility..... | 1-8 |
| 1.1.18 | LANVIEW Diagnostic LEDs..... | 1-8 |
| 1.1.19 | Year 2000 Compliance..... | 1-8 |
| 1.2 | Getting Help..... | 1-9 |

| | | |
|----------|-----------------------------|-----|
| 2 | NETWORK REQUIREMENTS | |
| 2.1 | SmartTrunk..... | 2-1 |
| 2.2 | 10BASE-T Network..... | 2-1 |
| 2.3 | 100BASE-TX Network..... | 2-2 |

| | | |
|----------|--|-----|
| 3 | INSTALLATION | |
| 3.1 | Unpacking the module | 3-1 |
| 3.2 | Installing Options..... | 3-2 |
| 3.3 | Installing the Module into the 6C105 Chassis | 3-2 |
| 3.4 | Connecting to the Network..... | 3-4 |
| 3.4.1 | Connecting Twisted Pair Cables to Fixed Ports..... | 3-4 |
| 3.5 | Completing the Installation..... | 3-6 |

| | | |
|----------|--------------------------------|------|
| 4 | TROUBLESHOOTING | |
| 4.1 | Using LANVIEW..... | 4-1 |
| 4.1.1 | The LED Mode Switch | 4-1 |
| 4.2 | Troubleshooting Checklist..... | 4-6 |
| 4.3 | Using the RESET Button..... | 4-11 |

| | | |
|----------|-----------------------------------|-----|
| A | SPECIFICATIONS | |
| A.1 | Module Specifications | A-1 |
| A.2 | Physical Properties | A-1 |
| A.3 | Environmental Requirements..... | A-1 |
| A.4 | Input/Output Ports..... | A-2 |
| A.5 | COM Port Pinout Assignments | A-2 |
| A.6 | Regulatory Compliance..... | A-3 |

| | | |
|----------|--|-----|
| B | SWITCH SETTINGS, UPGRADES, AND INSTALLATIONS | |
| B.1 | Setting the Mode Switches..... | B-1 |
| B.2 | SIMM Upgrade..... | B-3 |
| B.2.1 | Locating SIMMs | B-3 |
| B.2.2 | Installing the DRAM SIMM..... | B-4 |
| B.3 | Installing Optional High Speed Interface Modules | B-5 |

INDEX

Figures

| Figure | | Page |
|--------|---|------|
| 1-1 | The 6H203-24 and 6H253-13 SmartSwitches..... | 1-2 |
| 3-1 | Installing an Interface Module | 3-3 |
| 3-2 | Connecting a Twisted Pair Segment to the SmartSwitch..... | 3-5 |
| 4-1 | LANVIEW LEDs | 4-3 |
| 4-2 | RESET Button..... | 4-11 |
| B-1 | Module Mode Switch Location/Component Layout..... | B-2 |
| B-2 | SIMM Slot Locations | B-3 |
| B-3 | Installing the DRAM..... | B-4 |
| B-4 | HSIM and VHSIM Connector Locations | B-5 |

Tables

| Table | | Page |
|-------|--|------|
| 3-1 | Contents of Shipping Container | 3-1 |
| 4-1 | LANVIEW LEDs CPU, Receive, and Transmit Status | 4-4 |
| 4-2 | Speed and Full Duplex LED Indications | 4-5 |
| 4-3 | Fault Identification | 4-6 |
| 4-4 | Power System Troubleshooting | 4-7 |
| 4-5 | Firmware Troubleshooting | 4-8 |
| 4-6 | Management System Troubleshooting | 4-9 |
| 4-7 | Device Setup Troubleshooting | 4-10 |

About This Guide

Welcome to the Cabletron Systems **6H203-24 and 6H253-13 SmartSwitch 6000 Interface Modules Installation User's Guide**. This guide describes the SmartSwitch Interface Modules and provides information concerning network requirements, installation, and troubleshooting. For information about how to use Local Management to configure and manage the SmartSwitch series, refer to the *SmartSwitch Series 6H202, 6H203, 6H252, 6H253, 6H258, 6H259, 6H262, 6E233, and 6E253 Local Management User's Guide*.

Important Notice

Depending on the firmware version used in the SmartSwitch, some features described in this document may not be supported. Refer to the Release Notes shipped with the device to determine which features are supported.

USING THIS GUIDE

Read through this guide completely to understand SmartSwitch module features, capabilities, and Local Management functions.

A general working knowledge of Fast Ethernet and IEEE 802.3 type data communications networks and their physical layer components is helpful when using these devices.



In this document, the SmartSwitch Interface Modules are referred to as either "SmartSwitches" or "modules". When differences between the modules are described, the modules will be referred to by name.

STRUCTURE OF THIS GUIDE

This guide is organized as follows:

This section provides preliminary information that will aid in using this manual, lists technology and user guides that may help the user to set up and manage the SmartSwitch modules, and gives instructions on how to get help from Cabletron Systems.

Chapter 1, Introduction, describes the features of the SmartSwitch modules.

Chapter 2, Network Requirements, outlines the network requirements that must be met before installing the SmartSwitches into the 6C105 SmartSwitch 6000 chassis.

Chapter 3, Installation, provides instructions on how to install the module in the chassis and connect segments to the device.

Chapter 4, Troubleshooting, details the SmartSwitch LANVIEW LEDs that enable quick diagnosis of network/operational problems.

Appendix A, Specifications, contains information on functionality and operating specifications, connector pinouts, environmental requirements, and physical properties.

Appendix B, Switch Settings, Upgrades, and Installations, describes how to set the Mode Switches, and gives information on upgrading the SmartSwitch modules.

RELATED MANUALS

The following manuals are recommended to help the user to set up and manage the SmartSwitches:

- *SmartSwitch Series 6H202, 6H203, 6H252, 6H253, 6H258, 6H259, 6H262, 6E233, and 6E253 Local Management User's Guide*
- *6C105 SmartSwitch 6000 Overview and Setup Guide*
- *Ethernet Technology Guide*
- *Cabling Guide*
- *802.1Q VLAN User's Guide*
- *SmartTrunk User's Guide*

The following manuals, as applicable, may help the user to set up and manage SmartSwitch modules:

- *HSIM-A6DP User's Guide*
- *HSIM-F6 User's Guide*
- *HSIM-FE6 User's Guide*
- *HSIM-W6 Installation Guide*
- *HSIM-W84 Installation Guide*
- *HSIM-W87 User's Guide*
- *HSIM-G01/G09 User's Guide*
- *VHSIM-G6 User's Guide*
- *WAN Series Local Management User's Guide*
- *VHSIM-A6DP User's Guide*

The *HSIM-W6 Installation Guide*, the *HSIM-W84 Installation Guide*, and the *WAN Series Local Management User's Guide* are included on the QuickSET CD-ROM and, along with the other manuals referenced above, can be obtained on the World Wide Web in Adobe Acrobat Portable Document Format (PDF) at the following site:

<http://www.cabletron.com/>



All documentation for Cabletron Systems SecureFast VLAN Manager software can be found on the VLAN Manager CD-ROM.

DOCUMENT CONVENTIONS

The following conventions are used throughout this document:

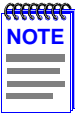

Note symbol. Calls the reader's attention to any item of information that may be of special importance.



Tip symbol. Conveys helpful hints concerning procedures or actions.



Caution symbol. Contains information essential to avoid damage to the equipment.



Electrical Hazard Warning symbol. Warns against an action that could result in personal injury or death due to an electrical hazard.

Introduction

This chapter introduces the 6H203-24 and 6H253-13 SmartSwitch 6000 interface modules and provides information about how to obtain additional support from Cabletron Systems.

Important Notice

Depending on the firmware version used in the SmartSwitches, some features described in this document may not be supported. Refer to the Release Notes shipped with the device to determine which features are supported.

1.1 OVERVIEW

The SmartSwitches shown in [Figure 1-1](#) are Ethernet/Fast Ethernet interface modules for the Cabletron Systems 6C105 chassis. The 6H203-24 has two RJ21 champ connectors, for a total of 24 switched ports. The 6H253-13 has one RJ21 champ connector, for a total of 12 switched ports and 1 slot for an optional High Speed Interface Module (HSIM) or Very High Speed Interface Module (VHSIM).

The SmartSwitch can be used to connect individual high-bandwidth user devices, such as workstations, or to provide a central switching point for multiple 10/100 Mbps Fast Ethernet segments. The optional HSIMs provide one or more high speed uplinks to networking technologies such as Gigabit Ethernet, Fast Ethernet, Fiber Distributed Data Interface (FDDI), Wide Area Network (WAN) and Asynchronous Transfer Mode (ATM). Some HSIMs can also provide additional Fast Ethernet ports in varying media types. The optional VHSIMs provide very high speed uplinks to networking technologies such as ATM and Gigabit Ethernet.

The SmartSwitch ports can be configured to control frame traffic several ways, including prioritizing traffic flow according to protocol type. The SmartSwitches can also be configured to establish Virtual Local Area Networks (VLANs) and control the flow of frames associated with each VLAN according to priority and Ether type. Detailed information about VLANs is provided in the *Local Management User's Guide* for this module.

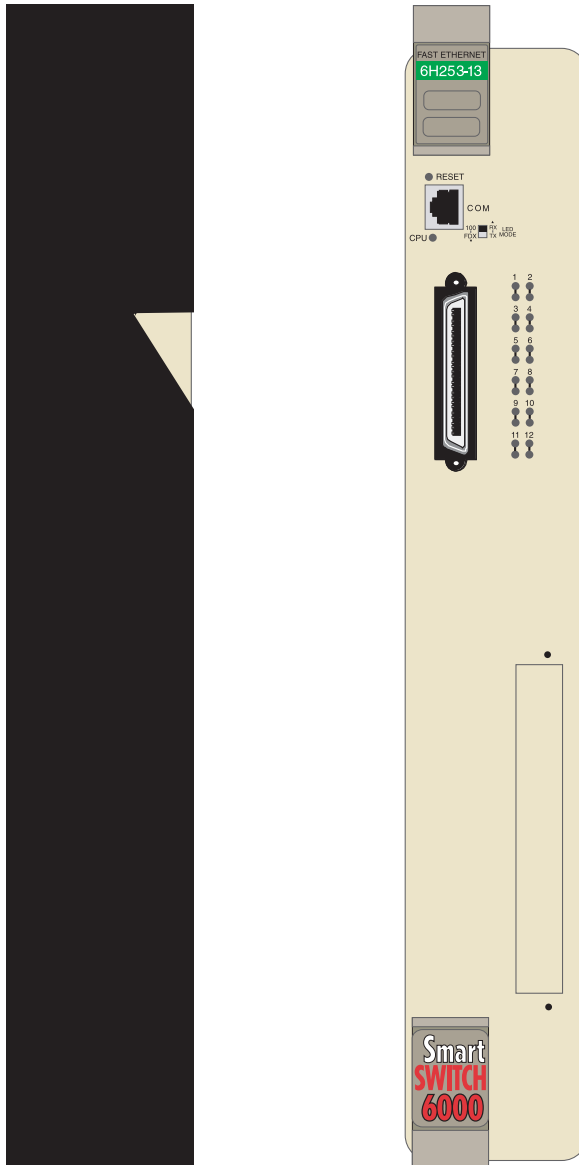
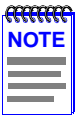

Figure 1-1 The 6H203-24 and 6H253-13 SmartSwitches

1.1.1 Connectivity

When the modules are connected to the network and powered up, Runtime IP Address Discovery (RAD) checks the modules for an IP address. If one has not yet been assigned (module and 6C105 chassis IP address set to 0.0.0.0), RAD checks to see if any of the module interfaces have a link. If so, RAD sends out Reverse Address Resolution Protocol (RARP) and BootP requests to obtain an IP address from a RARP or BootP server on the network.

The RAD requests start at an interval of one per second. The interval then doubles after every transmission until an interval of 300 seconds is reached. At this point, the interval remains at 300 seconds. The RAD requests continue until an IP address is received from a RARP or BootP server, or an IP address is entered using Local Management.



The module will reboot after RAD is successful.

1.1.4 Full Duplex Switched Ethernet

Each switched Fast Ethernet port on the SmartSwitches supports 10/100 Mbps operation and can be configured to operate in Full Duplex Switched Ethernet (FDSE) mode. FDSE allows each port to provide up to 200 Mbps of bandwidth.

1.1.5 SmartTrunk

SmartTrunk, also referred to as SmartTrunking, is Cabletron Systems' terminology for load balancing or load sharing. SmartTrunk technology provides an easy-to-implement mechanism to group, or aggregate, multiple links of any technology together to scale the backbone bandwidth beyond the limitations of a single link. All links are user-configurable so administrators can scale the backbone bandwidth by adding SmartTrunk links.

The benefits of SmartTrunking include the following:

- All purchased bandwidth is used.
- Distributed, resilient links increase reliability and performance.
- Multiple technologies are supported within a single trunk for maximum flexibility.

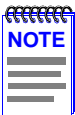

For information on SmartTrunk configuration, refer to the Cabletron Systems *SmartTrunk User's Guide*.

1.1.6 Remote Monitoring (RMON)

The SmartSwitches support all nine Ethernet RMON groups. The Statistics, Alarms, Events and History groups are enabled on all ports by default.

Cabletron Systems RMON Actions is a vendor-specific extension of RMON and provides the ability to set an “Action” on any SNMP MIB variable. The Action can be triggered by setting an RMON Event and/or Alarm. An example of an Action would be to turn off a MIB-2 interface if a broadcast threshold is crossed.

1.1.7 Broadcast Suppression

Broadcast Suppression enables a user to set a desired limit of receive broadcast frames per port/per second to be forwarded out the other ports on the module up to the set limit. Any broadcast frames above this specified limit are dropped. In the event that broadcast frames are being suppressed, multicast and unicast frames continue to be switched.

1.1.8 Port/VLAN Redirect Functions

The port redirect function, also referred to as “Port Mirroring,” is a troubleshooting tool used to map traffic from a single source port to a single destination port within the device. The feature allows frames, including those with errors, to be copied and sent to an analyzer or RMON probe. The analyzer or RMON probe will see the data as if it were directly connected to the LAN segment of the source port.

The VLAN redirect function is similar to the port redirect function except that the frames received by the device are redirected to a designated destination port according to the VLAN classification of the frames received. The VLAN redirect function does not support redirecting errors, and is only supported when the device is operating as an 802.1Q switch. Multiple VLANs can be directed to the same ports.

1.1.9 Rate Limiting

The Rate Limiting feature enables the SmartSwitch device to have control of traffic rates on a per-port, per-priority basis. The network administrator can configure a rate limit (from 100 kbps to 1 Gbps) for a given port with an associated list of IEEE 802.1p priorities (which can include one, some, or all of the eight priority levels defined in 802.1p). Each rate limit is specified as an inbound or an outbound limit. The combined rate of all traffic on the port that matches the listed priorities cannot exceed the programmed limit. If the rate exceeds the defined limit, frames are dropped until the rate falls below the limit.

Administrators can configure up to four rate limit rules per port; however, each rule must not include conflicting 802.1p priority values. In order to control traffic inbound and outbound on the same port, two rate limit rules must be configured (one inbound and one outbound). Since the rate limiting operation occurs after the processing of the multi-layer classification rules, the two features can be combined to provide application-aware rate limiting.

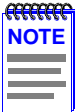

This traffic rate function is not supported on ports configured as SmartTrunk ports.

For more information about the application of the Rate Limiting function, refer to the *SmartSwitch Series 6H202, 6H203, 6H252, 6H253, 6H258, 6H259, 6H262, 6E233, and 6E253 Local Management User's Guide*.

1.1.10 GARP Switch Operation

Some or all ports on the switch may be activated to operate under the Generic Attribute Registration Protocol (GARP) applications, GARP VLAN Registration Protocol (GVRP) and/or GARP Multicast Registration Protocol (GMRP).

GARP is a protocol, or set of rules, that outlines a mechanism for propagating the port state and/or user information throughout a bridged LAN to keep track of users and VLANs on the network fabric. MAC bridges and end users alike can take part in the registration and de-registration of GARP attributes such as VLAN and multicast group membership. For more details on how GVRP and GMRP handle frames under GARP, and how to configure the switch ports to take advantage of this operation, refer to the *SmartSwitch Series 6H202, 6H203, 6H252, 6H253, 6H258, 6H259, 6H262, 6E233, and 6E253 Local Management User's Guide*.

1.1.11 Flow Control

Flow Control is a method of managing the flow of frames between two devices. It ensures that a transmitting device does not overwhelm a receiving device with data. This enables the receiving device to communicate with the transmitting device, and to have it pause its transmission while the receiving device processes the frames already received. Both devices must support the IEEE 802.3x standard for flow control to work.

The SmartSwitches support the following two types of flow control:

- frame based 802.3x
- back pressure

Frame based 802.3x flow control is supported on all Ethernet ports operating in the full duplex mode. Flow control can be enabled or disabled on a port-by-port basis.

Back pressure flow control is supported on all Ethernet ports operating in the standard mode of operation. Flow control can be enabled or disabled on a port-by-port basis.

1.1.12 802.1 Port Priority

IEEE 802.1 port priority is incorporated in the IEEE 802.1D standard. It is used to assign a default priority to the frames received without priority information in their tag header, to map prioritized frames to the appropriate transmit queues, and to prioritize frames according to protocol type.

1.1.13 Management

Management of the SmartSwitch modules and 6C105 chassis is accomplished using the Local Management application or remote SNMP management stations. Local Management is accessible through the RS232 COM port on the front panel using a local VT100 terminal, or a remote VT100 terminal via a modem connection, and in-band via a Telnet connection. In-band remote management is possible through any SNMP compliant Network Management Software.

Local Management, as described in your *Local Management User's Guide*, provides the ability to manage the SmartSwitches and offers information for Ethernet HSIMs or VHSIMs. Local Management information for non-Ethernet HSIMs or VHSIMs is included in their respective user's guide. For details on how to get manuals, refer to the [Related Manuals](#) section in the [About This Guide](#) section.

1.1.14 Switching Options

The SmartSwitch modules provide 802.1Q switching or SecureFast Switching Virtual Network Services between all of the front panel interfaces including any optional HSIM and VHSIMs. In the 802.1Q mode (the default mode of operation), the switch functions as an 802.1D switch until 802.1Q VLANs are configured.

SecureFast switching and IEEE 802.1Q switching allow migration to Virtual Network technologies without requiring the replacement of existing equipment.

1.1.15 Distributed Chassis Management

From a management perspective, the 6C105 SmartSwitch 6000 chassis can be viewed as a single entity with a single IP address. Its systems management functions are distributed to all modules. The chassis can be managed using a single IP address, or the modules can be managed separately by individual IP addresses. When using a single IP address, system wide settings can be done from the chassis menu in Local Management, while module settings are done by selecting the specific module to be modified and changing the settings for that module.

1.1.16 Optional HSIMs and VHSIMs

The 6H253-13 provides a slot for an optional High Speed Interface Module (HSIM) or Very High Speed Interface Module (VHSIM) for additional connectivity to various networking technologies. Any exceptions to the HSIMs and VHSIMs that operate in the 6H253-13 are listed in the Release Notes shipped with the 6H253-13.

1.1.17 Standards Compatibility

The SmartSwitches are fully compliant with the IEEE 802.3, 802.3x, 802.3u, 802.1D, and especially 802.1Q standards. The SmartSwitches provide IEEE 802.1D Spanning Tree Algorithm (STA) support to enhance the overall reliability of the network and protect against “loop” conditions. The SmartSwitches support a wide variety of industry standard MIBs including RFC 1213 (MIB II), RFC 1757 (RMON), RFC 1493 (Bridge MIB), RFC 1354 (FIB MIB), and RFC 1190 (Path MTU Discovery). A full suite of Cabletron Systems Enterprise MIBs provide a wide array of statistical information to enhance troubleshooting.

For information about how to extract and compile individual MIBs, contact Cabletron Systems, refer to [Section 1.2](#).

1.1.18 LANVIEW Diagnostic LEDs

LANVIEW diagnostic LEDs serve as an important troubleshooting aid by providing an easy way to observe the status of individual ports and overall network operations.

1.1.19 Year 2000 Compliance

The SmartSwitch modules and 6C105 chassis have an internal clock that maintains the time and date beyond the year 1999.

1.2 GETTING HELP

For additional support related to this device or document, contact Cabletron Systems using one of the following methods:

| | |
|----------------|---|
| World Wide Web | http://www.cabletron.com/ |
| Phone | (603) 332-9400 |
| Internet mail | support@cabletron.com |
| FTP | ftp://ftp.cabletron.com/ |
| Login | <i>anonymous</i> |
| Password | <i>your email address</i> |

To send comments or suggestions concerning this document, contact the Cabletron Systems Technical Writing Department via the following email address: **TechWriting@cabletron.com**
Make sure to include the document Part Number in the email message.

Before calling Cabletron Systems, have the following information ready:

- Your Cabletron Systems service contract number
- A description of the failure
- A description of any action(s) already taken to resolve the problem (e.g., changing mode switches, rebooting the unit, etc.)
- The serial and revision numbers of all involved Cabletron Systems products in the network
- A description of your network environment (layout, cable type, etc.)
- Network load and frame size at the time of trouble (if known)
- The device history (i.e., have you returned the device before, is this a recurring problem, etc.)
- Any previous Return Material Authorization (RMA) numbers

Network Requirements

Before installing the SmartSwitch modules, review the requirements and specifications referred to in this chapter concerning the following:

- SmartTrunk (Section 2.1)
- 10BASE-T Twisted Pair Network (Section 2.2)
- 100BASE-TX Twisted Pair Network (Section 2.3)

The network installation must meet the guidelines in this chapter and in the documents referenced in this chapter to ensure satisfactory performance of the equipment. Failure to follow the guidelines may produce poor network performance.

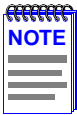

The Cabletron Systems *Cabling Guide*, referred to in the following sections, can be found on the Cabletron Systems World Wide Web site: <http://www.cabletron.com/>

2.1 SmartTrunk

To connect SmartSwitch modules to a network so they can take advantage of the SmartTrunk feature, there are certain rules concerning port connections and configurations that must be followed for proper operation. Refer to the Cabletron Systems *SmartTrunk User's Guide* for additional information.

2.2 10BASE-T NETWORK

When connecting a 10BASE-T segment to any of the SmartSwitch ports, ensure that the network meets the Ethernet network requirements of the IEEE 802.3 standard for 10BASE-T. Refer to the Cabletron Systems *Cabling Guide* for details.



If a port is to operate at 100 Mbps, Category 5 cabling must be used. For 10 Mbps operation only, Category 3 cabling can be used. Refer to Section 2.3 for information about 100BASE-TX networks and cabling.

2.3 100BASE-TX NETWORK

The fixed ports of the SmartSwitch provide an RJ21 connection that supports Category 5 UTP cabling. The device at the other end of the twisted pair segment must meet IEEE 802.3u 100BASE-TX Fast Ethernet network requirements for the devices to operate at 100 Mbps. Refer to the Cabletron Systems *Cabling Guide* for details.

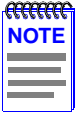

The fixed ports of the SmartSwitch support Category 5 UTP cabling with an impedance between 85 and 111 ohms for 10 and 100 Mbps operation.

SmartSwitch modules are capable of operating at either 10 or 100 Mbps. The SmartSwitch automatically senses the speed of the other device and adjusts its speed accordingly.



Only qualified personnel should install the SmartSwitch modules.

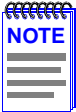

Read the Release Notes shipped with the device to check for any exceptions to the supported features and operation documented in this guide.

This chapter covers the following items:

- Unpacking the Module ([Section 3.1](#))
- Installing Options ([Section 3.2](#))
- Installing the Module into the 6C105 Chassis ([Section 3.3](#))
- Connecting to the Network ([Section 3.4](#))
- Completing the Installation ([Section 3.5](#))

3.1 UNPACKING THE MODULE

1. Open the box and remove the packing material protecting the module.
2. Verify the contents of the carton as listed in [Table 3-1](#).

Table 3-1 Contents of Shipping Container

| Item | Quantity |
|----------------------|----------|
| 6H203-24 or 6H253-13 | 1 |
| Manual Accessory Kit | 1 |

3.2 INSTALLING OPTIONS

If installing an optional HSIM or VHSIM, it must be installed in the 6H253-13 before proceeding to [Section 3.3](#). Complete instructions for installing an optional HSIM or VHSIM are available in the applicable HSIM or VHSIM User's Guide. For details on how to get manuals, refer to [Related Manuals](#) in the [About This Guide](#) preface. Refer to [Appendix B](#) for the HSIM or VHSIM connector locations.

3.3 INSTALLING THE MODULE INTO THE 6C105 CHASSIS



Failure to observe static safety precautions could cause damage to the SmartSwitches. Follow static safety handling rules and wear the antistatic wrist strap provided with the 6C105 chassis.

Do not cut the non-conductive bag to remove the module. Damage could result from sharp objects contacting the board or components.

The SmartSwitch modules can be installed in any of the 5 slots that are available. To install a module, refer to [Figure 3-1](#) and proceed as follows:

1. Remove the blank panel covering the slot in which the module will be installed. All other slots must remain covered to ensure proper airflow and cooling. (Save the blank plate in the event you need to remove the module.)
2. Carefully remove the module from the shipping box. (Save the box and packing materials in the event the module must be reshipped.)
3. Locate the antistatic wrist strap shipped with the 6C105 chassis. Attach the antistatic wrist strap to your wrist and plug the cable from the antistatic wrist strap into the ESD grounding receptacle at the upper right corner of the 6C105.
4. Remove the module from the plastic bag. (Save the bag in the event the module must be reshipped.) Observe all precautions to prevent damage from Electrostatic Discharge (ESD).

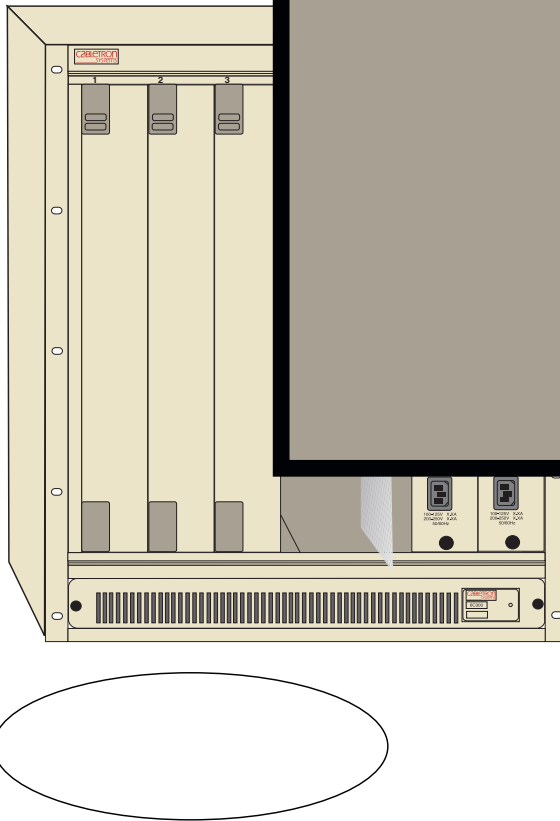

Figure 3-1 Installing an Interface Module

5. Examine the module for damage. If any damage exists, DO NOT install the module. Immediately contact Cabletron Systems. Refer to [Section 1.2](#) for details.



To prevent damaging the backplane connectors in the following step, take care that the module slides in straight and properly engages the backplane connectors.

Ensure that the top plastic locking tab lines up with the desired slot number located on the front panel of the chassis. Refer to [Figure 3-1](#).

6. Locate the slot guides that line up with the number of the slot in which the module will be installed. Install the module in the chassis by aligning the module circuit card between the upper and lower metal rail guides of the desired slot, sliding it into the chassis, and locking down the top and bottom plastic locking tabs, as shown in [Figure 3-1](#). Take care that the module slides in straight and properly engages the backplane connectors.
7. If the chassis in which the module is installed was powered down for the installation, turn it back on. Check to see that the CPU LED settles at solid green after a few minutes. If the LED does not turn solid green, see [Chapter 4](#) for details.

3.4 CONNECTING TO THE NETWORK

This section provides the procedures for connecting twisted pair segments from the network or other devices to the 6H203-24 or 6H253-13.



If the 6H203-24 or 6H253-13 is being installed in a network using SmartTrunking, there are rules concerning the network cable and port configurations that must be followed for SmartTrunking to operate properly. Before connecting the cables, refer to the Cabletron Systems *SmartTrunk User's Guide* for the configuration information.

3.4.1 Connecting Twisted Pair Cables to Fixed Ports

All fixed ports of the SmartSwitches are 10/100 ports with internal crossovers. When connecting a workstation, use a straight-through connection. When connecting networking devices, such as another bridge, repeater, or router, use a crossover connection.



All SmartSwitch front panel ports support Category 5 Unshielded Twisted Pair (UTP) cabling with an impedance between 85 and 111 ohms. Category 3 cable may be used if the connection is going to be used only for 10 Mbps.

Connect a twisted pair segment to the SmartSwitch as follows:

1. Ensure that the device connected to the other end of the segment is powered ON.
2. Connect the Twisted Pair segments to the 6H203-24 or 6H253-13 by connecting the RJ21 connector cable end to the RJ21 port as shown in [Figure 3-2](#). The connector with the cable on it must be connected to the premises wiring with the proper cross-over or straight-through connections as dictated by the device on the other side. All screws should be tightened on the RJ21s to prevent bad connections. Refer to the Cabletron Systems *Cabling Guide* for details.

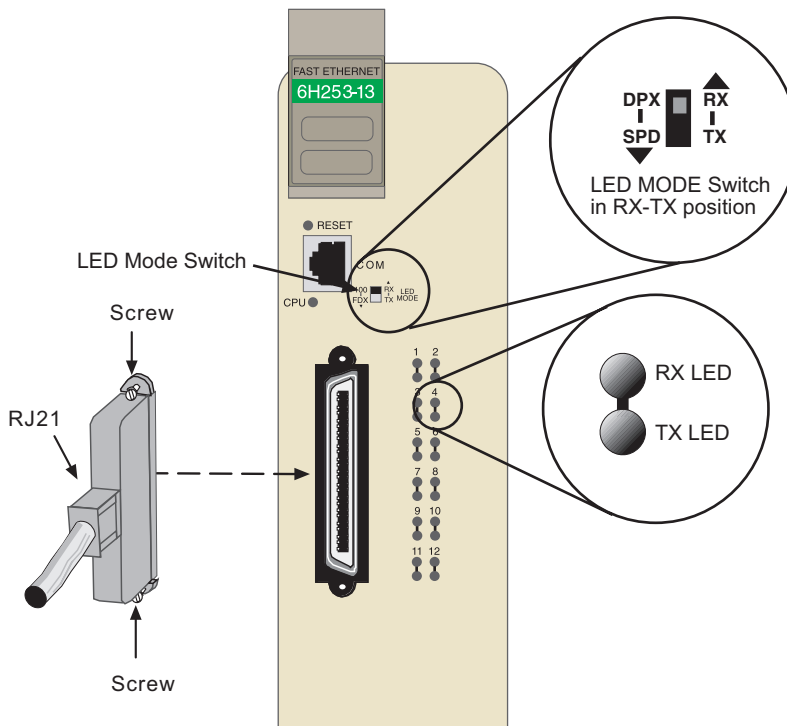

Figure 3-2 Connecting a Twisted Pair Segment to the SmartSwitch

3. Verify that a link exists by checking that the port **RX** (Receive) LED is ON (flashing amber, blinking green, or solid green). If the **RX** LED is OFF and the **TX** (Transmit) LED is not blinking amber, perform the following steps until it is on:
 - a. Verify that the LED mode switch located near the COM port of the module is in the UP position (RX and TX LED indicators).
 - b. Verify that the cabling being used is Category 5 UTP with an impedance between 85 and 111 ohms. If the port is to operate at 100 Mbps, category 5 cabling must be used.
 - c. Verify that the device at the other end of the twisted pair segment is on and properly connected to the segment.
 - d. Verify that the RJ21 connectors on the twisted pair segment have the proper pinouts (see the Cabletron Systems *Cabling Guide*) and check the cable for continuity. Typically, a crossover connection is used between a switching or hub device and an end user (computer). A straight-through connection is used between hub devices.

- e. Ensure that the twisted pair connection meets the dB loss and cable specifications outlined in the Cabletron Systems *Cabling Guide*. Refer to [Related Manuals](#) in the [About This Guide](#) preface for information on obtaining this document.

If a link is not established, contact Cabletron Systems for technical assistance. Refer to [Section 1.2](#) for details.

4. Repeat steps 1 through 3 above, until all connections have been made.

3.5 COMPLETING THE INSTALLATION

After installing the SmartSwitches and any optional HSIM or VHSIM, the module is now ready to be set up through Local Management. For information on the Local Management connection, configuring the 6C105 chassis and module, and using Network Tools, refer to the *Local Management User's Guide*.

Troubleshooting

This chapter provides information concerning the following:

- Using the LANVIEW diagnostic and status monitoring system (Section 4.1)
- Troubleshooting network and module operational problems (Section 4.2)
- Using the RESET button (Section 4.3)

4.1 USING LANVIEW

The SmartSwitch modules use Cabletron Systems' built-in visual diagnostic and status monitoring system called LANVIEW. The LANVIEW LEDs (Figure 4-1) allow quick observation of the network status to aid in diagnosing network problems. Refer to Table 4-1 for a description of the LEDs.

Refer to the *HSIM* or *VHSIM User's Guide* for a description of the HSIM or VHSIM LEDs.

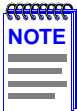

The terms **flashing**, **blinking**, and **solid** used in the LED definition tables of this chapter indicate the following:

Flashing indicates an irregular LED pulse.

Blinking indicates a steady LED pulse, (approximately 50% on, 50% off).

Solid indicates a steady LED light. No pulsing.

4.1.1 The LED Mode Switch

The SmartSwitches have an LED mode switch, located on the front panel, that allows the user to change the function of the LEDs. Refer to Figure 4-1 for the location of the LED mode switch. When the switch is in the UP position, the LEDs indicate the receive (RX) and transmit (TX) status of the fixed ports. When the mode switch is in the DOWN position, the LEDs indicate at what speed the applicable port is currently operating (10 Mbps or 100 Mbps) and if the applicable port is operating in standard or full duplex mode.



The LED mode switch does not change the function of any LEDs on an HSIM or VHSIM installed in the 6H253-13.

The default switch setting is the RX-TX (up) position.

Table 4-1 provides the definitions of the LED states that occur when the LED mode switch is in the UP position. **Table 4-2** provides the definitions of the LED states that occur when the LED mode switch is in the DOWN position.

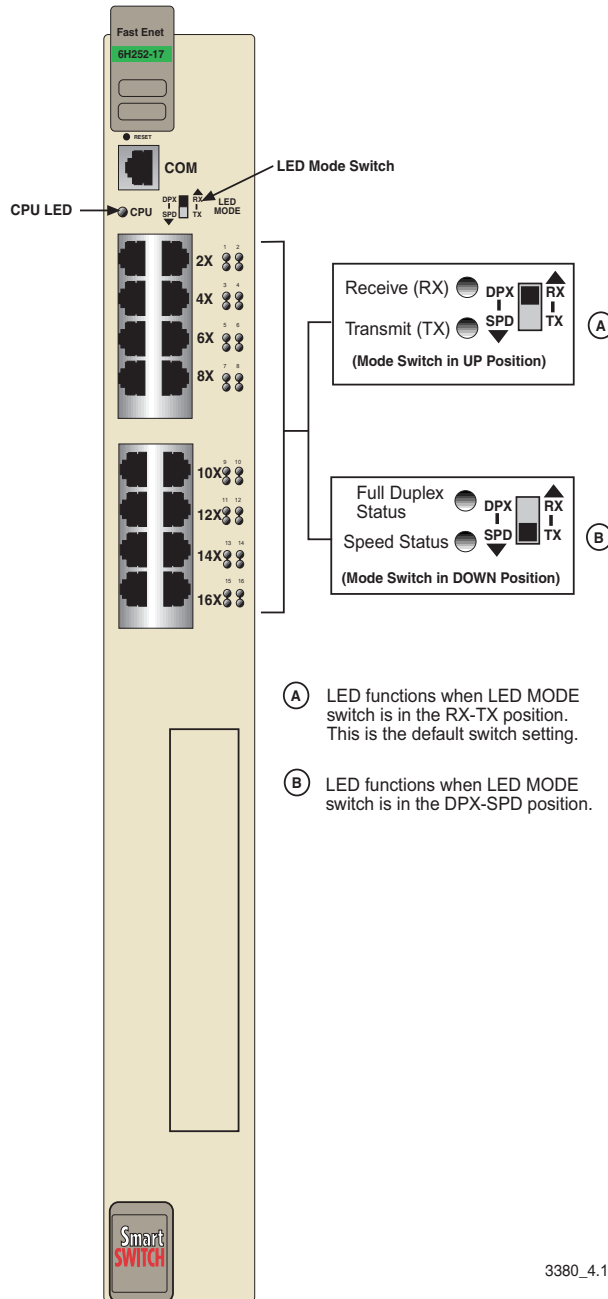

Figure 4-1 LANVIEW LEDs

3380_4.1

Table 4-1 LANVIEW LEDs CPU, Receive, and Transmit Status

| LED | Color | State | Recommended Action |
|-----------------|--|---|--|
| CPU | Off | Power off. | Power up chassis. |
| | Red | Blinking. Hardware failure has occurred. | Contact Cabletron Systems. |
| | | Solid. Resetting, normal power up reset. | If the LED remains red for several minutes, contact Cabletron Systems. |
| | Amber | Blinking. Crippled. | Contact Cabletron Systems. |
| | | Solid. Testing. | If the LED remains amber for several minutes, contact Cabletron Systems. |
| | Green | Solid. Functional. | None. |
| Amber and Green | Booting. Blinks amber and green while booting. | None. | |

The following port RX and TX LED indications are only valid when the LED MODE switch is in the RX-TX position.

| | | | |
|-----|---------------------|--|-------------------------|
| RX | Off | No link. No activity or port in Standby. Port enabled or disabled. | None. |
| | Green | Solid. Port enabled, link, no activity. | None. |
| | | Blinking. Port disabled, link. | Enable port if desired. |
| | Amber | Flashing. Port enabled, link, activity. | None. |
| Red | Diagnostic failure. | Contact Cabletron Systems. | |

Table 4-1 LANVIEW LEDs CPU, Receive, and Transmit Status (Continued)

| LED | Color | State | Recommended Action |
|-----|-------|--|--|
| TX | Off | Port enabled, and no activity. Should flash green every two seconds indicating BPDUs being sent if STA is enabled and there is a valid link. | <ol style="list-style-type: none"> 1. Ensure that the STA is enabled and that there is valid link. The <i>Local Management User's Guide</i> describes how to enable the STA. 2. Contact Cabletron Systems. |
| | Green | Flashing. Indicates activity. Rate indicates data rate. | None. |
| | Amber | Blinking. Port in standby. Port may be disabled due to Spanning Tree. | <ol style="list-style-type: none"> 1. Ensure that the port is not disabled. Refer to the <i>Local Management User's Guide</i> for information on enabling/disabling ports. 2. Contact Cabletron Systems. |
| | Red | Flashing. Indicates collision rate. Solid. Diagnostic Failure. | <p>None, unless there is a high rate of activity. If so, check for network configuration problems or a defective device.</p> <p>Contact Cabletron Systems.</p> |

Table 4-2 Speed and Full Duplex LED Indications

| LED | Color | Description |
|--|-------|--|
| The following port DPX and SPD LED indications are only valid when the LED MODE switch is in the DPX-SPD position. | | |
| DPX | Amber | Port is operating in standard mode (10 Mbps or 100 Mbps). |
| (Duplex Status) | Green | Port is operating in full duplex mode (20 Mbps or 200 Mbps). |
| SPD | Amber | There is a link and the port is operating at 10 Mbps. |
| (Speed Status) | Green | There is a link and the port is operating at 100 Mbps. |

4.2 TROUBLESHOOTING CHECKLIST

If the 6H203-24 or 6H253-13 are not working properly, refer to [Table 4-3](#) for a checklist of possible problems, causes, and recommended actions to resolve the problem.

Table 4-3 Fault Identification

| Symptom | Possible Causes |
|--|--|
| All LEDs off. | <ol style="list-style-type: none"> 1. Installation error - remove the module and perform installation in accordance with installation instructions. Check connectors for dust or dirt and clean as necessary. 2. Power system fault - refer to Table 4-4. |
| Module stays in BOOT state. | <ol style="list-style-type: none"> 1. Device does not have an operable firmware image, and is sending out BootP requests in an effort to locate a BootP server on the network. Press the RESET button on the front panel to attempt to use the firmware image in FLASH memory. 2. If the problem continues after pressing the RESET button, refer to Section B.1 for instructions on forcing a BootP image download. 3. Contact Cabletron Systems if the problem continues. |
| Cannot access Local Management. | <ol style="list-style-type: none"> 1. Firmware image fault - refer to Table 4-5. 2. Management system fault - refer to Table 4-6. |
| Cannot contact device through in-band management. | <ol style="list-style-type: none"> 1. Management system fault - refer to Table 4-6. 2. No link to device - verify all network connections between network management station and the module are valid and operating. |
| User parameters (IP address, community names, etc.) lost on reset or power-up. | Device setup fault - refer to Table 4-7 . |
| Device is not forwarding traffic from any port. | Device setup fault - refer to Table 4-7 . |

Table 4-4 Power System Troubleshooting

| Possible Causes | Instruction |
|-------------------------------------|---|
| Loss of Power to the 6C105 chassis. | <p>Perform the following steps:</p> <ol style="list-style-type: none"> 1. Check ON/OFF switches of 6C105 power supplies. All switches must be in the ON () position. 2. Check all power cords and cables for proper connection. Examine power cords for fraying or other damage. Replace if necessary. 3. Examine 6C105 chassis power supplies. If power supply LEDs or audible warnings (beep) indicate a power supply problem, refer to the following instructions: <ol style="list-style-type: none"> 2. If the power supply is not working, check the power supply voltage. 3. If the power supply is working, check the power supply connections. |

Table 4-5 Firmware Troubleshooting

| Possible Causes | Instruction |
|---------------------------------|---|
| Autobaud enabled. | Press ENTER (RETURN) (may take up to four times). |
| Terminal setup is not correct. | Refer to the <i>Local Management User's Guide</i> for the setup procedures. |
| Improper console cable pinouts. | Refer to co9(o9 TD 10(t Gur)9(open(r)-1(c)1o)11(nspTD 10rto9(o9ur)9npin)9 |

Table 4-6 Management System Troubleshooting

| Possible Causes | Instruction |
|--|--|
| Improper Community Names Table. | <ol style="list-style-type: none"> 1. Refer to the <i>Local Management User's Guide</i> for Community Names Table setup. 2. If the Community Names have been forgotten, refer to Section B.1 for instructions on clearing NVRAM. |
| The module does not have an IP address. | <ol style="list-style-type: none"> 1. Refer to your <i>Local Management User's Guide</i> for IP address assignment procedure. 2. If the module is using the IP address of the 6C105 chassis, ensure it is not in STANDALONE management mode. Your <i>Local Management User's Guide</i> provides instructions on setting the management mode. |
| The applicable front panel port is disabled. | <ol style="list-style-type: none"> 1. Enable port. Refer to the <i>Local Management User's Guide</i> for instructions on enabling/disabling ports. 2. Port may disabled due to Spanning Tree. Review network design and delete unnecessary loops. |

Table 4-7 Device Setup Troubleshooting

| Possible Causes | Instruction |
|--|---|
| The module detects a looped condition. | <ol style="list-style-type: none"> 1. Verify that Spanning Tree is enabled. Refer to the <i>Local Management User's Guide</i> for instructions on setting the type of STA. 2. Review network design and delete unnecessary loops. |
| Mode switch (7), NVRAM Reset, was changed sometime before either cycling power or pressing the RESET button, causing the user-entered parameters to reset to factory default settings. | <ol style="list-style-type: none"> 1. Reenter the lost parameters as necessary. Refer to your <i>Local Management User's Guide</i> for instructions on configuring the device through Local Management. 2. Call Cabletron Systems if the problem continues. |
| Clear NVRAM was set through Local Management. | <ol style="list-style-type: none"> 1. Reenter the lost parameters as necessary. Refer to the <i>Local Management User's Guide</i> for instructions on configuring the device through Local Management. 2. Call Cabletron Systems if the problem continues. |

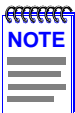

If these troubleshooting tables do not solve any problems that occur with the 6H203-24 or 6H253-13, contact Cabletron Systems. Refer to [Section 1.2](#), for details.

4.3 USING THE RESET BUTTON

The RESET button located near the upper plastic locking tab of the module (refer to [Figure 4-2](#)) resets the processor without affecting the NVRAM.



Pressing the RESET button resets the device, and all current switching being performed by the module is halted. A module downtime of up to two minutes results from this action.

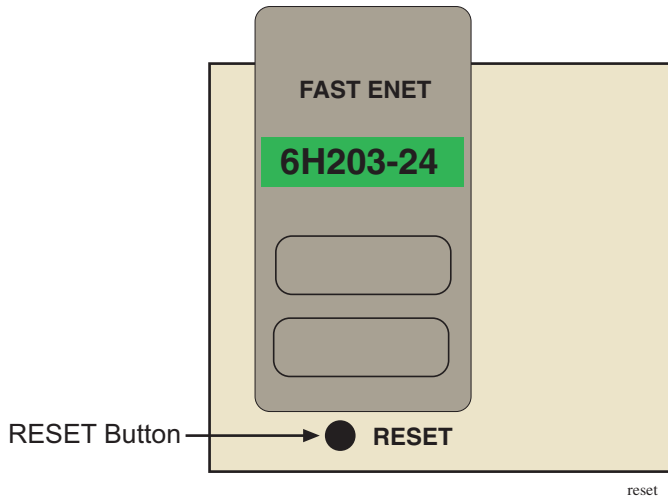

Figure 4-2 RESET Button

To reset the processor, press and release the RESET button. To push the button, use a pen or similar non-conductive tool, as the button is recessed behind the metal plate of the front panel. The module processor goes through a reset process of approximately 60 seconds. Additional downtime may be added as the module reenters the network.



It is not recommended to press the RESET button while the module is already in reset mode. The module will enter an extended diagnostic procedure, which is unnecessary for normal operation. This procedure will take much longer than a minute. The ESC key can be used to exit the procedure.

Specifications

This appendix provides operating specifications for the Cabletron Systems SmartSwitch Interface Modules. Cabletron Systems reserves the right to change these specifications at any time without notice.

A.1 MODULE SPECIFICATIONS

| | |
|---|--|
| Processors: | Intel i960 RISC processor control Power PC |
| Dynamic Random Access Memory (DRAM): | 20 MB (expandable to 32 MB) |
| FLASH Memory: | 8 MB |
| Shared Memory: | 4 MB |

A.2 PHYSICAL PROPERTIES

| | |
|-------------------|--|
| Dimensions: | 46.43 H x 6.05 W x 29.51 D (cm) 18.28 H x 2.38 W x 11.62 D (in) |
| Weight (Unit): | 2.72 kg (6 lb) |
| MTBF (Predicted): | 200,000 hours |

A.3 ENVIRONMENTAL REQUIREMENTS

| | |
|------------------------------|--------------------------------|
| Operating Temperature: | 5°C to 40°C (41°F to 104°F) |
| Storage Temperature: | -30°C to 73°C (-22°F to 164°F) |
| Operating Relative Humidity: | 5% to 90% (non-condensing) |

A.4 INPUT/OUTPUT PORTS

6H253-13 Specifications

Ports 1 through 12: Fast Ethernet 10/100 Mbps (100BASE-TX compliant) with one RJ21 connector.

Slot for optional High Speed Interface Module (HSIM) or Very High Speed Interface Module (VHSIM): Slot accepts optional HSIMs or VHSIMs that provide a variety of physical cabling types.

6H203-24 Specifications

Ports 1 through 24: Fast Ethernet 10/100 Mbps (100BASE-TX compliant) with two RJ21 connectors.

A.5 COM PORT PINOUT ASSIGNMENTS

The COM port is a serial communications port that supports Local Management or connection to a UPS.

Table A-1 shows the COM port pin assignments:

Table A-1 COM Port Pin Assignments

| Pin | Signal Name | Input/Output |
|-----|---------------------------|--------------|
| 1 | Transmit Data (XMT) | Output |
| 2 | Data Carrier Detect (DCD) | Output |
| 3 | Data Set Ready (DSR) | Input |
| 4 | Receive Data (RCV) | Input |
| 5 | Signal Ground (GND) | NA |
| 6 | Data Terminal Ready (DTR) | Output |
| 7 | Request to Send (RTS) | Input |
| 8 | Clear to Send (CTS) | NA |

A.6 REGULATORY COMPLIANCE

This equipment meets the following safety and electromagnetic compatibility (EMC) requirements:

| | |
|---|--|
| Safety: | UL 1950, CSA C22.2 No 950, 73/23/EEC, EN 60950, IEC 950 |
| Electromagnetic Compatibility (EMC): | FCC Part 15, CSA C108.8, 89/336/EEC, EN 55022, EN 61000-3-2, EN 61000-3-3, EN 50082-1, AS/NZS 3548, VCCI V-3 |

Switch Settings, Upgrades, and Installations

This appendix covers the following items:

- Setting the mode switches (Section B.1)
- Installing the DRAM SIMM (Section B.2)
- Location for installing HSIMs or VHSIMs (Section B.3)



You need an antistatic wrist strap (provided with 6C105 chassis) to perform the procedures in this appendix. Use the antistatic wrist strap when performing any of the procedures in this appendix to minimize ESD damage to the devices involved.

B.1 SETTING THE MODE SWITCHES



Read the appropriate sections to be fully aware of the consequences when changing switch settings.

Only qualified personnel should change switch settings.

These switches are set at the factory and do not need to be changed unless you intend to perform the following:

- Force download a new image file from a BootP server.
- Clear NVRAM and restore all user-entered parameters, such as the IP address and Subnet Masks, to the SmartSwitch “Default” configuration settings.
- Clear user-entered passwords stored in NVRAM and restore the default passwords.

Figure B-1 shows the location of the mode switches and the switch settings for normal operation.

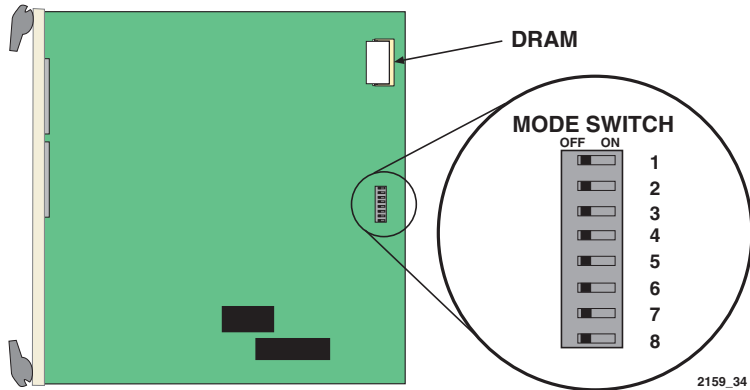

Figure B-1 Module Mode Switch Location/Component Layout

Switch definitions and positions are as follows:

- Switches 1 through 4 – For Cabletron Systems use only.
- Switch 5 – COM Port Autobaud. The default (OFF) position enables Autobaud sensing on the COM port for Local Management sessions. Changing the switch to the ON position disables Autobaud sensing and sets the COM port to 9600 baud for Local Management sessions.
- Switch 6 – Forced BootP. Changing the position of this switch (i.e., moving the switch from one position to the other) clears download information from NVRAM and forces the SmartSwitch to download a new image file from a BootP server after power to the chassis is restored.



After changing the position of switch 6, DO NOT reapply power to the chassis until there is a station acting as a BootP server, which contains the image file.

- After changing the position of switch 6 and restarting the module, the module requests a new image download until they either receive a new image or the RESET button on the front panel is pressed. When the RESET button is pressed, the module continues trying to contact a BootP server, but will time out in approximately one minute. If the module times out, the image is downloaded from its FLASH memory.
- Switch 7 – Clear NVRAM. Changing the position of this switch resets NVRAM on the next power up. ALL user entered parameters, such as IP addresses, subnet masks, SNMP traps, and switching functions are restored to their factory default settings.

- Switch 8 – Reset Password/Community Strings. Changing the position of this switch clears only the user-entered passwords stored in NVRAM, and restores the default passwords. Once the module is reset, the passwords can either be reentered or the default passwords (Public and ENTER) may be used.



Do not change the position of switch 8 unless it is necessary to reset the module super-user configured passwords to their factory default settings.

B.2 SIMM UPGRADE

Memory upgrade is available for the SmartSwitch modules to expand the DRAM to 32 MB. This section explains how to locate and add/replace a Single In-line Memory Module (SIMM). For information on the available SIMM upgrades, contact Cabletron Systems. For details on getting help, refer to [Section 1.2](#).

B.2.1 Locating SIMMs

Figure B-2 shows the location of the DRAM SIMM connector.

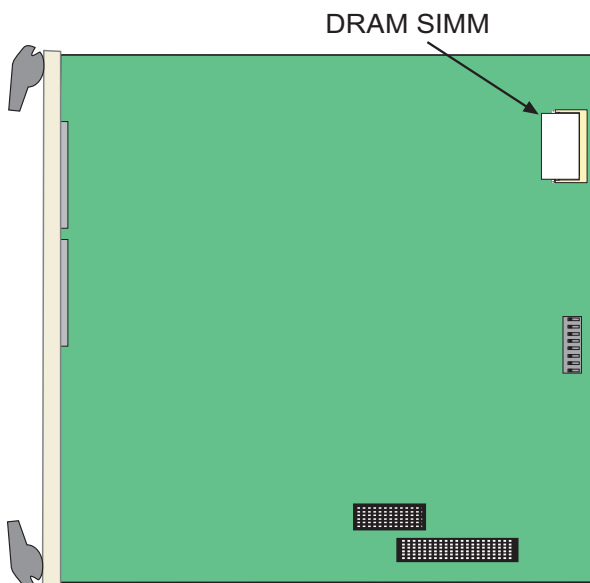

Figure B-2 SIMM Slot Locations

B.2.2 Installing the DRAM SIMM



Observe all antistatic precautions when handling sensitive electronic equipment.

To install a DRAM SIMM, refer to [Figure B-3](#) and proceed as follows:

1. With the SIMM alignment notch oriented as shown in [Figure B-3](#), insert the SIMM down between the connector teeth.
2. Pivot the SIMM downward so the connector clips align with the two side notches of the SIMM and the connector clips lock the SIMM into place.

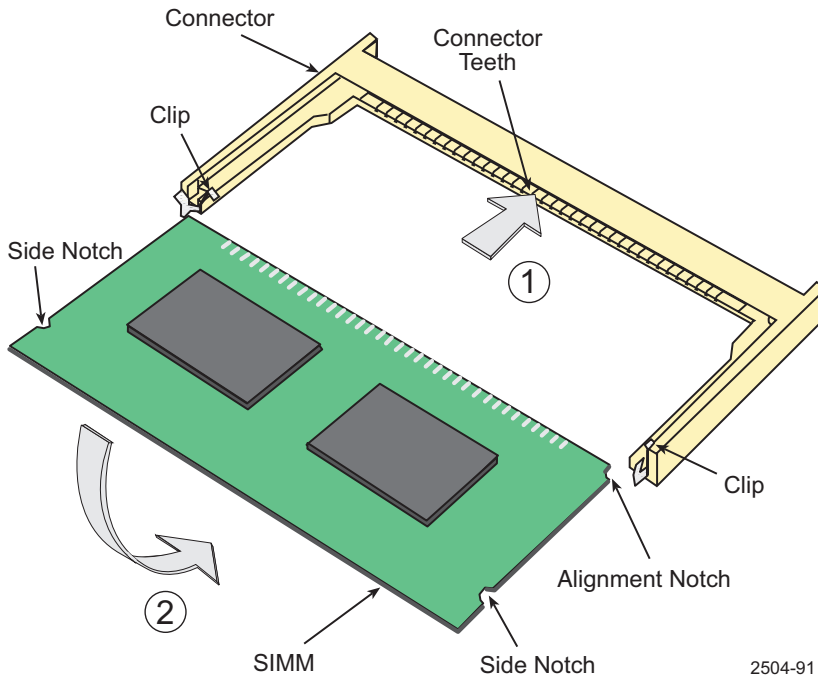
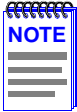

Figure B-3 Installing the DRAM

B.3 INSTALLING OPTIONAL HIGH SPEED INTERFACE MODULES

Figure B-4 shows the location of the two connectors for an optional High HSIM or VHSIM. Depending on if an HSIM or VHSIM is installed, one or both connectors are used.



Refer to the installation instructions for the optional HSIM or VHSIM in the associated user's guide.

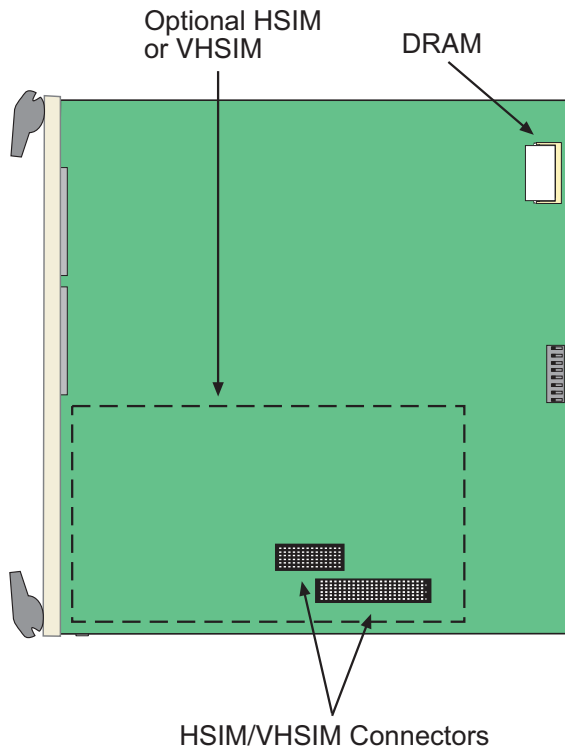

Figure B-4 HSIM and VHSIM Connector Locations

Numerics

100BASE-TX requirements 2-2
10BASE-T
 connection 3-4
 requirements 2-1

A

Auto-Negotiation 1-3

C

Cable specifications
 100BASE-TX network 2-2
 10BASE-T network 2-1
COM port
 pin assignments A-2
Connecting to the network 3-4

D

Distributed Chassis Management 1-8
Document Conventions xviii

E

Environmental requirements A-1

H

Help
 related manuals xvii

I

Installation
 connecting to the Network 3-4
 High Speed Interface Module B-5
 Module 3-1
 Very High Speed Interface Module B-5

L

LANVIEW LEDs 4-1
LDRAM
 installation B-4
Local Management
 introduction 1-7

M

Memory upgrading B-3
Mode Switch Bank Settings B-1

N

NVRAM
 clearing B-2

P

Physical properties A-1
Port Redirect Function, introduction to 1-5

R

Redirect functions
 port and VLAN, introduction to 1-5
Regulatory Compliance A-3
Related Manuals xvii
RESET button 4-11
Runtime IP Address Discovery 1-3

S

Safety A-2
SDRAM
 installation B-4
SIMMs
 installing
 LDRAM B-4
 location B-3

SmartTrunk, introduction 1-4
Specifications A-1
Standards compatibility 1-8

T

Troubleshooting 4-1
 checklist 4-6

U

Unpacking 3-1

V

VLAN Redirect Function, introduction to 1-5

Free Manuals Download Website

<http://myh66.com>

<http://usermanuals.us>

<http://www.somanuals.com>

<http://www.4manuals.cc>

<http://www.manual-lib.com>

<http://www.404manual.com>

<http://www.luxmanual.com>

<http://aubethermostatmanual.com>

Golf course search by state

<http://golfingnear.com>

Email search by domain

<http://emailbydomain.com>

Auto manuals search

<http://auto.somanuals.com>

TV manuals search

<http://tv.somanuals.com>