

# SPEEDLITE 380EX



# Thank you for purchasing a Canon product.

The Canon Speedlite 380EX is a Canon EOS-dedicated autofocus zoom flash unit featuring the newly-developed E-TTL (Evaluative-Through-The-Lens) auto flash control system. It also has two new features: FP (Focal-Plane) flash and FE (Flash Exposure) lock. FP flash enables the Speedlite to synchronize with all shutter speeds (high-speed sync) while FE lock locks the flash exposure reading for a specific area. These new features are available when Speedlite 380EX is coupled to a Type-A camera (see below).

Other features include auto flash-exposure compensation, auto flash exposure with a manually-set shutter speed and aperture, second-curtain synchronization, and multiple-flash compatibility.

When used with a Type-B camera, Speedlite 380EX operates as a TTL autofocus zoom flash unit.

The features available with Speedlite 380EX differ depending on the camera it is used with. Refer to the table below to check your camera type.

This Instructions booklet has separate sections for Type-A and Type-B cameras. Read the sections which apply to your camera.

Type-A Camera	E-TTL	EOS 50 EOS 50E EOS ELAN II EOS ELAN IIE
Type-B Camera	TTL	EOS 650 EOS 620 EOS 750 EOS 850 EOS 630 EOS-1 EOS RT EOS 10 EOS 10S EOS 700 EOS 1000 EOS REBEL EOS 100 EOS ELAN EOS 1000N EOS REBEL II EOS 1000FN EOS REBEL SII EOS 5 EOS A2 EOS A2E EOS 500 EOS REBEL X EOS 5000 EOS 888 EOS-1N EOS-1N RS

## Available Features with EOS Cameras

O: Available X: Not available.

Speedlite Feature	With Type-A Cameras	With Type-B Cameras
E-TTL auto flash control	O	x*
FP flash	O	x
FE lock	O	x
Second-curtain sync	O	x
Fill flash	O	O
Slow-speed sync	O	O
Bounce flash	O	O
Multiple flash	O*	O
Flash exposure compensation	O	O**

\* TTL auto flash control operates instead.

\*\* Available only with the EOS-1N, EOS-1N RS, EOS A2/A2E.

---

## Canon Speedlite 380EX Features

### 1 E-TTL auto flash control

When Speedlite 380EX is used with a Type-A camera, E-TTL auto flash control takes over. Unlike the A-TTL and TTL auto flash systems which use a multiple-zone flash metering sensor to read the flash exposure, the E-TTL auto flash system uses normal evaluative metering with the camera's metering sensor and controls the flash exposure automatically.

The E-TTL auto flash system thereby controls the flash exposure with higher precision and boosts the performance of the AIM (Advanced Integrated Multi-point) system (which links the metering and flash exposure to the focusing point).

The E-TTL auto flash system controls the exposure of the main subject as well as the background for a balanced exposure. It combines automatic exposure control for ambient light and flash exposure control for both fill flash and low-light conditions.

### 2 FP flash (high-speed sync)

When Speedlite 380EX is used with a Type-A camera, it can synchronize with all shutter speeds.

FP flash is effective when you want to use fill flash for an outdoor portrait while creating background blur with a large aperture. Or, when you want to produce a catchlight in the subject's eyes in daylight.

### 3 FE lock

When Speedlite 380EX is used with a Type-A camera, you can lock the correct flash exposure reading for any portion of the picture.

### 4 Flash exposure confirmation

The flash confirmation lamp on the back of the Speedlite lights for 2 sec. after the flash fires if the flash exposure was sufficient. It therefore gives you immediate feedback on proper flash exposure.

### 5 Auto zoom

The flash head zooms automatically for optimum flash coverage for lens focal lengths ranging from 24mm to 105mm.

### 6 Bounce flash

The flash head can tilt upward up to 90° to bounce the flash.

### 7 Auto power off

If the Speedlite has been turned on and it is not used for about 90 sec., it turns off automatically to conserve battery power. To turn on the Speedlite again, press the shutter button or the Speedlite's test firing button.

## 8 Speedlite accessories for creative lighting

Off-Camera Shoe Cord 2 connects the Speedlite off the camera while retaining E-TTL auto flash control. Accessories are also available to set up multiple-flash systems maintaining auto flash exposure control.

## Speedlite Care

- 1 Speedlite 380EX contains high-voltage circuitry. Never attempt to disassemble the Speedlite. For any repairs, take the Speedlite to a Canon Service Center.
- 2 Do not get the Speedlite wet. If it is exposed to rain or snow, wipe immediately with a dry cloth.
- 3 When the Speedlite is not to be used for an extended period, remove the batteries.
- 4 Avoid putting the Speedlite where it may be exposed to high temperatures. High temperatures may cause the Speedlite to malfunction.

### Symbols used in this Instructions:



:Warning for preventing camera malfunction or damage.



:Information you should know when operating the Speedlite 380EX.



:Helpful tip for using the Speedlite 380EX and taking pictures.

# Contents

- If you have a Type-A camera, read pages 2~28 and 36~46.
- If you have a Type-B camera, read pages 2~16 and 29~46.

	Quick Start Guide .....	6
	Nomenclature .....	8
<b>I. Before You Start</b>	1. Installing the Batteries .....	10
	2. Mounting the Speedlite .....	12
	3. Power Switch .....	13
	4. FP Flash Switch .....	13
	5. Pilot Lamp and Test Firing .....	14
	6. Flash Exposure Confirmation .....	14
	7. Flash Coverage .....	15
	8. AF-Assist Beam .....	16
	9. Shutter Button Operation .....	16
<b>II. Speedlite 380EX with Type-A Cameras</b>	1. Fully-Automatic Flash Operation .....	17
	Fill Flash .....	19
	2. Flash with Other Modes .....	20
	(1) Flash with Aperture-Priority AE .....	21
	(2) Flash with Shutter Speed-Priority AE .....	22
	(3) Flash with Manual Exposure .....	23
	3. Using Special Features .....	24
	(1) FP flash .....	24
	(2) FE Lock .....	26
	(3) Second-Curtain Synchronization .....	28
<b>III. Speedlite 380EX with Type-B Cameras</b>	1. Fully-Automatic Flash Operation .....	29
	Fill-in Flash .....	31
	2. Flash with Other Modes .....	32
	(1) Flash with Aperture-Priority AE .....	33
	(2) Flash with Shutter Speed-Priority AE .....	34
	(3) Flash with Manual Exposure .....	35
<b>IV. Other Applications</b>	1. Slow-Speed Sync .....	36
	2. Bounce Flash .....	38
	3. Flash Exposure Compensation .....	39
	4. Multiple Flash .....	39
	Troubleshooting Guide .....	42
	Specifications .....	43
	Speedlite 380EX Feature Availability .....	46

## Quick Start Guide

Before following this Guide, attach Speedlite 380EX to the camera and turn on the camera and Speedlite.

- \* The asterisked features are available only with Type-A cameras. For more details, see the specified pages.

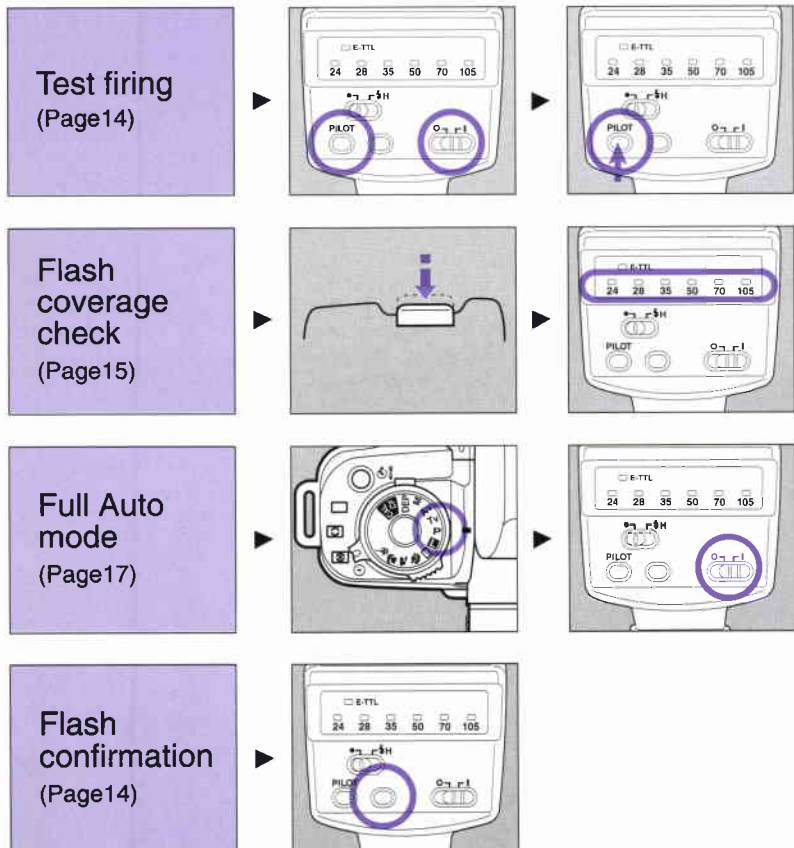

\*  
FP flash  
(Page24)

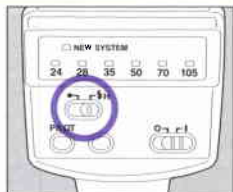
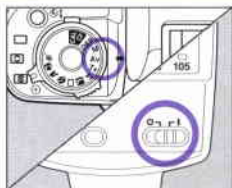

\*  
FE lock  
(Page26)

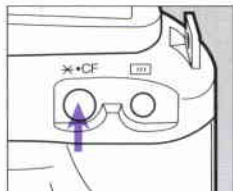

\*  
Second-curtain sync  
(Page28)

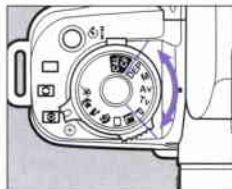

Slow-speed sync  
(Page36)

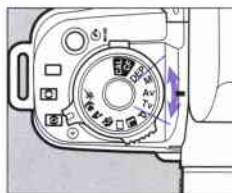

Bounce flash  
(Page38)

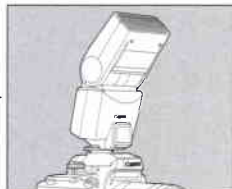

# Nomenclature

---

## • Front

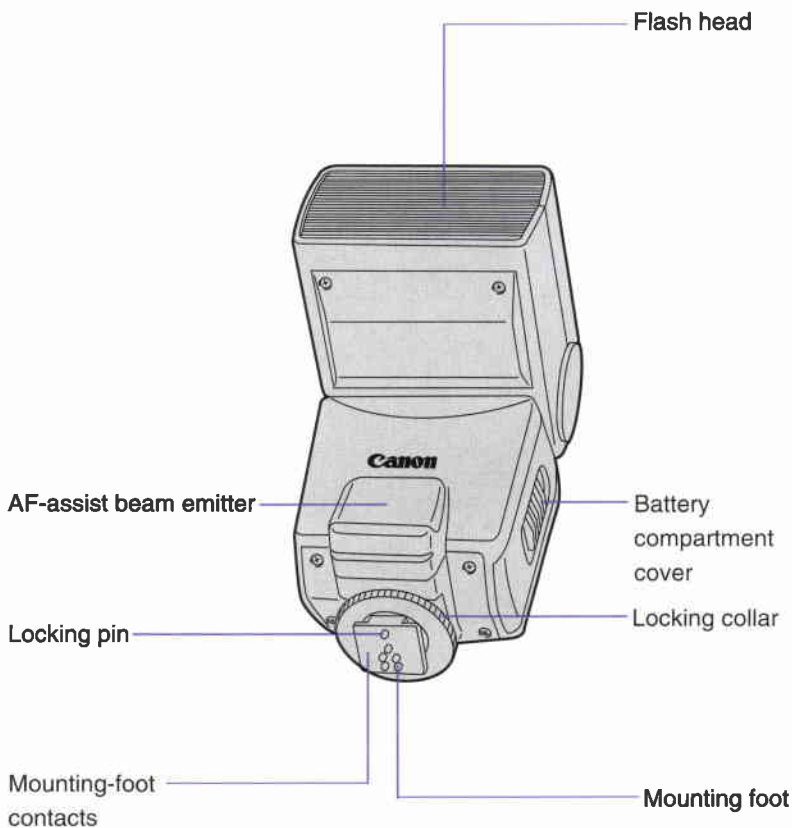



• Rear

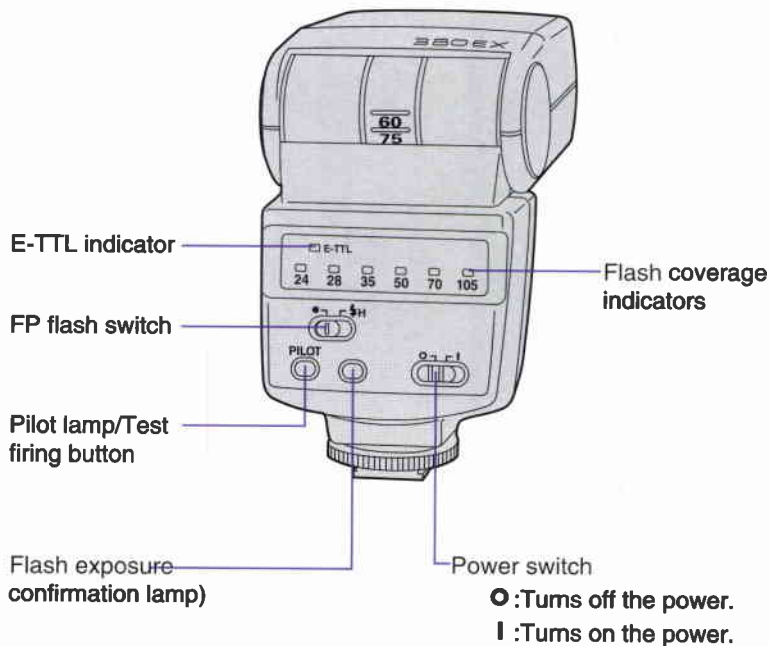

# I. Before You Start

## 1. Installing the Batteries

Install one of the following types of batteries:

- (1) Four size-AA alkaline batteries (LR6 or AM-3)
- (2) Four size-AA NiCd batteries (KR15 or KR51)

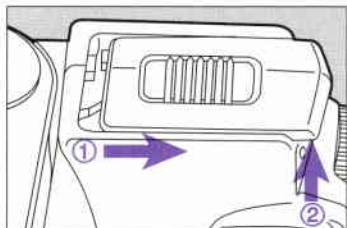

- 1** Slide the battery compartment cover as shown by the arrow and flip it up.

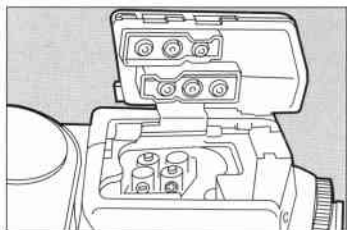

- 2** Insert the batteries with the contacts oriented as shown in the battery compartment. Use four new batteries of the same type.

- To prevent faulty connections, make sure the battery contacts are clean.

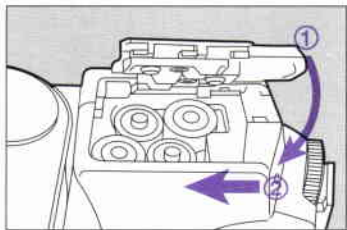

- 3** Close the battery compartment cover as shown in the figure.

# I. Before You Start



## Battery Cautions

- When replacing batteries, replace all four batteries at one time.
- Although ordinary, non-alkaline batteries (R6 or UM3) may be used, the number of flashes will be less.
- The contacts of NiCd batteries are not standardized. If you want to use NiCd batteries, make sure the battery contacts touch the battery compartment's contacts securely.
- When you will not use the Speedlite for an extended period, remove the batteries.
- In low temperatures, take two sets of fully-charged NiCd batteries and keep one set warm in a pocket, etc., and use the batteries alternately.
- Speedlite 380EX cannot be used with an external power source.

## Battery Life and Recycling Time

Battery Type	No. of Flashes	Recycling Time
Size-AA alkaline batteries (LR6 or AM-3)	260 to 1800	0.1 to 7.5 sec.
Size-AA NiCd batteries (KR15 or KR51)	75 to 500	0.1 to 4.5 sec.

- The above figures are based on Canon's Standard Test Method with a new set of batteries.

## 2. Mounting the Speedlite

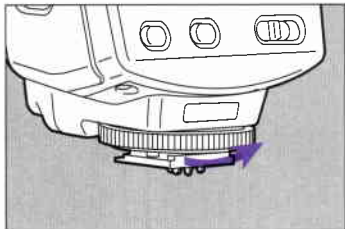

- 1 Loosen the locking collar by turning it as shown by the arrow.

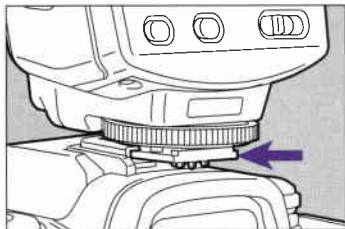

- 2 Slip the Speedlite's mounting foot on the camera's hot shoe until it stops.

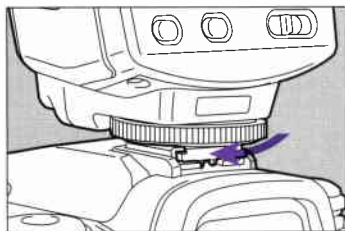

- 3 Turn the locking collar as shown by the arrow and tighten. (The mounting foot's locking pin extends into the hot shoe.)

- To detach the Speedlite, turn the locking collar in the opposite direction until it stops. (The locking pin retracts into the mounting foot.)



Although the hot shoe on the EOS 650, EOS 620, EOS 750, and EOS 850 does not have a locking pin hole, Speedlite 380EX can still be mounted on these cameras.

### 3. Power Switch

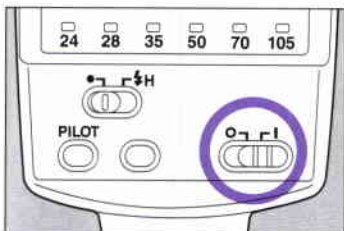

Set the power switch as follows:

- : To turn off the power.
- ⚡ : To turn on the power. If the Speedlite is left unused for about 90 sec., it turns off automatically to save battery power. To turn on the Speedlite again, press the shutter button or press the test firing button.

### 4. FP Flash Switch

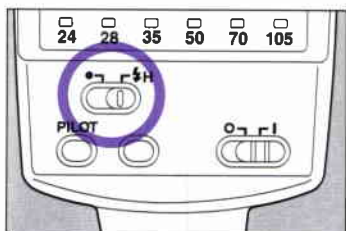

Use this switch to set high-speed sync.

- : For normal sync.
- ⚡ : For high-speed sync.

- When Speedlite 380EX is used with a Type-A camera and the switch is set for high-speed sync, using a shutter speed faster than the camera's maximum sync speed sets the high-speed sync mode and using a shutter speed slower than the maximum sync speed sets the normal sync mode.
- When a Type-B camera is used, normal sync mode is set regardless of this switch's setting.

## 5. Pilot Lamp and Test Firing

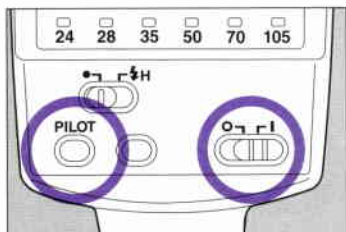

- 1 Set the power switch to I.
  - The Speedlite starts to recharge. When recharging is completed, the pilot lamp lights.

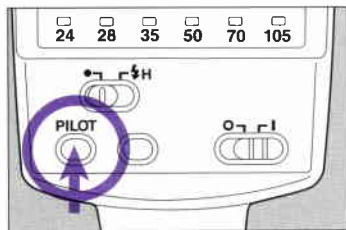

- 2 After the pilot lamp lights, press it to test fire the flash. (The pilot lamp is also a test firing button.)



The flash cannot be test fired while the exposure setting is displayed during the halfway pressing of the shutter button and the four seconds after the shutter button is released.

## 6. Flash Exposure Confirmation

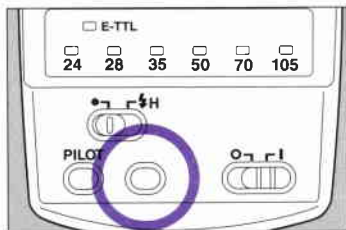

The flash confirmation lamp lights for 2 sec. after the flash fires if the correct flash exposure has been obtained. If the flash confirmation lamp does not light after the flash fires, the picture may have been underexposed. Move closer to the subject and try again.

## 7. Flash Coverage

Speedlite 380EX's flash head zooms automatically to provide adequate flash coverage for the lens focal length in use. Flash coverage is provided for 24mm to 105mm focal lengths. The corresponding flash coverage indicator on the Speedlite lights.

When a zoom lens is used, the Speedlite adjusts the flash coverage automatically whenever the lens is zoomed. The corresponding flash coverage indicator lights.

- When the flash coverage changes, the Speedlite's Guide No. also changes. See "Guide No." on page 44 to see how the Guide No. changes.
- If a lens wider than 24mm is used, the light will falloff at the picture's periphery.
- Using any lens longer than 100mm lights the 105 flash coverage indicator.

- 1 Turn on the camera.
- 2 Turn on Speedlite 380EX.
- 3 Press the shutter button halfway. The flash coverage indicator corresponding to the lens focal length lights.

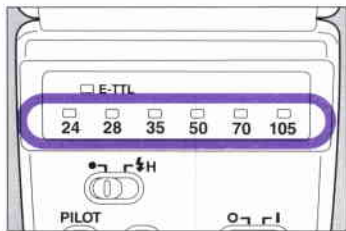

## 8. AF-Assist Beam

If where you focus lacks sufficient light or contrast, the Speedlite's AF-assist beam is emitted automatically to help the camera autofocus. The AF-assist beam is effective from 0.7 to 10 meters (2.3 to 33 feet).

### AF-assist beam activation

Depending on the camera and the active focusing point, either the camera's AF-assist beam or the Speedlite's AF-assist beam is emitted. Speedlite 380EX's AF-assist beam is linkable only to the center focusing point. If the camera has only one focusing point (AF frame), the Speedlite's AF-assist beam is emitted. If the camera has multiple focusing points, the camera's AF-assist beam is emitted instead. With the EOS 50, EOS 50E, EOS ELAN II, EOS ELAN II E and EOS-1N, Speedlite 380EX's AF-assist beam is emitted if the center focusing point is active. See page 46.

## 9. Shutter Button Operation

The EOS camera's shutter button operates in two steps: Press it halfway or all the way.

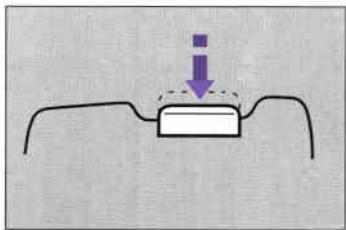

### When it is pressed halfway:

- 1) Autofocus is activated to focus the subject.
- 2) The exposure setting (shutter speed and aperture) is also set at the same time.

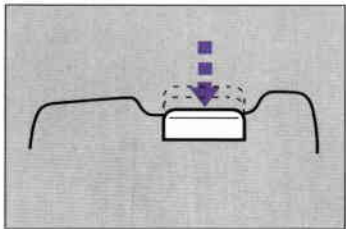

### When it is pressed completely:

- 1) The shutter is released to take the picture and then the film advances to the next frame.



## II. Speedlite 380EX with Type-A Cameras

With a Type-A camera, you can use Speedlite 380EX's E-TTL auto flash system. The E-TTL auto flash system uses the camera's focusing point-linked, evaluative metering sensor to meter the flash exposure. Flash exposure control is more precise, resulting in a balanced exposure for both the subject and background in fill-flash or low-light conditions. Automatic exposure control and flash exposure control are therefore combined. FP flash and FE lock can also be easily set.

### 1. Fully-Automatic Flash Operation

For fully-automatic flash operation, attach Speedlite 380EX to a Type-A camera and set the camera to Program AE (P) or Full Auto (□). The E-TTL auto flash system then sets the camera's sync speed and aperture automatically. This mode makes flash photography easy and automatic for low-light and fill-flash conditions.

#### (1) Fully-Automatic Flash Operation

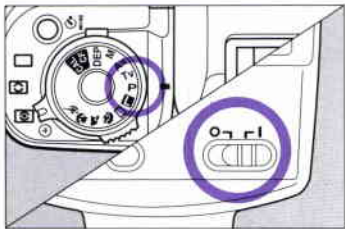

- 1 Set the camera to Program AE (P) or Full Auto (□).
  - If a Programmed Image Control mode is set, the Full Auto mode takes effect.
- 2 Turn on the Speedlite's power switch.

## II. Speedlite 380EX with Type-A Cameras

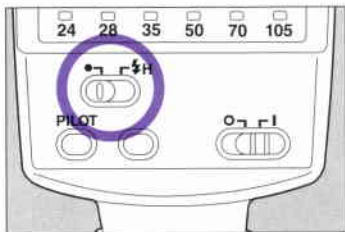

**3** Slide the FP flash switch to the green dot (normal sync).



**4** Aim the active focusing point on the subject and press the shutter button halfway.

- Focus is achieved and the shutter speed and aperture setting are displayed in the viewfinder and on the LCD panel.
- The sync speed is set automatically anywhere from 1/60 sec. to the camera's maximum sync speed (this varies depending on the camera). The aperture is also set automatically.



**5** Check that **⚡** and the shutter speed and aperture setting are displayed in the viewfinder, then press the shutter button completely to take the picture.



- Immediately before the shutter is released, the Speedlite fires a test preflash. After obtaining a flash exposure reading with the preflash, the Speedlite fires the main flash accordingly to obtain the correct flash exposure.



- The test preflash is fired to obtain a flash exposure reading which is used to calculate the output of the main flash for a correct flash exposure.
- The main flash is fired when the shutter is released.

### Fill Flash

Even in daylight, you can use flash as fill light for harsh shadows or dark, backlit portrait subjects.



With fill flash.



Without fill flash.



When a fully-automatic picture-taking mode is used with Speedlite 380EX, the fill flash output may be reduced automatically to balance the exposure between the subject and background. This is called auto flash output reduction.

## 2. Flash with Other Modes

The E-TTL auto flash system can also be used with a Type-A camera set to **Av** (aperture-priority AE), **Tv** (shutter speed-priority AE), or **M** (manual). Set the FP flash switch to the green dot (normal sync).

- When you press the shutter button halfway, the shutter speed and aperture setting are displayed as in any AE mode.

### Shutter Speed and Aperture Setting According to Mode

Mode	Shutter Speed	Flash Aperture
Full Auto and Programmed Image Control	Automatically set (1/60-1/X sec.)	Automatically set
<b>P</b>	Automatically set (1/60-1/X sec.)	Automatically set
<b>Av</b>	Automatically set (30-1/X sec.)	Manually set
<b>Tv</b>	Manually set (30-1/X sec.)	Automatically set
<b>M</b>	Manually set (buLb-1/X sec.)	Manually set

- Manually set: Set by the user. Automatically set: Set by the camera.
- 1/X sec.: Camera's maximum sync speed (see page 46).
- When you press the shutter button completely, the Speedlite fires a test preflash immediately before the shutter is released. The flash exposure reading obtained with the preflash is used to calculate the optimum output of the main flash.
- The exposure for the background is set with the shutter speed and aperture.



If flash is used in the DEP (Depth-of-field AE) mode, it will be the same as using flash in the Program AE mode.

## (1) Flash with Aperture-Priority AE

When you want to control the depth of field or when you want the background correctly exposed, use aperture-priority AE. You set the aperture and the camera sets the shutter speed automatically to suit the background's light level. The E-TTL auto flash system controls the flash output according to the aperture you set.

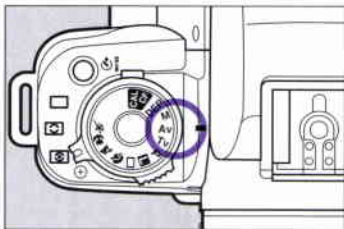

- 1 Set the camera to **Av** (aperture-priority AE) and set the desired aperture.

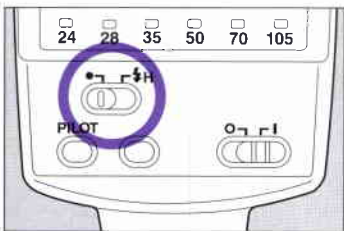

- 2 Check that the FP flash switch is set to the green dot.
- 3 Press the shutter button halfway to focus the subject.
- 4 Check that nothing is blinking in the viewfinder and press the shutter button completely to take the picture.



In low-light conditions, a slow sync speed is set automatically. A tripod is recommended for slow sync speeds.



If the maximum sync speed blinks, the background will be overexposed. If the 30" sync speed blinks, the background will be underexposed. Change the aperture setting until the sync speed stops blinking and stays on.

### (2) Flash with Shutter Speed-Priority AE

When you want to create a certain effect with the shutter speed, use shutter speed-priority AE. In this mode, you set the sync speed anywhere from 30 sec. to the camera's maximum sync speed. The camera then sets the aperture automatically to obtain the correct background exposure. The E-TTL auto flash system controls the flash output according to the aperture set automatically by the camera.

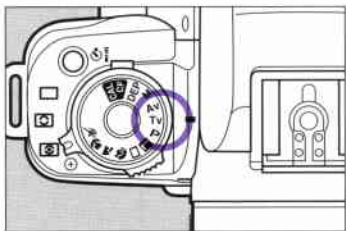

- 1 Set the camera to **Tv** (shutter speed-priority AE) and set the sync speed anywhere from 30 sec. to the camera's max. sync speed.

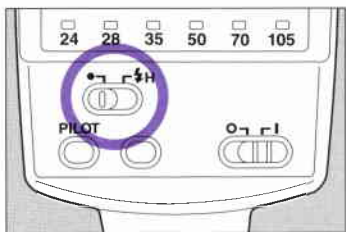

- 2 Check that the FP flash switch is set to the green dot (normal sync).



- 3 Press the shutter button halfway to focus the subject.
- 4 Check that nothing is blinking in the viewfinder and press the shutter button completely to take the picture.



If the aperture setting blinks, the background will be overexposed or underexposed. Change the sync speed until the aperture setting stops blinking and stays on.

### (3) Flash with Manual Exposure

When you want to set both the sync speed and the aperture, use manual exposure. The E-TTL auto flash system controls the flash output according to the aperture you set.

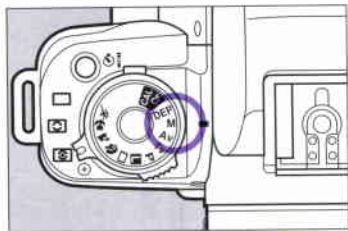

- 1 Set the camera to **M** (manual exposure) and set the desired aperture and sync speed anywhere from bulb to the camera's maximum sync speed.

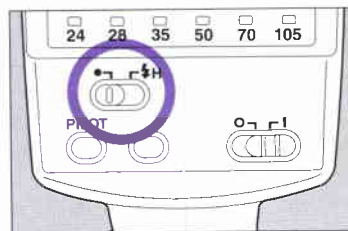

- 2 Check that the FP flash switch is set to the green dot (normal sync).



- 3 Press the shutter button halfway to focus the subject.
- 4 Check the information in the viewfinder and press the shutter button completely to take the picture.

## 3. Using Special Features

With a Type-A camera, Speedlite 380EX enables FP flash and FE lock.

### (1) FP flash

FP (focal-plane) flash, or high-speed sync, enables the Speedlite to synchronize with a shutter speed faster than the camera's maximum sync speed.

When a sync speed faster than the camera's maximum sync speed is set, Speedlite 380EX automatically sets the high-speed sync mode for auto flash exposure.

FP flash can be used in the **P**, **Tv**, **Av**, **M**, and **DEP** modes. It is effective when you want to use fill flash for an outdoor portrait while blurring the background with a large aperture. It can also be used to produce a catchlight in the subject's eyes or to eliminate harsh shadows. The result is best with a fast (large-aperture) lens.

- If a large aperture is to be used, set the camera to the **Tv**, **Av**, or **M** mode.

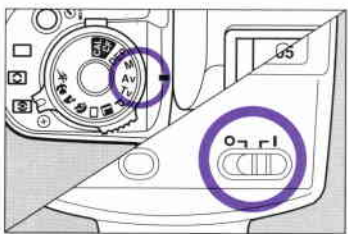

- 1 Set the desired picture-taking mode.

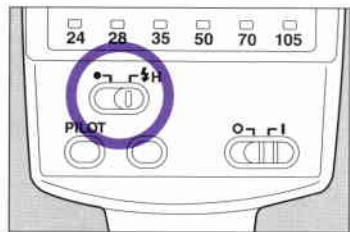

- 2 Slide the Speedlite 380EX's FP flash switch to **H** (high-speed sync).

- 3 Press the shutter button halfway to focus the subject.



## II. Speedlite 380EX with Type-A Cameras

- 4 Check that nothing is blinking in the viewfinder and press the shutter button completely to take the picture.

- When high-speed sync has been set,  is displayed in the viewfinder.



Taken with FP flash at 1/3000 sec., f/2.0  
(EF 100mm f/2.0 lens).



Taken with normal flash at 1/125 sec., f/9.5  
(EF 100mm f/2.0 lens).



The Speedlite's Guide No. changes according to the high-speed sync. The Speedlite's flash range decreases with FP flash.

### High-Speed Sync Guide No. Table

Shutter speed	Coverage angle(mm)					
	24	28	35	50	70	105
1/180	11.2	12.3	15.0	16.6	17.6	20.3
1/250	10.0	11.0	13.3	14.8	15.7	18.1
1/350	8.7	9.6	11.6	12.9	13.7	15.8
1/500	7.3	8.0	9.8	10.8	11.5	13.3
1/750	6.2	6.8	8.2	9.1	9.7	11.2
1/1000	5.2	5.7	6.9	7.7	8.2	9.4
1/1500	4.4	4.8	5.8	6.4	6.9	7.9
1/2000	3.7	4.0	4.9	5.4	5.8	6.6
1/3000	3.1	3.4	4.1	4.6	4.8	5.6
1/4000	2.6	2.8	3.5	3.8	4.1	4.7

The effective range of FP flash is 0.7 to 11.9 meters / 2.3 to 39.3 feet (at 1/180 sec. with EF 50mm f/1.4 lens).



The Guide No. can be calculated with the following formula: Camera-to-subject distance x correct aperture value = Guide No.  
Download from [www.Somanuals.com](http://www.Somanuals.com). All Manuals Search And Download.

### (2) FE Lock

When used with a Type-A camera, Speedlite 380EX enables FE (flash exposure) lock. The camera's AE lock button functions as an FE lock button. Use FE lock to obtain and lock the correct flash exposure reading for any portion of the picture. You can then recompose the shot while retaining the flash exposure reading.

- 1 Set the camera to a Creative Zone mode (**P**, **Tv**, **Av**, **M**, or **DEP**).
- 2 Press the shutter button halfway to focus the subject. Keep pressing the shutter button halfway even after focus is achieved.
- 3 Aim the focusing point where you want to obtain the correct flash exposure reading, then press the FE lock button .

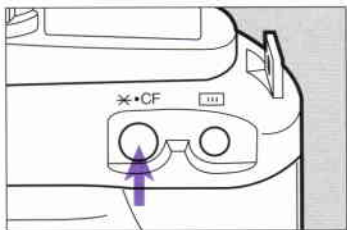

- Speedlite 380EX fires a preflash to calculate the required flash exposure which is then locked until 16 sec. after the FE lock button is released.
- In the viewfinder, the FE lock symbol (FEL) is displayed for about 0.5 sec, and the correct flash exposure setting is locked.
- The focusing point linked to the FE lock flashes in red.



- Using FE lock may not make any difference for a small subject.
- If the EOS 50, EOS 50E, EOS ELAN II and EOS ELAN II E Custom Function No. C04 (AF activation method and AE lock button operation) is set to 1 or 2, FE lock cannot be used.

## II. Speedlite 380EX with Type-A Cameras



- If the subject is too far away for FE lock to be set, blinks. Move nearer to the subject and repeat steps 2 and 3.

- 4 Compose the picture.
  - 5 Within 16 sec. after releasing the FE lock button, check the display in the viewfinder, recompose if necessary, then take the picture..
- Each time you press the FE lock button, a preflash is fired to obtain the correct flash exposure reading which is then locked for 16 sec.
  - The FE lock is canceled 16 sec, after the FE lock symbol ( ) is displayed or when the Command Dial is turned.

With a Type-A camera, the FE lock links to the focusing point as follows:

Focusing Point Selection Method		FE Lock-Linked Focusing Point
Automatic		Center
Manual	With Custom Function C08 set to 0.	Center
	With Custom Function C08 set to 1.	User-selected
Eye-controlled	With Custom Function C08 set to 0.	Center
	With Custom Function C08 set to 1.	User-selected*



\* With Eye-Controlled Autofocus, if you press the FE lock button while pressing the shutter button halfway, FE lock links to the selected focusing point. Also, if you press the FE lock button before focus is achieved or without pressing the shutter button, FE lock links to the center focusing point. Within 16 sec. after pressing the FE lock button, you can turn the Quick Control Dial for exposure compensation. In this way, you can control the exposure for the background.

### (3) Second-Curtain Synchronization

If your Type-A camera has a Custom Function for setting second-curtain synchronization, you can fire the flash right before the exposure ends (when the second shutter curtain closes). Normally, first-curtain synchronization is set so that the flash is fired at the start of the exposure (when the first shutter curtain opens). With second-curtain synchronization and a slow shutter speed, you can capture a moving subject sharply and leave a blurred streak behind the subject. This is more natural than when first-curtain synchronization is used.

\* To set the camera's Custom Function, refer to the camera's Instructions.



Taken with second-curtain synchronization.



Taken with first-curtain synchronization.



- If the camera is set to the Full Auto (□) mode or a Programmed Image Control mode, second-curtain synchronization cannot be used.
- To obtain second-curtain synchronization effects, set the camera to the Tv, Av, or M mode and use a slow shutter speed.
- Setting bulb for the sync speed makes second-curtain synchronization shots easier.

aperture, and multiple-flash capability. Just press the shutter button for easy and automatic flash photography.

## 1. Fully-Automatic Flash Operation

For fully-automatic flash operation, attach Speedlite 380EX to a Type-B camera and set the camera to Program AE (P) or Full Auto (□). The TTL auto flash system then sets the camera's sync speed and aperture automatically. This mode makes flash photography easy and automatic for low-light and fill-flash conditions.

### Fully-Automatic Flash Operation

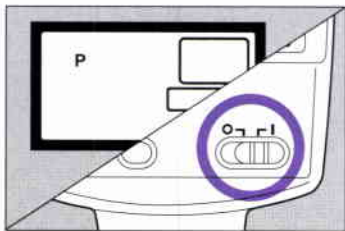

- 1 Set the camera to Program AE (P) or Full Auto (□).
- 2 Turn on the Speedlite's power switch.

### III. Speedlite 380EX with Type-B Cameras



**3** Aim the active focusing point on the subject and press the shutter button halfway.

- Focus is achieved and the shutter speed and aperture setting are displayed in the viewfinder and on the LCD panel.
- The sync speed is set automatically anywhere from 1/60 sec. to the camera's maximum sync speed (this varies depending on the camera). In the case of EOS Rebel-series cameras, the sync speed is set to 1/90 sec. in the Program or Full Auto mode). The aperture is also set automatically. (See page 46)



**4** Check that  $\text{⚡}$  and the shutter speed and aperture setting are displayed in the viewfinder, then press the shutter button completely to take the picture.



If the Speedlite is used with a Programmed Image Control mode, it will be the same as using the Speedlite in the Program AE mode.

## Fill-in Flash

Even in daylight, you can use flash as fill light for harsh shadows or dark, backlit portrait subjects.



With fill flash.



Without fill flash.



When a fully-automatic, picture-taking mode is used with Speedlite 380EX, the fill flash output may be reduced automatically to balance the exposure between the subject and background. This is called auto flash output reduction.

## 2. Flash with Other Modes

The TTL auto flash system can also be used with a Type-B camera set to **Av** (aperture-priority AE), **Tv** (shutter speed-priority AE), or **M** (manual).

- When you press the shutter button halfway, the shutter speed and aperture setting are displayed as in any AE mode.

### Shutter Speed and Aperture Setting According to Mode

Mode	Shutter Speed	Flash Aperture
<b>P</b>	Automatically set (1/60-1/X sec.)	Automatically set
<b>Av</b>	Automatically set (30-1/X sec.)	Manually set
<b>Tv</b>	Manually set (30-1/X sec.)	Automatically set
<b>M</b>	Manually set (buLb-1/X sec.)	Manually set

- Manually set: Set by the user. Automatically set: Set by the camera.
- 1/X sec.: Camera's maximum sync speed (see page 46).
- When you press the shutter button completely, the Speedlite fires. The flash output is controlled by the TTL auto flash system (the flash is metered off-the-film and cut-off automatically when the correct exposure is attained) according to the set aperture.
- The exposure for the background is set with the shutter speed and aperture.



- When the 380EX is used with a Type-B EOS camera, the FP flash switch does not function.
- Using the 380EX in the depth-of-field AE mode obtains the same result as using it in the Program AE mode.



## (1) Flash with Aperture-Priority AE

When you want to control the depth of field or when you want the background correctly exposed, use aperture-priority AE. You set the aperture and the camera sets the shutter speed automatically to suit the background's light level. The TTL auto flash system controls the flash output according to the aperture you set.

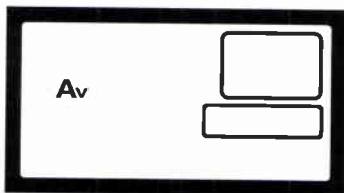

- 1 Set the camera to **Av** (aperture-priority AE) and set the desired aperture.



- 2 Press the shutter button halfway to focus the subject.
- 3 Check that nothing is blinking in the viewfinder and press the shutter button completely to take the picture.



In low-light conditions, a slow sync speed is set automatically. A tripod is recommended for slow sync speeds.



If the maximum sync speed blinks, the background will be overexposed. If the 30" sync speed blinks, the background will be underexposed. Change the aperture setting until the sync speed stops blinking and stays on.

## (2) Flash with Shutter Speed-Priority AE

When you want to create a certain effect with the shutter speed, use shutter speed-priority AE. In this mode, you set the sync speed anywhere from 30 sec. to the camera's maximum sync speed. The camera then sets the aperture automatically to obtain the correct background exposure. The TTL auto flash system controls the flash output according to the aperture set automatically by the camera.

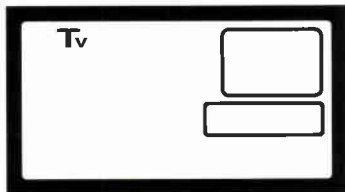

- 1 Set the camera to **Tv** (shutter speed-priority AE) and set the sync speed anywhere from 30 sec. to the camera's max. sync speed.
- 2 Press the shutter button halfway to focus the subject.
- 3 Check that nothing is blinking in the viewfinder and press the shutter button completely to take the picture.



If the aperture setting blinks, the background will be overexposed or underexposed. Change the sync speed until the aperture setting stops blinking and stays on.

## (3) Flash with Manual Exposure

When you want to set both the sync speed and the aperture, use manual exposure. The TTL auto flash system controls the flash output according to the aperture you set.

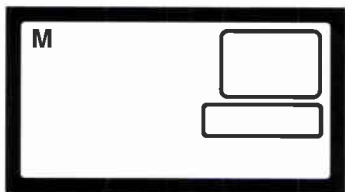

- 1 Set the camera to **M** (manual exposure) and set the desired aperture and sync speed anywhere from 30 sec. to the camera's maximum sync speed.

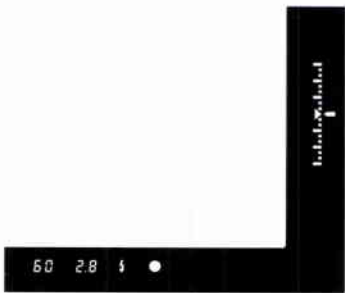

- 2 Press the shutter button halfway to focus the subject.
- 3 Check the information in the viewfinder and press the shutter button completely to take the picture.

## 1. Slow-Speed Sync

Slow-speed sync is a slow shutter speed you use with flash. By using a slow shutter speed, you can expose the background correctly while the flash exposes the subject correctly. You can use slow-speed sync in the picture-taking modes below.



Taken with a slow sync speed.



Taken with a normal sync speed.



When using slow-speed sync, use a tripod.

### (1) **Av** (Aperture-priority AE) Automatic Slow-Speed Sync

1. Set the camera to **Av** and set the aperture.
2. Focus the subject.
3. Check that nothing is blinking in the viewfinder and take the picture.
  - With a Type-A camera, the flash exposure is automatically controlled by the E-TTL auto flash system. With a Type-B camera, the flash exposure is automatically controlled by the TTL auto flash system.

### (2) Tv (Shutter speed-priority AE) Slow-speed sync

1. Set the camera to **Tv**.
2. Focus the subject.
3. Set the shutter speed so that a correct exposure\* will be obtained.
4. Check that nothing is blinking in the viewfinder and take the picture.

### (3) M (Manual exposure) Slow-speed sync

1. Set the camera to **M**.
2. Focus the subject and compose the shot.
3. To obtain the correct background exposure,\* set the shutter speed and aperture so that the exposure level indicator is at the center of the exposure level scale in the viewfinder. If your camera viewfinder has - and + symbols instead, set the shutter speed and aperture until both symbols light.
4. Check the information in the viewfinder and take the picture.

#### \* Balancing the exposure between the subject and background

- In shutter speed-priority AE mode  
Use a slower shutter speed until the aperture value stops blinking.
- In manual exposure mode  
Set the shutter speed and aperture so that the exposure level indicator is at the center of the scale.

## 2. Bounce Flash

When the flash is aimed directly at a portrait subject, a harsh shadow may appear behind the subject. By bouncing the flash off the ceiling, etc., you can reduce or eliminate the shadow and produce a softer light.

- The flash head has click stops at 0°, 60°, 75°, and 90° angles for tilting.



Taken with bounced flash.



Taken with direct flash.

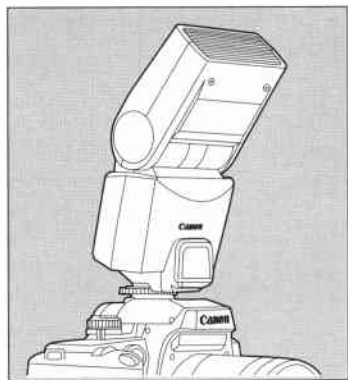

- 1 Tilt the flash head toward the ceiling or other reflective surface.
- 2 Turn on the Speedlite 380EX's power switch.
- 3 Focus the subject.
- 4 Check that nothing is blinking in the viewfinder and take the picture.



- The reflective surface should be a solid whitish color. If the reflective surface is patterned or not white, the result will be affected accordingly.
- When the flash head is tilted up, the zoom position is set automatically to 50mm.
- When the flash head is tilted for bounce flash, the flash coverage is set automatically to 50mm.

### 3. Flash Exposure Compensation

If you have an EOS-1N, EOS-1N RS, EOS 50, EOS 50E, EOS ELAN II, EOS ELAN II E, or EOS A2/A2E, you can set flash-exposure compensation with Speedlite 380EX. Refer to your camera's Instructions to set flash-exposure compensation.

### 4. Multiple Flash

By using multiple Speedlites, you can attain various lighting effects such as giving the portrait subject a more natural and sculptural look.

By connecting multiple Speedlites with multiple-flash accessories, you can use the TTL auto flash system for easy and automatic flash exposure. You need not make any troublesome exposure calculations. You can connect up to four Canon Speedlites. Besides Speedlite 380EX, you can connect Speedlite 480EG, any EZ-series Speedlite, and Macro Ring Lite ML-3.

#### Sample Multiple-Flash Connections

- 1 Use multiple-flash accessories to connect Canon Speedlites.
- 2 Before taking the picture, make sure the pilot lamp of all the connected Speedlites are lit.

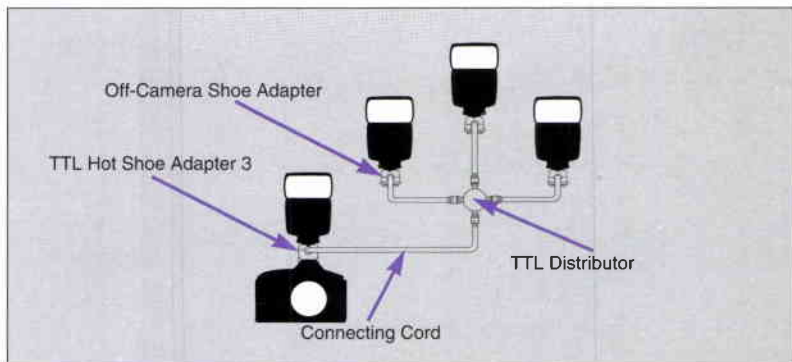

## IV. Other Applications

### Sample Multiple-Flash Setup

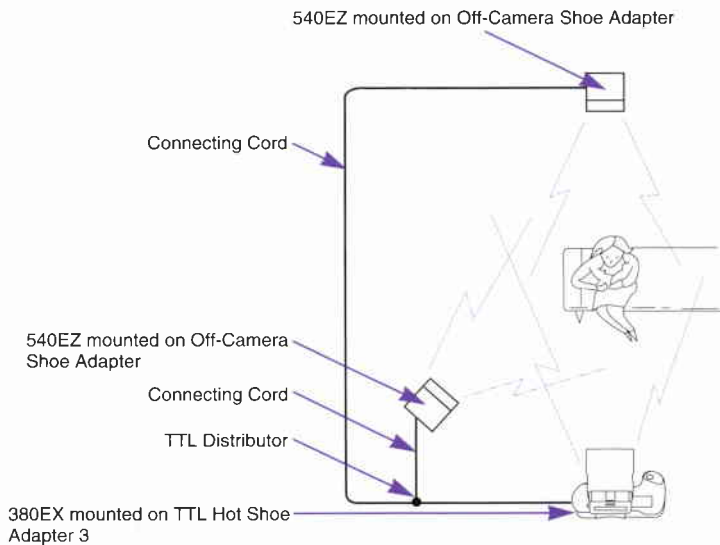

- If the batteries in TTL Hot Shoe Adapter 3 are almost exhausted, the Speedlite's pilot lamp may not light and the flash may not fire. Make sure the batteries in TTL Hot Shoe Adapter 3 have sufficient power.
- The Connecting Cord can be extended up to 9 meters / 30ft by connecting three Connecting Cord 300's (3 meters / 10ft each).



## Speedlite 380EX Accessories

### ① Off-Camera Shoe Cord 2

This cord enables you to use the Speedlite up to 60 cm/1.98ft away from the camera. All of the camera's automatic functions are left intact.

## Multiple-Flash Accessories

### ② Off-Camera Shoe Adapter

This adapter has a hot shoe, a Connecting Cord socket, and a tripod socket. Mount a Speedlite on the hot shoe, connect a Connecting Cord to the Connecting Cord socket, and mount the adapter on a tripod. The Connecting Cord's other end can be connected to a TTL Hot Shoe Adapter 3 or TTL Distributor.

### ③ TTL Distributor

With four Connecting Cord sockets, the TTL Distributor relays exposure information from the TTL Hot Shoe Adapter 3 to up to three Speedlites via Connecting Cords.

### ④ TTL Hot Shoe Adapter 3

Equipped with a hot shoe and a Connecting Cord socket, this adapter is mounted on the camera's hot shoe. A Speedlite is then mounted on the adapter's hot shoe and a Connecting Cord is connected to the socket. By connecting the other end of the Connecting Cord to an Off-Camera Shoe Adapter or a TTL Distributor, you can connect more Speedlites to the camera.

### ⑤ Connecting Cord 60 and Connecting Cord 300

Available in two lengths (60 cm and 3 meters), the Connecting Cords are used to wire a multiple-flash setup.

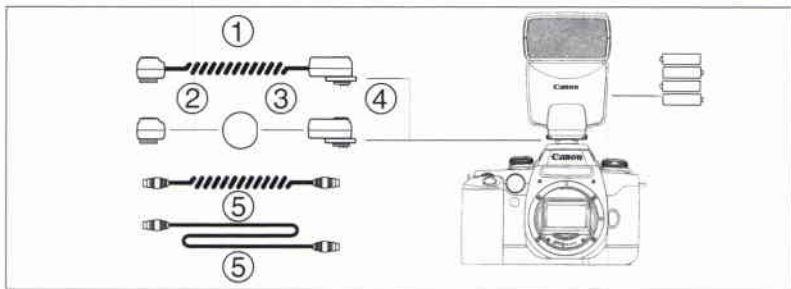

When a multi-flash accessory is attached to Speedlite 380EX, the TTL auto flash exposure mode takes effect.

# Troubleshooting Guide

No.	Problem	Probable Cause	Solution	Page No.
1	The Speedlite cannot be detached from the camera.	The locking collar has not been loosened enough to retract the locking pin.	Loosen the locking collar completely to retract the locking pin.	12
2	The flash does not fire even when the shutter button is pressed.	The Speedlite has not been mounted properly on the hot shoe.	Mount the Speedlite properly and securely on the camera.	12
		The hot shoe contacts are dirty. The Speedlite's mounting foot contacts are dirty.	If the contacts are dirty, use a clean cloth to wipe them.	12
3	After turning on the Speedlite, the pilot lamp turns off after a while.	If the Speedlite is not used for 90 sec., the power turns off automatically.	Press the shutter button or press the test firing button.	13
4	When high-speed sync was used with the EOS 50, EOS 50E, EOS ELAN II, EOS ELAN II E, the picture was underexposed.	With high-speed sync, the Guide No. changes depending on the sync speed. A faster sync speed reduces the flash range. If the subject is beyond the flash range, underexposure results.	Set the shutter speed so that the desired flash range is attained.	25
5	The subject looks blurred in the picture.	If flash is used with aperture-priority AE in low-light conditions, a slow sync speed is set automatically. A blurred picture is prone to occur if the camera is handheld at a slow shutter speed.	Use a tripod.	36

# Specifications

Type	Direct-sync, shoe-mount flash with E-TTL auto flash control (E-TTL test preflash, AF-assist beam, auto zoom head, and bounce capability).
Compatible cameras	Type-A cameras (with E-TTL auto flash control). Type-B cameras (with TTL auto flash control). (See page 2)
Flash coverage and Guide No	See page 44.
Battery life and recycling time	See page 11.
Flash duration	1.4 ms or less, (Normal Flash)
Flash coverage	Auto zoom head covers 24mm, 28mm, 35mm, 50mm, 70mm, and 105mm lenses automatically.
Flash modes	(1) Normal sync (2) High-speed sync (FP flash); Type-A Camera. (3) Test firing (with test firing button)
Tiltable angles	Max. tilt angle: 90° upward Click stops: 0°, 60°, 75°, 90°.
Exposure control modes	(1) E-TTL auto flash (Type-A Camera). (2) FE lock (Type-A Camera). (3) TTL auto flash (with EOS cameras without E-TTL auto flash capability).
Flash metering system	(1) E-TTL auto flash metering with a test preflash (Type-A Camera). (2) E-TTL auto flash partial metering with a test preflash (Type-A Camera). (3) TTL off-the-film auto flash metering (with Type-B cameras).
Flash exposure compensation	(1) Automatic flash output reduction for fill flash. (2) Enabled with cameras having flash-exposure compensation capability.
Flash range (with 50mm f/1.4 lens at ISO 100)	(1) With normal sync: 0.7 - 22 meters / 2.3-73ft (2) With high-speed sync: 0.7 - 11.9 meters / 2.3-39.27ft (at 1/125 sec).
Sync speed	See page 46.
Flash-ready indication	Red pilot lamp.
AF-assist beam linkage and range	Linked to center focusing point, effective from approx. 0.7 to 10 meters / 2.3 to 33ft (in total darkness).
Auto power off	Power turns off automatically after 90 sec. of non-use.
Power source	(1) Four size-AA alkaline batteries (LR6 or AM-3) (2) Four size-AA NiCd batteries (KR15 or KR51)
Dimensions (mm)	75 (W) x 113.5 (H) x 103.5 (D) / 2.15 / 16 (w) x 4.1 / 2 (H) x 4.3 / 4 (D)
Weight	270 g (excluding batteries) / 9.45oz

### Guide No. (meters at ISO 100)

Flash Coverage (mm)		24	28	35	50	70	105
Normal (full) Output (G.N.)		21	23	28	31	33	38
FP Flash	Shutter Speed						
	1/180	11.2	12.3	15.0	16.6	17.6	20.3
	1/250	10.0	11.0	13.3	14.8	15.7	18.1
	1/350	8.7	9.6	11.6	12.9	13.7	15.8
	1/500	7.3	8.0	9.8	10.8	11.5	13.3
	1/750	6.2	6.8	8.2	9.1	9.7	11.2
	1/1000	5.2	5.7	6.9	7.7	8.2	9.4
	1/1500	4.4	4.8	5.8	6.4	6.9	7.9
	1/2000	3.7	4.0	4.9	5.4	5.8	6.6
	1/3000	3.1	3.4	4.1	4.6	4.8	5.6
1/4000	2.6	2.8	3.5	3.8	4.1	4.7	

### Battery Life and Recycling Time

Battery Type	No. of Flashes	Recycling Time
Size-AA alkaline batteries (LR6 or AM-3)	260 to 1800	0.1 to 7.5 sec.
Size-AA NiCd batteries (KR15 or KR51)	75 to 500	0.1 to 4.5 sec.

- The above figures are based on Canon's Standard Test Method with a new set of batteries.

## AF-Assist Beam Emission Preconditions

380EX/Camera Combination		380EX's AF-Assist Beam Emitted	Camera's AF-Assist Beam Emitted
EOS 50 EOS 50 E EOS ELAN II EOS ELAN III E	With the center focusing point selected.	○	—
	With the left or right focusing point selected	—	○
EOS 500, EOS REBEL X, EOS 5000, EOS 888 EOS 5, EOS A2, EOS A2E, EOS 10		—	○
EOS-1N, EOS-1N RS, EOS 1000N, EOS REBEL II, EOS 1000 FN, EOS REBEL SII, EOS REBEL, EOS 1000, EOS 100, EOS ELAN, EOS 700, EOS RT, EOS- 1, EOS 630, EOS850, EOS 750, EOS 620, EOS 650		○	—

- \* With the EOS-1N, EOS-1N RS, if a focusing point other than the center one is selected, the camera's AF-assist beam is emitted instead.

## Camera's Flash-Related Exposure Warnings

Exposure Mode	Warning Indicator	Description	Remarks
Aperture-priority AE	Max. sync speed blinks.	The background will be overexposed.	Only the flash exposure setting for the subject is correct. Changing the aperture may stop the shutter speed from blinking.
Shutter speed-priority AE	Minimum aperture setting blinks.	The background will be overexposed.	Only the flash exposure setting for the subject is correct.
	Maximum aperture setting blinks.	The background will be underexposed.	
Program AE	Minimum aperture setting blinks.	The subject is too bright.	Attach a neutral-density filter to the lens to reduce the amount of light received by the camera.

# Speedlite 380EX Feature Availability

Camera	Camera's Max. Sync Speed				3-Zone Auto Flash Metering	Auto Flash Control		Flash Exposure Compens- ation with Camera	Second- Curtain Sync	Camera Mode for Fully- Automatic Flash	Bulb Exposure
	1/90	1/125	1/200	1/250		E-TTL	TTL				
EOS 650		●			×	×	●	×	×	P/□	●
EOS 620				●	×	×	●	×	×	P/□	×
EOS 750		●			×	×	●	×	×	PROGRAM	×
EOS 850		●			×	×	●	×	×	PROGRAM	●
EOS 630		●			×	×	●	×	×	P/□	●
EOS-1				●	×	×	●	×	×	P	●
EOS RT		●			×	×	●	×	×	P	●
EOS 10/10S		●			●	×	●	×	×	P/□	●
EOS 700		●			×	×	●	×	×	P	●
EOS 1000/REBEL	●				×	×	●	×	×	P/□	●
EOS 100/ELAN		●			×	×	●	×	×	P/□	●
EOS1000N REBELII	●				×	×	●	×	×	P/□	●
EOS1000FN REBEL SII	●				×	×	●	×	×	P/□	●
EOS 5/A2/A2E			●		●	×	●	●	×	P/□	●
EOS 500 / REBEL X	●				●	×	●	×	×	P/□	●
EOS 5000 EOS 888	●				●	×	●	×	×	□	●
EOS 1N/1NRS				●	●	×	●	●	×	P	●
EOS50.50E ELANIELANIII		●			●	●	×	●	●	P/□	●

This device complies with Part 15 of the FCC Rules. Operation is subject to the following two conditions: (1) This device may not cause harmful interference, and (2) this device must accept any interference received, including interference that may cause undesired operation.

Do not make any changes or modifications to the equipment unless otherwise specified in the instructions. If such changes or modifications should be made, you could be required to stop operation of the equipment.

This equipment has been tested and found to comply with the limits for a class B digital device, pursuant to part 15 of the FCC Rules. These limits are designed to provide reasonable protection against harmful interference in a residential installation. This equipment generates, uses and can radiate radio frequency energy and, if not installed and used in accordance with the instructions, may cause harmful interference to radio communications.

However, there is no guarantee that interference will not occur in a particular installation. If this equipment does cause harmful interference to radio or television reception, which can be determined by turning the equipment off and on, the user is encouraged to try to correct the interference by one or more of the following measures:

- Reorient or relocate the receiving antenna.
- Increase the separation between the equipment and receiver.
- Consult the dealer or an experienced radio/TV technician for help.

This digital apparatus does not exceed the Class B limits for radio noise emissions from digital apparatus as set out in the interference-causing equipment standard entitled "Digital Apparatus", ICES-003 of the Industry Canada.



The CE Mark is a Directive conformity mark of the European Community (EC)

# Canon

**CANON INC.** 30-2, Shimomaruko 3-chome, Ohta-ku, Tokyo 146, Japan

- U.S.A.** ————— **CANON U.S.A., INC.**  
FOR ALL INQUIRIES CONCERNING THIS CAMERA, CALL TOLL FREE IN THE U.S. 1-800-828-4040  
OR WRITE TO:  
CUSTOMER RELATIONS, CANON U.S.A., INC. ONE CANON PLAZA, LAKE SUCCESS, NY 11042-1113
- CANADA** ————— **CANON CANADA INC. HEADQUARTERS**  
6390 Dixie Road, Mississauga, Ontario L5T 1P7, Canada  
**CANON CANADA INC. MONTREAL SERVICE CENTRE**  
10652 Côte de Liesse, Lachine Quebec H8T 1A5, Canada  
**CANON CANADA INC. CALGARY OFFICE**  
2828, 16th Street, N.E. Calgary, Alberta T2E 7K7, Canada
- EUROPE, AFRICA & MIDDLE EAST** ————— **CANON EUROPA N.V.**  
Bovenkerkerweg 59-61, P.O. Box 2262, 1180 EG Amstelveen, The Netherlands  
**CANON PHOTO VIDEO FRANCE S.A.**  
"Le Doubleton" 11, Avenue Dubonnet 92407 Courbevoise Cedex, France  
**CANON UK LTD.**  
Units 4 & 5, Brent Trasing Centre, North Circular Road, London NW10 0JF, United Kingdom  
**CANON EURO-PHOTO G.m.b.H**  
Siemensring 90-92, D-47877 Willich 1, Germany  
**CANON ITALIA S.p.A**  
Via Meccenate 90, 20138 Milano, Italy
- CENTRAL & SOUTH AMERICA** ————— **CANON LATIN AMERICA, INC. DEPTO. DE VENTAS**  
Apartado 7022, Panamá S. República de Panamá  
**CANON LATIN AMERICA, INC. CENTRO DE SERVICIO Y REPARACION**  
Apartado 2019, Zona Libre de Colón, República de Panamá
- SOUTHEAST ASIA** ————— **CANON HONGKONG TRADING CO., LTD.**  
10/F., Mirror Tower, 61 Mody Road, Tsimshatsui East, Kowloon, Hong Kong  
**CANON SINGAPORE PTE. LTD.**  
79 Anson Road #09-01/06 Singapore 0207
- OCEANIA** ————— **CANON AUSTRALIA PTY. LTD.**  
1 Thomas Holt Drive, North Ryde, N.S.W. 2113, Australia  
**CANON NEW ZEALAND LTD.**  
Fred Thomas Drive, P.O. Box 33-336, Takapuna, Auckland, New Zealand
- JAPAN** ————— **CANON SALES CO., INC.**  
12-15, Mita, 3-Chome, Minato-ku, Tokyo 108, Japan

**NOTE FOR CUSTOMERS IN THE US**



NICKEL-CADMIUM BATTERY.  
MUST BE RECYCLED OR DISPOSED OF PROPERLY.

FOR MORE INFORMATION, PLEASE CONTACT YOUR STATE  
ENVIRONMENTAL AGENCY.

RBRC RECYCLING SYSTEM IS AVAILABLE IN THE US ONLY.

**NOTE FOR CUSTOMERS IN EUROPE**



NICKEL-CADMIUM BATTERY.  
MUST BE RECYCLED OR DISPOSED OF PROPERLY.



## Free Manuals Download Website

<http://myh66.com>

<http://usermanuals.us>

<http://www.somanuals.com>

<http://www.4manuals.cc>

<http://www.manual-lib.com>

<http://www.404manual.com>

<http://www.luxmanual.com>

<http://aubethermostatmanual.com>

Golf course search by state

<http://golfingnear.com>

Email search by domain

<http://emailbydomain.com>

Auto manuals search

<http://auto.somanuals.com>

TV manuals search

<http://tv.somanuals.com>