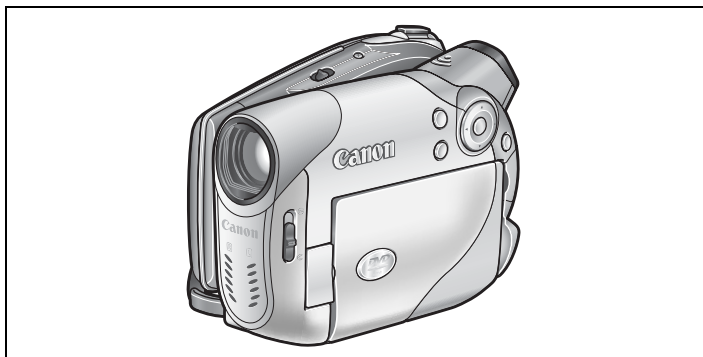

Canon

DVD Camcorder Instruction Manual

English

DC100/DC95

**Introduction****Preparations****Basic
Functions****Advanced
Functions****Editing
Functions****Disc
Finalization****External
Connections****Trouble?****Do's & Don'ts****Additional
Information****PAL**

Important Usage Instructions

WARNING!



TO REDUCE THE RISK OF ELECTRIC SHOCK, DO NOT REMOVE COVER (OR BACK). NO USER SERVICEABLE PARTS INSIDE. REFER SERVICING TO QUALIFIED SERVICE PERSONNEL.

WARNING!



TO REDUCE THE RISK OF FIRE OR ELECTRIC SHOCK, DO NOT EXPOSE THIS PRODUCT TO RAIN OR MOISTURE.

CAUTION:

TO REDUCE THE RISK OF ELECTRIC SHOCK AND TO REDUCE ANNOYING INTERFERENCE, USE THE RECOMMENDED ACCESSORIES ONLY.

CAUTION:

DISCONNECT THE MAINS PLUG FROM THE SUPPLY SOCKET WHEN NOT IN USE.

The Mains plug is used as the disconnect device. The Mains plug shall remain readily operable to disconnect the plug in case of an accident.

CA-570 identification plate is located on the bottom.



Using any device other than the Compact Power Adapter CA-570 may damage the camcorder.

This product has been classified under IEC60825-1:1993 and EN60825-1:1994.

CLASS 1 LASER PRODUCT

European Union (and EEA) only.



This symbol indicates that this product is not to be disposed of with your household waste, according to the WEEE Directive (2002/96/EC) and your national law. This product should be handed over to a designated collection point, e.g., on an authorized one-for-one basis when you buy a new similar product or to an authorized collection site for recycling waste electrical and electronic equipment (EEE). Improper handling of this type of waste could have a possible negative impact on the environment and human health due to potentially hazardous substances that are generally associated with EEE. At the same time, your cooperation in the correct disposal of this product will contribute to the effective usage of natural resources. For more information about where you can drop off your waste equipment for recycling, please contact your local city office, waste authority, approved WEEE scheme or your household waste disposal service. For more information regarding return and recycling of WEEE products, please visit

www.canon-europe.com/environment.
(EEA: Norway, Iceland and Liechtenstein)

The Advantages of DVDs

RECORDING

With a DVD you just press the recording start/stop button and the camcorder will find the empty space on the disc (□ 22). Don't waste time fast forwarding and rewinding a tape to find from where to start a new recording.

Never worry about mistakenly recording over a precious memory!



PLAYING

Just select a scene from the index screen!

Just insert your finalized* disc into a DVD player and immediately find the scene you want to play back from the index (□ 26). No need to play the whole thing or run the tape forward and back to find that scene you want.

* Finalization is a process required to make the DVD discs you recorded playable on common DVD players (□ 59).



An Introduction to DVDs

You have probably heard of DVD discs and they come in various types and in two sizes - the more common 12 cm DVDs and 8 cm Mini DVDs. This camcorder uses commercially available 8 cm DVD-R or DVD-RW discs.



So... what disc to choose?



DVD-R

Can be recorded only once.

You cannot edit or delete the recordings.



DVD-RW

You can record on it many times.

You can delete scenes or initialize the disc and start recording again.



Now that I have the disc... What disc standard do I choose to initialize it?



VIDEO mode

Once finalized, a disc recorded in VIDEO mode will play in most common DVD players. However, you cannot edit the recordings.

VR* mode

You can easily edit the recordings. However, the disc can only be played back with DVD players compatible with DVD-RW discs in VR mode.

* Video Recording

Differences in Available Features Depending on the Disc

The camcorder's features and functions available will differ depending on the type of disc you use and the disc specification selected when initializing it.

Disc Type/Specification Feature	DVD-R	DVD-RW		📖
	VIDEO mode	VIDEO mode	VR mode	
Editing scenes with this camcorder (deleting scenes, editing the Playlist)	–	–	●	52
Deleting a scene or still image (DC100 only) immediately after recording it	–	●	●	53 57
Initializing the disc in order to use it again for recording	–	●	●	55
Giving a title to the disc	●	●	●	56
Finalizing the disc in order to play it with a DVD player	●	●	●*	59
Adding recordings to a disc already finalized	–	●**	●	61
DC100 Converting still images into Photomovie scenes	●	●	●	58

* Playback cannot be guaranteed with all external DVD devices (DVD players, DVD recorders, etc.).

** You will need to unfinalize the disc first.

- **Recommended Discs:** This camcorder's performance was tested using Hitachi-Maxell HG-series DVD discs. For use of other DVD media, contact directly the manufacturer's customer support center.
- Attempting to record or play with this camcorder DVD discs that were recorded, initialized or finalized with other digital devices can result in lost data.
- You need to initialize newly bought DVD-RW discs with this camcorder before using them for the first time.
- For the highest compatibility with external DVD devices we recommend using the VIDEO mode.

Table of contents

Introduction

The Advantages of DVDs	3
An Introduction to DVDs	4
Differences in Available Features Depending on the Disc	5
About this Manual	8
Checking the Supplied Accessories	10
Components Guide	11
Screen Displays	13

Preparations

Getting Started	15
Step 1: Preparing the Power Supply	15
Step 2: Preparing the Camcorder	17
Step 3: Adjusting the LCD Screen	17
Step 4: Changing the Display Language	18
Step 5: Setting the Time Zone / Daylight Saving Time	18
Step 6: Setting the Date and Time	19
Step 7: Loading and Removing a Disc	20

Basic Functions

Recording

Recording Movies	22
Selecting the Aspect Ratio of your Recordings (16:9 Widescreen or 4:3)	23
DC100 Recording Still Images	24
Zooming	25

Playback

Playing Back Movies	26
Adjusting the Volume	27
Viewing Still Images	28
Magnifying the Image	29
Selecting the Recording Data Display	30

Advanced Functions

Options Lists – MENU / FUNC.	31
MENU Options	31
Camera Setup (Digital Zoom, Image Stabilizer, etc.)	31
Still Image Operations (Erase All Images)	32
Disc Operations (DC100 Photomovie, Finalize, etc.)	32
Display Setup (LCD Brightness, Language, etc.)	33
System Setup (Volume, Beep, etc.)	34
Date/Time Setup	35
FUNC. Menu Options	35

Recording Programs

Using the Recording Programs	37
Selecting the Recording Program	38
P Using the Program AE Mode	38
Tv Using the Shutter-Priority AE Mode	39
Av Using the Aperture-Priority AE Mode	40

More Recording Options

Manually Adjusting the Exposure	41
DC100 Changing the Metering Method	41

Manually Adjusting the Focus.....	42
Changing the Autofocus Mode	43
Using the Self Timer	44
Setting the White Balance	45
Applying Image Enhancing Effects.....	47
Using the Digital Effects.....	48
DC100 Selecting the Size and Quality of Still Images.....	51

Editing Functions

Editing the Scenes (DVD-RW in VR mode only)

Adding Scenes to the Playlist.....	52
Moving Scenes in the Playlist.....	52
Deleting Scenes	53
Dividing a Scene.....	54

Disc Options

Protecting the Disc	55
Initializing the Disc.....	55
Changing the Disc Title	56

Still Image Options

Erasing Still Images.....	57
DC100 Converting Still Images into Photomovie Scenes	58

Disc Finalization

Preparing your Disc for Playing on a DVD Player – [FINALIZE]	59
Playing Back your Disc on a DVD Player or a Computer's DVD Drive	60
Recording Additional Movies on a Finalized Disc – [UNFINALIZE].....	61

External Connections

Connecting to a TV and VCR

Playing Back on a TV Screen.....	62
Recording to a VCR.....	64

Trouble?

Troubleshooting.....	65
List of Messages.....	68

Do's & Don'ts

Handling Precautions	70
Maintenance/Others	72

Additional Information

System Diagram.....	74
Optional Accessories.....	75
Specifications.....	77
Index.....	79

About this Manual

Thank you for purchasing the Canon DC100/DC95. Please read this manual carefully before you use the camcorder and retain it for future reference. Should your camcorder fail to operate correctly, refer to the *Troubleshooting* table (□ 65).

Conventions Used in the Manual

- ⓘ : Precautions related to the camcorder operation.
- 👉 : Additional topics that complement the basic operating procedures.
- : Reference page number.
- ⊙ : Buttons and switches other than the multi selector's **SET** are indicated as ******* (for example **MENU**).
- [] are used to refer to menu items displayed on the screen. Menu options in boldface indicate a default setting (for example **[ON]**, **[OFF]**).
- “Screen” refers to the LCD and the viewfinder screen.
- The photos included in the manual are simulated pictures taken with a still camera.
- DC100** : Option or feature that applies or is available only with this model.

Menu item shown at its default position

Buttons and switches to be operated



Step 4: Changing the Display Language

MENU (□ 35) **DISPLAY SETUP** **LANGUAGE** ENGLISH

Options

[DEUTSCH]	[РУССКИЙ]
[ENGLISH]	[日本語]
[ESPAÑOL]	[OFF]
[FRANÇAIS]	[ON]
[ITALIANO]	[영어/ไทย]
[POLSKI]	[українська]

1. Press **MENU**.
2. Select **[AV]** [DISPLAY SETUP] and press (⊙).
3. Select **[AV]** [LANGUAGE] and press (⊙).
4. Select **[AV]** **[▶]** the desired option and press (⊙).
5. Press **MENU** to close the menu.

 If you changed the language by mistake, follow the  mark next to the menu item to change the setting.

About the Multi Selector

Use the multi selector to select options in a menu and change settings.

Push the multi selector up, down, left or right (▲/▼/◀/▶) to select an item. In most places, press the multi selector itself (⊙) to make a selection or change a setting.

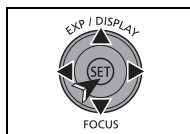

Selecting an Option - MENU/FUNC.

Many of the camcorder's functions can be adjusted from the menus that open after pressing the **MENU** button (**MENU**) and the **FUNC.** button (**FUNC.**).

For details about the available menu options and settings, refer to *Options Lists - MENU/FUNC.* (□ 31).

Selecting MENU options

1. Press **MENU**.
2. Select (**▲▼**) the desired menu from the left side column and press (**SET**).
The title of the selected menu appears on top of the screen and under it the list of settings.
3. Select (**▲▼**) the setting you want to change and press (**SET**).
 - The orange selection bar indicates the menu setting currently selected. Items not available appear in black.
 - To return to the menu selection screen, select (**▼**) [RETURN] and press (**SET**).
4. Select (**▲▼**) the desired option and press (**SET**) to save the setting.
5. Press **MENU**.



You can press **MENU** to close the menu at any time.

Selecting FUNC. Menu Options

1. Press **FUNC.**
2. Select (**▲▼**) the icon of the function you want change from the left side column.
3. Select (**◀▶**) the desired setting from the available options at the bottom bar.
The selected option will be highlighted in light blue.
4. Press **FUNC.** to save the settings and close the menu.
 - You can press **FUNC.** to close the menu at any time.
 - With some settings, you will need to make further selections (**▲▼**, **◀▶**) and/or press (**SET**). Follow the additional operation guides that will appear on the screen (such as the **SET** icon, small arrows, etc.).

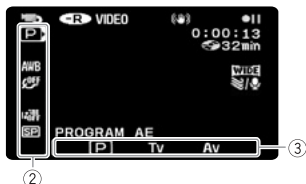

About the Operating Modes

Operating Mode	Operating Mode Indicator	Operation	
CAMERA ·	(CAMERA) Red LED	Recording movies	22
CAMERA ·		Recording still images	24
PLAY ·	(PLAY) Green LED	Playing movies	26
PLAY ·		Viewing still images	28

* To use the still images functions (**DC100** **CAMERA** · or **PLAY** · , **DC95** only **PLAY** ·) you need to set [STILL IMAGES] to [ON] as explained below.

To activate the still images modes

1. Press **MENU**.
2. Select (**▲▼**) [SYSTEM SETUP] and press (**SET**).
3. Select (**▲▼**) [STILL IMAGES] and press (**SET**).
4. Select (**▲▼**) [ON] and press (**SET**).
5. Press **MENU** again to close the menu.

To change the operating mode

In addition to turning the camcorder on and off, the power switch also toggles the camcorder's operating mode.

From the ON position, slide down the power switch momentarily towards MODE and release it.

This action will toggle the operation mode in the following sequence:

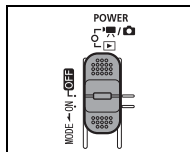

DC95/DC100 with [STILL IMAGES] set to [OFF] (default)

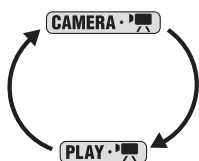

DC100 with [STILL IMAGES] set to [ON]

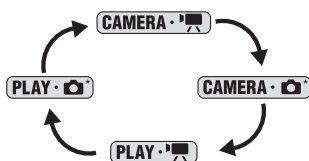

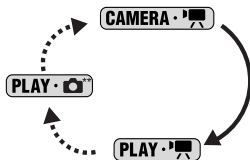

DC95 with [STILL IMAGES] set to [ON]

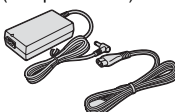
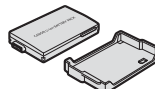

You cannot record still images with the **DC95, but you can view still images already recorded on a disc (with another camcorder). Playback cannot be guaranteed for all still images.

Checking the Supplied Accessories

CA-570 Compact Power Adapter (incl. power cord) 	BP-208 Battery Pack 	STV-250N Stereo Video Cable 	PC-A10 SCART Adapter* 
---	--	--	--

* Europe only.

Trademark Acknowledgements

- **DVD** is a trademark of DVD Format/Logo Licensing Corporation.
- Manufactured under license from Dolby Laboratories.
"Dolby" and the double-D symbol are trademarks of Dolby Laboratories.
- Other names and products not mentioned above may be trademarks or registered trademarks of their respective companies.
- ANY USE OF THIS PRODUCT OTHER THAN CONSUMER PERSONAL USE IN ANY MANNER THAT COMPLIES WITH THE MPEG-2 STANDARD FOR ENCODING VIDEO INFORMATION FOR PACKAGED MEDIA IS EXPRESSLY PROHIBITED WITHOUT A LICENSE UNDER APPLICABLE PATENTS IN THE MPEG-2 PATENT PORTFOLIO, WHICH LICENSE IS AVAILABLE FROM MPEG LA, L.L.C., 250 STEELE STREET, SUITE 300, DENVER, COLORADO 80206.



Components Guide

Left side view

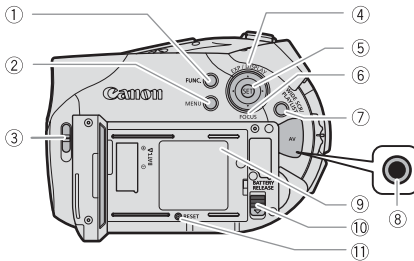

Right side view

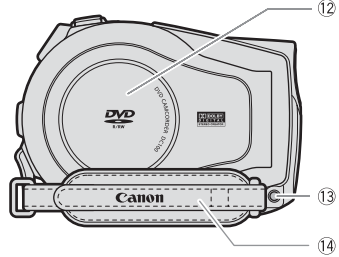

Front view

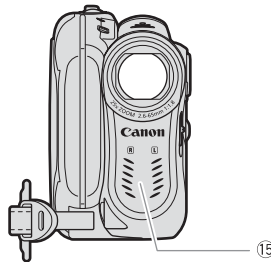

- ① FUNC. button (35)
- ② MENU button (31)
- ③ Lens cover switch (22, 24)
(☺ - open, ☹ - closed)
- ④ EXP (Exposure) switch (41) /
DISPLAY button (30) (Multi Selector)
- ⑤ (SET) button (Multi Selector) (8)
- ⑥ FOCUS button (42) (Multi Selector)
- ⑦ WIDE SCR (Widescreen) button (23) /
PLAYLIST button (52)

- ⑧ AV OUT terminal (62)
- ⑨ Serial number
- ⑩ BATTERY RELEASE switch (15)
- ⑪ RESET button (65)
- ⑫ Disc compartment cover (20)
- ⑬ DC IN terminal (15)
- ⑭ Grip belt (17)
- ⑮ Stereo microphone

Buttons and switches other than (SET) are indicated throughout the manual as *** (for example, **MENU**).

Top view

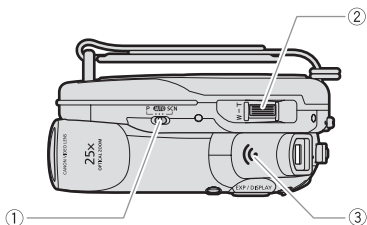

Bottom view

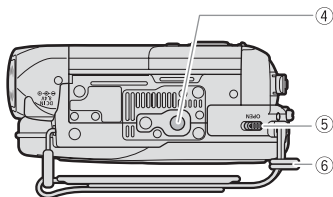

Back view

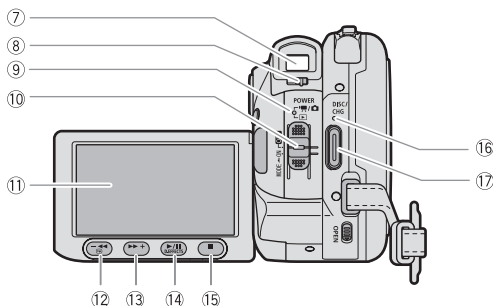

① Mode switch (37)

② Zoom lever (25)

③ Speaker (27)

④ Tripod socket (23)

⑤ OPEN (disc cover) switch (20)

⑥ Strap mount

⑦ Viewfinder (17)

⑧ Dioptic adjustment lever (17)

⑨ Operating mode indicator (9)

DC100 Red / (CAMERA),

DC95 Red (CAMERA),

Green (PLAY)

⑩ Power switch (9)

⑪ LCD screen (17)

⑫ (record review) button (23) /
 (fast reverse) button (26) /
 Index screen – button (26)

⑬ (fast forward) button (26) /
 Index screen + button (26)

⑭ D.EFFECTS button (48) /
 (play/pause) button (26)

⑮ (stop) button (26)

⑯ DISC access indicator (22, 24) /
 CHG. (charge) indicator (15)









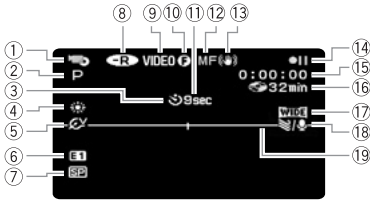















⑰ Start/stop button (22, 24)

Buttons and switches other than () are indicated throughout the manual as ******* (for example, **MENU**).

Screen Displays

CAMERA Recording Movies



- ① Operating mode ( 9)
- ② Recording program ( 37)
- ③ Self timer ( 44)
- ④ White balance ( 45)
- ⑤ Image effect ( 47)
- ⑥ Digital effects ( 48)
- ⑦ Recording mode ( 36)
- ⑧ Disc type
 DVD-R,  DVD-RW ( 4)
- ⑨ Disc specification
 (VIDEO mode, VR mode) ( 4)
- ⑩ Finalized disc mark ( 59)
- ⑪ Recording reminder
- ⑫ Manual focus ( 42)
- ⑬ Image stabilizer ( 31)
- ⑭ Disc operation
- ⑮ Time code (hours : minutes : seconds)
- ⑯ Remaining recording time
- ⑰ Widescreen mode ( 23)
- ⑱ Wind screen ( 32)
- ⑲ Level marker ( 33)
- ⑳ Zoom ( 25), Exposure ( 41)
- ㉑ Metering mode ( 41)
- ㉒ Still image quality/size ( 51)
- ㉓ Number of still images available
- ㉔ Remaining battery charge
- ㉕ AF frame ( 43)
- ㉖ Camcorder shake warning ( 31)
- ㉗ AF/AE locked during still image recording ( 24)

DC100

CAMERA Recording Still Images

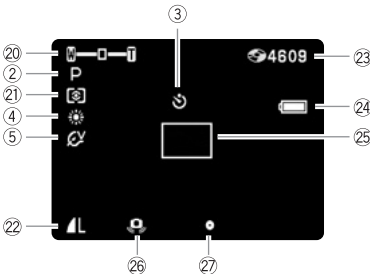

⑪ Recording reminder

The camcorder counts from 1 to 10 seconds when you start recording. This is helpful to avoid scenes that are too short.

⑯ Remaining recording time

When there is no more available disc space, "END" will be displayed and the recording will stop.

⑭ Disc operation



- Record, ●|| Record pause,
 - ▶ Playback, || Playback pause,
 - ▶▶ Fast playback,
 - ◀◀ Fast reverse playback,
 - ▶ Slow playback*,
 - ◀ Slow reverse playback*
- * Only with a DVD-RW in VR mode.

23 DC100 Number of still images available

- flashing in red: No disc
 - in green: 6 or more images
 - in yellow: 1 to 5 images
 - in red: No more images can be recorded
- When viewing the still images, the display will always be in green.
 - Depending on the recording conditions, the number of still images available displayed may not decrease even after a recording has been made, or may decrease by 2 still images at once.

24 Remaining battery charge



- When “” starts flashing in red replace the battery pack with a fully charged one.
- When you attach an empty battery pack, the power may turn off without displaying “”.
- Depending on the conditions under which the camcorder and the battery pack are used, the actual battery charge may not be indicated accurately.

PLAY Playing Movies (Index Screen)



① Current scene number / Total number of scenes ( 26)

② Date and time of recording

PLAY Playing Movies (During Playback)



① Disc operation

② Playback time (hours : minutes : seconds)

③ Scene number

④ Data code ( 30)

PLAY Viewing Still Images



① Image number ( 34)

② Current image / Number of images

③ Still image size

④ Data code ( 30)

Getting Started

Step 1: Preparing the Power Supply

The camcorder can be powered with a battery pack or directly using the compact power adapter. Charge the battery pack before use.

1. Turn off the camcorder.

2. Attach the battery pack to the camcorder.

- Open the LCD panel.
- Slide in the connector end of the battery in the direction of the arrow and press it gently until it clicks.

3. Connect the power cord to the compact power adapter.

4. Plug the power cord into a power outlet.

5. Connect the compact power adapter to the camcorder's DC IN terminal.

- The CHG. (charge) indicator starts flashing. The indicator will stay on when the charging is completed.
- You can also use the compact power adapter without attaching a battery pack.
- When the compact power adapter is connected, even if a battery is attached its power will not be consumed.

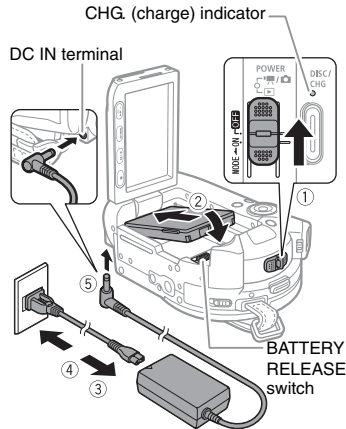

Remove the battery terminal cover before attaching the battery

Once the battery is fully charged:

1. Disconnect the compact power adapter from the camcorder.

2. Unplug the power cord from the power outlet and the compact power adapter.

To remove the battery pack:

Slide down **BATTERY RELEASE** to release the battery pack, and pull out the battery pack holding it from the ridge on its bottom part.

Charging, Recording and Playback Times with the BP-208 Battery Pack

The charging time of the BP-208 battery pack is 165 min.

The following recording and playback times are approximate and vary according to the charging, recording or playback conditions.

Recording Mode		Max. Recording Time	Typical Recording Time*	Playback Time
XP	Viewfinder	80 min.	45 min.	85 min.
	LCD [NORMAL]	80 min.	45 min.	
	LCD [BRIGHT]	75 min.	40 min.	
SP	Viewfinder	95 min.	50 min.	95 min.
	LCD [NORMAL]	90 min.	50 min.	
	LCD [BRIGHT]	90 min.	45 min.	
LP	Viewfinder	105 min.	50 min.	105 min.
	LCD [NORMAL]	100 min.	50 min.	
	LCD [BRIGHT]	95 min.	50 min.	

* Approximate times for recording with repeated operations such as start/stop, zooming, power on/off.



- Turn off the camcorder before connecting or disconnecting the power adapter.
- Do not connect to the camcorder's DC IN terminal or to the compact power adapter any electrical equipment that is not expressly recommended for use with this camcorder.
- You may hear some noise from the compact power adapter during use. This is not a malfunction.
- To prevent equipment breakdowns and excessive heating, do not connect the supplied compact power adapter to voltage converters for overseas travels or special power sources such as those on aircraft and ships, DC-AC inverters, etc.
- We recommend charging the battery pack in temperatures between 10 °C and 30 °C. Outside the temperature range of 0 °C to 40 °C, the charging will not start.



- If you connect a faulty power adapter or battery pack, the CHG. (charge) indicator flashes rapidly (approx. twice per second) and the charging stops.
- The CHG. (charge) indicator also serves as a rough estimate of the battery charge status.
 Continuously on: Battery fully charged.
 Flashes approx. twice per second: Battery over 50% charged.
 Flashes approx. once per second: Battery less than 50% charged.
- We recommend that you prepare battery packs 2 to 3 times longer than you think you might need.
- The charging time will vary depending on the surrounding temperature and the battery pack's initial charge condition.
- In cold surroundings the usable time of the battery pack will decrease.

Step 2: Preparing the Camcorder

1. Turn on the camcorder.

2. Adjust the viewfinder.

Keep the LCD panel closed to use the viewfinder and adjust the dioptic adjustment lever as necessary.

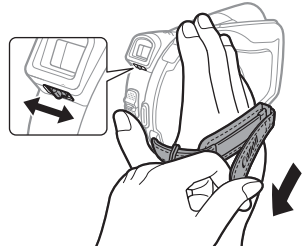

3. Fasten the grip belt.

Adjust the grip belt so that you can reach the zoom lever with your index finger, and the start/stop button with your thumb.

Step 3: Adjusting the LCD Screen

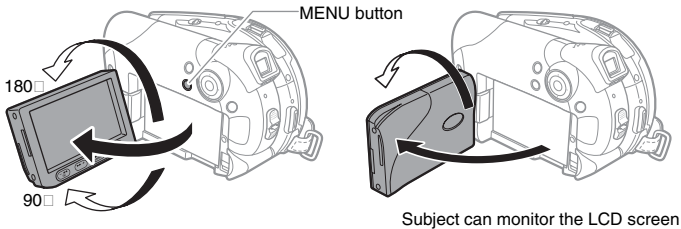

Rotating the LCD Panel

Open the LCD panel 90 degrees.

- You can rotate the panel downward by 90 degrees.
- You can rotate the panel by 180 degrees toward the lens (allowing the subject to monitor the LCD screen while you use the viewfinder). Rotating the panel by 180 degrees is also useful if you wish to include yourself when recording with the self-timer.

LCD Backlight

You can switch the brightness of the LCD screen to [NORMAL] or [BRIGHT].

1. Press **MENU**.
2. Select (▲▼) [DISPLAY SETUP] and press (SET).
3. Select (▲▼) [BACKLIGHT] and press (SET).
4. Select (▲▼) the desired option and press (SET).
5. Press **MENU** to close the menu.



- This setting does not affect the brightness of the recording or the viewfinder screen.
- Using the [BRIGHT] setting will shorten the effective usage time of the battery.

Step 4: Changing the Display Language

MENU
( 31)



Options

[DEUTSCH]	[РУССКИЙ]
[ENGLISH]	[简体中文]
[ESPAÑOL]	[繁體中文]
[FRANÇAIS]	[한국어]
[ITALIANO]	[ภาษาไทย]
[POLSKI]	[日本語]

1. Press **MENU**.
2. Select (**▲▼**) [DISPLAY SETUP] and press (**SET**).
3. Select (**▲▼**) [LANGUAGE SET).
4. Select (**▲▼**, **◀▶**) the desired option and press (**SET**).
5. Press **MENU** to close the menu.



If you changed the language by mistake, follow the  mark next to the menu item to change the setting.

Step 5: Setting the Time Zone / Daylight Saving Time

MENU
( 31)



1. Press **MENU**.
2. Select (**▲▼**) [DATE/TIME SETUP] and press (**SET**).
3. Select (**▲▼**) [T.ZONE/DST] and press (**SET**).
The time zone setting appears. The default setting is Paris.
4. Select (**▲▼**) your time zone and press (**SET**).



To adjust for daylight saving time, select the time zone with the  mark next to the area.

Time Zones

Once you have set the time zone, date and time, you do not need to reset the clock every time you travel to another time zone. Select the time zone referring to the date and time displayed on the screen.

Time Zones and Difference from GMT/UTC

London	GMT/UTC	Wellington (WELLINGTN)	+12
Paris	+1	Samoa	-11
Cairo	+2	Honolulu	-10
Moscow	+3	Anchorage	-9
Dubai	+4	Los Angeles (L.A.)	-8
Karachi	+5	Denver	-7
Dacca	+6	Chicago	-6
Bangkok	+7	New York	-5
Singapore	+8	Caracas	-4
Tokyo	+9	Rio de Janeiro (RIO)	-3
Sydney	+10	Fernando de Noronha (FERNANDO)	-2
Solomon	+11	Azores	-1

Step 6: Setting the Date and Time

MENU
(31)



DATE/TIME SETUP

DATE/TIME 1. JAN. 2006
12:00 AM

1. Press **MENU**.

2. Select () [DATE/TIME SETUP] and press ().

3. Select () [DATE/TIME] and press ().

The year is displayed in orange.

4. Select () the day and move () to the month setting.



- The next part of the date/time is displayed in orange.
- Set the month, year, hours and minutes in the same way.
- If you do not need to change all settings, move () to a specific setting you want to change.

5. Press **MENU** to close the menu and start the clock.



- When you do not use the camcorder for about 3 months, the built-in rechargeable lithium battery may discharge completely and the date and time setting may be lost. In such case, recharge the built-in lithium battery (71) and set the time zone, date and time again.
- You can also change the date format (35).

Step 7: Loading and Removing a Disc

Use only 8 cm mini DVD discs marked with the DVD-R  or DVD-RW  logo. Before inserting the disc be sure to check that the recording surface is clean. If necessary, use a soft lens-cleaning cloth to remove any fingerprints, dirt buildup or smudges from the disc surface.

Inserting the Disc

CAMERA 

CAMERA 

PLAY 

PLAY 

To change the operating mode, refer to *About the Operating Modes* (□ 9).

1. Move the power switch to ON to set the camcorder in  mode.
2. Slide **OPEN** fully in the direction of the arrow and gently open the disc cover completely until it stops.
Retract the grip belt under the camcorder so it will not get in the way of the disc cover.
3. Insert the disc and press its center firmly until it clicks in place.
 - Insert the disc with the recording side facing down (single sided discs - label side facing out).
 - Be careful not to touch the recording surface of the disc or the pick up lens.
4. Close the disc cover.
Do not force the cover closed if the disc is not correctly inserted and firmly set in place.

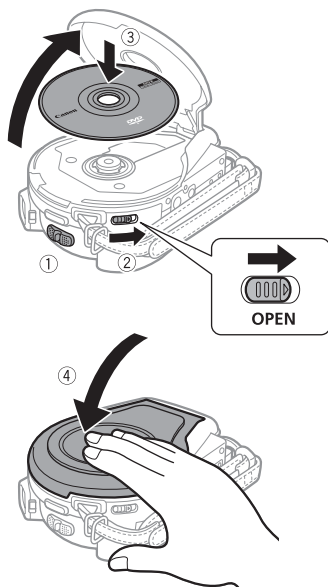





When using DVD-R discs:

You can start recording movies once the record pause  indication appears.

When using a DVD-RW:

You need to initialize new discs before you can start recording. The disc initialization screen will appear when a new DVD-RW is first inserted. It will not appear when inserting a disc already initialized. In that case, you can start recording once the record pause  indication appears.

- ① Select () the desired disc specification desired and press (). For a comparison between the specifications [VIDEO] and [VR], see *An Introduction to DVDs* (□ 4).
- ② You will be asked to confirm the disc specification you selected. Select () [YES] and press () to continue, or select [NO] and press () to return and select a different disc specification.

- ③ A confirmation message will appear on the screen. Select (▲▼) [YES] and press (SET) to start the disc initialization.
- The disc initialization will take approximately one minute. Avoid moving the camcorder while the operation is in progress.
 - You can start recording movies once the record pause ●|| indication appears.



- The disc initialization screen may not appear automatically if you operated the camcorder's buttons while the disc recognition was in progress. In that case, initialize the disc using the menu option (□ 55).
- The process of recognizing a disc may take a moment. The (🌀) display will move while the disc is being read. Wait until the camcorder finishes recognizing the disc before you start recording.

Removing the Disc

1. Slide **OPEN** fully in the direction of the arrow and gently open the disc cover completely until it stops.

- Do not subject the camcorder to strong impacts while the DISC access indicator is on or flashing.
- Retract the grip belt under the camcorder so it will not get in the way of the disc cover.
- It may take a moment after pressing **OPEN** for the disc cover to open.

2. Grab the edges of the disc and gently pull it out.

Be careful not to touch the recording surface of the disc or the pick up lens.

3. Close the disc cover.



When you slide **OPEN** after making a recording, additional important data is recorded on the disc before the disc cover opens. While the DISC access indicator is on or flashing do not subject the camcorder to shocks such as forcefully laying it on a table.

Recording

Recording Movies

Before You Begin Recording

Make a test recording first to check if the camcorder operates correctly. Since recordings made on a DVD-R cannot be deleted, we recommend you use a DVD-RW disc to make the test recordings.

CAMERA · 

CAMERA · 

PLAY · 

PLAY · 

To change the operating mode, refer to *About the Operating Modes* (□ 9).

1. **Open the LCD panel and the lens cover (move the lens cover switch down to ☺).**

2. **Press *Start/Stop* to begin recording.**

- Press *Start/Stop* again to pause recording.
- While recording and immediately after pausing, the DISC access indicator may go on while the scene is being recorded on the disc.

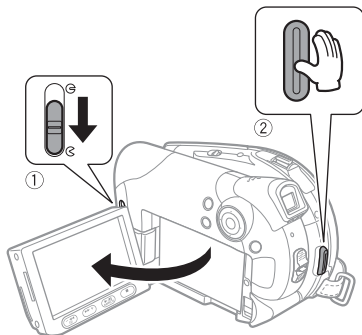

When you have finished recording:

1. **Remove the disc.**

2. **Turn off the camcorder.**

3. **Disconnect the power source and remove the battery pack.**

4. **Close the LCD panel and the lens cover (move the lens cover switch to ☹).**



Avoid the following actions while the DISC access indicator is on or flashing. Failing to do so may result in permanent data loss.

- Do not subject the camcorder to vibrations or strong impacts.
- Do not open the disc cover and do not remove the disc.
- Do not disconnect the power source or turn off the camcorder.
- Do not change the operating mode.



- **About the recording time:** By changing the recording mode you can change the recording time available on the disc (□ 36).
- When recording in bright places it may be difficult to use the LCD screen. In such case, use the viewfinder instead.
- When recording in very loud places (such as fireworks shows or concerts), sound may become distorted or it may not be recorded at the actual levels. This is not a malfunction.
- **About the Power Save mode:** In order to save power when the camcorder is powered by a battery pack, the camcorder will automatically shut off if left without any operations for 5 minutes (□ 34). To restore the power, slide the



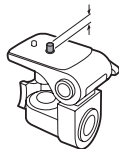

power switch towards MODE and release it, or move the power switch to **OFF** and back to ON.

- **About the LCD and viewfinder screen:** The screens are produced using extremely high-precision manufacturing techniques, with more than 99.99% of the pixels operating to specification. Less than 0.01% of the pixels may occasionally misfire or appear as black, red, blue or green dots. This has no effect on the recorded image and does not constitute a malfunction.
- **When using a tripod:** Do not leave the viewfinder exposed to direct sunlight as it may melt (due to concentration of the light by the lens). Do not use tripods with fastening screws longer than 5.5 mm. Doing so may damage the camcorder.



Reviewing the Last Scene Recorded

Press and release  (record review).

- The camcorder plays back the last scene and returns to record pause mode.
- While reviewing the scene, select () the  icon and press () to return to the recording mode.
- While reviewing a scene immediately after recording it, you can also delete the scene by selecting () the  icon (□ 53).



Selecting the Aspect Ratio of your Recordings (16:9 Widescreen or 4:3)

You can select the aspect ratio of your recording to match your TV.



To change the operating mode, refer to *About the Operating Modes* (□ 9).

Widescreen is not available when the recording mode is set to [LP] on a disc initialized in VIDEO mode.

Press **WIDE SCR.**

Repeatedly pressing **WIDE SCR** toggles between the Widescreen (16:9) and normal (4:3) aspect ratios.

WIDE SCR/
PLAYLIST



- When recording in Widescreen mode, with [IMG STAB] set to [OFF] (□ 31), you can have a wider view angle.
- **Playing back a Widescreen recording:** TV sets compatible with the Video ID-1 system will automatically switch to wide (16:9) mode. Otherwise, change the aspect ratio of the TV manually. To play back on a TV with normal aspect ratio (4:3) change the [TV TYPE] setting accordingly.

DC100 Recording Still Images

To use the still images functions, you will need to set [STILL IMAGES] to [ON] beforehand (9).

CAMERA · 

CAMERA ·  *

PLAY · 

PLAY · 

* **DC100** only. To change the operating mode, refer to *About the Operating Modes* (9).

1. Open the LCD panel and the lens cover (move the lens cover switch down to ).

2. Press **Start/Stop** halfway.

Once the focus is automatically adjusted,  will turn green and one or more AF frames appear.

3. Press **Start/Stop** fully.

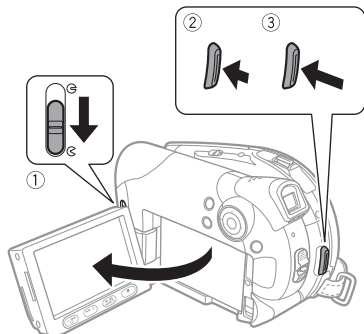

The DISC access indicator will flash as the image is being recorded.



Avoid the following actions while the disc access display  appears and while the DISC access indicator is on or flashing. Failing to do so may result in permanent data loss.

- Do not subject the camcorder to vibrations or strong impacts.
- Do not open the disc cover and do not remove the disc.
- Do not disconnect the power source or turn off the camcorder.
- Do not change the operating mode.



If the subject is not suitable for autofocus,  turns yellow. Keep **Start/Stop** pressed halfway and adjust the focus manually with the multi selector ().

Zooming

CAMERA · 

CAMERA ·  *

PLAY · 

PLAY · 

* **DC100** only. To change the operating mode, refer to *About the Operating Modes* (□ 9).

CAMERA · : In addition to the 25x optical zoom, the 1000x (**DC100**) / 770x (**DC95**) digital zoom is also available (□ 31).

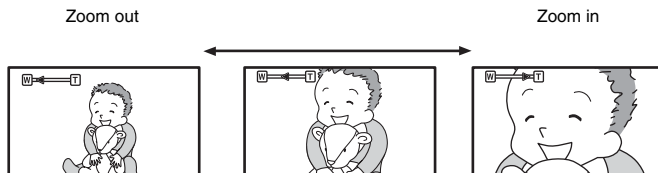

25x Optical Zoom

Move the zoom lever toward **W** to zoom out (wide-angle). Move it toward **T** to zoom in (telephoto).

You can also change the zoom speed (□ 31). You can select one of three fixed zoom speeds or a variable speed that depends on how you operate the zoom lever: Press lightly for a slow zoom; press harder for faster zooms.

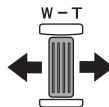

- Keep at least 1 m to the subject. At wide-angle, you can focus on a subject as close as 1 cm.
- When set to [VARIABLE], the zoom speed will be faster in the record pause mode.

Playback

Playing Back Movies

CAMERA 



CAMERA 

PLAY 

PLAY 

To change the operating mode, refer to *About the Operating Modes* (□ 9).
The scene index screen appears with the selection frame on the first scene.

1. Move (, , ,) the selection frame to the scene you want to play back.

Press  or  to move to the next or previous index page.

2. Press / to begin the playback.

- Playback of the scenes recorded on the disc will start from the scene selected.
- When the end of the last movie recorded is reached, playback will stop and the camcorder will return to the scene index screen.

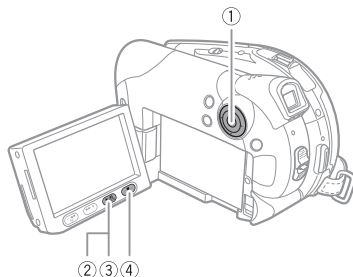

During Playback:

3. Press / again to pause the playback.

4. Press to stop the playback and return to the scene index screen.





- To use the viewfinder, close the LCD panel.
- **About the screen display:** During playback, the recording's time code will be displayed at the upper right corner of the screen in hours : minutes : seconds. You can also choose to display instead the date and time when the scene was recorded and additional recording data (□ 30).
- As long as you don't turn off the camcorder you can resume playback from the point you stopped last.

Special Playback Modes

Fast Forward Playback /

Fast Reverse Playback

During normal playback, press  or . Repeatedly press the button to increase the playback speed.

Fast forward: 1.5x → 5x → 15x → 25x the normal speed.

Fast reverse: 2.5x → 5x → 15x → 25x the normal speed.

Playback Pause

During normal playback, press /.

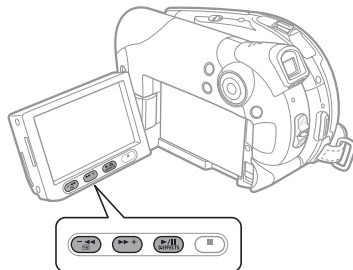

▶ Slow Forward Playback / ◀ Slow Reverse Playback

During playback pause, press or . Repeatedly press the button to increase the playback speed.

Slow playback: 1/16 → 1/8 → 1/4 → 1/2 the normal speed.

Skipping Scenes

During normal playback, push the multi selector () to skip to the beginning of the next scene. Push the multi selector () to return to the beginning of the current scene. Repeat to skip to the beginning of the previous scene.



- Except for fast playback at 1.5x the normal speed, there is no sound during special playback modes.
- The picture may become distorted during some special playback modes.
- Slow playback is not available with discs initialized in VIDEO mode.
- Depending on the recording, you might occasionally notice a brief stop of the picture or sound at the point where the scene changes.
- During the playback of a Photomovie scene, even though the display may change according to the fast forward/reverse playback, the actual playback speed will not change.

Adjusting the Volume

The camcorder plays the sound with the built-in speaker. The volume will be muted when you close the LCD panel.



To change the operating mode, refer to *About the Operating Modes* (📖 9).

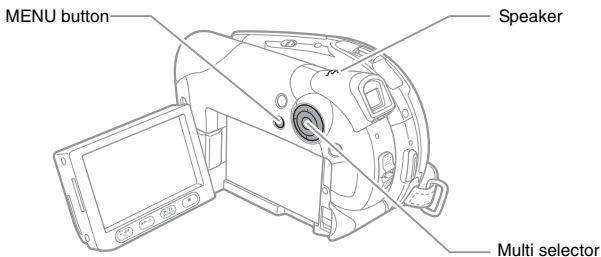

MENU
(📖 31)



1. Press **MENU**.
2. Select () [SYSTEM SETUP] and press ()
3. Select () [VOLUME] and press ()
4. Adjust () the volume as desired and press ()



To turn off the volume completely, keep pressing () until the volume icon changes to .

5. Press **MENU** to save the setting and close the menu.

Viewing Still Images

To use the still images functions, you will need to set [STILL IMAGES] to [ON] beforehand (9). **DC95**: You can view still images already recorded on a disc (with another camcorder). However, playback cannot be guaranteed for all still images.

CAMERA · 

CAMERA · 

PLAY · 

PLAY · 

To change the operating mode, refer to *About the Operating Modes* (9).

Use the multi selector (◀▶) to move between images.

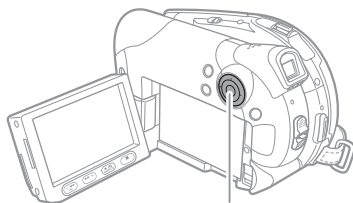

Multi selector



- Some still images may not be displayed correctly.
- Avoid the following actions while the DISC access indicator is on or flashing. Failing to do so may result in permanent data loss.
 - Do not subject the camcorder to vibrations or strong impacts.
 - Do not open the disc cover and do not remove the disc.
 - Do not disconnect the power source or turn off the camcorder.
 - Do not change the operating mode.

Slideshow

FUNC.

(35)



SLIDESHOW

1. Press **FUNC.**
2. Select (▲▼) [ SLIDESHOW] and press (SET).
3. Select (◀▶) [START] and press (SET).
 - Images are played back one after another.
 - Press **FUNC.** to stop the slideshow.

Index Screen

1. **Move the zoom lever toward W.**

The stills index screen appears with the first six still images.
2. **Select (▲▼, ◀▶) an image.**
 - Move the cursor  to the image you want to view.
 - Press **+** or **-** to move to the next or previous index page.
3. **Move the zoom lever toward T.**

The index screen closes and the selected image is displayed.

Image Jump Function

You can also quickly locate a specific image without having to browse all of them one by one.

Push the multi selector (◀▶) and keep it pressed down.

Image numbers will quickly run in sequence. When you release the multi selector the image corresponding to the number selected will be displayed.

Magnifying the Image

During playback, still images can be magnified up to 5 times.



To change the operating mode, refer to *About the Operating Modes* (📖 9).

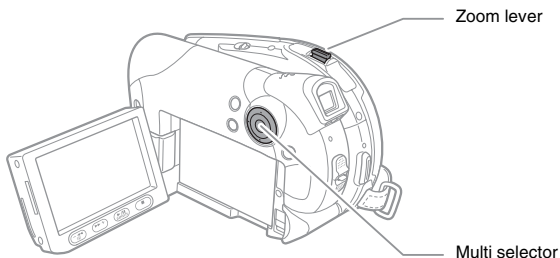

1. Move the zoom lever toward **T**.

- The image is magnified by 2 times and a frame appears indicating the position of the magnified area.
- To further enlarge the image, move the zoom lever toward **T**. To reduce the magnification to less than 2 times, move the zoom lever toward **W**.
- 🚫 will appear for images that cannot be enlarged.

2. Select the part of the image to be magnified with the multi selector.

- Move (▲▼, ◀▶) the frame to the part of the image you want to see enlarged.
- To cancel the magnification, move the zoom lever toward **W** until the frame disappears.

Selecting the Recording Data Display

The camcorder keeps a data code containing the recording date and time and other camera data such as shutter speed and exposure (f-stop).



To change the operating mode, refer to *About the Operating Modes* (□ 9).

PLAY (camera icon): [DATE], [TIME], [DATE&TIME] only.

Data Code display

You can select the data code display style on the screen.

MENU

(□ 31)



Options

[DATE]	Displays the date or time when the scene or still image was recorded.
[TIME]	
[DATE & TIME]	Displays both the date and time of the recording.
[CAMERA DATA]	Displays the exposure (f-stop) and shutter speed used when recording the image.
[CAM.& D/T]	Displays the exposure, shutter speed, date and time of the recording.

Selecting the Data Code

1. Press **MENU**.
2. Select (▲▼) [DISPLAY SETUP] and press (SET).
3. Select (▲▼) [DATA CODE] and press (SET).
4. Select (▲▼) the desired option and press (SET).
5. Press **MENU** to close the menu.



Turning the On-screen Displays On/Off

During playback, repeatedly press **DISPLAY** (▲) to turn the on-screen displays on/off in the following sequence:

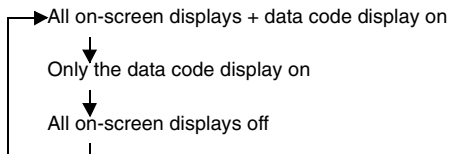

Options Lists – MENU / FUNC.

Menu items not available appear in black on the screen. For details about how to select an item, refer to *Selecting an Option - MENU/FUNC.* (□ 8).

CAMERA  only available with the **DC100**.

MENU Options

CAMERA SETUP

A.SL SHUTTER.

CAMERA 

CAMERA 

[**ON** ON], [**OFF** OFF]

The camcorder automatically uses slow shutter speeds to obtain brighter recordings in places with insufficient lighting.

- The camcorder uses shutter speeds down to 1/25 (1/12 when recording still images).
- If a trailing afterimage appears, set the slow shutter to [OFF].
- If “” (camcorder shake warning) appears, we recommend stabilizing the camcorder, for example, by mounting it on a tripod.

D.ZOOM

CAMERA 

DC100 [**OFF** OFF], [**100x** 100X], [**1000x** 1000X]

DC95 [**OFF** OFF], [**100x** 100X], [**770x** 770X]



Determines the operation of the digital zoom.



- When activated, the camcorder will switch automatically to the digital zoom when you zoom in beyond the optical zoom range.
- With the digital zoom the image is digitally processed, so the image resolution will deteriorate the more you zoom in.
- The digital zoom indicator will appear in light blue from 25x up to 100x and dark blue from 100x up to 1000x (**DC100**) / 770x (**DC95**).
- The digital zoom cannot be used with the [ NIGHT] recording program (**SCN**) or with the multi-image screen.

ZOOM SPEED

CAMERA 

CAMERA 

[**VAR** VARIABLE], [ SPEED 3], [ SPEED 2], [ SPEED 1]

- When set to [**VAR** VARIABLE] the zoom speed depends on how you operate the zoom lever: Press lightly for a slow zoom; press harder for faster zooms.
- The fastest zoom speed can be achieved with [**VAR** VARIABLE]. Among the fixed zoom speeds, [ SPEED 3] is the fastest and [ SPEED 1] the slowest.

IMG STAB

CAMERA 

[**ON** ON ()], [**OFF** OFF]

The image stabilizer compensates for camcorder shake even at full telephoto.

- The image stabilizer is designed to compensate for a normal degree of camcorder shake.
- The image stabilizer may not be effective when recording in dark places using the [ NIGHT] recording program (**SCN**).
- The image stabilizer cannot be turned off when the mode switch is set to **AUTO**.

DC100 **FOCUS PRI.** [**ON** ON], [**OFF** OFF]



The camcorder records the still image only after the focus has been adjusted.

- Set it to [**OFF** OFF] if you wish to record a still image as soon as you press **Start/Stop**. When set to [**OFF** OFF], no focusing frame appears.
- Focus priority cannot be turned off when the mode switch is set to **AUTO**.
- In the [ FIREWORKS] recording program (**SCN**) the setting is automatically set to [**OFF** OFF].

WIND SCREEN [**ON** ON ], [**OFF** OFF]

When activated, the camcorder will reduce the background sound of wind when recording outdoors.



- Set the mode switch to a position other than **AUTO**.
- Some low-frequency sounds will be suppressed along with the sound of wind. We recommend to leave the wind screen [**OFF** OFF] for most recording environments.

SELF TIMER   ( 44)[**ON** ON ], [**OFF** OFF] **STILL IMG OPER.****ERASE ALL IMAGES**  ( 57)

[NO], [YES]

 **DISC OPERATIONS****DISC INFO**    

Displays a screen where you can verify the details regarding the disc.

- The disc information includes the disc title, the disc type (DVD-R or DVD-RW), the disc specification (VIDEO mode or VR mode), and icons that indicate if the disc is finalized () or protected ().

DISC INITIALIZE     ( 55)

[VIDEO], [VR]

FINALIZE     ( 59)

[NO], [YES]

UNFINALIZE     ( 61)

[NO], [YES]

MOVIES ALL DEL  ( 53)

[NO], [YES]

This option is available only in the original index screen.

PLAYLIST ALL DEL

(📖 53)

[NO], [YES]

This option is available only in the playlist index screen.

DISC PROTECT

(📖 55)

[NO], [YES]

DC100 PHOTOMOVIE

(📖 58)

[NO], [YES]

DISC TITLE

(📖 56)

DISPLAY SETUP**BRIGHTNESS**

Adjusts the brightness of the LCD screen.

- Use the multi selector (◀▶) to adjust the brightness to your preference.
- Changing the brightness of the LCD screen does not affect that of the viewfinder or the recordings.

BACKLIGHT

(📖 17)

[☞ NORMAL], [☞ BRIGHT]

LCD MIRROR

[ON ON], [OFF OFF]

When you rotate the LCD panel 180 degrees to face the subject, the picture displayed will be a mirror image (right and left reversed) so that the image on the display will match that of the subject. All on-screen displays will also be reversed.

DATA CODE

(📖 30)

[📅 DATE], [🕒 TIME], [📅🕒 DATE & TIME], [📷 CAMERA DATA], [📷🕒 CAM. & D/T]

(📖 30)

[📅 DATE], [🕒 TIME], [📅🕒 DATE & TIME]

LEVEL MARKER

[ON ON], [OFF OFF]

A horizontal line will appear at the center of the screen. You can frame the picture by referring to the level marker.

LANGUAGE

(📖 18)

[DEUTSCH], [ENGLISH], [ESPAÑOL], [FRANÇAIS], [ITALIANO], [POLSKI],

[РУССКИЙ], [简体中文], [繁體中文], [한국어], [ភាសាខ្មែរ], [日本語]

DEMO MODE[**ON** ON], [**OFF** OFF]

The demonstration mode displays the camcorder's main features. It starts automatically when the camcorder is powered with the power adapter if you leave it turned on without loading a disc for more than 5 minutes.

- To cancel the demo mode once it started, press any button, turn off the camcorder or load a disc.

SYSTEM SETUP**STILL IMAGES**

(9)

[ON], [**OFF** OFF]**VOLUME**

(27)

**BEEP**[HIGH VOLUME], [LOW VOLUME], [**OFF** OFF]

A beep will accompany some operations like turning on the camcorder, the self-timer countdown, etc. It also serves as a warning beep under unusual conditions.

FIRMWARE

You can check the current version of the camcorder's firmware.

POWER SAVE[**ON** ON], [**OFF** OFF]

In order to save power when the camcorder is powered by a battery pack, it will automatically shut off if left without any operation for five minutes. Approximately 30 seconds before the camcorder shuts off, the message " AUTO POWER OFF" will appear.

DC100 FILE NOS.

[RESET], [CONTINUOUS]

Select the image numbering method to be used on a new disc.

Images are automatically assigned consecutive image numbers from 0101 to 9900, and stored in folders containing up to 100 images. Folders are numbered from 101 to 998.

[RESET]: Image numbering will start anew from 101-0101 every time you insert a new disc. If it already contains image files, a new image will be given the number following that of the last image on the disc.

[CONTINUOUS]: Image numbering will start from the number following that of the last image recorded with the camcorder. If the disc already contains an image with a larger image number, a new image will be given the number following that of the last image on the disc. This numbering method is useful for organizing images on a computer. We recommend using this setting.

TV TYPE

[NORMAL TV], [WIDE TV]

In order to display the picture in full and in the correct aspect ratio, select the setting according to the type of television to which you will connect the camcorder.

[NORMAL TV]: TV sets with 4:3 aspect ratio.

[WIDE TV]: TV sets with 16:9 aspect ratio.

**DATE/TIME SETUP****T.ZONE/DST**

(18)

DATE/TIME

(19)

DATE FORMAT

[Y.M.D (2006.1.1 AM 12:00)], [M.D,Y (JAN. 1, 2006 12:00 AM)], [D.M.Y (1.JAN.2006 12:00 AM)]

FUNC. Menu Options**Recording programs**

(37)

Mode switch: P

[**P** PROGRAM AE], [**Tv** SHUTTER-PRIO. AE], [**Av** APERTURE-PRIO. AE]

Mode switch: SCN

[PORTRAIT], [SPORTS], [NIGHT], [SNOW], [BEACH], [SUNSET], [SPOTLIGHT], [FIREWORKS]

DC100**Light metering mode**

(41)

Mode switch: P

[EVALUATIVE], [CENT.WEIGHT.AVERAGE], [SPOT]

White balance

(45)

Mode switch: P

[AUTO], [DAYLIGHT], [SHADE], [CLOUDY], [TUNGSTEN], [FLUORESCENT], [FLUORESCENT H], [SET]

Image effect

(47)

Mode switch: P

[IMAGE EFFECT OFF], [VIVID], [NEUTRAL], [LOW SHARPENING], [SOFT SKIN DETAIL], [CUSTOM]

Digital effects

Mode switch: P, SCN



[D.EFFECT OFF], [FADER], [EFFECT], [MULTI-S]*

* Not available while using the [NIGHT] recording program.

DC100  (48)

[ D.EFFECT OFF], [ BLK&WHT]

Recording mode







[ HIGH QUALITY], [ STANDARD PLAY], [ LONG PLAY]

- Approximate recording times with a brand new DVD-R disc are as follows:
XP: 20 minutes, SP: 30 minutes, LP: 60 minutes.
- **Recording in LP mode gives you a longer recording time; however, depending on the condition of the disc (long usage, imperfections, etc.) the picture and sound recorded in LP mode may be distorted. We recommend using the XP or SP mode for important recordings.**
- Depending on the recording mode, you might occasionally notice a brief stop of the picture or sound at the point where the scene changes.
- The camcorder uses a variable bit rate (VBR) when encoding the video data so the actual recording times will vary depending on the content of the scenes.

DC100 **Still image size/quality**

 (51)

Size: [ L 1024x768], [ S 640x480]

Quality: [ SUPER FINE], [ FINE], [ NORMAL]

Add to playlist

 (52)

[ALL SCENES], [ONE SCENE], [CANCEL]

This option is available only from the original index screen.

Move a scene

 (52)

This option is available only from the playlist index screen.

Divide a scene

 (54)

Delete a scene

 (53)

DC100 **Convert to scene**

 (58)

Image erase

  (57)

DC100  : This option will appear only when you press **FUNC.** while reviewing the still image immediately after recording it.

Slideshow

 (28)

[CANCEL], [START]

Using the Recording Programs

CAMERA · 

CAMERA ·  *

PLAY · 

PLAY · 

* **DC100** only. To change the operating mode, refer to *About the Operating Modes* (□ 9).



AUTO Auto

The camcorder adjusts focus, exposure and other settings automatically, allowing you to just point and shoot.



P **P Program AE** (□ 38)

Tv Shutter-Priority AE (□ 39)

Av Aperture-Priority AE (□ 40)

SCN

Portrait

The camcorder uses a large aperture, achieving a focus on the subject while blurring other distracting details.



Snow

Use this mode to record in bright ski resorts. It prevents the subject from being underexposed.



Spotlight

Use this mode to record spotlight scenes.



Sports

Use this mode to record sports scenes such as tennis or golf.



Beach

Use this mode to record on a sunny beach. It prevents the subject from being underexposed.



Fireworks

Use this mode to record fireworks.



Night

Use this mode to record in poorly lit places.



Sunset

Use this mode to record sunsets in vibrant colors.



Selecting the Recording Program

CAMERA · 

CAMERA ·  *

PLAY · 

PLAY · 

* **DC100** only. To change the operating mode, refer to *About the Operating Modes* (□ 9).

Move the mode switch between the recording categories.

AUTO Automatic mode

P Select [**P** PROGRAM AE], [**Tv** SHUTTER-PRIO. AE], [**Av** APERTURE-PRIO. AE]

SCN Select [**P** PORTRAIT], [**S** SPORTS], [**N** NIGHT], [**S** SNOW], [**B** BEACH],
[**S** SUNSET], [**A** SPOTLIGHT], [**F** FIREWORKS]

To select a recording program after choosing **P,SCN** :

FUNC. ⇨ Recording Program icon

FUNC. ⇩ Desired option



○ Do not change the recording program while recording as the brightness of the image may change abruptly.

○ [**P** PORTRAIT]

- The blur effect of the background increases the more you zoom in (**T**).
- The picture may not appear smooth when played back.

○ [**S** SPORTS]

- The picture may not appear smooth when played back.

○ [**S** SNOW]/[**B** BEACH]

- The subject may become overexposed on cloudy days or in shaded places. Check the image on the screen.
- The picture may not appear smooth when played back.

○ [**F** FIREWORKS]

- To avoid camcorder shake, we recommend using a tripod. **DC100** : Make sure to use a tripod especially in **CAMERA · ** , as the shutter speed slows down.

P Using the Program AE Mode

The camcorder automatically adjusts the aperture and shutter speed according to the subject to achieve the best exposure conditions. With [**P** PROGRAM AE], you can point and shoot as in **AUTO** mode, while still enjoying the option to manually adjust some settings.

CAMERA · 

CAMERA ·  *

PLAY · 

PLAY · 

* **DC100** only. To change the operating mode, refer to *About the Operating Modes* (□ 9).

Mode switch: P



Select the recording program [**P** PROGRAM AE] as described in *Selecting the Recording Program* (□ 38).





If the optimal exposure cannot be obtained, try the following actions.

- Manually adjust the exposure (📖 41).
- Change the metering method (📖 41).

Tv Using the Shutter-Priority AE Mode

You can select a shutter speed, and the camcorder automatically sets the aperture setting most appropriate for the subject. Select a high shutter speed for recording fast moving subjects, and a slow shutter speed to add a motion blur to moving objects, enhancing the feel of movement of the image.



* **DC100** only. To change the operating mode, refer to *About the Operating Modes* (📖 9).

Mode switch: P



Shutter speed guideline

	DC100	
1/6, 1/12, 1/25	1/2, 1/3, 1/6, 1/12, 1/25	For recording subjects in dark places.
1/50	1/50	For general recordings.
1/120	1/120	For recording indoor sports scenes.
1/250, 1/500, 1/1000	1/250, 1/500	For recording from within a car or train, or for recording moving subjects such as roller coasters.
1/2000	—	For recording outdoor sports such as golf or tennis on sunny days.

1. Select the recording program

[Tv SHUTTER-PRIO.AE] as described in *Selecting the Recording Program* (📖 38).



2. Press (SET).

3. Change (▲▼) the shutter speed and press (SET) to save the setting.



- The shutter speed denominator flashes when the selected shutter speed is not appropriate for the recording condition. In such case, readjust the shutter speed.
- When using a slow shutter speed in dark places, you can obtain a brighter image, but the image quality may be lower, and the autofocus may not work well.
- Do not point the camcorder directly at the sun when the shutter speed is set to 1/1000 or higher.
- The image may flicker when recording with high shutter speeds.

AvUsing the Aperture-Priority AE Mode

You can select an aperture value, and the camcorder automatically sets the shutter speed most appropriate for the subject. Use low aperture values (large aperture) to blur the background for a portrait, or high aperture values (small aperture) to achieve a broad depth of field for recording landscapes.



* **DC100** only. To change the operating mode, refer to *About the Operating Modes* (□ 9).

Mode switch: P



Aperture value guideline

[1.8], [2.0], [2.4], [2.8], [3.4], [4.0], [4.8], [5.6], [6.7], [8.0], [9.5], [11], [14], [16]

large ← aperture size → small

1. Select the recording program

[Av APERTURE-PRIO.AE] as described in *Selecting the Recording Program* (□ 38).



2. Press (SET).

3. Change (▲▼) the aperture value and press (SET) to save the setting.



- Available aperture values vary depending on the zoom position.
- The aperture value flashes when the selected aperture is not appropriate for the recording condition. In such case, readjust the aperture.

Manually Adjusting the Exposure

Adjust the exposure when a subject is underexposed (for example, when backlit subjects appear too dark in the image) or overexposed (for example, when recording subjects under very strong light and they appear too bright or glaring in the image).

CAMERA · CAMERA ·  *PLAY · PLAY · 

* **DC100** only. To change the operating mode, refer to *About the Operating Modes* (📖 9).
Mode switch: P,SCN (except for the  FIREWORKS) recording program).

1. Press **EXP** (▲).

- The exposure adjustment indicator  and the neutral value "±0" appear on the screen.
- If you operate the zoom during exposure lock, the brightness of the image may change.



2. Adjust (◀▶) the brightness of the image as required.

- The adjustment range depends on the brightness of the picture at the time you locked the exposure.
- Pressing **EXP** (▲) again will cancel the exposure lock and return the camcorder to the previous setting.

DC100 Changing the Metering Method

You can select the light metering mode.

CAMERA · CAMERA ·  *PLAY · PLAY · 



* **DC100** only. To change the operating mode, refer to *About the Operating Modes* (📖 9).
Mode switch: P

FUNC.
(📖 35)



EVALUATIVE

Options

[ EVALUATIVE]	Appropriate for standard shooting conditions, including backlit scenes. The camcorder divides the picture into several zones for light metering and evaluates complex lighting conditions for the optimal exposure of the subject.
[ CENT.WEIGHT.AVERAGE]	Averages the light metered from the entire screen, giving more weight to the subject in the center.
[ SPOT]	Meters the area within the spot AE point frame. Use this setting to adjust the exposure to match the subject in the center of the screen.

FUNC. ⇔ Metering Method icon



FUNC. ⇔ Desired option

FUNC. 

Manually Adjusting the Focus

Autofocus may not work well on the following subjects. In such case, focus manually.

Reflective surfaces



Subjects with low contrast or without vertical lines



Fast Moving Subjects



Through dirty or wet windows



Night Scenes



CAMERA · 

CAMERA ·  *

PLAY · 

PLAY · 

* **DC100** only. To change the operating mode, refer to *About the Operating Modes* (□ 9).

Mode switch: P, SCN

1. Adjust the zoom.

2. Press **FOCUS** (▼).

“MF” appears.

3. Adjust (◀▶) the focus as required until the image appears focused.

Pressing **FOCUS** (▼) again will return to autofocus.



- The camcorder will automatically return to autofocus when you set the mode switch to **AUTO**.
- Readjust the focus when you have turned off the camcorder.

Infinity Focus

Use this function when you wish to focus on faraway subjects such as mountains or fireworks.

1. Adjust the zoom.

2. Keep **FOCUS** (▼) pressed down for more than 2 seconds.

- “∞” appears.
- Pressing **FOCUS** (▼) again will return to autofocus.



If you operate the zoom or the multi selector (◀▶) during infinity focus, “∞” changes to “MF” and the camcorder returns to manual focusing mode.

DC100 **Changing the Autofocus Mode**

You can change the AF (autofocus) frame selection mode.



* **DC100** only. To change the operating mode, refer to *About the Operating Modes* (☰ 9).

Options

9 Point AiAF Mode switch: P, AUTO , SCN *	Depending on the shooting conditions, one or more AF frames out of the nine frames available are automatically selected and focused on. Four framing corners will appear on the screen when making the selection; the corners do not appear while actually recording.
Center point Mode switch: P, SCN *	The center AF frame is selected to focus. This is convenient for making sure the focus is exactly where you want it. A single focusing frame appears in the center of the screen when making the selection; the frame will appear also while actually recording.

* Except for the [🔥 FIREWORKS] recording program.

Select (◀▶) the autofocus mode.



Using the Self Timer



* **DC100** only. To change the operating mode, refer to *About the Operating Modes* (□ 9).

CAMERA (video camera icon) : Set the camcorder in record pause mode.



“” appears.

CAMERA (video camera icon) :

Press **Start/Stop**.

The camcorder starts recording after a 10-second countdown. The countdown appears on the screen.

DC100 **CAMERA** (still camera icon) :

Press **Start/Stop**, first halfway to activate the autofocus and then fully to record the still image.

The camcorder will record the still image after a 10-second countdown. The countdown appears on the screen.



Once the countdown has begun, you can also press **Start/Stop** to cancel the self timer. The self timer will be canceled if you turn off the camcorder.

Setting the White Balance

You can choose one of the preset settings to reproduce colors more accurately, or set a custom white balance to obtain the setting best suited to your specific recording conditions.

CAMERA · CAMERA ·  *PLAY · PLAY · 

* **DC100** only. To change the operating mode, refer to *About the Operating Modes* (📖 9).

Mode switch: P









FUNC.

(📖 35)

AWB

▶ AUTO

Options

[ AUTO]	Settings are automatically set by the camcorder. Use this setting for outdoor scenes.
[ DAYLIGHT]	For recording outdoors on a bright day.
[ SHADE]	For recording in shaded places.
[ CLOUDY]	For recording on a cloudy day.
[ TUNGSTEN]	For recording under tungsten and tungsten type (3-wavelength) fluorescent lighting.
[ FLUORESCENT]	For recording under warm white, cool white or warm white type (3-wavelength) fluorescent lighting.
[ FLUORESCENT H]	For recording under daylight or daylight type (3-wavelength) fluorescent lighting.
[ SET]	Use the custom white balance setting to make white subjects appear white under colored lighting.

FUNC. ⇨ White Balance icon



FUNC. ⇨ Desired option*

FUNC.







* To set the custom white balance when you select [ SET]:

1. Point the camcorder at a white object, zoom in until it fills the whole screen and press ().



Keep the camcorder zoomed at the white object until  stops flashing.

2. Press **FUNC.** to save the setting and close the menu.



○ Depending on the type of fluorescent light, optimal color balance may not be obtained with [ FLUORESCENT] or [ FLUORESCENT H]. If the color looks unnatural, adjust it using [ AUTO] or [ SET].

○ When you have set the custom white balance:

- Depending on the light source,  may keep flashing. The result will still be better than with [ AUTO].
 - Reset the white balance when the lighting condition changes.
 - Turn off the digital zoom.
- The camcorder retains the custom white balance setting even if you turn it off.

- Custom white balance may provide better results in the following cases:
 - Changing lighting conditions
 - Close-ups
 - Subjects in a single color (sky, sea or forest)
 - Under mercury lamps and certain types of fluorescent lights

Applying Image Enhancing Effects

You can record with different color saturation and contrast effects.



* **DC100** only. To change the operating mode, refer to *About the Operating Modes* (📖 9).

Mode switch: P



Options

[IMAGE EFFECT OFF]	Records with no image enhancing effects.
[VIVID]	Emphasizes the contrast and color saturation.
[NEUTRAL]	Tones down the contrast and color saturation.
[LOW SHARPENING]	Records subjects with softened outlines.
[SOFT SKIN DETAIL]	Softens the details in the skin tone area for a more complimentary appearance. To obtain the best effect, use this setting when recording a person in close-up. Note that areas similar to the skin color may lack in detail.
[CUSTOM]	Allows you to adjust the brightness, contrast, sharpness, and color depth of the image. [BRIGHTN.]: (-) Darker picture, (+) Brighter picture [CONTRAST]: (-) Flatter picture, (+) More defined light and shade [SHARPNESS]: (-) Vaguer outlines, (+) Sharper outlines [COL.DEPTH]: (-) Shallower colors, (+) Richer color tonality

FUNC. ⇨ Image Effect icon



FUNC. ⇨ Desired option*











* To set the custom image effect when you select [CUSTOM]:

1. Press () and select () the custom setting options: [BRIGHTN.], [CONTRAST], [SHARPNESS] or [COL.DEPTH].
2. Adjust () each setting as desired and then press () .
3. Press **FUNC.** to save the setting and close the menu.

Using the Digital Effects









[FADER] Faders

Begin or end scenes with a fade to or from black. You can preview the effect on the display.

 [FADE-T] (fade trigger)	 [WIPE]	 [CORNER] (corner wipe)
 [JUMP]	 [FLIP]	 [PUZZLE]
 [ZIGZAG]	 [BEAM]	 [TIDE]



[EFFECT] Effects

Add flavor to your recordings. Sound will be recorded normally. You can preview the effect on the display.

 [BLK&WHT] (black and white)	 [SEPIA]	 [ART]
 [MOSAIC]	 [BALL]	 [CUBE]
 [WAVE]	 [COLOR M.] (color mask)	 [MIRROR]

[MULTI-S] Multi-Image Screen (49)

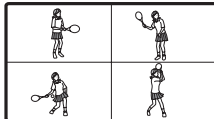
Captures moving subjects as a sequence of 4, 9 or 16 still images and displays them as one split screen. Sound will be recorded normally.

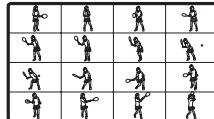
<p>4 split images</p> 	<p>9 split images</p> 	<p>16 split images</p> 
---	---	--



When you are not using the digital effect, select [ D.EFFECT OFF].

Selecting a Fader / Effect

CAMERA · 



CAMERA ·  *

PLAY · 

PLAY · 

* **DC100** only. To change the operating mode, refer to *About the Operating Modes* ( 9).

Mode switch: P, SCN

DC100  : [ BLK&WHT] only.

FUNC.

( 35)



D.EFFECT OFF

Setting

FUNC. ⇨ Digital Effects icon

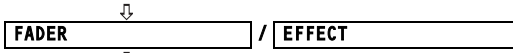

Press (SET)

Desired fader/effect.

FUNC.** ⇨ Press (SET)*

* You can preview the effect on the screen before pressing (SET).

** The selected effect icon appears.

Applying

1. Press **D.EFFECTS** to activate the fader/effect.

- To fade in, press **D.EFFECTS** before you start recording, then press **Start/Stop** to start recording.
- To fade out, press **D.EFFECTS** while recording, then press **Start/Stop** to pause the recording.



2. Press **D.EFFECTS** again to deactivate the fader/effect.



The camcorder retains the setting last used even if you turn off the digital effects or change the recording program.

Using the Multi-Image Screen

CAMERA · [MULTI-IMAGE]

CAMERA · [CAMERA]

PLAY · [MULTI-IMAGE]

PLAY · [CAMERA]

To change the operating mode, refer to *About the Operating Modes* (□ 9).

Mode switch: P, SCN (except for the [NIGHT] recording program).

FUNC.

(□ 35)



D.EFFECT OFF

Options

[S.SPEED]	Select how fast the images will be captured. [MANUAL]: One image will be added to the split screen every time you press D.EFFECTS . Hold D.EFFECTS pressed down for more than 1 second to delete images from the split screen. [FAST]: Every 4 frames [MOD.]: Every 6 frames [SLOW]: Every 8 frames
[S.SPLIT]	Select how many images in the split screen: [4], [9], [16].

Setting

FUNC. ⇨ Digital Effects icon



↓
MULTI-S

↓
Press (SET)

↓
(▲▼) **S.SPEED** (◀▶) Desired transition speed

(▲▼) **S.SPLIT** (◀▶) Desired number of images

FUNC. ⇨ Press (SET)

“” appears.

Applying

1. Press **D.EFFECTS** to capture the images.
2. Press **Start/Stop** to record the multi-image screen displayed.



DC100 Selecting the Size and Quality of Still Images

Still images are recorded on the disc using the JPEG (Joint Photographic Experts Group) compression. As a general rule select a larger image size for higher quality.



* **DC100** only. To change the operating mode, refer to *About the Operating Modes* (9).

FUNC.
(35)

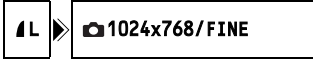

Options and number of still images that can be recorded on a disc:

Image Size	Image Quality	Number of Images	
		VIDEO Mode (DVD-R/-RW)	VR Mode (DVD-RW)
L 1024x768	[SUPER FINE]	3130	3135
	[FINE]	4530	4540
	[NORMAL]	8610	8630
S 640x480	[SUPER FINE]	7825	7845
	[FINE]	9999	(11510)*
	[NORMAL]	9999	(19185)*

* This number is the number of images that can be recorded on the disc; however, the maximum number of remaining images displayed on the screen will be 9999.

FUNC.

⇨ Image Size icon



Desired image size*



Press ()



FUNC.

⇨ Desired image quality*

FUNC.



* The number displayed on the right corner indicates the approximate number of images that can be recorded with the current quality/size setting.

Editing the Scenes (DVD-RW in VR mode only)

Creating a Playlist

Create a playlist to easily edit your movies (for example, change the order in which the scenes you recorded will be played back or edit scenes including only the best parts and cutting out the rest) without affecting your original recordings. After you add scenes to the playlist you will have two types of index screens: The original index screen (for the original recordings) and the playlist index screen.



To change the operating mode, refer to *About the Operating Modes* (□ 9).

Disc type: (RW) DVD-RW initialized in VR mode.

Adding Scenes to the Playlist

Options

[ALL SCENES]	Adds all scenes in the original index screen to the playlist.
[ONE SCENE]	Adds only the selected scene to the playlist.
[CANCEL]	Returns to the original index screen.

From the original index screen, select (▲▼, ◀▶) the scene to add to the playlist. To add all scenes there is no need to select any particular scene.

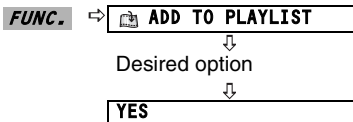

When the operation is completed "ADDED TO PLAYLIST" will be displayed. Press **PLAYLIST** to check the scenes in the playlist index screen.



Moving Scenes in the Playlist

From the original index screen, press **PLAYLIST**. From the playlist index screen, select (▲▼, ◀▶) the scene to move.

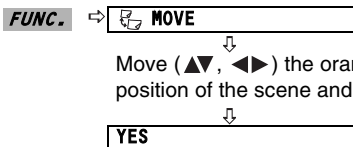

Deleting Scenes

You can delete those scenes that you are not interested in keeping. Remember that when you delete scenes in the playlist, you do not affect your original recordings; However, when you delete an original recording, it will be deleted also from the playlist.



- Be careful when deleting original recordings. Once deleted, an original scene cannot be recovered.
- Do not change the operating mode while the scene is being deleted.



- Scenes cannot be deleted when the disc is protected (🔒 55).
- You may not be able to delete scenes shorter than 5 seconds.

Deleting a Single Scene



To change the operating mode, refer to *About the Operating Modes* (📖 9).

Disc type: (RW) DVD-RW initialized in VR mode.

From the original index screen, select (▲▼, ◀▶) the scene to delete. To delete a scene only in the playlist, press **PLAYLIST** first, and then select the scene.

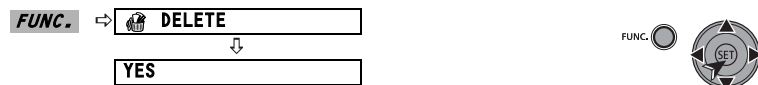

Deleting a Scene Just After Recording

As long as you have not turned the camcorder off or changed the operating mode after recording a scene, you can delete it while reviewing it.



To change the operating mode, refer to *About the Operating Modes* (📖 9).

Disc type: (RW) DVD-RW discs (VIDEO or VR mode).

1. Immediately after recording a scene, press

(⏮) (record review).



2. While reviewing the scene, select (◀▶)  and press (SET).

3. Select (◀▶) [YES] and press (SET).

Deleting All Scenes



To change the operating mode, refer to *About the Operating Modes* (📖 9).

Disc type: (RW) DVD-RW initialized in VR mode.

To delete all the scenes from the original index screen follow the procedure below. This will delete also the whole playlist. If you only want to delete all the scenes from the playlist (without affecting the original recordings), press **PLAYLIST** first and then continue as follows.

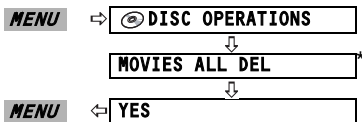

* When you are deleting the playlist, this menu option will be replaced by [PLAYLST ALL DEL].

Dividing a Scene

You can divide your recordings in order to leave only the best parts and later cut out the rest. Remember that when you divide scenes in the playlist, you do not affect your original recordings.



Photomovie scenes and scenes created by converting single still images (📖 58) cannot be divided.



To change the operating mode, refer to *About the Operating Modes* (📖 9).

Disc type: (RW) DVD-RW initialized in VR mode.

From the original index screen, select (▲▼, ◀▶) the scene to divide. To divide a scene only in the playlist, press **PLAYLIST** first, and then select the scene.

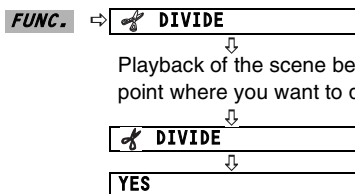

* You can use the following icons and the special playback modes (📖 26) to bring the scene to a precise point.

- ⏮/⏭: Skip to the beginning of the current/next scene.
- ⏪/⏩: One frame reverse/advance.

Disc Options

Protecting the Disc

You can protect the whole disc to prevent the accidental erasure of important recordings.



Initializing the disc (📖 55) will permanently erase all recordings, even if the disc is protected.



To change the operating mode, refer to *About the Operating Modes* (📖 9).

Disc type: (RW) DVD-RW initialized in VR mode.

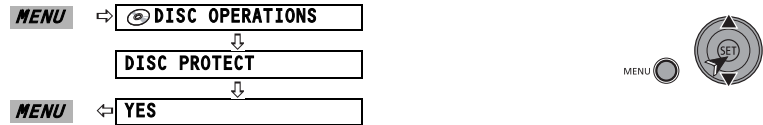

Initializing the Disc

You need to initialize a DVD-RW disc when first inserting it into the camcorder and you may have to initialize a disc if you get the “DISC ERROR” message. You can also choose to initialize the disc if you wish to erase all the recordings on the disc or in order to change the disc specification.



- **Avoid moving the camcorder while the operation is in progress.**
- Initializing the disc will permanently erase all recordings, even if the disc is protected. The lost original recordings cannot be recovered.
- The disc initialization will take approximately one minute.

Disc type: (RW) DVD-RW discs (VIDEO or VR mode).

Options

VIDEO mode	Most DVD players will play the disc, but except for the disc title, the recordings cannot be edited with the camcorder.
VR mode	You will have the option to edit the recordings with the camcorder, but the disc can only be played in VR mode-compatible DVD players and computer DVD drives.

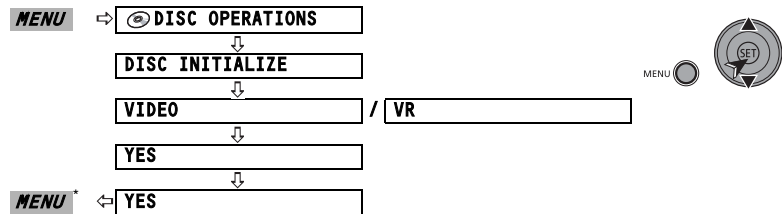

* Close the menu only after the screen display returns to the [DISC OPERATIONS] menu.

Changing the Disc Title

Before you finalize your disc, you can give it a title. The disc title will be displayed on the index screen when playing the finalized disc in most DVD players.



To change the operating mode, refer to *About the Operating Modes* (📖 9).

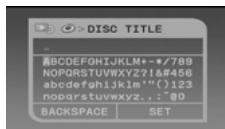
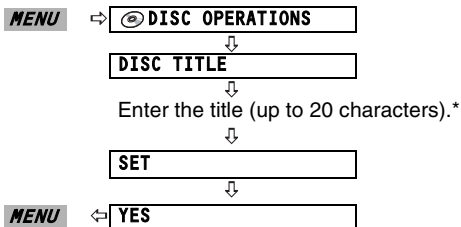

* Select one character at a time and press (SET) to add it to the title. Select [BACKSPACE] and press (SET) to delete the last character.

Erasing Still Images



Be careful when erasing images. Erased images cannot be recovered.



Still images on a protected disc cannot be erased.

Erasing a Single Image



To change the operating mode, refer to *About the Operating Modes* (□ 9).

Disc type: (RW) DVD-RW initialized in VR mode.

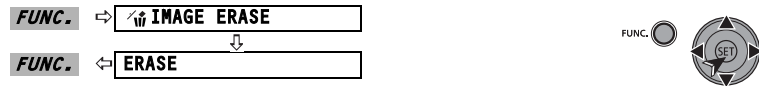

Erasing a Single Image Just After Recording

You can erase the still image you recorded last, while you are reviewing the image immediately after recording it.



* **DC100** only. To change the operating mode, refer to *About the Operating Modes* (□ 9).

Disc type: (RW) DVD-RW discs (VIDEO or VR mode).

While reviewing the image immediately after recording:

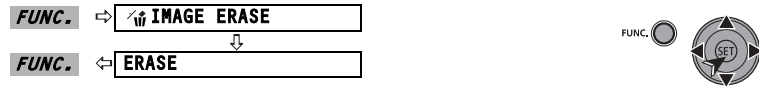

Erasing All Images



To change the operating mode, refer to *About the Operating Modes* (□ 9).

Disc type: (RW) DVD-RW initialized in VR mode.

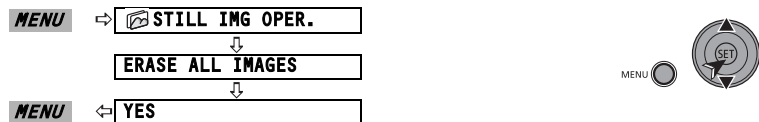

DC100 **Converting Still Images into Photomovie Scenes**

Still images are recorded using JPEG compression, but a DVD player only recognizes the MPEG standard. Thus, to play back your still images with your DVD player, first you need to create a Photomovie scene – a slide show of all still images on the disc, where each image will be displayed for approx. 3 seconds.

CAMERA · 



CAMERA · 

PLAY · 

PLAY ·  *

* **DC100** only. To change the operating mode, refer to *About the Operating Modes* ( 9).

Converting a Single Image

Select ( ) the still image you want to convert to a scene.

FUNC. ⇒  **CONVERT TO SCENE**



FUNC. ⇐ **EXECUTE**

FUNC. 



Converting All Images

MENU ⇒  **DISC OPERATIONS**



PHOTOMOVIE



MENU ⇐ **YES**

MENU 



- This function does not affect the original still images.
- If the disc becomes full while creating a Photomovie scene, the operation will be canceled.

Preparing your Disc for Playing on a DVD Player – [FINALIZE]

To play the disc you recorded on a DVD player, a computer's DVD drive or other digital device, you need to finalize it first. You do not need to finalize the disc to play back your recordings with the camcorder connected to the TV.

DC100 To view your still images on a DVD player you will need to convert them to Photomovie scenes beforehand (☐ 58).



- **Be sure to finalize the disc in normal room temperatures. If the procedure was not completed correctly due to high temperature, let the camcorder cool off before resuming operation.**
- **Place the camcorder on a table or other stable surface before starting the procedure. Subjecting the camcorder even to slight impacts (for example to place it on a table or to disconnect the AV cable) after the finalization process started may result in permanent data loss.**
- Always power the camcorder using the compact power adapter. The operation cannot be started if the camcorder is powered only with the battery pack.
- Avoid the following actions while the operation is in progress. Failing to do so can interrupt the process and result in permanent data loss.
 - Do not move the camcorder.
 - Do not disconnect the compact power adapter.
- Depending on the type of disc and the disc specification, after finalizing the disc you may not be able to initialize the disc, edit your recordings or add new recordings to the disc.
- Do not finalize with the camcorder discs that were not recorded using this camcorder.

Restrictions after Disc Finalization

	Additional Recordings	Edit Recordings	Initializing the Disc	Unfinalizing the Disc
DVD-R in VIDEO mode	–	–	–	–
DVD-RW in VIDEO mode	●*	–	●	●
DVD-RW in VR mode	●	●	●	–

* You will need to unfinalize the disc first.

Finalizing the Disc

The length of the finalization process depends on the scenes recorded and the remaining free space on the disc.

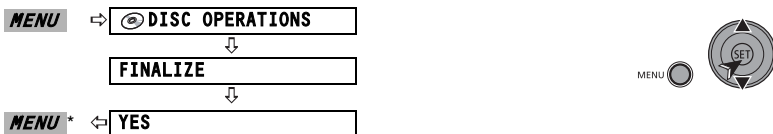

* During the disc finalization a progress bar is displayed. Close the menu only after the screen display returns to the [DISC OPERATIONS] menu.

 When using a finalized disc, the finalization mark (F) will appear next to the disc type display.

Playing Back your Disc on a DVD Player or a Computer's DVD Drive

After finalizing it, you can play the disc on DVD-R or DVD-RW compatible devices. On most DVD players look for the DVD-R/RW compatibility logo . Refer also to the instruction manual of your DVD device.

On a DVD Player

1. Turn on the TV and DVD player.
2. Insert a finalized disc in the DVD player.
3. Select the scene you want to play from the index screen.

On a Computer's DVD Drive

You need to have DVD playback software installed in your computer to play the disc.

1. Insert a finalized disc in the DVD drive.
2. Run the DVD playback software.

- Refer also to the instruction manual and help modules of your DVD playback software.
- **DC100**: To view still images recorded on the disc, close first any DVD playback software that may be running.

-  ○ DVD-RW discs recorded in VR mode can only be played on VR mode-compatible DVD players. Depending on your DVD device you may not be able to play the disc.
- **DC100**: In order to view the still images recorded on the disc in a DVD player, you have to convert individual images to scenes, or create a Photomovie scene (□ 58) before finalizing the disc. The resolution of Photomovie scenes will be lower than that of the original still images.

Recording Additional Movies on a Finalized Disc – [UNFINALIZE]

You can record additional movies after the finalization by unfinalizing an already finalized DVD-RW disc in VIDEO mode.

Disc type: (RW) DVD-RW initialized in VIDEO mode.



- Be sure to unfinalize the disc in normal room temperatures. If the procedure was not completed correctly due to high temperature, let the camcorder cool off before resuming operation.
- Place the camcorder on a table or other stable surface before starting the procedure. Subjecting the camcorder even to slight impacts (for example to place it on a table or to disconnect the AV cable) after the unfinalization process started may result in permanent data loss.
- Always power the camcorder using the compact power adapter. The operation cannot be started if the camcorder is powered only with the battery pack.
- Avoid the following actions while the operation is in progress. Failing to do so can interrupt the process and result in permanent data loss.
 - Do not move the camcorder.
 - Do not disconnect the compact power adapter.
- Only discs that were finalized using this camcorder can be unfinalized with this camcorder.

	Disc Can Be Unfinalized
DVD-R in VIDEO mode	–
DVD-RW in VIDEO mode	●
DVD-RW in VR mode	–
	You can record additional scenes even without unfinalizing the disc

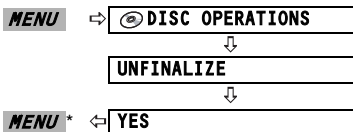

* During the disc unfinalization a progress bar is displayed. Close the menu only after the screen display returns to the [DISC OPERATIONS] menu.

Playing Back on a TV Screen

Selecting the Type of TV

CAMERA · 

CAMERA · 

PLAY · 

PLAY · 

To change the operating mode, refer to *About the Operating Modes* (□ 9).

Before connecting the camcorder, select the [TV TYPE] setting according to the TV set to which you will connect the camcorder - [WIDE TV]: TV sets with 16:9 aspect ratio or [NORMAL TV]: TV sets with 4:3 aspect ratio (□ 35).

Connection Diagram: TVs without SCART terminal

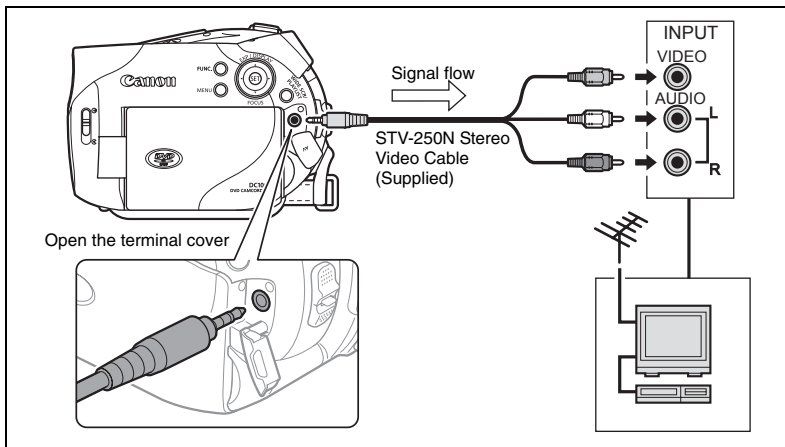

Connection Diagram: TVs with SCART terminal

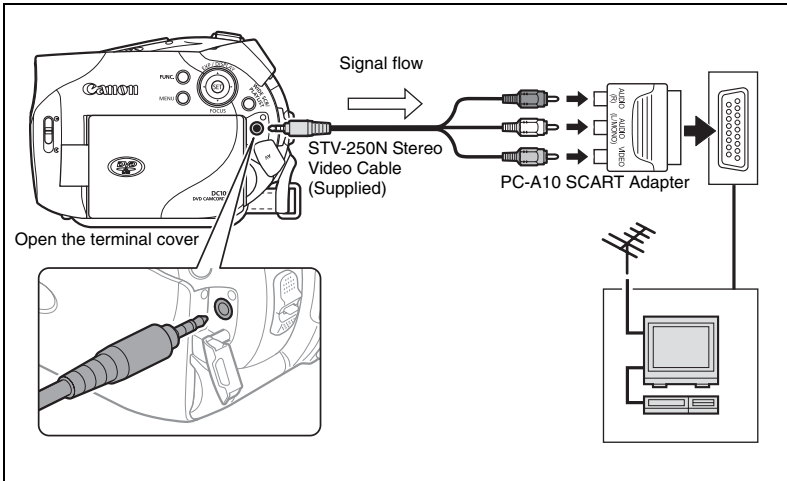

1. Turn off all devices before starting the connections.

2. Connect the STV-250N Stereo Video Cable to the camcorder's AV terminal and the terminals on the TV or VCR.

- TVs without SCART adapter: Connect the white plug to the white audio terminal L (left), the red plug to the red audio terminal R (right) and the yellow plug to the yellow VIDEO terminal.
- TVs with SCART adapter:
 - ① Insert the PC-A10 SCART Adapter to the terminal on the TV or VCR.
 - ② Connect the Stereo Video Cable to the terminals on the SCART Adapter: The white plug to the AUDIO (L) (left) terminal, the red plug to AUDIO (R) (right) terminal and the yellow plug to the VIDEO terminal.

3. On a TV: Set the input selector to VIDEO. On a VCR: Set the input selector to LINE (IN).



- We recommend powering the camcorder using the compact power adapter.
- The supplied PC-A10 SCART Adapter is for output only.

Recording to a VCR

You can copy your recordings by connecting the camcorder to a VCR or a digital video device. For a connection diagram showing how to connect the camcorder to a VCR see the previous section *Playing Back on a TV Screen* (□ 62).

CAMERA · 

CAMERA · 

PLAY · 

PLAY · 

To change the operating mode, refer to *About the Operating Modes* (□ 9).

- 1. Connected device: Load a blank cassette and set the device to record pause mode.**
- 2. This camcorder: Locate the scene you wish to copy and pause playback shortly before the scene.**
- 3. This camcorder: Resume the movie playback.**
- 4. Connected device: Begin recording when the scene you wish to copy appears. Stop recording when copying is complete.**
- 5. This camcorder: Stop playback.**



- We recommend powering the camcorder using the compact power adapter.
- By default, the on-screen displays will be embedded in the output video signal, but you can select to turn off the screen displays or select the data that will be displayed instead (□ 30).



Troubleshooting



If you have a problem with your camcorder, refer to this checklist. Consult your dealer or a Canon Service Center if the problem persists.

Power Source





Problem	Solution	
<ul style="list-style-type: none"> Camcorder will not turn on. The camcorder switches off by itself. The disc compartment cover will not open. LCD/viewfinder switches on and off. 	Battery pack is exhausted. Replace or charge the battery pack.	15
	Attach the battery pack correctly.	
Battery pack will not charge.	Charge the battery pack in temperatures between 0 °C and 40 °C.	–
	Battery packs become hot with use and may not charge. The charging will start once the battery pack temperature is below 40 °C.	–
	The battery pack is damaged. Use a different battery pack.	–

Recording/Playback





Problem	Solution	
Buttons will not work.	Turn on the camcorder.	–
	Load a disc.	20
Abnormal characters appear on the screen. The camcorder does not operate properly.	Disconnect the power source and reconnect it after a short time. If the problem still persists, disconnect the power source and press the RESET button with a pointed item. Pressing the RESET button resets all settings.	–
" 	Load a disc.	20
" 	Battery pack is exhausted. Replace or charge the battery pack.	15
Video noise appears on screen.	When using the camcorder in a room where a plasma TV is located, keep a distance between the camcorder and the plasma TV.	–
Video noise appears on the TV screen.	When using the camcorder in a room where a TV is located, keep a distance between the compact power adapter and the power or antenna cables of the TV.	–
Even without a disc loaded, when closing the disc compartment cover a motor sound can be heard.	The camcorder is checking if a disc is loaded or not. This is not a malfunction.	–
The disc cannot be ejected.	Turn off the camcorder, disconnect the compact power adapter and remove the battery pack. Restore the power supply and try again.	–
	The camcorder has exceeded its operational temperature. Disconnect the compact power adapter and remove the battery pack and let the camcorder cool down before resuming use.	
The disc cannot be recognized.	The disc is dirty. Clean the disc with a soft lens-cleaning cloth. If the problem persists replace the disc.	71
	The disc is not correctly loaded. Check the disc.	20
The camcorder vibrates.	Depending on the condition of the disc, the camcorder might vibrate occasionally. This is not a malfunction.	–

Problem	Solution	
<ul style="list-style-type: none"> The disc's rotation can be faintly heard. Occasionally the operation sound can be heard. 	The disc is activated from time to time. This is not a malfunction.	-
After using the camcorder for a long time the  lights up in red.	This is not a malfunction. Turn the camcorder off and let it cool for a while before resuming operation.	-

Recording

Problem	Solution	
Image will not appear on the screen.	Set the camcorder to  .	22
	Open the lens cover.	
"SET THE TIME ZONE, DATE AND TIME" appears on the screen.	Set the time zone, date and time.	18
	Recharge the built-in lithium battery and set the time zone, date and time.	71
Pressing the start/stop button will not start recording.	Set the camcorder to  .	22
	Load a disc.	20
	The disc is full ("  END" flashes on the screen). Delete some recordings (DVD-RW in VR mode) to free some space or replace the disc.	20 53
	The camcorder has exceeded its operational temperature. Disconnect the compact power adapter and remove the battery pack and let the camcorder cool down before resuming use.	-
	Even after stopping recording, the disc access indicator does not go off.	The scene or still image ( only) is being recorded on the disc.
The point where the start/stop button was pressed does not match the beginning/end of the recording.	There is a slight interval between pressing the start/stop button and the actual start of the recording on the disc. This is not a malfunction.	-
The recording suddenly stops shortly after starting recording.	The disc is dirty. Clean the disc with a soft lens-cleaning cloth. If the problem persists replace the disc.	71
	The camcorder has exceeded its operational temperature. Disconnect the compact power adapter and remove the battery pack and let the camcorder cool down before resuming use.	-
Camcorder will not focus.	Autofocus does not work on that subject. Focus manually.	42
	Adjust the viewfinder with the dioptic adjustment lever.	17
	Lens is dirty. Clean the lens with a soft lens-cleaning cloth. Never use tissue paper to clean the lens.	72
Sound is distorted.	When recording near loud sounds (such as fireworks or concerts), sound may become distorted. This is not a malfunction.	-
A vertical light bar appears on the screen.	Bright light in a dark scene may cause a vertical light bar (smear) to appear. This is not a malfunction.	-
Viewfinder picture is blurred.	Adjust the viewfinder with the dioptic adjustment lever.	17

Playback/Editing

Problem	Solution	
Pressing the playback button does not start playback.	Check that the disc contains recorded scenes.	–
	Load a disc.	20
	Set the camcorder to  .	26
	You may not be able to play with this camcorder discs recorded or edited with other DVD recorders or computer DVD drives.	–
	If using a single-sided disc, check that the disc is inserted with the label side facing up.	20
	The camcorder has exceeded its operational temperature. Disconnect the compact power adapter and remove the battery pack and let the camcorder cool down before resuming use.	–
During playback there is video noise, the sound is distorted or the disc cannot be read.	The disc is dirty. Clean the disc with a soft lens-cleaning cloth.	71
	You may not be able to play with the camcorder discs recorded or edited with other DVD recorders or computer DVD drives.	–
Cannot add scenes to the playlist.	The disc is full (“  END” flashes on the screen). Delete some recordings to free some space.	53
	You cannot add more than 999 scenes to the playlist.	–
Cannot divide the scene.	You cannot edit or delete scenes on a disc that was protected in another digital device.	–
Cannot edit the disc title.	You cannot add a title to a DVD-R disc after it was finalized.	59
	Unfinalize the disc first (DVD-RW in VIDEO mode).	61
	You may not be able to edit the title if you entered it with another digital device.	–
	Remove the disc protection.	55
DC100 Cannot create a Photomovie scene.	There are no still images recorded on the disc.	–
	The disc is full (“  END” flashes on the screen). Delete some recordings (DVD-RW in VR mode) to free some space.	53
Cannot edit or delete scenes.	Remove the disc protection.	55
	Scenes cannot be deleted in a DVD-R disc or a DVD-RW disc recorded in VIDEO mode.	–
	You cannot edit or delete scenes on a disc that was protected with another digital device.	–
Cannot finalize the disc.	DC100 : You cannot finalize a disc (DVD-R or DVD-RW) recorded in VIDEO mode if it contains only still images. Record at least one scene before finalizing the disc.	22 59
No sound from the built-in speaker.	Open the LCD panel.	–
	Speaker volume is turned off. Adjust the volume from the [SYSTEM SETUP] menu in  mode.	27



Playing Back the Disc in an External DVD Device

External DVD device refers to DVD players, DVD recorders, computer's DVD drives and other digital devices.

Problem	Solution	
There is a brief stop between scenes.	Depending on the DVD player, there might be a very short stop between scenes during playback.	–
Disc is running, but image will not appear on the TV screen.	TV/VIDEO selector on the TV is not set to VIDEO. Set the selector to VIDEO.	62
	You attempted to play back or dub an incompatible disc. Stop playback/dubbing.	–
The disc cannot be recognized by the device. Or, even though the disc is read, cannot play back the disc or the picture is distorted.	The disc is dirty. Clean the disc with a soft lens-cleaning cloth.	71
	The disc has not been finalized.	59
	DVD-RW discs in VR mode can only be played back with VR mode-compatible DVD players. Refer to the instruction manual of your DVD device.	–
Cannot edit my recordings or add recordings to the disc with the DVD device.	It may not be possible to edit or add recordings with an external DVD recorder on a disc recorded with this camcorder.	–
When writing on a disc in this camcorder recordings transferred from a computer, an error message appears.	The camcorder has exceeded its operational temperature. Disconnect the compact power adapter and remove the battery pack and let the camcorder cool down before resuming use.	–

List of Messages

Message	Explanation	
SET THE TIME ZONE, DATE AND TIME	You have not set the time zone, date and time. This message appears each time you turn the power on until you set the time zone, date and time.	18
CHANGE THE BATTERY PACK	Battery pack is exhausted. Replace or charge the battery pack.	15
TEMPERATURE TOO HIGH CANNOT RECORD	The camcorder has exceeded its operational temperature. Disconnect the compact power adapter and remove the battery and let the camcorder cool down before resuming use.	–
TEMPERATURE TOO HIGH CANNOT REMOVE DISC		–
CANNOT RECORD CHECK THE DISC	There is a problem with the disc. Replace the disc.	20
	This message can also appear if condensation has formed. Wait until the camcorder dries completely before resuming use.	72
	The disc's recording surface may be dirty or scratched.	–
REACHED THE MAXIMUM NUMBER OF SCENES	The maximum number of scenes has been reached. Delete some recordings (DVD-RW in VR mode) to free some space or replace the disc.	20 53
CANNOT PLAY DISC	The disc is dirty or you attempted to play back a disc type not supported (not DVD-R/RW).	–
	This message can also appear if condensation has formed. Wait until the camcorder dries completely before resuming use.	72
CANNOT EDIT DISC	There are no scenes to edit or the recording is damaged.	–
	This message can also appear if condensation has formed. Wait until the camcorder dries completely before resuming use.	72

Message	Explanation	
CANNOT DIVIDE THE SCENE	Photomovie scenes cannot be divided.	58
	You may not be able to divide very short scenes.	–
	Scenes cannot be divided when the disc already contains 999 scenes.	–
	You may not be able to further divide scenes shorter than 5 seconds that were created by dividing a previous scene.	–
DISC IS FINALIZED CANNOT RECORD	You cannot record additional scenes on a finalized DVD-R disc.	–
	You cannot record additional scenes or unfinalize a DVD-RW disc in VIDEO mode that was finalized with another digital device.	–
UNFINALIZE THE DISC	You cannot record additional scenes or convert still images to a Photomovie scene (DC100 only) on a finalized DVD-RW in VIDEO mode. Unfinalize the disc first.	61
DISC IS PROTECTED	The disc is protected. Replace the disc or remove the disc protection.	55
DISC ERROR	Initialize new DVD-RW discs before using them.	55
CANNOT READ THE DISC CHECK THE DISC	Disc could not be read. Try cleaning it or replace the disc.	71
	This message can also appear if the camcorder has exceeded its operational temperature. Disconnect the power adapter and remove the battery and let the camcorder cool down before resuming use.	–
	This message can also appear if condensation has formed. Wait until the camcorder dries completely before resuming use.	72
	The disc may not be loaded correctly. Try removing the disc and reinserting it.	20
	The disc is not initialized. Initialize the disc.	55
DISC ACCESS FAILURE CHECK THE DISC	There was an error when reading the disc or attempting to write onto it. Try cleaning the disc or replace it.	71
	This message can also appear if condensation has formed. Wait until the camcorder dries completely before resuming use.	72
	The disc may not be loaded correctly. Try removing the disc and reinserting it.	20
DISC COVER IS OPEN	Verify the disc is correctly inserted and close the disc cover.	20
NO DISC	No disc is loaded. Insert a disc.	20
	You inserted a disc recorded in a different Television System (NTSC).	–
	This message can also appear if condensation has formed. Wait until the camcorder dries completely before resuming use.	72
LOADING THE DISC	The disc is being read. Wait before you start recording.	–
AVOID MOVING THE CAMCORDER	Try not to move the camcorder while the image is being recorded.	–
UNABLE TO RECOVER DATA	Could not recover a corrupted file.	–
	This message can also appear if condensation has formed. If you suspect condensation is the reason, do not initialize the disc and wait until the camcorder dries completely before resuming use.	72
DISC FULL	The disc is full ("  END" flashes on the screen) . Delete some recordings (DVD-RW in VR mode) to free some space or replace the disc.	20 53

Handling Precautions

Camcorder

- Do not subject the camcorder to vibrations or strong impacts while the DISC access indicator is on or flashing. The data may not be correctly recorded on the disc, and the recording may be permanently lost.
- Do not touch the pick up lens.
- Do not carry the camcorder by the LCD panel or the disc cover. Be careful when closing the LCD panel.
- Do not leave the camcorder in places subject to high temperatures (like the inside of a car under direct sunlight), or high humidity.
- Do not use the camcorder near strong electric or magnetic fields such as above TVs, near plasma TVs or mobile phones.
- Do not point the lens or viewfinder at strong light sources. Do not leave the camcorder pointed at a bright subject.
- Do not use or store the camcorder in dusty or sandy places. The camcorder is not waterproof – avoid also water, mud or salt. If any of the above should get into the camcorder it may damage the camcorder and/or the lens. Be sure to close the disc compartment cover after use.
- Be careful of heat generated by lighting equipment.
- Do not disassemble the camcorder. If the camcorder does not function properly, consult qualified service personnel.
- Handle the camcorder with care. Do not subject the camcorder to shocks or vibration as this may cause damage.

Battery Pack

DANGER!

Treat the battery pack with care.

- Keep it away from fire (or it might explode).
- Do not expose the battery pack to temperature higher than 60 °C. Do not leave it near a heater or inside a car in hot weather.
- Do not try to disassemble or modify it.
- Do not drop or knock it.
- Do not get it wet.

- Charged battery packs continue to discharge naturally. Therefore, charge them on the day of use, or the day before, to ensure a full charge.
- Attach the terminal cover whenever a battery pack is not in use. Contact with metallic objects may cause a short circuit and damage the battery pack.
- Dirty terminals may cause a poor contact between the battery pack and the camcorder. Wipe the terminals with a soft cloth.
- Since storing a charged battery pack for a long time (about 1 year) can shorten its lifecycle or affect performance, we recommend to discharge the battery pack fully and to store it in a dry place at temperatures no higher than 30 °C. If you do not use the battery pack for long periods, charge and discharge it fully at least once a year. If you have more than one battery pack, perform these precautions at the same time for all battery packs.

- Although the battery pack's operating temperature range is from 0 °C to 40 °C, the optimal range is from 10 °C to 30 °C. At cold temperatures, performance will temporarily decline. Warm it in your pocket before use.
- Replace the battery pack if the usable time after full charge diminishes substantially at normal temperatures.

About the battery terminal cover

The battery terminal cover has a []-shaped hole. This is useful when you wish to differentiate between charged and uncharged battery packs.

Back side of the battery pack

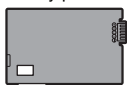

Terminal cover attached
Charged

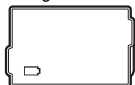

Uncharged

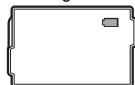

Mini DVD Disc

The recording surface of DVD discs is extremely delicate. Be sure to observe the following precautions when handling your discs.

- Keep the disc clean of dust, dirt or smudges. Even very small smudges or particles of dust can lead to problems when recording or playing back the disc. Carefully inspect the recording surface of the disc before inserting it in the camcorder. If the disc gets dirty use a dry, soft lens-cleaning cloth to remove any fingerprints, dirt buildup or smudges from the disc surface. Clean the disc in a radial motion from its center outwards.
- Never use a chemically treated cloth or flammable solvents such as paint thinner to clean the disc.
- Do not bend, scratch or wet the disc and do not subject it to strong shocks.
- Do not attach labels or stickers on the disc surfaces. The disc may not rotate in a stable manner and this may cause malfunctions.
- Return discs to their case for storage.
- When writing on the label side of the disc, avoid hard tip pens. Use waterproof soft-tipped felt pens instead.
- Moving a disc rapidly between hot and cold temperatures may cause condensation to form on its surfaces. If condensation forms on the disc, put it aside until the water droplets have evaporated completely.
- Never expose the disc to direct sunlight and do not store it in places subject to high temperatures or high humidity.
- Make sure to finalize a disc before inserting it in a DVD player, DVD recorder or a computer's DVD drive. Failing to do so can result in the loss of the recorded data.

Built-in Rechargeable Lithium Battery

The camcorder has a built-in rechargeable lithium battery to keep the date/time and other settings. The built-in lithium battery is recharged while you use the camcorder, however, it will become totally discharged if you do not use the camcorder for about 3 months.

To recharge the built-in lithium battery: Connect the compact power adapter to the camcorder and leave it connected for 24 hours with the power switch set to **OFF**.

Maintenance/Others

Storage

- If you do not intend to use the camcorder for a long time, store it in a place free of dust, in low humidity, and at temperatures not higher than 30 °C.

Cleaning

Camcorder Body

- Use a soft, dry cloth to clean the camcorder body. Never use chemically treated cloth or volatile solvents such as paint thinner.

Pick Up Lens

- Remove any dust or dirt particles using a non-aerosol type blower brush. Never touch the pick up lens directly to clean it.

Lens and Viewfinder

- If the lens surface is dirty, the autofocus may not work properly.
- Remove any dust or dirt particles using a non-aerosol type blower brush.
- Use a clean, soft lens-cleaning cloth to gently wipe the lens or viewfinder. Never use tissue paper.

LCD Screen

- Clean the LCD screen using a clean, soft lens-cleaning cloth.
- Condensation may form on the surface of the screen when the temperature changes suddenly. Wipe it with a soft dry cloth.

Condensation

Moving the camcorder rapidly between hot and cold temperatures may cause condensation (water droplets) to form on its internal surfaces. Stop using the camcorder if condensation is detected. Continued use may damage the camcorder.

Condensation may form in the following cases:

When the camcorder is moved from an air-conditioned room to a warm, humid place

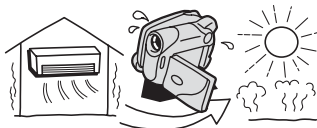

When the camcorder is moved from a cold place to a warm room

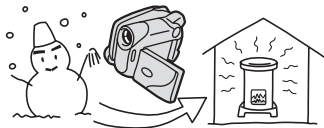

When the camcorder is left in a humid room



When a cold room is heated rapidly



How to avoid condensation:

- Do not expose the camcorder to sudden or extreme changes in temperature.
- Unload the disc, place the camcorder in an airtight plastic bag and let it adjust to temperature changes slowly before removing it from the bag.

When condensation is detected:

- The camcorder automatically shuts off. If a disc is loaded, remove the disc immediately and leave the disc cover open. Leaving the disc in the camcorder may damage it.
- A disc cannot be loaded when condensation is detected.

Resuming use:

- The precise time required for water droplets to evaporate will vary depending on the location and weather conditions. As a general criterion, wait for 2 hours before resuming use of the camcorder.

Using the Camcorder Abroad

Power Sources

You can use the compact power adapter to operate the camcorder and to charge battery packs in any country with power supply between 100 and 240 V AC, 50/60 Hz. Consult the Canon Service Center for information on plug adapters for overseas use.

Playback on a TV Screen

You can only play back your recordings on TVs compatible with the PAL system. The PAL system is used in the following countries/areas:

Algeria, Australia, Austria, Bangladesh, Belgium, Brunei, China, Denmark, Finland, Germany, Hong Kong Special Administrative Region, Iceland, India, Indonesia, Ireland, Israel, Italy, Jordan, Kenya, Kuwait, Liberia, Malaysia, Malta, Mozambique, the Netherlands, New Zealand, North Korea, Norway, Oman, Pakistan, Portugal, Qatar, Serbia and Montenegro, Sierra Leone, Singapore, South Africa, Spain, Sri Lanka, Swaziland, Sweden, Switzerland, Tanzania, Thailand, Turkey, Uganda, United Arab Emirates, United Kingdom, Yemen, Zambia.

System Diagram (Availability differs from area to area)

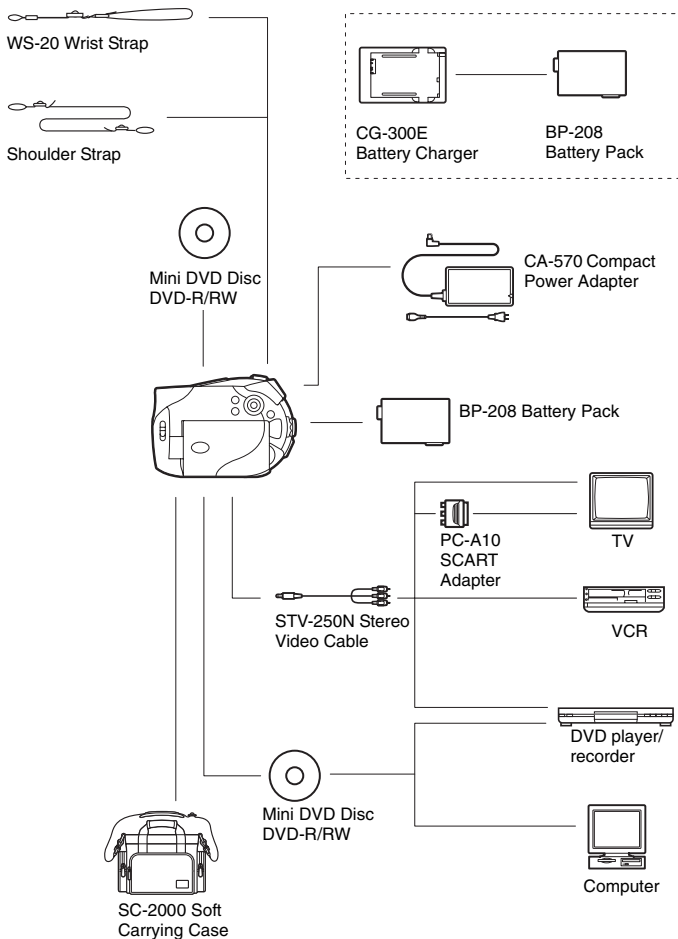

Optional Accessories

E

Use of genuine Canon accessories is recommended.

This product is designed to achieve excellent performance when used with genuine Canon accessories. Canon shall not be liable for any damage to this product and/or accidents such as fire, etc., caused by the malfunction of non-genuine Canon accessories (e.g., a leakage and/or explosion of a battery pack). Please note that this warranty does not apply to repairs arising out of the malfunction of non-genuine Canon accessories, although you may request such repairs on a chargeable basis.

Battery Packs

When you need extra battery packs, select only the BP-208 battery pack.

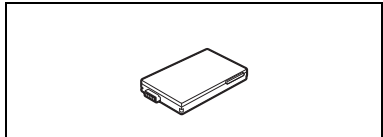

CG-300E Battery Charger

Use the battery charger for charging the battery packs.

Charging Time: 105 min.

Charging time varies according to the charging condition.

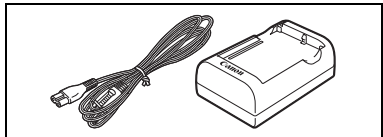

Shoulder Strap

You can attach a shoulder strap for more security and portability.

Pass the ends through the strap mount and adjust the length of the strap.

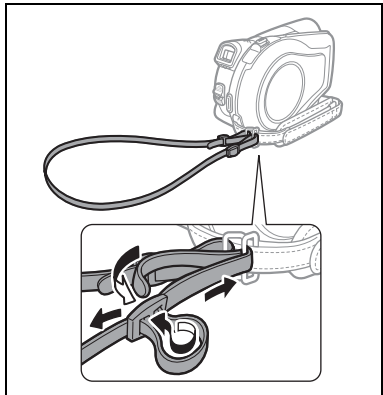

WS-20 Wrist Strap

Use this for extra additional protection for active shooting.

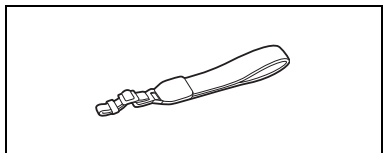

Additional Information

SC-2000 Soft Carrying Case

A handy camcorder bag with padded compartments and plenty of space for accessories.



This mark identifies genuine Canon video accessories. When you use Canon video equipment, we recommend Canon-brand accessories or products bearing the same mark.



Specifications

E

DC100/DC95

System

Disc Recording System	Video: DVD-VIDEO (VIDEO mode) DVD-VR (VR mode) only with 8 cm DVD-RW Video Compression: MPEG2 Audio Compression: Dolby Digital 2ch DC100 Still Images: Exif 2.2 compliant with JPEG compression
Television System	CCIR standard (625 lines, 50 fields) PAL color signal
Image Sensor	1/6-inch CCD, approx. 800,000 pixels Effective pixels: Movies 16:9 (Image stabilizer [ON]): approx. 470,000 16:9 (Image stabilizer [OFF]): approx. 530,000 4:3 recordings: approx. 400,000 DC100 Still images approx. 530,000
Compatible Media	8 cm mini DVD discs marked with the DVD-R or DVD-RW logo 
Maximum Recording Time (1.4 GB single-sided 8 cm Mini DVD)	XP: approx. 20 min., SP: approx. 30 min., LP: approx. 60 min.
LCD Screen	2.7 in., wide, TFT color, approx. 112,000 pixels
Viewfinder	0.3 in., TFT color, approx. 123,000 pixels
Microphone	Stereo electret condenser microphone
Lens	f=2.6-65 mm, F/1.8-4.4, 25x power zoom 35 mm equivalent: Movies 16:9 (Image stabilizer [ON]): 43.6-1,090 mm 16:9 (Image stabilizer [OFF]): 41.0-1,025 mm 4:3 recordings: 49.8-1,245 mm DC100 Still images 43.6-1,090 mm
Lens Configuration	10 elements in 8 groups
AF system	TTL autofocus, manual focusing possible
Minimum Focusing Distance	1 m; 1 cm on maximum wide angle
White Balance	Auto white balance, preset white balance (DAYLIGHT, SHADE, CLOUDY, TUNGSTEN, FLUORESCENT, FLUORESCENT H) or custom white balance
Minimum Illumination	2.0 lx ([NIGHT] recording program (SCN), Shutter speed at 1/6) 7.5 lx (Auto mode, Auto slow shutter [ON], Shutter speed at 1/25)
Recommended Illumination	More than 100 lx
Image Stabilization	Electronic

Output Terminals

AV OUT Terminal	∅ 3.5 mm minijack; Output only Video: 1 Vp-p/75 ohms unbalanced Audio: -10 dBV (47 kohm load)/3 kohm or less
------------------------	--

Power/Others

Power supply (rated)	7.4 V DC (battery pack), 8.4 V DC (compact power adapter)
Power consumption (SP mode, AF on)	3.9 W (viewfinder), 4.0 W (LCD screen [NORMAL])
Operating temperature	0 – 40 °C
Dimensions (W x H x D)	51 x 86 x 123 mm excluding protrusions
Weight (camcorder body only)	410 g

Additional Information

CA-570 Compact Power Adapter

Power supply	100 – 240 V AC, 50/60 Hz
Power consumption	17 W
Rated output	8.4 V DC, 1.5 A
Operating temperature	0 – 40 °C
Dimensions	52 x 90 x 29 mm
Weight	135 g

BP-208 Battery Pack

Battery type	Rechargeable Lithium Ion Battery
Rated voltage	7.4 V DC
Operating temperature	0 – 40 °C
Battery capacity	850 mAh
Dimensions	39 x 8 x 63 mm
Weight	40 g

Weight and dimensions are approximate. Errors and omissions excepted. Subject to change without notice.

16:9 screen ratio	23
9 Point AiAF*	43

A

Abroad, using the camcorder	73
Auto (recording program)	37
Auto slow shutter	31
Av (recording program)	40
AV OUT terminal	62

B

Battery pack, charging	15
Battery pack, remaining charge	14
Beach (SCN)	37
Beep	34

C

Condensation	72
Connection to a TV	62

D

Data code	30
Date and time	19
Daylight saving time	18
Digital effects	48
Digital zoom	31
Disc title	56
DVD discs	4
DVD-R/RW discs	4

E

Effects	48
Erasing still images	57
Error messages	68
Exposure adjustment	41

F

Faders	48
File numbers*	34
Finalizing the disc	59
Fireworks (SCN)	37
Focus priority*	32
Focusing mode	43
FUNC. menu	9, 35

G

Grip belt	17
-----------	----

I

Image enhancing effects	47
Image jump	29
Image stabilizer	31
Index screen, movies	26
Index screen, still images	28
Initialization, disc	55

L

Language	18
LCD backlight	17
LCD screen, rotating the	17
Lens cover	22, 24
LP mode	36

M

Magnifying a still image	29
Maintenance	72
MENU	8, 31
Metering method*	41
Mode switch	37
Multi selector	8
Multi-image screen	48

N

Night (SCN)	37
Normal TV	35

O

On-screen displays	30
Original recordings	52

P

P (recording program)	38
Photomovie scene*	58
Playback - Movies	26
Playback - Still images	28
Playlist	52
Portrait (SCN)	37
Power - Battery pack	15
Power - Compact power adapter	15
Power save	34
Protecting the disc	55

R

Record review	23
---------------	----

Recording - Movies	22
Recording - Still images*	24
Recording data	30
Recording mode	36
Recording programs	37
Recording reminder	13
RESET	65
Review - Movies	23

X

XP mode	36
---------	----

Z

Zoom	25
Zoom speed	31

S

Scene Editing	52
SCN - Special Scene (recording program)	37
Screen displays	13
Screen messages	68
Self timer	44
Serial number	11
Shoulder strap	75
Shutter speed	39
Slideshow	28
Snow (SCN)	37
SP mode	36
Speaker	27
Sports (SCN)	37
Spotlight (SCN)	37
Still image quality*	51
Still image size*	51
Sunset (SCN)	37

T

Telephoto	25
Time zone	18
Troubleshooting	65
Tv (recording program)	39

V

VIDEO mode (disc specification)	4
Viewfinder - Dioptic adjustment	17
Volume	27
VR mode (disc specification)	4

W

White balance	45
Wide angle	25
Wide TV (16:9)	35
Widescreen	23
Wind screen	32

Free Manuals Download Website

<http://myh66.com>

<http://usermanuals.us>

<http://www.somanuals.com>

<http://www.4manuals.cc>

<http://www.manual-lib.com>

<http://www.404manual.com>

<http://www.luxmanual.com>

<http://aubethermostatmanual.com>

Golf course search by state

<http://golfingnear.com>

Email search by domain

<http://emailbydomain.com>

Auto manuals search

<http://auto.somanuals.com>

TV manuals search

<http://tv.somanuals.com>