

# Canon

Digital Video Camcorder  
**Instruction Manual**

**English**

Caméscope Numérique  
**Manuel d'instruction**

**Français**

Videocámara digital  
**Manual de Instrucciones**

**Español**

## ZR800

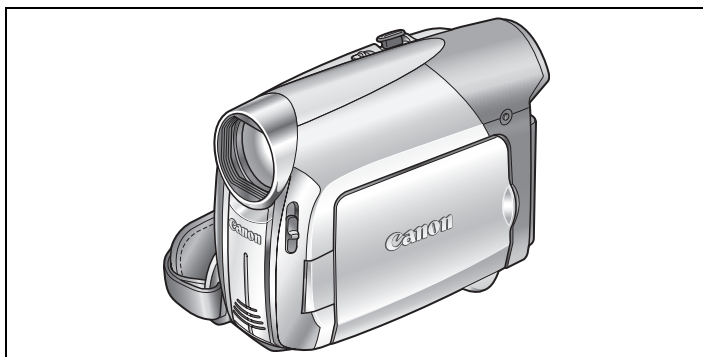

Mini **DV** Digital  
Video  
Cassette

**NTSC**

## Cleaning the Video Heads

Digital video camcorders record video signals on the tape in very thin lines (as thin as 1/8 of the width of a hair). The following symptoms may appear if the video heads become dirty even a little.

- Mosaic or other blocky video artifacts (Fig. 1) or banding (Fig. 2) appear on the picture during playback.
- Sound becomes distorted, or there is no sound during playback.
- The message "HEADS DIRTY, USE CLEANING CASSETTE" appears.



Fig. 1

If such symptoms appear, clean the video heads with the Canon DVM-CL Digital Video Head Cleaning Cassette\* or a commercially available dry cleaning cassette.

If the symptoms reappear shortly after the cleaning, the videocassette may be defective. Stop using it.

\* Availability differs from area to area.



Fig. 2

### Video heads may become dirty under the following conditions:

- When using the camcorder in humid or hot places.
- When using cassettes with damaged or dirty tape.
- When using the camcorder in dusty places.
- When using the video heads without cleaning them for a long time.

### **i** NOTES

- Before you make important recordings, clean the video heads and make a test recording first. We also recommend cleaning the video heads after use, before storing the camcorder.
- Do not use wet type cleaning cassettes as this may damage the camcorder.
- Even after cleaning the video heads you may not be able to play back correctly tapes that were recorded with dirty video heads.

# Important Usage Instructions

## WARNING!



**TO REDUCE THE RISK OF FIRE OR ELECTRIC SHOCK, DO NOT EXPOSE THIS APPARATUS TO RAIN OR MOISTURE.**

For Canada only:

**TO REDUCE THE RISK OF ELECTRIC SHOCK, DO NOT EXPOSE THIS PRODUCT TO DRIPPING OR SPLASHING.**

## WARNING!



**TO REDUCE THE RISK OF ELECTRIC SHOCK AND TO REDUCE ANNOYING INTERFERENCE, USE THE RECOMMENDED ACCESSORIES ONLY.**

## COPYRIGHT WARNING:

**Unauthorized recording of copyrighted materials may infringe on the rights of copyright owners and be contrary to copyright laws.**

Digital Video Camcorder, ZR800 A systems

This device complies with Part 15 of the FCC Rules. Operation is subject to the following two conditions: (1) This device may not cause harmful interference, and (2) this device must accept any interference received, including interference that may cause undesired operation.

Note: This equipment has been tested and found to comply with the limits for class B digital device, pursuant to Part 15 of the FCC Rules. These limits are designed to provide reasonable protection against harmful interference in a residential installation. This equipment generates, uses and can radiate radio frequency energy and, if not installed and use in accordance with the instructions, may cause harmful interference to radio communications. However, there is no guarantee that interference will not occur in a particular installation. If this equipment does cause harmful interference to radio or television reception, which can be determined by turning the equipment off and on, the user is encouraged to try to correct the interference by one or more of the following measures:

- Reorient or relocate the receiving antenna.
- Increase the separation between the equipment and receiver.
- Connect the equipment into an outlet on a circuit different from that to which the receiver is connected.
- Consult the dealer or an experienced radio/TV technician for help.

Use of shielded cable is required to comply with class B limits in Subpart B of Part 15 of FCC Rules.

Do not make any changes or modifications to the equipment unless otherwise specified in the manual.

If such changes or modifications should be made, you could be required to stop operation of the equipment.

Canon U.S.A. Inc.

One Canon Plaza, Lake Success, NY 11042, U.S.A.

Tel No. (516)328-5600

## Important Warning



The lightning flash with arrowhead symbol, within an equilateral triangle, is intended to alert the user to the presence of uninsulated "dangerous voltage" within the product's enclosure, that may be of sufficient magnitude to constitute a risk of electric shock to persons.

## CAUTION:

**TO REDUCE THE RISK OF ELECTRIC SHOCK, DO NOT REMOVE COVER (OR BACK). NO USER-SERVICEABLE PARTS INSIDE. REFER SERVICING TO QUALIFIED SERVICE PERSONNEL.**



The exclamation point, within an equilateral triangle, is intended to alert the user to the presence of important operating and maintenance (servicing) instructions in the literature accompanying the product.

# IMPORTANT SAFETY INSTRUCTIONS

In these safety instructions the word "apparatus" or "product" refers to the Canon Digital Video Camcorder ZR800 A and all its accessories.

- 1** Read these instructions.
- 2** Keep these instructions.
- 3** Heed all warnings.
- 4** Follow all instructions.
- 5** Do not use this apparatus near water.
- 6** Clean only with dry cloth.
- 7** Do not install near any heat sources such as radiators, heat registers, stoves, or other apparatus (including amplifiers) that produce heat.
- 8** Protect the power cord from being walked on or pinched particularly at plugs, convenience receptacles, and the point where they exit from the apparatus.
- 9** Unplug this apparatus during lightning storms or when unused for long periods of time.
- 10** Read instructions — All the safety and operating instructions should be read before the product is operated.
- 11** Retain instructions — The safety and operating instructions should be retained for future reference.
- 12** Heed Warnings — All warnings on the product and in the operating instructions should be adhered to.
- 13** Follow instructions — All operating and maintenance instructions should be followed.
- 14** Cleaning — Unplug this product from the wall outlet before cleaning. Do not use liquid or aerosol cleaners. The product should be cleaned only as recommended in this manual.
- 15** Avoid magnetic or electric fields — Do not use the camera close to TV transmitters, portable communication devices or other sources of electric or magnetic radiation. They may cause picture interference, or permanently damage the camera.
- 16** Water and Moisture — Hazard of electric shock — Do not use this product near water or in rainy/moist situations.
- 17** Placing or Moving — Do not place on an unstable cart, stand, tripod, bracket or table. The product may fall, causing serious injury to a child or adult, and serious damage to the product. A product and cart combination should be moved with care. Quick stops, excessive force, and uneven surfaces may cause the product and cart combination to overturn.
- 18** Power Sources — The product should be operated only from the type of power source indicated on the marking label. If you are not sure of the type of power supply to your home, consult your product dealer or local power company. Regarding other power sources such as battery power, refer to instructions in this manual.
- 19** Overloading — Do not overload wall outlets and extension cords as this can result in a risk of fire or electric shock.
- 20** Objects and Liquid Entry — Never push objects of any kind into this product through openings as they may touch dangerous voltage points or short out parts that could result in a fire or electric shock. Be careful not to spill liquid of any kind onto the product.
- 21** Servicing — Do not attempt to service this product yourself as opening or removing covers may expose you to dangerous voltage or other hazards. Refer all servicing to qualified service personnel.
- 22** Power Sources — The CA-590 Compact Power Adapter should be operated only from the type of power source indicated on the marking label. If you are not sure of the type of power supply to your home, consult your product dealer or local power company. Regarding other power sources such as battery power, refer to instructions in this manual.
- 23** Lightning — For added protection of this product during a lightning storm, or when it is left unattended and unused for long periods of time, disconnect it from the wall outlet and disconnect the antenna. This will prevent damage to the product due to lightning and power-line surges.
- 24** Overloading — Do not overload wall outlets and extension cords as this can result in a risk of fire or electric shock.

- 25** Damage Requiring Service — Disconnect this product from the wall outlet and all power sources including battery, and refer servicing to qualified service personnel under the following conditions:
- When the plug is damaged.
  - If any liquid has been spilled onto, or objects have fallen into, the product.
  - If the product has been exposed to rain or water.
  - If the product does not operate normally even if you follow the operating instructions. Adjust only those controls that are covered by the operation instructions. Improper adjustment of other controls may result in damage and will often require extensive work by a qualified technician to restore the product to its normal operation.
  - If the product has been dropped or the cabinet has been damaged.
  - When the product exhibits a distinct change in performance. This indicates a need for service.
- 26** Replacement Parts — When replacement parts are required, be sure the service technician has used replacement parts that are specified by Canon or that have the same characteristics as the original part. Unauthorized substitutions may result in fire, electric shock or other hazards.
- 27** Safety Check — Upon completion of any service or repairs to this product, ask the service technician to perform safety checks to determine that the product is in safe operating order.

When replacement of the power supply is required, please return it to the responsible nearest Canon Service Center and please replace it with the same type number CA-590.

This Class B digital apparatus complies with Canadian ICES-003.

The Mains plug is used as the disconnect device. The Mains plug shall remain readily operable to disconnect the plug in case of an accident.

The adapter can be used with a power supply between 100 and 240 V AC. For areas where 120 V AC power is not used, you will need a special plug adapter. Contact your nearest Canon Service Center for further information.  
The adapter is not intended to be serviced. Should the product cease to function in its intended manner, it should be returned to the manufacturer or be discarded.

## Table of contents

### Introduction

About this Manual .....	8
-------------------------	---

### Getting to Know the Camcorder

Supplied Accessories .....	10
Components Guide .....	11
Screen Displays .....	13

### Preparations

#### Getting Started

Charging the Battery Pack .....	15
Installing the Backup Battery .....	16
Inserting and Removing a Tape .....	17
Preparing the Camcorder .....	18
Adjusting the LCD Screen .....	18

#### Using the Menus

Selecting a FUNC. Menu Option .....	19
Selecting an Option from the Setup Menus .....	20

#### First Time Settings

Changing the Language .....	21
Changing the Time Zone .....	21
Setting the Date and Time .....	22

### Basic Functions

#### Recording

Recording Movies .....	23
Zooming .....	24

#### Playback

Playing Back Movies .....	25
Locating the End of the Last Scene .....	26
Magnifying the Playback Image .....	26

### Advanced Functions

#### Menu Options Lists

FUNC. Menu .....	27
Setup menus .....	27
Camera Setup (Digital Zoom, Image Stabilizer, etc.) .....	27
VCR Setup (Recording Mode, TV Type, etc.) .....	29
Audio Setup (Audio Mode, Wind Screen, etc.) .....	29
Display Setup (LCD Brightness, Language, etc.) .....	30
System Setup (Beep, etc.) .....	31
Date/Time Setup .....	31

#### Recording Programs

Using the Recording Programs .....	32
 Changing the Shutter Speed and Special Scene Programs .....	33

#### Adjusting the Picture: Exposure, Focus and Color

Manual Exposure Adjustment .....	34
Manual Focus Adjustment .....	35
White Balance .....	36

Image Effects.....	37
<b>Audio Recording and Playback</b>	
Audio Recording Mode.....	37
Audio Playback Modes.....	38
<b>Other Functions</b>	
Data Code.....	39
Self Timer.....	39
Digital Effects.....	40
<b>External Connections</b>	
<hr/>	
<b>Connecting to a TV or VCR</b>	
Connection Diagrams.....	42
Playback on a TV Screen.....	43
Recording to a VCR or Digital Video Recorder.....	43
Digital Video Dubbing.....	44
<b>Connecting to a Computer</b>	
PC Connection Diagrams.....	45
Transferring Video Recordings.....	46
<b>Additional Information</b>	
<hr/>	
<b>Trouble?</b>	
Troubleshooting.....	47
List of Messages.....	49
<b>Do's and Don'ts</b>	
Handling Precautions.....	51
Maintenance/Others.....	53
Using the Camcorder Abroad.....	55
<b>General Information</b>	
System Diagram.....	56
Optional Accessories.....	57
Product Codes.....	59
Specifications.....	60
Index.....	62

## About this Manual

Thank you for purchasing the Canon ZR800. Please read this manual carefully before you use the camcorder and retain it for future reference. Should your camcorder fail to operate correctly, refer to the *Troubleshooting* table (□ 47).

### Conventions Used in the Manual

- **!** IMPORTANT: Precautions related to the camcorder's operation.
- **i** NOTES: Additional topics that complement the basic operating procedures.
- **⚠** POINTS TO CHECK: Restrictions that apply if the function described is not available in all operating modes (the operating mode to which the camcorder should be set, etc.).
- □ : Reference page number.
- "Screen" refers to the LCD and the viewfinder screen.
- The photos included in the manual are simulated pictures taken with a still camera.

Menu item shown at its default position—

Buttons and switches to be operated—

Brackets [ ] and capital letters are used to refer to menu options as they are displayed on screen. Menu options in boldface indicate the default setting (for example **[ON]**, [OFF]).

Names of buttons and switches are other than the joystick indicated within a "button" frame (for example **[FUNC.]**).

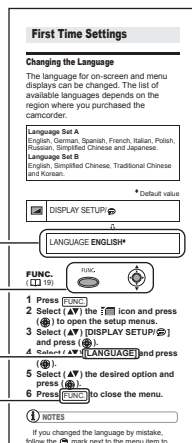

## About the Joystick and the Joystick Guide

The mini joystick allows you to control many of the camcorder's operations and to make selections and changes in the camcorder's menus.



	Push the joystick up, down, left or right (▲▼, ◀▶) to select an item or change settings.
	Press the joystick itself (⊗) to save the settings or confirm an action. On menu screens, this is indicated by the joystick icon ◀▶.



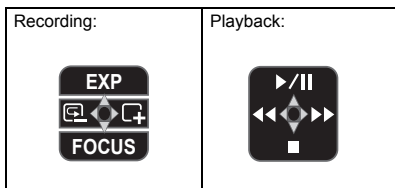



The functions assigned to the joystick change according to the operation mode. You can display the joystick guide to remind you of the joystick's functions in each operating mode.



## About the Operating Modes



The camcorder's operating mode is determined by the position of the **POWER** switch. In the manual,  indicates that a function is available in the operating mode shown and  indicates that the function is not available. When no operating mode icons are given, the function is available in all operating modes.

Operating Mode	POWER Switch	Icon Display	Operation	
	CAMERA		Recording movies on a tape	23
	PLAY		Playing movies from a tape	25

## Trademark Acknowledgements

- <sup>Mini</sup> DV is a trademark.
- Windows<sup>®</sup> is a registered trademark of Microsoft Corporation in the United States and/or other countries.
- Macintosh and Mac OS are trademarks of Apple Computer, Inc., registered in the United States and other countries.
- Other names and products not mentioned above may be trademarks or registered trademarks of their respective companies.

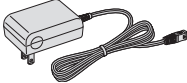
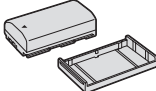
## Supplied Accessories

<p>CA-590 Compact Power Adapter</p> 	<p>BP-2L5 Battery Pack</p> 	<p>Lithium Button Battery CR1616</p> 	<p>STV-250N Stereo Video Cable</p> 
--	--	--	--

### Online product registration for U.S.A. Customers only.

Register your product online at [www.registercanon.com](http://www.registercanon.com)

#### ✓ Protect your product

We will keep the model number and date of purchase of your new Canon product on file to help you refer to this information in the event of an insurance claim such as loss or theft.

#### ✓ Receive information on new products and promotions

Upon your request, we will send you information on Canon new products and promotions.

The serial number of this product can be found at the battery attachment unit of the camcorder. Write down the number and other information here and retain this book as a permanent record of your purchase to aid identification in case of theft.

Date of Purchase:

Model Name: ZR800 A

Purchased From:

Serial No.:

Dealer Address:

Dealer Phone No.:

## Components Guide

### Left side view

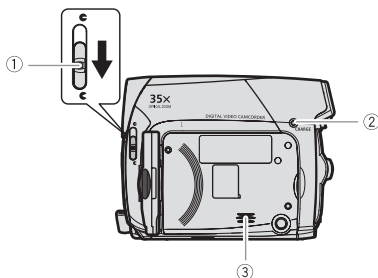

### Right Side View

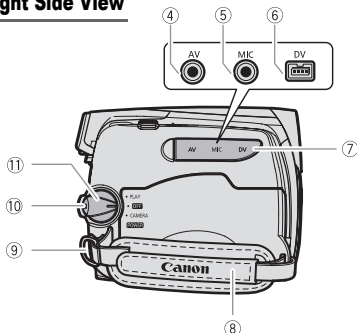

### Front view

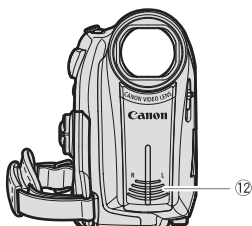

- ① Lens cover switch (□ 23)  
(☞ open, ☹ closed)
- ② CHARGE indicator (□ 15)
- ③ Speaker
- ④ AV terminal (□ 42)
- ⑤ MIC (microphone) terminal (□ 38)
- ⑥ DV terminal (□ 42, 45)
- ⑦ Terminal cover
- ⑧ Grip belt (□ 18)
- ⑨ Strap mount (□ 58)
- ⑩ Lock button
- ⑪ **POWER** switch (□ 9)
- ⑫ Stereo microphone

Names of buttons and switches other than the joystick are indicated within a "button" frame (for example **FUNC.**).

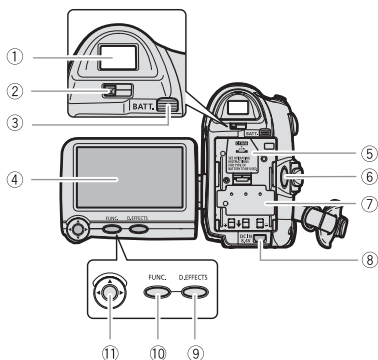
**Back view**

- ① Viewfinder (□□ 18)
- ② Dioptic adjustment lever (□□ 18)
- ③ BATT. (battery release) switch (□□ 15)
- ④ LCD screen (□□ 18)
- ⑤ Backup battery compartment (□□ 16)
- ⑥ Start/stop button (□□ 23)
- ⑦ Serial number, Battery attachment unit (□□ 15)
- ⑧ DC IN terminal (□□ 15)
- ⑨ D.EFFECTS button (□□ 40)
- ⑩ FUNC. button (□□ 19, 27)
- ⑪ Joystick (□□ 8)
- ⑫ Zoom lever (□□ 24)
- ⑬ Mode switch (□□ 32)

**EASY** Easy recording

**P** Recording programs

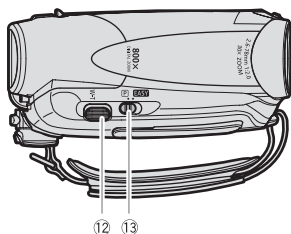
**Top view**

- ⑭ Cassette compartment (□□ 17)
- ⑮ OPEN/EJECT ▲ switch (□□ 17)
- ⑯ Cassette compartment cover (□□ 17)
- ⑰ Tripod socket (□□ 24)

Names of buttons and switches other than the joystick are indicated within a "button" frame (for example [FUNC.]).

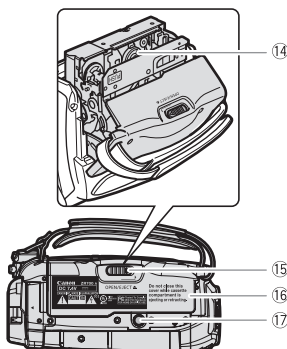
**Bottom view**





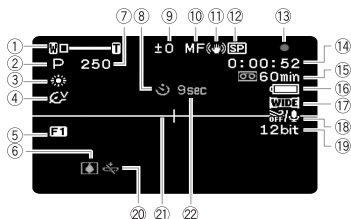

















## Screen Displays

### CAMERA Recording



### PLAY Playback





- ① Zoom () 24, Exposure  (  34 )
- ② Recording program (  32 )
- ③ White balance (  36 )
- ④ Image effect (  37 )
- ⑤ Digital effects (  40 )
- ⑥ Condensation warning (  54 )
- ⑦ Shutter speed (  33 )
- ⑧ Self timer (  39 )
- ⑨ Exposure adjustment (  34 )
- ⑩ Manual focus (  35 )
- ⑪ Image stabilizer (  28 )
- ⑫ Recording mode (  29 )
- ⑬ Tape operation
- ⑭ Time code (hours : minutes : seconds)
- ⑮ Remaining tape
- ⑯ Remaining battery charge
- ⑰ Widescreen 16:9 mode (  28 )
- ⑱ Wind screen off (  29 )
- ⑲ Audio recording mode (  37 )
- ⑳ Backup battery warning
- ㉑ Level marker (  30 )
- ㉒ Recording reminder
- ㉓ Operating mode (  9 )
- ㉔ Audio playback mode (  38 )
- ㉕ Search function display  
END SEARCH (  26 )
- ㉖ Playback time  
(hours : minutes : seconds : frames)
- ㉗ Joystick guide (  8 )
- ㉘ Data code (  39 )

**13 Tape operation**



- Record, ● || Record pause,
- Stop, ▲ Eject,
- ▶▶ Fast forward, ◀◀ Rewind,
- ▶ Playback, ▶ || Playback pause,
- ▶▶ Fast forward playback,
- ◀◀ Rewind playback

**15 Remaining tape**

Indicates the remaining time of the tape in minutes. “” moves during recording. When the tape reaches its end, the display changes to “ END”.

- When the time left is less than 15 seconds, the remaining tape time may not appear.
- Depending on the type of tape, the remaining time displayed may not be correct. In any case, you will be able to record on the tape the number of minutes that appears on the videocassette’s label (for example, 85 minutes).

**16 Remaining battery charge**

- When “” starts flashing in red replace the battery pack with a fully charged one.
- When you attach an empty battery pack, the power may turn off without displaying “”.
- Depending on the conditions under which the camcorder and the battery pack are used, the actual battery charge may not be indicated accurately.

**20 Backup battery warning**

 flashes in red when the lithium button battery is not installed, or when it needs to be replaced.

**22 Recording reminder**

The camcorder counts from 1 to 10 seconds when you start recording. This is helpful to avoid scenes that are too short.

## Getting Started

### Charging the Battery Pack

The camcorder can be powered with a battery pack or directly using the compact power adapter. Charge the battery pack before use.

Remove the battery terminal cover before attaching the battery

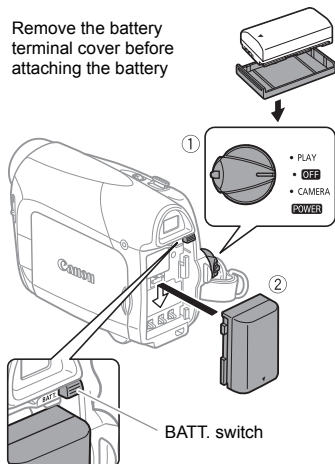

- 1 Turn off the camcorder.
- 2 Attach the battery pack to the camcorder.

- Press the battery pack lightly and slide it down until it clicks.

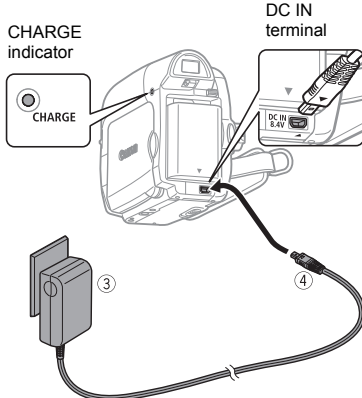

- 3 Plug the compact power adapter into a power outlet.
- 4 Connect the compact power adapter to the camcorder's DC IN terminal.

### Charging, Recording and Playback Times

The times given in the table below are approximate and vary depending on the actual charging, recording or playback conditions.

Battery Pack	BP-2L5	NB-2L	NB-2LH	BP-2L12	BP-2L14
Charging Time	145 min.	150 min.	160 min.	240 min.	285 min.
<b>Maximum Recording Times</b>					
Viewfinder	105 min.	120 min.	145 min.	250 min.	305 min.
LCD [NORMAL]	100 min.	120 min.	145 min.	245 min.	300 min.
LCD [BRIGHT]	95 min.	110 min.	135 min.	230 min.	280 min.
<b>Typical Recording Times*</b>					
Viewfinder	60 min.	65 min.	80 min.	135 min.	165 min.
LCD [NORMAL]	55 min.	65 min.	80 min.	130 min.	165 min.
LCD [BRIGHT]	50 min.	60 min.	75 min.	125 min.	155 min.
<b>Playback Times</b>	110 min.	125 min.	150 min.	265 min.	320 min.

\* Approximate times for recording with repeated operations such as start/stop, zooming, power on/off.

- The CHARGE indicator starts flashing. The indicator will stay on when the charging is completed.
- You can also use the compact power adapter without attaching a battery pack.
- When the compact power adapter is connected, even if a battery is attached its power will not be consumed.

#### ONCE THE BATTERY IS FULLY CHARGED

- 1 Disconnect the compact power adapter from the camcorder.**
- 2 Unplug the compact power adapter from the power outlet.**

#### TO REMOVE THE BATTERY PACK

Press **BATT.** to release the battery pack. Lift the battery pack and then pull it out.

#### ! IMPORTANT

- You may hear some noise from the compact power adapter during use. This is not a malfunction.
- We recommend charging the battery pack in temperatures between 10 °C and 30 °C (50 °F and 86 °F). Outside the temperature range of 0 °C to 40 °C (32 °F to 104 °F), the charging will not start.
- Do not connect to the camcorder's DC IN terminal or to the compact power adapter any electrical equipment that is not expressly recommended for use with this camcorder.
- To prevent equipment breakdowns and excessive heating, do not connect the supplied compact power adapter to voltage converters for overseas travels or special power sources such as those on aircraft and ships, DC-AC inverters, etc.

#### i NOTES

- The CHARGE indicator also serves as a rough estimate of the battery charge status. Continuously on: Battery fully charged. Flashes approx. twice per second: Battery over 50% charged.

Flashes approx. once per second: Battery less than 50% charged.

- The charging time will vary depending on the surrounding temperature and the battery pack's initial charge condition. In cold places, the effective usage time of the battery will decrease.
- We recommend that you prepare battery packs 2 to 3 times longer than you think you might need.
- **U.S.A. and Canada only:** The lithium ion/polymer battery that powers this product is recyclable. Please call 1-800-8-BATTERY for information on how to recycle this battery.



## Installing the Backup Battery

The backup battery (lithium button battery CR1616) allows the camcorder to retain the date, time (□□ 21) and other camcorder settings while the power source is disconnected. Connect a power source to the camcorder when replacing the backup battery to retain the settings.

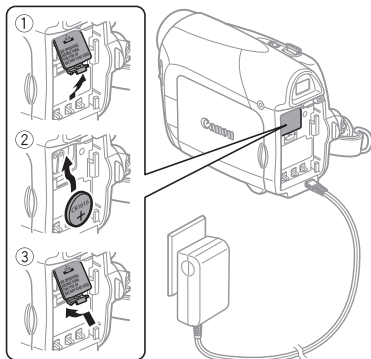

- 1 If a battery pack is attached, remove it first.**
- 2 Open the backup battery cover.**



**3 Insert the backup battery with the + side facing out.**

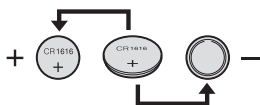

**4 Close the cover.**

**i NOTES**

The backup battery has a life span of about a year. flashes in red to inform you that it needs to be replaced.

• To remove a cassette pull it straight out.

**3 Press the **PUSH** mark on the cassette compartment until it clicks.**

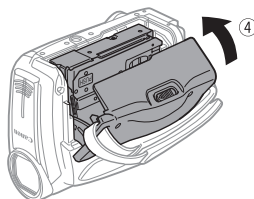

**4 Wait for the cassette compartment to retract automatically and close the cassette compartment cover.**

**! IMPORTANT**

- Do not interfere with the cassette compartment while it is opening or closing automatically, or attempt to close the cover before the cassette compartment has fully retracted.
- Be careful not to get your fingers caught in the cassette compartment cover.

**i NOTES**

If the camcorder is connected to a power source, cassettes can be inserted/removed even if the **POWER** switch is set to **OFF**.

**Inserting and Removing a Tape**

Use only videocassettes marked with the Mini **DX** logo.

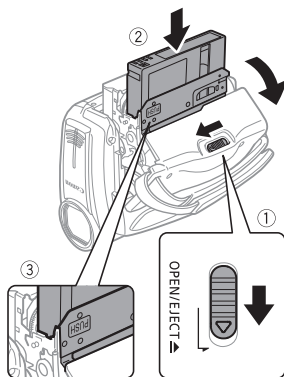

**1 Slide **OPEN/EJECT** fully in the direction of the arrow and open the cassette compartment cover.**

The cassette compartment opens automatically.

**2 Insert the cassette.**

- Insert the cassette with the window facing the grip belt.

## Preparing the Camcorder

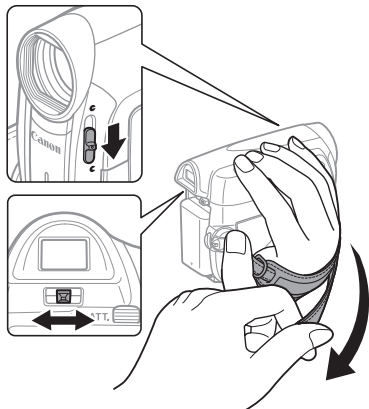

- 1 Turn on the camcorder.**
- 2 Move the lens cover switch down to  to open the lens cover.**
- 3 Adjust the viewfinder.**  
Keep the LCD panel closed to use the viewfinder and adjust the dioptic adjustment lever as necessary.
- 4 Fasten the grip belt.**  
Adjust the grip belt so that you can reach the zoom lever with your index finger, and the start/stop button with your thumb.

## Adjusting the LCD Screen

### Rotating the LCD Panel

**Open the LCD panel 90 degrees.**  
You can rotate the panel 90 degrees downward.

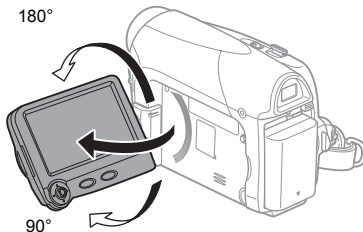

You can rotate the panel 180 degrees toward the lens (allowing the subject to monitor the LCD screen while you use the viewfinder). Rotating the panel 180 degrees is also useful if you wish to include yourself when recording with the self timer.

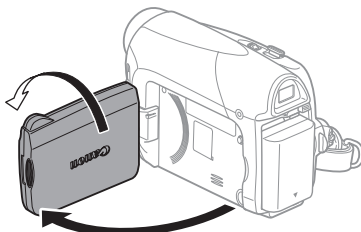

Subject can monitor the LCD screen

## LCD Backlight

You can set the brightness of the LCD screen at normal or bright.

**FUNC.**  
( [ ] 19)



- 1 Press **FUNC.**
- 2 Select (▲▼) the icon and press (⊙) to open the setup menus.
- 3 Select (▲▼) [ DISPLAY SETUP/ ] and press (⊙).
- 4 Select (▲▼) [BACKLIGHT] and press (⊙).
- 5 Select (▲▼) the desired option and press (⊙).
- 6 Press **FUNC.** to close the menu.

### **i** NOTES

- This setting does not affect the brightness of the recording or the viewfinder screen.
- Using the [BRIGHT] setting will shorten the effective usage time of the battery pack.

## Using the Menu

Many of the camcorder's functions can be adjusted from the menus that open after pressing the FUNC. button (FUNC.). For details about the available menu options and settings, refer to *Menu Options Lists* ( [ ] 27).

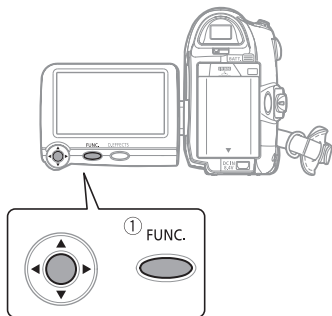

### Selecting a FUNC. Menu Option



- 1 Press **FUNC.**
- 2 Select (▲▼) the icon of the function you want to change from the left side column.
- 3 Select (◀▶) the desired setting from the available options at the bottom bar.





The selected option will be highlighted in light blue. Menu items not available will appear grayed out.

#### 4 Press **[FUNC.]** to save the settings and close the menu.

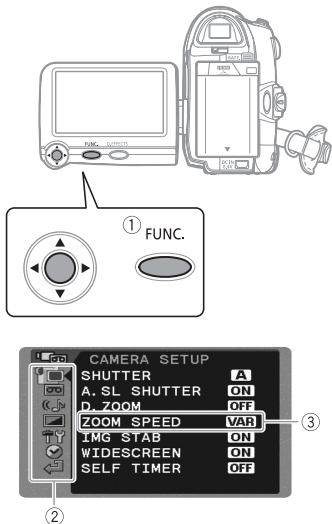
- You can press **[FUNC.]** to close the menu at any time.
- With some settings you will need to press (  ) and make further selections. Follow the additional operation guides that will appear on the screen (such as the joystick icon , small arrows, etc.).

### Selecting an Option from the Setup Menus





- 1 Press **[FUNC.]**.
- 2 Select (  ) the  icon and press (  ) to open the setup menu.  
You can also hold **[FUNC.]** pressed down for more than 2 seconds to open directly the setup menu screen.
- 3 Select (  ) the desired menu from the left side column and press (  ).

The title of the selected menu appears on top of the screen and under it the list of settings.

#### 4 Select ( ) the setting you want to change and press ( ).

- An orange frame will indicate the menu item currently selected. Menu items not available will appear grayed out.

- To return to the menu selection screen, select (  ) [  RETURN ] and press (  ).

#### 5 Select ( ) the desired option and press ( ) to save the setting.

#### 6 Press **[FUNC.]**.

You can press **[FUNC.]** to close the menu at any time.

## First Time Settings

### Changing the Language

The language for on-screen and menu displays can be changed. The list of available languages depends on the region where you purchased the camcorder.

#### Language Set A

English, German, Spanish, French, Italian, Polish, Russian, Simplified Chinese and Japanese.

#### Language Set B

English, Simplified Chinese, Traditional Chinese and Korean.

◆ Default value

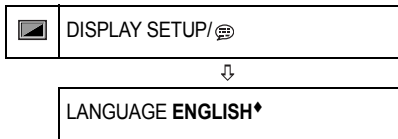

**FUNC.**  
( [ ] 19 )

FUNC.



- 1 Press **FUNC.**
- 2 Select (▲▼) the icon and press (⊗) to open the setup menus.
- 3 Select (▲▼) [DISPLAY SETUP/☎] and press (⊗).
- 4 Select (▲▼) [LANGUAGE] and press (⊗).
- 5 Select (▲▼) the desired option and press (⊗).
- 6 Press **FUNC.** to close the menu.

#### **i** NOTES

- If you changed the language by mistake, follow the ☎ mark next to the menu item to change the setting.

### Changing the Time Zone

◆ Default value

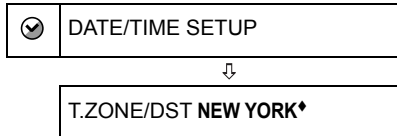

**FUNC.**  
( [ ] 19 )

FUNC.



- 1 Press **FUNC.**
- 2 Select (▲▼) the icon and press (⊗) to open the setup menus.
- 3 Select (▲▼) [DATE/TIME SETUP] and press (⊗).
- 4 Select (▲▼) [T.ZONE/DST] and press (⊗).  
The time zone setting appears. The default setting is New York or Singapore, depending on the region of purchase.
- 5 Select (▲▼) your time zone and press (⊗).  
To adjust for daylight saving time, select the time zone with the \* mark next to the area.
- 6 Press **FUNC.** to close the menu.

#### Time Zones

Once you have set the time zone, date and time, you do not need to reset the clock every time you travel to another time zone. Select the time zone referring to the date and time displayed on the screen.

## Setting the Date and Time



DATE/TIME JAN. 1, 2007 12:00 AM

### FUNC.

( 19)

FUNC.



- 1 Press **FUNC.**
- 2 Select () the icon and press () to open the setup menus.
- 3 Select () **[DATE/TIME SETUP]** and press ()
- 4 Select () **[DATE/TIME]** and press ()  
Blinking arrows will be displayed around the first field of the date.
- 5 Change each field of the date and time with the joystick's () and move () to the next field.
- 6 Press () to start the clock.
- 7 Press **FUNC.** to close the menu.

### NOTES

You can also change the date format ( 31).

## Recording

### Recording Movies

#### Before You Begin Recording

Make a test recording first to check if the camcorder operates correctly. If necessary, clean the video heads ( 2 ).

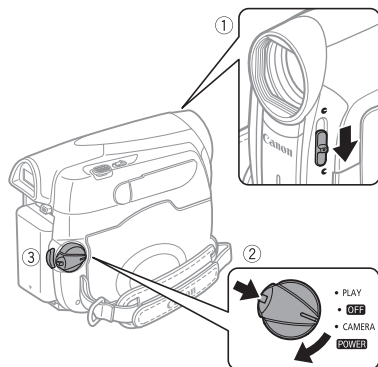

- 1 Move the lens cover switch down to to open the lens cover.
- 2 Holding the lock button pressed down, set the **POWER** switch to **CAMERA**.
- 3 Press **Start/Stop** to begin recording. Press **Start/Stop** again to pause the recording.

### TO REVIEW THE LAST SCENE RECORDED

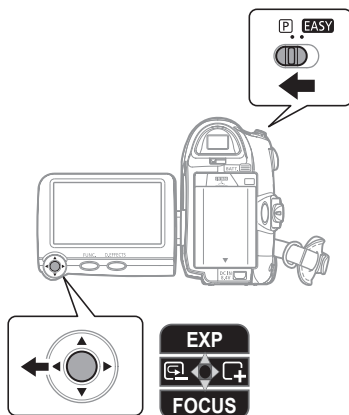

- 1 Set the mode switch to **P**.
- 2 If the joystick guide does not appear on screen, press to display it.
- 3 Push the joystick () momentarily towards and release it.
  - The camcorder will play back a few seconds of the last recording made and return to record pause mode.
  - You can also hold the joystick pressed () towards or () towards to play back the tape (reverse or forward respectively) to locate the point where you want to start recording.

#### WHEN YOU HAVE FINISHED RECORDING

- 1 Close the lens cover and the LCD panel.
- 2 Turn off the camcorder.
- 3 Remove the tape.
- 4 Disconnect the power source and remove the battery pack.

#### NOTES

- **About the recording time:** By changing the recording mode you can change the video

quality and as a result, also the available recording time (□ 29).

- Previous recordings overwritten by a new recording cannot be recovered. Before you start recording, search for the end of the last recording (□ 26).

- To protect the tape and video heads, the camcorder will enter the stop mode (■) if left in record pause (● ||) mode for 4 minutes 30 seconds. To resume recording press **Start/Stop**.

- When recording in very loud places (such as fireworks shows or concerts), sound may become distorted or it may not be recorded at the actual levels. This is not a malfunction.

- **About the Power Save mode:** To save power when the camcorder is powered by a battery pack, the camcorder will automatically shut off if left without any operations for 5 minutes (□ 31). To restore the power, turn the camcorder off and then on again.

- **About the LCD and viewfinder screen:** The screens are produced using extremely high-precision manufacturing techniques, with more than 99.99% of the pixels operating to specification. Less than 0.01% of the pixels may occasionally misfire or appear as black, red, blue or green dots. This has no effect on the recorded image and does not constitute a malfunction.

- **When using a tripod:** Do not leave the viewfinder exposed to direct sunlight as it may melt (due to concentration of the light by the lens). Do not use tripods with fastening screws longer than 5.5 mm (0.2 inch). Doing so may damage the camcorder.

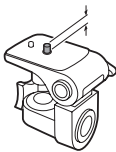

- **When recording movies, try to get a calm, stable picture.**

Excessive camcorder movement while shooting and extensive use of fast zooms and panning can result in fidgety, jittery scenes. In extreme cases the playback of such scenes may result in visually induced motion sickness. If you experience such a reaction, immediately stop the playback and take a rest break as necessary.

## Zooming

### POINTS TO CHECK



**CAMERA**: In addition to the 35x optical zoom, the digital zoom (up to 1000x) is also available (□ 28).

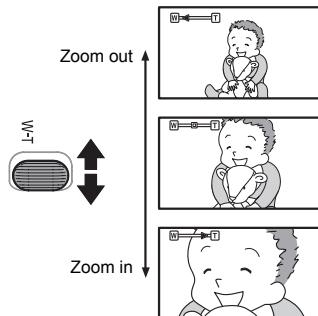

## 35x Optical Zoom

**Move the zoom lever toward W to zoom out (wide-angle). Move it toward T to zoom in (telephoto).**

You can also change the zoom speed (□ 28). You can select one of three fixed zoom speeds or a variable speed that depends on how you operate the zoom lever: Press gently for a slow zoom; press harder for faster zooms.

### NOTES

- When set to [VARIABLE], the zoom speed will be faster in the record pause mode.
- Keep at least 1 m (3.3 ft.) to the subject. At wide-angle, you can focus on a subject as close as 1 cm (0.39 in.).



## Playback

### Playing Back Movies

Play back the tape on the LCD display or close the LCD panel to use the viewfinder. You can also turn the LCD panel and close it with the screen facing out.



( 9 )

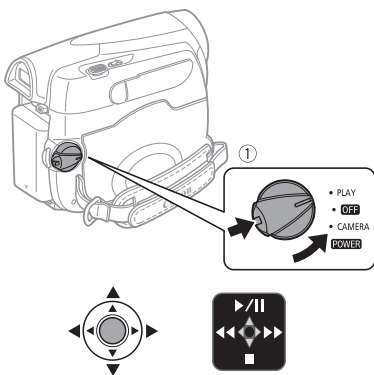

- 1 Holding the lock button pressed down, set the **POWER** switch to **PLAY**.
- 2 If the joystick guide does not appear on screen, press ( ) to display it.
- 3 Locate the point where you want to begin the playback.  
Push the joystick ( ) towards to rewind the tape or ( ) towards to fast forward.
- 4 Push the joystick ( ) towards to begin the playback.

### DURING PLAYBACK

- 5 Push the joystick ( ) towards again to pause the playback.
- 6 Push the joystick ( ) towards to stop the playback.

### TO ADJUST THE VOLUME

- 1 Press **[FUNC.]**.
- 2 Select ( ) **[ ] SPEAKER VOLUME** and adjust ( ) the volume.
  - The sound from the built-in speaker will be muted when you close the LCD panel or while the STV-250N Stereo Video Cable is connected to the AV terminal.
  - If you turn off the volume completely, the icon will change to .
- 3 Press **[FUNC.]** to close the menu.

### SPECIAL PLAYBACK MODES

There is no sound during the special playback modes.

- **Fast Playback:** Push the joystick ( ) towards or ( ) towards . Hold the joystick pressed down to rewind/fast forward the tape while continuing the playback.

### NOTES

- You can display the date and time of the recording ( 39 ).
- During some special playback modes, you may notice some video problems (blocky video artifacts, banding, etc.) in the playback picture.
- To protect the tape and video heads, the camcorder will enter the stop mode ( ) if left in playback pause ( ) mode for 4 minutes 30 seconds. To resume the playback push the joystick ( ) towards .

## Locating the End of the Last Scene

After playing back a tape, use this function to locate the end of the last scene recorded in order to continue recording from that point.

### POINTS TO CHECK



Stop the playback before using this function.

**FUNC.**  
( 19)

FUNC.



- 1 Press **FUNC.**.
- 2 Select (**▲▼**) [**→| END SEARCH**] and press (**⊗**).
- 3 Select (**◀▶**) [**EXECUTE**] and press (**⊗**).
  - "END SEARCH" appears.
  - The camcorder rewinds/fast forwards the tape, plays back the last few seconds of the recording and stops the tape.
  - To cancel the search push the joystick (**▼**) towards **■**.

### NOTES

- End search cannot be used once you remove the cassette.
- If there are blank sections between recordings, the end search may not work correctly.

## Magnifying the Playback Image

During playback, movies and still images can be magnified up to 5 times. You can also select the area to be magnified.

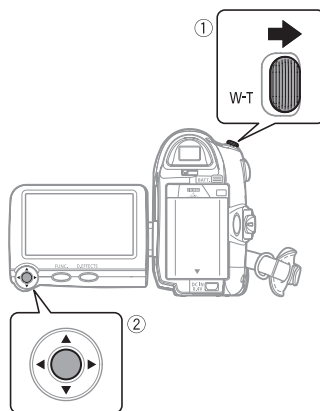

- 1 **Move the zoom lever toward T.**
  - The image is magnified by 2 times and a frame appears indicating the position of the magnified area.
  - To further enlarge the image, move the zoom lever toward **T**. To reduce the magnification, move the zoom lever toward **W**.
  -  will appear for images that cannot be enlarged.
- 2 **Select (**▲▼**, **◀▶**) the enlarged area of the picture with the joystick.**  
To cancel the magnification, move the zoom lever toward **W** until the frame disappears.

### IMPORTANT

While the magnification position frame is displayed, it will replace the joystick guide. Cancel the magnification to return to normal playback.

## Menu Options Lists

Menu items not available appear grayed out. For details about how to select an item, refer to *Using the Menus* (19).

### FUNC. Menu

#### Recording programs (32)



Mode switch: [P]

[P PROGRAM AE], [PORTRAIT],  
[SPORTS], [NIGHT], [SNOW],  
[BEACH], [SUNSET],  
[SPOTLIGHT], [FIREWORKS]

#### White balance (36)



Mode switch: [P]

[AUTO], [DAYLIGHT],  
[TUNGSTEN], [SET]

#### Image effect (37)



Mode switch: [P]

[IMAGE EFFECT OFF], [VIVID],  
[NEUTRAL],  
[SOFT SKIN DETAIL]

#### Digital effects (40)



Mode switch: [P]

[D.EFFECT OFF], [FADER],  
[EFFECT]

#### SPEAKER VOLUME (25)



Adjust (◀▶) the volume with the joystick.

#### REC PAUSE (44)



Press (⊗) to enter the record pause mode.

#### END SEARCH (26)



Press (⊗) to search.

### Setup menus

#### CAMERA SETUP

#### SHUTTER (33)



Mode switch: [P]

Recording program: [P PROGRAM AE]  
[A AUTO], [1/60], [1/100], [1/250],  
[1/500], [1/1000] [1/2000]

#### A.SL SHUTTER



[ON ON], [OFF OFF]

The camcorder automatically uses slow shutter speeds to obtain brighter recordings in places with insufficient lighting.

● The camcorder uses shutter speeds down to 1/30.

- If a trailing afterimage appears, set the slow shutter to [ **OFF** OFF ].

### D.ZOOM



[ **OFF** OFF ], [ **105x** 105X ], [ **1000x** 1000X ]  
Determines the operation of the digital zoom.

- When activated, the camcorder will switch automatically to the digital zoom when you zoom in beyond the optical zoom range.
- With the digital zoom the image is digitally processed, so the image resolution will deteriorate the more you zoom in.
- The digital zoom indicator will appear in light blue from 35x up to 105x and dark blue from 105x up to 1000x.
- The digital zoom cannot be used with the [ **NIGHT** ] recording program.

### ZOOM SPEED



[ **VAR** VARIABLE ], [ **SPEED 3** ],  
[ **SPEED 2** ], [ **SPEED 1** ]

- When set to [ **VAR** VARIABLE ] the zoom speed depends on how you operate the zoom lever: Press lightly for a slow zoom; press harder for faster zooms.
- The fastest zoom speed can be achieved with [ **VAR** VARIABLE ]. Among the fixed zoom speeds, [ **SPEED 3** ] is the fastest and [ **SPEED 1** ] the slowest.

### IMG STAB



Mode switch: [ **P** ]

[ **ON** ON ], [ **OFF** OFF ]

The image stabilizer compensates for camcorder shake even at full telephoto.

- The image stabilizer is designed to compensate for a normal degree of camcorder shake.
- The image stabilizer may not be effective when recording in dark places using the [ **NIGHT** ] recording program.
- The image stabilizer cannot be turned off when the mode switch is set to **EASY**.
- We recommend setting the image stabilizer to [ **OFF** OFF ] when using a tripod.

### WIDESCREEN



[ **ON** ON ], [ **OFF** OFF ]

The camcorder uses the full width of the CCD providing high-resolution 16:9 recording.

- Since the displays on the camcorder have an aspect ratio of 16:9, recordings with a 4:3 aspect ratio will appear in the center of the screen with black sidebars.
- **Playing back a widescreen recording:** TV sets compatible with the Video ID-1 system will automatically switch to wide (16:9) mode. Otherwise, change the aspect ratio of the TV manually. To play back on a TV with normal aspect ratio (4:3) change the [ **TV TYPE** ] setting accordingly (□ 29).

### SELF TIMER

(□ 39)



[ **ON** ON ], [ **OFF** OFF ]

## VCR SETUP

### REC MODE



[**SP** STD PLAY], [**LP** LONG PLAY]

● Recording in LP mode extends the available recording time on the tape 1.5 times.

● Depending on the condition of the tape (long usage, imperfections, etc.) you may notice some video problems (blocky video artifacts, banding, etc.) in the playback picture when playing back recordings made in LP mode. We recommend using the SP mode for important recordings.

● If you make recordings in both SP and LP modes on the same tape, during playback you may notice some video problems in the picture at the point where the recording mode changes.

● When playing back in this camcorder tapes recorded in LP mode with other devices or vice versa, you may notice some problems in the playback picture or the sound may stop briefly.

### TV TYPE



[**4:3** NORMAL TV], [**16:9** WIDE TV]

In order to display the picture in full and in the correct aspect ratio, select the setting according to the type of television to which you will connect the camcorder.

[NORMAL TV]: TV sets with 4:3 aspect ratio.

[WIDE TV]: TV sets with 16:9 aspect ratio.

## AUDIO SETUP

### OUTPUT CH

( 38)



[**L/R**], [**L/L**], [**R/R**]

### WIND SCREEN



Mode switch: **P**

[**A** AUTO], [**OFF** OFF ]

The camcorder automatically reduces the background sound of wind when recording outdoors.

● The wind screen cannot be turned off when the mode switch is set to **EASY**.

### 12bit AUDIO

( 38)



[**ST-1 STEREO1**], [**ST-2 STEREO2**],  
[**1:1 MIX/FIXED**], [**+ MIX/VAR.**]

### MIX BALANCE

( 38)



ST-1 ST-2

When [12bit AUDIO] is set to [**+ MIX/VAR.**], adjust (**◀▶**) the sound balance with the joystick.

● The camcorder will retain the audio balance adjustment, however if you turn off the camcorder, [12bit AUDIO] will be reset to [ST-1 STEREO1].

### AUDIO MODE



[**16bit** 16bit], [**12bit** 12bit]

## DISPLAY SETUP

### BRIGHTNESS



Adjust (◀▶) the brightness of the LCD display with the joystick.

- Changing the brightness of the LCD display does not affect that of the viewfinder or the recordings.

### BACKLIGHT

(□ 19)



[ NORMAL]\*, [ BRIGHT]

\* The default setting is [ BRIGHT] when you power the camcorder using the compact power adapter.

### TV SCREEN



[ ON], [ OFF]



[ ON], [ OFF]

When set to [ ON], the camcorder's on-screen displays will appear also on the screen of a connected TV or monitor.

When the date and time are displayed on the camcorder's screen they will also appear on a connected TV regardless of the [TV SCREEN] setting. Turn off the date/time display with the [DATA CODE] setting (□ 31).

### MARKERS



[ OFF], [ LEVEL(WHT)], [ LEVEL(GRY)], [ GRID(WHT)], [ GRID(GRY)]

You can display a grid or a horizontal line at the center of the screen. The markers are available in white or gray. Use the markers as a reference to make sure your subject is framed correctly (vertically and/or horizontally).

- Using the markers will not affect the recordings on the tape.

### DISPLAYS



[ ON], [ OFF<PLAYBK>]

You can hide the on-screen displays to show only the playback picture on the full screen.

- Tape operation displays appear for 2 seconds.
- Warning messages and the data code (if activated) will appear, even when set to [ OFF<PLAYBK>].
- All on-screen displays will appear while the playback image is magnified or a digital effect is activated.

### 6SEC.DATE



[ ON], [ OFF]

When you start playing back a tape or when the date of the recording changes, the date and time will be displayed for 6 seconds.

**DATA CODE**

( 39)



[ **OFF OFF** ], [ **DATE** ], [ **TIME** ],  
[ **DATE & TIME** ]

**LANGUAGE**

( 21)



The list of available languages depends on the region where you purchased the camcorder.

**Language Set A:**

[DEUTSCH], [ENGLISH], [ESPAÑOL],  
[FRANÇAIS], [ITALIANO], [POLSKI],  
[РУССКИЙ], [简体中文], [日本語]

**Language Set B:**

[ENGLISH], [简体中文], [繁體中文], [한국어]

**DEMO MODE**

[ **ON ON** ], [ **OFF OFF** ]

The demonstration mode displays the camcorder's main features. It starts automatically when the camcorder is powered with the power adapter if you leave it turned on without loading a recording media for more than 5 minutes.

● To cancel the demo mode once it started, press any button, turn off the camcorder or insert a videocassette.

**SYSTEM SETUP****BEEP**

[ **HIGH VOLUME** ],  
[ **LOW VOLUME** ], [ **OFF OFF** ]

A beep will accompany some operations like turning on the camcorder, the self-timer countdown, etc. It also serves as a warning beep under unusual conditions.

**POWER SAVE**

[ **ON ON** ], [ **OFF OFF** ]

In order to save power when the camcorder is powered by a battery pack, it will automatically shut off if left without any operation for five minutes. Approximately 30 seconds before the camcorder shuts off, the message "⚠️ AUTO POWER OFF" will appear.

**DATE/TIME SETUP****T.ZONE/DST**

( 21)

**DATE/TIME**

( 22)

**DATE FORMAT**

[Y.M.D (2007.1.1 AM 12:00)],  
[**M.D,Y (JAN. 1, 2007 12:00 AM)**],  
[D.M.Y (1.JAN.2007 12:00 AM)]

Changes the date format for on-screen displays.

## Using the Recording Programs



### **EASY Easy Recording**

The camcorder adjusts the focus, exposure and other settings automatically, allowing you to just point and shoot.



### **P: Recording Programs ( 33)**

#### **[P PROGRAM AE]**

The camcorder sets the aperture and shutter speed.



#### **[NIGHT]**

Use this mode to record in low-light conditions.



#### **[SUNSET]**

Use this mode to record sunsets in vibrant colors.



#### **[PORTRAIT]**

The camcorder uses a large aperture, achieving a focus on the subject while blurring other distracting details.



#### **[SNOW]**

Use this mode to record in bright ski resorts. It prevents the subject from being underexposed.



#### **[SPOTLIGHT]**

Use this mode to record spotlight scenes.



#### **[SPORTS]**

Use this mode to record sports scenes such as tennis or golf.



#### **[BEACH]**

Use this mode to record on a sunny beach. It prevents the subject from being underexposed.



#### **[FIREWORKS]**

Use this mode to record fireworks.





## [P]: Changing the Shutter Speed and Special Scene Programs

Use the automatic exposure (AE) program to set the shutter speed or select one of the special scene recording programs.

### POINTS TO CHECK



Mode switch: [P]



**FUNC.**  
(19)

FUNC.



FUNC.

Icon of the currently selected **Recording Program**



FUNC.

Desired option

## TO SET THE SHUTTER SPEED IN THE [P PROGRAM AE] RECORDING PROGRAM

FUNC.

MENU



CAMERA SETUP



SHUTTER



FUNC.

Desired option

## Shutter speed guidelines

1/60
For general recordings.
1/100
For recording indoor sports scenes.
1/250, 1/500, 1/1000
For recording from within a car or train, or for recording moving subjects such as roller coasters.
1/2000
For recording outdoor sports such as golf or tennis on sunny days.

Note that on screen only the denominator is displayed – “P 250” indicates a shutter speed of 1/250, etc.

### NOTES

- Do not change the position of the mode switch while recording as the brightness of the image may change abruptly.
- [P PROGRAM AE]
  - When setting the shutter speed, the number displayed will flash if the value selected is not appropriate for the recording conditions. In such case, select a different value.
  - If you use a slow shutter speed in dark places, you can obtain a brighter image, but the image quality may be lower, and the autofocus may not work well.
  - The image may flicker when recording with high shutter speeds.
  - Recording movies under fluorescent lights:** If the screen starts to flicker, select [P PROGRAM AE] and set the shutter speed to 1/100.
  - The shutter speed resets to [A AUTO] when you set the mode switch to **EASY** or change the recording program.
- [P PORTRAIT]/[P SPORTS]/[P BEACH]/[P SNOW]
  - The picture may not appear smooth during playback.
- [P PORTRAIT]
  - The blur effect of the background increases the more you zoom in (T).

- [NIGHT]

- Moving subjects may leave a trailing afterimage.
- Picture quality may not be as good as in other modes.
- White points may appear on the screen.
- Autofocus may not work as well as in other modes. In such case, adjust the focus manually.

- [SNOW]/[BEACH]

- The subject may become overexposed on cloudy days or in shaded places. Check the image on the screen.

- [FIREWORKS]

- To avoid camcorder shake, we recommend using a tripod.

## Adjusting the Picture: Exposure, Focus and Color

### Manual Exposure Adjustment

At times, backlit subjects may appear too dark (underexposed) or subjects under very strong lights may appear too bright or glaring (overexposed). To correct this, you can manually adjust the exposure.

#### POINTS TO CHECK



( 9 )

Mode switch: [P] (except for the [FIREWORKS] recording program).



- 1 If the joystick guide does not appear on screen, press ( ) to display it.**
- 2 Push the joystick (▲) towards [EXP].**
  - [EXP] on the joystick guide changes to light blue and the exposure adjustment indicator  and the neutral value "±0" appear on the screen.
  - If you operate the zoom during exposure lock, the brightness of the image may change.
- 3 Adjust (◀▶) the brightness of the image as required.**
  - The adjustment range and the length of the exposure adjustment indicator will vary depending on the initial brightness of the picture.
  - Pushing the joystick (▲) towards [EXP] again will return the camcorder to automatic exposure.
- 4 Push the joystick (▼) towards [BACK] to save the exposure setting.**

## Manual Focus Adjustment

Autofocus may not work well on the following subjects. In such case, focus manually.

Reflective surfaces



Subjects with low contrast or without vertical lines



Fast moving subjects



Through wet windows



Night scenes



### POINTS TO CHECK



( 9 )

Mode switch: [P]



- 1 Adjust the zoom.
- 2 If the joystick guide does not appear on screen, press ( 9 ) to display it.
- 3 Push the joystick (▼) towards [FOCUS] to activate the manual focus.  
[FOCUS] on the joystick guide will be displayed in light blue and "MF" appears on the screen.

- 4 Adjust (◀▶) the focus as necessary.

- Push the joystick (▶) towards ▲ for a farther focal distance or push it (◀) towards ♀ for a closer focal distance.
- Pushing the joystick (▼) towards [FOCUS] again will return the camcorder to autofocus.

- 5 Push the joystick (▲) towards [BACK] to save the focus adjustment.

### NOTES

The camcorder will automatically return to autofocus when you set the mode switch to **EASY**.

### Infinity Focus

Use this function when you wish to focus on faraway subjects such as mountains or fireworks.



- 1 Adjust the zoom.
- 2 Keep the joystick pushed (▼) towards [FOCUS] for more than 2 seconds.
  - ∞ appears.
  - Pushing the joystick (▼) towards [FOCUS] again will return the camcorder to autofocus.
  - Operating the zoom or the joystick (◀▶) will return the camcorder to manual focus adjustment.
- 3 Push the joystick (▲) towards [BACK] to save the focus adjustment.

## White Balance

The white balance function helps you accurately reproduce colors under different lighting conditions so that white objects will always look truly white in your recordings.

### POINTS TO CHECK



Mode switch: **[P]**

### Options

◆ Default value

<b>[AWB AUTO]◆</b>
Settings are automatically set by the camcorder. Use this setting for outdoor scenes.
<b>[☀ DAYLIGHT]</b>
For recording outdoors on a bright day.
<b>[☀ TUNGSTEN]</b>
For recording under tungsten and tungsten type (3-wavelength) fluorescent lighting.
<b>[📷 SET]</b>
Use the custom white balance for special situations not covered by the other options. The custom white balance will ensure that white subjects appear white under various lighting conditions.

**FUNC.**  
(📖 19)

FUNC.



**FUNC.** ⇨

Icon of the currently selected  
**White Balance**



**FUNC.** ⇐

Desired option\*

\* When you select **[📷 SET]**, do not press **[FUNC.]** and continue instead with the procedure below.

## TO SET THE CUSTOM WHITE BALANCE

**1** Point the camcorder at a white object, zoom in until it fills the whole screen and press (📷).

When the adjustment is completed,  stops flashing and stays on. The camcorder retains the custom setting even if you turn off the camcorder.

**2** Press **[FUNC.]** to save the setting and close the menu.

### NOTES

● When you select the custom white balance

**[📷 SET]**:

- Make the white balance adjustment in a place with sufficient light.
- Set **[D.ZOOM]** to **[OFF OFF]** (📖 28).
- Readjust the white balance if the lighting conditions change.
- Very rarely and depending on the light source,  may keep on flashing instead of staying on. Even in that case, the white balance would be properly adjusted and the results should be better than with **[AWB AUTO]**.

● Custom white balance may provide better results in the following cases:

- Changing lighting conditions
- Close-ups
- Subjects in a single color (sky, sea or forest)
- Under mercury lamps and certain types of fluorescent lights

## Image Effects

You can use the image effects to change the color saturation and contrast to obtain different results.

### POINTS TO CHECK



Mode switch: [P]

### Options

◆ Default value

[  IMAGE EFFECT OFF ]◆
Records with no image enhancing effects.
[  VIVID ]
Emphasizes the contrast and color saturation.
[  NEUTRAL ]
Tones down the contrast and color saturation.
[  SOFT SKIN DETAIL ]
Softens the details in the skin tone area for a more complimentary appearance.

**FUNC.**  
( 19 )

FUNC.



[FUNC.] → Icon of the currently selected **Image Effect**



[FUNC.] ← Desired option

## Audio Recording and Playback

### Audio Recording Mode

You can change the quality of the audio recording.

### POINTS TO CHECK



### Options

◆ Default value

[  16bit ]
Records audio at the highest quality.
[  12bit ]◆
Records audio on 2 channels (Stereo 1) leaving 2 channels free (Stereo 2) for audio dubbing or for adding a sound track with an external device. Audio dubbing cannot be performed with this camcorder.

**FUNC.**  
( 19 )

FUNC.



[FUNC.] → MENU



AUDIO SETUP



AUDIO MODE



[FUNC.] ← Desired option

### ABOUT THE WIND SCREEN

When using the built-in microphone, the camcorder automatically reduces the background sound of wind, but you can turn the wind screen off when you want the microphone to be as sensitive as possible ( 29 ).

## TO USE AN EXTERNAL MICROPHONE

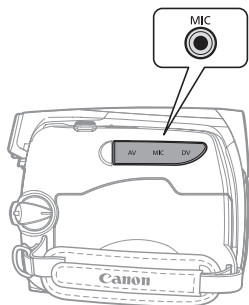

Connect the external microphone to the MIC terminal. Use commercially available condenser microphones with their own power supply and a cable no longer than 3 m. You can connect almost any stereo microphone with a  $\varnothing$  3.5 mm plug but the audio recording levels may vary.

## Audio Playback Modes

### Selecting the Audio Channel

You can select the audio channel to play back when playing back a tape with audio recorded on two channels (either stereo sound or bilingual audio signals).

#### POINTS TO CHECK



#### Options

◆ Default value

[  L/R ] <sup>◆</sup>
Left and Right channels (stereo) / Main + Sub signals (bilingual).
[  L/L ]
Left channel only (stereo) / Main signal only (bilingual).

[  R/R ]
Right channel only (stereo) / Sub signal only (bilingual).

**FUNC.**  
( 19 )

FUNC.



FUNC.	⇨	MENU
		↓
		AUDIO SETUP
		↓
		OUTPUT CH
		↓
FUNC.	⇦	Desired option

### Selecting the Audio Track on a Tape with Dubbed Audio

You can select the audio track to play back when playing back a tape that has a dubbed audio track (Stereo 2) in addition to the original recorded audio (Stereo 1).

#### POINTS TO CHECK



#### Options

◆ Default value

[ ST-1 STEREO1 ] <sup>◆</sup>
Original sound only.
[ ST-2 STEREO2 ]
Dubbed audio only.
[ 1:1 MIX/FIXED ]
Mixed audio with the original sound and the dubbed audio at the same level.
[  MIX/VAR. ]
Mixed audio where the balance between the original sound ( ST-1 ) and the dubbed audio ( ST-2 ) can be adjusted.

**FUNC.**  
( 19)

FUNC.

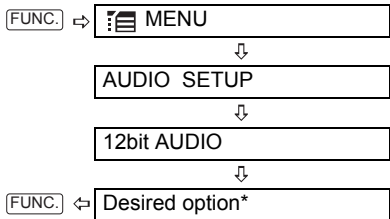

\* When you select [MIX/VAR.], adjust the mix balance with the [MIX BALANCE] setting ( 29).

## Other Functions

### Data Code

The camcorder keeps a data code containing the date and time of recording. You can select the data to be displayed.



### Options

◆ Default value

[ OFF OFF]◆
No data code display.
[ DATE], [ TIME]
Displays the date or time when the scene or still image was recorded.
[ DATE & TIME]
Displays both the date and time of the recording.

**FUNC.**  
( 19)

FUNC.

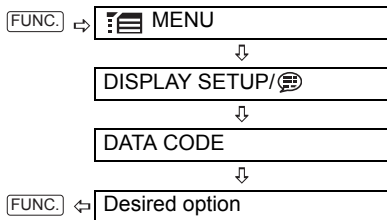

### Self Timer



( 9)

Set the camcorder in record pause mode.

**FUNC.**  
( 19)

FUNC.

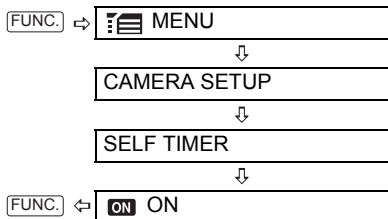

- appears.
- Set [SELF TIMER] to [**OFF** OFF] to cancel the self timer.

Press **Start/Stop**.

The camcorder starts recording after a 10-second countdown. The countdown appears on the screen.

**i NOTES**

Once the countdown has begun, you can also press **Start/Stop** to cancel the self timer. The self timer will also be canceled if you turn off the camcorder.

**Digital Effects****[ FADER] Faders**

Begin or end scenes with a fade to or from black. You can preview the effect on the display.

<b>[1] [FADE-T]</b> (fade trigger)	<b>[2] [WIPE]</b>
<b>[3] [CORNER]</b> (corner wipe)	<b>[4] [JUMP]</b>
<b>[5] [FLIP]</b>	<b>[6] [PUZZLE]</b>
<b>[7] [ZIGZAG]</b>	<b>[8] [BEAM]</b>
<b>[9] [TIDE]</b>	

**[ EFFECT] Effects**

Add flavor to your recordings. Sound will be recorded normally. You can preview the effect on the display.

<b>[1] [BLK&amp;WHT]</b> (black and white)	<b>[2] [SEPIA]</b>
<b>[3] [ART]</b>	<b>[4] [MOSAIC]</b>
<b>[5] [BALL]</b>	<b>[6] [CUBE]</b>
<b>[7] [WAVE]</b>	<b>[8] [COLOR M.]</b> (color mask)
<b>[9] [MIRROR]</b>	

 **POINTS TO CHECK**

Mode switch: **P**

◆ Default value

**FUNC.**  
( 19)

FUNC.

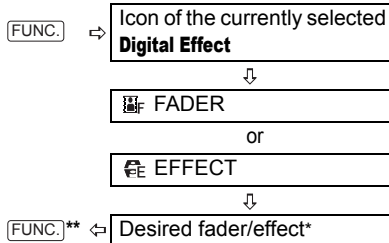
**Setting**

\* You can preview the effect on the screen before pressing ().

\*\* The icon of the selected effect appears.



## Applying

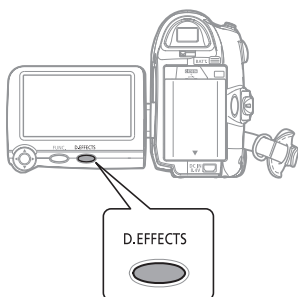

### 1 Press **D.EFFECTS** to activate the fader/effect.

- The icon of the selected effect turns green.
- Press **D.EFFECTS** again to deactivate the fader/effect.

### To FADE IN

Press **D.EFFECTS** ...

**CAMERA** (CAMERA icon): ...in record pause mode, then press **Start/Stop** to start recording with a fade in.

**PLAY** (PLAY icon): ...in playback pause mode, then push the joystick (▲) towards ►/|| to fade in and start the playback.

### To FADE OUT

Press **D.EFFECTS** ...

**CAMERA** (CAMERA icon): ...while recording, then press **Start/Stop** to fade out and pause the recording.

**PLAY** (PLAY icon): ...during playback, then push the joystick (▲) towards ►/|| to fade out and pause the playback.

### To ACTIVATE AN EFFECT

Press **D.EFFECTS** ...

**CAMERA** (CAMERA icon): ...while recording or in record pause mode.

**PLAY** (PLAY icon): ...during playback.

## **i** NOTES

- When you are not using the digital effect, select [D.EFFECT OFF].
- The camcorder retains the setting last used even if you turn off the digital effects or change the recording program.
- The digital effects are not available when [TV TYPE] is set to [NORMAL TV] and the stereo video cable is connected to the AV terminal.



## Connecting to a TV or VCR

### Connection Diagrams

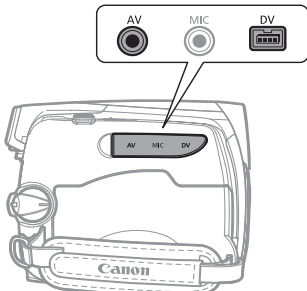
Turn off all the devices when making the connections and refer also to the instruction manual of the connected device.



Open the terminal cover to access.

	<b>AV Terminal</b>
	<b>DV Terminal</b> Check the type and orientation of the terminal and make sure you connect the DV cable properly.

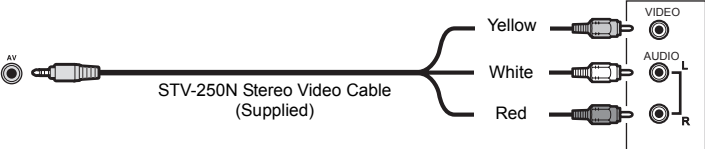
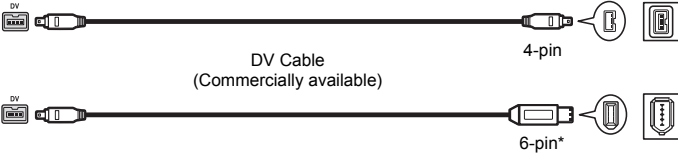
Terminal on the Camcorder	Connecting Cable	Terminal on the Connected Device
<b>1</b> Output connection (Signal Flow →) to a TV or VCR with AV Terminals.	 <p>STV-250N Stereo Video Cable (Supplied)</p> <p>Yellow White Red</p> <p>VIDEO AUDIO L R</p>	
<b>2</b> Output connection (Signal Flow →) to an HDTV with a DV (IEEE1394) terminal. Input connection (Signal Flow ←) from a TV or other digital video source with a DV (IEEE1394) output.	 <p>DV Cable (Commercially available)</p> <p>4-pin 6-pin*</p>	

\* Be careful to correctly insert the 6-pin plug into the DV terminal. Inserting it in the wrong direction can result in damage to the camcorder.

## Playback on a TV Screen

The quality of the playback picture will vary depending on the connected TV and the type of connection used.



Before making the connections, select the [TV TYPE] setting according to the TV set to which you will connect the camcorder (□ 29).

## Connecting

Connect the camcorder to the TV following one of the connection diagrams shown in the previous section *Connection Diagrams* (□ 42).

## Playback

### 1 Turn on the camcorder and the connected TV or VCR.

On a TV: Set the input selector to VIDEO. On a VCR: Set the input selector to LINE (IN).

### 2 Start the playback of the movies (□ 25).

#### **i** NOTES

- Turn off all the devices before starting the connections.
- We recommend powering the camcorder using the compact power adapter.

## Recording to a VCR or Digital Video Recorder

You can copy your recordings by connecting the camcorder to a VCR or a digital video device. When recording to a digital video recorder using the DV terminal, you can copy recordings with

virtually no generation loss in video and sound quality.

Connect the camcorder to the external device following one of the connection diagrams shown in the previous section *Connection Diagrams* (□ 42).



## Connecting

Connect the camcorder to a VCR or other analog device using connection type **1**, or to a DVD recorder or other digital recording device using connection type **2**, as shown in the previous section *Connection Diagrams* (□ 42).

## Recording

### 1 This camcorder: Load the recorded cassette.

### 2 Connected device: Load a blank cassette or disc and set the device to record pause mode.

### 3 This camcorder: Locate the scene you wish to copy and pause the playback shortly before the scene.

### 4 This camcorder: Resume the movie playback.

When using an analog connection you can include in the copy also the date/time of the original recording (□ 39).

### 5 Connected device: Begin recording when the scene you wish to copy appears. Stop recording when copying is complete.

### 6 This camcorder: Stop playback.

#### **i** NOTES

- We recommend powering the camcorder using the compact power adapter.
- When recording to a VCR using an analog connection –connection type **1** (□ 42)–, the quality of the edited tape will be lower than the original.

- When recording to a digital video recorder using the DV terminal –connection type **2** (□ 42)–:
  - If the picture does not appear, disconnect the DV cable and restore the connection after a short while or turn the camcorder off and then on again.
  - Proper operation cannot be guaranteed for all digital devices equipped with a DV terminal. If the operation does not work, use the AV terminal.



- 6** When the scene you wish to record appears, push the joystick (▲) towards ●/|| to begin recording. Recording starts.
- 7** While recording, push the joystick (▲) towards ●/|| to pause the recording. In record pause, push the joystick (▲) towards ●/|| again to resume recording.
- 8** Push the joystick (▼) towards ■ to stop recording.
- 9** Connected device: Stop the playback.

## Digital Video Dubbing

You can input video from other digital video devices and record the input video on the tape in the camcorder.



### Connecting

Connect the camcorder to the video input source using the digital connection –connection type **2** (□ 42)– shown in the previous section *Connection Diagrams*.

### Dubbing

**FUNC.**  
(□ 19)

FUNC.



- 1** Load a blank cassette in this camcorder.
- 2** Connected device: Load the recorded cassette or disc.
- 3** Press **FUNC.**, select (▲▼) [● || REC PAUSE] and press (⊙).
- 4** Select (◀▶) [EXECUTE] and press (⊙).
- 5** Connected device: Start the playback. In record pause mode and while recording you can check the picture on the camcorder's screen.

### ! IMPORTANT

- Blank sections may be recorded as anomalous picture.
- If the picture does not appear, disconnect the DV cable and restore the connection after a short while or turn the camcorder off and then on again.
- You can only record video signals in DV standard (standard definition, SP or LP mode) from devices carrying the DV logo. Note that signals from identically shaped DV (IEEE1394) terminals may be in different video standards.

### i NOTES

We recommend powering the camcorder using the compact power adapter.





### Copyright Signal

Certain software tapes are copyright protected. If you attempt to play back such tape, "COPYRIGHT PROTECTED PLAYBACK IS RESTRICTED" appears and you will not be able to view the contents of the tape. If you attempt to record from such tape via the HDV/DV terminal, "COPYRIGHT PROTECTED DUBBING RESTRICTED" appears and you will not be able to record the contents of the tape.

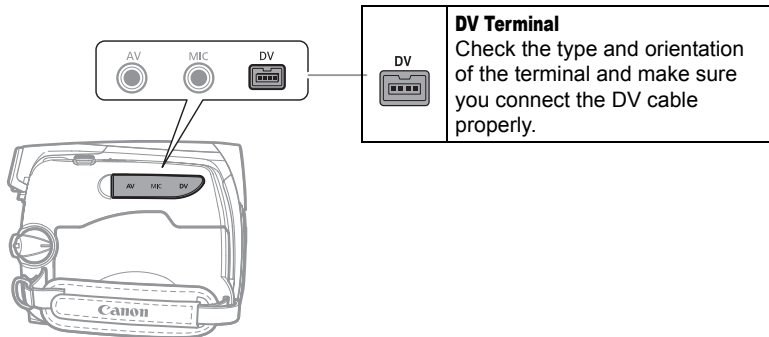
## Connecting to a Computer

### PC Connection Diagrams



Terminal on the Camcorder	Connecting Cable	Terminal on the Connected Device
<b>1</b> Output connection (Signal Flow →) to a computer with a DV (IEEE1394) terminal or a DV capture board.		
	DV Cable (Commercially available)	 4-pin
		 6-pin*
* Be careful to correctly insert the 6-pin plug into the DV terminal. Inserting it in the wrong direction can result in damage to the camcorder.		

---

## Transferring Video Recordings

You can transfer recordings to a computer using the DV terminal.



---

### Equipment and System Requirements

- A computer equipped with an IEEE1394 (DV) terminal or an IEEE1394 (DV) capturing board.
- A DV cable (commercially available).
- Video Editing Software.
- The appropriate driver  
A driver is preinstalled on Windows operating systems later than Windows 98 Second Edition and Mac operating systems later than Mac OS 9, and will be installed automatically.

---

### Connecting

- 1 Start the computer.
- 2 Set the camcorder to  mode.
- 3 Connect the camcorder to the computer using the digital connection –connection type  ( 45)– shown in the previous section *PC Connection Diagrams*.
- 4 Start the video editing software.  
Refer to the instruction manual of the editing software.

### IMPORTANT

- The video transfer may not work correctly depending on the software and the specifications/settings of your computer.
- If the computer freezes while the camcorder is connected to it, disconnect the DV cable and turn off the camcorder and the computer. After a short while, turn them on again, set the camcorder to  mode and restore the connection.
- Before connecting the camcorder to the computer using a DV cable, make sure that no other IEEE1394 device is connected to the computer.
- Depending on the video editing software, you may need to set the **POWER** switch on the camcorder to a mode other than PLAY. Refer to the instruction manual of the editing software.

### NOTES

- We recommend powering the camcorder using the compact power adapter.
- Refer also to the instruction manual of the computer.

## Troubleshooting

If you have a problem with your camcorder, refer to this checklist. Consult your dealer or a Canon Service Center if the problem persists.

### Power Source



Problem	Solution	
<ul style="list-style-type: none"> <li>• Camcorder will not turn on.</li> <li>• The camcorder switches off by itself.</li> <li>• The cassette compartment cover will not open.</li> <li>• The cassette compartment stopped half way while inserting/removing a tape.</li> <li>• The LCD/viewfinder switches on and off.</li> </ul>	Battery pack is exhausted. Replace or charge the battery pack.	15
	Attach the battery pack correctly.	
	Use the compact power adapter.	
Battery pack will not charge.	Charge the battery pack in temperatures between 0 °C and 40 °C (32 °F and 104 °F).	–
	Battery packs become hot with use and may not charge. When the battery pack is outside the charging temperature range, the CHG (charge) indicator will flash irregularly. The charging will start once the battery pack temperature is below 40 °C (104 °F).	–
	The battery pack is damaged. Use a different battery pack.	–
	If you connect a faulty power adapter or battery pack, the CHARGE indicator flashes approx. twice per second and the charging stops.	–
	Check that the compact power adapter is correctly connected to the camcorder.	–

### Recording/Playback



Problem	Solution	
Buttons will not work.	Turn on the camcorder.	–
	Load a cassette.	17
Abnormal characters appear on the screen. The camcorder does not operate properly.	Disconnect the power source and reconnect it after a short time. If the problem still persists, disconnect all power sources (including the battery pack and the backup battery). This will reset all the camcorder's settings.	–
"Ⓜ" flashes on the screen.	Load a cassette.	17
"Ⓜ" flashes on the screen.	Battery pack is exhausted. Replace or charge the battery pack.	15
"☒" flashes on the screen.	Condensation is detected. See reference page.	54
"REMOVE THE CASSETTE" appears on the screen.	Remove the cassette and reinsert it.	17
Video noise appears on screen.	When using the camcorder in a room where a plasma TV is located, keep a distance between the camcorder and the plasma TV.	–

Problem	Solution	
Video noise appears on the TV screen.	When using the camcorder in a room where a TV is located, keep a distance between the compact power adapter and the power or antenna cables of the TV.	–
The tape stops during record pause or playback pause.	To protect the tape and video heads, the camcorder will enter the stop mode (■) if left in playback pause (▶  ) or record pause (●  ) mode for 4 minutes 30 seconds. To resume the operation press [Start/Stop] (when recording) or push the joystick (▲) towards ▶/   (during playback).	–

## Recording

Problem	Solution	
Image will not appear on the screen.	Set the camcorder to <b>CAMERA</b>  .	23
"SET THE TIME ZONE, DATE AND TIME" appears on the screen.	Set the time zone, date and time.	21
	Replace the backup lithium battery and set the time zone, date and time.	16
Pressing the start/stop button will not start recording.	Set the camcorder to <b>CAMERA</b>  .	23
	Load a cassette.	17
	Tape reached the end ("END" appears on the screen). Rewind the tape or replace the cassette.	17
	Cassette is protected ("P" flashes on the screen). Change the position of the protect switch.	52
Camcorder will not focus.	Autofocus does not work on that subject. Focus manually.	35
	If you are using the viewfinder, adjust it with the dioptic adjustment lever.	18
	Lens is dirty. Clean the lens with a soft lens-cleaning cloth. Never use tissue paper to clean the lens.	53
Sound is distorted.	When recording near loud sounds (such as fireworks or concerts), sound may become distorted.	–
Viewfinder picture is blurred.	Adjust the viewfinder with the dioptic adjustment lever.	18

## Playback

Problem	Solution	
During playback there is video noise.	Video heads are dirty. Clean the video heads.	2
Pressing the playback button does not start playback.	Load a cassette.	17
	Set the camcorder to <b>PLAY</b>  .	25
	Tape reached the end ("END" appears on the screen). Rewind the tape.	17



Problem	Solution	
No sound from the built-in speaker.	Open the LCD panel.	–
	Speaker volume is turned off. Adjust the volume with the [SPEAKER VOLUME] setting.	25
Image will not appear on the TV screen.	Check again that the camcorder is properly connected to the TV.	42
Tape is running, but image will not appear on the TV screen.	TV/VIDEO selector on the TV is not set to VIDEO. Set the selector to VIDEO.	43
	Video heads are dirty. Clean the video heads.	2
	You attempted to play back or dub copyright a protected tape. Stop playback/dubbing.	44

## Editing

Problem	Solution	
Cannot record with this camcorder video input from an external video device connected using a DV cable.	Wrong signal standard. Refer also to the instruction manual of the connected device.	–

## List of Messages

Message	Explanation/Solution	
SET THE TIME ZONE, DATE AND TIME	You have not set the time zone, date and time. This message appears each time you turn the power on until you set the time zone, date and time.	21
CHANGE THE BATTERY PACK	Battery pack is exhausted. Replace or charge the battery pack.	15
THE TAPE IS SET FOR ERASURE PREVENTION	Cassette is protected. Replace the cassette or change the position of the protect switch.	52
REMOVE THE CASSETTE	Camcorder stopped operating to protect the tape. Remove the cassette and reinsert it.	17
CHECK THE INPUT	The DV cable is not correctly connected to the DV terminal, or the connected digital device is turned off.	42
	The video input signal is in a different television system (PAL or SECAM).	–
CONDENSATION HAS BEEN DETECTED	Condensation has been detected in the camcorder.	54
CONDENSATION HAS BEEN DETECTED REMOVE THE CASSETTE	Condensation has been detected in the camcorder. Remove the cassette.	54
TAPE END	Tape reached the end. Rewind the tape or replace the cassette.	–
INCORRECT TAPE SPECIFICATION	You attempted to play back a tape recorded in a different television system (PAL or SECAM) or in a recording standard not supported by this camcorder.	–

Message	Explanation/Solution	
INPUT SIGNAL NOT SUPPORTED	The digital device connected with the DV cable is incompatible with the camcorder.	–
HEADS DIRTY, USE CLEANING CASSETTE	Video heads are dirty. Clean the video heads.	2
COPYRIGHT PROTECTED PLAYBACK IS RESTRICTED	You attempted to play back a copyright protected tape.	44
COPYRIGHT PROTECTED DUBBING RESTRICTED	You attempted to dub a copyright protected tape. May also appear when an anomalous signal is received during analog line-in recording.	44

## Handling Precautions

### Camcorder

- Do not carry the camcorder by the LCD panel. Be careful when closing the LCD panel.
- Do not leave the camcorder in places subject to high temperatures (like the inside of a car under direct sunlight), or high humidity.
- Do not use the camcorder near strong electric or magnetic fields such as above TVs, near plasma TVs or mobile phones.
- Do not point the lens or viewfinder at strong light sources. Do not leave the camcorder pointed at a bright subject.
- Do not use or store the camcorder in dusty or sandy places. The camcorder is not waterproof – avoid also water, mud or salt. If any of the above should get into the camcorder it may damage the camcorder and/or the lens.
- Be careful of heat generated by lighting equipment.
- Do not disassemble the camcorder. If the camcorder does not function properly, consult qualified service personnel.
- Handle the camcorder with care. Do not subject the camcorder to shocks or vibration as this may cause damage.

### Battery Pack

#### **DANGER!**

#### **Treat the battery pack with care.**

- Keep it away from fire (or it might explode).
- Do not expose the battery pack to temperature higher than 60 °C (140 °F). Do not leave it near a heater or inside a car in hot weather.
- Do not try to disassemble or modify it.
- Do not drop or knock it.
- Do not get it wet.

- Charged battery packs continue to discharge naturally. Therefore, charge them on the day of use, or the day before, to ensure a full charge.
- Attach the terminal cover whenever a battery pack is not in use. Contact with metallic objects may cause a short circuit and damage the battery pack.
- Dirty terminals may cause a poor contact between the battery pack and the camcorder. Wipe the terminals with a soft cloth.
- Since storing a charged battery pack for a long time (about 1 year) can shorten its lifecycle or affect performance, we recommend to discharge the battery pack fully and to store it in a dry place at temperatures no higher than 30 °C (86 °F). If you do not use the battery pack for long periods, charge and discharge it fully at least once a year. If you have more than one battery pack, perform these precautions at the same time for all battery packs.
- Although the battery pack's operating temperature range is from 0 °C to 40 °C (32 °F to 104 °F), the optimal range is from 10 °C to 30 °C (50 °F to 86 °F). At cold temperatures, performance will temporarily decline. Warm it in your pocket before use.

- Replace the battery pack if the usable time after full charge diminishes substantially at normal temperatures.

### About the battery terminal cover

The battery terminal cover has a [□]-shaped hole. This is useful when you wish to differentiate between charged and uncharged battery packs.

Back side of the battery pack

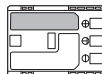

Terminal cover attached  
Charged



Uncharged



## Cassette

- Rewind tapes after use. A slack or damaged tape may cause video problems and/or audio distortions during playback.
- Return cassettes to the case and store them upright. Rewind tapes from time to time if they are stored for a long time.
- Do not leave the cassette in the camcorder after use.
- Do not use spliced tapes or nonstandard cassettes as they may damage the camcorder.
- Do not use tapes that have been jammed as video heads may become dirty.
- Do not insert anything into the small holes of the cassette, or cover them with cellophane tape.
- Handle cassettes with care. Do not drop or subject them to severe impact as this may damage the cassettes.

- With cassettes equipped with a memory function, metal plated terminals may become dirty with use. Clean the terminals with a cotton swab after about 10 times of removing and reinserting the cassette. The memory function is not supported by the camcorder.

### Protecting Tapes from Accidental Erasure

To protect your recordings from accidental erasure, slide the tab on the cassette to SAVE or ERASE OFF.

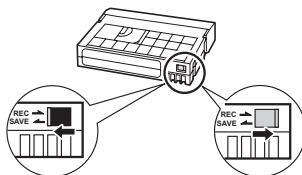

## Lithium Button Battery

### WARNING!

- The battery used in this device may present a fire or chemical burn hazard if mishandled. Do not recharge, disassemble, heat above 100 °C (212 °F) or incinerate the battery.
- Replace the battery with a CR1616 made by Panasonic, Hitachi Maxell, Sony, Toshiba, Varta or Renata. Use of other batteries may present a risk of fire or explosion.
- Dispose of the used battery according to applicable recycling regulations.

- Do not pick up the battery using tweezers or other metal tools as this will cause a short circuit.
- Wipe the battery with a clean dry cloth to ensure proper contact.
- Keep the battery out of the reach of children. If swallowed, seek medical

assistance immediately. The battery case may break and the battery fluids may cause internal damage.

- Do not disassemble, heat or immerse the battery in water to avoid the risk of explosion.

- **For California, USA only:** Included lithium battery contains Perchlorate Material – special handling may apply. See [www.dtsc.ca.gov/hazardouswaste/perchlorate](http://www.dtsc.ca.gov/hazardouswaste/perchlorate) for details.

## Maintenance/Others

---

---

### Cleaning the Camcorder

#### Camcorder Body

- Use a soft, dry cloth to clean the camcorder body. Never use chemically treated cloth or volatile solvents such as paint thinner.

#### Lens and Viewfinder

- If the lens surface is dirty, the autofocus may not work properly.
- Remove any dust or dirt particles using a non-aerosol type blower brush.
- Use a clean, soft lens-cleaning cloth to gently wipe the lens or viewfinder. Never use tissue paper.

#### LCD Screen

- Clean the LCD screen using a clean, soft lens-cleaning cloth.
- Condensation may form on the surface of the screen when the temperature changes suddenly. Wipe it with a soft dry cloth.

---

---

### Storage

- If you do not intend to use the camcorder for a long time, store it in a place free of dust, in low humidity, and at temperatures not higher than 30 °C (86 °F).

## Condensation

Moving the camcorder rapidly between hot and cold temperatures may cause condensation (water droplets) to form on its internal surfaces. Stop using the camcorder if condensation is detected. Continued use may damage the camcorder.

### Condensation may form in the following cases:

When the camcorder is moved from an air-conditioned room to a warm, humid place

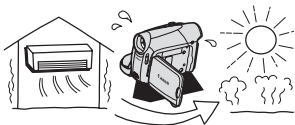

When the camcorder is moved from a cold place to a warm room



When the camcorder is left in a humid room

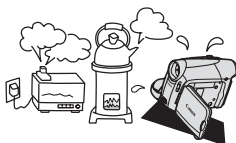



When a cold room is heated rapidly



## TO AVOID CONDENSATION

- Do not expose the camcorder to sudden or extreme changes in temperature.
- Remove the cassette, place the camcorder in an airtight plastic bag and let it adjust to temperature changes slowly before removing it from the bag.

## WHEN CONDENSATION IS DETECTED

- The camcorder automatically shuts off, the warning message "CONDENSATION HAS BEEN DETECTED" appears for approx. 4 seconds and  starts flashing.
- If a cassette is loaded, the warning message "REMOVE THE CASSETTE" appears and  starts flashing. Remove the cassette immediately and leave the cassette compartment open. Leaving the cassette in the camcorder may damage the tape.
- A cassette cannot be loaded when condensation is detected.

## RESUMING USE

- The precise time required for water droplets to evaporate will vary depending on the location and weather conditions. After the condensation warning stops flashing, wait for 1 more hour before resuming use.

---

---

## Using the Camcorder Abroad

### Power Sources

You can use the compact power adapter to operate the camcorder and to charge battery packs in any country with power supply between 100 and 240 V AC, 50/60 Hz. Consult the Canon Service Center for information on plug adapters for overseas use.

### Playback on a TV Screen

You can only play back your recordings on TVs compatible with the NTSC system. The NTSC system is used in the following countries/areas:

American Samoa, Antigua, Aruba, Bahamas, Barbados, Bermuda, Bolivia, Canada, Chile, Colombia, Costa Rica, Cuba, Ecuador, El Salvador, Guam, Guatemala, Greenland, Haiti, Honduras, Jamaica, Japan, Korea, Mexico, Micronesia, Myanmar, Nicaragua, Panama, Peru, Philippines, Puerto Rico, Saint Kitts and Nevis, Saint Lucia, Saint Vincent and the Grenadines, Surinam, Taiwan, Trinidad and Tobago, USA, Venezuela, Virgin Islands.

## System Diagram (Availability differs from area to area)

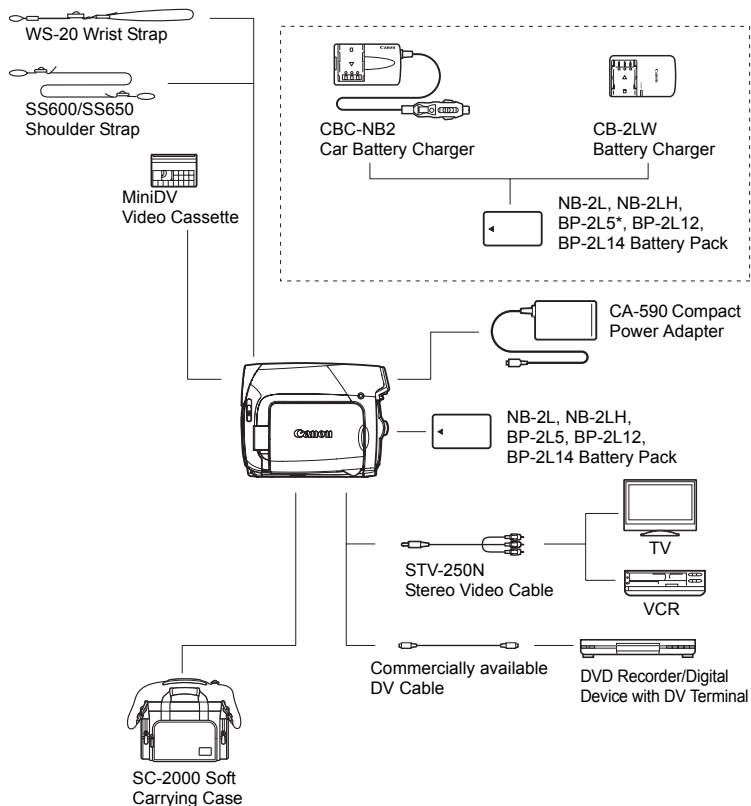

\* The BP-2L5 is not available as a separate optional accessory.



## Optional Accessories

Call or visit your local retailer/dealer for genuine Canon video accessories. You can also obtain genuine accessories for your Canon camcorder by calling: 1-800-828-4040, Canon U.S.A. Information Center.

### Use of genuine Canon accessories is recommended.

This product is designed to achieve excellent performance when used with genuine Canon accessories. Canon shall not be liable for any damage to this product and/or accidents such as fire, etc., caused by the malfunction of non-genuine Canon accessories (e.g., a leakage and/or explosion of a battery pack). Please note that this warranty does not apply to repairs arising out of the malfunction of non-genuine Canon accessories, although you may request such repairs on a chargeable basis.

### Battery Packs

When you need extra battery packs, select one of the following models: NB-2L, NB-2LH, BP-2L12, BP-2L14.

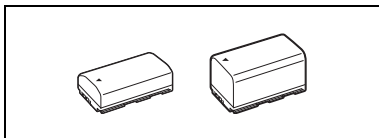

### CB-2LW Battery Charger

Use the battery charger for charging the battery packs. It plugs directly into a power outlet without a cable.

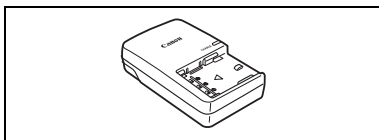

Battery Pack	Charging Time*
BP-2L5	70 min.
NB-2L	80 min.
NB-2LH	90 min.
BP-2L12	150 min.
BP-2L14	170 min.

\* Charging time varies according to the charging condition.

### CBC-NB2 Car Battery Charger

Use the car battery charger to charge battery packs on the move. The car battery cable plugs into your car's cigarette lighter and runs off a 12-24 V DC negative ground battery.

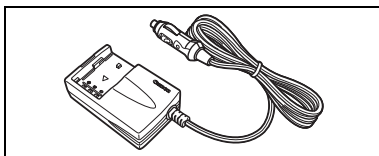

**Shoulder Strap**

You can attach a shoulder strap for more security and portability.

Pass the ends through the strap mount and adjust the length of the strap.

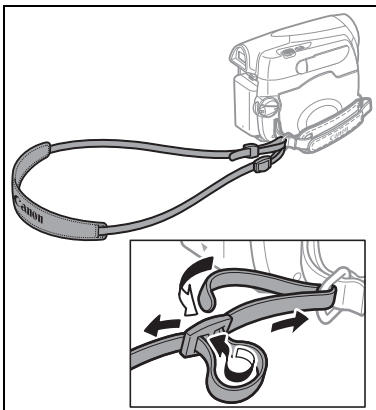
**WS-20 Wrist Strap**

Use this for extra additional protection for active shooting.

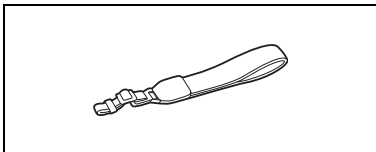
**SC-2000 Soft Carrying Case**

A handy camcorder bag with padded compartments and plenty of space for accessories.



This mark identifies genuine Canon video accessories. When you use Canon video equipment, we recommend Canon-brand accessories or products bearing the same mark.



---

---

## Product Codes

### Provided Accessories

CA-590 Compact Power Adapter	D85-1671-000
STV-250N Stereo Video Cable	3067A002AA (D82-0590-201)

### Optional Accessories

BP-2L12 Battery Pack	7871A002AA
BP-2L14 Battery Pack	9582A002AA
NB-2L Battery Pack	7302A001AA
CB-2LW Battery Charger	0763B001AA
CBC-NB2 Car Battery Charger	7873A002AA
WS-20 Wrist Strap	3118A002AA (D81-0190-202)
SC-2000 Soft Carrying Case	9389A001AA
DVM-CL DV Cleaning Cassette	3134A002AA (D36-0032-201)

## Specifications

### ZR800

#### System

<b>Video Recording System</b>	2 rotary heads, helical scanning DV system (consumer digital VCR SD system), digital component recording
<b>Audio Recording System</b>	PCM digital sound: 16 bit (48 kHz/2 channels); 12 bit (32 kHz)
<b>Television System</b>	EIA standard (525 lines, 60 fields) NTSC color signal
<b>Image Sensor</b>	1/6-inch CCD, approx. 680,000 pixels Effective pixels 16:9 Movies (Image stabilizer [ON]) approx. 360,000 pixels 16:9 Movies (Image stabilizer [OFF]) approx. 450,000 pixels 4:3 Movies approx. 340,000 pixels
<b>Compatible Tapes</b>	Videocassettes bearing the <sup>TM</sup> <b>IX</b> mark
<b>Tape Speed</b>	SP: 18.81 mm/s (0.74 ips); LP: 12.56 mm/s (0.49 ips)
<b>Maximum Recording Time (60 min. tape)</b>	SP: 60 minutes; LP: 90 minutes
<b>LCD Screen</b>	2.7 in., wide, TFT color, approx. 112,000 pixels
<b>Viewfinder</b>	0.35 in., wide, TFT color, approx. 114,000 pixels
<b>Microphone</b>	Stereo electret condenser microphone
<b>Lens</b>	f=2.6–91 mm, F/2.0–5.0, 35x power zoom 35 mm equivalent: 16:9 Movies (Image stabilizer [ON]) 45.8–1,603 16:9 Movies (Image stabilizer [OFF]) 41.0–1,435 4:3 Movies 49.8–1,743
<b>Lens Configuration</b>	10 elements in 8 groups
<b>AF system</b>	TTL autofocus, manual focus available
<b>Minimum Focusing Distance</b>	1 m (3.3 ft.); 1 cm (0.39 in.) on maximum wide angle
<b>White Balance</b>	Auto white balance, preset white balance (DAYLIGHT, TUNGSTEN) or custom white balance
<b>Minimum Illumination</b>	2 lx ([NIGHT] recording program, Shutter speed at 1/8) 8 lx (Easy recording mode, Auto slow shutter [ON], Shutter speed at 1/30)
<b>Recommended Illumination</b>	More than 100 lx
<b>Image Stabilization</b>	Electronic

#### Input/Output Terminals

<b>AV Terminal</b>	Ø3.5 mm minijack, output only Video: 1 V <sub>p-p</sub> /75 ohms unbalanced Audio: -10 dBV (47 kohms load/3 kohms or less)
<b>DV Terminal</b>	4 pin (IEEE1394 standard), input/output
<b>MIC Terminal</b>	Ø3.5 mm stereo mini-jack -57 dBV (with 600 ohm mic)/5 kohms or more

#### Power/Others

<b>Power supply (rated)</b>	7.4 V DC (battery pack), 8.4 V DC (compact power adapter)
<b>Power consumption (AF on)</b>	2.1 W
<b>Operating temperature</b>	0 – 40 °C (32 – 104 °F)
<b>Dimensions (W x H x D)</b>	57 x 92 x 119 mm (2.2 x 3.6 x 4.7 in.) excluding the grip belt
<b>Weight (camcorder body only)</b>	375 g (13.2 oz.)

---

---

### CA-590 Compact Power Adapter

<b>Power input</b>	100 – 240 V AC, 50/60 Hz, 0.14 – 0.08 A
<b>Rated output</b>	8.4 V DC, 0.6 A
<b>Operating temperature</b>	0 – 40 °C (32 – 104 °F)
<b>Dimensions</b>	46 x 26 x 70 mm (1.8 x 1.0 x 2.8 in.)
<b>Weight</b>	95 g (3.4 oz.)

---

---

---

### BP-2L5 Battery Pack

<b>Battery type</b>	Rechargeable Lithium Ion Battery
<b>Rated voltage</b>	7.4 V DC
<b>Operating temperature</b>	0 – 40 °C (32 – 104 °F)
<b>Battery capacity</b>	530 mAh
<b>Dimensions</b>	33.3 x 16.2 x 45.2 mm (1.3 x 0.64 x 1.8 in.)
<b>Weight</b>	40 g (1.4 oz.)

---

Weight and dimensions are approximate. Errors and omissions excepted. Subject to change without notice.

## Index

6-second auto date ..... 30

### A

Abroad, using the camcorder ..... 55  
 Audio mode ..... 37  
 Audio output channel ..... 38  
 Auto slow shutter ..... 27  
 AV terminal ..... 42

### B

Backup battery ..... 16  
 Battery pack, charging ..... 15  
 Battery pack, remaining charge ..... 14  
 Beach (recording program) ..... 32  
 Beep ..... 31

### C

Compact power adapter ..... 15  
 Condensation ..... 54  
 Connection to a computer ..... 45  
 Connection to a TV/VCR ..... 42

### D

Data code ..... 39  
 Date and time ..... 22  
 Daylight saving time ..... 21  
 Digital effects ..... 40  
 Digital video input (DV dubbing) ..... 44  
 Digital zoom ..... 27  
 DV terminal ..... 42, 45

### E

Easy recording (recording program) . . . 32  
 Effects ..... 40  
 End Search ..... 26  
 Error messages ..... 49

### F

Faders ..... 40  
 Fireworks (recording program) ..... 32  
 Focus ..... 35  
 FUNC. menu ..... 19, 27

### G

Grip belt ..... 18

### I

Image effects ..... 37  
 Image stabilizer ..... 28

### J

Joystick ..... 8  
 Joystick guide ..... 8

### L

Language ..... 21  
 LCD backlight ..... 19  
 LCD screen ..... 18  
 LP mode ..... 29

### M

Magnifying the playback image ..... 26  
 Maintenance ..... 53  
 Manual exposure adjustment ..... 34  
 Microphone ..... 37  
 Mode switch ..... 32

### N

Night (recording program) ..... 32  
 Normal TV (4:3) ..... 29

### P

P (recording program) ..... 33  
 Playback ..... 25  
 Portrait (recording program) ..... 32  
 Power save ..... 31

### R

Record review ..... 23  
 Recording ..... 23  
 Recording mode ..... 29  
 Recording programs ..... 32  
 Recording reminder ..... 14  
 Remaining tape indicator ..... 14

### S

Screen displays ..... 13  
 Screen markers ..... 30

Selecting the on-screen displays . . . . . 39  
 Self timer . . . . . 39  
 Serial number . . . . . 11  
 Setup menus . . . . . 20  
 Shoulder strap . . . . . 58  
 Shutter speed . . . . . 33  
 Snow (recording program) . . . . . 32  
 SP mode . . . . . 29  
 Sports (recording program) . . . . . 32  
 Spotlight (recording program) . . . . . 32  
 Sunset (recording program) . . . . . 32

**T**

Telephoto . . . . . 24  
 Time zone . . . . . 21  
 Tripod . . . . . 24  
 Troubleshooting . . . . . 47

**V**

Video heads, cleaning . . . . . 2  
 Videocassettes . . . . . 17, 52  
 Viewfinder, dioptic adjustment . . . . . 18  
 Volume . . . . . 25

**W**

White balance . . . . . 36  
 Wide angle . . . . . 24  
 Wide TV (16:9) . . . . . 29  
 Widescreen . . . . . 28  
 Wind screen . . . . . 29

**Z**

Zoom . . . . . 24  
 Zoom speed . . . . . 24, 28

## U.S.A.

### **CANON CONSUMER DIGITAL VIDEO EQUIPMENT LIMITED WARRANTY FOR THE UNITED STATES**

The warranty set forward below is given by Canon U.S.A., Inc. with respect to equipment purchased in the United States. The limited warranty is only effective upon presentation of your Bill of Sale or other proof of purchase. Canon consumer digital video equipment is warranted under normal, non-commercial, personal use, against defective materials or workmanship as follows:

Parts: Defective parts will be exchanged for new parts or comparable rebuilt parts for a period of ONE YEAR from the date of original purchase, except for a defective Video Head, which will be exchanged for a period of three months from the date of purchase.

Labor: For a period of ONE YEAR from the date of original purchase, labor will be provided free of charge by our factory service centers or designated service facilities located in the United States.

When returning equipment under this warranty, you must pre-pay the shipping charges, and you must enclose the Bill of Sale or other proof of purchase with a complete explanation of the problem. During your ONE-YEAR warranty period, repairs will be made and the equipment return-shipped to you free of charge. After your warranty period is over, you will be given an estimate of the cost of repair and an opportunity to approve or disapprove of the repair expense before it is incurred. If you approve, repairs will be made and the equipment return-shipped to you. (shipping charges apply). If you disapprove, we will return-ship the equipment at no charge to you.

**Non-Canon brand peripheral equipment and software which may be distributed with Canon DV camcorders are sold "AS IS" without warranty of any kind by CUSA, including any implied warranty regarding merchantability or fitness for a particular purpose. The sole warranty with respect to such non-Canon brand items is given by the manufacturer or producer thereof.**

CUSA shall have no responsibility under this limited warranty for use of Canon DV Camcorders in conjunction with incompatible peripheral equipment and incompatible software.

In order to obtain warranty service, contact the authorized Canon retail dealer from whom you purchased the DV Camcorder or call the CANON INFORMATION CENTER AT 1-800-828-4040). You will be directed to the nearest service facility for your product.

This Limited Warranty covers all defects encountered in normal use of the equipment and does not apply in the following cases:

- A) Loss or damage to the equipment due to abuse, mishandling, accident, improper maintenance, or failure to follow operating instructions;
- B) If the equipment is defective as a result of leaking batteries, sand, dirt or water damage;
- C) If defects or damages are caused by the use of unauthorized parts or by service other than our authorized agent;
- D) If the equipment is used for commercial or industrial use.

This Limited Warranty does not cover cabinet (exterior finish), video cassette tape, head cleanings, nor does it apply to equipment purchased outside the United States. This warranty does not cover units sold to rental firms, military operations, hotels, schools, hospitals or for other commercial, industrial, or institutional applications. These uses are covered only by such specific warranty as Canon may issue with such sales.

This Limited Warranty does not apply to accessories or consumables for the DV Camcorder, which are sold "AS IS", without warranty of any kind by CUSA.

Please retain this warranty card and your Bill of Sale as a permanent record of your purchase. This card is most important in order to be sure you are contacted right away should there be a safety inspection, modification or product recall under applicable laws or regulations.

**NO IMPLIED WARRANTY, INCLUDING MERCHANTABILITY AND FITNESS FOR A PARTICULAR PURPOSE APPLIES TO THIS EQUIPMENT AFTER THE APPLICABLE PERIOD OF EXPRESS WARRANTY OR GUARANTY, EXCEPT AS MENTIONED ABOVE, GIVEN BY ANY PERSON, FIRM OR CORPORATION WITH RESPECT TO THIS EQUIPMENT SHALL BIND THE UNDERSIGNED. (SOME STATES DO NOT ALLOW LIMITATIONS ON HOW LONG AN IMPLIED WARRANTY LASTS, SO THE ABOVE LIMITATION OR EXCLUSION MAY NOT APPLY TO YOU). CUSA SHALL NOT BE LIABLE FOR LOSS OF REVENUES OR PROFITS, EXPENSE FOR SUBSTITUTE EQUIPMENT OR SERVICE, STORAGE CHARGES, LOSS OF DATA, OR ANY OTHER SPECIAL, INCIDENTAL OR CONSEQUENTIAL DAMAGES CAUSED BY THE USE, MISUSE OR INABILITY TO USE THE DV CAMCORDER, REGARDLESS OF THE LEGAL THEORY ON WHICH THE CLAIM IS BASED, AND EVEN IF CUSA HAS BEEN ADVISED OF THE POSSIBILITY OF SUCH DAMAGES. NOR SHALL RECOVERY OF ANY KIND AGAINST CUSA BE GREATER THAN THE PURCHASE PRICE OF THE DV CAMCORDER SOLD BY CUSA AND CAUSING THE ALLEGED DAMAGE. WITHOUT LIMITING THE FOREGOING, YOU ASSUME ALL RISK AND LIABILITY FOR LOSS, DAMAGE OR INJURY TO YOU AND YOUR PROPERTY AND TO OTHERS AND THEIR PROPERTY ARISING OUT OF USE, MISUSE OR INABILITY TO USE THE DV CAMCORDER NOT CAUSED DIRECTLY BY THE NEGLIGENCE OF CUSA. (SOME STATES DO NOT ALLOW THE EXCLUSION OR LIMITATION OF INCIDENTAL OR CONSEQUENTIAL DAMAGES, SO THE ABOVE LIMITATION MAY NOT APPLY TO YOU). THIS WARRANTY SHALL NOT EXTEND TO ANYONE OTHER THAN THE ORIGINAL PURCHASER OF THIS EQUIPMENT OR THE PERSON FOR WHOM IT WAS PURCHASED AS A GIFT.**

This warranty gives you specific legal rights, and you may also have other rights which vary from state to state. CANON U.S.A., INC.



**CANADA****CANON CONSUMER DIGITAL VIDEO EQUIPMENT LIMITED WARRANTY**

The limited warranty set forth below is given by Canon Canada Inc. ("Canon Canada") with respect to Canon digital video equipment purchased in Canada. This limited warranty is only effective upon presentation of a bill of sale or other proof of purchase for this Canon digital video equipment to a Canon Service Facility when repairs are required.

Canon consumer video digital equipment is warranted under normal, non-commercial, personal use, against defective materials or workmanship as follows:

Parts: Defective parts will be exchanged for new parts or, at Canon Canada's option, comparable rebuilt parts for a period of one year from the date of original purchase, except Video Heads which will be exchanged for a period of 3 months from the date of purchase.

Labour: For a period of one year from the date of original purchase, labour will be provided free of charge by our Canon Service Facilities in Canada.

This limited warranty covers all defects except where:

(a) The loss or damage to the product results from:

- i) accident, natural disaster, mishandling, abuse, neglect, unauthorized product modification or failure to follow instructions contained in the instruction manual;
- ii) the use of accessories, attachments, products, supplies, parts or devices with this Canon product that do not conform to Canon specifications or that cause abnormally frequent service problems;
- iii) repairs or services performed by any party other than a Canon Service Facility;
- iv) defective batteries or any exposure to water, sand or dirt;
- v) shipping (claim must be presented to the shipper);

(b) Any serial number on the video equipment is altered or removed.

(c) The digital video equipment is used for commercial, professional or industrial purposes.

This limited warranty does not cover the cabinet (exterior finish) of the digital video equipment, video cassette tapes, head cleanings, nor does it apply to digital video equipment purchased outside Canada.

**TO OBTAIN WARRANTY SERVICE**

Ship your Canon digital video equipment in its original carton, box or equivalent, properly packed, fully insured with shipping charges prepaid, together with a copy of your bill of sale or other proof of purchase and a description of the problem to any of the Canon Service Facilities in Canada.

**LIMITATIONS**

Except as otherwise required by applicable legislation, this warranty is in lieu of all other warranties, conditions, guarantees or representations, express or implied, statutory or otherwise, relative to this Canon product, including implied warranties or conditions of merchantability or fitness for a particular purpose.

Canon Canada assumes no liability for special, consequential or incidental damages or loss that may arise, whether on account of negligence or otherwise, from the use, misuse or inability to use this Canon product (including loss of profit, revenue, video tapes or enjoyment) or from failure to conform to any express or implied warranties, conditions, guarantees or representations. Any recovery under this limited warranty shall not exceed the purchase price of the product. Canon Canada does not assume or authorize any other person to assume for Canon Canada any other liability with respect to this Canon product.

This warranty does not extend to any person other than the original purchaser of this Canon product or the person for whom it was purchased as a gift and states your exclusive remedy.

**NOTICE TO CONSUMER**

If you plan to take important videos or if the product has not been used for some time, please check all functions with the instruction book before using it.



**CANON INC.**

**U.S.A.**

**CANON U.S.A., INC. NEW JERSEY OFFICE**

100 Jamesburg Road, Jamesburg, NJ 08831 USA

**CANON U.S.A., INC. CHICAGO OFFICE**

100 Park Blvd., Itasca, IL 60143 USA

**CANON U.S.A., INC. LOS ANGELES OFFICE**

15955 Alton Parkway, Irvine, CA 92618 USA

**CANON U.S.A., INC. HONOLULU OFFICE**

210 Ward Avenue, Suite 200, Honolulu, HI 96814 USA

- If you have any questions, call the Canon U.S.A. Information Center toll-free at 1-800-828-4040 (U.S.A. only).

**CANADA**

**CANON CANADA INC. NATIONAL HEADQUARTERS**

6390 Dixie Road, Mississauga, Ontario L5T 1P7

**CANON CANADA INC. CALGARY**

2828, 16th Street, N.E. Calgary, Alberta T2E 7K7

**CANON CANADA INC. MONTREAL**

5990 Côte de Liesse, Quebec H4T 1V7

- If you have any questions, call the Canon Canada Information Center toll-free at 1-800-828-4040 (CANADA only).

- Si vous avez des questions, veuillez téléphoner sans frais au Canada 1-800-828-4040 (CANADA seulement).

**MEXICO**

**CANON MEXICANA, S. DE R.L. DE C.V.**

Periférico Sur No. 4124 Col. Ex-Rancho de Anzaldo C.P. 01900 México, D.F., México

**CANON U.S.A., INC. NEW JERSEY OFFICE**

100 Jamesburg Road, Jamesburg, NJ 08831 USA

**CENTRO Y SURAMÉRICA**

**CANON LATIN AMERICA, INC.**

703 Waterford Way Suite 400 Miami, FL 33126 USA

**ASIA**

**CANON HONGKONG COMPANY LTD.**

19/F, The Metropolis Tower, 10 Metropolis Drive, Hunghom, Kowloon, Hong Kong

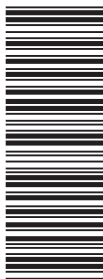

The information on this manual is verified as of January 1st, 2007.  
Les informations contenues dans ce manuel ont été vérifiées le 1er janvier 2007.  
La información de este manual fue verificada el 1 de enero de 2007.



Printed on 100% reused paper.  
Document réalisé avec du papier recyclé à 100%.  
El papel aquí utilizado es 100% reciclado.

## Free Manuals Download Website

<http://myh66.com>

<http://usermanuals.us>

<http://www.somanuals.com>

<http://www.4manuals.cc>

<http://www.manual-lib.com>

<http://www.404manual.com>

<http://www.luxmanual.com>

<http://aubethermostatmanual.com>

Golf course search by state

<http://golfingnear.com>

Email search by domain

<http://emailbydomain.com>

Auto manuals search

<http://auto.somanuals.com>

TV manuals search

<http://tv.somanuals.com>