

Digital Camera

# QV-R3/QV-R4

## User's Guide



**Exif Print**



**DPOF**

All the illustrations in this manual show the QV-R4. See the text that accompanies the illustrations for information about how the QV-R3 and QV-R4 differ from each other.

Thank you for purchasing this CASIO Product. Before using it, be sure to read the precautions contained in this User's Guide, and keep the User's Guide in a safe place for future reference.

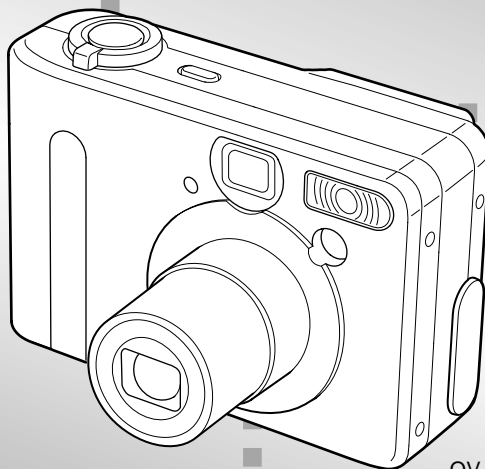

QV-R4

# INTRODUCTION

## Unpacking

Check to make sure that all of the items shown below are included with your camera. If something is missing, contact your dealer as soon as possible.

*Camera*

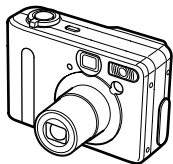

*Rechargeable lithium ion battery  
(NP-30)*

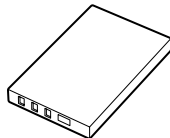

*Charger Unit (BC-20)*

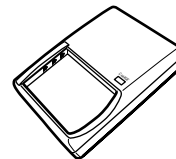

*Strap*

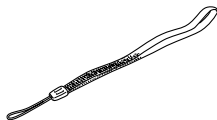

*CD-ROM*



*Special USB Cable*

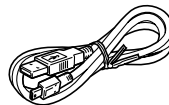

*User's Guide*

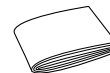

## Contents

**2 INTRODUCTION**

Unpacking .....	2
Contents .....	3
Features .....	8
Precautions .....	9
General Precautions .....	9
Data Error Precautions .....	11
Operating conditions .....	11
Condensation .....	12
LED Backlight .....	12
Lens .....	12
Other .....	12

**14 QUICK START GUIDE**

Getting Ready .....	14
To record an image .....	14
To view a recorded image .....	15
To delete an image .....	15

**16 GETTING READY**

General Guide .....	16
Front .....	16
Bottom .....	16
Back .....	17
Monitor Screen Contents .....	18
Recording Mode .....	18
Play Mode .....	19
Changing the Contents of the Monitor Screen .....	20
Indicator Lamps .....	20
Attaching the Strap .....	21
Using the Soft Case (Option) .....	21
Power Requirements .....	23
Using the Charger Unit .....	23
To load the battery into the camera .....	25
Battery Life .....	26
Power Supply Precautions .....	28
Using AC Power .....	31
Turning the Camera On and Off .....	32
Configuring Power Saving Settings .....	33
Using the On-screen Menus .....	34
Configuring Display Language and Clock Settings ...	36

**38 BASIC IMAGE RECORDING**

Recording an Image .....	38
Recording Precautions .....	40

## INTRODUCTION

About Auto Focus	41
About the Recording Mode Monitor Screen	41
Previewing the Last Image Recorded	42
Deleting an Image in a Recording Mode	42
Using the Optical Viewfinder	43
Adjusting the View of the Optical Viewfinder	43
Using Zoom	44
Optical Zoom	44
Digital Zoom	45
Using the Flash	46
Flash Unit Status	47
Changing the Flash Intensity Setting	48
Flash Precautions	48
Using the Self-timer	49
Specifying Image Size and Quality	51
To specify the image size	51
To specify the image quality	52

## 53 OTHER RECORDING FUNCTIONS

Selecting the Focus Mode	53
Using Auto Focus	53
Using the Macro Mode	54
Using the Infinity Mode	55
Using Manual Focus	55
Using Focus Lock	57
Exposure Compensation (EV Shift)	58

Recording Consecutive Images (Continuous Shutter Mode)	59
Combining Shots of Two People into a Single Image (Coupling Shot)	60
Recording a Subject onto an Existing Background Image (Pre-shot)	62
Using the Best Shot Mode	64
Creating Your Own Best Shot Setup	65
Using the Night Scene Mode	67
Shooting with Manual Exposure	67
Using the Movie Mode	69
Shooting at Fixed Intervals	70
Adjusting the White Balance	72
Adjusting White Balance Manually	73
Selecting the Metering Mode	74
Using the Histogram	75
Recording Mode Settings	76
Specifying Sensitivity	77
Enhancing Specific Colors	77
Using the Filter Function	78
Specifying Color Saturation	78
Specifying Contrast	79
Specifying Outline Sharpness	79
Turning the On-screen Grid On and Off	80
Specifying Power On Default Settings	80
Resetting the Camera	81

## INTRODUCTION

### 82 PLAYBACK

Basic Playback Operation .....	82
Zooming the Displayed Image .....	83
Resizing an Image .....	84
Cropping an Image .....	85
Playing a Movie .....	86
Displaying the 9-image View .....	87
Selecting a Specific Image in the 9-image View .....	88

### 89 DELETING FILES

Deleting a Single File .....	89
Deleting All Files .....	90

### 91 FILE MANAGEMENT

Folders .....	91
Memory Folders and Files .....	91
Protecting Files .....	92
To protect and unprotect a single file .....	92
To protect all files in memory .....	92
DPOF .....	93
To configure print settings for a single image .....	93
To configure print settings for all images .....	94

PRINT Image Matching II .....	95
Exif Print .....	95

### 96 OTHER SETTINGS

Specifying the File Name Serial Number Generation Method .....	96
Turning the Key Tone On and Off .....	96
Specifying an Image for the Startup Screen .....	97
Using the Alarm .....	97
To set an alarm .....	97
Stopping the Alarm .....	98
Changing the Date and Time Setting .....	99
Changing the Date Format .....	99
Using World Time .....	100
To switch between the home time and World Time screens .....	100
To configure World Time settings .....	100
To configure summer time (DST) settings .....	101
Changing the Display Language .....	102
Formatting Built-in Memory .....	103

## INTRODUCTION

### 104 USING A MEMORY CARD

Using a Memory Card .....	105
To insert a memory card into the camera .....	105
To remove a memory card from the camera .....	105
Formatting a Memory Card .....	106
Memory Card Precautions .....	107
Copying Files .....	107
To copy all the files in built-in memory to a memory card .....	107
To copy a file from a memory card to built-in memory .....	108

### 110 USING THE CAMERA WITH A COMPUTER

Installing the Software from the CD-ROM .....	110
About the bundled CD-ROM .....	110
Computer System Requirements .....	111
Installing Software from the CD-ROM in Windows ....	112
Getting Started .....	112
Selecting a Language .....	112
Viewing the Contents of the "Read me" File .....	113
Installing an Application .....	113
Viewing User Documentation (PDF Files) .....	114
Exiting the Menu Application .....	114
Installing Software from the CD-ROM on a Macintosh .....	114
Installing Software .....	114
Viewing User Documentation (PDF Files) .....	117

Transferring Files to a Computer .....	118
Transferring Files Over a USB Connection .....	118
Transferring Files Using a Memory Card .....	120
Memory Data .....	121
Memory Directory Structure .....	122
Supported Image Files .....	123
Built-in Memory and Memory Card Precautions .....	123
Using the Album Feature .....	124
Creating an album .....	124
Selecting an Album Layout .....	125
Configuring Detailed Album Settings .....	126
Viewing Album Files .....	128
Saving an Album .....	130

### 131 APPENDIX

Menu Reference .....	131
Recording Mode Menu .....	131
PLAY Mode Menu .....	132
Indicator Lamp Reference .....	133
Recording Mode .....	133
Play Mode .....	134
Charger Unit .....	135
Troubleshooting Guide .....	136
Display Messages .....	139
Specifications .....	140
Main Specifications .....	140

## INTRODUCTION

### ►► IMPORTANT! ◀◀

- The contents of this manual are subject to change without notice.
- CASIO COMPUTER CO., LTD. assumes no responsibility for any damage or loss resulting from the use of this manual.
- CASIO COMPUTER CO., LTD. assumes no responsibility for any loss or claims by third parties which may arise through the use of the QV-R3/QV-R4.
- CASIO COMPUTER CO., LTD. shall not be held liable for any damages or losses suffered by you or any third party due to the use of Photo Loader and/or Photohands.
- CASIO COMPUTER CO., LTD. assumes no responsibility for any damage or loss caused by deletion of data as a result of malfunction, repairs, or battery replacement. Be sure to back up all important data on other media to protect against its loss.
- *The SD logo is a registered trademark.*
- *Windows, Internet Explorer, and DirectX are registered trademarks of Microsoft Corporation.*
- *Macintosh is a registered trademark of Apple Computer, Inc.*
- *MultiMediaCard™ is a trademark of Infineon Technologies AG of Germany, and licensed to the MultiMediaCard Association (MMCA).*
- *Acrobat and Acrobat Reader are trademarks of Adobe Systems Incorporated.*

- *The USB driver (mass storage) uses Phoenix Technologies Ltd. software.  
Compatibility Software Copyright © 1997  
Phoenix Technologies Ltd., All Rights Reserved.*
- *Other company, product and service names used herein may also be trademarks or service marks of others.*
- *Photo Loader and Photohands are the property of CASIO COMPUTER CO., LTD. Except as stipulated above, all copyrights and other related rights to these applications revert to CASIO COMPUTER CO., LTD.*

### Features

- High-resolution primary color CCD  
Everything from rich skin tones in portraits to fine details in scenery shots come out with amazingly realistic clarity.
- Effective Pixels  
QV-R3: 3.20 million pixels (3.34 million total pixels)  
QV-R4: 4.00 million pixels (4.13 million total pixels)
- 1.6-inch TFT color LCD monitor screen
- 9.6X seamless zoom  
3X optical zoom, 3.2X digital zoom
- 11MB flash memory  
Images can be recorded without using a memory card.
- Support for SD memory cards and MMC (MultiMedia Cards) for memory expansion
- Coupling Shot and Pre-shot  
Coupling Shot lets you combine two subjects into a single image, while Pre-shot lets you add a subject to a previously recorded background image. This means you can create images include you and your friend, even if you are the only two people around.
- Triple Self-timer Mode  
The self-timer can be set up to repeat three times, automatically.
- Best Shot  
Simply select the sample scene that matches the type of image you are trying to record and the camera performs troublesome setups automatically for beautiful pictures every time.
- Real-time histogram  
An on-screen histogram lets you adjust exposure as you view the effect on overall image brightness, which makes shooting under difficult lighting conditions easier than ever before.
- World Time  
A simple operation sets the current time for your current location. You can select from among 162 cities in 32 time zones.
- Alarm  
A built-in alarm helps to keep you on time for important events, and even can be used in place of an alarm clock. You can even have a specific image appear on the monitor screen when the alarm time is reached.
- Album Function  
HTML files are generated automatically to create an album of recorded images. Album contents can be viewed and printed using a standard Web browser. Images can also be incorporated into Web pages quickly and easily.



## INTRODUCTION

- **Easy Image Transfer**  
Transfer images to a computer simply by connecting the camera with a USB cable.
- **Bundled with Photo Loader and Photohands**  
Your camera comes bundled with the latest version of Photo Loader, the popular application that automatically loads images from your camera to your PC. Also included is Photohands, an application that makes image retouching quick and easy.
- **DCF Data Storage**  
DCF (Design rule for Camera File system) data storage protocol provides image inter-compatibility between the digital camera and printers.
- **Digital Print Order Format (DPOF)**  
Images can be printed easily in the sequence you want using a DPOF compatible printer. DPOF can also be used when specifying images and quantities for printing by professional print services.
- **PRINT Image Matching II Compatible**  
Images include PRINT Image Matching II data (mode setting and other camera setup information). A printer that supports PRINT Image Matching II reads this data and adjusts the printed image accordingly, so your images come out just the way you intended when you recorded them.

## Precautions

### General Precautions

Be sure to observe the following important precautions whenever using the QV-R3/QV-R4.

All references in this manual to “this camera” and “the camera” refer to the CASIO QV-R3/QV-R4 Digital Camera.

- Never try to take pictures or use the built-in display while operating a motor vehicle or while walking. Doing so creates the danger of serious accident.
- Never try to open the case of the camera or attempt your own repairs. High-voltage internal components create the risk of electric shock when exposed. Always leave maintenance and repair work up to CASIO service center.
- Never look at the sun or any other bright light through the camera’s viewfinder. Doing so can damage your eyesight.
- Keep the small parts and accessories of this camera out of the reach of small children. If swallowed accidentally, contact your physician immediately.
- Never fire the flash in the direction of a person operating a motor vehicle. Doing so can interfere with the driver’s vision and create the danger of accident.
- Never fire the flash while it is too close to the subject’s eyes. Intense light from the flash can cause eye damage if it is fired too close to the eyes, especially with young children. When using the flash, the camera should be at least one meter from the eyes of the subject.

## INTRODUCTION

- Keep the camera away from water and other liquids, and never let it get wet. Moisture creates the danger of fire and electric shock. Never use the camera outdoors in the rain or snow, at the seashore or beach, in the bathroom, etc.
- Should foreign matter or water ever get into the camera, immediately turn power off, unplug the AC adaptor from the power outlet, and contact your dealer or nearest CASIO service center. Using the camera under these conditions creates the danger of fire and electric shock.
- Should you ever notice smoke or a strange odor coming out of the camera, immediately turn power off and unplug the AC adaptor from the power outlet. Using the camera under these conditions creates the danger of fire and electric shock. After making sure there is no more smoke coming from the camera, take it to your nearest CASIO service center for repair. Never attempt your own maintenance.
- Never use the AC adaptor to power any other device besides this camera. Never use any other AC adaptor besides the one that comes with this camera.
- Never cover the AC adaptor with a quilt, blanket, or other cover while it is in use, and do not use it near a heater.
- At least once a year, unplug the AC adaptor from the power outlet and clean the area around the prongs of the plug. Dust build up around the prongs can create the danger of fire.
- If the camera's case should ever become cracked due to dropping it or otherwise subjecting it to rough treatment, immediately turn power off, unplug the AC adaptor from the power outlet, and contact your nearest CASIO service center.
- Never use the camera inside of an aircraft or in any other areas where its use is prohibited. Doing so can result in an accident.
- Physical damage and malfunction of this camera can cause the data stored in its memory to be deleted. Be sure to always keep backup copies of data by transferring them to personal computer memory.
- Never open the battery cover, disconnect the AC adaptor from the camera or unplug it from the wall socket while recording images. Doing so will not only make storage of the current image impossible, it can also corrupt other image data already stored in camera memory.

### Data Error Precautions

- Your digital camera is manufactured using precision digital components. Any of the following creates the risk of corruption of data in camera memory.
  - Removing the battery while image recording or data communication is in progress.
  - Removing a memory card while image recording is in progress.
  - Removing the battery, removing the memory card, or connecting the USB cable while the green operation lamp is still flashing after you turn off the camera.
  - Disconnecting the USB cable that connects the camera to a computer, while a data communication operation is being performed.
  - Using a battery that is low.
  - Other abnormal operations.

Any of the above conditions can cause an error message to appear on the monitor screen (page 139). Follow the instructions provided by the message to correct the situation.

### Operating conditions

- This camera is designed for use in temperatures ranging from 0°C to 40°C (32°F to 104°F).
- Do not use or keep the camera in the following areas.
  - In areas subject to direct sunlight
  - In areas subject to high humidity or dust
  - Near air conditioners, heaters, or other areas subject to temperature extremes
  - Inside of a closed vehicle, especially one parked in the sun
  - In areas subject to strong vibration

### Condensation

- When you bring the camera indoors on a cold day or otherwise expose it to a sudden change of temperature, there is the possibility that condensation can form on the exterior or on interior components. Condensation can cause malfunction of the camera, so you should avoid exposing it to conditions that might cause condensation.
- To keep condensation from forming, place the camera into a plastic bag before moving it into a location that is much warmer or colder than your current location. Leave it in the plastic bag until the air inside the bag has a chance to reach the same temperature as the new location. If condensation does form, remove the battery from the camera and leave the battery cover open for a few hours.

### LED Backlight

- The monitor screen is illuminated by an LED backlight. A dark monitor screen indicates that the LED backlight has reached the end of its service life, and needs to be replaced by a CASIO service center. Note that you will be charged for LED backlight replacement. The LED backlight brightness is reduced by half after about 1,000 hours of use.

### Lens

- Never apply too much force when cleaning the surface of the lens. Doing so can scratch the lens surface and cause malfunction.
- Fingerprints, dust, or any other soiling of the lens can interfere with proper image recording. Never touch the lens with your fingers. You can remove dust particles from the lens surface by using a lens blower to blow them off. Next, wipe the surface of the lens with a soft lens cloth.

### Other

- The camera may become slightly warm during use. This does not indicate malfunction.

## INTRODUCTION

### **GUIDELINES LAID DOWN BY FCC RULES FOR USE OF THIS UNIT IN THE U.S.A. (not applicable to other areas).**

This device complies with Part 15 of the FCC Rules. Operation is subject to the following two conditions: (1) this device may not cause harmful interference, and (2) this device must accept any interference received, including interference that may cause undesired operation.

#### **NOTICE**

This equipment has been tested and found to comply with the limits for a Class B peripheral, pursuant to Part 15 of the FCC Rules. These limits are designed to provide reasonable protection against harmful interference in a residential installation. This equipment generates, uses and can radiate radio frequency energy and, if not installed and used in accordance with the instructions, may cause harmful interference to radio communications. However, there is no guarantee that interference will not occur in a particular installation. If this equipment does cause harmful interference to radio or television reception, which can be determined by turning the equipment off and on, the user is encouraged to try to correct the interference by one or more of the following measures:

- Reorient or relocate the receiving antenna.
- Increase the separation between the equipment and receiver.
- Connect the equipment into an outlet on a circuit different from that to which the receiver is connected.
- Consult the dealer or an experienced radio/TV technician for help.

#### **FCC WARNING**

Changes or modifications not expressly approved by the party responsible for compliance could void the user's authority to operate the equipment.

### **Declaration of Conformity**

Model Number: QV-R3/QV-R4  
Trade Name: CASIO COMPUTER CO.,LTD.  
Responsible party: CASIO INC.  
Address: 570 MT. PLEASANT AVENUE,  
DOVER,NEW JERSEY 07801  
Telephone number: 973-361-5400

This device complies with Part 15 of the FCC Rules.  
Operation is subject to the following two conditions:  
(1) This device may not cause harmful interference, and  
(2) this device must accept any interference received, including interference that may cause undesired operation.

CASIO COMPUTER CO.,LTD. QV-R3/QV-R4



Tested To Comply  
With FCC Standards

FOR HOME OR OFFICE USE

# QUICK START GUIDE

## Getting Ready

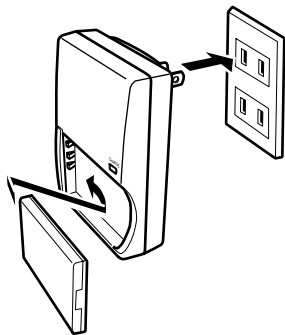

- 1. Attach the battery to the charger unit, and then charge it (page 23).**
  - It takes about two hours to achieve a full charge.
- 2. Load the battery into the camera (page 25).**
- 3. Configure screen message language, home time zone, and current time settings (page 36).**

## To record an image

(See page 38 for details.)

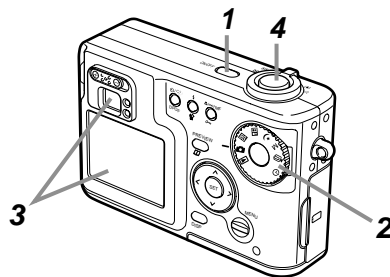



- 1. Press the power button to turn on the camera.**
- 2. Align the mode dial with  (Snapshot Mode).**
- 3. Point the camera at the subject, use the monitor screen or viewfinder to compose the image, and then press the shutter release button half way.**
- 4. Holding the camera still, gently press the shutter release button the rest of the way down.**

### To view a recorded image

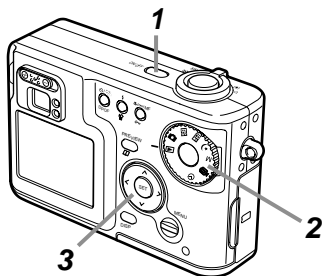
(See page 82 for details.)







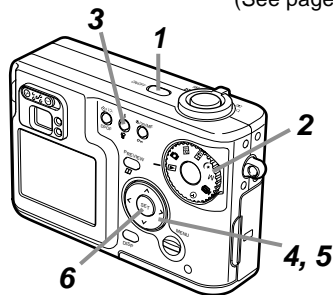

1. Press the power button to turn on the camera.
2. Align the mode dial with  (Play Mode).
3. Use [] and [] to scroll through the images.

### To delete an image

(See page 89 for details.)



1. Press the power button to turn on the camera.
2. Align the mode dial with  (Play Mode).
3. Press .
4. Use [] and [] to display the image you want to delete.
5. Use [] and [] to select "Delete."
  - To exit the image delete operation without deleting anything, select "Cancel."
6. Press SET to delete the image.

# GETTING READY

This section contains about things you need to know about and do before trying to use the camera.

## General Guide

The following illustrations show the names of each component, button, and switch on the camera.

### Front

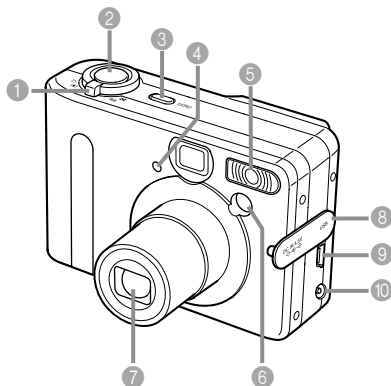

- 1 Zoom controller
- 2 Shutter release button
- 3 Power button
- 4 Self-timer lamp
- 5 Flash
- 6 AF assist lamp
- 7 Lens
- 8 Terminal panel cover
- 9 USB port
- 10 DC IN 4.5V terminal

### Open Terminal Panel Cover

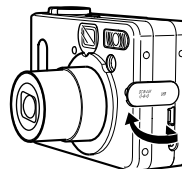

### Bottom

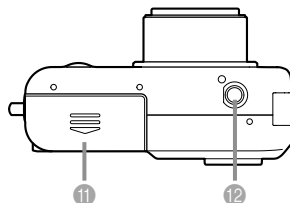

- 11 Battery compartment cover
- 12 Tripod screw hole  
\* Use this hole when attaching to a tripod.



## Back

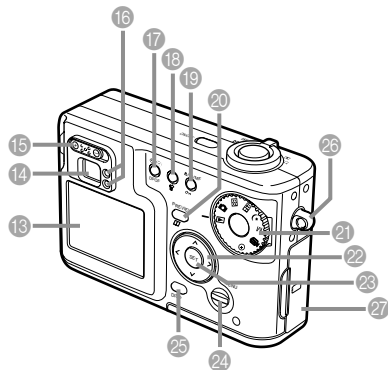

- 13 Monitor Screen
- 14 Viewfinder
- 15 Diopter slider
- 16 Operation lamp
- 17 DPOF (Self-timer/Continuous Shutter/DPOF) button
- 18 (Flash/Delete) button
- 19 (Macro/Infinity/Manual Focus/Protect) button
- 20 PREVIEW (Preview/Album) button
- 21 Mode dial
  - : Play Mode
  - : Snapshot Mode
  - : Best Shot Mode
  - : Coupling Shot Mode
  - : Night Scene Mode
  - : Manual Exposure Mode
  - : Movie Mode
  - : Interval Mode
- 22 [] [] []
- 23 SET button
- 24 MENU button
- 25 DISP button
- 26 Strap ring
- 27 Memory card slot cover

Recording modes

## Monitor Screen Contents

The monitor screen uses various indicators and icons to keep you informed of the camera's status.

### Recording Mode

#### Self-timer/Continuous

- |      |                              |
|------|------------------------------|
| None | 1-Image                      |
|      | Self-timer 10 sec            |
|      | Self-timer 2 sec             |
|      | Triple self-timer            |
|      | Continuous Shutter indicator |

#### Focus Mode indicator

- |      |              |
|------|--------------|
| None | Auto Focus   |
|      | Macro        |
|      | Infinity     |
|      | Manual Focus |

#### Manual focus position

#### Focus frame

- Focusing complete: Lights green
- Focusing failed: Lights red

Battery capacity

EV value

Date and time



Memory capacity  
(Remaining number  
of storable images)

#### Recording Mode

- Play Mode
- Snapshot
- Best Shot
- Coupling Shot
- Night Scene
- Manual Exposure
- Movie
- Interval

Recording modes

#### Image size

- 2304 × 1712 pixels (QV-R4)
- 2240 × 1680 pixels (QV-R4)
- 2048 × 1536 pixels (QV-R3)
- 1600 × 1200 pixels
- 1280 × 960 pixels
- 640 × 480 pixels
- Movie Recording: recording time (seconds)

#### Quality

- FINE
- NORMAL
- ECONOMY

- Built-in memory selected for data storage.
- Memory card selected for data storage.

## GETTING READY

**White balance indicator**

- None
- Auto
- Sunlight
- Shade
- Light Bulb
- Fluorescent
- Manual

**Metering Mode indicator**

- Multi-pattern Metering
- Center-weighted Metering
- Spot Metering

**Shutter speed value**

- An out of range aperture or shutter speed causes the corresponding monitor screen value to turn amber.

**Aperture value**

**Digital zoom indicator**

**Metering Mode indicator**

**Flash Mode indicator**

- None
- Auto
- Flash Off
- Flash On
- Red-eye reduction

**Zoom indicator**

Left side indicates optical zoom.  
Right side indicates digital zoom.

**Movie record indicator**

**REC**

**1600x1200**

**NORMAL**

**1/1000**

**F2.6**

**99**

**02/12/24**

**12:58**

## Play Mode

**Folder number/ File number**

**Image protection indicator**

**Image size**

- 2304 × 1712 pixels (QV-R4)
- 2240 × 1680 pixels (QV-R4)
- 2048 × 1536 pixels (QV-R3)
- 1600 × 1200 pixels
- 1280 × 960 pixels
- 640 × 480 pixels

**Quality**

- FINE
- NORMAL
- ECONOMY

**Built-in memory selected for data storage.**

**Memory card selected for data storage.**

**Battery capacity**

**Date and time**

**100-0024**

**1600x1200**

**NORMAL**

**02/12/24**

**12:58**

## Changing the Contents of the Monitor Screen

Each press of the DISP button changes the contents of the monitor screen as shown below.

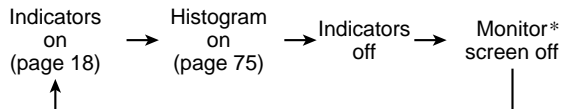

\* You cannot turn off the monitor screen in the Play Mode.

## Indicator Lamps

The color and condition (lit, unlit, flashing) of the indicator lamps keep you informed about the current status of the camera. For details, see “Indicator Lamp Reference” on page 133.

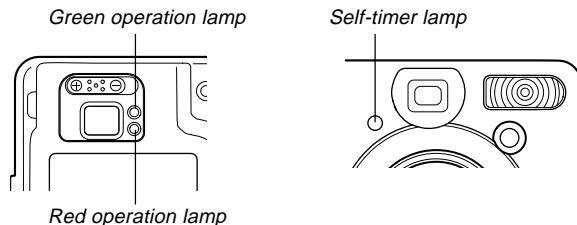

## GETTING READY

### Attaching the Strap

Attach the strap to the strap ring as shown in the illustration.

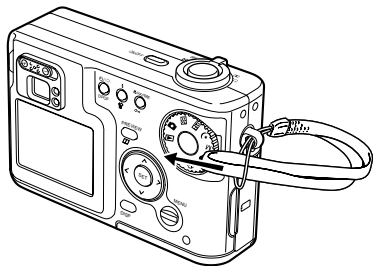

### ►► IMPORTANT! ◀◀

- Be sure to keep the strap around your wrist when using the camera to protect against accidentally dropping it.
- The supplied strap is intended for use with this camera only. Do not use it for any other application.
- Never swing the camera around by the strap.

### Using the Soft Case (Option)

We recommend that you keep the camera in the optional soft case when it is not in use.

Attach the strap of the soft case to the ring as shown in the illustration.

Soft case : QSC-4

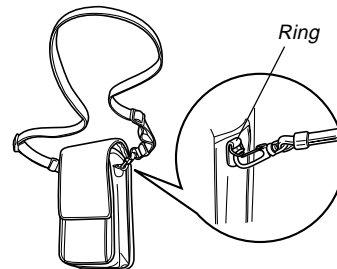

Use the buckle on the soft case strap to adjust its length.

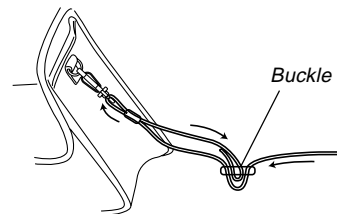

## GETTING READY

Insert the camera with the monitor screen facing downwards.

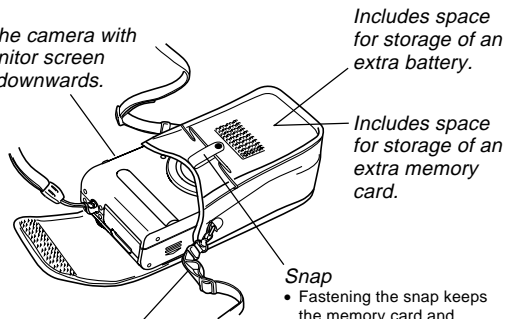

Includes space for storage of an extra battery.

Includes space for storage of an extra memory card.

**Snap**

- Fastening the snap keeps the memory card and battery from falling out.

**Belt loop**

- You can attach the bag to your belt.

## IMPORTANT!

- Use the soft case for storage of this camera, and its battery and memory card only.
- The strap that comes with the soft case is intended for use with the soft case only. Never use it for any other purpose.
- Never swing the camera around by the soft case strap.
- Wearing the soft case strap around your neck and allowing the camera to swing freely creates the risk of accident and personal injury caused by impact from the camera, by the camera becoming caught in a door, etc.
- Keep this camera out of the reach of small children. Children handling the camera creates the risk of serious accident should the soft case strap accidentally become wound around the neck.

## GETTING READY

### Power Requirements

Your camera can operate on either battery power or AC power.

- Battery  
One NP-30 rechargeable lithium ion battery

The battery is not charged when you purchase the camera. You need to charge the battery before using the camera for the first time.

- Household AC Power  
AC Adaptor: AD-C40 (Option)

### Using the Charger Unit

#### ■ Charger Unit General Guide

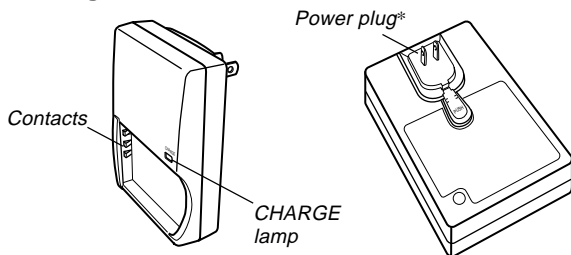

\* The shape of the power plug on the charger unit that comes with the camera depends on the geographic area where you purchase it.

#### ■ Attaching the Battery to the Charger Unit

Making sure that the positive and negative contacts are aligned correctly, affix the battery to the charger unit. Note that the battery will not charge properly if it is not positioned correctly on the charger unit.

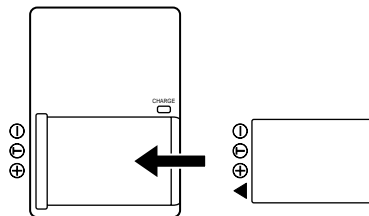

## ■ To charge the battery

**1. Positioning the positive and negative terminals of the battery as shown in the illustration, attach the battery to the charger unit.**

- Plug the charger unit into a household power outlet.

**2. The CHARGE lamp on the charger unit should turn red, indicating that charging has started.**

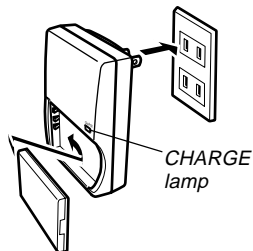

**3. Charging is complete when CHARGE lamp turns green. Unplug the charger unit from the power outlet, and then remove the battery from the charger unit.**

## ▶▶ IMPORTANT! ◀◀

- It takes about two hours to achieve a full charge. Actual charging time depends on current battery capacity and charging conditions.
- Use only the charger unit (BC-20) that comes with the camera to charge the special rechargeable lithium ion battery (NP-30). Never use any other charger device.
- Charging may not start immediately if you have just finished using the camera or if you are trying to charge the battery where it is very hot or very cold. This condition is indicated when the CHARGE lamp is flashing at slow speed. If this happens, simply move the battery to an area where temperature is more moderate (around 25°C (77°F)). The CHARGE lamp will turn red and charging will start when the battery temperature returns to the allowable charging temperature range.
- The CHARGE lamp flashes red at high speed during charging if the battery is not attached to the charger unit properly. Try removing it and then re-attaching the battery. If this does not correct the problem, it can mean there is something wrong with the charger unit or battery.
- If the charger unit contacts or battery terminals become dirty, wipe them clean with a cloth or cotton swab.
- Even though it looks removable, never try to remove the power plug from the charger unit.



### ■ Optionally Available Battery

You can purchase additional NP-30 rechargeable lithium ion battery for use this with camera as required.

Rechargeable Lithium Ion Battery: NP-30

- When an extra battery is not in use, keep it in the storage case that comes with each battery.
- Storing a battery with its terminals exposed creates the risk of shorting.
- If you are using only one battery, you should normally keep it loaded in the camera during transport. The battery that is bundled with the camera does not come with a storage case.

### ■ Inserting a Battery into Its Storage Case

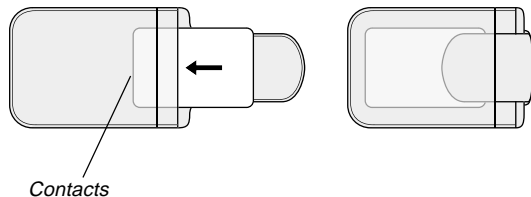

### To load the battery into the camera

1. Slide the battery cover on the side of the camera in the direction indicated by the arrow and then swing it open.

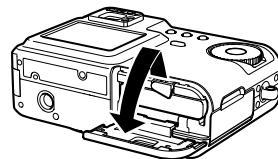

2. Slide the stopper in the direction indicated by the arrow in the illustration and hold it.

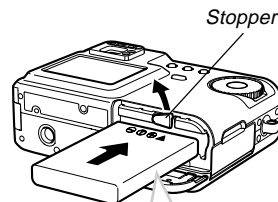

3. Orienting the battery so the contacts markings on the side of the battery are in the same order, from left to right, as the markings on the inside of the battery cover, slide the battery into the battery slot.

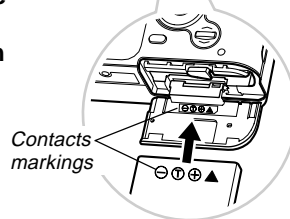

4. Swing the battery cover up and then slide it closed as you press down at the point indicated by the arrow in the illustration.

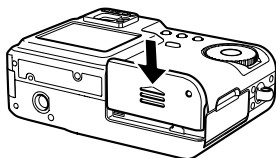

#### ▶▶ IMPORTANT! ◀◀

- Use only the special NP-30 rechargeable lithium ion battery to power this camera. Use of any other type of battery is not supported.

#### ▶▶ NOTE ◀◀

- To remove the battery from the camera, open the battery cover and hold the stopper so it does not stop the battery. Taking care to keep the battery from suddenly falling, angle the bottom of the camera downwards until the battery starts to come out. Next, pull the battery out the rest of the way.

## Battery Life

### ■ Battery Life Guidelines

The battery life guideline values given below indicate the amount of time at standard temperature (25°C (77°F)) until power automatically turns off due to battery failure. They do not guarantee that the battery will provide the amount of service indicated. Low temperatures and continued use reduce battery life.

Operation	Approximate Battery Life	
Continuous Recording*1	QV-R3	120 minutes (720 shots)
	QV-R4	110 minutes (660 shots)
Continuous Playback*2 (Continuous Snapshot Recording)	QV-R3	220 minutes
	QV-R4	220 minutes

#### \*1 Continuous Recording Conditions

- Normal temperature: 25°C (77°F)
- Flash: Off
- Monitor screen: On
- Image recorded about every 10 seconds using the following operations: Zoom to full wide angle → Auto Focus → Zoom to full close-up → Auto Focus → Image recording

#### \*2 Continuous Playback Conditions

- Normal temperature: 25°C (77°F)
- Scroll one image about every 10 seconds

## GETTING READY





- The above values are based a new battery starting from a full charge. Repeated charging shortens battery life.
- Battery life is greatly affected by how much you use flash, zoom and other functions, and how long you leave power turned on.

### ■ Tips to Make the Battery Last Longer

- If you do not need the flash while recording, select  (flash off) for the flash mode. See page 46 for more information.
- Enable the Auto Power Off and the Sleep features (page 33) to protect against wasting battery power when you forget to turn off the camera.
- Use the DISP button to turn off the monitor screen.

### ■ Low Battery Indicator

The following shows how the battery capacity indicator on the monitor screen changes as battery power is used. If you continue to use the camera while the battery level is , camera power will automatically turn off. When this happens, charge the battery as soon as possible.

Battery Level	High ←————→ Low
Indicator	 →  →  → 

- Pressing the shutter release button while  is displayed immediately shuts off the camera.

## Power Supply Precautions

### ■ Battery Handling Precautions

#### ● SAFETY PRECAUTIONS

Congratulations upon your selection on this CASIO Product. Be sure to read the following Safety Precautions before trying to use it for the first time. Keep these safety precautions and operating instructions on hand for future reference.

#### ))) NOTE (((

- All mentions of "the battery" in the following precautions refer to the CASIO NP-30 Rechargeable Lithium Ion Battery.

- Failure to observe any of the following precautions while using the battery creates the risk of over-heating, fire, and explosion.
  - Never use any other type of charger except the one specially specified for the battery.
  - Use this battery only with a product for which it is expressly specified.
  - Never use or leave the battery near open flame.
  - Never place the battery in a microwave oven, throw it into fire, or otherwise expose it to high heat.
  - Make sure the battery is oriented correctly when it is connected to the charger unit.
  - Never carry or store the battery together with items that can conduct electricity (necklaces, pencil lead, etc.).
  - Never try to take the battery apart, modify it in any way, or expose it to strong impact.
  - Do not immerse the battery in fresh water or salt water.
  - Do not use or leave the battery under direct sunlight, in an automobile parked in the sun, or in any other area subject to high temperatures.
- Should you ever notice leakage, strange odor, heat generation, discoloration, deformation, or any other abnormal condition while using, charging, or storing a battery, immediately remove it from the camera or charger unit and keep it away from open flame.

## GETTING READY

- If the battery does not achieve full charge after the normal charging time has passed, stop charging. Continued charging creates the risk of overheating, fire, and explosion.
- Battery fluid accidentally getting into your eyes can damage your eyes. Immediately rinse your eyes with clean tap water and then consult a physician.
- Be sure to read the User's Guide that comes with the camera and special charger unit before using or charging the battery.
- If the battery is to be used by young children, make sure that a responsible adult makes them aware of the precautions and proper handling instructions as contained in the User's Guide, and make sure that they handle the battery correctly.
- Should fluid from the battery accidentally get onto clothing or your skin, immediately rinse it off with clean tap water. Prolonged contact with battery fluid can cause skin irritation.

## ● PRECAUTIONS DURING USE

- This battery is designed for use with a CASIO digital camera only. See your camera's Users Guide to find out if it supports use of this battery.
- Use only the special charger unit to charge the battery. Never use any other type of charger unit for charging.
- This battery initially not charged. Be sure to charge the battery before using it for the first time.
- Use of a battery in cold environments shortens the operating time you can expect on a full charge.
- Charge the battery in a location where the temperature is in the range of 10°C to 35°C (50°F to 95°F). Charging outside this temperature range can cause charging to take longer than normal or even cause charging to fail.
- Very limited operation following a fully charge indicates that the battery has reached the end of its service life. Replace the battery with a new one.

### ● BATTERY STORAGE PRECAUTIONS

- Make sure you remove the battery from your camera when you do not plan to use the camera for a long time. A battery left in the camera discharges very small amounts of power even when camera power is turned off, which can lead to a dead battery or a longer charging time.
- Store the battery in a cool, dry place (20°C (68 °F) or lower).

### ● USING THE BATTERY

- See the User's Guide that comes with the special charger unit and the digital camera for information about charging procedures and charging time.
- When transporting a battery, keep it either loaded in the digital camera or stored in its case.

### ■ Charger Unit Precautions

- Never plug the charger unit into an outlet whose voltage rating is different from that marked on the charger unit. Doing so creates the risk of fire, malfunction, and electric shock.
- Never plug in or unplug the charger unit while your hands are wet. Doing so creates the risk of electric shock.
- Do not plug the charger unit into an outlet or extension cord that is shared by other devices. Doing so creates the risk of fire, malfunction, and electric shock.
- The charger unit becomes slightly warm during charging. This is normal and does not indicate malfunction.
- Unplug the charger unit from the power outlet whenever you are not using it.

## Using AC Power

Use the adaptor as shown below to power the camera from a household power outlet.

1. Open the camera's terminal panel cover.
2. Plug the AC adaptor to the DC IN 4.5V terminal.

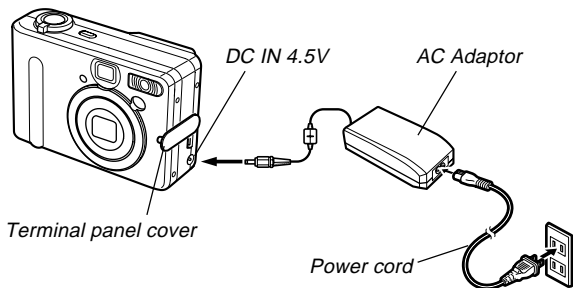

- AC adaptor: AD-C40

The AC adaptor can be used with any power source rated from 100V to 240V AC. If you plan to use the AC adaptor in another country, it is up to you to purchase the applicable power cord that matches the configuration of power receptacles in that country.

## ■ Adaptor Precautions

- Never use an electrical outlet whose voltage is outside the rating marked on the AC adaptor. Doing so can create the danger of fire or electric shock. Use only the optional AC adaptor specified for this camera.
- Do not allow the AC adaptor power cord to become cut or damaged, do not place heavy objects on it, and keep it away from heat. A damaged power cord creates the risk of fire and electric shock.
- Never try to modify the AC adaptor power cord, or subject it to severe bending, twisting, or pulling. Doing so creates the risk of fire and electric shock.
- Never touch the AC adaptor while your hands are wet. Doing so creates the risk of electric shock.
- Do not overload extension cords or wall outlets. Doing so creates the danger of fire and electric shock.
- Should the cord of the AC adaptor become damaged (exposed internal wiring), request a replacement from a CASIO service center. A damaged AC adaptor cord creates the danger of fire or electric shock.
- Be sure to turn off power before connecting or disconnecting the adaptor.
- Always turn camera power off before disconnecting the AC adaptor, even if the camera has a battery installed. If you don't, the camera will turn off automatically when you disconnect the AC adaptor. You also run the risk of damaging the camera whenever you disconnect the AC adaptor without first turning power off.

## GETTING READY

- The AC adaptor may become warm to touch after extended periods of use. This is normal and is not cause for alarm.
- After using the camera, turn it off and unplug the adaptor from the AC outlet.
- The camera automatically switches over to AC adaptor powered operation whenever the AC adaptor is plugged into the camera.
- Always use the AC adaptor to power the camera whenever it is connected to a computer.
- Never place a blanket or any other cover on the AC adaptor. Doing so creates the risk of fire.

## Turning the Camera On and Off

Press the power button to turn the camera on and off. Pressing the power button to turn on the camera causes the green operation lamp to flash. Press the power button again to turn off the camera.

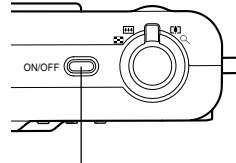

*Power button*

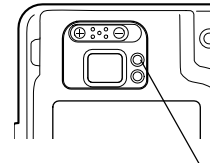

*Green operation lamp*

### ►► IMPORTANT! ◀◀

- If camera power is turned off by the Auto Power Off feature, press the power button to turn it back on again.
- Turning on camera power while the mode dial is set to recording mode causes the lens to extend from the camera. Make sure there is nothing in front of the camera that can be hit by the lens when you turn on the camera.



## Configuring Power Saving Settings

You can configure the settings described below to conserve battery power.

**Auto Power Off:** Turns off power if you do not perform any operation for a specified amount of time.

**Sleep** : Automatically turns off the monitor screen if no operation is performed for a specified amount of time in a recording mode. Performing any button operation causes the monitor screen to turn back on.

1. Align the mode dial with  (Snapshot Mode).
2. Press MENU.
3. Use [←] and [→] to select the “Set Up” tab.
4. Use [^] and [v] to select the feature whose setting you want to configure, and then press SET.

- See page 34 for information about how to use menus.

To configure this feature:	Select this setting:
Auto Power Off	Auto Power Off
Sleep	Sleep

### 5. Use [^] and [v] to change the currently selected setting, and then press SET.

- Available Auto Power Off settings are: 3 min, 5 min, and off.
- Available Sleep settings are: 30 sec, 1 min, 2 min, and off.
- Note that the Sleep feature does not operate in the Play Mode.
- Pressing any button while the camera is in the Sleep state immediately turns the monitor screen back on.
- The Auto Power Off and Sleep features are disabled while the camera is connected to a computer via the USB port.

## Using the On-screen Menus

Pressing the MENU button displays a menu of operations on the camera's monitor screen. The contents of the menu depend on whether the camera is in a recording mode or the Play Mode. The following explanation of basic menu operations uses the recording mode menu.

### 1. Turn on the camera, and then align the mode dial with .

- If you want to enter the Play mode instead, you would align the mode dial with .

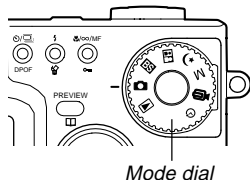

### 2. Press MENU.

- This displays the menu screen.

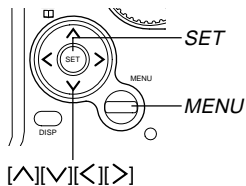

**Settings**  
Selection cursor (indicates the currently selected item)

## ● Menu Screen Operations

When you want to do this:	Do this:
Move between tabs	Press [ <b>&lt;</b> ] and [ <b>&gt;</b> ].
Move from the tab to the settings	Press [ <b>v</b> ].
Move from the settings to the tab	Press [ <b>^</b> ].
Move between the settings	Press [ <b>^</b> ] and [ <b>v</b> ].
Display the options available for a setting	Press [ <b>&gt;</b> ] or press SET.
Select an option	Press [ <b>^</b> ] and [ <b>v</b> ].
Register an option selection and exit the menu screen	Press SET.
Register an option selection and return to the menu screen	Press [ <b>&lt;</b> ].
Exit the menu screen	Press the MENU button.

## GETTING READY

**3. Press [ < ] or [ > ] to select the tab you want, and then press SET to move the selection cursor from the tab to the settings.**

**4. Use [ ^ ] and [ v ] to select the feature whose setting you want to configure, and then press [ > ].**

- Instead of pressing [ > ], you could also press SET.

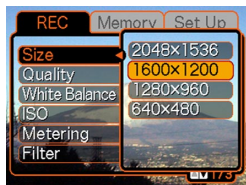

*Example: To select the "Size" item.*

**5. Use [ ^ ] and [ v ] to change the currently selected setting, and then press SET.**

- This applies the setting.

## NOTE

- The recording mode menu appears if you press the MENU button before starting a record operation. It will not appear if you press the MENU button during a setup procedure, while the camera is standing by for recording of the second image of a Coupling Shot operation, etc.
- See "Menu Reference" on page 131 for more information about menus.

### Configuring Display Language and Clock Settings

Be sure to configure the following settings before using the camera to record images.

- Display language
- Home city
- Date and time

Note that the current date and time settings are used by the camera to generate the date and time that is stored along with image data, etc.

### ▶▶ IMPORTANT! ◀◀

- The camera's clock settings are cleared if power to the camera is totally cut off for about 12 hours. This can happen if the battery goes dead while the camera is not being supplied power by the AC adaptor. The clock setting screen will appear automatically the next time you turn on power after the settings are cleared. Set the date and time before using the camera.
- You also need to configure clock settings whenever you replace the battery.
- Recording images without configuring the clock settings causes incorrect time information to be registered. Be sure to configure the clock settings before using the camera.

## GETTING READY

1. Press the power button to turn on the camera.
2. Use [^] and [v] to select the language you want, and then press SET.

日本語 : Japanese  
English : English  
Français : French  
Deutsch : German  
Español : Spanish  
Italiano : Italian

3. Use [^], [v], [<], and [>] to select the geographical area where you live, and then press SET.



4. Use [^] and [v] to select the name of the city where you live, and then press SET.



5. Use [^] and [v] to select the summer time (DST) setting you want, and then press SET.

When you want to do this:	Select this setting:
Keep time using standard time	Off
Keep time using summer time (Daylight Saving Time)	On

6. Set the current date and the time.

To do this:	Do this:
Move the cursor between settings	Press [^] and [v].
Change the setting at the current cursor location	Press [ < ] and [ > ].
Toggle between 12-hour and 24-hour timekeeping	Press DISP.

7. Press SET to register the settings and exit the setting screen.

# BASIC IMAGE RECORDING

This section describes the basic procedure for recording an image.

## Recording an Image

Your camera is equipped with a variety of different recording modes. The explanation in this section is presented using the Snapshot Mode. The camera automatically adjusts shutter speed and aperture settings in accordance with the brightness of the subject. Images you record are stored in the camera's built-in flash memory.

- You can also use optionally available SD memory cards and MultiMedia Cards (MMC) to store images (page 104).

### 1. Press the power button to turn on the camera.

- This causes an image or a message to appear on the monitor screen.

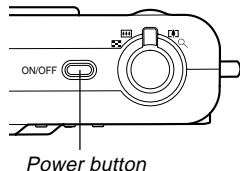

### 2. Align the mode dial with (Snapshot Mode).

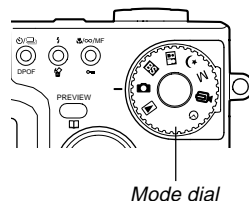

### 3. Compose the image on the monitor screen so the main subject is within the focus frame.

- The focusing range of the camera is approximately 40cm (1.3') to infinity ( $\infty$ ).
- You can compose images using either the monitor screen or the optical viewfinder (page 43).
- When using the optical viewfinder to compose images, you can use the DISP button to turn off the monitor screen and conserve battery power.

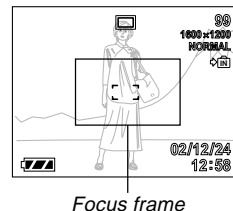

## BASIC IMAGE RECORDING

### 4. Press the shutter release button half way to focus the image.

- When you press the shutter release button half way, the camera's Auto Focus feature automatically focuses the image, and displays the shutter speed and aperture values.
- You can tell whether the image is focused by observing the focus frame and the green operation lamp.

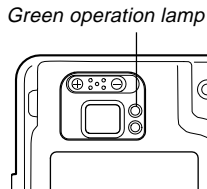
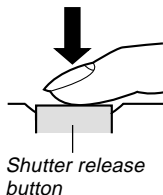

### ● Operation Lamp and Focus Frame Operation

When you see this:	It means this:
Green focus frame Green operation lamp	The image is focused.
Red focus frame Flashing green operation lamp	The image is not in focus.

- Make sure you are not blocking the lens, the AF assist lamp, or the flash with your fingers while recording an image.

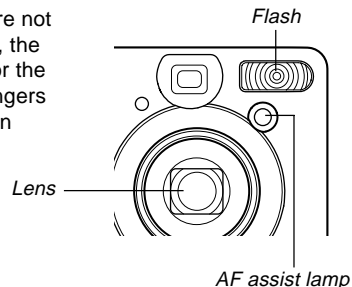

### 5. After making sure that the image is focused properly, press the shutter release button the rest of the way down to record.

- The recorded image is stored temporarily into buffer memory. After that, it is saved in the camera's built-in flash memory or onto a memory card, if one is loaded in the camera. You can record consecutive Continuous Shutter images as long as there is still buffer memory available to store them.
- The number of images that can be stored in memory depends on the resolution setting you are using (page 140).
- Press the shutter release button gently to avoid camera movement.

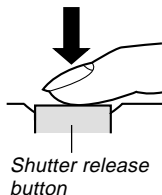

## Recording Precautions

- Never open the battery cover while the green operation lamp is flashing. Doing so not only causes the current image to be lost, it can also corrupt images already stored in camera memory and even lead to malfunction of the camera.
- Never remove the memory card while an image is being recorded to the memory card.
- Fluorescent lighting actually flickers at a frequency that cannot be detected by the human eye. When using the camera indoors under such lighting, you may experience some brightness or color problems with recorded images.
- The camera automatically adjusts its sensitivity in accordance with the brightness of the subject. This can cause some static noise to appear in images of relatively dark subjects.
- For a dimly lit subject, the camera raises the sensitivity and uses a faster shutter speed. Because of this, you need to guard against camera movement if you have flash turned off (🔇) when recording a dimly lit subject (page 46).



### About Auto Focus

- Auto Focus tends not to work well if the camera is moved during recording, or when recording the types of subjects listed below.
  - Solid color walls or objects with little contrast
  - Strongly backlit objects
  - Polished metal or other brightly reflective objects
  - Venetian blinds or other horizontally repeating patterns
  - Multiple images that are varying distances from the camera
  - Subjects in poorly lit areas
  - Moving subjects
- Note that a green operation lamp and focus frame do not necessarily guarantee that an image is in focus.
- If Auto Focus does not produce the results you want for some reason, try using focus lock (page 57) or manual focus (page 55).

### About the Recording Mode Monitor Screen

- The image shown on the monitor screen in a recording mode is a simplified image for composing purposes. The actual image is recorded in accordance with the image quality setting currently selected on your camera. The image saved on memory has much better resolution and detail than a recording mode monitor screen image.
- Certain levels of subject brightness can cause the response of the monitor screen in a recording mode to slow down, which causes some static noise in the monitor screen image.

### Previewing the Last Image Recorded

Use the following procedure to preview the last image recorded, without leaving the current recording mode.

#### 1. Press the PREVIEW button to display the last image recorded.

- Pressing the PREVIEW button again returns to the recording mode.
- The PREVIEW button does not perform any operation if you press it immediately after turning on camera power or immediately after entering to the recording mode from the Play mode.
- Image preview cannot be used in the Movie Mode. The preview image is cleared automatically whenever the recording mode is changed.

### Deleting an Image in a Recording Mode

You can use following procedure to delete the last image you recorded without leaving the current recording mode.

#### ►► IMPORTANT! ◀◀

- Note that the image delete operation cannot be undone. Make sure you really do not need an image before you delete it.

#### 1. In a recording mode, press the PREVIEW button to display the last image you recorded.

#### 2. Press .

#### 3. In response to the confirmation message that appears, select “Delete.”

- Select “Cancel” to cancel the delete operation without deleting anything.

#### 4. Press SET.

- This deletes the image and returns to the recording mode.

### Using the Optical Viewfinder

Turning off the camera's monitor screen and using its optical viewfinder to compose images helps to conserve battery power.

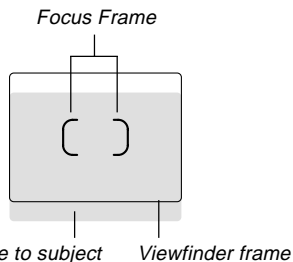

#### ▶▶ IMPORTANT! ◀◀

- The frame that is visible inside of the viewfinder indicates the image recorded at a distance of about three meters (9.8'). When the subject is closer or further away than three meters, the recorded image will be different from what you see inside the viewfinder frame.
- The monitor screen turns on automatically whenever you select the Macro Mode or Manual Focus Mode. Always use the monitor screen to compose images in these modes.

### Adjusting the View of the Optical Viewfinder

You can use the diopter slider to adjust the view of the viewfinder to match your eyesight. Adjust the diopter slider so the image in the viewfinder is clear.

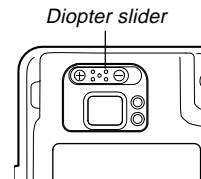

#### ▶▶ IMPORTANT! ◀◀

- The diopter slider does not work when the camera is turned off or in the Play Mode. Be sure to enter a recording mode before adjusting the diopter setting.

### Using Zoom

Your camera is equipped with two types of zoom: optical zoom and digital zoom.

### Optical Zoom

Optical zoom alters the focal distance of the lens. The range of the zoom factor is shown below.

Zoom Factor Range: 1X to 3X

**1. Enter a recording mode.**

**2. Shift the zoom controller to change the zoom factor.**

 (Wide Angle): Zooms out.

 (Telephoto) : Zooms in.

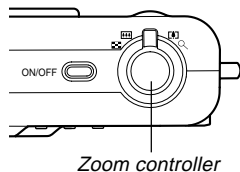

Zoom in

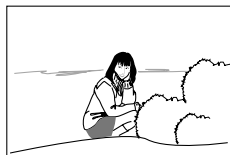

Zoom out

**3. Compose the image and then press the shutter release button.**

### NOTES



- The optical zoom factor also affects the lens aperture.
- Use of a tripod is recommended to protect against hand movement when using the telephoto setting (zoom in).



## Digital Zoom

Digital zoom is activated after you reach the maximum optical zoom factor (3X). It enlarges the part of the image at the center of the image screen. The range of the digital zoom factor is shown below.

Zoom Factor Range : 3X to 9.6X  
(in combination with optical zoom)

1. In a recording mode, press MENU.
2. Use [ < ] and [ > ] to select the “REC” tab.
3. Use [ ^ ] and [ v ] to select “Digital Zoom,” and then press [ > ].
4. Select “On,” and then press SET.
  - Selecting “Off” disables digital zoom.

5. Slide the zoom controller towards [  ] (Telephoto)/  to change the zoom factor.

- When zoom reaches maximum optical zoom, it stops momentarily. Keep the zoom controller pressed to the [  ] (Telephoto)/  side and zoom will switch over to digital zoom.
- This causes the zoom indicator to appear on the monitor screen. The zoom indicator shows the current approximate zoom factor.

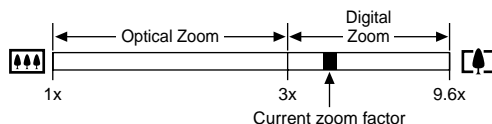
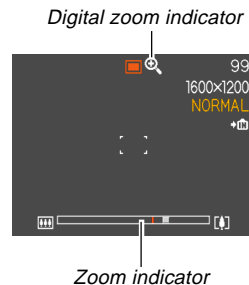

6. Compose the image and then press the shutter release button.

### ▶▶ IMPORTANT! ◀◀

- Digital zoom is disabled whenever the monitor screen is turned off (page 20).

## BASIC IMAGE RECORDING

### Using the Flash

Perform the following steps to select the flash mode you want to use.

1. In a recording mode, press MENU.

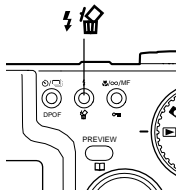

2. Press  to select the flash mode.

- Each press of  cycles through the flash mode settings shown below on the monitor screen.

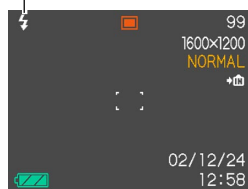

Flash mode indicator



To do this:	Select this setting:
Have the flash fire automatically when required (Auto Flash)	None
Turn off the flash (Flash Off)	
Always fire the flash (Flash On)	
Fire a pre-flash followed by image recording with flash, reducing the chance of red-eye in the image (Red-eye reduction) Have the flash fire automatically when required	

3. Record the image.

#### IMPORTANT!

- The flash unit of this camera fires a number of times when you record an image. The initial flashes are pre-flashes, which the camera uses to obtain information that it uses for exposure settings. The final flash is for recording. Make sure that you keep the camera still until the shutter releases.
- Image recording may not be performed if you press the shutter release button while the red operation lamp is flashing.

### ■ About Red-eye Reduction

Using the flash to record at night or in a dimly lit room can cause red spots inside the eyes of people who are in the image. This is caused when the light from the flash reflects off of the retina of the eye. When red-eye reduction is selected as the flash mode, the camera performs two pre-flash operations, one designed to cause the irises in the eyes of any people in the image to close, and one for the Auto Focus operation. This is followed by another flash operation for actual recording of the image.

### ▶▶ IMPORTANT! ◀◀

Note the following important points when using red-eye reduction.

- Red-eye reduction does not work unless the people in the image are looking directly at the camera during the pre-flash or AF assist lamp flash operation. Before pressing the shutter release button, call out to the subjects so they all look at the camera while one of the pre-flash operations is performed.
- Red-eye reduction may not work very well if the subjects are located far away from the camera.

### Flash Unit Status

You can find out the current flash unit status by pressing the shutter release button half way and checking the monitor screen and red operation lamp.

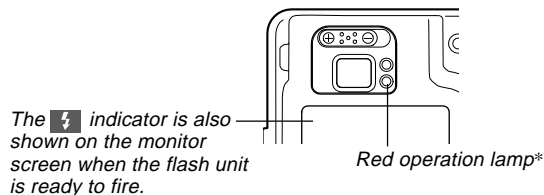

#### \* Red operation lamp

When the red operation lamp is this:	It means this:
Flashing	Flash unit is charging
Lit	Flash unit is ready to fire

## Changing the Flash Intensity Setting

Perform the following steps to change the flash intensity setting.

1. In a recording mode, press **MENU**.
2. Use [**<**] and [**>**] to select the “REC” tab.
3. Use [**^**] and [**v**] to select “Flash Intensity,” and then press [**>**].
4. Select the setting you want and then press **SET**.

To do this:	Select this setting:
Fire the flash with strong intensity	Strong
Fire the flash with normal intensity	Normal
Fire the flash with weak intensity	Weak

- Flash intensity may not change if the subject is too far or too close to the camera.

## Flash Precautions

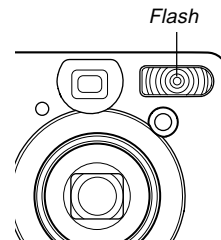

Take care that your fingers do not block the flash when you hold the camera. Covering the flash with your finger can greatly reduce its effectiveness.



- The approximate effective range of the flash is shown below. The flash is unable to adequately illuminate a subject that is outside this range.

QV-R3: 0.4 meter to 3.2 meters (1.3' to 10.5')

QV-R4: 0.4 meter to 2.8 meters (1.3' to 9.2')

- The flash takes anywhere from a few seconds to as long as 10 seconds to attain full charge after being fired. The actual time required depends on the battery level, temperature, and other conditions.
- The flash does not fire in the Movie Mode and in the Continuous Shutter Mode. This is indicated by  (Flash Off) on the monitor screen.
- The flash unit may not be able to charge when battery power is low. Low battery power is indicated by  (Flash Off) on the monitor screen, and when the flash fails to fire properly resulting in poor image exposure. When these symptoms occur, charge the camera's battery as soon as possible.



## BASIC IMAGE RECORDING

- When the red-eye reduction mode (👁️) is being used, flash intensity is adjusted automatically in accordance with the exposure. The flash may not fire at all when the subject is brightly lit.
- White balance is fixed while the flash is being used, so sunlight, fluorescent lighting, or other sources of illumination in the immediate area may affect the coloring of the recorded image.

### Using the Self-timer

The self-timer lets you select either a 2-second or 10-second delay of the shutter release after you press the shutter release button. A Triple Self-timer feature lets you perform three consecutive self-timer operations to record three images.



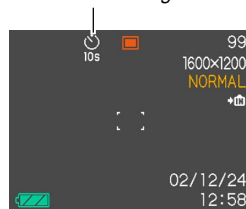

#### 1. In a recording mode, press 📷/📷 DPOF to select the self-timer setting you want.

- Each press of 📷/📷 DPOF cycles the self-timer between the settings described below.

Self-timer setting



## BASIC IMAGE RECORDING

To do this:	Select this setting:
Disable the self-timer	No icon displayed
Specify a 10-second self-timer	
Specify a 2-second self-timer	
Specify Triple Self-timer	
Specify Continuous Shutter recording (no self-timer)	

- See page 59 for information about Continuous Shutter recording.
- With the Triple Self-timer, the first image is recorded after a 10-second countdown. After that the second image is recorded after a 3-second countdown, and the third image is recorded after another 3-second countdown.

## 2. Record the image.

- When you press the shutter release button, the self-timer lamp flashes and the shutter releases after the self-timer reaches the end of its countdown.
- You can interrupt an ongoing self-timer countdown by pressing the shutter release button while the self-timer lamp is flashing.

*Self-timer lamp*

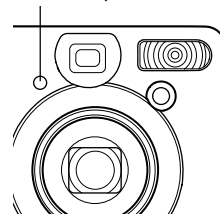

### »» NOTES ««

- The hand-shake limiter is enabled when you use a slow shutter speed and the two-second self-timer at the same time.
- You cannot use the self-timer in combination with the Continuous Shutter Mode (page 59).

## Specifying Image Size and Quality

You can specify the image size and image quality to suit the type of image you are recording.

### To specify the image size

1. In a recording mode, press **MENU**.
2. Use [**<**] and [**>**] to select the “REC” tab.
3. Use [**^**] and [**v**] to select “Size,” and then press [**>**].
4. Use [**^**] and [**v**] to change the current setting, and then press **SET**.

To record an image of this size:	Select this setting:
2304 X 1712 pixels (QV-R4)	2304 X 1712
2240 X 1680 pixels (QV-R4)	2240 X 1680
2048 X 1536 pixels (QV-R3)	2048 X 1536
1600 X 1200 pixels	1600 X 1200
1280 X 960 pixels	1280 X 960
640 X 480 pixels	640 X 480

#### NOTE

- Use the larger pixel settings when you plan to produce a large print of the image. Use 640 X 480 when you need to economize on space because you plan to send images in e-mail, etc.

## To specify the image quality

1. In a recording mode, press **MENU**.
2. Use [**<**] and [**>**] to select the “**REC**” tab.
3. Use [**^**] and [**v**] to select “**Quality**,” and then press [**>**].
4. Use [**^**] and [**v**] to change the current setting, and then press **SET**.

To get this:	Select this setting:
Very high quality, but large file size	Fine
Normal quality	Normal
Small file size, but low quality	Economy

### NOTE

- Use the “**Fine**” setting when image quality is your top priority, and file size is secondary. Conversely, use the “**Economy**” setting when file size is your top priority and image quality is secondary.

### IMPORTANT!

- Actual file size depends on the type of image you record. This means that the remaining image capacity noted on the monitor screen may not be exactly accurate (pages 18 and 140).

# OTHER RECORDING FUNCTIONS



This chapter describes the other powerful features and functions that are available for recording.

## Selecting the Focus Mode

You can select one of four different focus modes: Auto Focus, Macro, Infinity, and Manual.

1. Enter a recording mode.

2. Press /∞/MF .

- Each press of /∞/MF  cycles through the focus mode settings in the sequence shown below.

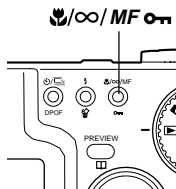
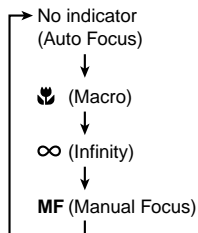

Focus mode indicator

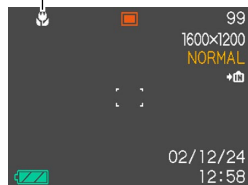

## Using Auto Focus

As its name suggests, Auto Focus focuses the image automatically. The automatic focus operation starts when you press the shutter release button down half way. The following is the Auto Focus range.

Range: Approximately 40cm to ∞ (1.3' to ∞)

1. Keep pressing /∞/MF  until there is no focus mode indicator on the display.

2. Compose the image so the main subject is within the focus frame, and then press the shutter release button half way.

- You can tell whether the image is focused by observing the focus frame and the green operation lamp.

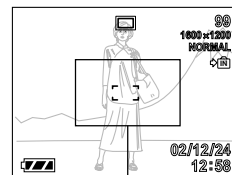

Focus frame

## OTHER RECORDING FUNCTIONS

When you see this:	It means this:
Green focus frame Green operation lamp	The image is focused.
Green flashing focus frame Flashing green operation lamp	The image is not in focus.

### 3. Press the shutter release button the rest of the way to record the image.

## Using the Macro Mode

The Macro Mode lets you focus automatically on close up subjects. The automatic focus operation starts when you press the shutter release button down half way. The following is the focus range in the Macro Mode.

Approximately 14cm to 50cm (5.5" to 19.7")

### 1. Keep pressing /∞/MF until the is on the display.

### 2. Record the image.



- The focus and image recording operations are identical to those in the Auto Focus Mode.
- You can tell whether the image is focused by observing the focus frame and the green operation lamp. The indications of the focus frame and green operation lamp are the same as those in the Auto Focus Mode.

### ▶▶ IMPORTANT! ◀◀

- Optical zoom is disabled in the Macro Mode. Zoom is fixed at maximum wide angle.

## Using the Infinity Mode



The Infinity Mode fixes focus at infinity ( $\infty$ ). Use this mode when recording scenery and other faraway images.

1. Keep pressing / $\infty$ /MF  until the  $\infty$  is on the display.
2. Record the image.

## Using Manual Focus

With the Manual Focus Mode, you can adjust the focus of an image manually. The following shows focus ranges in the Macro Mode for two optical zoom factors.

Optical Zoom Factor	Approximate Focus Range
1X	14cm (0.5') to infinity ( $\infty$ )
3X	40cm (1.3') to infinity ( $\infty$ )

1. Keep pressing / $\infty$ /MF  until MF is on the display.

- At this point, a boundary also appears on the display, indicating the part of the image that will be used for manual focus.

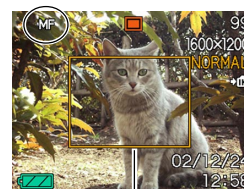

*Boundary*

## OTHER RECORDING FUNCTIONS

2. While watching the image on the monitor screen, use [^] and [v] to focus.



Manual focus position

To do this:	Do this:
Focus out on the subject	Press [^].
Focus in on the subject	Press [v].

- Pressing [^] or [v] causes the area inside of the boundary displayed in step 1 to fill the monitor screen momentarily to aid in focus. The normal image reappears a short while later.
3. Press the shutter release button to record the image.



## Using Focus Lock

Focus lock is a technique you can use to focus on a subject that is not located within the focus frame when you record an image. You can use focus lock in the Auto Focus Mode and the Macro Mode (📷).

- Using the monitor screen, compose the image so the main subject is within the focus frame, and then press the shutter release button half way.

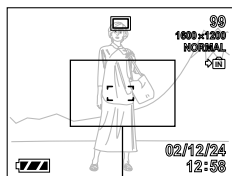

*Focus frame*

- The focus and image recording operations are identical to those in the Auto Focus Mode.
- You can tell whether the image is focused by observing the focus frame and the green operation lamp. The indications of the focus frame and green operation lamp are the same as those in the Auto Focus Mode.

- Keeping the shutter release button half way down, re-compose the image as you like.

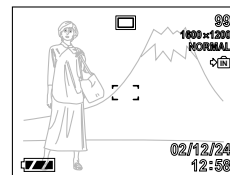

- When the image is composed the way you want, press the shutter release button the rest of the way to record it.

### NOTE

- Locking the focus also locks the exposure.

## Exposure Compensation (EV Shift)

Exposure compensation lets you change the exposure setting (EV value) manually to adjust for the lighting of your subject. This feature helps to achieve better results when recording a backlit subject, a strongly lit subject indoors, and a subject that is against a dark background.

Exposure Compensation Range:  $-2.0\text{EV}$  to  $+2.0\text{EV}$

Steps:  $1/3\text{EV}$

### 1. In a recording mode, press [ $\leftarrow$ ] and [ $\rightarrow$ ].

- This causes the exposure compensation value to appear on the monitor screen.

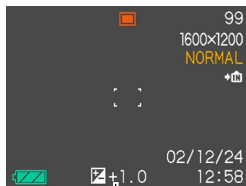

EV value

Press [ $\rightarrow$ ] to increase the EV value. A higher EV value is best used for light-colored subjects and backlight subjects.



Press [ $\leftarrow$ ] to decrease the EV value. A lower EV value is best for dark-color subjects and for shooting outdoors on a clear day.

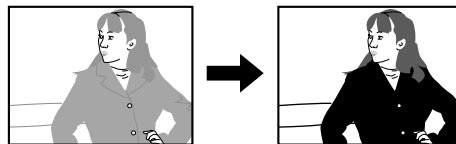

- To cancel exposure compensation, adjust the value until it becomes zero.



### 2. Compose the image and then press the shutter release button.

#### ▶▶ IMPORTANT! ◀◀

- When shooting under very dark or very bright conditions, you may not be able to obtain satisfactory results even after performing exposure compensation.

### Recording Consecutive Images (Continuous Shutter Mode)

The Continuous Shutter Mode records images as long as you keep the shutter release button depressed. Note that the length of the interval between images depends on the image quality setting.

**1. Press /  DPOF to select the Continuous Shutter Mode (page 49).**

- The Continuous Shutter Mode is selected when the  indicator is on the monitor screen.

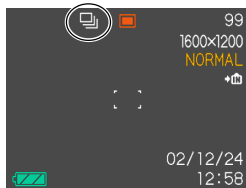

**2. Hold down the shutter release button to record the images you want.**

### IMPORTANT!

- The flash does not fire during continuous shutter recording.
- You cannot use the self-timer in combination with the continuous shutter mode.
- Never remove the battery or memory card from the camera or unplug the AC adaptor while images are being saved to memory.

### Combining Shots of Two People into a Single Image (Coupling Shot)

The Coupling Shot Mode lets you record images of two people and combine them into a single image. This makes it possible for you to include yourself in group images, even when there is no one else around to record the image for you.

- First Image



This is the part of the image that does not include the person who is recording the first image.





- Second Image

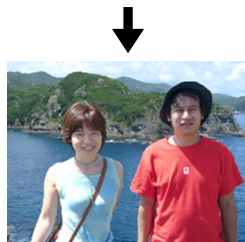

Making sure that the background of the image is aligned correctly, record the image of the person who recorded the first image.

- Combined Images



1. Align the mode dial with  (Coupling Shot Mode).

2. First, align the focus frame on the monitor screen with the subject you want on the left side of the image, and then press the shutter release button to record the image.

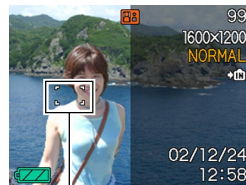

Focus frame

- The following settings are fixed for this image: focus, exposure, white balance, zoom, flash.

## OTHER RECORDING FUNCTIONS

**3. Next, align the focus frame with the subject you want in the right side of the image, taking care to align the actual background with the semi-transparent image of the background of the first image, which is shown on the monitor screen. When everything is aligned correctly, record the image.**

- Pressing MENU any time after step 2 of the above procedure cancels the first image and returns to step 2.



*Semi-transparent image*

### NOTE

- The Best Shot Mode (page 64) includes three sample scenes that use Coupling Shot. One of the scenes uses two shots on the left half and the right half of the image, as described in the procedure above. The first shot of the other two Coupling Shot sample scenes uses the left 1/3 of the image, while that of the remaining sample scene uses the right 1/3 of the image. Note, however, that the Coupling Shot sample scenes in the Best Shot Mode cannot be used in the Coupling Shot Mode.

## OTHER RECORDING FUNCTIONS

### Recording a Subject onto an Existing Background Image (Pre-shot)

Pre-shot helps you get the background you want, even if you need to ask someone else to record the image for you. Basically, Pre-shot is a two-step process.

1. You compose the background you want and press the shutter release button, which causes a semi-transparent image of the background to remain on the monitor screen.
2. Ask someone else to record a shot of you against your original background, telling them to compose the image by using the semi-transparent monitor screen image as a guide.
  - The camera stores the image produced by step 2 only.
  - Depending on how the image is actually composed in step 2, its background may not be exactly the same as the one you composed in step 1.

Note that Pre-shot is available in the Best Shot Mode only (page 64).

- Freeze the background on the monitor screen.



- Record the image, using the background on the monitor screen as a guide.



- This records the image.



## OTHER RECORDING FUNCTIONS

1. Align the mode dial with **BS**.
2. Use [**<**] and [**>**] to select “Pre-shot,” and then press SET.

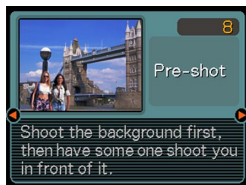

3. Freeze the background on the monitor screen.
  - Though a semi-transparent image of the background appears on the monitor screen in step 4, the background image is not saved in memory at this time.
  - The following settings are fixed for this image: focus, exposure, white balance, zoom, flash.

4. Next, align the focus frame with the subject, composing the subject with the semi-transparent background shown on the monitor screen. When everything is aligned correctly, record the image.



*Semi-transparent image*

- This records the image composed on the monitor screen in step 4. The reference background image is not recorded.
- Pressing MENU any time after step 3 of the above procedure cancels the background image and returns to step 3.

## Using the Best Shot Mode

Selecting one of the 33 Best Shot scenes automatically sets up the camera for recording a similar type of image.

### ■ Example Sample Scene

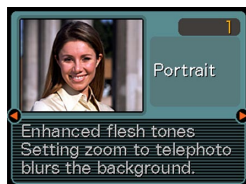

### ■ Composition Outline

Selecting certain Best Shot scenes causes a composition outline to appear on the monitor screen. Use the composition outline to compose your image and achieve proper balance. The location of the composition outline depends on the sample scene you select.

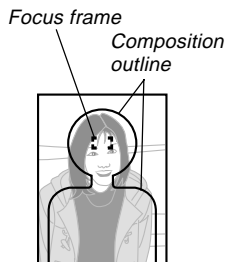

Example: Recording a portrait.

### 1. Align the mode dial with **BS**.

- This enters the Best Shot Mode and displays a sample scene.



### 2. Use [**<**] and [**>**] to select the sample scene you want, and then press SET.

### 3. Record the image.

#### ▶▶ IMPORTANT! ◀◀

- Sample scenes numbered 5 through 7 are Coupling Shot scenes (page 60). Sample scene number 8 is a Pre-shot scene (page 62).
- Best Shot scenes were not recorded using this camera. They are provided as samples only.
- Images recorded using a Best Shot scene may not produce the results you expected due to shooting conditions and other factors.
- You can change to a different sample scene by using [**<**] and [**>**] to select the scene you want and pressing SET.



## Creating Your Own Best Shot Setup

You can use the procedure below to save the setup of an image you recorded for later recall when you need it again. Recalling a setup you save automatically sets up the camera accordingly.

### 1. Align the mode dial with **BS**.

- This enters the Best Shot Mode and displays a sample scene.

### 2. Use [**<**] and [**>**] to display “Register Favorites.”



### 3. Press SET.

### 4. Use [**<**] and [**>**] to display the image whose setup you want to register as a Best Shot scene.

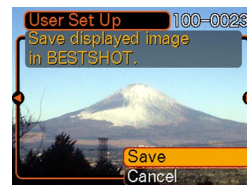

### 5. Use [**^**] and [**v**] to select “Save,” and then press SET.

- This registers the setup.
- Now you can use the procedure on page 64 to select your user setup for recording.

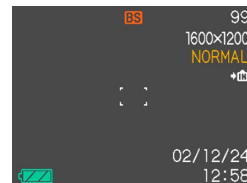

### ▶▶ IMPORTANT! ◀◀

- Setups that you register as Best Shot Mode sample scenes are located after the built-in sample scenes.
- Note that formatting the built-in memory (page 103) deletes all Best Shot Mode user setups.

### ▶▶ NOTES ◀◀

- Best Shot Mode user setups are located in memory after the built-in sample scenes.
- The following are the settings that are included in a Best Shot Mode user setup: focus mode, EV shift value, filter, metering mode, white balance mode, color enhancement, flash intensity, sharpness, saturation, contrast, flash mode, ISO sensitivity, and aperture and shutter speed.
- Note that images recorded with this camera only can be used for registration of Best Shot Mode user setups.
- You can register up to 999 Best Shot Mode user setups.
- You can check the current setup of a scene by displaying the various setting menus.
- User setups are assigned file names using the format "UQVR3nnn.jpe" (where n = 0 to 9) or "UQVR4nnn.jpe" (where n = 0 to 9).

### ■ To delete a Best Shot Mode user setup

#### 1. Align the mode dial with **BS**.

- This enters the Best Shot Mode and displays a sample scene.

#### 2. Use [**<**] and [**>**] to display the user setup you want to delete.

#### 3. Press **⚡** **🗑** to delete the user setup.

- You can also delete a user setup by using your computer to delete its file in the "SCENE" folder in camera memory (page 122).

## Using the Night Scene Mode

The night scene mode extends the exposure time to produce beautiful night images.

1. Align the mode dial with .
2. Record the image.

### NOTE

- When recording a portrait of a subject against a twilight or nighttime background, you can use the Night Scene Mode in combination with the flash to achieve a slow sync effect that causes the subject to stand out better.

### IMPORTANT!

- Always mount the camera on a tripod when using the Night Scene Mode. This protects against blurred images caused by slow shutter speeds.
- Auto Focus may not be able to work properly when lighting is low. If this happens, focus the image manually (page 55). Trying to record a fast moving object can cause blurring of the image.
- The slower the shutter speed, the more likely it is that the recorded image will not match the image that is on the monitor screen when you press the shutter release button.

## Shooting with Manual Exposure

In the Manual Exposure Mode, you can manually adjust shutter speed and aperture.



### Shutter Speed Setting Range

Shutter Speed	Slower $\longleftrightarrow$ Faster
	2 seconds $\longleftrightarrow$ 1/1000 second (F2.6)
	2 seconds $\longleftrightarrow$ 1/2000 second (F5.0)
Brightness	Brighter $\longleftrightarrow$ Darker
Movement	Flowing $\longleftrightarrow$ Stopped

### Aperture Setting Range

Aperture	Wider $\longleftrightarrow$ Smaller
	F2.6, F5.0 (Wide angle zoom)*
Brightness	Brighter $\longleftrightarrow$ Darker
Focus	Shallow $\longleftrightarrow$ Deep

\* The following shows how the optical zoom setting affects aperture.

Zoom	 (Wide Angle) $\longleftrightarrow$  (Telephoto)
Wide Aperture	F2.6/3.0/3.4/3.8/4.2/4.6/4.8
Small Aperture	F5.0/5.8/6.5/7.3/8.0/8.7/9.2

## OTHER RECORDING FUNCTIONS

1. Align the mode dial with M (Manual Exposure).
2. Use [ < ] and [ > ] to specify the shutter speed, and then use [ ^ ] and [ v ] to specify the aperture value.
3. Compose the image and then press the shutter release button.

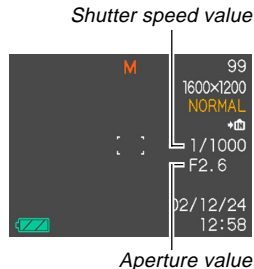

### ►► IMPORTANT! ◀◀

- The shutter speed and aperture value on the monitor screen will turn orange when you press the shutter release button half way if the image is over-exposed or under-exposed.
- You may not be able to achieve the brightness you want when recording an image that is very dark or very bright. If this happens, adjust the shutter speed.
- Using slow shutter speeds can cause static noise to appear in the image.
- At shutter speeds slower than 1/8 second, the brightness of recorded image may not be the same as the brightness of the image that appears on the monitor screen.

### Using the Movie Mode

You can record movies up to 30 seconds long.

- **File Format: AVI**  
AVI format conforms to the Motion JPEG format promoted by the Open DML Group.
- **Image Size:** 320 x 240 pixels
- **Movie File Size:** Approximately 200KB/second.
- **Maximum Movie Length**
  - One Movie: 30 seconds
  - Total Movie Time:  
60 seconds with built-in memory; 330 seconds with 64MB SD memory card

#### 1. Align the mode dial with .

- “Remaining capacity” shows how many 30-second movies can still be recorded to memory.

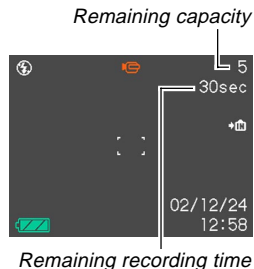

#### 2. Point the camera at the subject and then press the shutter release button.

- Movie recording continues for 30 seconds, or until you stop it by pressing the shutter release button again.
- The remaining recording time value counts down on the monitor screen as you record.
- If you want to stop recording sooner than 30 seconds, press the shutter release button again.

#### 3. After recording stops, the camera starts the movie file store operation.

- To cancel storage of the movie file while it is being performed, press , use [^] and [v] to select “Delete,” and then press SET.

#### ▶▶ IMPORTANT! ◀◀

- The flash does not fire in the Movie Mode.

### Shooting at Fixed Intervals

You can set up the camera to record at fixed intervals, specifying the number of images to be recorded, the interval between recordings, and a start time. The following describes the types of recording variations you can configure.

- **Interval Recording**  
Records images at a fixed interval, starting immediately.
- **Timer Recording**  
Records a single image at a specified time.
- **Interval Timer Recording**  
Records images at a fixed interval, starting from a specified time.

- 1. Align the mode dial with .**
- 2. Use [ < ] and [ > ] to change the “Shots” setting, and then press [ √ ].**
  - Specify the number of shots you want to record. Skip this step by pressing SET without changing the default setting (1) if you want to record a single image.
  - Select the “MAX” option if you want recording to continue until memory becomes full.
- 3. Use [ < ] and [ > ] to change the “Interval” setting, and then press [ √ ].**
  - Specify the interval between shots. You can specify a value from one minute to 60 minutes, in one-minute increments.
- 4. Use [ < ] and [ > ] to set the start time, and then press SET.**
  - The initial default setting for the start time is “Start.”
  - You can set the start time to a value in the range of 1 minute to 240 minutes. When you press the shutter release button in step 6, recording starts after the number of minutes you specify here passes.
  - If you want recording to start immediately when you press the shutter release button, select “Start” for this setting, and then press SET to advance to the next step.

### 5. Configure image recording settings.

- At this point, you should make white balance and any other settings you want.

### 6. Align the focus frame with the subject, and then press the shutter release button all the way down.

- This causes camera power to turn off. Camera power will turn back on and image recording will be performed in accordance with the interval timer recording settings you configured with the above steps.

### ■ Canceling an Interval Mode Timer Operation

Turning on the camera while it is standing by for an Interval Mode record operation causes the message “Interval recording was canceled.” to appear, and cancels the interval recording operation. An Interval Mode record operation is also cancelled by changing the mode dial setting to something other than .

## Adjusting the White Balance

The wavelengths of the light produced by various light sources (sunlight, light bulb, etc.) can affect the color of a subject when it is recorded. White balance lets you make adjustments to compensate for different lighting types, to make the colors of an image appear more natural.

**1. In a recording mode, press MENU.**

**2. Select the “REC” tab, select “White Balance,” and then press [>].**



**3. Use [^] and [v] to change the current setting, and then press SET.**

When shooting under these conditions:	Select this setting:
Normal conditions	Auto
Outdoor daylight	
Shade	
Incandescent light bulb (reddish tinge)	
Fluorescent light (greenish tinge)	
Difficult lighting that requires manual control (See below.)	Manual

### NOTE

- Selecting “Manual” changes white balance to the settings achieved the last time a manual white balance operation was performed.



## Adjusting White Balance Manually

Under some light sources, automatic white balance under the “Auto” setting can take a long time to complete. Also, the auto white balance range (color temperature range) is limited. Manual white balance helps to ensure that colors are recorded correctly for a particular light source.

Note that you must perform manual white balance under the same conditions you will be shooting under. You must also have a white piece of paper or other similar object on hand in order to perform manual white balance.

### 1. In step 3 of the procedure under “Adjusting the White Balance,” select “Manual” (page 72).

- This causes the object you last used to adjust manual white balance to appear on the monitor screen.

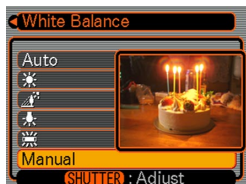

### 2. Point the camera at a white piece of paper or similar object under the lighting conditions for which you want to set the white balance, and then press the shutter release button.

- This adjusts the white balance.

### 3. Press SET.

- This registers the white balance settings and exits the setting screen.
- Dim lighting or pointing the camera at a dark colored object can cause white balance to take a long time to complete.

## Selecting the Metering Mode

Use the following procedure to specify multi-pattern metering, spot metering, or center-weighted metering as the metering mode.

1. In a recording mode, press **MENU**.
2. Select the “**REC**” tab, select “**Metering,**” and then press [**>**].
3. Select the setting you want and then press **SET**.

### Multi-pattern:

Multi-pattern metering divides the image into sections and measures the light in each section for a balanced exposure reading. The camera automatically determines shooting conditions according to the measured lighting pattern, and makes exposure settings accordingly. This type of metering provides error-free exposure settings for a wide range of shooting conditions.



### Center-weighted:

Center-weighted metering measures light concentrating on the center of the focus area. Use this metering method when you want to exert some control over exposure, without leaving settings totally up to the camera.



### Spot:

Spot metering takes readings at a very small area. Use this metering method when you want exposure to be set according to the brightness of a particular subject, without it being affected by surrounding conditions.



## ▶▶ IMPORTANT! ◀◀

- When “Multi” is selected as the metering mode, certain procedures cause the metering mode setting to change automatically as described below.
- Changing the exposure compensation setting (page 58) to a value other than 0.0 changes the metering mode setting to “Center Weighted.” The metering mode changes back to “Multi” when you return the exposure compensation setting to 0.0.
- Selecting manual exposure (page 67) changes the metering mode setting to “Center Weighted.” The metering mode changes back to “Multi” when you select an exposure mode other than manual.

## Using the Histogram

Using the DISP button to display the histogram on the monitor screen makes it possible for you to check exposure conditions as you record images (page 20). You can also display the histogram of a recorded image in the Play Mode.

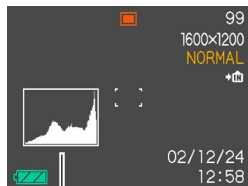

*Histogram*

A histogram is a graph that represents the lightness of an image in terms of the number of pixels. The vertical axis indicates the number of pixels, while the horizontal axis indicates lightness. You can use the histogram to determine whether an image includes the shadowing (left side), mid tones (center), and highlighting (right) required to bring out sufficient image detail. If the histogram appears too lopsided for some reason, you can use exposure compensation (EV shift) to move it left or right in order to achieve better balance. Optimum exposure can be achieved by correcting exposure so the graph is as close to the center as possible.

- When the histogram is too far to the left, it means that there are too many dark pixels. This type of histogram results when the overall image is dark. A histogram that is too far to the left may result in “black out” of the dark areas of an image.

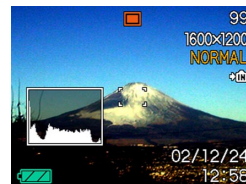

- When the histogram is too far to the right, it means that there are too many light pixels. This type of histogram results when the overall image is light. A histogram that is too far to the right may result in “white out” of the light areas of an image.

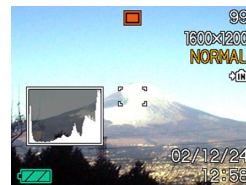

- A centered histogram indicates that there is good distribution of light pixels and dark pixels. This type of histogram results when the overall image is at optimal lightness.

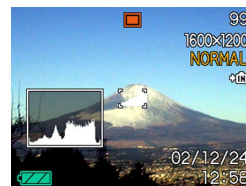

### ▶▶ IMPORTANT! ◀◀

- Note that the above histograms are shown for illustrative purposes only. You may not be able to achieve exactly the same shapes for particular subjects.
- A centered histogram does not necessarily guarantee optimum exposure. The recorded image may be over-exposed or under-exposed, even though its histogram is centered.
- You may not be able to achieve an optimum histogram configuration due to the limitations of exposure compensation.
- Use of the flash or multi-metering, as well as certain shooting conditions can cause the histogram to indicate exposure that is different from the actual exposure of the image when it was recorded.
- When using the Continuous Shutter Mode, the histogram appears for the first image only (page 59).
- This histogram does not appear when you are using Coupling Shot (page 60).

### Recording Mode Settings

The following are the settings you can make before recording an image using a recording mode.

- ISO sensitivity
- Enhancement
- Color filtering
- Saturation
- Contrast
- Sharpness
- Grid on/off
- Power on default settings

### ▶▶ NOTE ◀◀

- You can also configure the settings listed below. See the referenced pages for more information.
  - Size and Quality (page 51)
  - White Balance (page 72)
  - Metering (page 74)
  - Flash Intensity (page 48)
  - Digital Zoom (page 45)

## Specifying Sensitivity

Use the following procedure to select the sensitivity setting that suits the type of image you are recording.

1. In a recording mode, press **MENU**.
2. Select the “REC” tab, select “ISO,” and then press [**>**].
3. Select the setting you want and then press **SET**.

QV-R3
Auto : Automatic sensitivity selection ISO125 : Conforms with ISO125 ISO250 : Conforms with ISO250
QV-R4
Auto : Automatic sensitivity selection ISO100 : Conforms with ISO100 ISO200 : Conforms with ISO200

### ►► IMPORTANT! ◀◀

- Increasing sensitivity can cause static to appear inside an image. Select the sensitivity setting that suits your shooting needs.

## Enhancing Specific Colors

Use the following procedure when you want to enhance a particular color in your recorded image.

1. In a recording mode, press **MENU**.
2. Select the “REC” tab, select “Enhance,” and then press [**>**].
3. Select the setting you want and then press **SET**.

To do this:	Select this setting:
Turn off color enhancement	Off
Enhance reds	Red
Enhance greens	Green
Enhance blues	Blue
Enhance flesh tones	Flesh Tones

### ►► NOTES ◀◀

- Enhancing a color produces the same effect as attaching a color enhancer lens filter to the lens.
- If color enhancement and the filter function (page 78) are both turned on at the same time, the filter function is given priority (color enhancement is not performed).

## Using the Filter Function

The camera's filter function lets you alter the tint of an image when you record it.

1. In a recording mode, press **MENU**.
2. Select the "REC" tab, select "Filter," and then press [**>**].
3. Select the setting you want and then press **SET**.
  - Available filter settings are: Off, B/W, Sepia, Red, Green, Blue, Yellow, Pink, Purple

### »» IMPORTANT! ««

- Using the camera's filter feature produces the same effect as attaching a color filter to the lens.
- If color enhancement (page 77) and the filter function are both turned on at the same time, the filter function is given priority (color enhancement is not performed).

## Specifying Color Saturation

Use the following procedure to control the intensity of the image you are recording.

1. In a recording mode, press **MENU**.
2. Select the "REC" tab, select "Saturation," and then press [**>**].
3. Select the setting you want and then press **SET**.

To get this:	Select this setting:
High color saturation (intensity)	High
Normal color saturation (intensity)	Normal
Low color saturation (intensity)	Low

## Specifying Contrast

Use this procedure to adjust the relative difference between the light areas and dark areas of the image you are recording.

1. In a recording mode, press MENU.
2. Select the "REC" tab, select "Contrast," and then press [>].
3. Select the setting you want and then press SET.

To get this:	Select this setting:
High contrast	High
Normal contrast	Normal
Low contrast	Low

## Specifying Outline Sharpness

Use the following procedure to control the sharpness of image outlines.

1. In a recording mode, press MENU.
2. Select the "REC" tab, select "Sharpness," and then press [>].
3. Select the setting you want and then press SET.

To get this:	Select this setting:
High sharpness	Hard
Normal sharpness	Normal
Low sharpness	Soft

## Turning the On-screen Grid On and Off

You can display gridlines on the monitor screen to help you compose images and ensure that the camera is straight when recording.

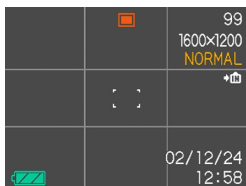

1. In a recording mode, press MENU.
2. Select the “REC” tab, select “Grid,” and then press [>].
3. Select the setting you want and then press SET.

To do this:	Select this setting:
Display the grid	On
Hide the grid	Off

## Specifying Power On Default Settings

You can configure the camera to save certain settings in “mode memory” when it is turned off, and restore them the next time you turn the camera back on. This keeps you from having to configure the camera each time you turn it on.

### ● Mode Memory Settings

The following are the settings that can be saved in mode memory and restored the next time you turn on the camera. Flash mode, focus mode, white balance, ISO sensitivity, metering mode, flash intensity, digital zoom, manual focus position

1. In a recording mode, press MENU.
2. Select the “Memory” tab, and then press [√].
3. Select the item whose setting you want to change, and then press SET.
4. Select the setting you want and then press



#### 4. Select the setting you want and then press SET.

To do this:	Select this setting:
Save the current status of the setting and restore it the next time the camera is turned on.	On
Restore the factory default setting whenever the camera is turned on.	Off

#### 5. After you are finished configuring settings, press the MENU button to exit the setting screen.

Function	On	Off
Flash	Setting when camera is turned off	Auto
Focus		Auto
White Balance		Auto
ISO		Auto
Metering		Multi
Flash Intensity		Normal
Digital Zoom		On
MF Position		Last Auto Focus position that was in effect before you switched to manual focus

## Resetting the Camera

Use the following procedure to reset all of the camera's settings to their initial defaults as shown under "Menu Reference" on page 131.

- 1. In a recording mode or the Play Mode, press MENU.**
- 2. Select the "Set Up" tab, select "Reset," and then press [>].**
- 3. Select "Reset," and then press SET.**
  - To cancel the procedure without resetting, select "Cancel" and press SET.

# PLAYBACK

You can use the camera's built in monitor screen to play back files

## Basic Playback Operation

Use the following procedure to scroll through files stored in the camera's memory.

### 1. Press the power button to turn on the camera.

- This causes an image or a message to appear on the monitor screen.

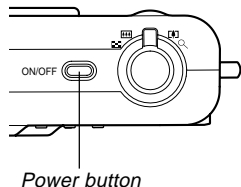

### 2. Align the mode dial with (Play Mode).

- This enters the Play Mode.

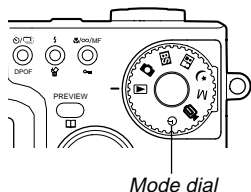

### 3. Use [ $\wedge$ ], [ $\vee$ ], [ $\lt$ ], and [ $\gt$ ] to scroll through images on the monitor screen.



To do this:	Do this:
Scroll forward	Press [ $\gt$ ].
Scroll back	Press [ $\lt$ ].
Display the first image	Press [ $\wedge$ ].
Display the last image	Press [ $\vee$ ].

### NOTES

- Holding down [ $\lt$ ] or [ $\gt$ ] scrolls images at high speed.
- Note that the images produced on the monitor screen of this camera are simplified versions of the actual image stored in memory.

## Zooming the Displayed Image

Perform the following procedure to zoom the image currently on the monitor screen up to four times its normal size.

1. In the Play Mode, use [ < ] and [ > ] to display the image you want.

2. Shift the zoom controller towards  to enlarge the image.

- This displays an indicator that shows the current zoom factor.

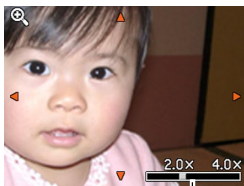

*Current zoom factor*

3. Use [ ^ ], [ v ], [ < ], and [ > ] to shift the image up, down, left, or right.

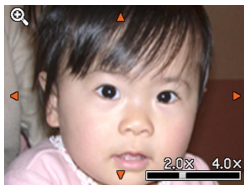

4. Press any button besides DISP to return the image to its original size.

### »» IMPORTANT! ««

- You cannot enlarge a movie image.

## Resizing an Image

You can use the following procedure to change an image to one of the two sizes: SXGA size (1280 x 960 pixels) or VGA size (640 x 480 pixels).

1. In the Play Mode, press MENU.
2. Select the “PLAY” tab, select “Resize,” and then press [>].
3. Use [←] and [→] to scroll through images and display the one you want to resize.
4. Use [^] and [v] to select the size you want, and then press SET.

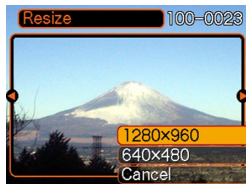

To do this:	Select this setting:
Resize to 1280 x 960 pixels (SXGA)	1280 X 960
Resize to 640 x 480 pixels (VGA)	640 X 480
Cancel the resizing operation	Cancel

## IMPORTANT!

- Resizing an image causes a new (resized) version to be stored as a separate file.
- Images smaller than 640 X 480 pixels cannot be resized.
- Resizing is supported for images recorded by this model camera only.
- If the message “The function is not supported for this file.” appears, it means that the current image cannot be resized.
- The resize operation cannot be performed if there is not enough memory to store the resized image.

## Cropping an Image

Use the following procedure when you want to crop a portion of an enlarged image and use the remaining part of the image as an e-mail attachment, Web page image, etc.

**1. In the Play Mode, use [◀] and [▶] to scroll through images and display the one you want to crop.**

**2. Press MENU.**

**3. Select the “PLAY” tab, select “Trimming,” and then press [▶].**

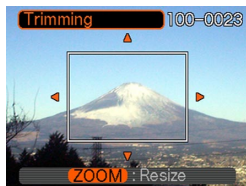

**4. Shift the zoom controller towards  to expand the size of the boundary on the monitor screen.**

- The size of the cropping boundary depends on the size of the image on the display.

**5. Use [^], [v], [◀], and [▶] to move the cropping boundary up, down, left, or right until the area of the image you want to extract is within the boundary.**

**6. Press SET to extract the part of the image enclosed in the cropping boundary.**

- If you want to cancel the procedure at any point, press MENU.

### ▶▶ IMPORTANT! ◀◀

- The cropped version of the image is saved as a new file.
- The original, pre-cropped image is also retained in memory.
- A Movie Mode image cannot be cropped.
- If the message “The function is not supported for this file.” appears, it means that the current image cannot be cropped.
- The cropping operation cannot be performed if there is not enough memory to store the cropped image.

## Playing a Movie

Use the following procedure to play back a movie recorded in the Movie Mode.

- In the Play Mode, use [ < ] and [ > ] to display the movie you want play.**

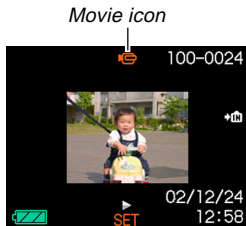

- Press SET to start playback of the movie.**

- You can perform the following operations while a movie is playing.

To do this:	Do this:
Play at fast forward	Press [ > ].
Play at fast reverse	Press [ < ].
Pause or unpause playback	Press SET.
Skip forward or back while playback is paused	Press [ < ] or [ > ].
Stop playback	Press MENU.

### ▶▶ IMPORTANT! ◀◀

- A movie plays until the end and then stops. You cannot repeat-play a movie.

## Displaying the 9-image View

The following procedure displays nine images on the monitor screen at the same time.

1. Enter the Play Mode.
2. Shift the zoom controller towards .
  - This displays the 9-image screen with the image that was on the monitor screen in step 2 in the center, with a selection boundary around it.
3. Use [^], [v], [<], and [>] to move the selection boundary to the image you want. Pressing [>] while the selection boundary is in the right column or [<] while it is in the left column scrolls to the next full screen of nine images.

Example: When there are 20 images in memory, and Image 1 is displayed first

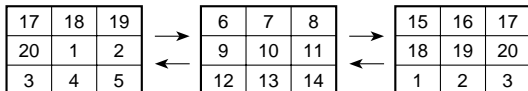

- When there are nine or fewer images, they are displayed in order with Image 1 in the upper left corner, with the selection boundary around it.

4. Pressing any button except [^], [v], [<], and [>] displays the full-size version of the image where the selection boundary is located.

## Selecting a Specific Image in the 9-image View

1. Display the 9-image view.
2. Use [^], [v], [<], and [>] to move the selection boundary up, down, left, or right until it is located at the image you want to view.

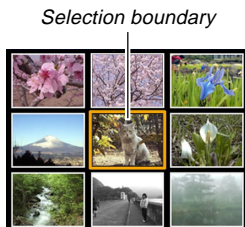

3. Pressing any button except [^], [v], [<], or [>] displays the selected image.
  - This displays the full-size version of the image you selected.





# DELETING FILES

You can delete a single file, or you can delete all files currently in memory.

## »» IMPORTANT! ««

- Note that file deletion cannot be undone. Once you delete a file, it is gone. Make sure you really do not need a file anymore before you delete it. Especially when deleting all files, make sure you check all the files you have stored before proceeding.
- Delete cannot be performed when all the files in memory are protected (page 92).
- A protected file cannot be deleted. To delete a protected file, unprotect it first (page 92).

## Deleting a Single File

Perform the following steps when you want to delete a single file.

1. In the Play Mode, press  .





2. Use [**<**] and [**>**] to display the image you want to delete.
3. Use [**^**] and [**v**] to select “Delete.”
  - To exit the file delete operation without deleting anything, select “Cancel.”
4. Press **SET** to delete the image.
  - Repeat steps 2 through 4 to delete other files, if you want.
5. Press **MENU** to exit the delete operation.

### ►► IMPORTANT! ◀◀

- If a file cannot be deleted for some reason, the message “The function is not supported for this file.” appears when you try to delete it.

### Deleting All Files

The following procedure deletes all unprotected files currently in memory.

- 1. In the Play Mode, press  .**
- 2. Use [^] and [v] to select “All File Delete,” and then press SET.**
- 3. Use [^] and [v] to select “Yes.”**
  - To exit the file delete operation without deleting anything, select “No.”
- 4. Press SET to delete all the images.**

# FILE MANAGEMENT

The file management capabilities of the camera make it easy to keep track of images. You can protect files against deletion, and even use its DPOF feature to specify images for printing.

## Folders

Your camera automatically creates a directory of folders in its built-in flash memory or on the memory card to store images.

## Memory Folders and Files

An image you record is automatically stored in a folder, whose name is a serial number. You can have up to 900 folders in memory at the same time. Folder names are generated as shown below.

Example: Name of the 100th folder.

100CASIO

|  
*Serial number (3 digits)*

Each folder can hold files numbered up to 9,999. Trying to store the 10,000th file in a folder causes the next serially numbered folder to be created. Folder names are generated as shown below.

Example: Name of the 26th file

CIMG0026.JPG

|                   |  
*Extension*

|  
*Serial number (4 digits)*

- The actual number of files you will be able to store on a memory card depends on the image quality settings, capacity of the card, etc.
- For details about the directory structure, see “Memory Directory Structure” on page 122.

## Protecting Files

Once you protect a file it cannot be deleted. You can protect files individually or you can protect all files in memory with a single operation.

### To protect and unprotect a single file

1. In the Play Mode, press /∞/MF .
2. Use [◀] and [▶] to display the image you want to protect.
3. Use [^] and [v] to select either “On” (protected) or “Off” (unprotected).
4. Press SET to apply the setting.
  - Protecting an image causes to appear on it.
5. Press MENU to exit the image protect screen.

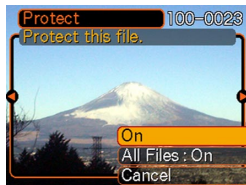

### To protect all files in memory

1. In the Play Mode, press /∞/MF .
2. Use [^] and [v] to select “All Files: On,” and then press SET.
  - To unprotect all images, select “All Files: Off,” and then press SET.
  - Selecting “All Files: On” protects all images and causes to appear on them.
3. Press MENU to exit the image protect screen.

## DPOF

The letters “DPOF” stand for “Digital Print Order Format,” which is a format for recording on a memory card or other medium which digital camera images should be printed and how many copies of the image should be printed. Then when you print on a DPOF-compatible printer or at a professional print service that supports DPOF, only the files you selected on the card are printed, in the quantities you specified.

With this camera, you should always select images by viewing them on the monitor screen. Do not specify images by file name without viewing the file contents.

#### ■ DPOF Settings

File Name,  
number of copies,  
date

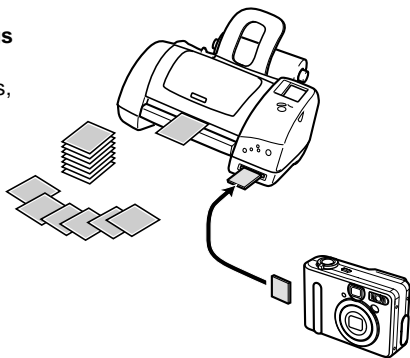

## To configure print settings for a single image

1. In the Play Mode, press DPOF.



2. Use [ $\wedge$ ] and [ $\vee$ ] to select “Select images,” and then press SET.

3. Use [<] and [>] to display the image you want.



4. Use [ $\wedge$ ] and [ $\vee$ ] to specify the number of copies.

- You can specify up to 99 for the number of copies. Specify 00 if you do not want to have the image printed.

**5. To turn on date stamping for the prints, press DISP so  is displayed.**

- To turn off date stamping for the prints, press DISP so  is not displayed.
- Repeat steps 3 through 5 if you want to configure other images for printing.

**6. After all the settings are the way you want, press SET to apply them.**

## To configure print settings for all images

**1. In the Play Mode, press  DPOF.**

**2. Use [^] and [v] to select “All images,” and then press SET.**



**3. Use [^] and [v] to specify the number of copies.**

- You can specify up to 99 for the number of copies. Specify 00 if you do not want to have the image printed.

**4. To turn on date stamping for the prints, press DISP so  is displayed.**

- To turn off date stamping for the prints, press DISP so  is not displayed.

**5. After all the settings are the way you want, press SET to apply them.**

### PRINT Image Matching II

Images include PRINT Image Matching II data (mode setting and other camera setup information). A printer that supports PRINT Image Matching II reads this data and adjusts the printed image accordingly, so your images come out just the way you intended when you recorded them.



\* PRINT Image Matching and PRINT Image Matching II are registered trademarks of SEIKO EPSON Corporation.

### Exif Print

Exif Print is an internationally supported, open standard file format that makes it possible to capture and display vibrant digital images with accurate colors. With Exif 2.2, files include a wide range of shooting condition information that can be interpreted by an Exif Print printer to produce better-looking prints.



#### »» IMPORTANT! ««

- Information about the availability of Exif Print compatible printer models can be obtained from each printer manufacturer.

# OTHER SETTINGS

## Specifying the File Name Serial Number Generation Method

Use the following procedure to specify the method for generating the serial number used for file names (page 91).

- 1. In a recording mode or the Play Mode, press MENU.**
- 2. Select the “Set Up” tab, select “File No.,” and then press [>].**
- 3. Use [^] and [v] to change the setting, and then press SET.**

To do this for a newly saved file:	Select this setting:
Store the last file number used and increment it, regardless of whether files are deleted or whether the memory card is replaced with a new one	Continue
Find the highest file number in the current folder and increment it	Reset

## Turning the Key Tone On and Off

Use the following procedure to turn the tone that sounds when you press a key on and off.

- 1. In a recording mode or the Play Mode, press MENU.**
- 2. Select the “Set Up” tab, select “Beep,” and then press [>].**
- 3. Use [^] and [v] to change the setting, and then press SET.**

To do this:	Select this setting:
Turn on the key tone	On
Turn off the key tone	Off



## Specifying an Image for the Startup Screen

You can specify an image you recorded as the startup screen image, which causes it to appear on the monitor screen for about two seconds whenever you turn on the camera.

1. In a recording mode or the Play Mode, press **MENU**.
2. Select the “Set Up” tab, select “Startup,” and then press [>].
3. Use [←] and [→] to display the image you want to use as the startup image.
  - You can specify a snapshot image or a movie image that is two seconds (200KB) or less in length.
4. Use [^] and [v] to change the setting, and then press **SET**.

To do this:	Select this setting:
Use the currently displayed image as the startup screen image	On
Disable the startup screen	Off

## IMPORTANT!

- The snapshot image or movie that you select as the startup image is stored in a special memory location called “startup image memory.” Only one image can be stored in startup image memory at one time. Selecting a new startup image overwrites anything that is already stored in startup image memory. Because of this, if you want to return to a previous startup image, you need to have a separate copy of that image in the camera’s standard image storage memory. Note that you cannot delete an image from startup image memory. You can only replace it with another image.

## Using the Alarm

You can configure up to three alarms that cause the camera to beep and display a specified image at the time you specify.

### To set an alarm

1. In the Play Mode, press **MENU**.
2. Select the “PLAY” tab, select “Alarm,” and then press [>].

- 3. Use [^] and [v] to select the alarm whose setting you want to configure, and then press SET.**
- 4. Use [<] and [>] to select the setting you want to change, and then use [^] and [v] to change the selected setting.**
  - You set an alarm time, and setup an alarm to sound either once or daily. You can also turn the alarm on and off.
- 5. Press DISP.**
  - You could press SET in place of DISP if you want to configure the alarm without an image.
- 6. Use [<] and [>] to select the scene you want to appear at the alarm time, and then press SET.**
- 7. After all the settings are the way you want, press SET.**
  - You can configure up to three alarms, named 1, 2, and 3.

## Stopping the Alarm

When an alarm time is reached while the camera is turned off, the alarm sounds for about one minute (or until you stop it), even if the camera is turned off. The camera turns on automatically after the alarm sounds. To stop the alarm after it starts to sound, press any button.

### ▶▶ IMPORTANT! ◀◀

- The alarm does not sound when either of the following conditions exists.
  - When the camera is turned on
  - While you are using the Interval Mode

## Changing the Date and Time Setting

Use the following procedure to change the date and time setting. The settings you make here affect your home time zone.

1. In a recording mode or the Play Mode, press MENU.
2. Select the “Set Up” tab, select “Adjust,” and then press [>].
3. Set the current date and the time.

To do this:	Do this:
Move the cursor between settings	Press [←] or [→].
Change the setting at the current cursor location	Press [^] or [v].
Toggle between 12-hour and 24-hour timekeeping	Press DISP.

4. When all the settings are the way you want, press SET to register them and exit the setting screen.

## Changing the Date Format

You can select from among three different formats for display of the date.

1. In a recording mode or the Play Mode, press MENU.
2. Select the “Set Up” tab, select “Date Style,” and then press [>].
3. Use [^] and [v] to change the setting, and then press SET.

Example: October 23, 2002

To display the date like this:	Select this format:
02/10/23	YY/MM/DD
23/10/02	DD/MM/YY
10/23/02	MM/DD/YY

## Using World Time

You can use the World Time screen to view a time zone that is different from the home time zone when you go on a trip, etc. World Time can display the time in one of 162 cities in 32 time zones.

### To switch between the home time and World Time screens

1. In a recording mode or the Play Mode, press **MENU**.
2. Select the “Set Up” tab, select “World Time,” and then press [>].
  - This displays the current World Time zone.
3. Use [^] and [v] to select either home time or World Time.

To do this:	Select this:
Display the time in your home time zone	Home
Display the time in a different time zone	World

4. Press **SET** again to exit the setting screen.

### To configure World Time settings

1. In a recording mode or the Play Mode, press **MENU**.
2. Select the “Set Up” tab, select “World Time,” and then press [>].
  - This displays the current World Time zone.
3. Use [^] and [v] to select “World,” and then press [>].
  - If you want to configure Home Time settings, select “Home” instead.
4. Use [^] and [v] to select “City,” and then press [>].
5. Use [^], [v], [←], and [→] to select the geographical area you want, and then press **SET**.



## OTHER SETTINGS

**6. Use [^] and [v] to select the city you want, and then press SET.**

- This displays the current time in the city you select.

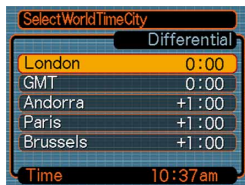

**7. When the setting is the way you want, press SET to apply it and exit the setting screen.**

## To configure summer time (DST) settings

- 1. In a recording mode or the Play Mode, press MENU.**
- 2. Select the "Set Up" tab, select "World Time," and then press [>].**
  - This displays the current World Time Settings.
- 3. Use [^] and [v] to select "World," and then press [>].**
  - If you want to configure Home Time settings, select "Home" instead.
- 4. Use [^] and [v] to select the summer time (DST) setting you want, and press [>].**

To do this:	Select this:
Advance the current time setting by one hour	On
Display the current time as-is	Off

**5. After the setting is the way you want, press SET.**

- This displays the current time in accordance with your setting.

**6. Press SET again to exit the setting screen.**

### Changing the Display Language

You can use the following procedure to select one of six languages as the display language.

- 1. In a recording mode or the Play Mode, press MENU.**
- 2. Select the “Set Up” tab, select “Language,” and then press [>].**
- 3. Use [^] and [v] to change the setting, and then press SET.**

日本語 : Japanese

English : English

Français : French

Deutsch : German

Español : Spanish

Italiano : Italian

### Formatting Built-in Memory

Formatting built-in memory deletes any data stored in it.

#### ►► IMPORTANT! ◀◀

- Note that data deleted by a format operation cannot be recovered. Check to make sure you do not need any of the data in memory before you format it.
- Formatting memory deletes all files in memory, including protected files (page 92), and Best Shot Mode user setups (page 65).
- The startup screen image is not deleted by formatting memory.

#### 1. Check to make sure there is no memory card loaded in the camera.

- If there is a memory card loaded in the camera, remove it (page 105).

#### 2. In a recording mode or the Play Mode, press MENU.

#### 3. Select the “Set Up” tab, select “Format,” and then press [>].

#### 4. Select “Format,” and then press SET.

- To exit the format operation without formatting, select “Cancel.”

# USING A MEMORY CARD

You can expand the storage capabilities of your camera by using a commercially available memory card (SD memory card or MultiMedia Card). You can also copy files from built-in flash memory to a memory card and from a memory card to flash memory.

- Normally, files are stored in built-in flash memory. When you insert a memory card, however, the camera automatically stores files to the card.
- Note that you cannot save files to built-in memory while a memory card is installed in the camera.

## ▶▶ IMPORTANT! ◀◀

- Make sure you turn off the camera before inserting or removing a memory card.
- Be sure to orient the card correctly when inserting it. Never try to force a memory card into the slot when you feel resistance.
- See the instructions that come with the memory card for information about how to use it.
- Certain types of cards can slow down processing speeds.
- SD memory cards have a write protect switch, which you can use to protect against accidental deletion of image data. Note, however, that if you write protect an SD memory card, you must remove write protection whenever you want to record to it, format it, or delete any of its files.



## Using a Memory Card

### To insert a memory card into the camera

1. Open the memory card cover.

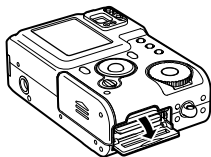

2. Positioning the memory card so its cut off corner is oriented as shown in the illustration, push the memory card into slot as far as it will go.

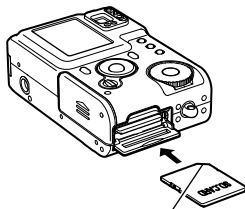

*Cut off corner*

3. Close the memory card cover.

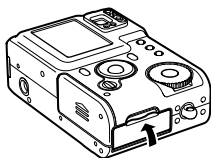

### To remove a memory card from the camera

1. Open the memory card cover.
2. Press the memory card into the camera and then release it. This will cause the card to come part way out of the camera.

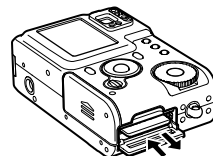

3. Pull the memory card out of the slot.

#### ►► IMPORTANT! ◀◀

- Never insert any other object besides a memory card into the camera's card slot. Doing so creates the risk of damage to the camera and card.
- Should water or any foreign object ever get into the card slot, immediately turn off the camera, remove the battery, and contact your dealer or nearest CASIO service center.
- Never remove a card from the camera while the green operation lamp is flashing. Doing so can cause the file save operation to fail, and even damage the memory card.

### Formatting a Memory Card

Formatting a memory card deletes any data already stored on it.

#### ►► IMPORTANT! ◀◀

- Be sure to use the camera to format a memory card. Formatting a memory card on a computer and then using it in the camera can slow down data processing by the camera. In the case of an SD card, formatting on a computer can result in nonconformity with the SD format, causing problems with compatibility, operation, etc.
- Note that data deleted by a memory card format operation cannot be recovered. Check to make sure you do not need any of the data on the memory card before you format it.
- Formatting a memory card that contains files deletes all the files, even those that are protected (page 92).

- 1. Load the memory card into the camera.**
- 2. Turn on the camera. Next, enter a recording mode or the Play Mode, and then press MENU.**
- 3. Select the “Set Up” tab, select “Format,” and then press [>].**
- 4. Select “Format,” and then press SET.**
  - To exit the format operation without formatting, select “Cancel.”

### Memory Card Precautions

- Use only an SD memory card or a MultiMedia Card with this camera. Proper operation is not guaranteed when any other type of card is used.
- Electrostatic charge, electrical noise, and other phenomena can cause data to become corrupted or even lost. Always make sure that you always back up important data on other media (MO disc, computer hard disk, etc.)
- If a memory card starts to behave abnormally, you can restore normal operation by reformatting it. However, we recommend that you always take along more than one memory card whenever using the camera far away from the home or office.
- We recommend that you format a memory card before using it for the first time after purchasing it, or whenever the card you are using seems to be the cause of abnormal images.
- Before starting a format operation, connect the AC adaptor for power or check to make sure that the battery is at full charge. Power interruption during the format operation can result in improper formatting, and even damage the memory card and make it unusable.

### Copying Files

Use the procedures below to copy files between built-in memory and a memory card. You can copy all files from built-in memory to a memory card, or you can copy a single file from the memory card to built-in memory.

#### To copy all the files in built-in memory to a memory card

1. Load the memory card into the camera.
2. Turn on the camera. Next, enter the Play Mode, and then press MENU.
3. Select the “PLAY” tab, select “Copy,” and then press [>].

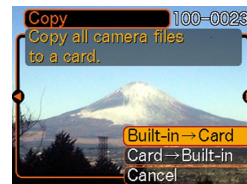

### 4. Use [^] and [v] to select “Built-in → Card,” and then press SET.

- This starts the copy operation and displays the message “Busy.... Please wait...”
- After the copy operation is complete, the monitor screen shows the last file in the folder.

### To copy a file from a memory card to built-in memory

1. Perform steps 1 through 3 of the procedure under “To copy all the files in built-in memory to a memory card.”
2. Use [^] and [v] to select “Card → Built-in,” and then press SET.
3. Use [<] and [>] to scroll through images until the one you want to copy is on the monitor screen.
4. Use [^] and [v] to select “Copy,” and then press SET.
  - This starts the copy operation and displays the message “Busy.... Please wait...”
  - The file reappears on the monitor screen after the copy operation is complete.
  - Repeat steps 3 through 4 to copy other images, if you want.
5. Press MENU to exit the copy operation.

## USING A MEMORY CARD

### »» NOTE ««

- Files are copied to the folder in built-in memory whose name has the largest number.

# USING THE CAMERA WITH A COMPUTER

The USB cable that comes with your camera makes it easy to connect to a computer that is equipped with a USB port. You can also transfer images using the memory card, if your computer is equipped to read memory cards.

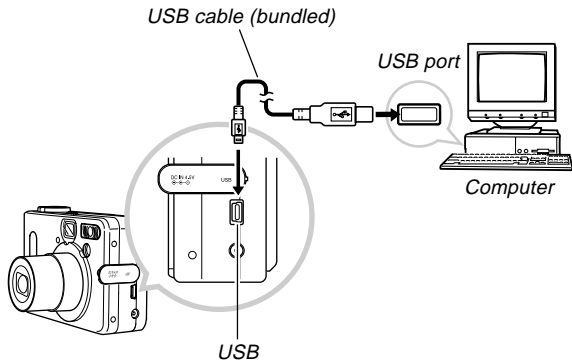

## Installing the Software from the CD-ROM

Before you can exchange files with your computer, you first need to install the software contained on the CD-ROM that comes with the camera.

## About the bundled CD-ROM

The CD-ROM that comes bundled with the camera contains the following software.

### Photo Loader (for Windows/Macintosh)

This application loads image data saved in JPEG and AVI format from a digital camera onto your computer.

### Photohands (for Windows)

This application is for retouching and printing image files.

### USB Driver for Mass Storage (for Windows/Macintosh)

This is the software that makes it possible for the camera to "talk" to your personal computer over a USB connection. If you are using Windows XP, Mac OS 9, or Mac OS X, do not install the USB driver from the CD-ROM. With these operating systems, you will be able to perform USB communication simply by connecting the camera to your computer with the USB cable.

### Internet Explorer (for Macintosh)

This is a browser application for reading HTML files. Images loaded by Photo Loader are stored in folders called "Libraries." Internet Explorer displays the contents of a library on your computer screen.

### DirectX (for Windows)

This software provides an extended tool set including a codec that allows Windows 98 and 2000 to handle movie files recorded using a digital camera. You do not need to install DirectX if you are running Windows XP or Me.

### Acrobat Reader (for Windows/Macintosh)

This is an application that lets you read PDF files. Use it to read the user documentation for the camera, Photo Loader, and Photohands, all of which is included on the bundled CD-ROM.

### NOTE

- See the user documentation files (PDF) on the bundled CD-ROM for details about using Photo Loader and Photohands. See "Viewing User Documentation (PDF files)" on page 114 (Windows) and page 117 (Macintosh) of this manual for more information.

## Computer System Requirements

Computer system requirements depend on each of the applications, as described below.

### Windows

See the "Readme" file on the bundled CD-ROM.

### Macintosh

See the "readme" file on the bundled CD-ROM.

### Installing Software from the CD-ROM in Windows

Use the procedures in this section to install the software from the bundled CD-ROM to your computer.

#### NOTE

- You do not need to install software if you already have it installed on your computer.

The CD-ROM includes the software and user documentation for various languages. Check the CD-ROM menu screen to see if applications and user documentation are available for a particular language.

### Getting Started

Start up your computer and insert the CD-ROM into its CD-ROM drive. This will automatically launch the menu application, which displays a menu screen on your computer.



#### NOTE

- The menu application may not start up automatically on some computers. If this happens, navigate to the CD-ROM and double-click “menu.exe” to launch the menu application.

### Selecting a Language

First select a language. Note that some software is not available in all languages.

- On the menu screen, click the language button in the upper left corner of the display.
- On the list of languages that appears, select the one you want.



### Viewing the Contents of the “Read me” File

You should always read the “Read me” file for any application before installing it. The “Read me” file contains information you need to know when installing the application.

1. On the menu screen, click “Software.”
2. Click the name of the application you want to install.
3. Click the “Read me” button.

#### »» IMPORTANT! ««

- Before upgrading or reinstalling Photo Loader, or before installing it onto another computer, be sure to read the “Read me” file for information about retaining existing libraries.

### Installing an Application

1. On the menu screen, click “Software.”
2. Click the name of the application you want to install.
3. Click the “Install” button.
4. Follow the instructions that appear on your computer screen.

#### »» IMPORTANT! ««

- Be sure to follow the instructions carefully and completely. If you make a mistake when installing Photo Loader, you may not be able to browse your existing library information and HTML files that are created automatically by Photo Loader. In some cases, image files may be lost.
- When using an operating system other than Windows XP, never connect the camera to your computer without installing the USB driver from the CD-ROM first.

## Viewing User Documentation (PDF Files)

1. On the menu screen, click “Manual.”
2. Click the name of the application whose user documentation you want to read.
3. Click the “Read” button.

### ▶▶ IMPORTANT! ◀◀

- You need to have Adobe Acrobat Reader installed on your computer to read user documentation files. If you do not already have Adobe Acrobat Reader installed, you can install it from the bundled CD-ROM.

## Exiting the Menu Application

1. On the menu screen, click “Exit” to exit the menu.

## Installing Software from the CD-ROM on a Macintosh

The CD-ROM contains applications and user documentation in various languages in folders named for each language: English, French, German, Spanish, Italian, Dutch, and Chinese. Check the CD-ROM folders to find out if applications and user documentation are available in a particular language.

File names include one of the following codes that indicate the language of the data contained in the file as shown below.

English: e, French: f, German: g, Spanish: sp, Italian: i, Dutch: du, Chinese: ct

If your language is not included in the above, use the contents of the “English” folder.

## Installing Software

Use the following procedures to install the software. We recommend that you install Internet Explorer and Outlook Express first before installing Photo Loader and Acrobat Reader.

■ **To install Internet Explorer and Outlook Express**

1. Open the file named “Internet Explorer.”
2. Open the folder for the language version you want to install, and then open the file named “readme\_casio” file.
3. Follow the instructions in the read me file to install Internet Explorer and Outlook Express.

■ **To install Photo Loader**

1. Open the folder named “Photo Loader.”
2. Open the folder named “English,” and then open the file named “Important.”
3. Open the folder named “Installer,” and then open the file named “readme.”
4. Follow the instructions in the “readme” file to install Photo Loader.

►► **IMPORTANT!** ◀◀

- If you are upgrading to the new version of Photo Loader from a previous version and you want to use library management data and HTML files created using the old version of Photo Loader, be sure to read the “Important” file in the “Photo Loader” folder. Follow the instructions in the file to use your existing library management files. Failure to follow this procedure correctly can result in loss or corruption of your existing files.

■ **To install Acrobat Reader**

1. On the bundled CD-ROM, open the folder named “Acrobat Reader.”
2. Open the folder for the language whose version of Acrobat Reader you want to install, and then open the file named “readme\_casio.”
  - Follow the instructions in the read me file to install Acrobat Reader.

### ■ Installing the USB Driver

1. Turn off the camera and quit all applications on your Macintosh.
2. Insert the bundled CD-ROM provided into the CD-ROM drive.
3. Open the hard disk that is specified as the startup disk.
4. Open the “System Folder” on the startup disk.
5. Open the “Extensions” folder inside the “System Folder.”
6. Open the “USB Driver” folder on the CD-ROM.
7. Drag “CASIO-USB Storage Driver” and “CASIO-USB Storage Class Shim” from the “USB Driver” folder to the “Extensions” folder.
8. Confirm that the “CASIO-USB Storage Driver” file and “CASIO-USB Storage Class Shim” file are in the “Extensions” folder, and then restart your Macintosh.

9. After the system starts up, use the USB cable to connect the camera to your Macintosh.

10. Turn on the camera.

11. From now on, the camera will be recognized as a drive whenever you connect the camera to your Macintosh.

- The shape of the icon that appears on your Macintosh display depends on the version of your Mac OS.



### ▶▶ IMPORTANT! ◀◀

- If you are running an operating system other than Mac OS 9 or Mac OS X, do not connect the camera to your Macintosh PC without installing the USB driver first.
- **To uninstall the USB driver**  
Delete “CASIO-USB Storage Driver” and “CASIO-USB Storage Class Shim” from the “Extensions” folder.

## Viewing User Documentation (PDF Files)

To perform the following procedures, you must have Acrobat Reader installed on your Macintosh (page 115).

1. On the bundled CD-ROM, open the folder named “Acrobat Reader.”
2. Open the folder for the language whose version of Acrobat Reader you want to install, and then open the file named “readme\_casio.”
3. Follow the instructions in the read me file to install Acrobat Reader.

### ■ To view the camera user’s guide

1. On the CD-ROM, open the “Manual” folder.
2. Open the “Digital Camera” folder, and then open the folder for the language whose user’s guide you want to view.
3. Open the file named “camera\_xx.pdf.”
4. “xx” is the language code (English: e, French: f, German: g, Spanish: sp, Italian: i, Dutch: du, Chinese: ct).

### ■ To read the Photo Loader user’s guide

1. On the CD-ROM, open the “Manual” folder.
2. Open the “Photo Loader” folder and then open the “English” folder.
3. Open “PhotoLoader\_english.”

### Transferring Files to a Computer

The CD-ROM that comes bundled with your camera contains a copy of Photo Loader and a USB driver. This software lets you transfer the contents of the camera's memory to your computer quickly and easily. The Photo Loader and Photohands applications can also be used for high-level image management and editing.

- For information about using Photo Loader and Photohands, see their user documentation files (PDF) on the bundled CD-ROM.

### Transferring Files Over a USB Connection

You can transfer images to a computer with a USB port simply by connecting the camera to the computer with the USB cable.

- Note that you need to install a USB driver on your computer the first time you try to connect. Once you use the cable to establish a USB connection, the computer sees the camera as an external storage device (card reader/writer).
- If you plan to transfer file data from the camera's built-in memory to your computer, make sure there is no memory card loaded in the camera. If there is, remove the memory card from the camera before you connect the USB cable.

#### NOTE

- Do not install the USB driver from the CD-ROM onto a computer running Windows XP, Mac OS 9, or Mac OS X. With these operating systems, USB communication becomes enabled simply by connecting the camera to the computer with the USB cable.

### ■ To connect the USB Cable

1. Turn on the camera.
2. Open the terminal panel cover and then use the USB cable to connect the camera to the computer.

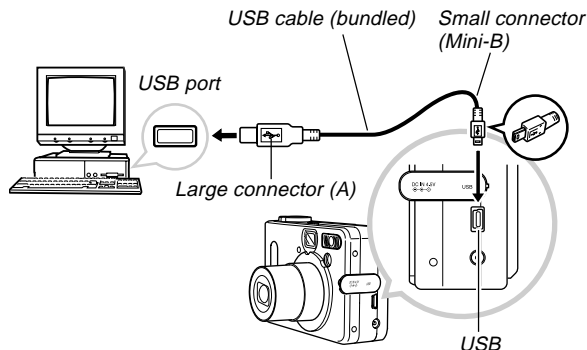

3. Import the images to the computer.
4. After image data transfer is complete, disconnect the USB cable.
  - For details, see "Terminating a USB Connection."

### ▶▶ IMPORTANT! ◀◀

- Be sure to read the applicable information in the user documentation that comes with your computer before connecting the USB cable.
- Do not leave the same image displayed on your computer screen for a long time. Doing so can cause the image to "burn in" on the screen.
- Take care when connecting the USB cable to the camera. The USB port and the cable plug are shaped for proper positioning.
- Plug the USB cable into the ports securely as far as it will go. Proper operation is not possible if connections are not correct.
- The camera does not draw power over the USB cable. Be sure to connect the AC adaptor to the camera for power.
- The optionally available CASIO QC-1U USB cable cannot be used with this camera.
- Never disconnect the USB cable while the PC is accessing camera memory (indicated by a flashing USB lamp). Doing so can cause data to become corrupted.
- You can perform USB data communication while the camera is in a recording mode or in the Play Mode.

### ■ Terminating a USB Connection

#### **Windows Me or 98**

Disconnect the USB cable from the camera, and then turn off the camera.

#### **Windows XP or 2000**

Click card services in the task tray on your computer screen, and disable the drive number assigned to the camera. Next, disconnect the USB cable from the camera, and then turn off the camera.

#### **Macintosh**

In Finder, drag the camera to the trashcan. Next, disconnect the USB cable from the camera and then turn off the camera.

### Transferring Files Using a Memory Card

The procedures in this section describe how to transfer images from the camera to your computer using a memory card.

- **Using a Computer with a Built-in SD Memory Card Slot**  
Insert the SD memory card directly into the slot.

- **Using a Computer with a Built-in PC Card Slot**  
Use a commercially available PC card adapter (for an SD memory card/MMC). For full details, see the user documentation that comes with the PC card adapter and your computer.

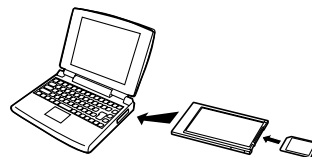



## USING THE CAMERA WITH A COMPUTER

### ● Using a Commercially Available SD Memory Card Reader/Writer

See the user documentation that comes with the SD memory card reader/writer for details about how to use it.

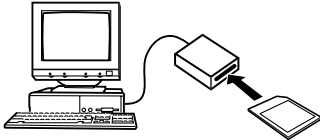

### ● Using a Commercially Available PC Card Reader/Writer and PC Card Adapter (for SD Memory Cards and MMCs)

See the user documentation that comes with the PC card reader/writer and PC card adapter (for an SD memory card/MMC) for details about how to use them.

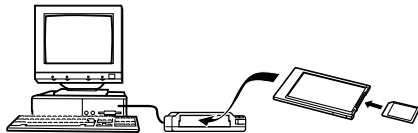

## Memory Data

Images recorded with this camera and other data are stored in memory using DCF (Design Rule for Camera File System) protocol. DCF protocol is designed to make it easier to exchange image and other data between digital cameras and other devices.

### ■ DCF Protocol

DCF devices (digital cameras, printers, etc.) can exchange images with each other. DCF protocol defines camera format for image file data and the directory structure for camera memory, so images can be viewed using another manufacturer's DCF camera or printed on a DCF printer.

## Memory Directory Structure

### ■ Directory Structure

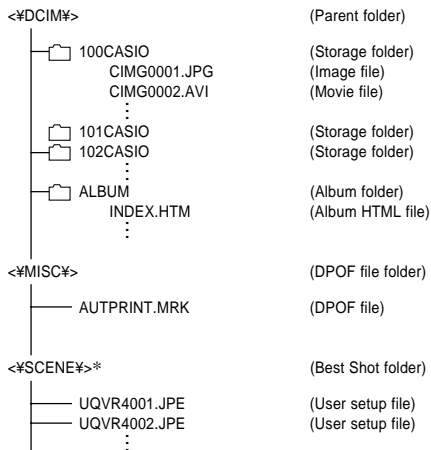

\* <¥SCENE¥> is created for built-in memory only.

### ■ Folder and File Contents

- Parent folder  
Folder that stores all of the digital camera files.
- Storage folder  
Folders for storing files stored with the digital camera.
- Image file  
File that contains an image recorded with the digital camera.
- Movie file  
File that contains a movie recorded with the digital camera.
- Album folder  
Folder that contains files used by the album function.
- Album HTML file  
File used by the album function.
- DPOF file folder  
Folder that contains DPOF files.
- Best Shot folder (Built-in memory only)  
Folder that contains Best Shot user setup files.
- User setup files (Built-in memory only)  
Files that contain user setups used by the Best Shot Mode.

### Supported Image Files

- Image files recorded with the CASIO QV-R3/QV-R4 Digital Camera
- DCF protocol image files

Certain DCF functions may not be supported. When displaying an image recorded on another camera model, it may take a long time for the image to appear on the display.

### Built-in Memory and Memory Card Precautions

- Note that the folder named "DCIM" is the parent (top) folder of all the files in memory. When transferring memory contents to a hard disk, MO disk, or other external storage, treat all the contents inside a DCIM folder as a set and always keep them together. You can change the name of the DCIM folder on your computer. Changing the name to a date is a good way to keep track of multiple DCIM folders. However, be sure you change the name of the DCIM folder back to "DCIM" before you copy it back to camera memory for playback on the camera. The camera does not recognize any folder name other than DCIM.
- We also strongly recommend that after transferring data from memory to other external storage that you reformat memory and delete its contents before using it to store more files. Remember that formatting memory deletes all of its contents. Check to make sure that you no longer need any of the files in memory before you format it.

### Using the Album Feature

The album feature of the camera creates an HTML layout that displays your images. You can use the HTML layout to post your images on a Web page, or for printing the images.

- You can use the Web browser shown below to view or print the contents of an album. Note that to view a movie on a computer running Windows 2000 or 98, you need to install DirectX.

Microsoft Internet Explorer Ver 5.5 or later

### Creating an album

1. In the Play Mode, press .

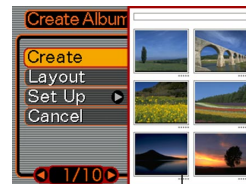

Sample layout

2. Use  $[\wedge]$  and  $[\vee]$  to select “Create,” and then press SET.

- This starts creation of the album, and causes the message “Busy.... Please wait...” to appear on the monitor screen.
- After creation of the album is complete, press the MENU button to exit the menu screen.
- Creating an album causes a file folder named “ALBUM,” which contains a file named “INDEX.HTM” plus other files to be created in camera memory or on the memory card.

### ▶▶ IMPORTANT! ◀◀

- Never open the battery cover or remove the memory card from the camera while an album is being created. Doing so not only runs the risk of certain album files being skipped, it can also result in image data and other data in memory being corrupted.
- If memory becomes full while an album is being created, the message "Memory Full" appears on the monitor screen and album creation is terminated.
- Album creation will not be performed properly if the battery goes dead while album creation is in progress.
- You can also configure the camera to create albums automatically (page 127). However, performing the above procedure creates an album regardless of whether automatic album creation is turned on or off.

## Selecting an Album Layout



You can select from among 10 different display layouts for an album.

1. In the Play Mode, press .
2. Use [^] and [v] to select "Layout."
3. Use [<] and [>] to select the layout you want.
  - Changing the layout causes the layout sample on the right side of the screen to change.

### ▶▶ IMPORTANT! ◀◀

- The sample layout shows the arrangement of items and the background color. It does not show whether the layout uses a list view or detailed view, or if hot linking is turned on or off.

## Configuring Detailed Album Settings

1. In the Play Mode, press .
2. Use [^] and [v] to select “Set Up,” and then press [>].
 
3. Use [^] and [v] to select the item whose setting you want to change, and then press [>].
  - Details about each of the settings are provided in the following sections.
4. Use [^] and [v] to change the setting, and then press SET.

### ■ Background Color

You can specify white, black, or gray as the color of the album background using the procedure under “Configuring Detailed Album Settings.”

### ■ Album Type

There are two album types: Normal and Index/Info.

**Normal Type** : This type of album displays images in accordance with the currently selected layout.

**Index/Info Type** : In addition to the normal album screen, this type of album also includes thumbnails of images and detailed information about each image.

### ■ Hot Linking On/Off

This setting controls whether or not you can enlarge movies, or play movies or audio files from your Web browser. Each image in the album represents either a still image or a movie. When hot linking is turned on, clicking an album image displays the corresponding still image or plays the corresponding movie. This setting lets you turn album image hot linking on or off.

## USING THE CAMERA WITH A COMPUTER

To get this:	Select this hot linking setting:
High-resolution album images when printing album pages <b>»» NOTES ««</b> <ul style="list-style-type: none"><li>• Since images are high resolution, it takes a longer time to display them on your computer screen.</li><li>• With this setting, you cannot enlarge images or play movies.</li></ul>	Off
Lower resolution album images for album browsing and publishing thumbnails on a Website <b>»» NOTES ««</b> <ul style="list-style-type: none"><li>• Clicking an image displays its enlarged version, which you can use for viewing and printing.</li><li>• With this setting, clicking an AVI file image plays the movie.</li></ul>	On

### ■ Auto Album Creation On/Off

This setting controls whether an album is created automatically whenever you turn off the camera.

To do this:	Select this option:
Turn off auto album creation	Off
Turn on auto album creation	On

- When auto album creation is turned on, an album is created automatically in built-in memory or on the memory card whenever you turn off the camera.

### »» IMPORTANT! ««

- When you turn off the camera while auto album creation is turned on, the monitor screen turns off, but the operation lamp continues to flash for a few seconds to indicate that the album creation process is being performed. Never open the battery cover or remove the memory card while the green operation lamp is flashing.

### »» NOTE ««

- Depending on the number of images in memory, it can take quite a bit of time to complete auto album creation when you turn off the camera. If you do not plan to use the album feature, we suggest that you keep auto album creation turned off, which shortens the amount of time the camera takes to power down completely.

## Viewing Album Files

You can view and print album files using your computer's Web browser application.

1. Use your computer to access the data in built-in memory or on the memory card, or access a memory card with your computer (pages 118 and 120).
2. Open the built-in memory "ALBUM" folder or the memory card "ALBUM" folder, which is located inside the folder named "DCIM."
3. Use your computer's Web browser to open the file named "INDEX.HTM."

- This displays a list of folders in built-in memory or on the memory card.

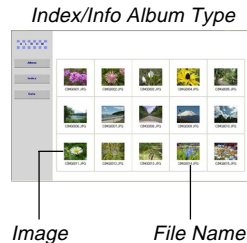

4. If you created the album after selecting "Normal" type or "Index/Info" as the album type under "Configuring Detailed Album Settings" on page 126, you can click one of the following display options.

Album : Displays an album created by the camera.

Index : Displays a list of images stored in a folder.

Info : Displays information about each image.

- If hot linking is turned on for the album, you can double-click an image on your computer screen to display the full-size version.

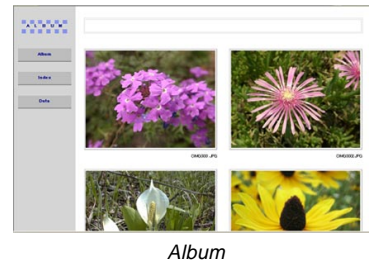



## USING THE CAMERA WITH A COMPUTER



Index



Info

- The following describes the information that appears on the Info Screen.

This Info Screen item:	Shows this:
File Size	Image file size
Resolution	Resolution
Quality	Quality
Drive mode	Drive mode
AE	Exposure mode
Light metering	Metering mode
Shutter speed	Shutter speed
Aperture stop	Aperture stop
Exposure comp	Exposure compensation
Focusing mode	Focusing mode
Flash mode	Flash mode
Sharpness	Sharpness
Saturation	Saturation
Contrast	Contrast
White balance	White balance
Sensitivity	Sensitivity
Filter	Filter setting
Enhancement	Enhancement setting
Flash intensity	Flash intensity
Digital zoom	Digital zoom setting
World	Location
Date	Recording date and time
Model	Camera model name

### »» NOTES ««

- When printing an album page, you should set up your Web browser as described below.
  - Select the browser frame where the images are located.
  - Set margins to the lowest possible values.
  - Set the background color to a printable color.
- See the user documentation that came with your Web browser application for details about printing and configuring settings for printing.

### **5. After you are finished viewing the album, exit your Web browser application.**

## Saving an Album

- To save an album, copy the “DCIM” folder from camera memory or the memory card to your computer’s hard disk, a floppy diskette, an MO disk, or some other storage medium. Note that copying only the “ALBUM” folder, does not copy image data and other necessary files.
- After copying the “DCIM” folder, do not change or delete any of the files inside of it. Adding new images or deleting existing images may lead to abnormal album display.
- If you plan to use a memory card again after saving its album, first delete all of its files or format it before loading it into the camera.





# APPENDIX

## Menu Reference

The tables in this section show the items that appear on each recording mode and Play Mode tab. Underlined items are factory defaults.

## Recording Mode Menu

### ● REC tab menu

Size	QV-R3: <u>2048</u> × <u>1536</u> / 1600 × 1200 / 1280 × 960 / 640 × 480 QV-R4: 2304 × 1712 / <u>2240</u> × <u>1680</u> / 1600 × 1200 / 1280 × 960 / 640 × 480
Quality	Fine / <u>Normal</u> / Economy
White Balance	<u>Auto</u> /  (Sunlight) /  (Shade) /  (Light Bulb) /  (Fluorescent) / Manual
ISO	QV-R3: <u>Auto</u> / ISO 125 / ISO 250 QV-R4: <u>Auto</u> / ISO 100 / ISO 200
Metering	<u>Multi</u> / Center weighted / Spot
Filter	<u>Off</u> / B/W / Sepia / Red / Green / Blue / Yellow / Pink / Purple
Enhance	<u>Off</u> / Red / Green / Blue / Flesh Tone
Sharpness	Soft / <u>Normal</u> / Hard
Saturation	Low / <u>Normal</u> / High
Contrast	Low / <u>Normal</u> / High

Flash Intensity	Weak / <u>Normal</u> / Strong
Grid	<u>Off</u> / On
Digital Zoom	Off / <u>On</u>

### ● Memory tab menu

Flash	<u>On</u> / Off
Focus	On / <u>Off</u>
White Balance	On / <u>Off</u>
ISO	On / <u>Off</u>
Metering	On / <u>Off</u>
Flash Intensity	On / <u>Off</u>
Digital Zoom	<u>On</u> / Off
MF Position	On / <u>Off</u>

## ● Set Up tab menu

File No.	<u>On</u> / Off
Beep	<u>On</u> / Off
Startup	<u>On (Selectable image)</u> / Off
World Time	<u>Home</u> / World
	Home time setup (city, DST, etc.)
	World Time setup (city, DST, etc.)
Date Style	<u>YY/MM/DD</u> / DD/MM/YY / MM/DD/YY
Adjust	Time setting
Language	日本語 / <u>English</u> / Français / Deutsch / Español / Italiano
Sleep	30 sec / <u>1 min</u> / 2 min / Off
Auto Power Off	<u>3 min</u> / 5 min / Off
Format	Format / <u>Cancel</u>
Reset	Reset / <u>Cancel</u>

## PLAY Mode Menu

## ● PLAY tab menu

Resize	1280 × 960 / 640 × 480 / Cancel
Trimming	—
Alarm	Alarm setups
Copy	Built-in → Card / Card → Built-in / Cancel

## ● Set Up tab menu

File No.	<u>On</u> / Off
Beep	<u>On</u> / Off
Startup	<u>On (Selectable image)</u> / Off
World Time	<u>Home</u> / World
	Home time setup (city, DST, etc.)
	World Time setup (city, DST, etc.)
Date Style	<u>YY/MM/DD</u> / DD/MM/YY / MM/DD/YY
Adjust	Time setting
Language	日本語 / <u>English</u> / Français / Deutsch / Español / Italiano
Sleep	30 sec / <u>1 min</u> / 2 min / Off
Auto Power Off	<u>3 min</u> / 5 min / Off
Format	Format / <u>Cancel</u>
Reset	Reset / <u>Cancel</u>

## Indicator Lamp Reference

The camera has three indicator lamps: a green operation lamp, a red operation lamp, and a self-timer lamp. These lamps light and flash to indicate the current operational status of the camera.

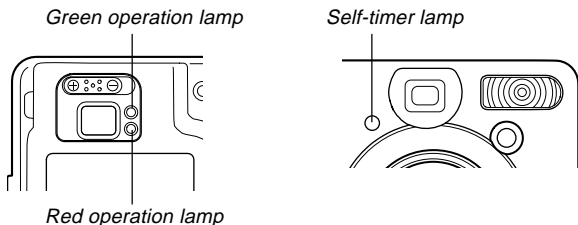

\* There are three lamp flash patterns. Pattern 1 flashes once per second, Pattern 2 flashes twice per second, and Pattern 3 flashes four times per second. The table below explains what each flash pattern indicates.

## Recording Mode

Operation Lamp		Self-timer Lamp	Meaning
Green	Red	Red	
Lit			Operational (Power on, recording enabled)
Pattern 1	Pattern 1		Interval recording is stopped.
	Pattern 3		Flash is charging.
	Lit		Flash charging is complete.
Lit			Auto Focus operation was successful.
Pattern 3			Cannot Auto Focus.
Lit			Monitor screen is off.
Pattern 2	Pattern 2		Storing image
Pattern 1	Pattern 1		Storing movie
		Pattern 1	Self-timer countdown (10 to 3 seconds)
		Pattern 2	Self-timer countdown (3 to 0 seconds)
	Pattern 1		Cannot charge flash.
	Pattern 2		Memory card problem / Memory card is unformatted. / Best Shot setup cannot be registered.
	Lit		Memory card is locked / Cannot create folder. / Memory is full. / Write error

## APPENDIX

Operation Lamp		Self-timer Lamp	Meaning
Green	Red	Red	
	Pattern 3		Low battery alert
Pattern 3			Formatting card
Pattern 3			Powering down

### ▶▶ IMPORTANT! ◀◀

- When you are using a memory card, never remove the card from the camera while the green operation lamp is flashing. Doing so will cause recorded images to be lost.

## Play Mode

Operation Lamp		Self-timer Lamp	Meaning
Green	Red	Red	
Lit			Operational (Power on, recording enabled)
Pattern 1			Interval recording is stopped.
Pattern 3			One of the following operations is being performed: delete, DPOF, image protect, copy, album creation, format, power down
	Pattern 2		Memory card problem / Memory card is unformatted.
	Lit		Memory card is locked / Cannot create folder. / Memory is full.
	Pattern 3		Low battery alert

## Charger Unit

The charger unit has a CHARGE lamp that lights or flashes in accordance with the charger unit operation that is being performed.

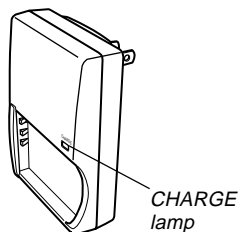

CHARGE Lamp		Meaning
Green	Red	
	Lit	Charging
Lit		Charging complete
	Pattern 1	Charging problem (Ambient temperature is too high or too low.)
	Pattern 3	Charger unit or battery abnormality

## Troubleshooting Guide

	Symptom	Possible Cause	Action
Power Supply	Power does not turn on.	<ol style="list-style-type: none"> <li>1) The battery is not oriented correctly.</li> <li>2) The battery is dead.</li> </ol>	<ol style="list-style-type: none"> <li>1) Orient the battery correctly (page 25).</li> <li>2) Charge the battery (page 24). If the battery goes dead soon after being charged, it means the battery has reached the end of its life and needs to be replaced. Purchase a separately available NP-30 rechargeable lithium ion battery.</li> </ol>
	Camera suddenly powers down.	<ol style="list-style-type: none"> <li>1) Auto Power Off activated (page 33).</li> <li>2) The battery is dead.</li> </ol>	<ol style="list-style-type: none"> <li>1) Turn power back on.</li> <li>2) Charge the battery (page 24).</li> </ol>
Image Recording	Image is not recorded when the shutter release button is pressed.	<ol style="list-style-type: none"> <li>1) The mode dial is set to  (Play Mode).</li> <li>2) Flash unit is being charged.</li> <li>3) Memory is full.</li> </ol>	<ol style="list-style-type: none"> <li>1) Use the mode dial to select a recording mode (page 38).</li> <li>2) Wait until the flash unit finishes charging.</li> <li>3) Transfer files you want to keep to your computer and then delete files from camera memory, or use a different memory card.</li> </ol>
	Auto Focus does not focus properly	<ol style="list-style-type: none"> <li>1) The lens is dirty.</li> <li>2) The subject is not located in the center of the focus frame when you compose the image.</li> <li>3) The subject you are shooting is a type that is not compatible with Auto Focus operation (page 41).</li> <li>4) You are moving the camera.</li> </ol>	<ol style="list-style-type: none"> <li>1) Clean the lens.</li> <li>2) Make sure the subject is centered in the focus frame when composing the image.</li> <li>3) Use manual focus (page 55).</li> <li>4) Mount the camera on a tripod.</li> </ol>



## APPENDIX

	Symptom	Possible Cause	Action
Image Recording	The subject is out of focus in the recorded image.	The image is not focused properly.	When composing the image, make sure the subject on which you want to focus is located inside the focus frame.
	Camera powers down during self-timer countdown.	The battery is dead.	Charge the battery (page 24).
	Monitor screen image is out of focus.	<ol style="list-style-type: none"> <li>1) You are using the Manual Focus Mode and have not focused the image.</li> <li>2) You are trying to use the Macro Mode when shooting a scenery or portrait shot.</li> <li>3) You are trying to use Auto Focus or the Infinity Mode (<math>\infty</math>) when shooting a close-up shot.</li> </ol>	<ol style="list-style-type: none"> <li>1) Focus the image (page 55).</li> <li>2) Use Auto Focus for scenery and portrait shots.</li> <li>3) Use the Macro Mode for close-ups.</li> </ol>
	Recorded images are not saved in memory.	<ol style="list-style-type: none"> <li>1) Camera powers down before the save operation is complete.</li> <li>2) Removing the memory card before the save operation is complete.</li> </ol>	<ol style="list-style-type: none"> <li>1) When the battery indicator shows , charge the battery as soon as possible (page 24).</li> <li>2) Do not remove the memory card before the save operation is complete.</li> </ol>
Playback	Color of the playback image is different from the image on the monitor screen during recording.	Sunlight or light from another source is shining directly into the lens during recording.	Position the camera so sunlight does not shine directly into the lens.

## APPENDIX

	Symptom	Possible Cause	Action
Playback	Images are not displayed.	A memory card with non-DCF images recorded with another camera is loaded in the camera.	This camera cannot display non-DCF images recorded onto a memory card using another digital camera.
	All buttons and switches are disabled.	Circuit problem caused by electrostatic charge, impact, etc. while the camera was connected to another device.	Remove the battery from the camera, reinsert it, and then try again.
Other	Monitor screen is off.	<ol style="list-style-type: none"> <li>1) USB communication is in progress.</li> <li>2) The monitor screen is turned off (in a recording mode).</li> </ol>	<ol style="list-style-type: none"> <li>1) After confirming that the computer is not accessing camera memory, disconnect the USB cable.</li> <li>2) Press DISP to turn on the monitor screen.</li> </ol>
	Cannot transfer files over a USB connection.	<ol style="list-style-type: none"> <li>1) USB cable is not connected securely.</li> <li>2) USB driver is not installed.</li> <li>3) Camera is turned off.</li> </ol>	<ol style="list-style-type: none"> <li>1) Check all connections.</li> <li>2) Install the USB driver on your computer (page 110).</li> <li>3) Turn on the camera.</li> </ol>

## Display Messages

---

**Battery is low.** The battery is dead.

---

**BEST SHOT memory is full.** You are attempting to register a Best Shot setup when the "SCENE" folder already contains 999 set-ups.

---

**Card ERROR** Some problem occurred with the memory card. Turn off the camera, and remove and then reinsert the memory card. If the same message appears, format the memory card (page 106).

**»» IMPORTANT! ««**

Formatting the memory card deletes all files on the memory card. Before formatting, try transferring recoverable files to a computer or some other storage device.

---

**Folder cannot be created.** This message appears when you try to record an image while there are 9,999 files stored in the 999th folder. If you want to record more files, delete files you no longer need (page 89).

---

**Memory Full** Memory is full. If you want to record more files, delete files you no longer need (page 89).

---

**Record Error** Image compression could not be performed during image data storage for some reason. Record the image again.

---

**SYSTEM ERROR** Your camera system is corrupted. Contact your retailer or a CASIO service center.

---



---

**The card is locked.** The LOCK switch of the SD memory card is locked. You cannot store images to or delete images from a memory card that is locked.

---

**The card is not formatted.** The memory card is not formatted. Format the memory card (page 106).

---

**The function is not supported for this file.** The function you are trying to perform is not supported for the file on which you are trying to perform it.

---

**There are no files.** There are no files in built-in memory or on the memory card.

---

**This file cannot be played.** The image file or audio file is corrupted, or is a type that cannot be displayed by this camera.

---

**This function cannot be used.** You attempted to copy files from built-in memory to a memory card while there is no memory card loaded in the camera (page 107).

---

## Specifications

### Main Specifications

**Product:** ..... Digital Camera

**Model:** ..... QV-R3/QV-R4

### ■ Camera Functions

#### Image Files Format

Snapshots: ..... JPEG (Exif Ver.2.2); DCF (Design rule for Camera File system) 1.0 standard; DPOF compliant

Movies: ..... AVI (Motion JPEG)

**Recording Media:** ..... 11MB built-in flash memory  
SD Memory Card  
Multimedia Card

#### Image Size

Snapshots: ..... 2304 x 1712 pixels (QV-R4)  
2240 x 1680 pixels (QV-R4)  
2048 x 1536 pixels (QV-R3)

1600 x 1200 pixels

1280 x 960 pixels

640 x 480 pixels

Movies: ..... 320 x 240 pixels

### Approximate Memory Capacity and File sizes:

#### • Snapshots

File Size (pixels)	Quality	Approximate Image File Size	Built-in flash memory 11MB	SD Memory Card* 64MB
2304 x 1712 (QV-R4)	Fine	1.8MB	5 shots	30 shots
	Normal	1.4MB	7 shots	40 shots
	Economy	1.0MB	9 shots	54 shots
2240 x 1680 (QV-R4)	Fine	1.8MB	5 shots	30 shots
	Normal	1.4MB	7 shots	40 shots
	Economy	1.0MB	9 shots	54 shots
2048 x 1536 (QV-R3)	Fine	1.6MB	6 shots	34 shots
	Normal	1.2MB	8 shots	45 shots
	Economy	630KB	15 shots	88 shots
1600 x 1200 (UXGA)	Fine	1050KB	9 shots	53 shots
	Normal	710KB	14 shots	79 shots
	Economy	370KB	27 shots	154 shots
1280 x 960 (SXGA)	Fine	680KB	14 shots	82 shots
	Normal	460KB	22 shots	126 shots
	Economy	250KB	39 shots	220 shots
640 x 480 (VGA)	Fine	190KB	52 shots	294 shots
	Normal	140KB	68 shots	386 shots
	Economy	90KB	110 shots	618 shots

## APPENDIX

### • Movies (320 x 240 pixels)

Data Size	200KB/second max.
Recording Time	One Movie: 30 seconds maximum Total Movie Time: 60 seconds maximum (built-in memory) 330 seconds maximum (SD 64MB memory card)*

\* Based on Matsushita Electric Industrial Co., Ltd. products. Capacity depends on card manufacturer.

\* To determine the number of images that can be stored on a memory card of a different capacity, multiply the capacities in the table by the appropriate value.

**Delete:** ..... Single-file, all files (with protection)

### Effective Pixels

QV-R3: ..... 3.20 million

QV-R4: ..... 4.00 million

### Imaging Element

QV-R3: ..... 1/1.8-inch square pixel color CCD  
(Total pixels: 3.34 million)

QV-R4: ..... 1/1.8-inch square pixel color CCD  
(Total pixels: 4.13 million)

### Lens/Focal Distance

QV-R3: ..... F2.6 (W) to 4.8 (T); f=7.6 (W) to 22.8mm (T) (equivalent to approximately 37 (W) to 111mm (T) for 35mm film)

QV-R4: ..... F2.6 (W) to 4.8 (T); f=7.6 (W) to 22.8mm (T) (equivalent to approximately 37.5 (W) to 112.5mm (T) for 35mm film)

**Zoom:** ..... 3X optical zoom; 3.2X digital zoom  
(9.6X in combination with optical zoom)

**Focusing:** ..... Contrast-type Auto Focus (Macro Mode, Infinity Mode); manual focus; focus lock

### Approximate Focus Range (from lens surface)

Normal: ..... 40cm to ∞ (1.3' to ∞)

Macro: ..... 14cm to 50cm (5.5" to 19.7")

Optical zoom is disabled in the Macro Mode. Zoom is fixed at maximum wide angle.

### Exposure Control

Light Metering: ..... Multi-pattern, center-weighted, spot by CCD

Exposure: ..... Program AE

Exposure Compensation: ... -2EV to +2EV (1/3EV units)

**Shutter:** ..... CCD electronic shutter; mechanical shutter, 2 to 1/2000 second

**Aperture:** ..... F2.6/5.0, auto switching

**White Balance:** ..... Automatic, fixed (4 modes), manual switching

**Self-timer:** ..... 10 seconds, 2 seconds, Triple Self-timer

### Built-in Flash

Flash Modes: ..... AUTO, ON, OFF, Red eye reduction

Flash Range: ..... Approximately 0.4 to 3.2 meters  
(1.3' to 10.5') (QV-R3)  
Approximately 0.4 to 2.8 meters  
(1.3' to 9.2') (QV-R4)

## APPENDIX

**Recording Functions:** ..... Snapshot; Best Shot; Coupling Shot; Night Scene; Manual Exposure; Movie; Interval Mode

**Monitor Screen:** ..... 1.6-inch TFT color LCD  
84,960 pixels (354 x 240)

**Viewfinder:** ..... Monitor screen and optical viewfinder

**Timekeeping Functions** .... Built-in digital quartz clock  
Date and Time: ..... Recorded with image data  
Auto Calendar: ..... To 2049

**World Time:** ..... City; Date; Time; Summer time;  
162 cities in 32 time zones

**Input/Output Terminals:** ... AC adaptor terminal (DC IN 4.5V);  
USB port (MINI-B)

## ■ Power Requirements

**Power Requirements:** ..... Rechargeable lithium ion battery (NP-30) x 1  
AC adaptor (AD-C40)

### Approximate Battery Life:

Continuous Recording	QV-R3	120 minutes (720 shots)
	QV-R4	110 minutes (660 shots)
Continuous Playback (Continuous Snapshot Recording)	QV-R3	220 minutes
	QV-R4	220 minutes

The values noted above are approximate values until power fails at normal temperature (25°C (77°F)). The above does not guarantee that you will be able to achieve this level of operation. Low temperatures shorten battery life (page 26).

**Power Consumption:** ..... DC 4.5V Approximately 5.4W

**Dimensions:** ..... 90.0(W) x 59.0(H) x 31.0(D) mm  
(3.5"(W) x 2.3"(H) x 1.2"(D))  
(excluding projections  
Thickest Part: 35.0mm (1.4"))

**Weight:** ..... Approximately 200 g (7.05 oz)  
(excluding battery and accessories)

**Bundled Accessories:** ..... Rechargeable lithium ion battery (NP-30); Special battery charger unit (BC-20); Special USB cable; Strap; CD-ROM; User's Guide

■ **Rechargeable Lithium Ion Battery (NP-30)**

**Rated Voltage:** ..... 3.7 V

**Rated Capacitance:** ..... 1000 mAh

**Operating Temperature**

**Range:** ..... 0°C to 40°C (32°F to 104°F)

**Dimensions:** ..... 35.3 (W) x 53.1 (H) x 7.1 (D) mm  
(1.4" (W) x 2.1" (H) x 0.3" (D))

**Weight:** ..... Approximately 28 g (0.99 oz)

■ **Special battery charger unit (BC-20)**

**Power Requirement:** ..... 100 to 240V AC, 0.2A, 50/60Hz

**Output:** ..... DC 4.2V, 650mA

**Charging Temperature:** ... 0°C to 40°C (32°F to 104°F)

**Chargeable Battery type:** ... CASIO Lithium-ion rechargeable battery (NP-30)

**Full Charge Times:** ..... Approximately 2 hours

**Dimensions:** ..... 65.0(W) x 90.0(H) x 30.5(D) mm  
(2.6"(W) x 3.5"(H) x 1.2"(D))  
(excluding projections)

**Weight:** ..... Approximately 120g (4.23 oz)

**Power Supply**

- Use only the special NP-30 rechargeable lithium ion battery to power this camera. Use of any other type of battery is not supported.
- This camera does not have a separate battery for the clock. The date and time settings of the camera are cleared whenever power is totally cut off (from both the battery and AC adaptor). Be sure to reconfigure these settings after power is interrupted (page 36).

**LCD Panel**

- The LCD panel is a product of the latest LCD manufacturing technology that provides a pixel yield of 99.99%. This means that less than 0.01% of the total pixels are defective (they do not turn on or always remain turned on).

## Free Manuals Download Website

<http://myh66.com>

<http://usermanuals.us>

<http://www.somanuals.com>

<http://www.4manuals.cc>

<http://www.manual-lib.com>

<http://www.404manual.com>

<http://www.luxmanual.com>

<http://aubethermostatmanual.com>

Golf course search by state

<http://golfingnear.com>

Email search by domain

<http://emailbydomain.com>

Auto manuals search

<http://auto.somanuals.com>

TV manuals search

<http://tv.somanuals.com>