

# CASIO®

Digital Camera

# EX-FS10

## User's Guide

E

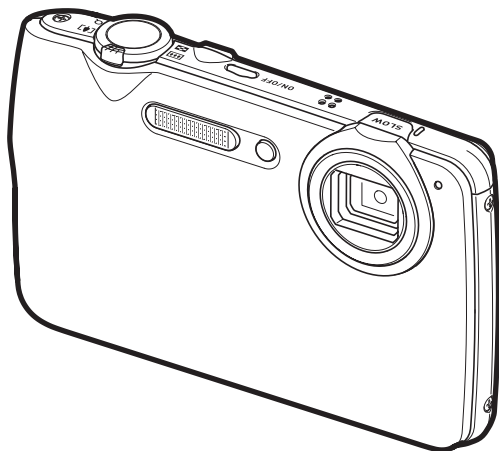

Thank you for purchasing this CASIO product.

- Before using it, be sure to read the precautions contained in this User's Guide.
- Keep the User's Guide in a safe place for future reference.
- For the most up-to-date information about this product, visit the official EXILIM Website at <http://www.exilim.com/>

# EXILIM

Download from [www.Somanuals.com](http://www.Somanuals.com). All Manuals Search And Download.

## Unpacking

As you unpack your camera, check to make sure that all items shown below are included. If anything is missing, contact your original retailer.



Digital camera

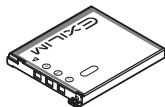

Rechargeable lithium ion  
battery (NP-60)

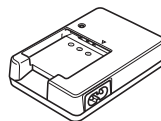

Charger unit (BC-60L)

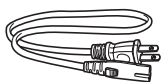

\* The shape of the power cord plug varies according to country or geographic area.

Power cord

To attach the strap to the camera

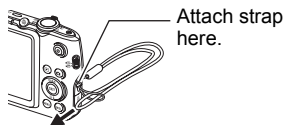

Strap



USB cable

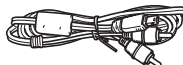

AV cable



CD-ROM

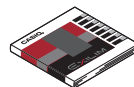

Basic Reference

## Read this first!

- The contents of this manual are subject to change without notice.
- The contents of this manual have been checked at each step of the production process. Feel free to contact us if you notice anything that is questionable, erroneous, etc.
- Any copying of the contents of this User's Guide, either in part or its entirety, is forbidden. Except for your own personal use, any other use of the contents of this manual without the permission of CASIO COMPUTER CO., LTD. is forbidden under copyright laws.
- CASIO COMPUTER CO., LTD. shall not be held liable for any damages or lost profits suffered by you or any third party due to the use or malfunction of this product.
- CASIO COMPUTER CO., LTD. shall not be held liable for any damages, lost profits, or claims by third parties arising out of the use of Photo Transport or YouTube Uploader for CASIO.
- CASIO COMPUTER CO., LTD. shall not be held liable for any damages or lost profits caused by loss of memory contents due to malfunction, repair, or any other reason.
- Note that the example screens and product illustrations shown in this User's Guide may differ somewhat from the screens and configuration of the actual camera.

### LCD Panel

The liquid crystal panel of the monitor screen uses high-precision technology that provides a pixel yield in excess of 99.99%. This means that some very small number of pixels may not light or may remain lit at all times. This is due to the characteristics of the liquid crystal panel, and does not indicate malfunction.

#### Take test shots

Before shooting your final image, shoot a test shot to ensure that the camera is recording correctly.

# Contents

Unpacking .....	2
Read this first! .....	3
General Guide .....	9
Monitor Screen Contents .....	11

## ■ Quick Start Basics 14

---

What is a digital camera? .....	14
What you can do with your CASIO camera .....	15
First, charge the battery prior to use.....	16
■ To charge the battery .....	16
■ To load the battery .....	17
Configuring Basic Settings the First Time You Turn On the Camera.....	19
Preparing a Memory Card .....	20
■ Supported Memory Cards.....	20
■ To load a memory card .....	21
■ To format (initialize) a new memory card .....	22
Turning the Camera On and Off .....	23
■ To turn power on .....	23
■ To turn off the camera .....	23
To shoot a snapshot.....	24
Holding the Camera Correctly .....	27
Viewing Snapshots .....	28
Deleting Images.....	29
■ To delete a single file .....	29
■ To delete all files .....	29
Snapshot Shooting Precautions .....	30
■ Auto Focus Restrictions .....	30

## ■ Snapshot Tutorial 31

---

Using the Control Panel.....	31
Changing the Image Size .....	(Size) .. 32
Specifying ISO Sensitivity .....	(ISO) .. 35
Adjusting White Balance .....	(White Balance) .. 35
Correcting Image Brightness .....	(EV Shift) .. 37
Shooting with Slow Motion View .....	38
Using Lag Correction .....	(Lag Correction) .. 40
Using Flash .....	(Flash) .. 42
Changing the Control Panel Date/Time Style .....	44
Shooting with Zoom.....	44
■ Optical Zoom/Digital Zoom Switch Point.....	45
Using Continuous Shutter .....	47
■ Using Normal-speed Continuous Shutter .....	47
■ Using High Speed CS and Prerecord CS .....	48
■ Specifying the Method for Saving Continuous Shutter Images.....	52
■ Continuous Shutter Precautions .....	54

## ■ Recording Movies

55

To record a movie	55
■ Audio	56
Recording a High-definition Movie	57
Recording a High Speed Movie	58
Using Prerecord Movie	(Prerecord (Movie)) 59
Recording a Movie for YouTube	(For YouTube) 61
Shooting a Snapshot while Shooting a Movie	62

## ■ Using BEST SHOT

63

What is BEST SHOT?	63
■ Some Sample Scenes	63
To shoot with BEST SHOT	63
■ Creating Your Own BEST SHOT Setups	66
Shooting with High Speed Night Scene	(High Speed Night Scene) 67
Shooting with High Speed Anti Shake	(High Speed Anti Shake) 68
Isolating Moving Subjects	(Multi-motion image) 69
■ Basic Multi-motion image Procedure	69
Shooting with Priority on Subject Faces	(High Speed Best Selection) 71
Shooting an Image in Accordance with Subject Movement	(Move Out CS/Move In CS) 72

## ■ Advanced Settings

77

Using On-screen Menus	77
REC Mode Settings	(REC) 79
■ Selecting a Focus Mode	(Focus) 79
■ Using the Self-timer	(Self-timer) 82
■ Reducing the Effects of Camera and Subject Movement	(Anti Shake) 83
■ Specifying the Auto Focus Area	(AF Area) 84
■ Using the Auto Focus Assist Light	(AF Assist Light) 85
■ Shooting with Face Detection	(Face Detection) 85
■ Shooting with Continuous Auto Focus	(Continuous AF) 86
■ Changing the Continuous Shutter Mode	(CS) 87
■ Configuring the Continuous Shutter Image Save Method	(Save CS Images) 87
■ Turning Digital Zoom On or Off	(Digital Zoom) 87
■ Assigning Functions to the [◀] and [▶] Keys	(L/R Key) 88
■ Shooting with Quick Shutter	(Quick Shutter) 88
■ Displaying the On-screen Grid	(Grid) 89
■ Turning on Image Review	(Review) 89
■ Using Icon Help	(Icon Help) 89
■ Configuring Power On Default Settings	(Memory) 90
Image Quality Settings	(Quality) 91
■ Specifying Snapshot Image Quality	(☐ Quality (Snapshot)) 91
■ Movie Image Quality Settings	(📹 Quality (Movie)) 91
■ Setting the High Speed Movie Frame Rate	(HS 📹 Speed) 92

■ Specifying the Metering Mode .....	(Metering) ... 92
■ Optimizing Image Brightness .....	(Lighting) ... 92
■ Specifying Flash Intensity .....	(Flash Intensity) ... 93
■ Using Built-in Color Filters .....	(Color Filter) ... 93
■ Controlling Image Sharpness .....	(Sharpness) ... 93
■ Controlling Color Saturation .....	(Saturation) ... 93
■ Adjusting Image Contrast .....	(Contrast) ... 93

## ■ Viewing Snapshots and Movies 94

---

Viewing Snapshots .....	94
Viewing a Movie .....	94
Viewing Continuous Shutter Images .....	95
■ Deleting Continuous Shutter Images .....	97
■ Dividing Up a CS Group .....	98
■ Copying a CS Group Image .....	99
Zooming an On-screen Image .....	100
Displaying the Image Menu .....	100
Viewing Snapshots and Movies on a TV Screen .....	101

## ■ Other Playback Functions (PLAY) 103

---

Playing a Slideshow on the Camera .....	(Slideshow) . 103
■ Transferring Music from Your Computer to Camera Memory .....	104
Creating a Snapshot of Movie Frames .....	(MOTION PRINT) . 106
Editing a Movie on the Camera .....	(Movie Editing) . 107
Adjusting White Balance .....	(White Balance) . 109
Adjusting the Brightness of an Existing Snapshot .....	(Brightness) . 110
Selecting Images for Printing .....	(DPOF Printing) . 110
Protecting a File Against Deletion .....	(Protect) . 111
Rotating an Image .....	(Rotation) . 114
Resizing a Snapshot .....	(Resize) . 114
Cropping a Snapshot .....	(Trimming) . 115
Copying Files .....	(Copy) . 115
Dividing Up a Continuous Shutter Group .....	(Divide Group) . 116
Editing a CS Image .....	(CS Frame Edit) . 116

## ■ Printing 117

---

Printing Snapshots .....	117
Connecting Directly to a PictBridge Compatible Printer .....	117
Using DPOF to Specify Images to be Printed and the Number of Copies .....	120

## ■ Using the Camera with a Computer 124

---

Things you can do using a computer...	124
Using the Camera with a Windows Computer .....	125
■ Viewing and Storing Images on a Computer .....	126

■ Playing Movies .....	130
■ Uploading Movie Files to YouTube .....	131
■ Viewing User Documentation .....	(PDF Files) . 132
■ Transferring Images from Your Computer to Camera Memory .....	133
■ User Registration .....	134
Using the Camera with a Macintosh .....	135
■ Connecting the Camera to Your Computer and Saving Files .....	135
■ Transferring Images Automatically and Managing Them on Your Macintosh .....	138
■ Playing a Movie .....	138
■ Viewing User Documentation .....	(PDF Files) . 139
■ User Registration .....	139
Using an Eye-Fi Wireless SD Memory Card to Transfer Images . (Eye-Fi) .	140
Files and Folders .....	141
Memory Card Data .....	142

## ■ Other Settings (Set Up) 144

---

Adjusting Monitor Screen Brightness .....	(Screen) . 144
Turning off Eye-Fi Card Communication .....	(Eye-Fi) . 144
Configuring Camera Sound Settings .....	(Sounds) . 145
Specifying the File Name Serial Number Generation Rule .....	(File No.) . 145
Configuring World Time Settings .....	(World Time) . 146
Time Stamping Snapshots .....	(Timestamp) . 147
Setting the Camera's Clock .....	(Adjust) . 147
Specifying the Date Style .....	(Date Style) . 148
Specifying the Display Language .....	(Language) . 148
Configuring Sleep State Settings .....	(Sleep) . 149
Configuring Auto Power Off Settings .....	(Auto Power Off) . 149
Configuring [📷] and [▶] Settings .....	(REC/PLAY) . 150
Configuring USB Protocol Settings .....	(USB) . 150
Selecting the Screen Aspect Ratio and Video Output System .....	(Video Out) . 151
Configuring a Startup Image .....	(Startup) . 151
Formatting Built-in Memory or a Memory Card .....	(Format) . 152
Resetting the Camera to Factory Defaults .....	(Reset) . 152

## ■ Configuring Monitor Screen Settings 153

---

Turning Display Information On and Off .....	(Info) . 153
Using the On-screen Histogram to Check Exposure .....	(+Histogram) . 153
■ How to Use the Histogram .....	154

## ■ Appendix 155

---

Precautions during Use .....	155
Power Supply .....	162
■ Charging .....	162

■ To replace the battery . . . . .	163
■ Battery Precautions. . . . .	163
■ Using the Camera in another Country . . . . .	164
Using a Memory Card . . . . .	164
■ To replace the memory card . . . . .	164
Computer System Requirements for Bundled Software . . . . .	166
Reset Initial Default Settings . . . . .	167
When things don't go right... . . . .	169
■ Troubleshooting . . . . .	169
■ Display Messages. . . . .	174
Number of Snapshots/Movie Recording Time . . . . .	176
Specifications. . . . .	179



## General Guide

The numbers in parentheses indicate the pages where each item is explained.

### ■ Camera

#### Front

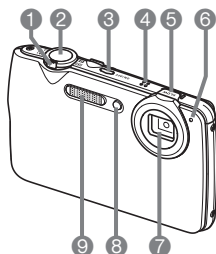

- 1 Zoom controller (pages 24, 44, 100)
- 2 Shutter button (page 24)
- 3 [ON/OFF] (Power) (page 23)
- 4 Speaker
- 5 [SLOW] (Slow Motion View) (page 38)
- 6 Microphone (page 56)
- 7 Lens
- 8 Front lamp (pages 82, 85)
- 9 Flash (page 42)
- 10 Back lamp (pages 23, 25, 42)

#### Back

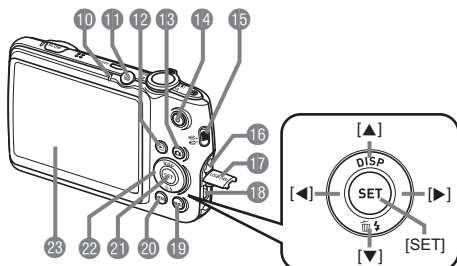

- 11 (Continuous Shutter) (page 47)
- 12 (PLAY) button (pages 23, 28)
- 13 (REC) button (pages 23, 24)
- 14 (Movie) button (page 55)
- 15 Movie mode switch (page 55)
- 16 Strap hole (page 2)
- 17 Terminal cover
- 18 [USB/AV] port (pages 101, 118, 127, 136)
- 19 [BS] button (page 63)
- 20 [MENU] button (page 77)
- 21 [SET] button (page 31)
- 22 Control button ([▲] [▼] [◀] [▶]) (pages 29, 31, 42, 77, 153)
- 23 Monitor screen (pages 11, 153)

## Bottom

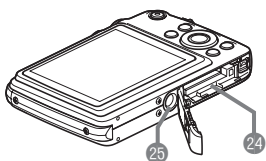

- 24 Battery/memory card slots (pages 17, 163)
- 25 Tripod hole  
Use this hole when attaching to a tripod.

## ■ Charger Unit

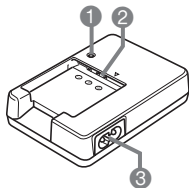

- 1 [CHARGE] Lamp
- 2 + - Contacts
- 3 AC jack

## Monitor Screen Contents

The monitor screen uses various indicators, icons, and values to keep you informed of the camera's status.

- The sample screens in this section are intended to show you the locations of all the indicators and figures that can appear on the monitor screen in various modes. They do not represent screens that actually appear on the camera.

### ■ Snapshot Recording

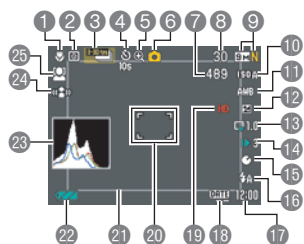

- 1 Focus mode (page 79)
- 2 Metering mode (page 92)
- 3 Continuous Shutter mode (page 47)
- 4 Self-timer mode (page 82)
- 5 Image deterioration indicator (page 45)
- 6 Recording mode (page 24)
- 7 Remaining snapshot memory capacity (pages 50, 73)
- 8 Number of recordable CS images (pages 50, 73)
- 9 Snapshot image size/Quality (pages 32, 91)
- 10 ISO sensitivity (page 35)
- 11 White balance setting (page 35)
- 12 Exposure compensation (page 37)
- 13 Slow Motion View (page 38)
- 14 Slow Motion View Speed (page 38)
- 15 Lag Correction (page 40)
- 16 Flash (page 42)
- 17 Date/Time (page 44)
- 18 Timestamp indicator (page 147)
- 19 Movie quality (HD/STD movie) (pages 55, 57)/ Recording speed (high speed movie) (page 58)
- 20 Focus frame (pages 25, 84)
- 21 Slow Motion View frame (page 38)
- 22 Battery level indicator (page 18)
- 23 Histogram (page 153)
- 24 Anti Shake (page 83)
- 25 Face Detection (page 85)

### NOTE

- The semi-transparent gray frame on the monitor screen indicates the area that is recorded when shooting a movie. The area within the frame is recorded for a movie.

## ■ Movie Recording



- 1 Recording mode (page 55)
- 2 Audio recording disabled (page 58)
- 3 Remaining movie memory capacity (page 177)
- 4 Movie recording time (page 55)
- 5 Movie recording in progress (page 55)
- 6 Movie quality (HD/STD movie) (pages 55, 57)/  
Recording speed (high speed movie) (page 58)

## ■ Snapshot Viewing

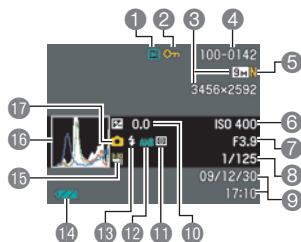

- 1 File type
- 2 Protect indicator (page 111)
- 3 Snapshot image size (page 32)
- 4 Folder name/file name (page 141)
- 5 Snapshot image quality (page 91)
- 6 ISO sensitivity (page 35)
- 7 Aperture value
- 8 Shutter speed
- 9 Date/time (page 148)
- 10 Exposure compensation (page 37)
- 11 Metering mode (page 92)
- 12 White balance setting (page 109)
- 13 Flash (page 42)
- 14 Battery level indicator (page 18)
- 15 Continuous Shutter mode (page 47)
- 16 Histogram (page 153)
- 17 Recording mode (page 24)

## ■ Movie Playback

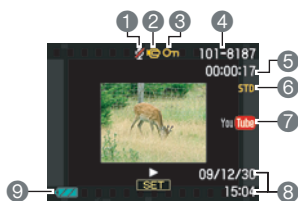

- 1 No audio data available
- 2 File type
- 3 Protect indicator (page 111)
- 4 Folder name/file name (page 141)
- 5 Movie recording time (page 94)
- 6 Movie quality/speed (pages 55, 57, 58)
- 7 YouTube (page 61)
- 8 Date/time (page 148)
- 9 Battery level indicator (page 18)

## ■ CS Image Viewing

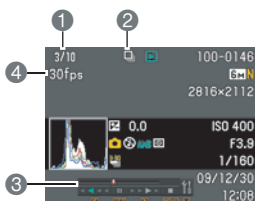

- 1 Current image number/number of images in the group (page 95)
- 2 CS group icon (page 95)
- 3 Playback guide (page 95)
- 4 CS speed (page 95)

# Quick Start Basics

## What is a digital camera?

A digital camera stores images on a memory card, so you can record and delete them a countless number of times.

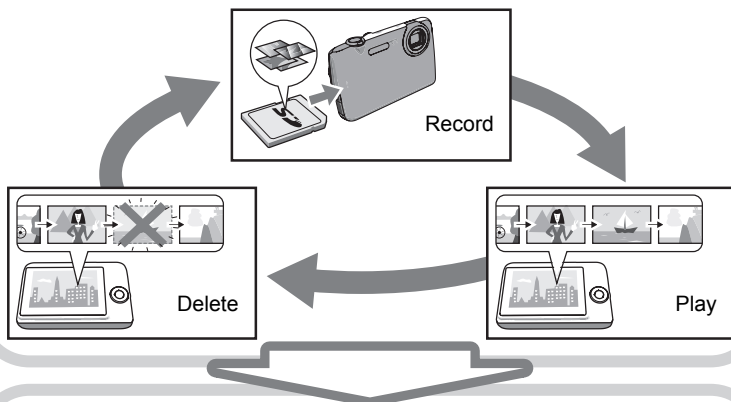

You can use the images you record in a variety of different ways.

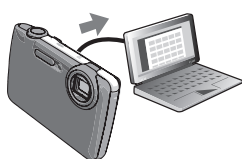

Store images on your computer.

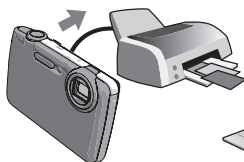

Print images.



Attach images to e-mail.

## What you can do with your CASIO camera

Your CASIO camera is packed with a powerful selection of features and functions to make recording of digital images easier, including the following three main functions.



### High Speed CS/Prerecord CS

Now you can shoot continuous high-resolution images at the amazing speed of 30 images per second. Prerecord CS pre-records images to ensure you are almost never too late with the shutter button.

See page **48** for more information.

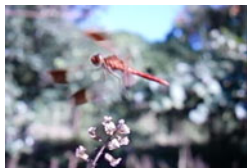

### High Speed Movie

Movies can be recorded at up to 1000 frames per second. This makes it possible to clearly view phenomena that are invisible to the human eye, in slow motion.

See page **58** for more information.



1280×720 pixels

### HD Movie Recording

You can record movies in high-quality HD. (1280×720 pixels 30 fps)

See page **57** for more information.

## First, charge the battery prior to use.

Note that the battery of a newly purchased camera is not charged. Perform the steps under "To charge the battery" to bring the battery to a full charge.

- Your camera requires a special CASIO rechargeable lithium ion battery (NP-60) for power. Never try to use any other type of battery.

### To charge the battery

- 1. Positioning the positive  $\oplus$  and negative  $\ominus$  terminals of the battery with those of the charger unit, load the battery into the charger unit.**

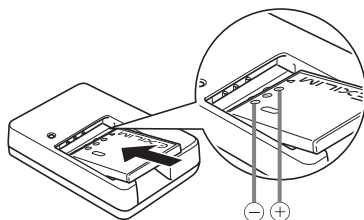

- 2. Plug the charger unit into a household power outlet.**

About 90 minutes are required to reach full charge. The [CHARGE] lamp will go out when charging is complete. Unplug the power cord from the power outlet and then remove the battery from the charger.

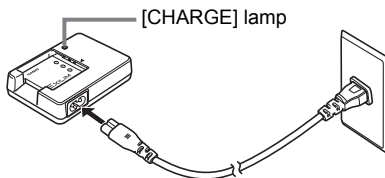

Lamp Status	Description
Lit Red	Charging
Flashing Red	Charger unit or battery problem (page 162)
Off	Charging complete or standing by, due to abnormally high or low ambient temperature (page 162)



## Other Charging Precautions

- Use the special charger (BC-60L) to charge the special lithium ion battery (NP-60). Never use any other type of charger device. Attempting to use a different charger can result in unexpected accident.
- A battery that is still warm due to normal use may not charge fully. Give the battery time to cool before charging it.
- A battery discharges slightly even when it is not loaded in the camera. Because of this, it is recommended that you charge the battery immediately before you need to use it.
- Charging the camera's battery may cause interference with TV and radio reception. If this happens, plug the charger into an outlet that is further away from the TV or radio.
- Actual charging time depends on current battery capacity and charging conditions.

## To load the battery

### 1. Open the battery cover.

Slide the battery cover slider towards OPEN and then open it as indicated by the arrows in the illustration.

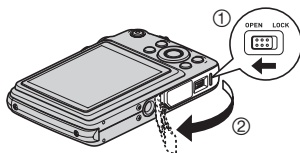

### 2. Load the battery.

With the EXILIM logo on the battery facing upwards (in the direction of the monitor screen), hold the stopper next to the battery in the direction indicated by the arrow as you slide the battery into the camera. Press the battery in until the stopper secures it in place.

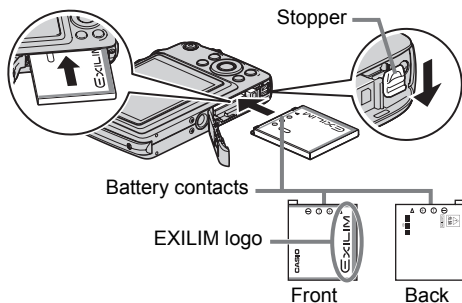

### 3. Close the battery cover.

Close the battery cover and then shift the slider towards LOCK.

- For information about how to replace the battery, see page 163.

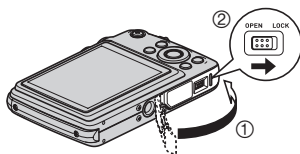

### Checking Remaining Battery Power

As battery power is consumed, a battery indicator on the monitor screen indicates remaining power as shown below.

Remaining Power	High	←	→	Low			
Battery Indicator		→		→		→	
Indicator Color	Cyan	→	Amber	→	Red	→	Red

indicates battery power is low. Charge the battery as soon as possible.

Recording is not possible when is indicated. Charge the battery immediately.

- The level shown by the battery indicator may change when you switch between the REC mode and PLAY mode.
- Leaving the camera for about two days with no power supplied while the battery is dead will cause its date and time settings to be cleared. A message telling you to configure time and date settings will appear the next time you turn on the camera after restoring power. When this happens, configure date and time settings (page 147).
- See page 182 for information about battery life and memory capacity.

### Battery Power Conservation Tips

- When you do not need to use the flash, select (flash off) for the flash setting (page 42).
- Enable the Auto Power Off and the Sleep features to protect against wasting battery power when you forget to turn off the camera (pages 149, 149).
- Select “Off” for “Continuous AF” (page 86).
- Avoid unnecessary optical zoom operations.

## Configuring Basic Settings the First Time You Turn On the Camera

The first time you load a battery into the camera, a screen appears for configuring the display language, date, and time settings. Failure to set the date and time correctly will cause the wrong date and time data to be recorded with images.



### IMPORTANT!

- A screen for language selection will not appear in step 2 of the procedure below if you purchased a camera intended for the Japanese market. To change the display language from Japanese in this case, use the procedure under “Specifying the Display Language (Language)” (page 148). Note that a version of this manual in the language you select may not be included with a camera intended for the Japanese market.

**1. Press [ON/OFF] to turn on the camera.**

**2. Use [▲], [▼], [◀], and [▶] to select the language you want and then press [SET].**

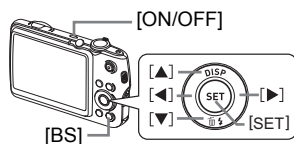

**3. Use [▲] and [▼] to select a date style and then press [SET].**

Example: 30. 12. 09  
YY/MM/DD → 09/12/30  
DD/MM/YY → 30/12/09  
MM/DD/YY → 12/30/09

**4. Set the date and the time.**

Use [◀] and [▶] to select the setting you want to change and then use [▲] and [▼] to change it. To switch between 12-hour and 24-hour format, press [BS].



**5. After setting the date and time, use [◀] and [▶] to select “Apply” and then press [SET].**

If you make a mistake configuring display language, date, or time settings with the above procedure, refer to the following pages for information about how to correct the settings.

- Display language: Page 148
- Date and time: Page 147

## NOTE

- Each country controls its local time offset and the use of summer time, and so they are subject to change.
- Removing the battery from the camera too soon after configuring time and date settings for the first time can cause the settings to be reset to their factory defaults. Do not remove the battery for at least 24 hours after configuring settings.

## Preparing a Memory Card

Though the camera has built-in memory that can be used to store images and movies, you probably will want to purchase a commercially available memory card for greater capacity. The camera does not come with a memory card. Images recorded while a memory card is loaded are saved to the memory card. When no memory card is loaded, images are saved to built-in memory.

- For information about memory card capacities, see page 176.

## Supported Memory Cards

- SD Memory Card
- SDHC Memory Card



Use one of the above types of memory card.

- Use only SD cards that are compliant with the SD Card Association specification.

## Memory Card Handling Precautions

Certain types of cards can slow down processing speeds, and even can make it impossible to store High Quality movies correctly. Also, use of certain types of memory cards slows down data transfer and increases the time it takes to record movie data, which can result in movie frames being dropped. The "● REC" indicator on the monitor screen turns yellow to indicate that frames are being dropped. In order to avoid problems such as these, use of an Ultra High Speed Type SD memory card is recommended. Note, however that CASIO makes no guarantees about the operation of any Ultra High Speed Type SD memory card used with this camera.

## To load a memory card

### 1. Press [ON/OFF] to turn off the camera and then open the battery cover.

Slide the battery cover slider towards OPEN and then open it as indicated by the arrows in the illustration.

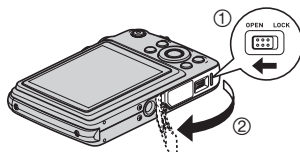

### 2. Load a memory card.

Positioning the memory card so its front is facing upwards (towards the monitor screen side of the camera), slide it into the card slot all the way in until you hear it click securely into place.

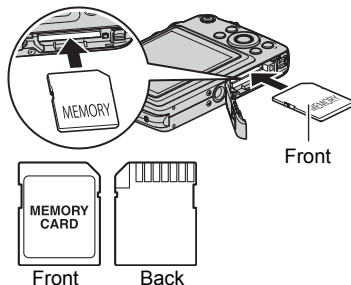

### 3. Close the battery cover.

Close the battery cover and then shift the slider towards LOCK.

- For information about how to replace the memory card, see page 164.

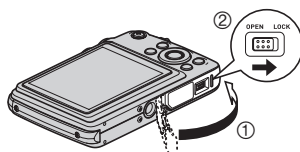

### **IMPORTANT!**

- Never insert anything besides a supported memory card (page 20) into the memory card slot.
- Should water or any foreign object ever get into the card slot, immediately turn off the camera, remove the battery, and contact your retailer or nearest CASIO authorized service center.

## **To format (initialize) a new memory card**

---

You need to format a new memory card before using it for the first time.

- 1. Turn on the camera and press [MENU].**

---

- 2. On the “Set Up” tab, select “Format” and then press [▶].**

---

- 3. Use [▲] and [▼] to select “Format” and then press [SET].**

### **IMPORTANT!**

- Formatting a memory card that already has snapshots or other files on it, will delete its contents. Normally you do not need to format a memory card again. However, if storing to a card has slowed down or if you notice any other abnormality, re-format the card.
- Be sure to use the camera to format a memory card. Formatting a memory card on a computer and then using it in the camera can slow down data processing by the camera. In the case of an SD or SDHC memory card, formatting on a computer can result in non-conformity with the SD format, causing problems with compatibility, operation, etc.
- Before formatting a new Eye-Fi card to use it for the first time, copy the Eye-Fi Manager install files to your computer. Do this before formatting the card.

## Turning the Camera On and Off

### To turn power on

To enter the REC mode, press [ON/OFF] (Power) or [📷] (REC). To enter the PLAY mode, press [▶] (PLAY).

The back lamp will light (green) momentarily and the camera will turn on.

- Pressing [▶] (PLAY) while in the REC mode switches to the PLAY mode.
- The Sleep function or Auto Power Off (pages 149, 149) will turn off power automatically if you do not perform any operation for a preset amount of time.

[ON/OFF] (Power)

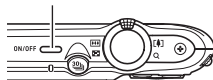

Back lamp

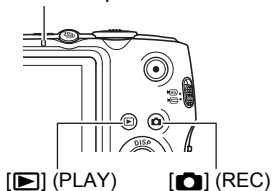

### To turn off the camera

Press [ON/OFF] (Power).

- You can configure the camera so power does not turn on when you press [📷] (REC) or [▶] (PLAY). You also can configure the camera to turn off when you press [📷] (REC) or [▶] (PLAY) (page 150).

## To shoot a snapshot

The following procedure describes how to shoot a single snapshot. For information about shooting a series of shots (Continuous Shutter), see page 47.

### 1. Press **[CAMERA]** (REC) to turn on the camera.

Make sure **[Auto]** (Auto) is on the display. If it isn't, see page 63.

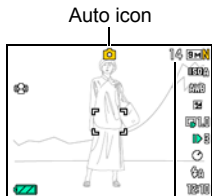

Remaining snapshot memory capacity (page 176)

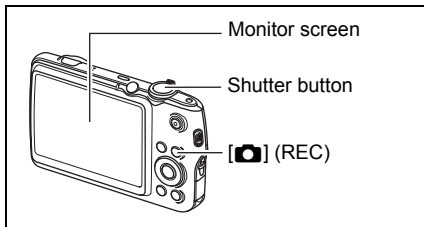

### 2. Point the camera at the subject.

You can zoom the image, if you want.

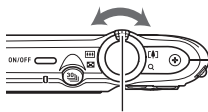

Zoom controller



Wide Angle



Telephoto



### 3. Half-press the shutter button to focus the image.

When focus is complete, the camera will beep, the back lamp will light green, and the focus frame will turn green.

- If the current aperture, shutter speed, ISO sensitivity, or Auto Exposure is not correct, the setting will turn orange when you half-press the shutter button.

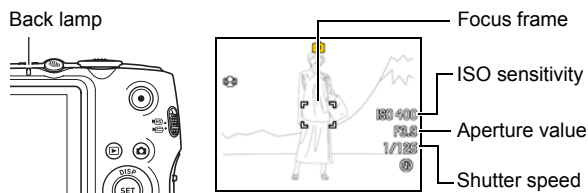

#### Half-press

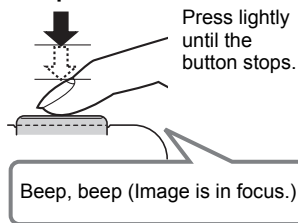

When you half-press the shutter button, the camera automatically adjusts exposure and focuses on the subject it is currently pointed at. Mastering how much pressure is required for a half-press and a full-press of the shutter button is an important technique for good-looking images.

### 4. Continuing to keep the camera still, press the shutter button the rest of the way down.

This records the snapshot.

#### Full-press

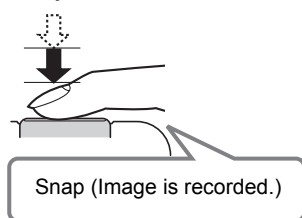

## Shooting a Movie

Press [●] (Movie) to start movie recording. Press [●] (Movie) again to stop movie recording. See the following pages for details.

Standard movie (STD movie): page 55

High-definition movie (HD movie): page 57

High speed movie (HS movie): page 58

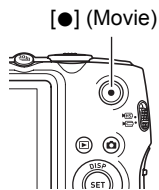

## ■ Using Quick Shutter

Fully pressing the shutter button without waiting for Auto Focus to operate will record using Quick Shutter (page 88).

- With Quick Shutter, the camera focuses faster than normal Auto Focus, which means you can capture quick moving action more easily. Note, however, that some images may be out of focus when Quick Shutter is used.
- Whenever possible, take a little extra time to half-press the shutter button in order to ensure proper focus.

## ■ If the image does not focus...

If the focus frame stays red and the back lamp is flashing green, it means that the image is not in focus (because the subject is too close, etc.) Point the camera at the subject and try to focus again.

## ■ If the subject is not in the center of the frame...

“Focus lock” (page 81) is a technique you can use when you want to shoot an image in which the subject to be focused on is not within the focus frame in the center of the screen.

## Holding the Camera Correctly

Your images will not come out clearly if you move the camera when you press the shutter button. When pressing the shutter button, be sure to hold the camera as shown in the illustration below, and keep it still by pressing your arms firmly against your sides as you shoot.

Holding the camera still, carefully press the shutter button and take care to avoid all movement as the shutter releases and for a few moments after it releases. This is especially important when available lighting is low, which slows down the shutter speed.

### Horizontal



### Vertical

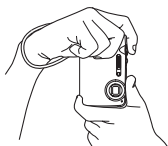

Hold the camera so the flash is above the lens.

### NOTE

- Take care that your fingers and the strap do not cover any of the areas indicated in the illustration.
- To protect against accidentally dropping the camera, attach the wrist strap and make sure it is around your fingers or wrist while you are operating the camera.
- Never swing the camera around by its strap.
- The supplied strap is intended for use with this camera only. Never use it for any other purpose.

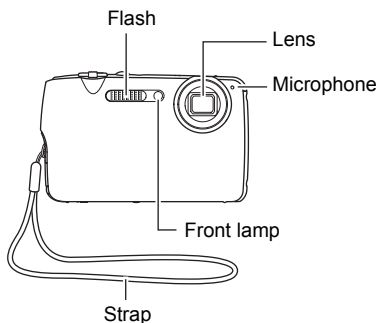



## Deleting Images

If memory becomes full, you can delete images you no longer need in order to free up storage and record more images.



### IMPORTANT!

- Remember that a file (image) delete operation cannot be undone.
- For information about images recorded using continuous shutter (CS), see page 97.

### To delete a single file

1. Press [▶] (PLAY) to enter the PLAY mode and then press [▼] (🗑️ ⚡).



2. Use [◀] and [▶] to scroll through the files until the one you want to delete is displayed.

3. Use [▲] and [▼] to select "Delete" and then press [SET].

- To delete other files, repeat steps 2 and 3.
- To exit the delete operation, press [MENU].
- If a CS group (page 95) is displayed when you perform the above procedure, all of the images in the currently display CS group will be deleted.

### To delete all files

1. Press [▶] (PLAY) to enter the PLAY mode and then press [▼] (🗑️ ⚡).

2. Use [▲] and [▼] to select "Delete All Files" and then press [SET].

3. Use [▲] and [▼] to select "Yes" and then press [SET] to delete all files. This will cause the message "There are no files" to appear.

## Snapshot Shooting Precautions

### Operation

- Never open the battery cover while the back lamp is flashing green. Doing so can result in the image you just shot being saved incorrectly, damage to other images stored in memory, malfunction of the camera, etc.
- If unwanted light is shining directly onto the lens, shade the lens with your hand.

### Monitor Screen when Shooting Snapshots

- Subject brightness conditions can cause monitor screen response to slow and can cause digital noise in the monitor screen image.
- The image that appears on the monitor screen is for image composition. The actual image will be recorded at the quality set for the image quality setting (page 91).

### Shooting Indoors under Fluorescent Lighting

- Minute flickering of fluorescent lighting can affect the brightness or color of an image.

### Other Precautions

- Due to the characteristics of the camera's semiconductor, slow shutter speeds can cause digital noise in images. The camera performs an automatic noise reduction process whenever the shutter speed is 1 second or slower. Storage of images shot at slower shutter speeds takes longer because of the time required for noise reduction. Do not perform any key operation while the image storage operation is in progress.
- Due to the characteristics of the imaging element used by the camera, very fast moving objects in an image may appear distorted.

## Auto Focus Restrictions

- Any of the following can make proper focus impossible.
  - Solid color wall or other very low contrast subject
  - Strongly back lit subject
  - Very shiny subject
  - Blinds or other subject with a repeating horizontal pattern
  - Multiple subjects at varying distances from the camera
  - Subject in a dark location
  - Subject that is too far away for light from the AF assist lamp to reach
  - Camera movement while shooting
  - Fast-moving subject
  - Subjects outside the focus range of the camera
- If you cannot focus properly, try using focus lock (page 81) or Manual Focus (page 79).

## Using the Control Panel

The control panel can be used to configure camera settings.

**1. In the REC mode, press [SET].**

**2. Use [▲] and [▼] to select the setting you want to change.**

This will select one of the control panel icons and display its settings.

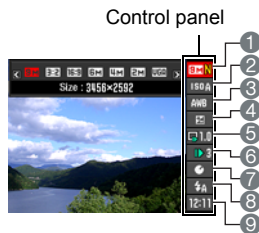
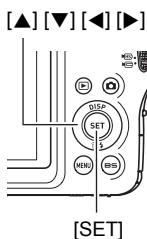

- 1 Image size/Quality\*1 (pages 32, 91)
- 2 ISO sensitivity (page 35)
- 3 White balance (page 35)
- 4 EV shift (page 37)
- 5 Slow Motion View (page 38)\*2
- 6 Slow Motion View Speed (page 39)\*2
- 7 Lag Correction (page 40)\*2
- 8 Flash (page 42)\*2
- 9 Date/Time (page 44)

\*1 Image quality cannot be changed using the control panel.

\*2 Items displayed in the control panel depend on the recording mode.

**3. Use [◀] and [▶] to change the setting.**

**4. If you want to configure another setting, repeat steps 2 and 3.**

**5. After all of the settings are the way you want, press [SET].**

This will apply the settings and return to the REC mode.

### NOTE

- You also can use on-screen menus to configure settings other than those listed above (page 77).

## Changing the Image Size (Size)

### ■ Pixels

A digital camera image is a collection of small dots called "pixels". The more pixels there are in an image, the more detail there will be. However, you generally can do with fewer pixels when printing an image (L size) through a print service, attaching an image to e-mail, when viewing the image on a computer, etc.

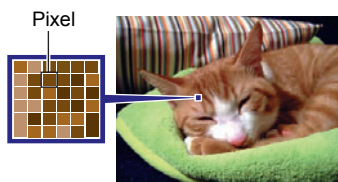

### ■ About image sizes

The size of an image indicates how many pixels it contains, and is expressed as horizontal pixels  $\times$  vertical pixels.

9M (3456 $\times$ 2592) size image =  
Approximately 9 million pixels

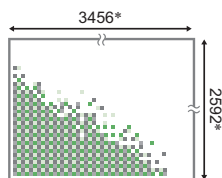

VGA (640 $\times$ 480) size image =  
Approximately 300,000 pixels

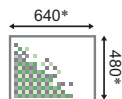



\* Unit: pixels



## Image Size Selection Tips

Note that larger images have more pixels, so they take up more memory space.

<b>Large Number of Pixels</b>	More detail, but takes up more memory. Best when you plan to print large-size prints (such as A3 size).	
<b>Small Number of Pixels</b>	Less detail, but takes up less memory. Best when you want to send images by e-mail, etc.	

- For information about image size, image quality, and number of images that can be stored, see page 176.
- For information about movie image size, see page 91.
- For information about resizing existing snapshots, see page 114.

### ■ To select the image size

**1. In the REC mode, press [SET].**

---

**2. Use [▲] and [▼] to select the top control panel option (Image Size).**

---

**3. Use [◀] and [▶] to select an image size and then press [SET].**

Image Size (Pixels)	Suggested Print Size and Application	Description
9M (3456×2592)	A3 Print	Good detail for better clarity even for images cropped (page 115) from the original
3:2 (3456×2304)	A3 Print	
16:9 (3456×1944)	HDTV	
6M (2816×2112)	A3 Print	Good detail
4M (2304×1728)	A4 Print	
2M (1600×1200)	3.5"×5" Print	Best when preserving memory capacity is relatively more important than image quality.
VGA (640×480)	E Mail	Image files are smaller, which is better when attaching images to e-mail. However, images are relatively coarser.

- The initial factory default image size setting is 9M (9 million pixels).
- Selecting "3:2" records images with an aspect ratio of 3:2, which matches the standard aspect ratio of print paper.
- The letters "HDTV" stand for "High Definition Television". An HDTV screen has an aspect ratio of 16:9, which makes them wider than the usual 4:3 aspect ratio of television screens of the past. Your camera can record images that are compatible with the aspect ratio an HDTV screen.
- You should regard the print paper sizes suggested here as guidelines only (200 dpi print resolution).
- Available image sizes are limited for some functions as noted below.

These sizes	Cannot be selected when using
9M, 3:2, 16:9	Slow Motion View, Lag Correction, High Speed CS, some BEST SHOT scenes*

\* Applicable BEST SHOT scenes: "Move In CS", "Move Out CS", "High Speed Anti Shake", "High Speed Night Scene", "Multi-motion Image", "High Speed Best Selection"

## Specifying ISO Sensitivity (ISO)

ISO sensitivity is a measure of sensitivity to light.

1. In the REC mode, press [SET].
2. Use [▲] and [▼] to select the second control panel option from the top (ISO Sensitivity).
3. Use [◀] and [▶] to select the setting you want and then press [SET].

<b>AUTO</b>	Adjusts sensitivity automatically according to conditions		
<b>ISO 100</b>	Lower sensitivity	Slow shutter speed	Less noise
<b>ISO 200</b>	↑ ↓	↑ ↓	↑ ↓
<b>ISO 400</b>			
<b>ISO 800</b>	Higher sensitivity	Fast shutter speed (Set for shooting in dimly lit areas.)	Some coarseness (increased digital noise)
<b>ISO 1600</b>			

- "AUTO" ISO sensitivity always is applied for movies, regardless of the current ISO sensitivity setting.
- Higher ISO sensitivity values tend to result in digital noise in images.

## Adjusting White Balance (White Balance)

You can adjust white balance to match the source of light available where you are shooting and avoid the blue cast that results when shooting outdoors when it is cloudy, and the green cast that results when shooting under fluorescent lighting.

1. In the REC mode, press [SET].
2. Use [▲] and [▼] to select the third control panel option from the top (White Balance).

3. Use [◀] and [▶] to select the shooting condition you want and then press [SET].

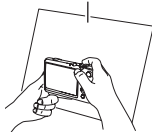
<b>AWB Auto WB</b>	Configures the camera to adjust white balance automatically
<b>☀ Daylight</b>	For shooting outdoors on a clear day
<b>☁ Overcast</b>	For shooting outdoors on an overcast rainy day, in the shade, etc.
<b>🌲 Shade</b>	For shooting on a clear day in the shade of trees or buildings
<b>☀N Day White Fluorescent</b>	For shooting under white or day white fluorescent lighting
<b>☀D Daylight Fluorescent</b>	For shooting under daylight fluorescent lighting
<b>💡 Tungsten</b>	For shooting under light bulb lighting
<b>MWB Manual WB</b>	<p>For configuring the camera manually to suit a particular light source.</p> <ol style="list-style-type: none"> <li>① Select “<b>MWB Manual WB</b>”.</li> <li>② Under the lighting conditions you plan to use when shooting, point the camera at a blank white piece of paper so it fills the entire monitor screen and then press the shutter button.</li> <li>③ Press [SET].</li> </ol> <p>The white balance setting is retained even if you turn off the camera.</p> <div style="text-align: right;"> <p>Blank white paper</p>  </div>

- When “**AWB Auto WB**” is selected for the white balance setting, the camera automatically determines the white point of the subject. Certain subject colors and light source conditions can cause problems when the camera tries to determine the white point, which makes proper white balance adjustment impossible. If this happens, select the white balance setting that matches your shooting conditions (Daylight, Overcast, etc.)

## Correcting Image Brightness (EV Shift)

You can manually adjust an image's exposure value (EV value) before shooting it.

- Exposure Compensation Range:  $-2.0\text{EV}$  to  $+2.0\text{EV}$
- Unit:  $1/3\text{EV}$

**1. In the REC mode, press [SET].**

**2. Use [▲] and [▼] to select the fourth control panel option from the top (EV Shift).**

**3. Use [◀] and [▶] to adjust the exposure compensation value.**

[▶]: Increases the EV value. A higher EV value is best for light-colored subjects and backlit subjects.

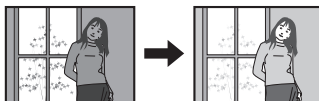

[◀]: Decreases the EV value. A lower EV value is best for dark-color subjects and for shooting outdoors on a clear day.



To cancel exposure compensation, change the EV value to 0.0.



Exposure compensation value

**4. Press [SET].**

This applies the exposure compensation value. The exposure compensation value you set remains in effect until you change it.

### NOTE

- When shooting under very dark or very bright conditions, you may not be able to obtain satisfactory results even after performing exposure compensation.

## Shooting with Slow Motion View

When you press [SLOW] (Slow Motion View), the camera will start to pre-record images continually in a buffer and play them back at slow speed. Up to three seconds worth of pre-recorded images are in the buffer. Fully pressing the shutter button will save the currently displayed pre-recorded image. You can specify one of eight playback speeds for pre-recorded images.

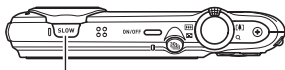

[SLOW] (Slow Motion View)

### ■ To get ready to shoot with Slow Motion View

1. In the REC mode, press [SET].

2. Use [▲] and [▼] to select the fifth control panel option from the top (Slow Motion View).



3. Use [◀] and [▶] to select the Slow Motion View pre-record time (buffer size).

You can select 1 second (30 fps), 2 seconds (15 fps), or 3 seconds (10 fps).

When you press [SLOW] (page 39), the images that are recorded in accordance with the time (and CS fps) you specify here are displayed on the monitor screen in slow motion.

\* fps (frames per second) is a unit of measurement indicating the number of images recorded or played back per second.

4. Use [▲] and [▼] to select the fourth control panel option from the bottom (Slow Motion View Speed).

5. Use [◀] and [▶] to select the Slow Motion View playback speed you want and then press [SET].



You can select one of eight speeds, from 1 to 8. A higher level number specifies a faster playback speed.

## ■ To shoot with Slow Motion View

### 1. Point the camera at the subject.

### 2. Press [SLOW] (Slow Motion View).

This will start slow motion playback of pre-recorded images on the monitor screen.

- You can use [◀] and [▶] to change the playback speed while Slow Motion View playback is in progress.

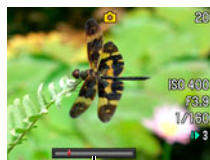

Playback speed bar

### 3. When the pre-recorded image you want to save is displayed, press the shutter button.

This will store the displayed image as a snapshot and exit Show Motion View. To exit Slow Motion View without saving any image, press [SLOW].

## NOTE

- Press [SLOW] before the instance you want to shoot occurs.
- After pressing [SLOW], be sure to keep the camera pointed at the subject for at least the duration that is specified by the Slow Motion View pre-record time (buffer size) setting.
- After you press [SLOW], the slow motion image playback will continue on the screen until you press the shutter button to store one of the images. To stop slow motion playback without saving any one of the images, press [SLOW] again.
- Focus and exposure settings remain fixed at what they were when you pressed [SLOW].
- For focusing during a Slow Motion View operation, it is recommended that you half-press the shutter button to focus before you press [SLOW] (it is not necessary to keep the shutter button half-pressed after focus is achieved), or that you change the “Continuous AF” setting to “On”.
- When “On” is selected for the “Continuous AF” setting, it will take slightly longer for slow motion playback of the pre-recorded images to start after you press [SLOW].
- If the camera’s image size setting is 9M, 3:2, or 16:9 when you shoot a Slow Motion View image, the size of the resulting image will be 6M.
- The shooting range of Slow Motion View is narrower than that of a Single Shot mode image.
- Switching to Slow Motion View causes the flash setting to become  (flash off) automatically.

## Using Lag Correction (Lag Correction)

The Lag Correction function lets you correct for the lag time from the point you decide to shoot until the point it takes for the shutter to actually release. This feature actually does not speed up shutter release, but instead it pre-records images when you half-press the shutter button and saves what occurred slightly before you press the shutter button.

**1. In the REC mode, press [SET].**

**2. Use [▲] and [▼] to select the third control panel option from the bottom (Lag Correction).**



**3. Use [◀] and [▶] to select the lag correction time you want and then press [SET].**

You can select a correction time of “-0.1”, “-0.2”, or “-0.3” seconds. Select “Off” to disable lag correction.

**4. Half-press the shutter button.**

This starts pre-recording in accordance with the correction time you selected in step 3.

**5. When you want to record, press the shutter button the rest of the way down.**

This records the image currently in the buffer.



## NOTE

---





- Lag Correction will not be performed if you press the shutter button all the way without first pressing it half way.
- If the camera's image size setting is 9M, 3:2, or 16:9 when you shoot with Lag Correction, the size of the resulting image will be 6M.
- The shooting range of Lag Correction is narrower than that of the Single Shot mode.
- The lag correction time you should select depends on a variety of factors. The lag from the point when you decide to shoot to the point when the shutter actually releases depend on the individual photographer and on shooting conditions. Experiment with different settings until you find the one that suits you best.
- Failure to pay proper attention to the subject when shooting can increase the lag time considerably.
- Note the following when selecting a lag correction time.
  - If you are viewing the subject with the monitor screen, try selecting “-0.2” as the lag correction time. If you are looking directly at the subject, try “-0.1”.
  - If timing is off with the above settings, try changing the lag correction time to “-0.3” when using the monitor screen and “-0.2” when looking directly at the subject.
- Using Lag Correction causes the flash setting to become  (flash off) automatically.

## Using Flash (Flash)

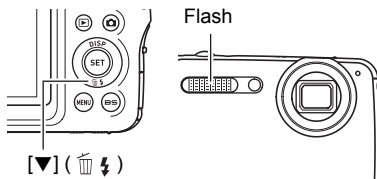
1. In the REC mode, press [▼] (  ) once.

2. Use [◀] and [▶] to select the flash setting you want and then press [SET].



 <b>Auto Flash</b>	Flash fires automatically in accordance with exposure (amount of light and brightness) conditions.
 <b>Flash Off</b>	Flash does not fire.
 <b>Flash On</b>	Flash always fires. This setting can be used to brighten a subject that normally comes out dark due to daylight or backlight (daylight synchro flash).
 <b>Red Eye Reduction</b>	Flash fires automatically. This type of flash can be used to reduce the chance of redness in the subject's eyes.

3. Press the shutter button to shoot.



### Back lamp

Flashes red while the flash is charging to indicate that image recording is disabled.

- You will not be able to take another flash snapshot until the lamp stops flashing red, which indicates that charging is complete.

 indicates the flash will fire.

- For information about Flash Range, see page 180.

## NOTE

---

- Take care so your fingers and the strap do not block the flash.
- The desired effect may not be obtained when the subject is too far away or too close.
- Flash charging time (page 180) depends on operating conditions (battery condition, ambient temperature, etc.).
- Shooting with flash turned off when lighting is dim results in a slow shutter speed, which can cause image blur due to camera movement. Under such conditions, secure the camera with a tripod, etc.
- With red eye reduction, the flash is fired automatically in accordance with exposure. It does not fire in areas where lighting is bright.
- The presence of outdoor sunlight, fluorescent lighting, or some other light source can cause abnormal image colors.
- Select  (flash off) for the flash setting when shooting in areas where flash photography is prohibited.

### Red-eye Reduction

Using the flash to shoot at night or in a dimly lit room can cause red spots inside the eyes of people who are in the image. This is caused when the light from the flash reflects off of the retina of the eye. When red-eye reduction is selected as the flash mode, the camera fires a pre-flash to cause the irises in the eyes of any people in the image to close, which reduces the chance of red eye.

Note the following important points when using red-eye reduction.

- Red-eye reduction does not work unless the people in the image are looking directly at the camera (flash).
- Red-eye reduction may not work very well if the subjects are located far away from the camera.

### Other Useful Flash Features

- Changing the flash intensity (page 93)

## Changing the Control Panel Date/Time Style

1. In the REC mode, press [SET].
2. Use [▲] and [▼] to select the bottom control panel option (Date/Time).  
You can use [◀] and [▶] to select date or time display.

### NOTE

- You can select either of two display styles (page 148) for the date: Month/Day or Day/Month.
- The time is displayed using 24-hour format.

## Shooting with Zoom

Your camera provides you with 3X optical zoom (that changes the lens focal distance), which can be used in combination with digital zoom (that digitally processes the center portion of the image to enlarge it) for total zoom capabilities of 3X to 47.8X. The image deterioration point depends on the image size (page 45).

1. In the REC mode, slide the zoom controller to zoom.



 Wide Angle



 Telephoto

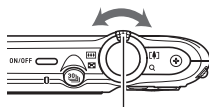

Zoom controller

 (Wide Angle): Reduces the size of the subject and broadens the range

 (Telephoto) : Enlarges the subject and narrows the range

2. Press the shutter button to shoot the image.

## NOTE

- The higher the digital zoom factor, the coarser the recorded image. Note that the camera also has a function that lets you record using digital zoom without image deterioration (page 46).
- Use of a tripod is recommended to protect against image blur due to camera movement when shooting with telephoto.
- Performing a zoom operation changes the lens aperture.
- Both optical zoom and digital zoom are disabled during high speed movie recording.

## Optical Zoom/Digital Zoom Switch Point

If you hold the zoom controller towards **[T]** (Telephoto), the zoom operation will stop when the optical zoom factor reaches its maximum. Momentarily releasing the zoom controller and then holding it again towards **[T]** (Telephoto) will switch to digital zoom, which you can use to set an even higher zoom factor.

- If you do want to use digital zoom, change the "Digital Zoom" setting to "On" (page 87).
- During zoom, a zoom bar on the monitor screen shows the current zoom setting.

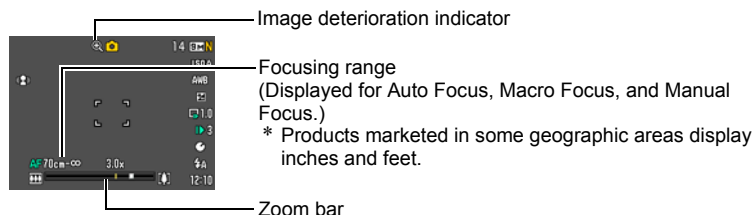

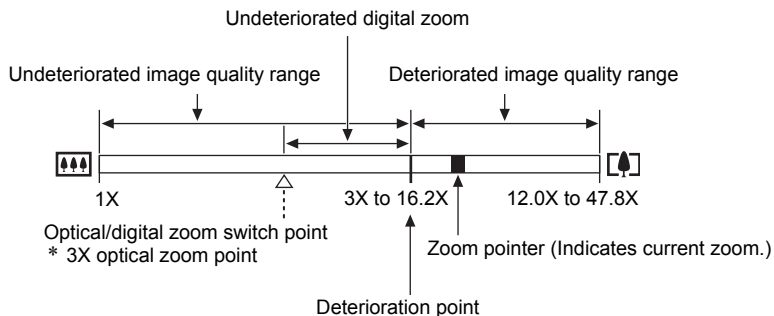

- The deterioration point depends on the current image size setting (page 32). The smaller the image size setting, the higher the zoom factor you can use before reaching the image deterioration point.
- Though digital zoom generally causes a deterioration of image quality, some digital zoom without image deterioration is possible with image sizes of "6M" and smaller. The range in which you can use digital zoom without image deterioration is indicated on the display. The deterioration point depends on the image size.
- When "HD/STD" is selected as the movie mode, minimal deterioration up to a zoom factor of 16.2X is possible only for STD shooting.

Image Size	Maximum Zoom Factor	Deterioration Point
9M	12X	3X
3:2	12X	3X
16:9	12X	3X
6M	14.7X	3.7X
4M	18X	4.5X
2M	25.9X	6.5X
VGA	47.8X	16.2X

## Using Continuous Shutter

Pressing  (Continuous Shutter) toggles between the Continuous Shutter mode and the Single Shot mode (page 24).

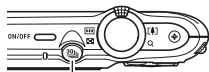



 (Continuous Shutter)

## Using Normal-speed Continuous Shutter

With normal-speed continuous shutter (Normal Speed CS) you can shoot a series of images at a speed of approximately one image per second as long as there is memory available for image storage.

1. In the REC mode, press [MENU].
2. Use [◀] and [▶] to select the “REC” tab.
3. Use [▲] and [▼] to select “CS” and then press [▶].
4. Use [▲] and [▼] to select “Normal Speed CS”, and then press [SET].

### 5. Press (Continuous Shutter).

- This will display  (Normal Speed CS) and surround the monitor screen with a yellow frame. If this does not happen, press  again.

Normal Speed CS icon



Yellow frame

### 6. Hold down the shutter button to shoot.

Images continue to be shot as long as you keep the shutter button depressed and there is memory available to store them. Releasing the shutter button stops shooting.



### IMPORTANT!

- Combining Normal Speed CS images into a CS group (page 95) manually on the playback screen is not supported.
- You cannot specify the number of images shot per second (fps) with Normal Speed CS.
- The number of images per second (fps) of Normal Speed CS varies slightly depending on the type of memory card you are using and its current condition (remaining capacity, fragmentation state, etc.)
- You cannot use Normal Speed CS in combination with Prerecord CS.

## Using High Speed CS and Prerecord CS

With High Speed CS, you can configure the camera to shoot at a speed of 3, 5, 10, 15, or 30 images per second, as long as you keep the shutter button and there is memory available to store the images. With Prerecord CS, half-pressing the shutter button starts continual pre-recording of images to a temporary buffer. Then when you press the shutter button the rest of the way down, the camera stores what is currently in the buffer and starts real-time continuous shutter recording of new images. Real-time recording continues until you release the shutter button or until a total of up to 30 images (buffer images plus new images) are recorded. You can configure Prerecord CS to specify how many of the 30 images are recorded in the buffer and how many are recorded after you fully press the shutter button. Use Prerecord CS when you want to make sure you do not miss fast-moving action.

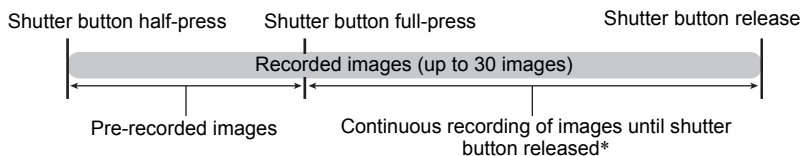

\* You can record up to 30 images (pre-recorded buffer images plus real-time images) for each Prerecord CS operation.

- You can specify 5, 10, 20, or 30 as the maximum number of shots for each continuous shutter operation.
- You can specify anywhere from one second up to 30 seconds as the continuous shutter shooting time, which is the amount of time of the pre-record buffer plus the amount of time that continuous shutter recording is performed after the shutter button is pressed all the way. The maximum shooting time depends on the selected CS speed. You can select a CS speed in the range of 3 to 30 fps.

<b>30 images per second (30 fps)</b>	You can shoot up to 30 images in one second.
<b>3 images per second (3 fps)</b>	You can shoot up to 30 images over 10 seconds.



- You can configure the mode so up to 25 images are pre-recorded to the buffer until you fully press the shutter button.
- The minimum number of pre-recorded buffer images you can specify is three. Total recording time depends on the current continuous shutter frames-per-second (fps) setting.
- Specifying zero for the number of pre-recorded images disables Pre-record CS and performs High Speed CS only (without pre-recording).



**1. In the REC mode, press [MENU].**

**2. Use [◀] and [▶] to select the “REC” tab.**

**3. Use [▲] and [▼] to select “CS” and then press [▶].**

**4. Use [▲] and [▼] to select “High Speed CS”, and then press [SET].**

**5. Press  (Continuous Shutter).**

- This will display  (High Speed CS) and surround the monitor screen with a yellow frame. If this does not happen, press  again.

High Speed CS icon



Yellow frame

**6. Press [SET].**

**7. Use [▲] and [▼] to select the fifth control panel option from the top (High-speed CS fps).**

**8. Use [◀] and [▶] to select the continuous shutter (CS) speed you want and then press [SET].**

CS speed



<b>AUTO</b>	The camera determines the CS speed by determining the surrounding light level and automatically configuring a speed that prevents underexposure.
<b>3 to 30 fps</b>	Enables specification of the number of CS images recorded per second.

\* fps (frames per second) is a unit of measurement indicating the number of images recorded or played back per second.

9. Use [▲] and [▼] to select the sixth control panel option from the top (Max CS shots).



10. Use [◀] and [▶] to select the maximum number of shots for each continuous shutter operation and then press [SET].

11. Use [▲] and [▼] to select the seventh control panel option from the top (Prerecord CS shots).

12. Use [◀] and [▶] to specify how many of the 30 images and for how long images should be pre-recorded in the buffer.

- Prerecord CS shooting is not performed when the number of buffer images and the recording time are both zero.

Shutter button full-press

Number of pre-record images and pre-record time (Not displayed when "AUTO" is selected for "High-speed CS fps".)

Number of remaining images and remaining recording time after the shutter button full-press (Not displayed when "AUTO" is selected for "High-speed CS fps".)

A camera control panel with various icons and settings. The 'Prerecord CS shots' option is highlighted in the center. A line points from the text 'Shutter button full-press' to the shutter button icon. Another line points from the text 'Number of pre-record images and pre-record time...' to the '30' value. A third line points from the text 'Number of remaining images and remaining recording time...' to the '25' value.

13. Press [SET].

- The approximate number of recordable CS images will appear on the monitor screen.

Number of recordable CS images (If you are not performing Prerecord CS, the allowable continuous shutter time also is displayed.)



Remaining snapshot memory capacity

---

#### **14. Half-press the shutter button.**

This will cause the camera to start pre-recording images.

- The camera will not emit a shutter sound when you half-press the shutter button while Prerecord CS is selected.

---

#### **15. When you are ready to shoot, press the shutter button the rest of the way down.**

This will record the images in the pre-record buffer and start recording new images in real-time. Images continue to be shot as long as you keep the shutter button depressed.

---

#### **16. Real-time shooting will stop when you release the shutter button or after the maximum number of shots is reached.**

---

#### **17. Save the CS images (page 52).**

#### **NOTE**

- Note the following when selecting a High Speed CS speed (fps) setting.
  - Use a higher High Speed CS speed (fps) setting when shooting a fast-moving subject.
  - Use a slower High Speed CS speed (fps) setting when shooting a slower-moving subject.
- Note the following when selecting a High Speed CS maximum number of shots setting.
  - The greater the number of shots, the longer it takes to save them after shooting is complete.
- Note the following when specifying a Prerecord CS shots setting.
  - A setting that results in a Prerecord CS operation that takes at least 0.3 seconds is recommended because there is a minimal lag from about 0.1 seconds to 0.3 seconds between the point you decide to shoot and the point that the shutter button is fully depressed.

## Specifying the Method for Saving Continuous Shutter Images

Use the procedure below to specify how images should be saved after a High Speed CS operation.

1. In the REC mode, press [MENU].
2. Use [◀] and [▶] to select “REC” tab.
3. Use [▲] and [▼] to select “Save CS Images”, and then press [▶].
4. Use [▲] and [▼] to change the setting.

### Normal (Batch)

All images that were shot are saved after the continuous shutter operation is finished.

## Select & Save

After continuous shutter shooting is finished, the shot images are played back at slow speed so you can select the images you want to save.

- When shooting with Prerecord CS, the first image saved when you press the shutter all the way is indicated by an “S” mark so you can tell where the continuous shutter operation started.

- ① While the shot images are playing back and an image appears that you want to save, press the shutter button. Each image that you select by pressing the shutter button will have a mark appended to it.
- ② After selecting all of the images you want to save, press [MENU].



### Buttons Used for Image Selection

[◀] [▶]	During playback, these buttons change the playback direction and playback speed. While playback is paused, these buttons scroll forward or back.
[SET]	Toggles between pause and play.
Shutter button	Press all the way down to select an image for saving.
[MENU]	Saves the selected images and exits the image select operation.

- ③ Use [▲] and [▼] to select the save method you want and then press [SET].  
Save All : Saves all the images.  
Save Selected: Saves selected images.  
Back : Returns to image selection.  
Cancel Save : Does not save any of the images.

## Always Ask

After continuous shutter shooting is finished, a prompt appears allowing you to select Normal (Batch) or Select & Save.

Select the save method you want to use and then press [SET].

Save Selected: Saves selected images.

Save All : Saves all the images.

Cancel Save : Does not save any of the images.

## 5. Press [SET] to apply the setting.

## Continuous Shutter Precautions

- If there is not enough available capacity on the memory card, you may not be able to record the number of CS images indicated on the monitor screen. Make sure your memory card has sufficient remaining capacity before shooting with using continuous shutter.
- With continuous shutter, exposure and focus for the first image are applied for successive images as well.
- When using a continuous shutter mode, keep the camera still until shooting is finished.
- In the Continuous Shutter mode, the flash setting automatically becomes  (flash off).
- Zoom is disabled during continuous shutter operations.
- 9M, 3:2, or 16:9 cannot be selected as the image size while High Speed CS is being used. If you enter the High Speed CS mode while one of these image sizes is selected, the camera will record 6M size images.
- The maximum number of images that can be recorded during each High Speed CS session is limited, regardless of how much memory card storage capacity is available.

 <b>High Speed CS</b>	Specified maximum number of continuous shutter shots (Max CS shots)
--	--

The number of images will be restricted even further or shooting may be impossible when remaining memory card capacity is less than the allowable number of images for a particular CS mode.

- The Triple Self-time cannot be used in the High Speed CS mode.
- The Self-timer cannot be used in the Prerecord CS mode.

# Recording Movies

## To record a movie

The following procedure explains how to record a standard (STD) movie.

See the pages indicated below for more information about movies.

High-definition movie (HD movie): page 57

High speed movie (HS movie): page 58

1. In the REC mode, set the movie mode switch to  (HD/STD).

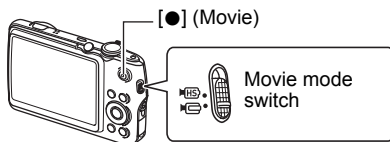

2. Press [MENU].

3. Use [◀] and [▶] to select the “Quality” tab.

4. Use [▲] and [▼] to select “ Quality” and then press [▶].

5. Use [▲] and [▼] to select “STD” (Standard), and then press [SET].

- Recording is performed with an aspect ratio of 4:3, an image size of 640×480 pixels, and a frame rate of 30 frames per second (STD Movie). Image size setting cannot be changed.
- The semi-transparent gray frame on the monitor screen indicates the area that is recorded when shooting a movie. The area within the frame is recorded for a movie.



Semi-transparent gray frame

6. Press [●] (Movie).

This will start recording and display  on the monitor screen.

Movie recording includes monaural audio.

Remaining recording time  
(page 177)

7. Press [●] again to stop recording.

- Each movie can be up to 10 minutes long. Movie recording stops automatically after 10 minutes of recording. Movie recording also will stop automatically if memory becomes full before you stop movie recording by pressing [●] again.

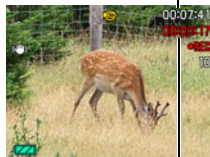

Recording time

## Shooting with BEST SHOT

With BEST SHOT (page 63), you can select the sample scene that matches the type of movie you are trying to shoot and the camera will change its setup accordingly, for beautiful movies every time. Selecting the “Natural Green” BEST SHOT scene, for example, will shot images with vivid green trees and grass.

## Minimizing the Effects of Camera Movement during Movie Recording

You can configure the camera to minimize the effects of camera movement during HD and STD movie recording (page 83). Note, however, that this does not prevent image blur due to subject movement.

## Audio

Your camera has a built-in microphone that can be used to record audio (monaural) during movie recording.

### ■ Recording Precautions

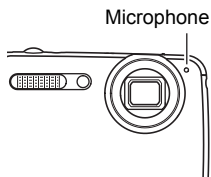

The camera also records audio. Note the following points when shooting a movie.

- Take care that the microphone is not blocked by your fingers, etc.
- Good audio recording results are not possible when the camera is too far away from what you are trying to record.
- Operating camera buttons while shooting can cause button noise to be picked up in the audio.
- Audio recording cannot be performed while “HS” is selected as the movie mode.







## NOTE

- Spending a long time using movie recording will cause the camera to become slightly warm to the touch. This is normal and does not indicate malfunction.
- Use of certain types of memory cards slows down data transfer and increases the time it takes to record movie data, which can result in movie frames being dropped. The “● REC” indicator on the monitor screen turns yellow to indicate that frames are being dropped. In order to avoid problems such as these, use of an Ultra High Speed Type SD memory card is recommended. Note, however that CASIO makes no guarantees about the operation of any Ultra High Speed Type SD memory card used with this camera.
- The effects of camera movement in an image become more pronounced when you shoot close up or with a large zoom factor. Because of this, use of a tripod is recommended under these conditions.
- Face Detection is disabled during movie recording.
- When “ AF Auto Focus” or “ Macro” is selected for the “Focus” setting, Continuous AF is performed during HD and STD movie recording, regardless of the current “Continuous AF” setting (page 86).

## Recording a High-definition Movie

This camera supports recording of high-definition (HD) movies. The aspect ratio of an HD movie is 16:9, the image size is 1280×720 pixels, and the frame rate is 30 fps. Image quality and image size settings cannot be changed.

1. In the REC mode, set the movie mode switch to  (HD/STD).
2. Press [MENU].
3. Use [◀] and [▶] to select the “Quality” tab.
4. Use [▲] and [▼] to select “ Quality” and then press [▶].
5. Use [▲] and [▼] to select “HD”, and then press [SET].
6. Record the movie the same way as you would a normal movie (page 55).  
Press [●] to start and stop recording.

## Recording a High Speed Movie

This camera supports recording of high speed movies at a maximum speed of 1000 fps. The aspect ratio of movies recorded with this mode depends on the frame rate (recording speed).

- Audio is not recorded in this mode.

**1. In the REC mode, set the movie mode switch to  (HS).**

**2. Press [MENU].**

**3. Use [◀] and [▶] to select the “Quality” tab.**

**4. Use [▲] and [▼] to select “HS  Speed” and then press [▶].**

**5. Use [▲] and [▼] to select the frame rate (recording speed) you want and then press [SET].**

A fast frame rate (such as 1000 fps) will result in a smaller image size.

- \* fps (frames per second) is a unit of measurement indicating the number of images recorded or played back per second.

Frame Rate	Image Size (Pixels)
210 fps	480×360
420 fps	224×168
1000 fps	224×64
30-210 fps	480×360

**6. Record the movie the same way as you would a normal movie (page 55).**

Press [●] to start and stop recording.

- With the “30-210 fps” high speed movie, the frame rate is always fixed at 30 fps when you first begin recording. You can switch between 30 fps and 210 fps only while recording is in progress. Use [◀] and [▶] or press [SET] to switch speeds.

## NOTE

- The higher the frame rate (speed), the more lighting is required when shooting. When shooting a high speed movie, shoot in a well-lit environment.
- When recording certain types of movies, the image that appears on the monitor screen may be smaller than normal. When recording a high speed movie, there are black bands along the top, bottom, left, and right of the screen.
- When recording a high speed movie, light source flicker can cause horizontal bands to appear in the image. This does not indicate malfunction of the camera.
- During high speed movie recording, Auto Focus and exposure remain fixed at the levels they were when you initially started recording. Zoom and monitor screen content switching are all disabled.
- To focus the image, half-press the shutter button for Auto Focus or focus manually before starting the high speed movie recording operation.



## Using Prerecord Movie (Prerecord (Movie))

With this feature, the camera pre-records up to five seconds of whatever is happening in front of the lens in a buffer that is continually updated. Pressing [●] saves the pre-recorded action (buffer contents) followed by real-time recording. Real-time recording continues until you stop it. Prerecord Movie can be used when shooting a standard (STD) movie, a high-definition (HD) movie, or a high speed (HS) movie.

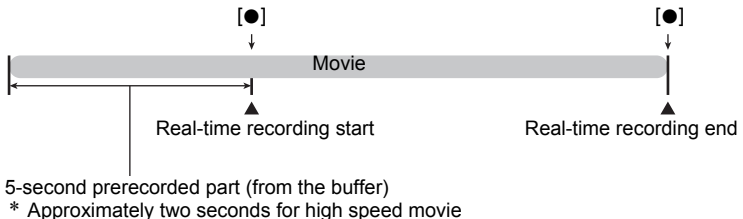
- When using Prerecord Movie in combination with high speed movie, the buffer will store two seconds of pre-recording instead of the usual five.



## ■ To set up the camera to shoot with Prerecord Movie

1. In the REC mode, select the movie mode you want to use by setting the movie mode switch to  (HD/STD) or  (HS).

---

2. Press [BS].

---

3. Use [▲], [▼], [◀], and [▶] to select the “Prerecord (Movie)” scene and then press [SET].

This causes  to appear on the monitor screen, indicating that the camera is prerecording to its buffer.

## ■ To shoot a Prerecord Movie

1. After using the above procedure to set up the camera for Prerecord Movie, point the camera at the subject.

---

2. When you are ready to record, press [●].

This will save the approximately five seconds of action that was prerecorded in the buffer before you pressed [●] (two seconds if you are using high speed movie) and start real-time recording.

---

3. Press [●] again to stop recording.

- To turn off Prerecord Movie, press [BS] and then select  (Auto).
- When shooting with the high speed movie “30-210 fps” setting, you cannot change the speed (fps) setting while the camera is pre-recording to the buffer in step 1 of the above procedure. You can change the speed (fps) setting after you press [●] to start real-time recording.

### NOTE

---

- While the camera is set up for shooting with Prerecord Movie, pressing the shutter button will not shoot a snapshot unless movie recording is in progress. With high-definition (HD) and standard (STD) movie, you can shoot still images while real-time movie recording is in progress.

## Recording a Movie for YouTube (For YouTube)

The “For YouTube” scene records movies in a format that is optimal for uploading to the YouTube movie site, which is operated by YouTube, LLC. “For YouTube” can be used when shooting a standard (STD) movie, a high-definition (HD) movie, or a high speed (HS) movie.

**1. In the REC mode, set the movie mode switch to  (HD/STD) or  (HS).**

Select the movie mode you want to use.

---

**2. Press [BS].**

---

**3. Use [▲], [▼], [◀], and [▶] to select the “For YouTube” scene and then press [SET].**

This causes  to appear on the monitor screen.

---

**4. Record the movie.**

The movie file will be stored in a camera folder named “100YOUTB”.

- Installing YouTube Uploader for CASIO from the CD-ROM that comes with your camera simplifies uploading of movie files you recorded with the “For YouTube” scene to YouTube (page 131).
- To exit “For YouTube”, press [BS] and then select  (Auto).

---

### NOTE

- Movies recorded with the “For YouTube” scene are stored in a special folder to make them easy to locate for uploading (page 142). “For YouTube” movies are shot using the image size, recording speed, and quality settings configured in the Movie Mode (page 55).
- Snapshots cannot be shot (regardless of whether you are recording or not) while the “For YouTube” scene is selected.

## Shooting a Snapshot while Shooting a Movie

### 1. While a movie is being recorded, press the shutter button.

Movie recording continues after the snapshot is recorded.



Number of recordable snapshots

### NOTE





- You can shoot up to 10 snapshots per movie. The number of snapshots is also limited by the amount of free space available on the memory card.
- Note that the flash cannot be used when shooting a Snapshot in Movie.
- A snapshot cannot be shot while recording a high speed movie or while recording with the "For YouTube" BEST SHOT scene.
- You cannot use Snapshot in Movie to shoot a snapshot when recording with "Prerecord (Movie)" while the movie is being pre-recorded to the buffer before you press [●]. You will be able to shoot snapshots during real-time movie recording, which starts when you press [●].
- The size of the stored snapshot is the image size specified on the camera before you started movie recording. Note, however, that when an image size of 9M, 3:2, or 16:9 is selected, the stored snapshot size will be 6M.
- The shooting range when shooting a snapshot while movie recording is in progress is narrower than that of the Single Shot Mode.
- Snapshots shot with Snapshot in Movie cannot be focused individually. The focus will be the same as the movie being recorded.

# Using BEST SHOT

## What is BEST SHOT?

BEST SHOT provides you with a collection of sample “scenes” that show a variety of different types of shooting conditions. When you need to change the setup of the camera, simply find the scene that matches what you are trying to achieve, and the camera sets up for it automatically. This helps to minimize the chance of ruined images due to poor exposure and shutter speed settings.

## Some Sample Scenes

			
Portrait	Scenery	High Speed Night Scene	Night Scene Portrait

## To shoot with BEST SHOT

### 1. In the REC mode, press [BS].

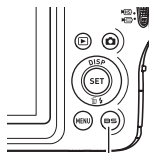

This will display a menu of BEST SHOT scenes.

- The initial default selection is  (Auto).



[BS]

### 2. Use [▲], [▼], [◀], and [▶] to move the boundary to the scene you want to select.

- The scene menu has multiple pages. Use [▲] and [▼] to scroll between menu pages.
- You can access information about the currently selected scene. See page 64 for details.
- To return to normal snapshot recording, select Scene 1  (Auto). Pressing [MENU] while the scene selection screen or scene information screen is displayed will cause the boundary to jump directly to  (Auto).

Currently selected scene (with boundary)

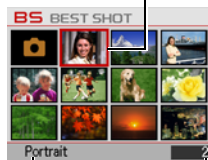

Scene name

Scene number

---

### 3. Press [SET] to configure the camera with the settings for the currently selected scene.

This returns to the REC mode.

- The settings of the scene you selected remain in effect until you select a different scene.
- To select a different BEST SHOT scene, repeat the above procedure from step 1.

---

### 4. Press the shutter button (if you are shooting a snapshot) or [●] (if you are shooting a movie).

#### ■ Using the Scene Information Screen

To find out more about a scene, select it with the boundary on the scene menu and then slide the zoom controller in either direction.

- To return to the scene menu, slide the zoom controller again.
- To scroll between scenes, use [◀] and [▶].
- To configure the camera with the settings for the currently selected scene, press [SET]. To return to the scene information screen for the currently selected BEST SHOT scene, press [BS].

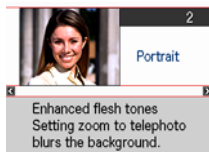



## ■ BEST SHOT Precautions

- BEST SHOT scene images were not shot using this camera.
- Images shot using a BEST SHOT scene may not produce the results you expected due to shooting conditions and other factors.
- You can modify the camera settings that are configured after you select a BEST SHOT scene. Note, however, that the BEST SHOT settings revert to their defaults when you select another BEST SHOT scene or turn off the camera.
- 9M, 3:2, and 16:9 cannot be selected for the image size while the “High Speed Anti Shake”, “High Speed Night Scene”, “Move Out CS”, “Move In CS”, “Multi-motion Image”, or “High Speed Best Selection” BEST SHOT scene is selected. An image size setting of 6M is used if any one of the above image sizes is already selected before selecting one of the above BEST SHOT scenes.
- The following BEST SHOT scenes cannot be used while shooting a snapshot: Prerecord (Movie), For YouTube.
- Selecting any one of the following BEST SHOT scenes will cause the camera to set up for the scene’s preset recording mode, regardless of the camera’s current Single Shot/Continuous Shutter mode setting: “High Speed Night Scene”, “Fireworks”, “Night Scene Portrait”, “High Speed Anti Shake”, “Move Out CS”, “Move In CS”, “Multi-motion Image”, “High Speed Best Selection”. Selecting a BEST SHOT scene other than those listed above (except for “Prerecord (Movie)” and “For YouTube”) will cause it to shoot single shots or continuous shutter images in accordance with its current setting. Other settings and parameters, however, may be affected by the selected BEST SHOT scene.
- Movie recording is not supported with the following BEST SHOT scenes: “High Speed Anti Shake”, “Move Out CS”, “Move In CS”, “Multi-motion Image”, “High Speed Best Selection”.
- When the movie mode is **HD/STD**, movies are recorded using the settings of the selected BEST SHOT scene. For high speed movie recording, BEST SHOT scene settings are ignored and movie recording is performed as it normally is.
- Pressing [SLOW] (Slow Motion View) while any one of the following BEST SHOT scenes is selected will cancel the BEST SHOT scene setting and shoot with Slow Motion View.  
“High Speed Night Scene”, “Night Scene Portrait”, “Fireworks”, “High Speed Anti Shake”, “Multi-motion Image”, “High Speed Best Selection”, “Move Out CS”, “Move In CS”, “Prerecord (Movie)”, “For YouTube”

## Creating Your Own BEST SHOT Setup

You can save up to 999 camera setups as user BEST SHOT scenes for instant recall whenever you need them.

- 1. On the BEST SHOT scene menu, select the scene named BEST SHOT (Register User Scene).**
- 2. Use [◀] and [▶] to select the snapshot whose setup you want to save.**
- 3. Use [▲] and [▼] to select “Save”, and then press [SET].**  
Your BEST SHOT scene will be assigned the name “Recall User Scene”, along with a scene number.

### NOTE

- You can create BEST SHOT setup for snapshots only. You cannot create a movie BEST SHOT setup.
- You can check the settings of the currently selected BEST SHOT scene by displaying the camera's setting menus and looking at its settings.
- User snapshot scenes are assigned numbers in the sequence: U1, U2, and so on.
- The following are the settings that are saved for each user snapshot BEST SHOT scene.  
Face Detection, Focus, EV Shift, White Balance, Flash, ISO, Metering, Lighting, Flash Intensity, Color Filter, Sharpness, Saturation, Contrast
- User BEST SHOT scenes are stored in built-in memory (page 142) in the SCENE folder (snapshots).
- Formatting the camera's built-in memory (page 152) deletes all user BEST SHOT scenes.
- Use the following procedure when you want to delete a user BEST SHOT scene.
  - ① Display the information screen (page 64) of the user BEST SHOT scene you want to delete.
  - ② Press [▼] (  ), select “Delete”, and then press [SET].

## Shooting with High Speed Night Scene (High Speed Night Scene)

With High Speed Night Scene, the camera detects automatically whether it is being hand-held or on a tripod. When you press the shutter button, the camera will record a series of images and combine them in a way that minimizes image blur due to low light conditions. If the camera detects it is on a tripod, it will shoot a single image using a longer exposure time (instead of shooting and combining multiple images), which results in an even clearer image.

### 1. Press [BS] and then select “High Speed Night Scene”.

### 2. When you are ready to shoot, press the shutter button.

- After you press the shutter button, the message “Busy... Please wait...” will appear on the monitor screen to indicate that recording is in progress. Keep the camera still while this message is displayed. The recording process takes some time to complete after the message appears.

#### NOTE

- This BEST SHOT scene saves only a single final image.
- To cancel this BEST SHOT scene and enter the Continuous Shutter mode, press  (Continuous Shutter).
- Shooting with this BEST SHOT scene makes the shooting range narrower than normal.
- Movement while the camera is mounted on a tripod may cause the camera to erroneously judge it is being hand held.
- The flash is always turned off and the flash setting cannot be changed while High Speed Night Scene is enabled.
- For handheld shooting under very dark conditions, this BEST SHOT scene may not be able to produce the exposure level required for a clear image. Use of a tripod under very dark conditions is recommended.

## Shooting with High Speed Anti Shake (High Speed Anti Shake)

When you press the shutter button while High Speed Anti Shake is enabled, the camera records multiple images and automatically combines them in a way that produces a final image with minimal blur. You can shoot with this feature to minimize the effects of camera movement when shooting with optical anti shake does not produce the desired results.

### 1. Press [BS] and then select “High Speed Anti Shake”.

### 2. When you are ready to shoot, press the shutter button.

- After you press the shutter button, the message “Busy... Please wait...” will appear on the monitor screen to indicate that recording is in progress. Keep the camera still while this message is displayed. The recording process takes some time to complete after the message appears.

#### NOTE

- This BEST SHOT scene saves only a single final image.
- To cancel this BEST SHOT scene and enter the Continuous Shutter mode, press  (Continuous Shutter).
- Shooting with this BEST SHOT scene makes the shooting range narrower than normal.
- High Speed Anti Shake will not operate correctly while the camera is mounted on a tripod.
- High Speed Anti Shake may not operate properly resulting in blurred images if the camera is moved more than the allowable range or if the subject moves during shooting.

## Isolating Moving Subjects (Multi-motion image)

Multi-motion image can be used to isolate a moving subject within a series of multiple images and place them against a stationary background. Use a tripod or some other means to make sure that the camera is not moving or shaking when shooting with Multi-motion image.



### Basic Multi-motion image Procedure

**1. Press [BS] and then select “Multi-motion Image”.**

**2. Hold down the shutter button to record.**

**3. Release the shutter button.**

Continuous Shutter shooting will stop and the resulting composite image will appear on the monitor screen.

- The above procedure shoots multiple images and combines them automatically into a final image. Do not move the camera until shooting is complete.
- You can configure the maximum number of CS shots, the CS fps, and Prerecord CS shots settings the same way as you configure the High Speed CS setting (page 48). Note, however, that the maximum number of CS shots for “Multi-motion Image” is 28 instead of 30.

## NOTE

---

- This BEST SHOT scene saves only a single final image.
- To cancel this BEST SHOT scene and enter the Continuous Shutter mode, press  (Continuous Shutter).
- Shooting with this BEST SHOT scene makes the shooting range narrower than normal.
- Shooting with “Multi-motion Image” assumes that the subject is moving and changing positions. Trying to use it to shoot a subject that is moving while maintaining the same location (such as a golf swing, a baseball swing, etc.) will cause an error message to appear on the monitor screen and failure of image recording, or will produce an image in which the shots of the subject are arranged incorrectly.
- Multi-motion will not operate correctly if you shake or move the camera along with the movement of the subject.
- If an error message appears on the monitor screen, either secure the camera so it does not move or shoot against a different type of background.
- If not enough CS images are recorded, an error will be displayed before the camera starts to place the isolated subject onto the stationary background. This can be caused if you release the shutter button too soon when recording the moving subject. Keep the shutter button fully depressed long enough to allow recording of more images.
- Choose a shooting angle so the colors, shapes, and patterns of the moving subject and the background are as different as possible.
- Avoid a shooting angle where the background is monotone or mono-pattern (such as a clear blue sky).
- The camera may not be able to compose the final image if the intervals between movements are so narrow the subject shots overlap. If this happens, increase the interval by using the control panel to select a slower “High-speed CS fps” setting (page 48).

## Shooting with Priority on Subject Faces (High Speed Best Selection)

With High Speed Best Selection, the camera automatically shoots a series of images, and selects the best one based on facial image blur, and facial expression (whether the subject is smiling or blinking).

**1. Press [BS] and then select the “High Speed Best Selection” scene.**

**2. Press the shutter button to shoot.**

- This will cause the message “Busy... Please wait...” to appear. Do not move the camera while this message is displayed. The recording process takes some time to complete after the message appears.

### NOTE

- This BEST SHOT scene saves only a single final image.
- To cancel this BEST SHOT scene and enter the Continuous Shutter mode, press  (Continuous Shutter).
- If one or more of the faces are blurred in all of the images that are shot, they will be blurred in the final image as well.
- The following conditions may make it impossible for the camera to determine if the subject is blinking or smiling. This may result in a final image in which the subject is blinking or not smiling.
  - Faces that are partially or completely darkened by shadows, etc.
  - Hair that is hiding or near the eyes
  - Eye glasses
  - Small faces
  - Faces that are not looking directly at the camera
- Shooting a large group of people will cause processing of the image after shooting to take longer.

## Shooting an Image in Accordance with Subject Movement (Move Out CS/Move In CS)

You can use these features to shoot an image automatically whenever the subject moves into or moves out of a frame on the monitor screen. You also can configure the camera to record images of what happened immediately before and after the subject moves.

<b>Move Out CS</b>	Automatically records what happened immediately before and after the subject moves outside of a boundary on the monitor screen.
<b>Move In CS</b>	Automatically records what happened immediately before and after the subject moves into a boundary on the monitor screen.

### ■ To setup the camera

1. Press [BS] and then select “Move Out CS” or “Move In CS”.

2. Press [SET].

3. Configure the boundary location and size settings.

[▲][▼][◀][▶]	Moves the boundary.
<b>Zoom controller</b>	Resizes the boundary.

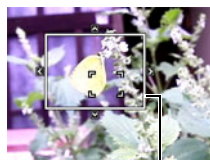

Boundary

4. Press [SET].

- If you want to reconfigure the settings, start again from step 2.

5. Press [▼].

6. Use [▲] and [▼] to select the fifth control panel option from the top (High-speed CS fps).



7. Use [◀] and [▶] to select the continuous shutter (CS) speed you want and then press [SET].

CS speed



<b>AUTO</b>	The camera measures light levels and configures the fastest possible CS speed setting automatically.
<b>3 to 30 fps</b>	Enables specification of the number of CS images recorded per second.

\* fps (frames per second) is a unit of measurement indicating the number of images recorded or played back per second.

8. Use [▲] and [▼] to select the sixth control panel option from the top (Max CS shots).



9. Use [◀] and [▶] to select the maximum number of shots for each continuous shutter operation and then press [SET].

10. Use [▲] and [▼] to select the seventh control panel option from the top (Prerecord CS shots).

11. Use [◀] and [▶] to specify how many of the 30 images and for how long images should be pre-recorded in the buffer.

• You cannot set a value of "0" for the number of Prerecord CS buffer images.

Shutter button full-press

Number of pre-record images and pre-record time (Not displayed when "AUTO" is selected for "High-speed CS fps".)

Number of remaining images and remaining recording time after the shutter button full-press (Not displayed when "AUTO" is selected for "High-speed CS fps".)

12. Press [SET].

• The approximate number of recordable CS images will appear on the monitor screen.

Number of recordable CS images

Remaining snapshot memory capacity

---

**13. Use [▲] and [▼] to select the second control panel option from the bottom (Trigger Sense).**

---

**14. Use [◀] and [▶] to select the subject movement sensitivity, and then press [SET].**

- You can select any one of three sensitivity levels: “High”, “Normal”, or “Low”.
- Move Out CS Setting Guide
  - High: For a subject that moves out of the boundary quickly
  - Low : For a subject that moves out of the boundary slowly
- Move In CS Setting Guide
  - High: For a subject that moves into the boundary quickly or for a small subject (relative to the boundary)
  - Low : For a subject that moves into the boundary slowly or for a large subject (relative to the boundary)

## ■ To shoot using Move Out CS

**1. Compose the image so the subject is within the boundary on the monitor screen.**

---

**2. Half-press the shutter button.**

- The camera will adjust exposure and focus automatically.
- 

**3. When the boundary on the monitor screen turns green, press the shutter button the rest of the way down.**

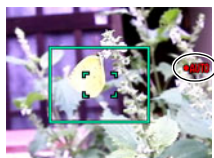

At this time the camera will go into recording standby and start pre-recording images and storing them in a buffer, in accordance with the Prerecord CS shots setting you configured in step 11 under “To setup the camera” on page 72. After the buffer becomes full, new images keep being added while older images are continually being deleted.

The camera will start saving images automatically the moment it detects that the subject has moved out of the boundary.

- “● AUTO” flashes on the monitor screen during recording standby and auto recording.

---

#### 4. Image recording will continue until the end of the recording time is reached.

- While the camera is in Move Out CS recording standby, you can cancel standby by pressing the shutter button all the way down. You then will be able to shoot images normally.
- To stop an ongoing real-time recording operation, press [SET].

---

#### 5. Save the CS images (page 52).

##### ■ To shoot using Move In CS

#### 1. Compose the image at a location where you expect the subject to enter the boundary on the monitor screen.

---

#### 2. Half-press the shutter button.

- The camera will adjust exposure and focus automatically.
- In this case, use of manual focus (page 79) to preset a fixed focus is recommended.

---

#### 3. When the boundary on the monitor screen turns green, press the shutter button the rest of the way down.

At this time the camera will go into recording standby and start pre-recording images and storing them in a buffer, in accordance with the Prerecord CS shots setting you configured in step 11 under "To setup the camera" on page 72. After the buffer becomes full, new images keep being added while older images are continually being deleted.

The camera will start saving images to memory automatically the moment it detects the subject has moved into the area within the boundary.

- "● AUTO" flashes on the monitor screen during recording standby and auto recording.

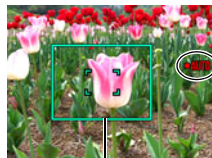

Boundary

---

#### 4. Image recording will continue until the end of the recording time is reached.

- While the camera is in Move In CS recording standby, you can cancel standby by pressing the shutter button all the way down. You then will be able to shoot images normally.
- To stop an ongoing real-time recording operation, press [SET].

---

#### 5. Save the CS images (page 52).

##### NOTE

- Compose the image so the entire subject and its background are within the boundary. Recording may not be performed correctly if there is little difference between the subject and the part of the background enclosed by the boundary. Also, Move Out CS may not record correctly if the subject is not in the center of the boundary.
- Move In CS and Move Out CS do not operate correctly if you press the shutter button all the way down. Be sure to half-press the shutter button. After images are pre-recorded, press the shutter button the rest of the way down.
- After pressing the shutter button all the way to put the camera into record standby, keep the camera still. Recording may not be performed correctly if you move the camera during record standby.
- The camera will shoot only with Continuous Shutter (CS) while this BEST SHOT scene is selected.
- To cancel this BEST SHOT scene and enter the Continuous Shutter mode, press  (Continuous Shutter).
- The sleep mode and Auto Power Off are disabled while the camera is in record standby.
- The camera may not start recording automatically or camera power may turn off when battery power is low. Always make sure that the battery is sufficiently charged before using these features.
- To save all of the continuous shutter images, select "Save All" (page 52) as the continuous shutter image save method. If you do, make sure that the memory card loaded in the camera has enough free space to store them.
- Zoom is disabled, and focus and exposure are fixed while the camera is in recording standby.

# Advanced Settings

The following are menu operations you can use to configure various camera settings.

## Using On-screen Menus

### ■ Example Menu Screen Operation

Press [MENU] to display the menu screen.

- Menu contents are different in the REC mode and PLAY mode.

Example: REC mode menu

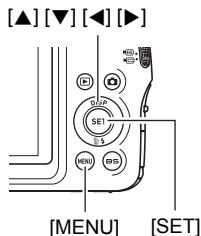

### Menu Screen Operation Buttons

[◀] [▶]	Selects tabs. [▶] is also used to display the options available for a setting.
[▲] [▼]	Selects a setting option.
[SET]	Registers the selected setting.
[MENU]	Exits the menu screen.

#### 1. In the REC mode, press [MENU].

This will display the menu screen.

#### 2. Use [◀] and [▶] to select the tab where the item you want to configure is located.

3. Use [▲] and [▼] to select the menu item you want, and then press [▶].

4. Use [▲] and [▼] to change the setting.

5. After the setting is the way you want, press [SET].

- Pressing [◀] registers the selected setting and returns to the menu.
- To configure settings on another tab after pressing [◀] to return to the menu, use [▲] to move the highlighting up to the tabs, and then use [◀] and [▶] to select the tab you want.

Example:  
When "Self-timer" is selected on the "REC" tab



### ■ Menu Operations in This Manual

Menu operations are represented in this manual as shown below. The following operation is the same as the one described under "Example Menu Screen Operation" on page 77.

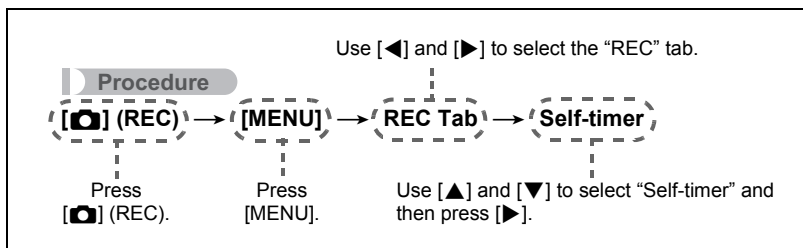





## REC Mode Settings (REC)

### Selecting a Focus Mode (Focus)

#### Procedure

[] (REC) → [MENU] → REC Tab → Focus

Settings	Type of Shot	Focus Mode		Approximate Focus Range* <sup>1</sup>	
		Snapshot	Movies	Snapshot	Movies
 Auto Focus	General recording	Automatic		Approximately 40 cm to ∞ (infinity) (1.3' to ∞)	
 Macro	Close ups	Automatic		Approximately 10 cm to 50 cm (3.9" to 19.7")	
 Pan Focus	Shooting with a relatively wide focus range	Fixed focal point		Fixed distance* <sup>2</sup>	
 Infinity	Scenery and other distant subjects	Fixed		Infinity	
 Manual Focus	When you want to focus manually	Manual		Approximately 10 cm to ∞ (infinity)* <sup>2</sup> (3.9" to ∞)	

\*1 The focus range is the distance from the lens surface.

\*2 The minimum changes along with the optical zoom setting.

## To focus with manual focus

**1. On the monitor screen, compose the image so the subject you want to focus on is within the yellow boundary.**

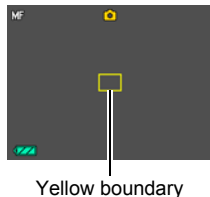

**2. Watching the image on the monitor screen use [◀] and [▶] to adjust focus.**

- At this time the image that is within the boundary will enlarge and fill the monitor screen, which aids in focusing. If you do not perform any operation for two seconds while the enlarged image is displayed, the screen in step 1 will re-appear.

### NOTE

- An Auto Macro feature detects how far the subject is from the lens and automatically selects either Macro Focus or Auto Focus accordingly.
- Use of the flash together with Macro Focus can cause the light of the flash to become blocked, which may result in unwanted lens shadows in your image.
- Auto Macro can be used when recording snapshots only.
- Whenever you perform an optical zoom operation while shooting with Auto Focus, Macro Focus, or Manual Focus, a value will appear on the monitor screen to tell you the focus range, as shown below.

Example: ○○ cm to ∞

\* ○○ is the actual focusing range value.

- The operations assigned to the [◀] and [▶] keys with the “L/R Key” setting (page 88) are disabled while Manual Focus is selected as the focus mode.
- Focus mode selection is disabled while face detection is turned on.



## Using Focus Lock

“Focus lock” is a technique you can use when you want to compose an image in which the subject you want to focus on is not within the focus frame in the center of the screen.

- To use focus lock, select “ Spot” or “ Tracking” for the Auto Focus area (page 84).

**1. Align the monitor screen’s focus frame with the subject you want to focus on and then half-press the shutter button.**

Subject to be focused on

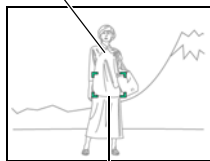

Focus frame

**2. Keeping the shutter button half-pressed (which maintains the focus setting), move the camera to compose the image.**

- When “ Tracking” is selected as the Auto Focus area, the focus frame will move automatically and follow the subject.



**3. When you are ready to shoot the image, press the shutter button the rest of the way down.**

### NOTE



- Focus lock also locks exposure (AE).

## Using the Self-timer (Self-timer)

### Procedure

[] (REC) → [MENU] → REC Tab → Self-timer

With the Self-timer, pressing the shutter button starts a timer. The shutter is released and the image is shot after a fixed amount of time.

 <b>10 sec</b>	10-second Self-timer
 <b>2 sec</b>	2-second Self-timer • When shooting under conditions that slow down the shutter speed, you can use this setting to prevent image blur due to camera movement.
 <b>X3 (Triple Self-timer)</b>	Shoots three images: one image 10 seconds after the shutter button is pressed, and the next two images as soon as the camera is ready after shooting the previous image. How long it takes for the camera to get ready to shoot depends on the image size and quality settings, whether or not a memory card is loaded in the camera, and the flash charge condition.
<b>Off</b>	Self-timer is disabled.

- The front lamp flashes while the Self-timer countdown is in progress.
- You can interrupt an ongoing Self-timer countdown by pressing [SET].

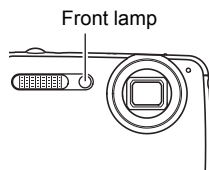

### NOTE

- The Self-timer cannot be used together with the following features. Lag Correction (when shooting single shots), High Speed CS with Prerecord CS, Prerecord (Movie), Move Out CS, Move In CS, Multi-motion Image, Slow Motion View
- The Triple Self-timer cannot be used together with the following features. High Speed CS, Normal Speed CS, Movie, some BEST SHOT scenes (High Speed Best Selection, For YouTube)

## Reducing the Effects of Camera and Subject Movement (Anti Shake)

### Procedure

[] (REC) → [MENU] → REC Tab → Anti Shake

You can turn on the camera's Anti Shake feature to reduce image blur due to subject movement or camera movement when shooting a moving subject using telephoto, when shooting a fast-moving subject, or when shooting under dim lighting conditions.

<b>Auto</b>	Minimizes the effects of hand and subject movement.
<b>Off</b>	Turns off Anti Shake settings

### NOTE

- Only Camera Stabilizer can be used during movie recording.
- The ISO sensitivity setting (page 35) must be "AUTO" for Anti Shake to work.
- Anti Shake is not supported while recording with High Speed Movie.
- Shooting with Anti Shake can cause an image to appear somewhat coarser than normal and can cause slight deterioration of image resolution.
- Anti Shake may not be able to eliminate the effects of camera or subject movement when movement is severe.

## Specifying the Auto Focus Area (AF Area)

### Procedure

[] (REC) → [MENU] → REC Tab → AF Area

You can use the following procedure to change the Auto Focus metering area for shooting snapshots.

- When recording movies, the AF metering area is always " Spot".

Spot	This mode takes readings of a small area in the center of the image. This setting works well with focus lock (page 81).
Free	You can move the focus frame by using [], [], [], and [] to move the focus point and then pressing [SET]. To change the focus point position, select " Free" again and then use [], [], [] and [] to select the position you want.
Tracking	When you half-press the shutter button while this setting is selected, the focus frame will follow the movement of the subject.

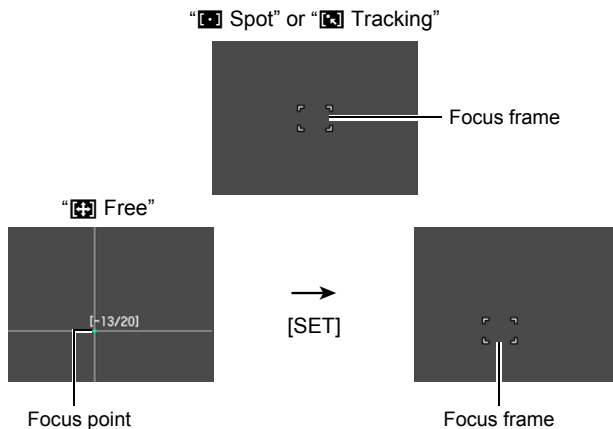

- " Tracking" cannot be used in combination with the following features. Prerecord CS, some BEST SHOT scenes (Move Out CS, Move In CS, Multi-motion Image, For YouTube, Prerecord (Movie)), Lag Correction
- " Free" cannot be selected for the AF area while Face Detection is enabled.

## Using the Auto Focus Assist Light (AF Assist Light)

### Procedure

[] (REC) → [MENU] → REC Tab → AF Assist Light

Half-pressing the shutter button while this setting is selected causes the front lamp to light, which provides illumination for focusing in areas where lighting is dim. Leaving this function turned off is recommended when shoot portraits from short distances, etc.

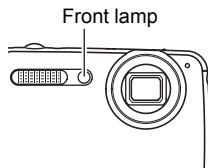

### IMPORTANT!

- Never look directly into the front lamp while it is lit.
- Make sure your finger is not covering the front lamp.

## Shooting with Face Detection (Face Detection)

### Procedure

[] (REC) → [MENU] → REC Tab → Face Detection

When shooting people, the face detection feature detects the faces of up to ten individuals and adjusts focus and brightness accordingly.

**1. Use [◀] and [▶] to select “On” and then press [SET].**

**2. Point the camera at the subject (s).**

The camera will detect human faces and display a frame around each one.

**3. Half-press the shutter button.**

The camera will focus and the frames around the faces it focuses on will turn green.



Face Detection icon

**4. Press the shutter button the rest of the way down.**

## Tips for Best Face Detection Results

- The camera performs center focus if it cannot detect a face.
- Always make sure that Auto Focus (AF) is selected as the focus mode when shooting with face detection.
- Detection of the following types of faces is not supported.
  - A face that is obstructed by hair, sunglasses, a hat, etc., or a face in dark shade
  - A profile or a face that is at an angle
  - A face that is very far away and small, or very close and large
  - A face in an area that is very dark
  - A face of a pet or some other non-human subject



### IMPORTANT!

- Face detection cannot be used in combination with any of the following features.
  - Lag Correction (when shooting single shots)
  - Some BEST SHOT scenes (Move Out CS, Move In CS, Multi-motion Image, For YouTube, Prerecord (Movie))
  - Movie Mode
  - High Speed CS with Prerecord CS
- Focus mode selection on the menu is disabled while face detection is turned on.

## Shooting with Continuous Auto Focus (Continuous AF)

### Procedure

[] (REC) → [MENU] → REC Tab → Continuous AF

When shooting a snapshot while “On” is selected for Continuous AF, Auto Focus is performed and focusing is continually updated until you half-press the shutter button. When “ Auto Focus” or “ Macro” is selected for the “Focus” setting, Continuous AF is performed during HD and STD movie recording, regardless of the current “Continuous AF” setting.



- Before you half-press the shutter button, the camera focuses at the center of the screen. If “ Free” is selected for the “AF Area” setting (page 84) when you half-press the shutter button, focusing is performed for the area specified by “ Free”. If “Face Detection” is turned on, focusing is performed in the area where a face is detected.

## Changing the Continuous Shutter Mode (CS)

### Procedure

[] (REC) → [MENU] → REC Tab → CS

Perform the following steps to change the continuous shutter mode.

 <b>High Speed CS</b>	Enables shooting of up to 30 continuous shutter images at faster speeds than Normal Speed CS. Images shot with this mode cannot be any one of the following sizes: 9M, 3:2, 16:9. If the camera's image size setting is one of these sizes, High Speed CS will shoot 6M images. See page 48 for details.
 <b>Normal Speed CS</b>	Enables shooting at approximately one image per second for as long as memory space is available to store images. See page 47 for details.

## Configuring the Continuous Shutter Image Save Method (Save CS Images)

### Procedure

[] (REC) → [MENU] → REC Tab → Save CS Images

See page 52 for details.

## Turning Digital Zoom On or Off (Digital Zoom)

### Procedure

[] (REC) → [MENU] → REC Tab → Digital Zoom

Select "On" when you want to use digital zoom (page 45).

- Digital zoom is disabled while shooting with the following feature.
  - High speed movie recording

## Assigning Functions to the [◀] and [▶] Keys (L/R Key)

### Procedure

[📷] (REC) → [MENU] → REC Tab → L/R Key

You can assign one of the three functions listed below to the [◀] and [▶] keys.

Setting	[◀]/[▶] key operation
Metering	Changes the Metering Mode (page 92)
Self-timer	Sets the self-timer time (page 82)
Face Detection	Turns face detection on and off (page 85)
Off	Cancels [◀] and [▶] key assignments

## Shooting with Quick Shutter (Quick Shutter)

### Procedure

[📷] (REC) → [MENU] → REC Tab → Quick Shutter

When Quick Shutter is turned on, you can press the shutter button all the way without waiting for Auto Focus. This will record the image using a high-speed focus operation that is much faster than Auto Focus.

<b>On</b>	Turns on Quick Shutter <ul style="list-style-type: none"><li>Some images may be out of focus when Quick Shutter is used.</li></ul>
<b>Off</b>	Turns off Quick Shutter so focus is performed using normal Auto Focus before the image is recorded. <ul style="list-style-type: none"><li>If you fully press the shutter button while Quick Shutter is turned off, images will continue to be shot without focusing.</li><li>Whenever possible, take a little extra time to half-press the shutter button in order to ensure proper focus.</li></ul>

### NOTE

- Quick Shutter is disabled when the zoom factor is greater. Recording is performed using Auto Focus at this time.



## Displaying the On-screen Grid (Grid)

---

### Procedure

[] (REC) → [MENU] → REC Tab → Grid

The on-screen grid can be displayed on the REC mode monitor screen for easy vertical and horizontal alignment when composing images.

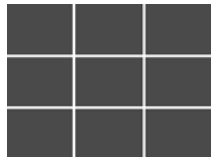

## Turning on Image Review (Review)

---

### Procedure

[] (REC) → [MENU] → REC Tab → Review

While Review is turned on, the camera will display a image for about one second immediately after you press the shutter button to record it.

- Image review is available only when shooting single images. It does not work with continuous shutter.

## Using Icon Help (Icon Help)

---

### Procedure

[] (REC) → [MENU] → REC Tab → Icon Help

While Icon Help is turned on, a textual description will appear on the display for certain icons when you switch between REC functions.

### Functions Supported by Icon Help



- REC Mode
- Available options for the “L/R Key” setting

## Configuring Power On Default Settings (Memory)

### Procedure

[] (REC) → [MENU] → REC Tab → Memory

This setting lets you specify which camera settings should be remembered by the camera when it is turned off, and restored the next time the camera is turned on. To have the camera remember a setting, you should enable the setting's memory. Any setting whose memory is disabled will be reset to its initial default any time the camera is turned off.

Setting	Disabled (Initial Default Setting)	Enabled
 BEST SHOT	 (Auto)	Setting at power off
Flash	Auto	
Focus	 (Auto Focus)	
AF Area	Spot	
Metering	Multi	
CS	High Speed CS	
Self-timer	Off	
Flash Intensity	0	
Digital Zoom	On	
MF Position	Position before manual focus was selected.	
Zoom Position*	Full wide	

\* Optical zoom setting only.

## Image Quality Settings (Quality)

### Specifying Snapshot Image Quality ( Quality (Snapshot))

#### Procedure

[] (REC) → [MENU] → Quality Tab →  Quality (Snapshot)

<b>Fine</b>	Gives image quality priority
<b>Normal</b>	Normal
<b>Economy</b>	Gives the number of images priority

- The "Fine" setting helps to bring out details when shooting dense tree branches or leaves, a complex pattern, etc.
- Memory capacity (the number of images you can record) will be affected by the quality settings you configure (page 176).

### Movie Image Quality Settings ( Quality (Movie))

#### Procedure

[] (REC) → [MENU] → Quality Tab →  Quality (Movie)

This setting can be used to specify HD or STD as the image quality for movie recording when **HD/STD** is selected as the movie mode.

<b>HD</b>	Select this setting record high-definition (HD) movies (page 57). The aspect ratio of movies recorded with this setting is 16:9.
<b>STD</b>	Use this setting for standard movie recording. Recording with this setting is performed using an aspect ratio of 4:3, an image size of 640×480 pixels, and a frame rate of 30 frames per second. Image quality and image size settings cannot be changed.

## Setting the High Speed Movie Frame Rate (HS Speed)

### Procedure

[] (REC) → [MENU] → Quality Tab → HS  Speed



See page 58 for details.

## Specifying the Metering Mode (Metering)

### Procedure

[] (REC) → [MENU] → Quality Tab → Metering

The metering mode determines what part of the subject is metered for exposure.

 <b>Multi</b>	Multi-pattern metering divides the image into sections and measures the light in each section for a balanced exposure reading. This type of metering provides error-free exposure settings for a wide range of shooting conditions.
 <b>Center Weighted</b>	Center weighted metering concentrates on the center of the focus area to measure light. This type of metering is best when you want some level of control over contrast.
 <b>Spot</b>	Spot metering takes readings at a very small area. Use this metering method when you want exposure to be set according to the brightness of a particular subject, without being affected by surrounding conditions.

## Optimizing Image Brightness (Lighting)

### Procedure

[] (REC) → [MENU] → Quality Tab → Lighting

You can use this setting to optimize the balance between bright areas and dark areas when shooting images.

<b>On</b>	Performs brightness correction.
<b>Off</b>	Does not perform brightness correction.

## Specifying Flash Intensity (Flash Intensity)

---

### Procedure

[] (REC) → [MENU] → Quality Tab → Flash Intensity

You can specify flash intensity to one of five levels from +2 (brightest flash) to -2 (least bright flash).

- Flash intensity may not change when the subject is too far away or too close.

## Using Built-in Color Filters (Color Filter)

---

### Procedure

[] (REC) → [MENU] → Quality Tab → Color Filter

Settings: Off, B/W, Sepia, Red, Green, Blue, Yellow, Pink, and Purple

## Controlling Image Sharpness (Sharpness)

---

### Procedure

[] (REC) → [MENU] → Quality Tab → Sharpness

You can specify one of five sharpness settings from +2 (sharpest) to -2 (least sharp).

## Controlling Color Saturation (Saturation)

---

### Procedure

[] (REC) → [MENU] → Quality Tab → Saturation

You can specify one of five saturation settings from +2 (most saturated) to -2 (least saturated).

## Adjusting Image Contrast (Contrast)

---

### Procedure

[] (REC) → [MENU] → Quality Tab → Contrast

You can specify one of five contrast settings from +2 (most contrast between light and dark) to -2 (least contrast between light and dark).

# Viewing Snapshots and Movies

## Viewing Snapshots

See page 28 for the procedure for viewing snapshots.

## Viewing a Movie

1. Press [▶] (PLAY) and then use [◀] and [▶] to display the movie you want to view.
2. Press [SET] to start playback.



### Movie Playback Controls

<b>Fast forward/fast reverse</b>	[◀] [▶] (Playback in progress.) <ul style="list-style-type: none"><li>• Each press of either button increases the speed of the fast forward or fast reverse operation.</li><li>• To return to normal playback speed, press [▼].</li></ul>
<b>Play/pause</b>	[SET]
<b>1 frame forward/back</b>	[◀] [▶] (Playback paused.) <ul style="list-style-type: none"><li>• Holding down either button scrolls continuously.</li></ul>
<b>Volume adjustment</b>	Press [▼] and then press [▲] [▼] <ul style="list-style-type: none"><li>• Volume can be adjusted only while movie playback is in progress.</li></ul>
<b>Information display on/off</b>	[▲] (DISP)
<b>Zoom</b>	Slide the zoom controller in the direction of [⏏] (Q). <ul style="list-style-type: none"><li>• You can use [▲], [▼], [◀], and [▶] to scroll the zoomed image on the monitor screen. You can zoom a movie image up to 4.5 times normal size.</li></ul>
<b>Stop playback</b>	[MENU]

- Playback may not be possible for movies not recorded with this camera.

## Viewing Continuous Shutter Images

Each time you perform a continuous shutter (CS) operation, the camera creates a CS group that includes all of the images for that particular CS session. You can use the following procedure to play back the images in a particular CS group.

### 1. Press [▶] (PLAY) and then use [◀] and [▶] to display the CS group whose images you want to view.



### 2. About one second after you select a CS group, playback of its images will start automatically.

- Playback of the group loops, which means it restarts from the beginning each time the last image of the group is reached. The first playback is at high speed, while the second and subsequent playbacks are at slower speed.
- Note that you cannot scroll forward or back through the images manually, and you cannot change the playback speed while playback is in progress.
- Image information is not displayed during automatic playback of CS group images.
- Pressing [SET] will pause playback. While playback is paused, you can adjust the playback speed, specify the playback direction, scroll forward or back, zoom images, and delete images.

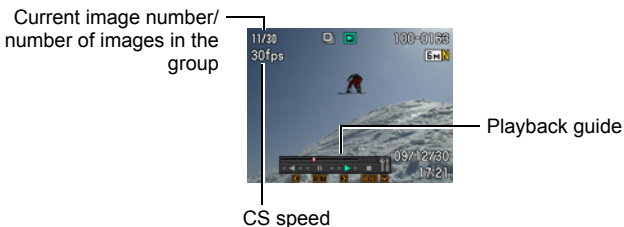

The following are operations that are supported after you press [SET] to start image playback.

[◀] [▶]	During playback, changes the playback direction and playback speed. While playback is paused, scrolls forward or back. <ul style="list-style-type: none"><li>• Playback speed cannot be adjusted while the displayed image is zoomed.</li></ul>
[SET]	Toggles between pause and play.
Zoom controller	Zooms the image. <ul style="list-style-type: none"><li>• You can use [▲], [▼], [◀], and [▶] to scroll the zoomed image on the monitor screen.</li></ul>
[MENU]	Exits CS group playback.
[▲] (DISP)	Cycles through information display formats.
[▼]	Displays the “CS Frame Edit” menu.

#### NOTE

- Multiple images shot using normal-speed continuous shutter are stored individually and are not grouped. This means they can be displayed individually (page 28) but not as a CS group.



## Deleting Continuous Shutter Images

---

You can use the following procedures to delete images while playback is in progress or paused.

### ■ Deleting a Specific CS Group File

- 1. While CS image playback is in progress or paused (toggle by pressing [SET]), press [▼].**

This will display the “CS Frame Edit” menu.

---

- 2. Use [▲] and [▼] to select “Delete” and then press [SET].**
- 

- 3. Use [◀] and [▶] to display the image you want to delete.**
- 

- 4. Use [▲] and [▼] to select “Delete” and then press [SET].**

- To delete other files, repeat steps 3 and 4.
- To exit the delete operation, press [MENU].

### NOTE

---

- Either of the following methods is recommended when you want to keep only one of the images in a CS group and delete all of the others.
  - Copy the image you want to keep to a file located outside of the CS group and then delete the CS group.
  - Protect the image you want to keep and then delete the CS group.

### ■ Deleting All Files in a CS Group

- 1. While CS image playback is in progress or paused (toggle by pressing [SET]), press [▼].**

This will display the “CS Frame Edit” menu.

---

- 2. Use [▲] and [▼] to select “Delete” and then press [SET].**
- 

- 3. Use [▲] and [▼] to select “Del Group Images” and then press [SET].**
- 

- 4. Use [▲] and [▼] to select “Yes”, and then press [SET].**

## Dividing Up a CS Group

---

Use the following to divide up a CS Group into individual images.

### ■ Dividing Up a Specific CS Group

1. While a CS group is displayed or while the images of a CS group are scrolling on the monitor screen, press [MENU].

---

2. Use [◀] and [▶] to select “PLAY” tab.

---

3. Use [▲] and [▼] to select “Divide Group” and then press [▶].

---

4. Use [◀] and [▶] to display the CS group folder whose CS group you want to divide up.

---

5. Use [▲] and [▼] to select “Divide” and then press [SET].
  - To divide up other CS group files, repeat steps 4 and 5.

### ■ Dividing Up All CS Groups

1. While a CS group is displayed or while the images of a CS group are scrolling on the monitor screen, press [MENU].

---

2. Use [◀] and [▶] to select “PLAY” tab.

---

3. Use [▲] and [▼] to select “Divide Group” and then press [▶].

---

4. Use [▲] and [▼] to select “Divide All Groups” and then press [SET].

---

5. Use [▲] and [▼] to select “Yes”, and then press [SET].
  - Once a CS group is divided, it cannot be regrouped.

## Copying a CS Group Image

---

Use the following procedure to copy an image in a CS group to a location outside of the group.

- 1. While CS image playback is in progress or paused (toggle by pressing [SET]), press [▼].**

This will display the “CS Frame Edit” menu.

- 2. Use [▲] and [▼] to select “Copy”, and then press [SET].**
- 

- 3. Use [◀] and [▶] to display the image you want to copy.**
- 

- 4. Use [▲] and [▼] to select “Copy”, and then press [SET].**

### NOTE

---

- The functions below cannot be performed on snapshots inside a CS group folder. Before using either of these functions, perform the above procedure to copy the image first.

White Balance, Brightness, Trimming, Rotation, Resize

## Zooming an On-screen Image

**1. In the PLAY mode, use [◀] and [▶] to scroll through the images until the one you want is displayed.**

**2. Slide the zoom controller towards [🔍] (🔍) to zoom.**

You can use [▲], [▼], [◀], and [▶] to scroll the zoomed image on the monitor screen. Slide the zoom controller towards [🔍] to unzoom the image.

- When monitor screen contents are turned on, a graphic in the lower right corner of the screen shows what part of the zoomed image is currently displayed.
  - To exit the zoom screen, press [MENU].
  - Though the maximum image zoom factor is 8X, certain image sizes may not allow zooming up to the full 8X.
- Pressing [SET] will lock the current zoom factor for the on-screen image. You can then use [◀] and [▶] to scroll between images, using the same zoom factor. Pressing [SET] again will unlock the zoom factor and allow you to use [▲], [▼], [◀] and [▶] to move around the currently displayed images. This function cannot be used while viewing CS group images or movies. Also, CS group images and movies will not appear when you are scrolling images with [◀] and [▶].

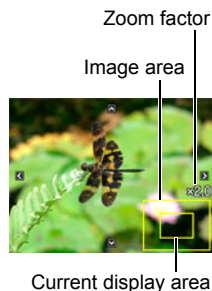

## Displaying the Image Menu

**1. In the PLAY mode, slide the zoom controller towards [🔍] (🔍).**

Use [▲], [▼], [◀] and [▶] to move the selection boundary around the image menu.

To view a particular image, use [▲], [▼], [◀], or [▶] to move the selection boundary to the image you want and then press [SET].

- In the case of a movie or a continuous shutter (CS) file, the first frame of the file will be displayed.



## Viewing Snapshots and Movies on a TV Screen

### 1. Use the AV cable that comes with the camera to connect it to the TV.

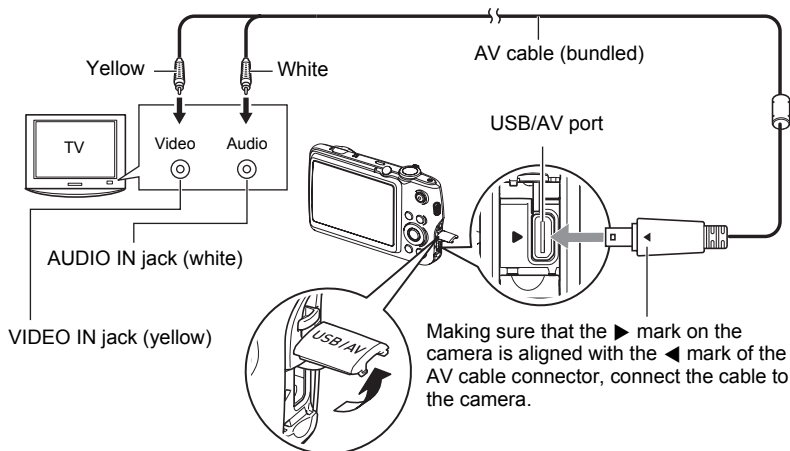

- Make sure that you insert the cable connector into the USB/AV port until you feel it click securely into place. Failure to insert the connector fully can result in poor communication or malfunction.
- Note that even while the connector is fully inserted, you still will be able to see the metal part of the connector as shown in the illustration.
- Make sure that the camera is turned off before plugging in or unplugging the cable. Check the user documentation that comes with the TV for information about requirements before plugging into or unplugging from the TV.

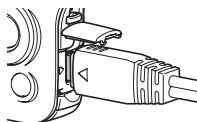

### 2. Turn on the TV and select its video input mode.

If the TV has more than one video input, select the one where the camera is connected.

---

### 3. Press **[▶] (PLAY)** to turn on the camera.

This will cause an image to appear on the TV screen, without anything appearing on the camera's monitor screen.

- Pressing **[ON/OFF]** or **[📷] (REC)** will not turn on the camera while the AV cable is connected.
- You also can change the aspect ratio of the screen and the video output system (page 151).

---

### 4. Now you can display images and play back movies as you normally do.



#### **IMPORTANT!**

- Before connecting to a TV to display images, be sure to configure the camera's **[📷] (REC)** and **[▶] (PLAY)** buttons for "Power On" or "Power On/Off" (page 150).
- Audio is initially output by the camera at maximum volume. When you first start displaying images, set the TV volume control at a relatively low level and then adjust it as required.

---

#### **NOTE**

- Audio is monaural.
- Some TVs may not be able to output images and/or audio correctly.
- All icons and indicators that appear on the monitor screen also appear on the TV screen. You can use **[▲] (DISP)** to change the display contents.

### **Recording Camera Images to a DVD Recorder or Video Deck**

Use the following method to connect the camera to the recording device using the camera's bundled AV cable.

- DVD recorder or video deck: Connect the AV cable to the VIDEO IN and AUDIO IN terminals.
- Camera: Connect the AV cable to the USB/AV port

You can play a slideshow of snapshots and movies on the camera and record it on a DVD or video tape. You can record movies by selecting "**[📷] Only**" for the slideshow "Images" setting (page 103). When recording images to an external device, use **[▲] (DISP)** to clear all indicators from the monitor screen (page 153).

For information about connecting a monitor to the recording device and about how to record, see the user documentation that comes with the recording device you are using.

# Other Playback Functions (PLAY)







This section explains menu items that you can use to configure settings and perform other playback operations.

For information about menu operations, see page 77.

## Playing a Slideshow on the Camera (Slideshow)

### Procedure

[] (PLAY) → [MENU] → PLAY Tab → Slideshow

<b>Start</b>
Starts the slideshow
<b>Images</b>
Specifies the type of images to be included in the slideshow All images: Snapshots, movies, continuous shutter images All images except  : All non-continuous shutter (CS) images  Only: Snapshots only  Only: Movies only One Image: One single selected image (selected using [  ] and [  ])
<b>Time</b>
Time from the start to the end of the slideshow 1 to 5 minutes, 10 minutes, 15 minutes, 30 minutes, 60 minutes
<b>Interval</b>
Amount of time each image remains displayed Use [  ] and [  ] to select a value from 1 to 30 seconds, or "MAX". If you specify a value from 1 to 30 seconds, movies play from beginning to end. When the slideshow reaches a movie file while "MAX" is selected, only the first frame of the movie will be displayed.

## Effect

Select the effect you want.

Pattern 1 to 5: Plays background music and applies an image change effect.

- Patterns 2 through 4 have different background music, but they all use the same image change effect.
  - Pattern 5 can be used for playback of snapshots only (except for those that are part of a CS group), and the "Interval" setting is ignored.
  - Movies that include audio are played back without background music. Movies that do not include audio are played back with background music.
  - The currently selected image change effect setting is disabled automatically in following cases.
    - When playing a slideshow for which "☑ Only" or "One Image" is selected for the "Images" setting
    - When the interval setting is "MAX", 1 second, or 2 seconds
    - Before and after playback of a movie
    - During CS group playback (Except the Pattern 1 effect)
- Off: No image change effect or background music

- To stop the slideshow, press [SET] or [MENU]. Pressing [MENU] stops the slideshow and returns to the menu screen.
- Adjust audio volume by pressing [▼] and then press [▲] or [▼] during playback.
- All button operations are disabled while the slideshow is transitioning from one image to another.
- The time required for transition from one image to another may be longer in the case of an image that was not recorded with this camera.

## Transferring Music from Your Computer to Camera Memory

You can replace the built-in slideshow background music with other music from your computer.

### Supported File Types:

- IMA-ADPCM format WAV files
- Sampling Frequencies: 22.05 kHz/44.1 kHz
- Quality: Monaural

### Number of Files: 9

### File names: SSBGM001.WAV to SSBGM009.WAV

- Create the music files on your computer using the above names.
- Regardless of which effect pattern you select, the music files you store in camera memory are played back in name sequence.



## **1. Connect the camera to your computer (pages 126, 135).**

If you plan to save the music files to the camera's memory card, make sure the card is loaded in the camera.

---

## **2. Perform one of the following operations to open the memory card or built-in memory.**

This will cause the camera to be recognized by your computer as a Removable Disk (Drive).

- Windows
    - ① Windows Vista: Start → Computer
    - Windows XP: Start → My Computer
    - Windows 2000: Double-click "My Computer".
    - ② Double-click "Removable Disk".
  - Macintosh
    - ① Double-click the camera's drive icon.
- 

## **3. Create a folder named "SSBGM".**

## **4. Double-click the "SSBGM" folder you created and copy the background music file to it.**

- See the user documentation that comes with your computer for information about moving, copying, and deleting files.
  - If there are background music files both in built-in memory and on the memory card loaded in the camera, the files on the memory card take priority.
  - See page 142 for information about camera folders.
- 

## **5. Disconnect the camera from the computer (pages 128, 137).**

## Creating a Snapshot of Movie Frames (MOTION PRINT)

### Procedure

[▶] (PLAY) → Movie Screen → [MENU] → PLAY Tab → MOTION PRINT

1. Use [◀] and [▶] to scroll through the movie frames and display the one you want to use as the image of the MOTION PRINT image.

Holding down [◀] or [▶] scrolls at high speed.



9 frames

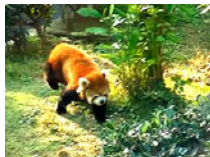

1 frame

2. Use [▲] and [▼] to select either “9 frames” or “1 frame” and then press [SET].



- When “9 frames” is selected, the frame you select in step 1 will be in the center of the MOTION PRINT image.
- Only the frames of movies recorded on this camera can be used in a MOTION PRINT image.

## Editing a Movie on the Camera (Movie Editing)

### Procedure

[**▶**] (PLAY) → **Movie Screen of Movie to be Edited** → [**MENU**] → **PLAY Tab** → **Movie Editing**

The Movie Editing feature lets you use one of the following procedures to edit out a specific part of a movie.

 <b>Cut (To-Point Cut)</b>	Cuts everything from the beginning of the movie up to the current location.
 <b>Cut (Point-To-Point Cut)</b>	Cuts everything between two points.
 <b>Cut (From-Point Cut)</b>	Cuts everything from the current location to the end of the movie.

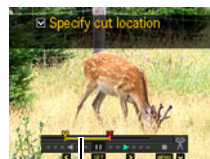

1. Use [**▲**] and [**▼**] to select the editing method you want to use and then press [**SET**].
2. Use the following operations to select the frame (point) from which or to which you want to cut the movie (the cut point).

[ <b>◀</b> ] [ <b>▶</b> ]	During playback, changes the playback direction and playback speed. While playback is paused, scrolls forward or back.
[ <b>SET</b> ]	Toggles between pause and play.



Cut range (yellow)

### 3. Press [▼] to display the editing menu and specify one or two cut points.

 <b>Cut (To-Point Cut)</b>	While the frame you want the cut to be up to is displayed, press [▼].
 <b>Cut (Point-To-Point Cut)</b>	<ol style="list-style-type: none"><li>① While the frame you want the first (From) cut to be is displayed, press [▼].</li><li>② Select another frame.</li><li>③ While the frame you want the second (To) cut to be is displayed, press [▼].</li></ol>
 <b>Cut (From-Point Cut)</b>	While the frame you want the cut to be from is displayed, press [▼].

### 4. Use [▲] and [▼] to select “Yes” and then press [SET].

The selected cut operation will take considerable time to complete. Don't try to perform any camera operation until the “Busy... Please wait...” message disappears from the monitor screen. Note that a cut operation can take a long time if the movie being edited is long.

#### **IMPORTANT!**

- When you edit a movie, only the result is saved. The original movie is not retained. An editing operation cannot be undone.

#### **NOTE**







- A movie that is shorter than five seconds cannot be edited.
- Editing of movies recorded with a different type of camera is not supported.
- You will not be able to edit a movie if the amount of remaining memory capacity is less than the size of the movie file you want to edit. If there is not enough memory available, delete files you no longer need to free up more.
- Splitting of a movie into two movies and splicing of two different movies into a single movie are not supported.
- You also can start a movie editing operation while the movie you want to edit is playing back. When playback reaches a frame where you want a cut point to be, press [SET] to pause playback. Next, press [▼] to display the menu of editing options. Perform editing using the same procedures as described above.

## Adjusting White Balance (White Balance)

### Procedure

[] (PLAY) → Snapshot Screen → [MENU] → PLAY Tab → White Balance

You can use the white balance setting to select a light source type for a recorded image, which will affect the colors of the image.

 Daylight	Outdoors, fair weather
 Overcast	Outdoors, cloudy to rain, in tree shade, etc.
 Shade	Very high temperature light, such as building shade, etc.
 Day White Fluorescent	White or day white fluorescent lighting, without suppressing color cast
 Daylight Fluorescent	Daylight fluorescent lighting, while suppressing color cast
 Tungsten	Suppressing of the appearance of light bulb lighting
Cancel	No white balance adjustment

### NOTE

- You also can adjust the white balance when recording images (page 35).
- The original snapshot is retained in memory and not deleted.
- When you display an altered image on the camera's monitor screen, the date and time indicates when the image was originally recorded, not when the image was altered.

## Adjusting the Brightness of an Existing Snapshot (Brightness)

### Procedure

**[▶] (PLAY) → Snapshot Screen → [MENU] → PLAY Tab → Brightness**

You can select one of five brightness levels, from +2 (brightest) to -2 (least bright).

### NOTE

- The original snapshot is retained in memory and not deleted.
- When you display an altered image on the camera's monitor screen, the date and time indicates when the image was originally recorded, not when the image was altered.

## Selecting Images for Printing (DPOF Printing)

### Procedure



**[▶] (PLAY) → Snapshot Screen → [MENU] → PLAY Tab → DPOF Printing**

See page 120 for details.

## Protecting a File Against Deletion (Protect)

### Procedure

[▶] (PLAY) → [MENU] → PLAY Tab → Protect

<b>On</b>	<p>Protects specific files.</p> <ol style="list-style-type: none"><li>① Use [◀] and [▶] to scroll through the files until the one you want to protect is displayed.</li><li>② Use [▲] and [▼] to select "On" and then press [SET]. An image that is protected is indicated by the  icon.</li><li>③ To protect other files, repeat steps 1 and 2. To exit the protect operation, press [MENU]. To unprotect a file, select "Off" instead of "On" in step 2 above.</li></ol>	
<b>All Files: On</b>	<p>Protects all files.</p> <ol style="list-style-type: none"><li>① Use [▲] and [▼] to select "All Files: On" and then press [SET].</li><li>② Press [MENU]. To unprotect all files, select "All Files: Off" instead of "All Files: On" in step 1 above.</li></ol>	

### ★ IMPORTANT!

- Note that even if a file is protected, it will be deleted if you perform the format operation (page 152).

### NOTE

- Performing the above procedure while a CS group folder is displayed will protect all the images in the CS group folder. You can protect individual images in a CS group by performing the above procedure while the image is displayed.

## ■ To protect a specific image in a CS group

1. While CS image playback is in progress or paused (toggle by pressing [SET]), press [▼].

This will display the “CS Frame Edit” menu.

---

2. Use [▲] and [▼] to select “Protect” and then press [SET].
- 

3. Use [◀] and [▶] to scroll through images until one you want to protect is displayed.
- 

4. Use [▲] and [▼] to select “On” and then press [SET].

This will protect the image and display the  icon.

- To unprotect an image, select “Off” in step 4 and then press [SET].
- 

5. After you are finished, select “Cancel” and then press [SET] to exit this operation.

### NOTE

---

- Note that even if a file is protected, it will be deleted if you perform the format operation (page 152).



## ■ To protect all the images in a CS group

**1. While a CS group is displayed or while the images of a CS group are scrolling on the monitor screen, press [MENU].**

---

**2. Use [◀] and [▶] to select “PLAY” tab.**

---

**3. Use [▲] and [▼] to select “Protect” and then press [SET].**

---

**4. Use [◀] and [▶] to display the CS group you want to protect.**

---

**5. Use [▲] and [▼] to select “On” and then press [SET].**

This will protect all the images in the group and display the  icon.

- To unprotect all of the images in the group, select “Off” in step 5 and then press [SET].
- 

**6. Press [MENU].**

### NOTE

---

- Note that even if a file is protected, it will be deleted if you perform the format operation (page 152).

## Rotating an Image (Rotation)

### Procedure

[] (PLAY) → Snapshot Screen → [MENU] → PLAY Tab → Rotation

**1. Use [] and [] to select “Rotation” and then press [SET].**

Each press of [SET] will rotate the displayed image 90 degrees left.

**2. When the displayed image is at the orientation you want, press [MENU].**

### NOTE

- A CS group or an image that is part of a CS group cannot be rotated.
- Rotation of movie images is not supported.
- Note that this procedure does not actually change the image data. It simply alters how the image is displayed on the camera's monitor screen.
- An image that has been protected or zoomed cannot be rotated.
- The original (unrotated) version of the image will be displayed on the image menu screen.

## Resizing a Snapshot (Resize)

### Procedure

[] (PLAY) → Snapshot Screen → [MENU] → PLAY Tab → Resize

You can reduce the size of a snapshot and save the result as a separate snapshot. The original snapshot is also retained. You can resize an image to one of three sizes: 5M, 2M, VGA.





- Resizing a 3:2 or 16:9 size snapshot will create an image with an aspect ratio of 4:3, with both sides cut off.
- The recording date of the resized version of the snapshot will be the same as the recording date of the original snapshot.

## Cropping a Snapshot (Trimming)

### Procedure

[] (PLAY) → Snapshot Screen → [MENU] → PLAY Tab → Trimming

You can crop a snapshot to trim parts you do not need, and save the result in a separate file. The original snapshot is also retained.

Use the zoom controller to zoom the image to the size you want, use [, [, [, and [] to display the portion of the image you want to cut out, and then press [SET].

- The image produced by cropping a 3:2 or 16:9 image will have an aspect ratio of 4:3.
- The recording date of the cropped image will be the same as the recording date of the original snapshot.

Zoom factor  
Represents  
snapshot area







Part of snapshot that is  
currently displayed

## Copying Files (Copy)

### Procedure

[] (PLAY) → Snapshot Screen → [MENU] → PLAY Tab → Copy

Files can be copied from the camera's built-in memory to a memory card or from a memory card to built-in memory.

<b>Built-in → Card</b>	Copies all files from built-in camera memory to a memory card. This option copies all the files in built-in camera memory. It cannot be used to copy a single file.
<b>Card → Built-in</b>	Copies a single file on the memory card to camera built-in camera memory. Files are copied to the folder in built-in memory whose name has the largest serial number. <ul style="list-style-type: none"><li>• You cannot copy a continuous shutter (CS) group image (page 99).</li></ul> <ol style="list-style-type: none"><li>① Use [] and [] to select the file you want to copy.</li><li>② Use [] and [] to select "Copy" and then press [SET].</li></ol>

### NOTE

- You can copy snapshots or movies you recorded with this camera.

## Dividing Up a Continuous Shutter Group (Divide Group)

### Procedure

**[▶] (PLAY) → [MENU] → PLAY Tab → Divide Group**

See page 98 for details.

## Editing a CS Image (CS Frame Edit)

### Procedure

**[▶] (PLAY) → [MENU] → PLAY Tab → CS Frame Edit**

See the following pages for details.

DPOF Printing: page 121

Protect: page 112

Copy: page 99

Delete: page 97

# Printing

## Printing Snapshots

### Professional Print Service

You can take a memory card that contains the images you want to print to a professional print service and have them printed.



### Printing on a Home Printer

#### Printing Images on a Printer with Memory Card Slot

You can use a printer equipped with a memory card slot to print images directly from a memory card. For details, see the user documentation that comes with your printer.



#### Connecting Directly to a PictBridge Compatible Printer

You can print on a printer that supports PictBridge (page 117).

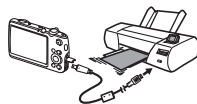

### Printing with a Computer

After transferring the images to your computer, use commercially available software to print.

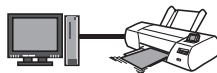

- You can specify which images you want to print, the number of copies, and date stamp settings before printing (page 120).

## Connecting Directly to a PictBridge Compatible Printer

You can connect the camera directly to a printer that supports PictBridge and print images without going through a computer.

### ■ To set up the camera before connecting to a printer

1. Turn on the camera and press [MENU].
2. On the “Set Up” tab, select “USB” and then press [▶].
3. Use [▲] and [▼] to select “PTP (PictBridge)”, and then press [SET].

## ■ Connecting the Camera to a Printer

Use the USB cable that comes bundled with the camera to connect the camera to your printer's USB port.

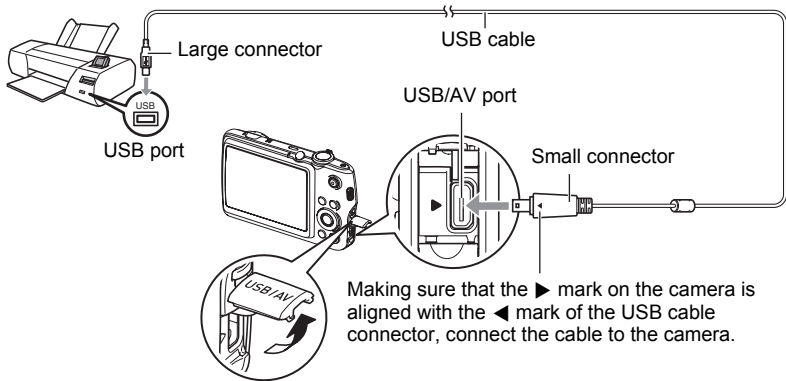

- The camera does not draw power over the USB cable. Check the battery level before connecting and make sure it is not too low.
- Make sure that you insert the cable connector into the USB/AV port until you feel it click securely into place. Failure to insert the connector fully can result in poor communication or malfunction.
- Note that even while the connector is fully inserted, you still will be able to see the metal part of the connector as shown in the illustration.
- When connecting the USB cable to a USB port, make sure you align the connector correctly with the port.
- Make sure that the camera is turned off before plugging in or unplugging the cable. Check the user documentation that comes with the printer for information about requirements before plugging into or unplugging from the printer.

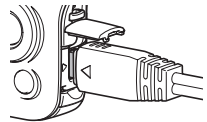

## ■ To print

### 1. Turn on the printer and load paper.

---

### 2. Turn on the camera.

This will display the print menu screen.

---

### 3. Use [▲] and [▼] to select “Paper Size”, and then press [▶].

---

### 4. Use [▲] and [▼] to select a paper size and then press [SET].

- The following are the available paper sizes.  
3.5"×5", 5"×7", 4"×6", A4, 8.5"×11", By Printer
  - Selecting “By Printer” prints using a paper size selected on the printer.
  - See the documentation that comes with your printer for information about paper settings.
- 

### 5. Use [▲] and [▼] to specify the print option you want.

1 Image : Prints one image. Select and then press [SET]. Next, use [◀] and [▶] to select the image you want to print.

DPOF Printing: Prints multiple images. Select and then press [SET]. With this option, images will be printed in accordance with DPOF settings (page 120).

- To toggle date stamping on and off, press [BS]. The date stamp will be printed when “On” is indicated on the monitor screen.
- 

### 6. Use [▲] and [▼] to select “Print” and then press [SET].

Printing will start and the message “Busy... Please wait...” will appear on the monitor screen. The message will disappear after a short while, even though printing is still being performed. Pressing any camera button will cause the printing status to re-appear. The print menu screen will re-appear when printing is complete.

- If you selected “1 Image”, you can repeat the procedure from step 5, if you want.
- 

### 7. After printing is complete, turn off the camera and disconnect the USB cable from the printer and camera.

## Using DPOF to Specify Images to be Printed and the Number of Copies

### ■ Digital Print Order Format (DPOF)

DPOF is a standard that allows you to include image type, number of copy, and time stamp on/off information on the memory card with the images. After configuring settings, you can use the memory card to print on a home printer that supports DPOF or take the memory card to a professional print service.



- Whether or not you will be able to use DPOF settings for printing depends on the printer you are using.
- Some professional print services may not support DPOF.

### ■ Configuring DPOF Settings Individually for Each Image

#### Procedure

[**▶**] (PLAY) → Snapshot Screen → [MENU] → PLAY Tab → DPOF Printing → Select images

1. Use [**◀**] and [**▶**] to scroll through the files until the image you want to print is displayed.

---

2. Use [**▲**] and [**▼**] to specify the number of copies.  
You can specify a value up to 99. Specify 00 if you do not want to print the image.
  - If you want to include the date in the images, press [BS] so "On" is shown for date stamping.
  - Repeat steps 1 and 2 to configure settings for other images, if you want.

---

3. Press [SET].



## ■ Configuring the Same DPOF Settings for All the Images

### Procedure

[] (PLAY) → Snapshot Screen → [MENU] → PLAY Tab → DPOF Printing → All images

#### 1. Use [] and [] to specify the number of copies.

You can specify a value up to 99. Specify 00 if you do not want to print the image.

- Note that the specified number of copies will be printed for all of the images in any CS group included with the images.
- If you want to include the date in the images, press [BS] so “On” is shown for date stamping.

---

#### 2. Press [SET].

### NOTE

- You can specify the number of copies for a specific image (page 121) or for all of the images in a CS group (page 122) by performing the above procedure while an image in the group is displayed.

## ■ To specify the number of copies for a specific image in a CS group

#### 1. While CS image playback is in progress or paused (toggle by pressing [SET]), press [].

This will display the “CS Frame Edit” menu.

---

#### 2. Use [] and [] to select “DPOF Printing” and then press [SET].

---

#### 3. Use [] and [] to select “Select images” and then press [SET].

---

#### 4. Use [] and [] to scroll through images until one you want to print is displayed.

---

#### 5. Use [] and [] to specify the number of copies.

You can specify a value up to 99. Specify 00 if you do not want to print the image.

- If you want to include the date in the images, press [BS] to select “On” for date stamping.
- Repeat steps 4 and 5 to configure settings for other images, if you want.

---

#### 6. Press [SET].

■ **To configure the same DPOF settings for all the images in a CS group**

**1. While CS image playback is in progress or paused (toggle by pressing [SET]), press [▼].**

This will display the "CS Frame Edit" menu.

---

**2. Use [▲] and [▼] to select "DPOF Printing" and then press [SET].**

---

**3. Use [▲] and [▼] to select "Frame all" and then press [SET].**

---

**4. Use [▲] and [▼] to specify the number of copies.**

You can specify a value up to 99. Specify 00 if you do not want to print the image.

- If you want to include the date in the images, press [BS] to select "On" for date stamping.
- 

**5. Press [SET].**

**DPOF settings are not cleared automatically after printing is complete.**

The next DPOF print operation you execute will be performed using the last DPOF settings you configured for the images. To clear DPOF settings, specify "00" for the number of copies of all images.

**Tell your print service about your DPOF settings!**

If you take a memory card to a professional print service, be sure to tell them that it includes DPOF settings for the images to be printed and the number of copies. If you don't, the print service may print all the images without regard to your DPOF settings, or they may ignore your date stamp setting.

## ■ Date Stamping

You can use one of the following three methods to include the recording date in the printout of an image.

<b>Configuring camera settings</b>
Configure DPOF settings (page 120). You can turn date stamping on and off each time you print. You can configure settings so some images include the date stamp and some don't.
Configure the Camera's Timestamp setting (page 147). <ul style="list-style-type: none"><li>• The camera's Timestamp setting imprints the date into a snapshot when you shoot it, so the date is always included when you print. It cannot be deleted.</li><li>• Do not turn on DPOF date stamping for an image that includes a date stamped with the camera's Timestamp function. Doing so can cause the two stamps to be overprinted.</li></ul>
<b>Configuring computer settings</b>
You can use commercially available image management software to date stamp images.
<b>Professional print service</b>
Request date stamping when ordering prints from a professional print service.

## ■ Standards Supported by the Camera

### • PictBridge

This is a standard of the Camera and Imaging Products Association (CIPA). You can connect the camera directly to a printer that supports PictBridge, and perform image selection and printing using the camera monitor screen and controls.



### • PRINT Image Matching III

Using image editing software and printing on a printer that supports PRINT Image Matching III makes it possible to use information about shooting conditions that is recorded with the image, and produce exactly the type of image you want. PRINT Image Matching and PRINT Image Matching III are trademarks of Seiko Epson Corporation.



### • Exif Print



Printing on a printer that supports Exif Print (Exif 2.2) uses information about shooting conditions recorded with the image to enhance printed image quality. Contact your printer manufacturer for information about models that support Exif Print, printer upgrades, etc.



# Using the Camera with a Computer

## Things you can do using a computer...

You can perform the operations described below while the camera is connected to a computer.

<b>Save images to a computer and view them there</b>		<ul style="list-style-type: none"><li>• Save images and view them manually (USB connection) (pages 126, 135).</li><li>• Transfer images to a computer automatically over a wireless LAN for viewing (Eye-Fi) (page 140).</li></ul>
<b>Transfer images stored on your computer to camera memory</b>		In addition to images, you also can transfer screen shot images from your computer to the camera (Photo Transport*) (page 133).
<b>Playback and edit movies</b>		<ul style="list-style-type: none"><li>• You can play back movies (pages 130, 138).</li><li>• To edit movies, use commercially available software as required.</li></ul>

\* Windows only

The procedures you need to perform when using the camera with your computer and when using the bundled software are different for Windows and the Macintosh.

- Windows users should refer to “Using the Camera with a Windows Computer” on page 125.
- Macintosh users should refer to “Using the Camera with a Macintosh” on page 135.

## Using the Camera with a Windows Computer

Install the required software in accordance with the version of Windows you are running and what you want to do.

When you want to do this:	Operating System Version	Install this software:	See page:
Save images to a computer and view them there manually	Vista / XP / 2000	Installation not required.	126
Play movies	Vista / XP / 2000	Installation not required. <ul style="list-style-type: none"> <li>Windows Media Player, which is already installed on most computers, can be used for playback.</li> <li>If your computer is running Windows 2000 and does not have DirectX 9.0c or higher installed, download DirectX from the Microsoft DirectX site and install it on your computer.</li> </ul>	130
Edit movies	Vista / XP / 2000	– <ul style="list-style-type: none"> <li>Use commercial software as required.</li> </ul>	–
Upload movie files to YouTube	Vista / XP (SP2/SP3) / 2000 (SP4)	<b>YouTube Uploader for CASIO*</b>	131
Transfer images to the camera	Vista / XP / 2000	<b>Photo Transport 1.0*</b>	133
View the User's Guide	Vista / XP (SP2/SP3) / 2000 (SP4)	<b>Adobe Reader 8</b> (Not required if already installed.)	132

\* YouTube Uploader for CASIO and Photo Transport will not run under 64-bit versions of Windows Vista.

## ■ Computer System Requirements for Bundled Software

Computer system requirements are different for each of the applications. See the “Read me” file that comes with each application for details. Information about computer system requirements also can be found under “Computer System Requirements for Bundled Software” on page 166 of this manual.

## ■ Precautions for Windows Users

- Except for Adobe Reader, the bundled software requires Administrator privileges to run.
- Operation under a dual-processor environment is not supported.
- Operation may not be possible under certain computer environments.

## Viewing and Storing Images on a Computer

---

You can connect the camera to your computer in order to view and store images (snapshot and movie files).

### ■ To connect the camera to your computer and save files

1. Turn on the camera and press [MENU].

---

2. On the “Set Up” tab, select “USB” and then press [▶].

---

3. Use [▲] and [▼] to select “Mass Storage”, and then press [SET].

---

**4. Turn off the camera and then use the USB cable that comes with the camera to connect it to your computer.**

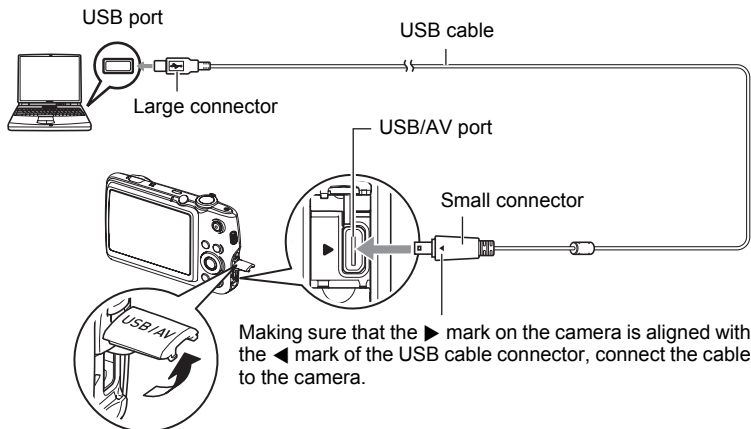

- The camera does not draw power over the USB cable. Check the battery level before connecting and make sure it is not too low.
- Make sure that you insert the cable connector into the USB/AV port until you feel it click securely into place. Failure to insert the connector fully can result in poor communication or malfunction.
- Note that even while the connector is fully inserted, you still will be able to see the metal part of the connector as shown in the illustration.
- When connecting the USB cable to a USB port, make sure you align the connector correctly with the port.
- Your computer may not be able to recognize the camera if you connect via a USB hub. Always connect directly to the computer's USB port.

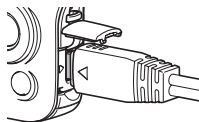

---

**5. Turn on the camera.**

---

**6. Windows Vista users: Click “Start” and then “Computer”.**  
**Windows XP users: Click “Start” and then “My Computer”.**  
**Windows 2000 users: Doubleclick “My Computer”.**

---

**7. Double-click “Removable Disk”.**

- Your computer recognizes the memory card loaded in the camera (or built-in memory if there is no card) as a removable disk.
- 

**8. Right-click the “DCIM” folder.**

---

**9. On the shortcut menu that appears, click “Copy”.**

---

**10. Windows Vista users: Click “Start” and then “Documents”.**  
**Windows XP users: Click “Start” and then “My Documents”.**  
**Windows 2000 users: Doubleclick “My Documents” to open it.**

- If you already have a “DCIM” folder in “My Documents”, the next step will overwrite it. If you want to keep the existing “DCIM” folder, you need to change its name or move it to a different location before performing the next step.
- 

**11. On the “My Documents” “Edit” menu, select “Paste”.**

This will paste the “DCIM” folder (and all the image files it contains) into your “My Documents” folder. You now have a copy of the files that are in camera memory on your computer.

---

**12. After you finish copying images, disconnect the camera from the computer.**

**Windows Vista, Windows XP**

On the camera, press [ON/OFF] to turn off the camera. After making sure that the back lamp is unlit, disconnect the camera from the computer.

**Windows 2000**

Click card services in the task tray on your computer screen, and disable the drive number assigned to the camera. Next, after making sure that the back lamp is unlit, press the camera’s [ON/OFF] button to turn off the camera and disconnect the camera from your computer.



## ■ To view images you copied to your computer

**1. Double-click the copied “DCIM” folder to open it.**

---

**2. Double-click the folder that contains the images you want to view.**

---

**3. Double-click the image file you want to view.**

- For information about file names, see “Memory Folder Structure” on page 142.
- An image that was rotated on the camera will be displayed on your computer screen in its original (unrotated) orientation.

**Never use your computer to modify, delete, move, or rename any image files that are in the camera’s built-in memory or on its memory card.**

Doing so can cause problems with the camera’s image management data, which will make it impossible to play back images on the camera and can drastically alter remaining memory capacity. Whenever you want to modify, delete, move, or rename an image, do so only on images that are stored on your computer.



### **IMPORTANT!**

- Never unplug the USB cable, or operate the camera while viewing or storing images. Doing so can cause data to become corrupted.

## Playing Movies

---

Windows Media Player, which is already installed on most computers, can be used for movie playback. To play back a movie, first copy the movie to your computer and then double-click the movie file.

### ■ Minimum Computer System Requirements for HD Movie Playback

The minimum system requirements described below are necessary to play back HD movies recorded with this camera on a computer.

Operating System : Vista / XP / 2000

CPU : Pentium 4, 3.2 GHz or higher

Required Software: Windows Media Player, DirectX 9.0c or higher

- The above are recommended system environments. Configuring one of these environments does not guarantee proper operation.
- Certain settings and other installed software may interfere with proper playback of movies.

### ■ Movie Playback Precautions

- Be sure to move the movie data to the hard disk of your computer before trying to play it. Proper movie playback may not be possible for data accessed over a network, from a memory card, etc.
- Proper movie playback may not be possible on some computers. If you experience problems, try the following.
  - Try recording movies with a quality setting of "STD".
  - Try upgrading Windows Media Player to the latest version.
  - Quit any other applications you have running, and stop resident applications.

Even if proper playback is not possible on the computer, you can use the AV cable that comes bundled with the camera to connect to the video input terminal a TV or computer and play back movies that way.

## Uploading Movie Files to YouTube

---

Installing YouTube Uploader for CASIO from the CD-ROM that comes with your camera simplifies uploading of movie files you recorded with the “For YouTube” scene to YouTube.

### ■ What is YouTube?

YouTube is a movie sharing site managed by YouTube, LLC where you can upload movies and view movies uploaded by others.

### ■ To install YouTube Uploader for CASIO

1. On the CD-ROM menu screen, select “YouTube Uploader for CASIO”.

---

2. After reading the information about installation conditions and system requirements for installation in the “Read me” file, install YouTube Uploader for CASIO.

### ■ To upload a movie file to YouTube

- Before you can use YouTube Uploader for CASIO, you need to go to the YouTube website (<http://www.youtube.com/>) and register as a user there.
- Do not upload any video that is copyrighted (including neighboring copyrights) unless you yourself own the copyright or you have obtained the permission of the applicable copyright holder(s).
- The maximum file size for each upload is 1024MB or 10 minutes of playing time.

1. Record the movie you want to upload using the “For YouTube” scene (page 61).

---

2. If it isn’t already, connect your computer to the Internet.

---

3. Connect the camera to your computer (page 126).

---

4. Turn on the camera.

YouTube Uploader for CASIO will start up automatically.

- If this is the first time you are using the application, configure the YouTube user ID and network environment settings, and then click the [OK] button.

---

**5. The left side of the display will have an area for inputting a title, category, and other information required for uploading to YouTube. Enter the required information.**

---

**6. The right side of the display shows a list of movie files in camera memory. Select the check box next to the movie file you want to upload.**

---

**7. When everything is ready, click the [Upload] button.**

This will upload the movie file(s) to YouTube.

- After uploading is complete, click the [Exit] button to exit the application.

---

## **Viewing User Documentation (PDF Files)**

---

**1. Start up your computer, and place the bundled CD-ROM into its CD-ROM drive.**

Normally, this should cause the menu screen to appear automatically. If your computer does not display the menu screen automatically, navigate to the CD-ROM on your computer and then double-click the "AutoMenu.exe" file.

---

**2. On the menu screen, click the "Language" down arrow button and then select the language you want.**

---

**3. Click "Manual" to select it and then click "Digital Camera".**

---



### **IMPORTANT!**

- You must have Adobe Reader or Adobe Acrobat Reader installed on your computer in order to view the contents of a PDF file. If you do not already have Adobe Reader or Adobe Acrobat Reader installed, install Adobe Reader from the bundled CD-ROM.

## Transferring Images from Your Computer to Camera Memory

---

If you want to transfer images from your computer to the camera, install Photo Transport on your computer from the CD-ROM that comes with the camera.

### ■ To install Photo Transport

1. On the CD-ROM menu screen, select “Photo Transport”.

---

2. After reading the information about installation conditions and system requirements for installation in the “Read me” file, install Photo Transport.

### ■ To transfer images to the camera

1. Connect the camera to your computer (page 126).

---

2. On your computer, click the following: Start → All Programs → CASIO → Photo Transport.  
This starts up Photo Transport.

---

3. Drag the file(s) you want to transfer to the [Transfer] button.

---

4. Follow the instructions that appear on the display to complete the transfer.
  - The details of the instructions that appear on the display and the transferred images will depend on your Photo Transport setup. For details, click the [Settings] button or [Help] button and check the setup.

### Transfer Data

- Only image files with the following extensions can be transferred to the camera: jpg, jpeg, jpe, bmp (bmp images are converted to jpeg image automatically when transferred.)
- Certain types of images may not be able to be transferred.
- You cannot transfer movies to the camera.

## ■ To transfer computer screen captures to the camera

### 1. Connect the camera to your computer (page 126).

---

### 2. On your computer, click the following: Start → All Programs → CASIO → Photo Transport.

This starts up Photo Transport.

---

### 3. Display the screen whose screen capture you want to transfer.

---

### 4. Click the [Capture] button.

---

### 5. Draw a boundary around the area you want to capture.

Move your mouse pointer to the upper left corner of the area you want to capture and then hold down the mouse button. Keeping the mouse button depressed, drag the pointer down to the lower right corner of the area and then release the mouse button.

---

### 6. Follow the instructions that appear on the display.

This will send an image of the area you selected to the camera.

- The transfer operation converts screen captures to JPEG format.
- The instructions that appear on the display and details about the transferred images will depend on your Photo Transport setup. For details, click the [Settings] button or [Help] button and check the setup.

## ■ About settings and help

Click the [Settings] button when you want to change the Photo Transport setup. For help about operation procedures and troubleshooting, click the Photo Transport [Help] button.

## || User Registration

---

You can perform user registration over the Internet. To do so, of course, you need to be able to connect to the Internet with your computer.

### 1. On the CD-ROM menu screen, click the “Register” button.

- This starts up your Web browser and accesses the user registration website. Follow the instructions that appear on your computer screen to register.

## Using the Camera with a Macintosh

Install the required software in accordance with what version of the Macintosh OS you are running and what you want to do.

When you want to do this:	Operating System Version	Install this software:	See page:
Save images to your Macintosh and view them there manually	OS 9	Installation not required.	135
	OS X		
Save images to your Macintosh automatically/Manage images	OS 9	Use commercially available software.	138
	OS X	Use iPhoto, which comes bundled with your operating system.	
Play movies	OS 9 / OS X	You can playback with QuickTime, which comes bundled with your operating system.	138

## Connecting the Camera to Your Computer and Saving Files



### IMPORTANT!

- The camera does not support operation with Mac OS 8.6 or earlier, or Mac OS X 10.0. Operation is supported with Mac OS 9, X (10.1, 10.2, 10.3, 10.4, 10.5) only. Use the standard USB driver that comes with your supported operating system.

### ■ To connect the camera to your computer and save files

1. Turn on the camera and press **[MENU]**.

---

2. On the “Set Up” tab, select “USB” and then press **[▶]**.

---

3. Use **[▲]** and **[▼]** to select “Mass Storage”, and then press **[SET]**.

---

#### 4. Turn off the camera and then use the USB cable that comes with the camera to connect it to your Macintosh.

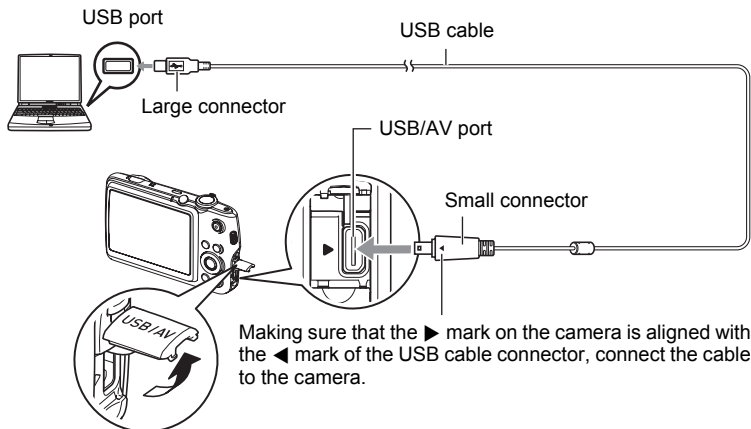

- The camera does not draw power over the USB cable. Check the battery level before connecting and make sure it is not too low.
- Make sure that you insert the cable connector into the USB/AV port until you feel it click securely into place. Failure to insert the connector fully can result in poor communication or malfunction.
- Note that even while the connector is fully inserted, you still will be able to see the metal part of the connector as shown in the illustration.
- When connecting the USB cable to a USB port, make sure you align the connector correctly with the port.
- Your computer may not be able to recognize the camera if you connect via a USB hub. Always connect directly to the computer's USB port.

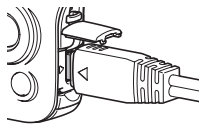

---

#### 5. Turn on the camera.

The camera's back lamp will light green at this time. In this mode, your Macintosh recognizes the memory card loaded in the camera (or the camera's built-in memory if it does not have a memory card loaded) as a drive. The appearance of the drive icon depends on the Mac OS version you are using.



- 
6. Double-click the camera's drive icon.
  7. Drag the "DCIM" folder to the folder to which you want to copy it.
  8. After the copy operation is complete, drag the drive icon to Trash.
  9. On the camera, press [ON/OFF] to turn off the camera. After making sure that the green back lamp is unlit, disconnect the camera from the computer.

■ **To view copied images**

- 
1. Double-click the camera's drive icon.
  2. Double-click the "DCIM" folder to open it.
  3. Double-click the folder that contains the images you want to view.
  4. Double-click the image file you want to view.
    - For information about file names, see "Memory Folder Structure" on page 142.
    - An image that was rotated on the camera will be displayed on your Macintosh screen in its original (unrotated) orientation.

**Never use your computer to modify, delete, move, or rename any image files that are in the camera's built-in memory or on its memory card.**

Doing so can cause problems with the camera's image management data, which will make it impossible to play back images on the camera and can drastically alter remaining memory capacity. Whenever you want to modify, delete, move, or rename an image, do so only on images that are stored on your computer.

 **IMPORTANT!**

- Never unplug the USB cable, or operate the camera while viewing or storing images. Doing so can cause data to become corrupted.

## Transferring Images Automatically and Managing Them on Your Macintosh

---

If you are running Mac OS X, you can use the iPhoto application that comes bundled with the operating system to manage your images. If you are running Mac OS 9, you will need to use commercially available software.

## Playing a Movie

---

You can use QuickTime, which comes bundled with your operating system, to play back movies on a Macintosh. To play back a movie, first copy it to your Macintosh and then double-click the movie file.

### ■ Minimum Computer System Requirements for HD Movie Playback

The minimum system requirements described below are necessary to play back HD movies recorded with this camera on a computer.

Operating System : Mac OS X 10.3.9 or higher

Required Software : QuickTime 7 or higher

- The above are recommended system environments. Configuring one of these environments does not guarantee proper operation.
- Certain settings and other installed software may interfere with proper playback of movies.

### ■ Movie Playback Precautions

Proper movie playback may not be possible on some Macintosh models. If you experience problems, try the following.

- Change the movie image quality setting to “STD”.
- Upgrade to the latest version of QuickTime.
- Shut down other applications that are running.

Even if proper playback is not possible on your Macintosh, you can use the AV cable that comes bundled with the camera to connect to the video input terminal a TV or Macintosh and play back movies that way.

### **IMPORTANT!**

- Be sure to move the movie data to the hard disk of your Macintosh before trying to play it. Proper movie playback may not be possible for data accessed over a network, from a memory card, etc.

## Viewing User Documentation (PDF Files)

---

You must have Adobe Reader or Adobe Acrobat Reader installed on your computer in order to view the contents of a PDF file. If you don't, go to the Adobe Systems Incorporated website and install Acrobat Reader.

- 1. On the CD-ROM, open the “Manual” folder.**
- 2. Open the “Digital Camera” folder and then open the folder for the language whose user’s guide you want to view.**
- 3. Open the file named “camera\_xx.pdf”.**
  - “xx” is the language code (Example: camera\_e.pdf is for English.)

## User Registration

---

Internet registration only is supported. Visit the following CASIO website to register:  
<http://world.casio.com/qv/register/>

## Using an Eye-Fi Wireless SD Memory Card to Transfer Images (Eye-Fi)

Shooting with an Eye-Fi wireless SD memory card loaded in the camera makes it possible to transfer image data automatically to a computer via wireless LAN.

- 1. Configure LAN access point, transfer destination and other settings for the Eye-Fi card in accordance with the instructions that come with the Eye-Fi card.**
- 2. After configuring settings, load the Eye-Fi card into the camera and record.**

Images you record are sent by wireless LAN to your computer, etc.

- For full details, see the user documentation that comes with the Eye-Fi card.
- Before formatting a new Eye-Fi card to use it for the first time, copy the Eye-Fi Manager install files to your computer. Do this before formatting the card.

### **IMPORTANT!**

- Recorded images are transferred over wireless LAN. Do not use the Eye-Fi card or turn off Eye-Fi card communication (page 144) when on an aircraft or in any other location where use of wireless communication is limited or prohibited.
- Loading an Eye-Fi card will cause the Eye-Fi indicator  to appear on the monitor screen. Its transparent or not transparent appearance indicates the communication status as shown below.



<b>Transparent</b>	Access point cannot be found or no transferable image data exists.
<b>Not transparent</b>	Image transfer in progress

- A communication icon  will appear on the monitor screen while image data transfer is in progress.
- The camera's Auto Power Off (page 149) function is disabled while image data transfer is in progress.
- A confirmation message will appear on the monitor screen if you try to turn off the camera while image data transfer is in progress. Follow the instructions in the messages (page 174).
- Transfer of a large number of images can take some time to complete.
- The original images remain on the Eye-Fi card after the image data transfer.
- Recording a movie to an Eye-Fi card may result in movie frames being dropped.
- Proper Eye-Fi card data communication may not be possible due to camera settings, battery level, or operating conditions.

## Files and Folders

The camera creates a file each time you shoot a snapshot, record a movie, or perform any other operation that stores data. Files are grouped by storing them in folders. Each file and folder has its own unique name.

- For details about how folders are organized in memory, see “Memory Folder Structure” (page 142).

Name and Maximum Number Allowed	Example
<b>File</b>	
Each folder can contain up to 9999 files named CIMG0001 through CIMG9999. The extension on the file name depends on the file type.	26th file name:  CIMG0026.JPG          Serial number Extension (4 digits)
<b>Folders</b>	
Folders are named from 100CASIO to 999CASIO There can be up to 900 folders in memory. <ul style="list-style-type: none"><li>• BEST SHOT has a scene named “For YouTube” that optimizes movie settings for recording movies for upload to YouTube. Images recorded with the YouTube scene are stored in a folder named “100YOUTB”.</li></ul>	100th folder name:  100CASIO   Serial number (3 digits)

- You can view folder and file names on your computer. For details about how file names are displayed on the camera’s monitor screen, see pages 12 and 13.
- The total number of folders and files allowed depends on the image size and quality, and capacity of the memory card being used for storage.

## Memory Card Data

The camera stores images you shoot in accordance with the Design Rule for Camera File System (DCF).

### ■ About DCF

DCF is a standard that makes it possible to view and print images recorded on one manufacturer's camera on DCF-compliant devices produced by other manufacturers. You can transfer DCF-compliant images recorded with another camera to this camera and view them on this camera's monitor screen.

### ■ Memory Folder Structure

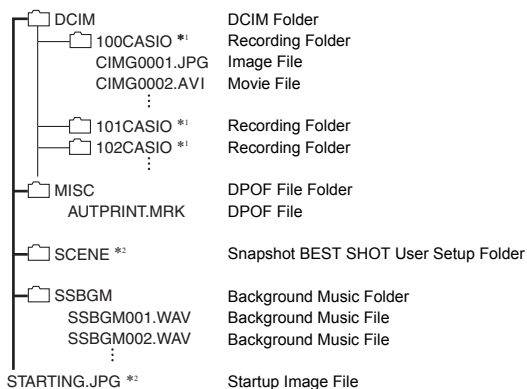

\*1 The BEST SHOT "For YouTube" scene sets up the camera for recording movies that are optimized for uploading to YouTube. Images recorded with the "For YouTube" scene are stored in a folder named "100YOUTB".

\*2 This folder or file can be created in built-in memory only.

## ■ Supported Image Files

- Image files shot with this camera
- DCF-compliant image files

This camera may not be able to display an image, even if it is DCF-compliant. When displaying an image recorded on another camera, it may take a long time for the image to appear on this camera's monitor screen.

## ■ Built-in Memory and Memory Card Data Handling Precautions

- Whenever copying memory contents to your computer, you should copy the DCIM folder and all of its contents. A good way to keep track of multiple DCIM folders is to change their names to dates or something similar after you copy them to your computer. If you later decided to return a DCIM folder to the camera, however, be sure to change its name back to DCIM. The camera is designed to recognize only a root file with the name DCIM. Note the camera also will not be able to recognize the folders inside the DCIM folder unless they have the names they originally had when you copied them from the camera to your computer.
- Folders and files must be stored in accordance with the "Memory Folder Structure" shown on page 142 in order for the camera to be able to recognize them correctly.
- You also can use a PC card adapter or a memory card reader/writer to access camera files directly from the camera's memory card.

## Other Settings (Set Up)

This section explains menu items that you can use to configure settings and perform other operations in both the REC mode and PLAY mode.

For information about menu operations, see page 77.

### Adjusting Monitor Screen Brightness (Screen)

#### Procedure

[MENU] → Set Up Tab → Screen

<b>Auto 2/ Auto 1</b>	With this setting, the camera detects available light levels and automatically adjusts the brightness of the monitor screen accordingly. "Auto 2" changes monitor screen brightness relatively more quickly than "Auto 1" when surrounding light is bright.
<b>+2</b>	Brightness that is greater than +1, which makes the screen easier to view. This setting consumes more power.
<b>+1</b>	Bright setting for outdoor use, etc. Brightness that is greater than 0.
<b>0</b>	Normal monitor screen brightness for indoor use, etc.

### Turning off Eye-Fi Card Communication (Eye-Fi)

#### Procedure

[MENU] → Set Up Tab → Eye-Fi



Select "Off" to disable Eye-Fi card communication (page 140).



## Configuring Camera Sound Settings (Sounds)

### Procedure

[MENU] → Set Up Tab → Sounds

<b>Startup</b>	
<b>Half Shutter</b>	Specifies the startup sound
<b>Shutter</b>	Sound 1 - 5: Built-in sounds (1 through 5) Off: Sound off
<b>Operation</b>	
 <b>Operation</b>	Specifies the sound volume. This setting is also used as the audio level during video output (page 151).
 <b>Play</b>	Specifies the volume of movie audio output. This volume setting is not used during video output (from the USB/AV port) (page 150).

- Setting a volume level of 0 mutes output.

## Specifying the File Name Serial Number Generation Rule (File No.)

### Procedure

[MENU] → Set Up Tab → File No.

Use the following procedure to specify the rule that governs generation of the serial number used in file names (page 141).

<b>Continue</b>	Tells the camera to remember the last used file number. A new file will be named using the next sequential number, even if files are deleted or if a blank memory card is loaded. If a memory card is loaded and that card already has files stored on it and the largest sequential number in the existing file names is greater than the largest sequential number remembered by the camera, numbering of new files will start from the largest sequential number in the memory card file names plus 1.
<b>Reset</b>	Restarts the serial number from 0001 whenever all files are deleted or when the memory card is replaced with a blank one. If a memory card is loaded and that card already has files stored on it, numbering of new files will start from the largest sequential number in the memory card file names plus 1.

## Configuring World Time Settings (World Time)

### Procedure

#### [MENU] → Set Up Tab → World Time

You can use the World Time screen to view the current time in a zone that is different from your Home City when you go on a trip, etc. World Time displays the current time in 162 cities in 32 time zones around the globe.

**1. Use [▲] and [▼] to select “World” and then press [▶].**

- To change the geographic area and city for the time where you normally use the camera, select “Home”.

**2. Use [▲] and [▼] to select “City” and then press [▶].**

- To change the “World” setting to summer time, use [▲] and [▼] to select “DST” and then select “On”. Summer time is used in some geographical areas to advance the current time setting by one hour during the summer months.

**3. Use [▲], [▼], [◀], and [▶] to select the geographic area you want and then press [SET].**

**4. Use [▲] and [▼] to select the city you want and then press [SET].**

**5. Press [SET].**



#### **IMPORTANT!**

- Before configuring World Time settings, make sure that the Home City setting is the place where you live or normally use the camera. If it isn't, select “Home” on the screen in step 1 and configure the Home City, date, and time settings as required (page 147).

## Time Stamping Snapshots (Timestamp)

### Procedure

#### [MENU] → Set Up Tab → Timestamp

You can configure the camera to stamp the recording date only, or date and time in the lower right corner of each snapshot.

- Once date and time information is stamped into a snapshot, it cannot be edited or deleted.

Example: December 30, 2009, 1:25 p.m.

<b>Date</b>	2009/12/30
<b>Date&amp;Time</b>	2009/12/30 1:25pm
<b>Off</b>	No stamping of date and/or time

- Even if you do not stamp the date and/or time with Timestamp, you can do so later using the DPOF function or some printing application (page 123).
- Stamping is performed in accordance with the date and time settings (page 147) and the display style settings (page 148).

## Setting the Camera's Clock (Adjust)

### Procedure

#### [MENU] → Set Up Tab → Adjust

<b>[▲] [▼]</b>	Change the setting at the cursor location
<b>[◀] [▶]</b>	Move the cursor between settings
<b>[BS]</b>	Toggles between 12-hour and 24-hour format

When the date and time settings are what you want, select "Apply" and then press [SET] to apply them.

- You can specify a date from 2001 to 2049.
- Be sure to select your Home City (page 146) before setting the time and date. If you set the time and date while the wrong city is selected for your Home City, the times and dates of all of the World Time cities (page 146) will be wrong.

## Specifying the Date Style (Date Style)

### Procedure

[MENU] → Set Up Tab → Date Style

You can select from among three different styles for the date.

Example: December 30, 2009

YY/MM/DD	09/12/30
DD/MM/YY	30/12/09
MM/DD/YY	12/30/09

- This setting also affects the control panel date format as shown below (page 31).  
YY/MM/DD or MM/DD/YY: MM/DD  
DD/MM/YY: DD/MM

## Specifying the Display Language (Language)

### Procedure

[MENU] → Set Up Tab → Language

#### ■ Specify the display language you want.

- ① Select the tab on the right.
- ② Select "Language".
- ③ Select the language you want.



## Configuring Sleep State Settings (Sleep)

### Procedure

**[MENU] → Set Up Tab → Sleep**

This feature turns off the monitor screen whenever no camera operation is performed for a preset amount of time. Press any button to turn the monitor screen back on.

Trigger Time Settings: 30 sec, 1 min, 2 min, Off (Sleep is disabled while "Off" is selected.)

- Sleep is disabled under any of the following conditions.
  - In the PLAY mode
  - While the camera is connected to a computer or other device
  - During a slideshow
  - During movie recording and playback
  - During Move Out CS or Move In CS auto record standby
  - When both sleep and Auto Power Off are turned on, Auto Power Off takes priority.

## Configuring Auto Power Off Settings (Auto Power Off)

### Procedure

**[MENU] → Set Up Tab → Auto Power Off**

Auto Power Off turns off the camera whenever no camera operation is performed for a preset amount of time.

Trigger Time Settings: 2 min, 5 min, 10 min (The trigger time is always 5 minutes in the PLAY mode.)

- Auto Power Off is disabled under any of the following conditions.
  - While the camera is connected to a computer or other device
  - During a slideshow
  - During CS group playback
  - During movie recording and playback
  - During Move Out CS or Move In CS auto record standby

## Configuring [📷] and [▶] Settings (REC/PLAY)

### Procedure

[MENU] → Set Up Tab → REC/PLAY

<b>Power On</b>	Camera turns on whenever [📷] (REC) or [▶] (PLAY) is pressed.
<b>Power On/Off</b>	Camera turns on or off whenever [📷] (REC) or [▶] (PLAY) is pressed.
<b>Disable</b>	Camera does not turn on or off when [📷] (REC) or [▶] (PLAY) is pressed.

- With “Power On/Off”, the camera turns off when you press [📷] (REC) in the REC mode or [▶] (PLAY) in the PLAY mode.
- Change this setting to “Power On” or “Power On/Off” before connecting to a TV for image viewing.

## Configuring USB Protocol Settings (USB)

### Procedure

[MENU] → Set Up Tab → USB

You can use the procedure below to select the USB communication protocol, which is used when exchanging data with a computer, printer, or other external device.

<b>Mass Storage</b>	Select this setting when connecting to a computer (pages 126, 135). With this setting, the computer sees the camera as an external storage device. Use this setting for normal transfer of images from the camera to a computer.
<b>PTP (PictBridge)</b>	Select this setting when connecting to a printer that supports PictBridge (page 117). This setting simplifies the transfer of image data to the connected device.

## Selecting the Screen Aspect Ratio and Video Output System (Video Out)

### Procedure

#### [MENU] → Set Up Tab → Video Out

You can use the procedure in this section to select either NTSC or PAL as the video output system. You can also specify an aspect ratio of 4:3 or 16:9.

<b>NTSC</b>	Video system used in Japan, the U.S., and other countries
<b>PAL</b>	Video system used in Europe and other areas
<b>4:3</b>	Normal TV screen aspect ratio
<b>16:9</b>	Wide screen aspect ratio

- Select the aspect ratio (4:3 or 16:9) that matches the type of TV you plan to use. Images will not display correctly if you select the wrong aspect ratio.
- Images will not display correctly unless the camera's video signal output setting matches the video signal system of the TV or other video equipment.
- Images cannot be displayed correctly on a TV or video equipment that is not NTSC or PAL.

## Configuring a Startup Image (Startup)

### Procedure

#### [MENU] → Set Up Tab → Startup

Display the image you want to use as your startup image and then select "On".

- The startup image does not appear when you turn on the camera by pressing [▶] (PLAY).
- You can specify a snapshot you recorded as the startup image, or you can use the special startup image provided in the camera's built-in memory.
- Formatting built-in memory (page 152) will delete the current startup image setting.
- You can select the first snapshot of a CS group as the startup image. If you want to select another image within a CS group, you need to first divide up the CS group or use the CS Frame Edit feature to make a copy of the image outside of the CS group.

## Formatting Built-in Memory or a Memory Card (Format)

### Procedure

#### [MENU] → Set Up Tab → Format

If a memory card is loaded in the camera, this operation will format the memory card. It will format built-in memory if no memory card is loaded.

- The format operation will delete all contents on the memory card or in built-in memory. It cannot be undone. Make sure you do not need any data currently on the card or in built-in memory before you format it.
- Formatting built-in memory will delete the following data.
  - Protected images
  - BEST SHOT user setups
  - Startup screen
- Formatting a memory card will delete the following data.
  - Protected images
- Check the battery level before starting a format operation and make sure it is not too low. Formatting may not be performed correctly and the camera may stop operating normally if the camera powers down while formatting is in progress.
- Never open the battery cover while formatting is in progress. Doing so can cause the camera to stop operating normally.

## Resetting the Camera to Factory Defaults (Reset)

### Procedure

#### [MENU] → Set Up Tab → Reset

See page 167 for details about the camera's factory default settings.

The settings below are not reset.

World Time settings, clock settings, date style, screen language, video output



# Configuring Monitor Screen Settings

## Turning Display Information On and Off (Info)

Each press of [▲] (DISP) will cycle through display settings that display or hide on-screen information and the control panel. You can configure separate settings for the REC mode and PLAY mode.

<b>Information on, control panel on</b>	Displays setting information and the control panel.
<b>Information on, control panel on, histogram on</b>	Displays setting information and the control panel, and a histogram (page 153) on the left side of the display. Also displays the remaining movie recording time in place of the remaining snapshot capacity, as well as a movie image quality icon.
<b>Information off, control panel off</b>	Hides setting information and the control panel.



Histogram

- The control panel is not displayed and display information settings cannot be changed during movie recording.

## Using the On-screen Histogram to Check Exposure (+Histogram)

Displays a histogram on the monitor screen which you can use to check the exposure of an image before you shoot it. You also can display the histogram in the PLAY mode for information about the exposure levels of images.



Histogram

### NOTE

- A centered histogram does not necessarily guarantee optimum exposure. The recorded image may be over-exposed or under-exposed, even though its histogram is centered.
- Due to the limitations of exposure compensation, you may not be able to achieve an optimum histogram configuration.
- Use of the flash and certain shooting conditions can cause the histogram to indicate exposure that is different from the actual exposure of the image when it is shot.
- The histogram cannot be displayed during high speed movie recording.

## How to Use the Histogram

A histogram is a graph that represents the lightness of an image in terms of the number of pixels. The vertical axis indicates the number of pixels, while the horizontal axis indicates lightness. If the histogram appears too lopsided for some reason, you can use EV shift to move it left or right in order to achieve better balance. Optimum exposure can be achieved by EV shifting so the graph is as close to the center as possible. For snapshots, you can even display individual histograms for R (red), G (green), and B (blue).

### Example Histograms

A histogram towards the left side results when the overall image is dark. A histogram that is too far to the left may result in “black out” of the dark areas of an image.



A histogram towards the right side results when the overall image is light. A histogram that is too far to the right may result in “white out” of the light areas of an image.



An overall well-balanced histogram results when the overall image is at optimal lightness.



## Precautions during Use

### ■ Avoid Use While In Motion

- Never use the camera to record or play back images while operating an automobile or other vehicle, or while walking. Looking at the monitor while in motion creates the risk of serious accident.

### ■ Flash

- Never use the flash unit in areas where flammable or explosive gas may be present. Such conditions create the risk of fire and explosion.
- Never fire the flash in the direction of a person operating a motor vehicle. Doing so can interfere with the driver's vision and creates the risk of accident.
- Never fire the flash too close to the eyes of the subject. Doing so creates the risk of loss of eyesight.

### ■ Monitor Screen

- Should the monitor screen ever become cracked, never touch any of the liquid inside the monitor screen. Doing so creates the risk of skin inflammation.
- Should monitor screen liquid ever get into your mouth, immediately rinse your mouth out and contact your physician.
- Should monitor screen liquid ever get into your eyes or onto your skin, immediately rinse with clean water for at least 15 minutes and contact your physician.

### ■ Connections

- Never plug any devices that are not specified for use with this camera into connectors. Connecting a non-specified device creates the risk of fire and electric shock.

### ■ Transport

- Never operate the camera inside of an aircraft or anywhere else where operation of such devices is restricted. Improper use creates the risk of serious accident.

### ■ **Smoke, abnormal odor, overheating, and other abnormalities**

- Continued use of the camera while it is emitting smoke or strange odor, or while it is overheating creates the risk of fire and electric shock. Immediately perform the following steps whenever any of the above symptoms are present.
  1. Turn off the camera.
  2. Remove the battery from the camera, taking care to protect yourself against burn injury.
  3. Contact your dealer or nearest CASIO authorized service center.

### ■ **Water and Foreign Matter**

- Water, other liquids, or foreign matter (especially metal) getting inside the camera creates the risk of fire and electric shock. Immediately perform the following steps whenever any of the above symptoms are present. Particular care is required when using the camera where it is raining or snowing, near the ocean or other body of water, or in a bathroom.
  1. Turn off the camera.
  2. Remove the battery from the camera.
  3. Contact your dealer or nearest CASIO authorized service center.

### ■ **Dropping and Rough Treatment**

- Continued use of the camera after it is damaged by dropping or other rough treatment creates the risk of fire and electric shock. Immediately perform the following steps whenever any of the above symptoms are present.
  1. Turn off the camera.
  2. Remove the battery from the camera.
  3. Contact your dealer or nearest CASIO authorized service center.

### ■ **Keep Away From Fire**

- Never expose the camera to fire, which can cause it to explode and creates the risk of fire and electric shock.

### ■ **Disassembly and Modification**

- Never try to take the camera apart or modify it in any way. Doing so creates the risk of electric shock, burn injury, and other personal injury. Be sure to leave all internal inspection, maintenance, and repair up to your dealer or nearest CASIO authorized service center.

## ■ Locations To Be Avoided

- Never leave the camera in any of the following types of locations. Doing so creates the risk of fire and electric shock.
  - Areas subject to large amounts of humidity or dust
  - Food preparation areas or other locations where oil smoke is present
  - Near heaters, on a heated carpet, in areas exposed to direct sunlight, in a closed vehicle parked in the sun, or other areas subject to very high temperatures
- Never place the camera on an unstable surface, on a high shelf, etc. Doing so can cause the camera to fall, creating the risk of personal injury.

## ■ Backing Up Important Data

- Always keep backup copies of important data in camera memory by transferring it to a computer or other storage device. Note that data can be deleted in the case of camera malfunction, repair, etc.

## ■ Memory Protection

- Whenever replacing the battery, be sure to follow the correct procedure as described in the documentation that comes with the camera. Incorrectly replacing the battery can result in corruption or loss of data in camera memory.

## ■ Rechargeable Battery

- Use only the specified charger unit or the specified device to charge the battery. Attempting to charge the battery by an unauthorized means creates the risk of battery overheating, fire, and explosion.
- Do not expose or immerse the battery in fresh water or salt water. Doing so can damage the battery, and cause deterioration of its performance and loss of service life.
- The battery is intended for use with a CASIO Digital Camera only. Use with any other device creates the risk of the battery damage, or deterioration of battery performance and service life.
- Failure to observe any of the following precautions creates the risk of battery overheating, fire, and explosion.
  - Never use or leave the battery near open flame.
  - Do not expose the battery to heat or fire.
  - Make sure the battery is oriented correctly when it is connected to the charger unit.
  - Never carry or store the battery together with items that can conduct electricity (necklaces, pencil lead, etc.)
  - Never disassemble the battery, pierce it with a needle, or expose it to strong impact (hit it with a hammer, step on it, etc.), and never apply solder to it. Never place the battery into a microwave oven, heater, high-pressure generating device, etc.
- Should you ever notice leakage, strange odor, heat generation, discoloration, deformation, or any other abnormal condition while using, charging, or storing a battery, immediately remove it from the camera or charger unit and keep it away from open flame.

- Do not use or leave the battery under direct sunlight, in an automobile parked in the sun, or in any other area subject to high temperatures. Doing so can damage the battery, and cause deterioration of its performance and loss of service life.
- If battery charging does not end normally within the specified charging time, stop charging anyway and contact your local CASIO authorized service center. Continued charging creates the risk of battery overheating, fire, and explosion.
- Battery fluid can damage your eyes. Should battery fluid get into your eyes accidentally, immediately rinse them with clean tap water and then consult a physician.
- Be sure to read the user documentation that comes with the camera and special charger unit before using or charging the battery.
- If a battery is to be used by young children, make sure that a responsible adult makes them aware of the precautions and proper handling instructions, and make sure that they handle the battery correctly.
- Should fluid from a battery accidentally get onto clothing or your skin, immediately rinse it off with clean tap water. Prolonged contact with battery fluid can cause skin irritation.

## ■ Battery Life

- Battery continuous operation times provided in this manual represent the approximate amount of time before the camera turns off due to low battery power when being powered by the special battery under normal temperature (23°C (73°F)). They do not guarantee that you will be able to achieve the indicated level of operation. Actual battery life is greatly affected by ambient temperature, battery storage conditions, the amount of time spent in storage, etc.
- Leaving the camera on can run down the battery and cause the low battery warning to appear. Turn off the camera whenever you are not using it.
- The low battery warning indicates that the camera is about to turn off due to low battery power. Charge the battery as soon as possible. Leaving a low or dead battery in the camera can lead to battery leakage and data corruption.

## ■ Data Error Precautions

Your digital camera is manufactured using precision digital components. Any of the following creates the risk of corruption of data in camera memory.

- Removing the battery or memory card while the camera is performing some operation
- Removing the battery or memory card while the back lamp is flashing green after turning off the camera
- Disconnecting the USB cable while communication is in progress
- Using a battery that is low
- Other abnormal operations

Any of the above conditions can cause an error message to appear on the monitor screen (page 174). Perform the action indicated by the message that appears.

## ■ Operating Environment

- Operating Temperature: 0 to 40°C (32 to 104°F)
- Operating Humidity: 10 to 85% (non condensation)
- Do not place the camera in any of the following locations.
  - In an area exposed to direct sunlight, or large amounts of moisture, dust, or sand.
  - Near an air conditioner or in other areas subjected to extreme temperature or humidity
  - Inside of a motor vehicle on a hot day, or in an area subjected to strong vibration

## ■ Condensation

Sudden and extreme temperature changes, such as when the camera is moved from the outdoors on a cold winter day into a warm room, can cause water droplets called “condensation” to form on the interior and the exterior of the camera, which creates the risk of malfunction. To prevent condensation from forming seal the camera in a plastic bag before changing locations. Then leave the bag sealed to allow the air inside to naturally change to the same temperature as the air in the new location. After that, remove the camera from the bag and open the battery cover for a few hours.

## ■ Lens

- Never apply too much force when cleaning the surface of the lens. Doing so can scratch the lens surface and cause malfunction.
- You may sometimes notice some distortion in certain types of images, such as a slight bend in lines that should be straight. This is due to the characteristics of lenses, and does not indicate malfunction of the camera.

## ■ Caring for your camera

- Never touch the lens or flash window with your fingers. Finger smudges, dirt, and other foreign matter on the lens or flash window can interfere with proper operation of the camera. Use a blower or other means to keep the lens and flash window free of dirt and dust, and wipe gently with a soft, dry cloth.
- To clean the camera, wipe it with a soft, dry cloth.

## ■ Old Rechargeable Battery Handling Precautions

- Insulate the positive and negative terminals with tape, etc.
- Do not peel the covering off of the battery.
- Do not try to take the battery apart.

## ■ Charger Unit Handling Precautions



- Never plug the power cord into an outlet whose voltage rating is different from that marked on the power cord. Doing so creates the risk of fire, malfunction, and electric shock.
  - Take care to protect the power cord against damage and breaking. Never place heavy objects onto the power cord, or expose it to intense heat. Doing so can damage the power cord, creating the risk of fire and electric shock.
  - Never try to modify the power cord, or subject it to severe bending, twisting, or pulling. Doing so creates the risk of fire, malfunction, and electric shock.
  - Never plug in or unplug the power cord while your hands are wet. Doing so creates the risk of electric shock.
  - Do not plug the power cord into an outlet or extension cord that is shared by other devices. Doing so creates the risk of fire, malfunction, and electric shock.
  - Should the power cord ever become damaged (to the point that internal wires are exposed or cut), immediately contact your original retailer or authorized CASIO authorized service center to request repair. Continued use of a damaged power cord creates the risk of fire, malfunction, and electric shock.
- The charger unit becomes slightly warm during charging. This is normal and does not indicate malfunction.
  - Unplug the power cord from the power outlet when you are not using the charger unit.
  - Never use detergent to clean the power cord (especially the plug).
  - Never cover the charger unit with a blanket, etc. Doing so creates the risk of fire.



## ■ Other Precautions

The camera becomes slightly warm during use. This is normal and does not indicate malfunction.

## ■ Copyrights

Except for your own personal enjoyment, unauthorized use of use of snapshots or movies of images whose rights belong to others, without the permission of the right holder, is forbidden by copyright laws. In some cases, shooting of public performances, shows, exhibitions, etc. may be restricted entirely, even if it is for your own personal enjoyment. Regardless of whether such files are purchased by you or obtained for free, posting them on a website, a file sharing site, or any other Internet site, or otherwise distributing them to third parties without the permission of the copyright holder is strictly prohibited by copyright laws and international treaties. For example, uploading or distributing on the Internet images of TV programs, live concerts, music videos, etc. that were photographed or recorded by you may infringe upon the rights of others. Note that CASIO COMPUTER CO., LTD. shall not be held liable for use of this product in any way that infringes on the copyrights of others or that violates copyright laws.

The following terms, which are used in this manual, are registered trademarks or trademarks of their respective owners.

Note that trademark ™ and registered trademark ® are not used within the text of this manual.

- The SDHC logo is a trademark.
- Microsoft, Windows, Internet Explorer, Windows Media, Windows Vista, and DirectX are registered trademarks or trademarks of Microsoft Corporation in the United States and other countries.
- Macintosh, Mac OS, QuickTime, and iPhoto are trademarks of Apple Inc.
- Adobe and Reader are trademarks or registered trademarks in the United States and other countries of Adobe Systems Incorporated.
- YouTube, the YouTube logo, and "Broadcast Yourself" are trademarks or registered trademarks of YouTube, LLC.
- EXILIM, Photo Transport, and YouTube Uploader for CASIO are registered trademarks or trademarks of CASIO COMPUTER CO., LTD.
- All other company or product names mentioned herein may be registered trademarks or trademarks of their respective companies.

Any and all unauthorized commercial copying, distribution, and copying of the bundled software over a network are prohibited.

This product contains PrKERNELv4 Real-time OS of eSOL Co., Ltd. Copyright © 2007 eSOL Co., Ltd.  
PrKERNELv4 is a registered trademark of eSOL Co., Ltd. in Japan.



This product's YouTube upload functionality is included under license from YouTube, LLC. The presence of YouTube upload functionality in this product is not an endorsement or recommendation of the product by YouTube, LLC.

## Power Supply

### Charging

#### **If the [CHARGE] lamp does not light red...**

Charging cannot be performed because ambient temperature or the temperature of the charger is too hot or too cold. Leave the camera in a location whose temperature is within the range where charging can be performed. When the camera returns to a temperature where charging can be performed, the [CHARGE] lamp will light red.

#### **If the [CHARGE] lamp flashes red...**

The battery is faulty or the battery is loaded in the charger incorrectly. Remove the battery from the charger and check if its contacts are dirty. If contacts become dirty, wipe them clean with a dry cloth. When experiencing charging problems, also check to make sure that the power cord is not disconnected from the power outlet or charger.

If problems continue to occur after you perform the above steps, it could mean that the battery is faulty. Contact your nearest CASIO authorized service center.

## To replace the battery

### 1. Open the battery cover and remove the current battery.

With the monitor screen side of the camera facing upwards, slide the stopper in the direction indicated by the arrow in the illustration. After the battery pops out, pull it the rest of the way out of the camera.

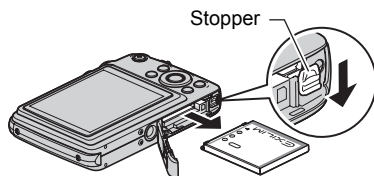

### 2. Load a new battery.

## Battery Precautions

### ■ Precautions during Use

- Operation provided by a battery under cold conditions is always less than operation under normal temperatures. This is due to the characteristics of the battery, not the camera.
- Charge the battery in an area where the temperature is within the range of 5°C to 35°C (41°F to 95°F). Outside this temperature range charging can take longer than normal or even fail.
- Do not tear or remove the battery outer label.
- If a battery provides only very limited operation following a full charge, it probably means the battery has reached the end of its service life. Replace the battery with a new one.

### ■ Storage Precautions

- Storing the battery for a long time while it is charged can cause deterioration of battery characteristics. If you do not plan to use a battery for some time, fully use up its charge before storing it.
- Always remove the battery from the camera when you are not using it. A battery left in the camera can discharge and go dead, which will require some time to charge when you need to use the camera.
- Store batteries in a cool, dry place (20°C (68°F) or lower).
- To prevent over discharging of an unused battery, fully charge it, and then load it in the camera and fully use up the charge about once every six months.

## Using the Camera in another Country

### ■ Precautions during Use

- The bundled charger is designed for operation with any power supply in the range of 100V to 240V AC, 50/60Hz. Note, however, that the shape of the power cord plug depends on each country or geographic area. Before taking the camera and charger along on a trip, check with travel agent about the power supply requirements in your destination(s).
- Do not connect the charger to a power supply through a voltage converter or similar device. Doing so can lead to malfunction.

### ■ Extra Batteries

- Taking along extra fully charged batteries (NP-60) is recommended while on a trip in order to avoid not being able to shoot images due to the battery going dead.

## Using a Memory Card

See page 20 for information about supported memory cards and how to load a memory card.

### To replace the memory card

Press the memory card and then release it. This will cause it to pop out of the memory card slot slightly. Pull the card out the rest of the way and then insert another one.

- Never remove a card from the camera while the back lamp is flashing green. Doing so can cause the image save operation to fail and even damage the memory card.

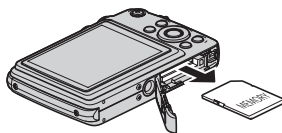

## ■ Using a Memory Card

- SD memory cards and SDHC memory cards have a write protect switch. Use the switch when you need to guard against accidentally deleting data. Note, however, if you write protect an SD memory card you must then turn write protection off whenever you want to record to it, format it, or delete any of its images.
- If a memory card starts to behave abnormally during image playback, you can restore normal operation by reformatting it (page 152). However, it is recommended that you always take along multiple memory cards whenever using the camera far away from the home or office.
- As you record data to and delete data from a memory card a number of times, it loses its ability to retain data. Because of this, periodic re-formatting of a memory card is recommended.
- Electrostatic charge, electrical noise, and other phenomena can cause data to become corrupted or even lost. Make sure that you always back up important data on other media (CD-R, CD-RW, hard disk, etc.)

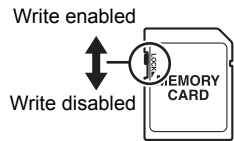

## ■ Discarding or Transferring Ownership of a Memory Card or the Camera

The format and delete functions of the camera do not actually delete files from the memory card. The original data remains on the card. Note that responsibility for the data on a memory card lies with you. The following procedures are recommended whenever you discard a memory card or the camera, or if you transfer ownership to another party.

- When discarding a memory card, either physically destroy the memory card or use commercially available data delete software to completely delete the data on the memory card.
- When transferring ownership of a memory card to another party, use commercially available data deletion software to completely delete the data on it.
- Use the format function (page 152) to completely delete the data in built-in memory before discarding or transferring ownership of the camera.

## Computer System Requirements for Bundled Software

Computer system requirements are different for each of the applications. Be sure to check the requirements for the particular application you are trying to use. Note that the values provided here are minimum requirements for running each application. Actual requirements are greater, depending on the number of images and the sizes of the images being handled.

### ● Windows

#### **YouTube Uploader for CASIO**

Operating System : Windows Vista / XP (SP2/SP3) / 2000 (SP4)

Other : Sufficient memory to run the operating system

Computer configuration that enables playback of movies on the YouTube site

Computer configuration that enables upload of movies to the YouTube site

#### **Photo Transport 1.0**

Operating System : Windows Vista / XP / 2000

Memory : At least 64MB

Hard Disk Drive Space : At least 2MB

#### **Adobe Reader 8**

Operating System : Windows Vista / XP (SP2/SP3) / 2000 (SP4)

CPU : Pentium III Class

Memory : At least 128MB

Hard Disk Drive Space : At least 180MB

Other : Internet Explorer 6.0 or higher installed

For details about the minimum system requirements for each software application, see the "Read me" files on the CASIO Digital Camera Software CD-ROM that comes bundled with the camera.

## Reset Initial Default Settings

The tables in this section show the initial default settings that are configured for menu items (displayed when you press [MENU]) after you reset the camera (page 152).

Menu items depend on whether the camera is in the REC mode or PLAY mode.

- A dash (–) indicates an item whose setting is not reset or an item for which there is no reset setting.

### ■ REC Mode

#### “REC” Tab

Focus	<b>AF</b> (Auto Focus)
Self-timer	Off
Anti Shake	Auto
AF Area	<b>Spot</b>
AF Assist Light	On
Face Detection	Off
Continuous AF	Off
CS	High Speed CS
Save CS Images	Always Ask
Digital Zoom	On
L/R Key	Off
Quick Shutter	On

Grid	Off
Review	On
Icon Help	On
Memory	<b>BS</b> BEST SHOT: Off / Flash: On / Focus: Off / AF Area: On / Metering: Off / CS: Off / Self-timer: Off / Flash Intensity: Off / Digital Zoom: On / MF Position: Off / Zoom Position: Off

#### “Quality” Tab

<b>Quality (Snapshots)</b>	Normal
<b>Quality (Movies)</b>	HD
HS <b>Speed</b>	210 fps
Metering	<b>Multi</b>
Lighting	Off

Flash Intensity	0
Color Filter	Off
Sharpness	0
Saturation	0
Contrast	0

## “Set Up” Tab

<b>Screen</b>	Auto 2
<b>Eye-Fi</b>	On
<b>Sounds</b>	Startup: Sound 1 / Half Shutter: Sound 1 / Shutter: Sound 1 / Operation: Sound 1 / ▶ Operation: ■■■□□□□ / ▶ Play: ■■■□□□□
<b>File No.</b>	Continue
<b>World Time</b>	Home
<b>Timestamp</b>	Off

<b>Adjust</b>	–
<b>Date Style</b>	–
<b>Language</b>	–
<b>Sleep</b>	1 min
<b>Auto Power Off</b>	5 min
<b>REC/PLAY</b>	Power On
<b>USB</b>	Mass Storage
<b>Video Out</b>	–
<b>Startup</b>	Off
<b>Format</b>	–
<b>Reset</b>	–

## ■ PLAY Mode

### “PLAY” Tab

<b>Slideshow</b>	Images: All images / Time: 30 min / Interval: 3 sec / Effect: Pattern 1
<b>MOTION PRINT</b>	9 frames
<b>Movie Editing</b>	–
<b>White Balance</b>	–
<b>Brightness</b>	–
<b>DPOF Printing</b>	–

<b>Protect</b>	–
<b>Rotation</b>	–
<b>Resize</b>	–
<b>Trimming</b>	–
<b>Copy</b>	–
<b>Divide Group</b>	–
<b>CS Frame Edit</b>	–

## “Set Up” Tab









- The contents of the “Set Up” tab are the same in the REC mode and PLAY mode.



## When things don't go right...

### Troubleshooting

Problem	Possible Cause and Recommended Action
<b>Power Supply</b>	
Power does not turn on.	<ol style="list-style-type: none"><li>1)The battery may not be loaded correctly (page 17).</li><li>2)The battery may be dead. Charge the battery (page 16). If the battery goes dead soon after being charged, it means the battery has reached the end of its life and needs to be replaced. Purchase a separately available CASIO NP-60 rechargeable lithium ion battery.</li></ol>
The camera suddenly powers down.	<ol style="list-style-type: none"><li>1)Auto Power Off may have activated (page 149). Turn power back on.</li><li>2)The battery may be dead. Charge the battery (page 16).</li><li>3)The camera's protection function may have activated because camera temperature is too high. Turn off the camera and wait until it cools down before trying to use it again.</li></ol>
Power will not turn off. Nothing happens when a button is pressed.	Remove the battery from the camera and then reload them.
<b>Image Recording</b>	
Image is not recorded when the shutter button is pressed.	<ol style="list-style-type: none"><li>1)If the camera is in the PLAY mode, press [RECORD] (REC) to enter the REC Mode.</li><li>2)If the flash is charging, wait until the charge operation finishes.</li><li>3)If the message "Memory Full" appears, transfer images to your computer, delete images you no longer need, or use a different memory card.</li></ol>
Auto Focus does not focus properly	<ol style="list-style-type: none"><li>1)If the lens is dirty, clean it off.</li><li>2)The subject may not be in the center of the focus frame when you compose the image.</li><li>3)The subject you are shooting may not be a type that is compatible with Auto Focus (page 30). Use manual focus (page 79).</li><li>4)You may be moving the camera when shooting. Try shooting with Anti Shake or use a tripod.</li><li>5)You may be pressing the shutter button all the way without waiting for Auto Focus. Half-press the shutter button and allow enough time for Auto Focus to focus.</li></ol>

Problem	Possible Cause and Recommended Action
The subject is out of focus in the recorded image.	The image may not be focused properly. When composing the image, make sure the subject is located inside the focus frame.
The flash does not fire.	<ol style="list-style-type: none"> <li>1) If  (Flash Off) is selected as the flash mode, change to another mode (page 42).</li> <li>2) If the battery is low, charge it (page 16).</li> <li>3) If a BEST SHOT scene that uses  (Flash Off) is selected, change to a different flash mode (page 42) or select a different BEST SHOT scene (page 63).</li> <li>4) If Lag Correction is turned on while shooting single shots, change the "Lag Correction" setting to " Off" (page 40).</li> </ol>
The  (Flash Off) icon flashes red on the monitor screen and the flash does not fire.	The flash unit may be malfunctioning. Contact a CASIO service center or your original retailer. Note that though the flash will not fire, you still can use the camera for non-flash shots.
Camera powers down during Self-timer countdown.	The battery may be low. Charge the battery.
The monitor screen image is out of focus.	<ol style="list-style-type: none"> <li>1) You may be using Manual Focus and have not focused the image. Focus the image (page 79).</li> <li>2) You may be using  (Macro) for scenery or portraits. Use Auto Focus for scenery and portrait shots (page 79).</li> <li>3) You may be trying to use Auto Focus or  (Infinity) when shooting a close-up shot. Use the  (Macro) for close ups (page 79).</li> </ol>
There is digital noise in images.	<ol style="list-style-type: none"> <li>1) Sensitivity may have been increased automatically for a dark subject, which increases the chance of digital noise. Use a light or some other means to illuminate the subject.</li> <li>2) You may be attempting to shoot in a dark location with  (Flash Off) selected, which can increase digital noise and make images appear coarse. In this case, turn on flash (page 42) or use lights for illumination.</li> </ol>
A recorded image was not saved.	<ol style="list-style-type: none"> <li>1) Camera power may have been turned off before the save operation was complete, which will result in the image not being saved. If the battery indicator shows , charge the battery as soon as possible (page 18).</li> <li>2) You may have removed the memory card from the camera before the save operation was complete, which will result in the image not being saved. Do not remove the memory card before the save operation is complete.</li> </ol>

Problem	Possible Cause and Recommended Action
Though available lighting is bright, the faces of people in the image are dark.	Not enough light is reaching the subjects. Change the flash mode setting to <b>[2]</b> (Flash On) for daylight synchro flash (page 42), or adjust EV shift to the + side (page 37).
Night shots come out bad.	Use the following BEST SHOT scenes (page 63) when shooting at night. <ul style="list-style-type: none"> <li>• High Speed Night Scene (for shooting night scenery only)</li> <li>• Night Scene Portrait (for shooting people against night scenery)</li> </ul>
Subjects are too dark when shooting images in a seashore or ski area.	Sunlight reflected by water, sand, or snow, can cause underexposure of images. Change the flash mode setting to <b>[2]</b> (Flash On) for daylight synchro flash (page 42), or adjust EV shift to the + side (page 37).
Digital zoom will not go up to the maximum value.	The digital zoom setting may be turned off. Turn on digital zoom (page 87).
The image is out of focus during movie recording.	<ol style="list-style-type: none"> <li>1) Focusing may not be possible because the subject is outside the focus range. Shoot within the allowable range.</li> <li>2) The lens may be dirty. Clean the lens (page 159).</li> <li>3) Focus is fixed during high speed movie recording.</li> </ol>

Problem	Possible Cause and Recommended Action
<b>Playback</b>	
The color of the playback image is different from what appears on the monitor screen when shooting.	Sunlight or light from another source may be shining directly into the lens when you are shooting. Position the camera so sunlight does not shine directly into the lens.
Images are not displayed.	This camera cannot display non-DCF images recorded onto a memory card using another digital camera.
Images cannot be edited (with White Balance, Brightness, Trimming, Rotation, Resize).	<p>Note that you cannot edit the following types of snapshots.</p> <ul style="list-style-type: none"> <li>• Snapshots created using MOTION PRINT</li> <li>• CS group snapshots</li> <li>• Movies</li> <li>• Snapshots recorded with another camera</li> </ul>
<b>Other</b>	
The wrong date and time are displayed, or the wrong date and time are being stored along with image data.	The date and time setting is off. Set the correct date and time (page 147).
The messages on the display are in the wrong language.	The wrong display language is selected. Change the display language setting (page 148).
Images cannot be transferred over a USB connection.	<ol style="list-style-type: none"> <li>1)The USB cable may not be connected securely. Check all connections.</li> <li>2)The wrong USB communication protocol is selected. Select the correct USB communication protocol in accordance with the type of device you are connecting (pages 126, 135).</li> <li>3)If the camera is not turned on, turn it on.</li> <li>4)Your computer may not be able to recognize the camera if you connect via a USB hub. Always connect directly to the computer's USB port.</li> </ol>

Problem	Possible Cause and Recommended Action
<p>Language selection screen appears when the camera is turned on.</p>	<p>1) You did not configure initial settings after purchasing the camera or the battery may have been left with a dead battery. Configure the correct settings (pages 19, 148).</p> <p>2) There may be a problem with the camera's memory data. If this is the case, perform the reset operation to initialize the camera's setup (page 152). After that, configure each setting. If the language selection screen does not re-appear when you turn the camera on, it means that the camera's memory management data has been restored.</p> <p>If the same message appears after you turn power back on, contact your retailer or a CASIO authorized service center.</p>
<p>The time and date settings configured the first time after purchasing the camera are reset to their factory defaults when I remove the camera's battery.</p>	<p>Load the camera's battery and reconfigure the time and date settings (page 19). Do not remove the battery from the camera for at least 24 hours after configuring time and date settings. After that, the settings will not be reset if you remove the battery.</p> <ul style="list-style-type: none"> <li>• If the time and date are reset to their factory default settings when you remove the battery after it has been loaded for more than 24 hours, it could mean that the camera's setting memory is defective. Contact your retailer or a CASIO authorized service center.</li> </ul>

## Display Messages

<b>ALERT</b>	The camera's protection function may have activated because camera temperature is too high. Turn off the camera and wait until it cools down before trying to use it again.
<b>Battery is low.</b>	Battery power is low.
<b>Camera not in standby. Re-frame the image.</b>	The camera could not go into auto record standby for some reason during a Move Out CS or Move In CS operation. Compose the image again with the boundary aligned correctly (page 72).
<b>Cannot find the file.</b>	The image you specified with the slideshow "Images" setting cannot be found. Change the "Images" setting (page 103) and try again.
<b>Cannot register any more files.</b>	You are attempting to save a user BEST SHOT scene in the "SCENE" folder when the folder already contains 999 user scenes.
<b>Card ERROR</b>	<p>There is something wrong with the memory card. Turn off the camera, remove the memory card and then reload it into the camera. If this message re-appears when you turn the camera back on, format the memory card (page 152).</p> <p> <b>IMPORTANT!</b></p> <ul style="list-style-type: none"><li>• Formatting a memory card deletes all its files. Before formatting, try transferring recoverable files to a computer or some other storage device.</li></ul>
<b>Check connections!</b>	You are attempting to connect the camera to a printer while the camera's USB settings are not compatible with the USB system of the printer (page 117).
<b>Files could not be saved because battery is low.</b>	Battery power is low, so an image file could not be saved.
<b>Folder cannot be created.</b>	You are trying to record a file while there are already 9999 files stored in the 999th folder. If you want to record more, delete files you no longer need (page 29).
<b>Images are being transferred. Stop transfer and turn off power?</b>	You are attempting to turn off power while image data is being transferred using the Eye-Fi card (page 140).
<b>LENS ERROR</b>	This message appears and the camera turns off whenever the lens performs some unexpected operation. If the same message appears after you turn power back on, contact a CASIO authorized service center or your original retailer.

<b>Load paper!</b>	The printer ran out of paper while printing.
<b>Memory Full</b>	Memory is full with images you recorded and/or files saved by editing operations. When shooting with Prerecord CS, this message indicates that there is not enough memory capacity to record all of the pre-recorded images. Delete files you no longer need (page 29).
<b>Printing Error</b>	An error occurred while printing. <ul style="list-style-type: none"> <li>• The printer is turned off.</li> <li>• The printer generated an error, etc.</li> </ul>
<b>Record Error</b>	Image compression could not be performed for some reason during image data storage. Shoot the image again.
<b>SYSTEM ERROR</b>	Your camera system is corrupted. Contact your retailer or an authorized CASIO authorized service center.
<b>The card is locked.</b>	The LOCK switch of the SD or SDHC memory card loaded in the camera is in the locked position. You cannot store images to or delete images from a memory card that is locked. <div style="float: right; text-align: center;"> <p>LOCK</p>  </div>
<b>There are no files.</b>	There are no files in built-in memory or on the memory card.
<b>There are no printing images. Set up DPOF.</b>	There are currently no files specified for printing. Configure the required DPOF settings (page 120).
<b>There is no image to register.</b>	The setup you are trying to save is for an image that cannot be saved as a user BEST SHOT scene.
<b>This card is not formatted.</b>	The memory card loaded in the camera is not formatted. Format the memory card (page 152).
<b>This file cannot be played.</b>	The file you are trying to access is corrupted or is a type that cannot be displayed by this camera.
<b>This function cannot be used.</b>	<ul style="list-style-type: none"> <li>• You attempted to copy images from built-in memory to a memory card while there is no memory card loaded in the camera (page 115).</li> <li>• You attempted to divide up a CS group while a file that is not a CS group is displayed (page 98).</li> </ul>

## Number of Snapshots/Movie Recording Time

### Snapshot

Image Size (Pixels)	Image Quality	Approximate Image File Size	Built-in Memory Snapshot Recording Capacity	SD Memory Card (1GB) Snapshot Recording Capacity
9M (3456×2592)	Fine	5.66 MB	5	170
	Normal	3.0 MB	10	322
	Economy	2.02 MB	15	478
3:2 (3456×2304)	Fine	4.94 MB	6	195
	Normal	2.64 MB	11	366
	Economy	1.78 MB	17	543
16:9 (3456×1944)	Fine	4.04 MB	8	239
	Normal	2.18 MB	14	443
	Economy	1.48 MB	20	653
6M (2816×2112)	Fine	3.48 MB	9	277
	Normal	1.89 MB	16	511
	Economy	1.3 MB	23	743
4M (2304×1728)	Fine	2.5 MB	12	386
	Normal	1.4 MB	21	690
	Economy	900 KB	33	1074
2M (1600×1200)	Fine	1.26 MB	23	767
	Normal	790 KB	37	1224
	Economy	470 KB	62	2056
VGA (640×480)	Fine	330 KB	88	2929
	Normal	190 KB	152	5086
	Economy	140 KB	206	6903



## Movies

Movie Mode	Image Quality (Pixels)/ (Audio)	Maximum File Size	Approximate Data Rate (Frame Rate)	Built-in Memory Movie Recording Capacity	SD Memory Card (1GB) Movie Recording Capacity	File Size of 1-minute Movie
HD/ STD	HD 1280×720 (Monaural)	Maximum Movie Length: 10 minutes	30 Megabits/second (30 frames/second)	8 seconds	4 minutes 22 seconds	225 MB
	STD 640×480 (Monaural)		10 Megabits/second (30 frames/second)	26 seconds	12 minutes 57 seconds	75 MB
HS	210 fps 480×360 (No audio)		50 Megabits/second (210 frames/second)	5 seconds	2 minutes 38 seconds	375 MB
	420 fps 224×168 (No audio)		50 Megabits/second (420 frames/second)	5 seconds	2 minutes 38 seconds	375 MB
	1000 fps 224×64 (No audio)		25 Megabits/second (1000 frames/second)	10 seconds	5 minutes 14 seconds	187.5 MB
	30-210 fps 480×360 (No audio)		7.1 Megabits/second (30 frames/second) 50 Megabits/second (210 frames/second)	37 seconds*	18 minutes 28 seconds*	53 MB*

Movie Mode	Image Quality (Pixels)/ (Audio)	Maximum File Size	Approximate Data Rate (Frame Rate)	Built-in Memory Movie Recording Capacity	SD Memory Card (Maximum recording time per recording)
YouTube Capture Mode	YouTube (HS210 fps) 480×360 (No audio)	Maximum Movie Size: 1024 MB (or 10 minutes)	50 Megabits/second (210 frames/second)	5 seconds	1 minute 25 seconds
	YouTube (HS420 fps) 224×168 (No audio)		50 Megabits/second (420 frames/second)	5 seconds	42 seconds
	YouTube (HS1000 fps) 224×64 (No audio)		25 Megabits/second (1000 frames/second)	10 seconds	18 seconds
	YouTube (HS30-210 fps) 480×360 (No audio)		7.1 Megabits/second (30 frames/second) 50 Megabits/second (210 frames/second)	37 seconds*	10 minutes*
	YouTube (HD) (1280×720) (Monaural)		30 Megabits/second (30 frames/second)	8 seconds	4 minutes 41 seconds
	YouTube (STD) 640×480 (Monaural)		10 Megabits/second (30 frames/second)	26 seconds	10 minutes

- Snapshot and movie recording capacity values are approximate and intended for reference only. Actual capacity depends on image contents.
- File size and data rate values are approximate and intended for reference only. Actual values depend on the type of image being shot.
- The above values are based on use of a PRO HIGH SPEED SD memory card (Panasonic Corporation). The number of images you can save depends on the type of memory card you are using.
- When using a memory card with a different capacity, calculate the number of images as a percentage of 1GB.
- The time it takes to play back a high speed movie will be different from the time it takes to record it. If you record a 210 fps high speed movie for 10 seconds, for example, it will take 70 seconds to play it back.
- Each movie can be up to 10 minutes long. Movie recording stops automatically after 10 minutes of recording.
- Certain types of memory cards can cause slow data transfer during movie recording, which may result in some of the frames of the movie being dropped. In order to avoid this problem, use of an Ultra High Speed Type SD memory card is recommended. Note, however that CASIO makes no guarantees about the operation of any Ultra High Speed Type SD memory card used with this camera.

\* Recordable time when the entire movie is recorded at 30 fps. Recording time is shorter if the 30 fps frame rate is switched to 210 fps during recording.

## Specifications

<b>File Format</b>	Snapshots: JPEG (Exif Version 2.2); DCF 1.0 standard; DPOF compliant Movies: Motion JPEG AVI, IMA-ADPCM audio (monaural)
<b>Recording Media</b>	Built-in Memory (Image Storage Area: 31.9MB) SD/SDHC
<b>Recorded Image Sizes</b>	Snapshots: 9M (3456×2592), 3:2 (3456×2304), 16:9 (3456×1944), 6M (2816×2112), 4M (2304×1728), 2M (1600×1200), VGA (640×480) Movies: HD (1280×720 30 fps), HS210 (480×360 210 fps), HS420 (224×168 420 fps), HS1000 (224×64 1000 fps), HS30-210 (480×360 30-210 fps switchable), STD (640×480 30 fps)
<b>Delete</b>	1 file; all files CS group, Individual images within a CS group (with memory protection feature)
<b>Effective Pixels</b>	9.10 Megapixels
<b>Imaging Element</b>	Size: 1/2.3-inch square pixel high-speed CMOS Total Pixels: 10.29 Megapixels
<b>Lens/Focal Distance (Snapshot)</b>	F3.9 (W) to 5.4 (T) f = 6.66 to 19.98 mm (equivalent to 38 to 114 mm in 35 mm format) 11 lenses in 9 groups, including aspherical lens.
<b>Zoom</b>	3X optical zoom, 4X digital zoom (12X in combination with optical zoom) 16.2X maximum HD Zoom (in combination with optical zoom, VGA size)
<b>Focusing</b>	Contrast Detection Auto Focus • Focus Modes: Auto Focus, Macro Focus, Pan Focus, Infinity, Manual Focus • AF Area: Spot, Free, Tracking; with AF assist lamp
<b>Approximate Focus Range (Snapshot) (From Lens Surface)</b>	Auto Focus: 40 cm to ∞ (1.3' to ∞) (Wide Angle) Macro Focus: 10 cm to 50 cm (3.9" to 19.7") (Wide Angle) Infinity: ∞ (Wide Angle) Manual Focus: 10 cm to ∞ (3.9" to ∞) (Wide Angle) * Range is affected by optical zoom.
<b>Metering</b>	Multi-pattern, center weighted, and spot by imaging element
<b>Exposure Control</b>	Program AE

<b>Exposure Compensation</b>	-2.0 EV to +2.0 EV (in 1/3EV steps)
<b>Shutter</b>	CMOS electronic shutter, mechanical shutter
<b>Shutter Speed</b>	Snapshot (Auto): 1 to 1/1250 second (1/40000 second for High Speed CS only) Snapshot (Night Scene): 4 to 1/1250 second * May differ due to the camera setup.
<b>Aperture Value</b>	F3.9 (W) to F7.1 (W) (When used with ND filter); aperture changed by optical zoom or recording mode
<b>White Balance</b>	Auto, Daylight, Overcast, Shade, Day White Fluorescent, Daylight Fluorescent, Tungsten, Manual WB
<b>Sensitivity (Standard Output Sensitivity)</b>	Snapshots: Auto, ISO 100, ISO 200, ISO 400, ISO 800, ISO 1600 equivalent Movies: Auto
<b>Self-timer</b>	Approximate Trigger Times: 10 seconds, 2 seconds, Triple Self-timer (Trigger time setting depends on CS mode being used.)
<b>Flash Modes</b>	Auto, Off, On, Red-eye reduction
<b>Flash Range (ISO Sensitivity: Auto)</b>	0.4 m to 2.6 m (1.3' to 8.5') (Wide Angle) 0.7 m to 1.9 m (2.3' to 6.2') (Telephoto) * Range is affected by optical zoom.
<b>Flash Intensity Adjustment</b>	-2, -1, 0, +1, +2
<b>Flash Charging Time</b>	Approximately 3 seconds maximum
<b>Movie Recording Minimum Illumination</b>	36 lx (HD/STD movie)
<b>Recording</b>	Snapshot, Normal Speed Continuous Shutter, High Speed Continuous Shutter, Prerecord (Continuous Shutter), Slow Motion View, Lag Correction, BEST SHOT, Face detection, High speed movie (no audio), HD Movie, STD Movie, Prerecord (Movie), YouTube Capture Mode
<b>Monitor Screen</b>	2.5-inch TFT color LCD (Super Clear LCD) 230,400 (960×240) dots
<b>Viewfinder</b>	Monitor Screen
<b>Timekeeping Functions</b>	Built-in quartz digital clock Date and Time: Recorded with image data Auto Calendar: To 2049
<b>World Time</b>	162 cities in 32 time zones City name, date, time, summer time

<b>Input/Output Terminals</b>	USB/AV port, Hi-Speed USB compatible
<b>Microphone</b>	Monaural
<b>Speaker</b>	Monaural
<b>Power Requirements</b>	Rechargeable lithium ion battery (NP-60) ×1

## Approximate Battery Life

All of the values provided below represent the approximate amount of time under normal temperature (23°C (73°F)) before the camera turns off. These values are not guaranteed. Low temperatures shorten battery life.

<b>Number of Shots (CIPA) (Operating Time)*<sup>1</sup></b>	160 shots
<b>Continuous Playback (Snapshots)*<sup>2</sup></b>	2 hours
<b>Approximate continuous movie recording time (High speed movie)*<sup>3</sup></b>	1 hour
<b>Approximate continuous movie recording time (HD Movie)*<sup>3</sup></b>	50 minutes

- Battery: NP-60 (Rated Capacity: 720 mAh)
- Recording Medium: 1GB SD memory card (PRO HIGH SPEED (Panasonic Corporation))
- Measurement Conditions

\*1 Approximate number of shots (CIPA) (Operating Time)

In accordance with CIPA (Camera and Imaging Products Association) standards Normal temperature (23°C (73°F)), monitor on, zoom operation between full wide and full telephoto every 30 seconds, during which two images are shot with flash; power turned off and back on every time 10 images are shot.

\*2 Approximate playback time

Standard temperature (23°C (73°F)), one-image scroll approximately every 10 seconds

\*3 Approximate time using a 16GB SDHC memory card for a repeated cycle of 10 minutes recording followed by deletion of the recorded file.

- The above values are based a new battery, starting from a full charge. Repeated charging shortens battery life.
- Frequency of flash, zoom, High Speed Continuous Shutter, and Auto Focus usage, and the time the camera is on greatly affects recording time and number of shots values.

<b>Power Consumption</b>	3.7 V DC, Approximately 4.6 W
<b>Dimensions</b>	97.1 (W) × 59.4 (H) × 16.3 (D) mm (3.8" (W) × 2.3" (H) × 0.64" (D))
<b>Weight</b>	Approximately 119 g (4.2 oz) (excluding battery and bundled accessories)

## ■ Rechargeable lithium ion battery (NP-60)

<b>Rated Voltage</b>	3.7 V
<b>Rated Capacitance</b>	720 mAh
<b>Operating Temperature</b>	0 to 40°C (32 to 104°F)
<b>Dimensions</b>	37.9 (W) × 42.3 (H) × 5.0 (D) mm (1.49" (W) × 1.67" (H) × 0.20" (D))
<b>Weight</b>	Approximately 18 g (0.63 oz)

## ■ Charger unit (BC-60L)

<b>Input Power</b>	100 to 240 V AC, 80 mA, 50/60 Hz
<b>Output Power</b>	4.2 V DC, 600 mA
<b>Operating Temperature</b>	5 to 35°C (41 to 95°F)
<b>Supported Battery Type</b>	Rechargeable lithium ion battery (NP-60)
<b>Charging Time</b>	90 minutes
<b>Dimensions</b>	60 (W) × 20 (H) × 86 (D) mm (2.4" (W) × 0.79" (H) × 3.4" (D)) (excluding projections)
<b>Weight</b>	Approximately 62 g (2.2 oz)

- Power cord precautions for use in Singapore  
The power cord set is not supplied. The power cord used must comply with relevant national and/or international standards.

**CASIO®**

**CASIO COMPUTER CO.,LTD.**  
6-2, Hon-machi 1-chome  
Shibuya-ku, Tokyo 151-8543, Japan



## Free Manuals Download Website

<http://myh66.com>

<http://usermanuals.us>

<http://www.somanuals.com>

<http://www.4manuals.cc>

<http://www.manual-lib.com>

<http://www.404manual.com>

<http://www.luxmanual.com>

<http://aubethermostatmanual.com>

Golf course search by state

<http://golfingnear.com>

Email search by domain

<http://emailbydomain.com>

Auto manuals search

<http://auto.somanuals.com>

TV manuals search

<http://tv.somanuals.com>