

EXILIM

E

Digital Camera

EX-S3

User's Guide

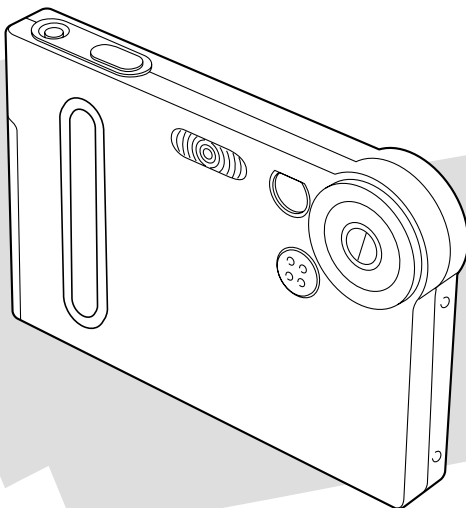

Thank you for purchasing this CASIO Product. Before using it, be sure to read the precautions contained in this User's Guide, and keep the User's Guide in a safe place for future reference.

K856PCM1DMX

Download from [Www.Somanuals.com](http://www.Somanuals.com). All Manuals Search And Download.

CASIO®

INTRODUCTION

Unpacking

Check to make sure that all of the items shown below are included with your camera. If something is missing, contact your dealer as soon as possible.



Camera

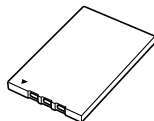

Rechargeable lithium ion battery (NP-20)

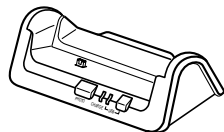

USB Cradle (CA-22)

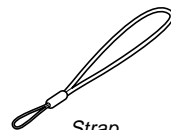

Strap



CD-ROM

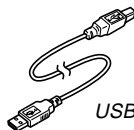

USB Cable

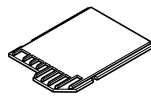

Dummy card

* Loaded in the camera when you purchase it.

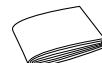

Basic Reference

• Note that the shape of the AC adaptor depends on the area where you purchased the camera.

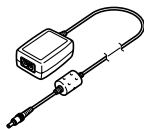

Special AC Adaptor
(Inlet Type)

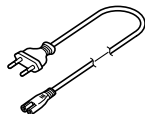

AC power cord *

* The shape of the AC power cord plug varies according to country or geographic area.

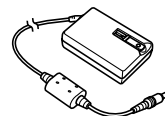

Special AC Adaptor
(Plug-in Type)

Contents

2 INTRODUCTION

Unpacking	2
Features	9
Precautions	11
General Precautions	11
Data Error Precautions	12
Operating conditions	13
Condensation	13
LED Backlight	14
Lens	14
Other	14

15 QUICK START GUIDE

First, charge the battery!	15
To configure display language and clock settings	16
To record an image	17
To view a recorded image	17
To delete an image	18

19 GETTING READY

About This Manual	19
General Guide	20
Camera	20
USB Cradle	21
Monitor Screen Contents	22
REC mode	22
PLAY mode	23
Changing the Contents of the Monitor Screen	23
Indicator Lamps	24
Attaching the Strap	24
Power Requirements	25
To load the battery	25
To charge the battery	26
Power Supply Precautions	30
Turning the Camera On and Off	34
Auto Power Off (APO)	34
Using the On-screen Menus	35
Configuring Display Language and Clock Settings ...	38
To configure display language and clock settings	39

INTRODUCTION

41 BASIC IMAGE RECORDING

Recording an Image	41
About the REC Mode Monitor Screen	42
Recording Precautions	43
Using Zoom	43
Using the Flash	45
Flash Precautions	46
Using the Self-timer	47
Specifying Image Size and Quality	49
To specify the image size	49
To specify image quality	50

51 OTHER RECORDING FUNCTIONS

Exposure Compensation (EV Shift)	51
Adjusting White Balance	52
Adjusting White Balance Manually	53
Using the Best Shot Mode	54
Creating Your Own Best Shot Setup	56
Combining Shots of Two People into a Single Image (Coupling Shot)	58
Recording a Subject onto an Existing Background Image (Pre-shot)	60

Using the Movie Mode	62
Using the Histogram	63
REC Mode Camera Settings	65
Specifying ISO Sensitivity	65
Turning Image Review On and Off	66
Assigning Functions to the [◀] and [▶] Keys	66
Assigning Functions to the [▲] and [▼] Keys	67
Specifying Power On Default Settings	68
Resetting the Camera	69

70 PLAYBACK

Basic Playback Operation	70
Flipping the Display	71
Zooming the Display Image	72
Resizing an Image	73
Cropping an Image	74
Playing a Movie	75
Displaying the Calendar Screen	76
Playing a Slide Show	77
To specify the slideshow images	79
To specify the slideshow time	80
To set the slideshow interval	80
Using the Photo Stand Feature	81
Rotating the Display Image	82

INTRODUCTION

83 DELETING FILES

Deleting a Single File	83
Deleting All Files	84

85 FILE MANAGEMENT

Folders	85
Memory Folders and Files	85
Protecting Files	86
To protect a single file	86
To protect all files in memory	87
DPOF	87
To configure print settings for a single image	88
To configure print settings for all images	89
PRINT Image Matching II	90
Exif Print	90
Using USB DIRECT-PRINT	91
Using the FAVORITE Folder	93
To copy a file to the FAVORITE folder	93
To display a file in the FAVORITE folder	94
To delete a file from the FAVORITE folder	95

97 OTHER SETTINGS

Turning the Key Tone On and Off	97
Specifying an Image for the Startup Screen	97
Specifying the File Name Serial Number Generation Method	98
Using the Alarm	99
To set an alarm	99
Stopping the Alarm	100
Setting the Clock	101
To select your Home Time zone	101
To set the current time and date	102
Changing the Date Format	102
Using World Time	103
To display the World Time screen	103
To configure World Time settings	103
To configure summer time (DST) settings	104
Changing the Display Language	105
Formatting Built-in Memory	106

INTRODUCTION

107 USING A MEMORY CARD

Using a Memory Card	108
To insert a memory card into the camera	108
To remove a memory card from the camera	108
Formatting a Memory Card	109
Memory Card Precautions	110
Copying Files	110
To copy all the files in built-in memory to a memory card	110
To copy a file from a memory card to built-in memory	111

112 VIEWING IMAGES ON A COMPUTER

Using the Camera with a Windows Computer	112
USB Connection Precautions	117
Using the Camera with a Macintosh Computer	117
USB Connection Precautions	122
Operations You Can Perform from Your Computer ..	122
Using a Memory Card to Transfer Images to a Computer	123
Memory Data	124
DCF Protocol	124
Memory Directory Structure	124
Image Files Supported by the Camera	125
Built-in Memory and Memory Card Precautions	126

127 USING THE CAMERA WITH A COMPUTER

Using the Album Feature	127
Creating an album	127
Selecting an Album Layout	128
Configuring Detailed Album Settings	129
Viewing Album Files	131
Saving an Album	134
Installing the Software from the CD-ROM	134
About the bundled CD-ROM	134
Computer System Requirements	135
Installing Software from the CD-ROM in Windows ...	136
Getting Started	136
Selecting a Language	136
Viewing the Contents of the "Read me" File	137
Installing an Application	137
Viewing User Documentation (PDF Files)	138
User Registration	138
Exiting the Menu Application	138
Installing Software from the CD-ROM on a Macintosh	139
Installing Software	139
Viewing User Documentation (PDF Files)	140

142 APPENDIX

Menu Reference	142
Indicator Lamp Reference	144
Camera Indicator Lamps	144
USB Cradle Indicator Lamps	146
Troubleshooting Guide	147
Display Messages	149
Specifications	150
Main Specifications	150

INTRODUCTION

►► IMPORTANT! ◀◀

- The contents of this manual are subject to change without notice.
- CASIO COMPUTER CO., LTD. assumes no responsibility for any damage or loss resulting from the use of this manual.
- CASIO COMPUTER CO., LTD. assumes no responsibility for any loss or claims by third parties which may arise through the use of the EX-S3.
- CASIO COMPUTER CO., LTD. shall not be held liable for any damages or losses suffered by you or any third party due to the use of Photo Loader and/or Photohands.
- CASIO COMPUTER CO., LTD. assumes no responsibility for any damage or loss caused by deletion of data as a result of malfunction, repairs, or battery replacement. Be sure to back up all important data on other media to protect against its loss.
- *The SD logo is a registered trademark.*
- *Windows, Internet Explorer, and DirectX are registered trademarks of Microsoft Corporation.*
- *Macintosh is a registered trademark of Apple Computer, Inc.*
- *MultiMediaCard is a trademark of Infineon Technologies AG of Germany, and licensed to the MultiMediaCard Association (MMCA).*
- *Acrobat and Acrobat Reader are trademarks of Adobe Systems Incorporated.*

- *The USB driver (mass storage) uses Phoenix Technologies Ltd. software.
Compatibility Software Copyright © 1997
Phoenix Technologies Ltd., All Rights Reserved.*
- *Other company, product and service names used herein may also be trademarks or service marks of others.*
- *Photo Loader and Photohands are the property of CASIO COMPUTER CO., LTD. Except as stipulated above, all copyrights and other related rights to these applications revert to CASIO COMPUTER CO., LTD.*

■ Copyright Restrictions

Except for the purposes of your own personal enjoyment, unauthorized copying of snapshot files and movie files violates copyright laws and international contracts. Distribution to third parties of such files over the Internet without permission of the copyright holder, whether for profit or for free, violates copyright laws and international contracts.

Features

- **3.2 million Effective Pixels**
A high-resolution megapixel CCD provides 3.2 million effective pixels (3.35 million total pixels) for images that print beautifully.
- **Fixed focus lens for quick operation**
Fixed focus eliminates the need for lens movement, which shortens startup time and shooting time.
- **2.0-inch TFT color LCD monitor screen**
- **4X digital zoom**
- **10MB Flash memory**
Images can be recorded without using a memory card.
- **Support for SD memory cards and MMC (MultiMedia Cards) for memory expansion**
- **Easy Charging**
Just place the camera onto the USB cradle to charge its battery.
- **Easy Image Transfer**
Transfer images to a computer simply by placing the camera onto the USB cradle.
- **Photo Stand feature**
A slideshow of images in file memory can be played while the camera is on its USB cradle.
- **Best Shot**
Simply select the sample scene that matches the type of image you are trying to record and the camera performs troublesome setups automatically for beautiful pictures every time.
- **Coupling Shot and Pre-shot**
Coupling Shot lets you combine two subjects into a single image, while Pre-shot lets you add a subject to a previously recorded background image. This means you can create images that include you and your friend, even if you are the only two people around. You can use Coupling Shot and Pre-shot by selecting the applicable sample images in the Best Shot mode.
- **Triple Self-timer mode**
The self-timer can be set up to repeat three times, automatically.
- **Real-time histogram**
An on-screen histogram lets you adjust exposure as you view the effect on overall image brightness, which makes shooting under difficult lighting conditions easier than ever before.
- **World Time**
A simple operation sets the current time for your current location. You can select from among 162 cities in 32 time zones.

INTRODUCTION

- **Alarm**
A built-in alarm helps to keep you on time for important events, and even can be used in place of an alarm clock. You can also have a specific image appear on the monitor screen when the alarm time is reached.
- **Album Function**
HTML files are generated automatically to create an album of recorded images. Album contents can be viewed and printed using a standard Web browser. Images can also be incorporated into Web pages quickly and easily.
- **Calendar screen**
A simple operation displays a full-month calendar on the camera's monitor screen. Each day of the full-month calendar shows a thumbnail of the first image recorded for that date, which helps to make searching for a particular image quicker and easier.
- **Movie mode with audio**
- **DCF Data Storage**
DCF (Design rule for Camera File system) data storage protocol provides image inter-compatibility between the digital camera and printers.
- **Digital Print Order Format (DPOF)**
Images can be printed easily in the sequence you want using a DPOF compatible printer. DPOF can also be used when specifying images and quantities for printing by professional print services.
- **PRINT Image Matching II Compatible**
Images include PRINT Image Matching II data (mode setting and other camera setup information). A printer that supports PRINT Image Matching II reads this data and adjusts the printed image accordingly, so your images come out just the way you intended when you recorded them.
- **USB DIRECT-PRINT support**
Your camera supports USB DIRECT-PRINT, which was developed by Seiko Epson Corporation. When connected directly to a printer that supports USB DIRECT-PRINT, you can select images to print and start the print operation directly from the camera.
- **Bundled with Photo Loader and Photohands**
Your camera comes bundled with Photo Loader, the popular application that automatically loads images from your camera to your PC. Also included is Photohands, an application that makes image retouching quick and easy.

Precautions

General Precautions

Be sure to observe the following important precautions whenever using the EX-S3.

All references in this manual to “this camera” and “the camera” refer to the CASIO EX-S3 Digital Camera.

- Never try to take pictures or use the built-in display while operating a motor vehicle or while walking. Doing so creates the danger of serious accident.
- Never try to open the case of the camera or attempt your own repairs. High-voltage internal components create the risk of electric shock when exposed. Always leave maintenance and repair work up to a CASIO authorized service center.
- Never look at the sun or any other bright light through the camera's viewfinder. Doing so can damage your eyesight.
- Keep the small parts and accessories of this camera out of the reach of small children. If swallowed accidentally, contact your physician immediately.
- Never fire the flash in the direction of a person operating a motor vehicle. Doing so can interfere with the driver's vision and create the danger of accident.

- Never fire the flash while it is too close to the subject's eyes. Intense light from the flash can cause eye damage if it is fired too close to the eyes. This is especially true with young children. When using the flash, the camera should be at least one meter (3.3') from the eyes of the subject.
- Keep the camera away from water and other liquids, and never let it get wet. Moisture creates the danger of fire and electric shock. Never use the camera outdoors in the rain or snow, at the seashore or beach, in the bathroom, etc.
- Should foreign matter or water ever get into the camera, immediately turn it off. Next, remove the camera's battery and/or unplug the AC adaptor power cord from the power outlet, and contact your dealer or nearest CASIO authorized service center. Using the camera under these conditions creates the danger of fire and electric shock.
- Should you ever notice smoke or a strange odor coming out of the camera, immediately turn it off. Next, taking care you do not burn your fingers, remove the camera's battery and/or unplug the AC adaptor power cord from the power outlet, and contact your dealer or nearest CASIO authorized service center. Using the camera under these conditions creates the danger of fire and electric shock. After making sure there is no more smoke coming from the camera, take it to your nearest CASIO authorized service center for repair. Never attempt your own maintenance.

INTRODUCTION

- Never use the AC adaptor to power any other device besides this camera. Never use any other AC adaptor besides the one that comes with this camera.
- Never cover the AC adaptor with a quilt, blanket, or other cover while it is in use, and do not use it near a heater.
- At least once a year, unplug the AC adaptor power cord from the power outlet and clean the area around the prongs of the plug. Dust build up around the prongs can create the danger of fire.
- If the camera's case should ever become cracked due to dropping it or otherwise subjecting it to rough treatment, immediately turn it off. Next, remove the camera's battery and/or unplug the AC adaptor power cord from the power outlet, and contact your dealer or nearest CASIO authorized service center.
- Never use the camera inside of an aircraft or in any other areas where its use is prohibited. Doing so can result in an accident.
- Physical damage and malfunction of this camera can cause the data stored in its memory to be deleted. Be sure to always keep backup copies of data by transferring them to personal computer memory.
- Never open the battery cover, disconnect the AC adaptor from the camera, or unplug the AC adaptor from the wall socket while recording images. Doing so will not only make storage of the current image impossible, it can also corrupt other image data already stored in file memory.

Data Error Precautions

- Your digital camera is manufactured using precision digital components. Any of the following creates the risk of corruption of data in file memory.
 - Removing the battery or memory card, or setting the camera onto the USB cradle while the camera is performing a record or memory access operation
 - Removing the battery, removing the memory card, or placing the camera onto the USB cradle while the operation/flash charge lamp is still flashing after you turn off the camera.
 - Disconnecting the USB cable, removing the camera from the USB cradle, or disconnecting the AC adaptor from the USB cradle while a data communication operation is being performed
 - Using low battery.
 - Other abnormal operations

Any of the above conditions can cause an error message to appear on the monitor screen (page 149). Follow the instructions provided by the message to eliminate the cause of the error.

Operating conditions

- This camera is designed for use in temperatures ranging from 0°C to 40°C (32°F to 104°F).
- Do not use or keep the camera in the following areas.
 - In areas subject to direct sunlight
 - In areas subject to high humidity or dust
 - Near air conditioners, heaters, or other areas subject to temperature extremes
 - Inside of a closed vehicle, especially one parked in the sun
 - In areas subject to strong vibration

Condensation

- When you bring the camera indoors on a cold day or otherwise expose it to a sudden change of temperature, there is the possibility that condensation can form on the exterior or on interior components. Condensation can cause malfunction of the camera, so you should avoid exposing it to conditions that might cause condensation.
- To keep condensation from forming, place the camera into a plastic bag before moving it into a location that is much warmer or colder than your current location. Leave it in the plastic bag until the air inside the bag has a chance to reach the same temperature as the new location. If condensation does form, remove the battery from the camera and leave the battery cover open for a few hours.

LED Backlight

- The monitor screen is illuminated by an LED backlight. A dark monitor screen indicates that the LED backlight has reached the end of its service life, and needs to be replaced by a CASIO authorized service center. Note that you will be charged for LED backlight replacement. The LED backlight brightness is reduced by half after about 1,000 hours of use.

Lens

- Never apply too much force when cleaning the surface of the lens. Doing so can scratch the lens surface and cause malfunction.
- Fingerprints, dust, or any other soiling of the lens can interfere with proper image recording. Never touch the lens with your fingers. You can remove dust particles from the lens surface by using a lens blower to blow them off. Next, wipe the surface of the lens with a soft lens cloth.

Other

- Take care never to sit down with the camera in the pocket of your slacks or otherwise subject the camera to severe stress. Doing so can crack the LCD monitor screen.
- The camera may become slightly warm during use. This does not indicate malfunction.
- If the exterior of the camera needs cleaning, wipe it with a soft, dry cloth.

QUICK START GUIDE

First, charge the battery!

1. Load the battery (page 25).

1

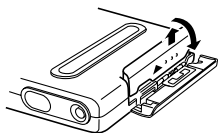

2

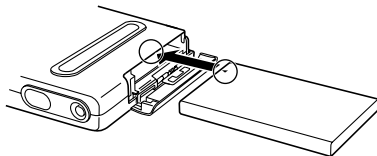

3

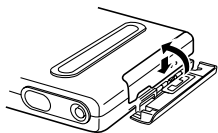

2. Place the camera onto the USB cradle to charge the battery (page 26).

- Note that the shape of the AC adaptor depends on the area where you purchased the camera.
- It takes about two hours to achieve a full charge.

1 Inlet Type

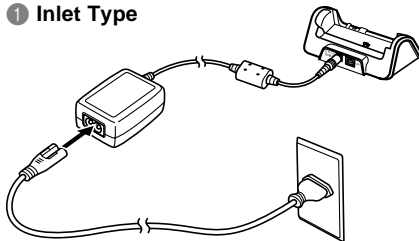

2



.....

1 Plug-in Type

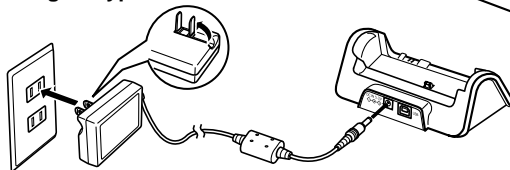

To configure display language and clock settings

►► IMPORTANT! ◀◀

- Be sure to configure the following settings before using the camera to record images (See page 38 for details).

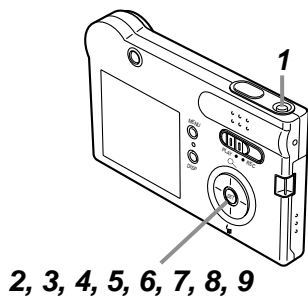

1. Press the power button to turn on the camera.
2. Press [▲], [▼], [◀], and [▶] to select the language you want.
3. Press [SET] to register the language setting.
4. Use [▲], [▼], [◀], and [▶] to select the geographical area you want, and then press [SET].
5. Use [▲] and [▼] to select the city you want, and then press [SET].
6. Use [▲] and [▼] to select the summer time (DST) setting you want, and then press [SET].
7. Use [▲] and [▼] to select the date format setting you want, and then press [SET].
8. Set the date and the time.
9. Press [SET] to register the clock settings and exit the setting screen.

To record an image

(See page 41 for details.)

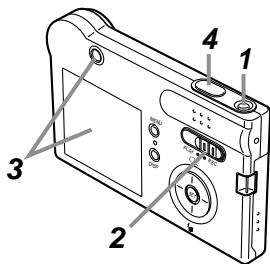

1. Press the power button to turn on the camera.
2. Align the mode selector with “REC”.
3. Point the camera at the subject, use the monitor screen or viewfinder to compose the image.
4. Holding the camera still, gently press the shutter release button.

To view a recorded image

(See page 70 for details.)

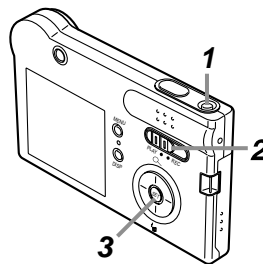

1. Press the power button to turn on the camera.
2. Align the mode selector with “PLAY”.
3. Use [◀] and [▶] to scroll through the images on the monitor screen.

To delete an image

(See page 83 for details.)

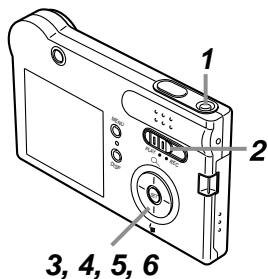

1. Press the power button to turn on the camera.
2. Align the mode selector with “PLAY”.
3. Press [▼] (🏠).
4. Use [◀] and [▶] to display the image you want to delete.
5. Use [▲] and [▼] to select “Delete”.
 - To exit the image delete operation without deleting anything, select “Cancel”.
6. Press [SET] to delete the image.

GETTING READY

This section contains information about things you need to know about and do before trying to use the camera.

About This Manual

This section contains information about the conventions used in this manual.

Terminology

The following table defines the terminology used in this manual.

This term as used in this manual:	Means this:
"this camera" or "the camera"	The CASIO EX-S3 Digital Camera
"file memory"	The location where the camera is currently storing images you record (page 41)
"battery"	The NP-20 Rechargeable Lithium Ion Battery
"optional charger unit"	The optionally available CASIO BC-10L Charger Unit

Button Operations

Button operations are indicated by the button name inside of brackets ([]).

On-screen Text

On-screen text is always enclosed by double quotation marks (" ").

File Memory

The term "file memory" in this manual is a general term that refers to the location where your camera is currently storing the images you record. File memory can be any one of the following three locations.

- The camera's built-in Flash memory
- An SD memory card loaded in the camera
- A MultiMediaCard loaded in the camera

For more information about how the camera stores images, see page 107.

General Guide

The following illustrations show the names of each component, button, and switch on the camera.

Camera

■ Front

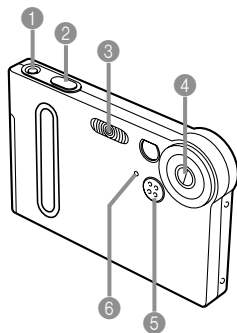

- 1 Power button
- 2 Shutter release button
- 3 Flash
- 4 Lens
- 5 Microphone
- 6 Self-timer lamp

■ Back

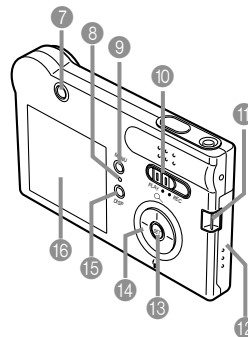

- 7 Viewfinder
- 8 Operation/Flash charge lamp
- 9 [MENU] button
- 10 Mode selector
- 11 Strap bar
- 12 Battery cover
- 13 [SET] button
- 14 [▲][▼][◀][▶]
- 15 [DISP] button
- 16 Monitor Screen

GETTING READY

Bottom

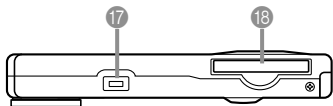

17 Connector

18 Memory card slot

If you are not using a memory card, be sure to insert the dummy card into this slot to protect against dust and damage.

USB Cradle

Simply placing your CASIO digital camera onto the USB cradle lets you perform the following tasks.

- Battery charging (page 26)
- Automatic transfer of images to a computer (page 112)
- Viewing of images using the Photo Stand slideshow feature (page 81).

Front

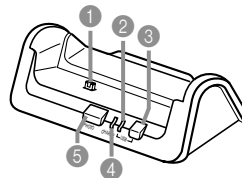

1 Camera connector

2 [USB] lamp

3 [USB] button

4 [CHARGE] lamp

5 [PHOTO] button

Back

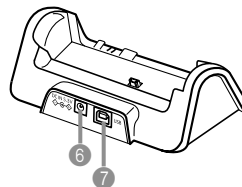

6 [DC IN 5.3V]
(AC adaptor connector)

7 [USB]
(USB port)

Monitor Screen Contents

The monitor screen uses various indicators and icons to keep you informed of the camera's status.

REC mode

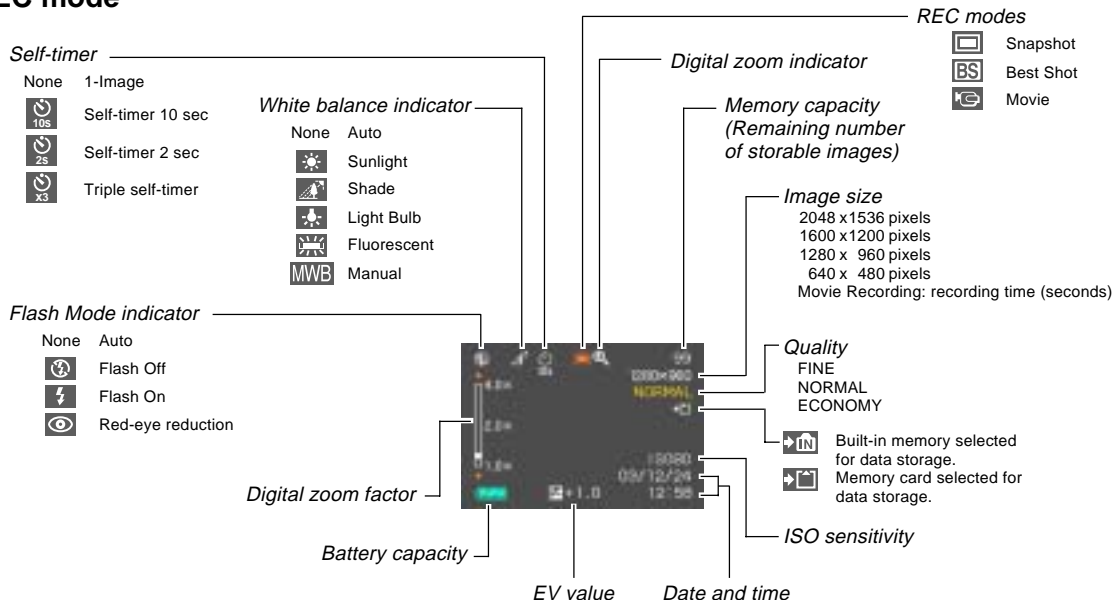

PLAY mode

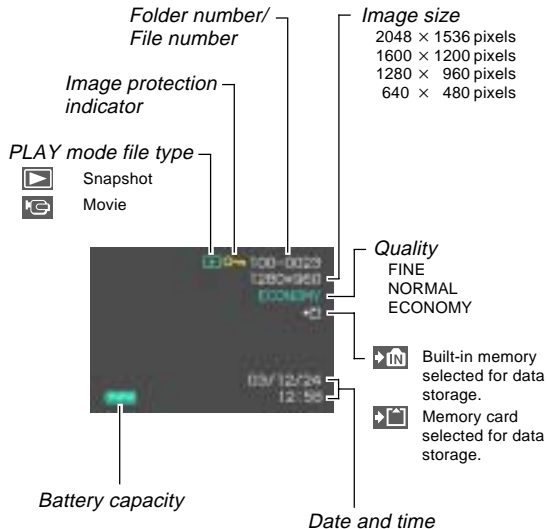

▶▶ IMPORTANT! ◀◀

- Some information may not display properly if you display an image that was recorded using a different digital camera model.

Changing the Contents of the Monitor Screen

Each press of the [DISP] button changes the contents of the monitor screen as shown below.

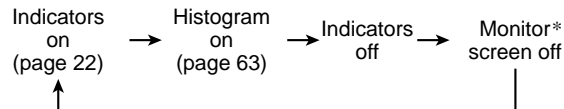

* You cannot turn off the monitor screen in the following modes: PLAY mode, Best Shot mode, Movie mode.

GETTING READY

Indicator Lamps

You can find out the operational status of the camera and the USB cradle at a glance by checking the color of the indicator lamps, and whether a lamp is lit or flashing. For details, see "Indicator Lamp Reference" on page 144.

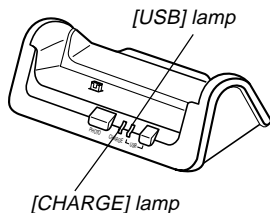
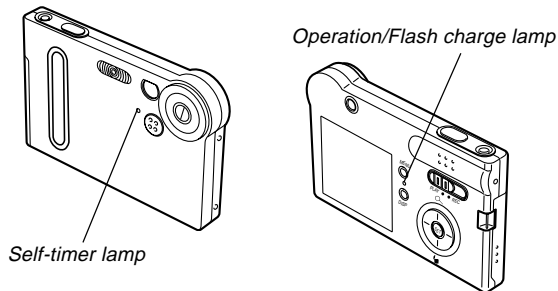

Attaching the Strap

Attach the strap to the strap bar as shown in the illustration.

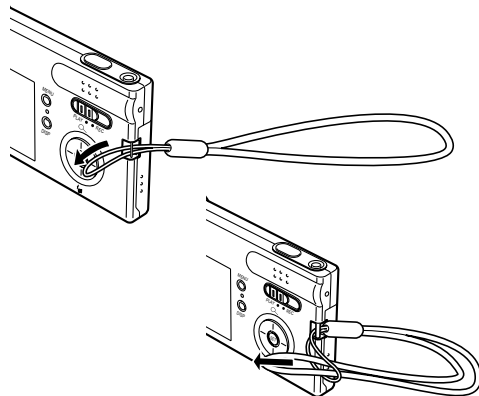

►► IMPORTANT! ◀◀

- Be sure to keep the strap around your wrist when using the camera to protect against accidentally dropping it.
- The supplied strap is intended for use with this camera only. Do not use it for any other purpose.
- Never swing the camera around by the strap.

Power Requirements

Your camera is powered by a rechargeable lithium ion battery (NP-20).

To load the battery

1. Pressing the battery cover on the side of the camera, slide it in the direction indicated by the ▲ mark and then swing it open.

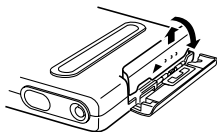

2. Align the arrow mark on the battery with the arrow mark on the camera as shown in the illustration, and slide the battery into the battery compartment.

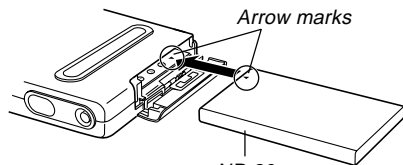

3. Swing the battery cover closed, and then slide it in the direction indicated by the arrow while pressing down on it.

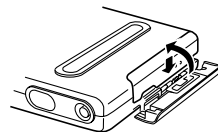

IMPORTANT!

- Use only the special NP-20 rechargeable lithium ion battery to power this camera. Use of any other type of battery is not supported.

NOTE

- To remove the battery, open the battery cover. Taking care that the battery does not suddenly fall out of the camera, tilt the camera towards the side. When the battery slides out part way, pull it out by hand.

The battery is not charged when you purchase the camera. You need to charge the battery before using the camera for the first time (page 26).

To charge the battery

1. Connect the bundled AC adaptor to the [DC IN 5.3V] connector of the USB cradle, and then plug it in to a household power outlet.

- Note that the shape of the AC adaptor depends on the area where you purchased the camera.

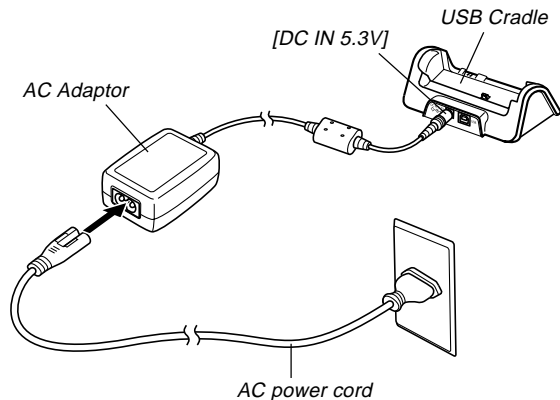

NOTE

- The bundled AC adaptor is designed for operation with any power supply in the range of 100V to 240V AC. Note, however, that the shape of the AC power cord plug varies according to country or geographic area. If you plan to use the AC adaptor in a geographic area where the power receptacle shape is different from that in your area, replace the AC power cord with one of the other ones that comes with the camera, or purchase a commercially available AC power cord that is compatible with the power outlets in that area.

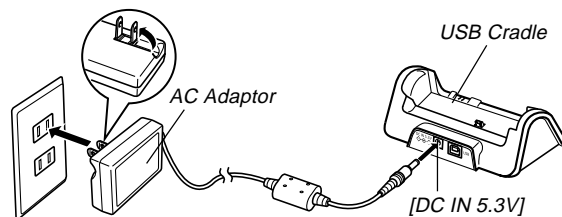

GETTING READY

NOTE

- The AC adaptor is designed for operation on power ranging from 100V AC to 240V AC. Note, however, that the shape of the power cord plug varies according to country or geographic area. It is up to you to find out if the shape of the AC adaptor power cord plug is compatible with local power outlets when traveling abroad.

2. Turn off the camera.

3. Set the camera onto the USB cradle.

- Do not place the camera onto the USB cradle while it is turned on.
- The [CHARGE] lamp on the USB cradle should turn red, indicating that charging has started. When charging is complete, the [CHARGE] lamp will turn green.

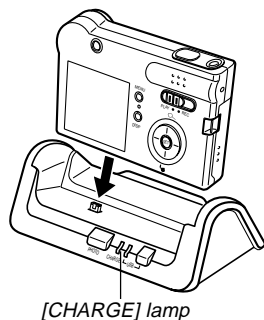

4. After charging is complete, remove the camera from the USB cradle.

IMPORTANT!

- It takes about two hours to achieve a full charge. Actual charging time depends on current battery capacity and charging conditions.
- Use only the USB cradle (CA-22) or the optionally available charger unit (BC-10L) to charge the special NP-20 rechargeable lithium ion battery. Never use any other charging device.
- Use only the bundled AC adaptor. Never use any other type of AC adaptor. Do not use optionally available AD-C40, AD-C620 and AD-C630 AC adaptors with this camera.
- Make sure that the camera connector of the USB cradle is securely inserted into the camera's connector as far as it will go.
- The [CHARGE] lamp may remain amber colored and the charge operation may not start right away if you try to charge immediately after using the camera (which causes battery to become warm) or when it is too hot or too cold where you are performing the charge operation. If this happens, simply wait until the battery reaches normal temperature. The [CHARGE] lamp will turn red and charging will start when the battery temperature returns to the allowable charging temperature range.

- If the [CHARGE] lamp starts flashing red, it means that an error occurs while charging. An error can be caused by any of the following: a problem with the USB cradle, a problem with the camera, or a problem with the battery or how it is loaded. Remove the camera from the USB cradle and see if it works normally.
- You can use the USB cradle to charge the camera's battery, to exchange data with a computer over a USB connection, or when using the Photo Stand feature only.

■ If the camera works normally

- 1. Continue using the camera until the current charge is used up, and then charge the battery.**

■ If the camera does not work normally

This can mean there is a problem with how the battery is loaded.

- 1. Remove the battery from the camera and check the battery contacts for dirt. If the contacts are dirty, wipe them clean with a dry cloth.**
- 2. Check to make sure that the AC adaptor's power cord is connected securely to the power outlet and USB cradle.**
 - If the same symptoms occur again when you place the camera on the USB cradle after taking the above steps, contact a CASIO authorized service center.

■ Battery Life Guidelines

The battery life guideline values given below indicate the amount of time at standard temperature (25°C (77°F)) until power automatically turns off due to battery failure. They do not guarantee that the battery will provide the amount of service indicated. Low temperatures and continued use reduce battery life.

Operation	Approximate Battery Life
Continuous Recording* ¹ (Continuous Snapshot Recording)	80 minutes (480 shots)
Continuous Playback* ²	120 minutes

Supported Battery: NP-20 (Rated Capacitance: 680mAh)

*1 Continuous Recording Conditions

- Normal temperature: 25°C (77°F)
- Flash: Off
- Monitor screen: On
- Image recorded about every 10 seconds

*2 Continuous Playback Conditions



- Normal temperature: 25°C (77°F)
- Scroll one image about every 10 seconds





- Recording one image per minute under the above conditions reduces battery life to about one sixth of that noted above.
- The above values are based on a new battery starting from a full charge. Repeated charging shortens battery life.
- Battery life is greatly affected by how much you use flash, zoom and other functions, and how long you leave power turned on.

■ Tip to Make the Battery Last Longer

If you do not need the flash while recording, select  (flash off) for the flash mode. See page 45 for more information.

■ Low Battery Indicator

The following shows how the battery capacity indicator on the monitor screen changes as battery power is used. The  indicator means that remaining battery power is low. Note that you will not be able to record images while the battery indicator is . Charge the battery immediately whenever either of these indicators appears.

Battery Level	High ←————→ Low
Indicator	 →  →  → 

Power Supply Precautions

Note the following precautions when handling or using the battery and the optional charger unit.

■ Battery Handling Precautions

● SAFETY PRECAUTIONS

Be sure to read the following Safety Precautions before trying to use the battery for the first time. Keep these safety precautions and all operating instructions on hand for future reference.

☰ NOTES ☰

- The term “battery” in this manual refers to the CASIO NP-20 Rechargeable Lithium Ion Battery.
- The term “optional charger unit” in the following precautions refers to the optionally available CASIO BC-10L Charger Unit.

GETTING READY

- Failure to observe any of the following precautions while using the battery creates the risk of over-heating, fire, and explosion.
 - Never use any other type of charger except the optional charger unit specified for the battery.
 - Never try to use the battery to power any other device other than this camera.
 - Never use or leave the battery near open flame.
 - Never place the battery in a microwave oven, throw it into fire, or otherwise expose it to intense heat.
 - Make sure the battery is oriented correctly when you load it into the camera or attach it to the optional charger unit.
 - Never carry or store the battery together with items that can conduct electricity (necklaces, pencil lead, etc.)
 - Never try to take the battery apart, modify it in any way, or expose it to strong impact.
 - Do not immerse the battery in fresh water or salt water.
 - Do not use or leave the battery under direct sunlight, in an automobile parked in the sun, or in any other area subject to high temperatures.
- Should you ever notice leakage, strange odor, heat generation, discoloration, deformation, or any other abnormal condition while using, charging, or storing a battery, immediately remove it from the camera or optional charger unit and keep it away from open flame.
- If the battery does not achieve full charge after the normal charging time has passed, stop charging. Continued charging creates the risk of overheating, fire, and explosion.
- Battery fluid can damage your eyes. Should battery fluid get into your eyes accidentally, immediately rinse them with clean tap water and then consult a physician.
- Be sure to read page 26 of this User's Guide and the instructions that come with the optional charger unit before using or charging the battery.
- If the battery is to be used by young children, make sure that a responsible adult makes them aware of the precautions and proper handling instructions and make sure that they handle the battery correctly.
- Should fluid from the battery accidentally get onto clothing or your skin, immediately rinse it off with clean tap water. Prolonged contact with battery fluid can cause skin irritation.

GETTING READY

● PRECAUTIONS DURING USE

- The battery is designed for use with this CASIO digital camera only.
- Use only the USB cradle that comes with the camera or the specified optional charger unit to charge the battery. Never use any other type of charger unit for charging.
- A new battery is not charged. Be sure to charge the battery before using it for the first time.
- Use of a battery in cold environments shortens the operating time you can expect on a full charge. Charge the battery in a location where the temperature is in the range of 10°C to 35°C (50°F to 95°F). Charging outside this temperature range can cause charging to take longer than normal or even cause charging to fail.
- Very limited operation following a full charge indicates that the battery has reached the end of its service life. Replace the battery with a new one.
- Never wipe the battery with thinner, benzene, alcohol, or other volatile agents or chemically treated rags. Doing so can cause deformation of the battery and lead to malfunction.

● BATTERY STORAGE PRECAUTIONS

- Make sure you remove the battery when you do not plan to use the camera for a long time. A battery left in the camera discharges very small amounts of power even when power is turned off, which can lead to a dead battery or the need for longer charging before the next use.
- Store the battery in a cool, dry place (20°C (68 °F) or lower).

● USING THE BATTERY

- See page 26 of this manual or the instructions that come with the optional charger unit for information about charging procedures and charging times.
- When transporting a battery, keep it either loaded in the camera or stored in its case.

■ USB Cradle and AC Adaptor Precautions



Caution!

- Never use an electrical outlet whose voltage is outside the rating marked on the AC adaptor. Doing so can create the danger of fire or electric shock. Use only the bundled AC adaptor specified for this camera.
 - Do not allow the AC adaptor cord to become cut or damaged, do not place heavy objects on it, and keep it away from heat. A damaged power cord creates the risk of fire and electric shock.
 - Never try to modify the AC adaptor cord, or subject it to severe bending, twisting, or pulling. Doing so creates the risk of fire and electric shock.
 - Never touch the AC adaptor while your hands are wet. Doing so creates the risk of electric shock.
 - Do not overload extension cords or wall outlets. Doing so creates the danger of fire and electric shock.
 - Should the cord of the AC adaptor become damaged (exposed internal wiring), request a replacement from a CASIO authorized service center. A damaged AC adaptor cord creates the danger of fire or electric shock.
- Make sure you always remove the camera from the USB cradle before connecting or disconnecting the AC adaptor.
 - Charging, USB data communication, and using the Photo Stand feature can cause the AC adaptor to become warm. This is normal and does not indicate malfunction.
 - Unplug the AC power cord from the power outlet whenever you are not using it.
 - Never place a blanket or any other cover on the AC adaptor. Doing so creates the risk of fire.

Turning the Camera On and Off

Press the power button to turn the camera on and off.

Pressing the power button to turn on the camera causes the operation/flash charge lamp to turn green. Press the power button again to turn off the camera.

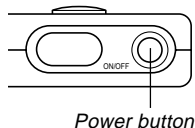

►► IMPORTANT! ◀◀

- If camera power is turned off by the Auto Power Off feature, press the power button to turn it back on again.

Auto Power Off (APO)

Auto Power Off (APO) automatically turns off the camera when you do not perform any operation for a certain amount of time.

1. Turn on the camera, and then align the mode selector with “REC” or “PLAY”.
2. Press [MENU].
3. Use [◀] and [▶] to select the “Set Up” tab.
4. Use [▲] and [▼] to select “Auto Power Off”, and then press [▶].
 - See page 35 for information about how to use menus.

GETTING READY

5. Use [▲] and [▼] to change the currently selected setting, and then press [SET].

To do this:	Select this setting:
Set the Auto Power Off trigger time to 2 minutes	2 min
Set the Auto Power Off trigger time to 5 minutes	5 min

►► IMPORTANT! ◀◀

- Auto Power Off is automatically disabled under any one of the following conditions.
 - While the camera is connected to a computer via the USB cradle
 - While a slideshow is playing

Using the On-screen Menus

Pressing [MENU] displays menus on the monitor screen that you can use to perform various operations. The menu that appears depends on whether you are in the REC mode or the PLAY mode. The following shows an example menu procedure in the REC mode.

1. Turn on the camera, and then align the mode selector with “REC” to enter the REC mode.

- If you want to enter the PLAY mode instead, you would align the mode selector with “PLAY”.

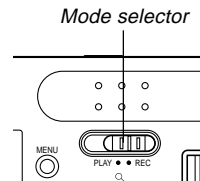

GETTING READY

2. Press [MENU].

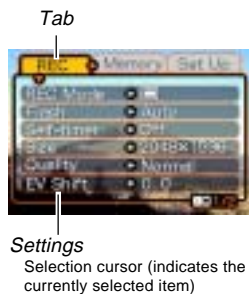
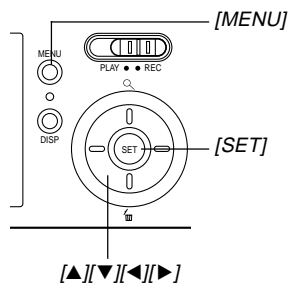

● Menu Screen Operations

When you want to do this:	Do this:
Move between tabs	Press [◀] and [▶].
Move from the tab to the settings	Press [▼].
Move from the settings to the tab	Press [▲].
Move between the settings	Press [▲] and [▼].
Display the options available for a setting	Press [▶] or press [SET].
Select an option	Press [▲] and [▼].
Register an option selection and exit the menu screen	Press [SET].
Register an option selection and return to the menu screen	Press [◀].
Exit the menu screen	Press the [MENU] button.

3. Press [◀] or [▶] to select the tab you want, and then press [SET] to move the selection cursor from the tab to the settings.

4. Use [▲] and [▼] to select the feature whose setting you want to configure, and then press [▶].

- Instead of pressing [▶], you could also press [SET].



Example: To select the "REC Mode" item.

5. Use [▲] and [▼] to change the currently selected setting.

6. Perform one of the following operations to apply the setting you configured.

To do this:	Perform this key operation:
Apply the setting and exit the menu screen.	Press [SET].
Apply the setting and return to feature selection in step 4.	Press [◀].
Apply the setting and return to tab selection in step 3.	1. Press [◀]. 2. Use [▲] to move back up to tab selection.

- See "Menu Reference" on page 142 for more information about menus.

Configuring Display Language and Clock Settings

Be sure to configure the following settings before using the camera to record images.

- Display language
- Home city
- Date Style
- Date and time

Note that the current date and time settings are used by the camera to generate the date and time that are stored along with image data, etc.

►► IMPORTANT! ◀◀

- The camera's clock settings are cleared whenever power is totally cut off. This can happen if the battery goes dead while the camera is not being supplied power by the USB cradle. The clock setting screen will appear automatically the next time you turn on power after the settings are cleared. Set the date and time before using the camera.
- The current date and time settings will be cleared if the battery remains dead without being charged for about two days.
- Recording images without configuring the clock settings causes incorrect time information to be registered. Be sure to configure the clock settings before using the camera.

To configure display language and clock settings

1. Press the power button to turn on the camera.
2. Use [▲], [▼], [◀], and [▶] to select the language you want, and then press [SET].



日本語	: Japanese
English	: English
Français	: French
Deutsch	: German
Español	: Spanish
Italiano	: Italian
Português	: Portuguese
中國語	: Chinese (Complex)
中国語	: Chinese (Simplified)
한국어	: Korean

3. Use [▲], [▼], [◀], and [▶] to select the geographical area where you live, and then press [SET].



4. Use [▲] and [▼] to select the name of the city where you live, and then press [SET].



5. Use [▲] and [▼] to select the summer time (DST) setting you want, and then press [SET].

When you want to do this:	Select this setting:
Keep time using summer time (Daylight Saving Time)	On
Keep time using standard time	Off

GETTING READY

6. Use [▲] and [▼] to change the date format setting, and then press [SET].



Example: October 23, 2003

To display the date like this:	Select this format:
03/10/23	YY/MM/DD
23/10/03	DD/MM/YY
10/23/03	MM/DD/YY

7. Set the current date and the time.



To do this:	Do this:
Change the setting at the current cursor location	Press [▲] and [▼].
Move the cursor between settings	Press [◀] and [▶].
Toggle between 12-hour and 24-hour timekeeping	Press [DISP].

8. Press [SET] to register the settings and exit the setting screen.

BASIC IMAGE RECORDING

This section describes the basic procedure for recording an image.

Recording an Image

Your camera automatically adjusts shutter speed in accordance with the brightness of the subject. Images you record are stored in the camera's built-in memory, or to a memory card if you have one loaded in the camera.

- When an optionally available SD memory card or MultiMediaCard (MMC) is loaded in the camera, images are stored on the card (page107).

1. Press the power button to turn on the camera.

- This causes an image or a message to appear on the monitor screen.

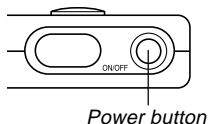

2. Align the mode selector with "REC".

- This enters the REC mode for image recording.

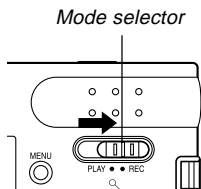

3. Compose the image on the monitor screen.

- The focusing range of the camera is approximately 80 cm (2.6 feet) to infinity (∞).
- When performing this step, take care so your fingers do not block the lens or any of the sensors.
- You can compose images using either the monitor screen or the optical viewfinder.
- When using the optical viewfinder, you can turn off the monitor screen to save power (page 23).

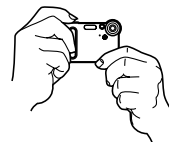
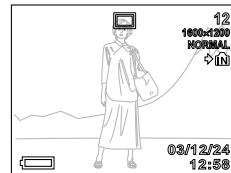

4. Press the shutter release button to record the image.

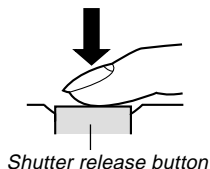

- The number of images that can be stored in memory depends on the resolution setting you are using (pages 49, 151).
- Depending on the distance or angle between the subject and the camera, the image you see in the viewfinder may not be exactly the image that is recorded.
- Press the shutter release button gently to avoid camera movement.

About the REC Mode Monitor Screen

- The image shown on the monitor screen in the REC mode is a simplified image for composing purposes. The actual image is recorded in accordance with the image quality setting currently selected on your camera. The image saved in file memory has much better resolution and detail than the REC mode monitor screen image.
- Certain levels of subject brightness can cause the response of the REC mode monitor screen to slow down, which causes some static noise in the monitor screen image.

Recording Precautions

- Never open the battery cover or place the camera onto the USB cradle while the operation/flash charge lamp is flashing. Doing so not only causes the current image to be lost, it can also corrupt images already stored in file memory and even lead to malfunction of the camera.
- Never remove the memory card while an image is being recorded to the memory card.
- Fluorescent lighting actually flickers at a frequency that cannot be detected by the human eye. When using the camera indoors under such lighting, you may experience some brightness or color problems with recorded images.
- When “Auto” is selected for the ISO sensitivity setting (page 65), the camera automatically adjusts its sensitivity in accordance with the brightness of the subject. This can cause some static noise to appear in images of relatively dark subjects.
- When “Auto” is selected for the ISO sensitivity setting (page 65), the camera raises the sensitivity and uses a faster shutter speed. Because of this, you need to guard against camera movement if you have flash turned off (page 45) when recording a dimly lit subject.
- If unwanted light is shining on the lens, shade the lens with your hand when recording the image.

Using Zoom

You can use the digital zoom feature of your camera to zoom in on the center of an image. Performing a zoom operation toggles the zoom factor between 1X and 4X.

- 1. In the REC mode, press [MENU].**
- 2. Use [◀] and [▶] to select the “REC” tab.**
- 3. Use [▲] and [▼] to select “Digital Zoom”, and then press [▶].**
- 4. Use [▲] and [▼] to select “On”, and then press [SET].**
 - Selecting “Off” disables digital zoom.

5. In the REC mode, use [▲] and [▼] to change the digital zoom factor.

[▲] : Zoom in.

[▼] : Zoom out.



Zoom in

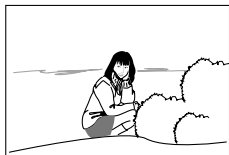

Zoom out

6. Record the image.

►► IMPORTANT! ◀◀

- Zoom is disabled whenever the monitor screen is turned off (page 23).
- Using digital zoom can cause degradation of the recorded image.
- To disable digital zoom, select "Off" for the "Digital Zoom" setting on the "REC" tab.



►► NOTE ◀◀

- You can use the key customization feature (page 67) to configure the camera so the digital zoom factor changes whenever you press [▲] and [▼] while in the REC mode.

Using the Flash

Perform the following steps to select the flash mode you want to use.

1. In the REC mode, press [MENU].
2. Use [◀] and [▶] to select the “REC” tab.
3. Use [▲] and [▼] to select “Flash”, and then press [▶].
4. Use [▲] and [▼] to select the flash mode you want, and then press [SET].

To do this:	Select this setting:
Have the flash fire automatically when required (Auto Flash)	Auto
Turn off the flash (Flash Off)	
Always fire the flash (Flash On)	
Fire a pre-flash followed by image recording with flash, reducing the chance of red-eye in the image (Red-eye reduction). Have the flash fire automatically when required.	

5. Record the image.

►► IMPORTANT! ◀◀

- The flash unit of this camera fires a number of times when you record an image. The initial flashes are pre-flashes, which the camera uses to obtain information it uses for exposure settings. The final flash is for recording. Make sure that you keep the camera still until the shutter releases.
- Image recording may not be performed if you press the shutter release button while the operation/flash charge lamp is flashing amber.

►► NOTE ◀◀

- You can use the key customization feature (pages 66, 67) to configure the camera so the flash mode changes whenever you press [◀] and [▶], or [▲] and [▼] while in the REC mode.

■ About Red-eye Reduction

Using the flash to record at night or in a dimly lit room can cause red spots inside the eyes of people who are in the image. This is caused when the light from the flash reflects off of the retina of the eye. Red-eye reduction fires a pre-flash, which causes the irises in the eyes of any people in the image to close. This is followed by another flash operation when the image is actually recorded.

▶▶ IMPORTANT! ◀◀



Note the following important points when using red-eye reduction.

- Red-eye reduction does not work unless the people in the image are looking directly at the camera (flash). Before pressing the shutter release button, call out to the subjects so they all look at the camera.
- Red-eye reduction may not work very well if the subjects are located far away from the camera.

Flash Precautions

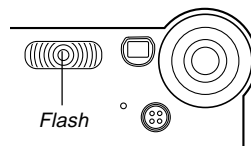
Take care that your fingers do not block the flash when you hold the camera. Covering the flash with your finger can greatly reduce its effectiveness.



- The approximate effective range of the flash is shown below. The flash is unable to adequately illuminate a subject that is outside this range. 0.8 meter to 2 meters (2.6' to 6.6') (ISO Sensitivity : "Auto")
- The flash takes anywhere from a few seconds as long as 10 seconds to attain full charge after being fired. The actual time required depends on the battery level, temperature, and other conditions.
- The flash does not fire during movie recording. This is indicated by  on the monitor screen.
- The flash unit may not be able to charge when battery power is low. Low battery power is indicated by the  on the monitor screen, and when the flash fails to fire properly resulting in poor image exposure. When these symptoms occur, charge the camera's battery as soon as possible.

BASIC IMAGE RECORDING

- When the red-eye reduction mode (👁) is selected, flash intensity is adjusted automatically in accordance with the exposure. The flash may not fire at all when the subject is brightly lit.
- White balance is fixed while the flash is being used, so sunlight, fluorescent lighting, or other sources of illumination in the immediate area may affect the coloring of the recorded image.

Using the Self-timer

The self-timer lets you select either a 2-second or 10-second delay of the shutter release after you press the shutter release button. A Triple Self-timer feature lets you perform three consecutive self-timer operations to record three images.

- 1. In the REC mode, press [MENU].**
- 2. Use [◀] and [▶] to select the “REC” tab.**
- 3. Use [▲] and [▼] to select “Self-timer”, and then press [▶].**
- 4. Use [▲] and [▼] to select the self-timer time you want to use, and then press [SET].**
 - Selecting “Off” in step 4 disables the self-timer.

BASIC IMAGE RECORDING

To do this:	Select this setting:
Specify a 10-second self-timer	10 sec
Specify a 2-second self-timer	2 sec
Specify Triple Self-timer	X3
Disable the self-timer	Off

- With the Triple Self-timer, the camera records a series of three images in the sequence described below.
 1. The camera performs a 10-second countdown and then records the first image.
 2. The camera prepares to record the next image. The amount of time required for preparation depends on the camera's current "Size" and "Quality" settings, the type of memory (built-in or card) you are using for image storage, and whether or not the flash is charging.
 3. After preparation is complete, the indicator "1sec" appears on the monitor screen, and another image is recorded one second later.
 4. Steps 2 and 3 are repeated once more to record the third image.

5. Record the image.

- When you press the shutter release button, the self-timer lamp flashes and the shutter releases after the self-timer reaches the end of its countdown.
- You can interrupt an ongoing self-timer countdown by pressing the shutter release button while the self-timer lamp is flashing.

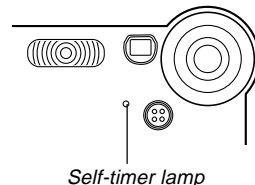

»» NOTES ««

- The "2 sec" self-timer setting is best when shooting with a slow shutter speed, because it helps to avoid blurring of images due to hand movement.
- You can use the key customization feature (page 67) to configure the camera so the self-timer setting changes whenever you press [▲] and [▼] while in the REC mode.

Specifying Image Size and Quality

You can specify the image size and image quality to suit the type of image you are recording.

To specify the image size

1. In the REC mode, press [MENU].
2. Use [◀] and [▶] to select the “REC” tab.
3. Use [▲] and [▼] to select “Size”, and then press [▶].
4. Use [▲] and [▼] to select the setting you want, and then press [SET].

2048 x 1536 : 2048 x 1536 pixels

1600 x 1200 : 1600 x 1200 pixels

1280 x 960 : 1280 x 960 pixels

640 x 480 : 640 x 480 pixels

NOTES

- If you plan to make large prints of your images or otherwise use them in applications where high-resolution is your top priority, select the “2048 x 1536” image size.
- If you plan to send images as e-mail attachments or otherwise use them in applications where data economy is your top priority, select the “640 x 480” image size.

To specify image quality

1. In the REC mode, press [MENU].
2. Use [◀] and [▶] to select the “REC” tab.
3. Use [▲] and [▼] to select “Quality”, and then press [▶].
4. Use [▲] and [▼] to select the setting you want, and then press [SET].

To get this:	Select this setting:
Very high quality, but large file size	Fine
Normal quality	Normal
Small file size, but low quality	Economy

NOTE

- Use the “Fine” setting when image quality is your top priority and file size is secondary. Conversely, use the “Economy” setting when file size is your top priority and image quality is secondary.

IMPORTANT!

- Actual file size depends on the type of image you record. This means that the remaining image capacity noted on the monitor screen may not be exactly accurate (pages 22, 151).

OTHER RECORDING FUNCTIONS

This chapter describes the other powerful features and functions that are available for recording.

Exposure Compensation (EV Shift)

Exposure compensation lets you change the exposure setting (EV value) manually to adjust for the lighting of your subject. This feature helps to achieve better results when recording a backlit subject, a strongly lit subject indoors, or a subject that is against a dark background.

EV Shift Range: -2.0EV to $+2.0\text{EV}$
Steps: $1/3\text{EV}$

1. In the REC mode, press [MENU].

2. Select the "REC" tab, select "EV Shift", and then press [▶].

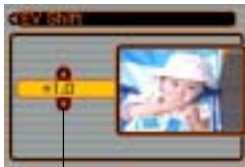

Exposure compensation value

3. Use [▲] and [▼] to change the exposure compensation value, and then press [SET].

- Pressing [SET] registers the displayed value.



EV value

[▲] : Increases the EV value. A higher EV value is best used for light-colored subjects and backlight subjects.

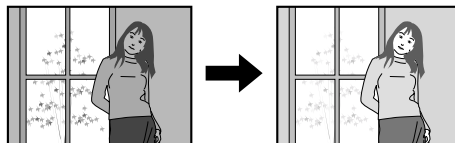

[▼] : Decreases the EV value. A lower EV value is best for dark-color subjects and for shooting outdoors on a clear day.

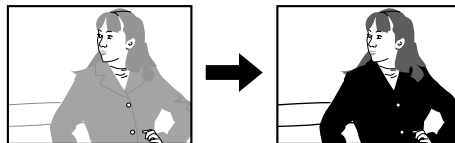

OTHER RECORDING FUNCTIONS

- To cancel EV Shift, adjust the value until it becomes 0.0.

4. Record the image.

▶▶ IMPORTANT! ◀◀

- When shooting under very dark or very bright conditions, you may not be able to obtain satisfactory results even after performing exposure compensation.

▶▶ NOTES ◀◀

- Performing an EV shift operation causes the metering mode to switch automatically to center weighted metering. Returning the EV shift value to 0.0 causes the metering mode to change back to multi-pattern metering.
- You can use key customization (page 66) to configure the camera to perform exposure compensation whenever you press [◀] and [▶] while in the REC mode.





Adjusting White Balance

The wavelengths of the light produced by various light sources (sunlight, light bulb, etc.) can affect the color of a subject when it is recorded. White balance lets you make adjustments to compensate for different lighting types, so the colors of an image appear more natural.

1. In the REC mode, press [MENU].
2. Select the “REC” tab, select “White Balance”, and then press [▶].



3. Use [▲] and [▼] to select the setting you want, and then press [SET].

When shooting under these conditions:	Select this setting:
Normal conditions	Auto
Outdoor daylight	
Shade	
Incandescent light bulb (reddish tinge)	
Fluorescent light (greenish tinge)	
Difficult lighting that requires manual control (See "Adjusting White Balance Manually".)	Manual

»» NOTES ««

- Selecting "Manual" changes white balance to the settings achieved the last time a manual white balance operation was performed.
- You can use the key customization feature (pages 66, 67) to configure the camera so the white balance setting changes whenever you press [◀] and [▶], or [▲] and [▼] while in the REC mode.

Adjusting White Balance Manually

Under some light sources, automatic white balance under the "Auto" setting can take a long time to complete. Also, the auto white balance range (color temperature range) is limited. Manual white balance helps to ensure that colors are recorded correctly for a particular light source. Note that you must perform manual white balance under the same conditions you will be shooting under. You must also have a white piece of paper or other similar object on hand in order to perform manual white balance.

1. In the REC mode, press [MENU].
2. Select the "REC" tab, select "White Balance", and then press [▶].
3. Use [▲] and [▼] to select "Manual".

- This causes the object you last used to adjust manual white balance to appear on the monitor screen.



4. Point the camera at a white piece of paper or similar object under the lighting conditions for which you want to set the white balance, and then press the shutter release button.

- This starts the white balance adjustment procedure. The message “Complete” appears on the monitor screen after white balance adjustment is complete.
- Dim lighting or pointing the camera at a dark colored object while performing manual white balance adjustment can cause the procedure to take a long time to complete.

5. Press [SET].

- This registers the white balance settings and returns to the REC mode.

Using the Best Shot Mode

Selecting one of the 15 Best Shot scenes automatically sets up the camera for recording a similar type of image.

■ Example Sample Scene



1. In the REC mode, press [MENU].
2. Select the “REC” tab, select “REC Mode”, and then press [▶].
3. Use [▲] and [▼] to select “BS (Best Shot)”, and then press [SET].
 - This enters the Best Shot mode and displays a sample scene.
4. Use [◀] and [▶] to select the sample scene you want, and then press [SET].
5. Record the image.



▶▶ IMPORTANT! ◀◀

- Sample scene number 4 is Coupling Shot scene (page 58). Sample scene number 5 is a Pre-shot scene (page 60).
- Best Shot scenes were not recorded using this camera. They are provided as samples only.
- Images recorded using a Best Shot scene may not produce the results you expected due to shooting conditions and other factors.
- After selecting a Best Shot scene, you can change to a different one by using [◀] and [▶] to scroll through available scenes. When the one you want is displayed, press [SET].

Creating Your Own Best Shot Setup

You can use the procedure below to save the setup of an image you recorded for later recall when you need it again. Recalling a setup you save automatically sets up the camera accordingly.

1. In the REC mode, press [MENU].
2. Select the “REC” tab, select “REC Mode”, and then press [▶].
3. Use [▲] and [▼] to select “BS (Best Shot)”, and then press [SET].
 - This enters the Best Shot mode and displays a sample scene.
4. Use [◀] and [▶] to display “Register Favorites”.
 
5. Press [SET].

6. Use [◀] and [▶] to display the image whose setup you want to register as a Best Shot scene.
 

7. Use [▲] and [▼] to select “Save”, and then press [SET].
 

- This registers the setup.
- Now you can use the procedure on page 55 to select your user setup for recording.

▶▶ IMPORTANT! ◀◀

- Setups that you register as Best Shot sample scenes are located after the built-in sample scenes.
- When a Best Shot user setup is recalled, the monitor screen in step 4 of the procedure on page 55 displays the text “Recall Favorites”.
- Note that formatting the built-in memory (page 106) deletes all Best Shot user setups.

▶▶ NOTES ◀◀

- Best Shot user setups are located in the camera’s built-in memory after the built-in sample scenes.
- The following are the settings that are included in a Best Shot user setup: EV shift value, white balance mode, flash mode, and ISO sensitivity.
- Note that images recorded with this camera only can be used to create a Best Shot user setup.
- You can have up to 999 Best Shot user setups in the camera’s built-in memory at one time.
- You can check the current setup of a scene by displaying the various setting menus.
- User setups are assigned file names using the format “UEXS3nnn.jpe” (where n = 0 to 9).

■ To delete a Best Shot user setup

1. In the REC mode, press [MENU].
2. Select the “REC” tab, select “REC Mode”, and then press [▶].
3. Use [▲] and [▼] to select “BS (Best Shot)”, and then press [SET].
 - This enters the Best Shot mode and displays a sample scene.
4. Use [◀] and [▶] to display the user setup you want to delete.
5. Press [▼] () to delete the user setup.
 - You can also delete a user setup by using your computer to delete its file in the “SCENE” folder in the camera’s built-in memory (page 124).

Combining Shots of Two People into a Single Image (Coupling Shot)

The Coupling Shot mode lets you record images of two people and combine them into a single image. This makes it possible for you to include yourself in group images, even when there is no one else around to record the image for you. Coupling Shot is available in the Best Shot mode (page 54).

- First Image



This is the part of the image that does not include the person who is recording the first image.



- Second Image



Making sure that the background of the image is aligned correctly, record the image of the person who recorded the first image.

- Combined Images



1. In the REC mode, press [MENU].
2. Select the "REC" tab, select "REC Mode", and then press [▶].
3. Use [▲] and [▼] to select "[BS] (Best Shot)", and then press [SET].
4. Use [◀] and [▶] to select "Coupling Shot", and then press [SET].

OTHER RECORDING FUNCTIONS

5. Use the monitor screen to compose and record the left side of the image.

- The exposure, white balance, zoom, and flash settings are fixed for this type of image.



6. Next, use the monitor screen to compose the right side of the image, taking care to align the actual background with the semi-transparent image of the background of the left-side image, which remains on the monitor screen. When everything is aligned correctly, record the image.

- Pressing [MENU] any time after step 5 of the above procedure cancels the first image and returns to step 5.



Semi-transparent image

OTHER RECORDING FUNCTIONS

Recording a Subject onto an Existing Background Image (Pre-shot)

Pre-shot helps you get the background you want, even if you need to ask someone else to record the image for you. Basically, Pre-shot is a two-step process.

1. You compose the background you want and press the shutter release button, which causes a semi-transparent image of the background to remain on the monitor screen.
2. Ask someone else to record a shot of you against your original background, telling them to compose the image by using the semi-transparent monitor screen image as a guide.
 - The camera stores the image produced by step 2 only.
 - Depending on how the image is actually composed in step 2, its background may not be exactly the same as the one you composed in step 1.

Note that Pre-shot is available in the Best Shot mode only (page 54).

- Freeze the background on the monitor screen.



- Record the image, using the background on the monitor screen as a guide.



- This records the image.



OTHER RECORDING FUNCTIONS

1. In the REC mode, press [MENU].
2. Select the “REC” tab, select “REC Mode”, and then press [▶].
3. Use [▲] and [▼] to select “BS (Best Shot)”, and then press [SET].
4. Use [◀] and [▶] to select “Pre-shot”, and then press [SET].



5. **Freeze the background on the monitor screen.**
 - Though a semi-transparent image of the background appears on the monitor screen in step 6, the background image is not saved in memory at this time.
 - The exposure, white balance, zoom, and flash settings are fixed for this type of image.

6. Next, use the monitor screen to compose the subject with the semi-transparent background shown on the monitor screen. When everything is aligned correctly, record the image.



Semi-transparent image

- This records the image composed on the monitor screen in step 6. The reference background image is not recorded.
- Pressing [MENU] any time after step 5 of the above procedure cancels the background image and returns to step 5.

OTHER RECORDING FUNCTIONS

Using the Movie Mode

You can record movies with audio, up to 30 seconds long.

- File Format: AVI
AVI format conforms to the Motion JPEG format promoted by the Open DML Group.
- Image Size: 320 x 240 pixels
- Movie File Size: Approximately 130KB/second.
- Maximum Movie Length
 - One Movie: 30 seconds
 - Total Movie Time:
80 seconds with built-in memory; 500 seconds with 64MB SD memory card

1. In the REC mode, press [MENU].

2. Select the “REC” tab, select “REC Mode”, and then press [▶].

3. Use [▲] and [▼] to select [M] (Movie), and then press [SET].

- “Remaining capacity” shows how many 30-second movies can still be recorded to memory.

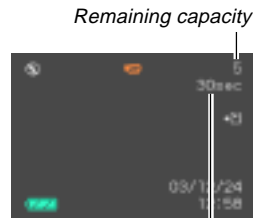

Remaining recording time

4. Point the camera at the subject and then press the shutter release button.

- Movie recording continues for 30 seconds, or until you stop it by pressing the shutter release button again.
- The remaining recording time value counts down on the monitor screen as you record.
- When movie recording is complete, the movie file is stored in file memory.
- To cancel storage of the movie file, use [▼] to select “Delete” while file storage is being performed, and then press [SET].

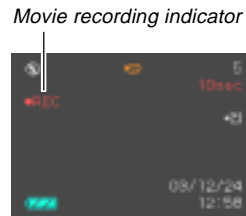

OTHER RECORDING FUNCTIONS

▶▶ IMPORTANT! ◀◀

- The flash does not fire in the Movie mode.
- This camera also records audio. Note the following points when recording a movie.

- Take care that you do not block the microphone with your fingers.

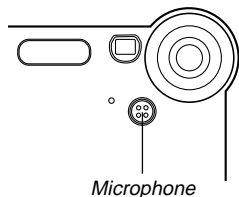

- Good recording results are not possible when the camera is too far from the subject.
- Operating camera buttons during recording can cause button noise to be included in the audio.
- Movie audio is recorded in monaural.

Using the Histogram

You can use the [DISP] button to display a histogram on the monitor screen. The histogram lets you check exposure conditions as you record images (page 23). You can also display the histogram of a recorded image in the PLAY mode.



Histogram

A histogram is a graph that represents the lightness of an image in terms of the number of pixels. The vertical axis indicates the number of pixels, while the horizontal axis indicates lightness. You can use the histogram to determine whether an image includes the shadowing (left side), mid tones (center), and highlighting (right) required to bring out sufficient image detail. If the histogram appears too lopsided for some reason, you can use EV shift (exposure compensation) to move it left or right in order to achieve better balance. Optimum exposure can be achieved by correcting exposure so the graph is as close to the center as possible.

OTHER RECORDING FUNCTIONS

- When the histogram is too far to the left, it means that there are too many dark pixels. This type of histogram results when the overall image is dark. A histogram that is too far to the left may result in “black out” of the dark areas of an image.



- When the histogram is too far to the right, it means that there are too many light pixels. This type of histogram results when the overall image is light. A histogram that is too far to the right may result in “white out” of the light areas of an image.



- A centered histogram indicates that there is good distribution of light pixels and dark pixels. This type of histogram results when the overall image is at optimal lightness.



▶▶ IMPORTANT! ◀◀

- Note that the above histograms are shown for illustrative purposes only. You may not be able to achieve exactly the same shapes for particular subjects.
- A centered histogram does not necessarily guarantee optimum exposure. The recorded image may be over-exposed or under-exposed, even though its histogram is centered.
- You may not be able to achieve an optimum histogram configuration due to the limitations of EV shift.
- Use of the flash as well as certain shooting conditions can cause the histogram to indicate exposure that is different from the actual exposure of the image when it was recorded.
- This histogram does not appear when you are using Coupling Shot (page 58).

REC Mode Camera Settings

Specifying ISO Sensitivity

Use the following procedure to select the ISO sensitivity setting that suits the type of image you are recording.

1. In the REC mode, press [MENU].
2. Select the “REC” tab, select “ISO”, and then press [▶].
3. Use [▲] and [▼] to select the setting you want and then press [SET].

To get this:	Select this setting:
Automatic sensitivity selection	Auto
Conforms with ISO 80	ISO 80
Conforms with ISO 160	ISO 160
Conforms with ISO 320	ISO 320
Conforms with ISO 640	ISO 640

▶▶ IMPORTANT! ◀◀

- Increasing ISO sensitivity can cause static to appear inside an image. Select the ISO sensitivity setting that suits your shooting needs.
- Using a high ISO sensitivity setting along with the flash to shoot a nearby subject may result in improper illumination of the subject.
- You can use the key customization feature (page 66) to configure the camera so the ISO sensitivity setting changes whenever you press [◀] and [▶] while in the REC mode.

Turning Image Review On and Off

Image review displays an image on the monitor screen as soon as you record it. Use the following procedure to turn image review on and off.

1. In the REC mode, press [MENU].
2. Select the “REC” tab, select “Review”, and then press [▶].
3. Use [▲] and [▼] to select the setting you want, and then press [SET].

To do this:	Select this setting:
Display images on the monitor screen for about one second immediately after they are recorded	On
Do not display images immediately after they are recorded	Off

Assigning Functions to the [◀] and [▶] Keys

A “key customization” feature lets you configure the [◀] and [▶] keys so they change camera settings whenever they are pressed in the REC mode. After you configure the [◀] and [▶] keys, you can change the setting assigned to them without going through the menu screen.

1. In the REC mode, press [MENU].
2. Select the “REC” tab, select “L/R Key”, and then press [▶].
3. Use [▲] and [▼] to select the setting you want, and then press [SET].

OTHER RECORDING FUNCTIONS

When you want to assign this function to [◀] and [▶] keys:	Select this:
Recording mode • [◀] and [▶] cycle through recording modes: Snapshot, Best Shot, Movie (page 142).	REC Mode
Flash mode • [◀] and [▶] cycle through the flash mode settings (page 45).	Flash
EV shift • [◀] decreases compensation, [▶] increases compensation (page 51).	EV Shift
White balance setting • [◀] and [▶] cycle through white balance settings (page 52).	White Balance
ISO sensitivity • [◀] and [▶] cycle through sensitivity settings (page 65).	ISO
No function assigned	Off

NOTE

- The initial default setting is “REC Mode”.

Assigning Functions to the [▲] and [▼] Keys

A “key customization” feature lets you configure the [▲] and [▼] keys so they change camera settings whenever they are pressed in the REC mode. After you configure the [▲] and [▼] keys, you can change the setting assigned to them without going through the menu screen.

- 1. In the REC mode, press [MENU].**
- 2. Select the “REC” tab, select “U/D Key”, and then press [▶].**
- 3. Use [▲] and [▼] to select the setting you want, and then press [SET].**

OTHER RECORDING FUNCTIONS

When you want to assign this function to [▲] and [▼] keys:	Select this:
Recording mode • [▲] and [▼] cycle through recording modes: Snapshot, Best Shot, Movie (page 142).	REC Mode
Digital Zoom • [▲] increases the digital zoom factor, [▼] decreases the digital zoom factor (page 43).	Digital Zoom
Flash mode • [▲] and [▼] cycle through the flash mode settings (page 45).	Flash
White balance setting • [▲] and [▼] cycle through white balance settings (page 52).	White Balance
Self-timer mode • [▲] and [▼] cycle through self-timer modes (page 47).	Self-timer
No function assigned	Off

»» NOTE ««

- The initial default setting is “Digital Zoom”.

Specifying Power On Default Settings

The camera’s “mode memory” feature lets you specify the power on default settings individually for the recording mode, flash mode, white balance mode, ISO sensitivity, and digital zoom mode. Turning on mode memory for a mode tells the camera to remember the status of that mode when you turn off the camera, and restore it the next time you turn the camera back on. When mode memory is turned off, the camera automatically restores the initial factory default setting for the applicable mode. The following table shows what happens when you turn mode memory on or off for each mode.

Function	On	Off
REC Mode	Setting when camera is turned off	 Snapshot
Flash		Auto
White Balance		Auto
ISO		Auto
Digital Zoom		On

1. In the REC mode, press [MENU].
2. Select the “Memory” tab, select the item you want to change, and then press [▶].
3. Use [▲] and [▼] to select the setting you want, and then press [SET].

To do this:	Select this setting:
Turn on mode memory so settings are restored at power on	On
Turn off mode memory so settings are initialized at power on	Off

▶▶ IMPORTANT! ◀◀

- Note that Best Shot mode settings take priority over mode memory settings. If you turn the camera off while in the Best Shot mode, the camera’s Flash, White Balance, and ISO Sensitivity will be configured according to the Best Shot sample scene when you turn it back on again, regardless of mode memory on/off setting.
- If you turn the camera off while in the Movie mode, the flash will be turned off when you turn the camera back on again, regardless of mode memory on/off setting.

Resetting the Camera

Use the following procedure to reset all of the camera’s settings to their initial defaults as shown under “Menu Reference” on page 142.

1. In the REC mode or the PLAY mode, press [MENU].
2. Select the “Set Up” tab, select “Reset”, and then press [▶].
3. Use [▲] and [▼] to select “Reset”, and then press [SET].
 - To cancel the procedure without resetting, select “Cancel” and press [SET].

PLAYBACK

You can use the camera's built-in monitor screen to view images after you record them.

Basic Playback Operation

Use the following procedure to scroll through files stored in the camera's memory.

1. Press the power button to turn on the camera.

- This causes an image or a message to appear on the monitor screen.

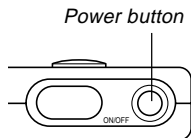

2. Align the mode selector with "PLAY".

- This enters the PLAY mode.

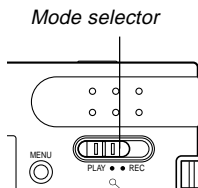

3. Use [▶] (forward) or [◀] (back) to scroll through files on the monitor screen.



NOTES

- Holding down [◀] or [▶] scrolls images at high speed.
- Note that the images produced on the monitor screen of this camera are simplified versions of the actual image stored in memory.

Flipping the Display

The following procedure flips the image 180 degrees. This comes in handy when you want to show someone standing in front of you an image on the monitor screen.

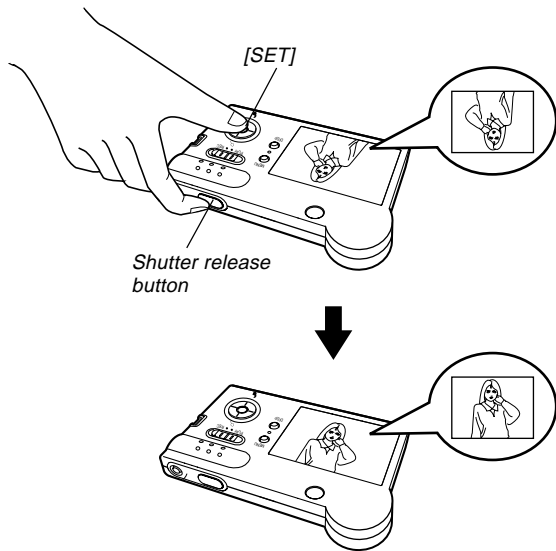

1. In the PLAY mode, use [◀] and [▶] to scroll through images on the monitor screen and display the one you want.

2. Press the shutter release button and [SET] at the same time.

- This flips the image 180 degrees. The histogram or any other display information you had displayed is cleared automatically whenever you flip the image.
- While an image is flipped, you can use [◀] and [▶] to scroll to another image, if you want.

3. To return the image to its normal orientation, press any button other than [▲], [▼], [◀], or [▶].

▶▶ IMPORTANT! ◀◀

- Note that you cannot play a movie on the monitor screen while a flipped image is displayed.
- You cannot use the above procedure to flip an image while a zoomed image, or calendar screen is on the display, or while a movie is playing.

Zooming the Display Image

Perform the following procedure to zoom the image currently on the monitor screen up to four times its normal size.

1. In the PLAY mode, use [◀] and [▶] to display the image you want.

2. Press [▲] (Q) to enlarge the image.

- This displays an indicator that shows the current zoom factor.



Current zoom factor

3. To scroll the image on the display, press [SET] and then press [▲], [▼], [◀], or [▶].

- To display the indicator for further zooming, press [SET] again.



4. Press [MENU] to return the image to its original size.

►► IMPORTANT! ◀◀

- You cannot enlarge a movie image.
- Depending on the original size of the recorded image, you may not be able to zoom a display image the full four times its normal size.

Resizing an Image

You can use the following procedure to change a snapshot image to either SXGA size (1280 x 960 pixels) or VGA size (640 x 480 pixels).

- VGA is the optimum image size for attachment to e-mail messages or incorporation into Web pages.

1. In the PLAY mode, press [MENU].

2. Select the “PLAY” tab, select “Resize”, and then press [▶].



3. Use [◀] and [▶] to scroll through images and display the one you want to resize.

4. Use [▲] and [▼] to select the setting you want, and then press [SET].

To do this:	Select this:
Resize to 1280 x 960 pixels (SXGA)	1280 x 960
Resize to 640 x 480 pixels (VGA)	640 x 480
Cancel the resizing operation	Cancel

▶▶ IMPORTANT! ◀◀

- Resizing an image creates a new file that contains the image in the size you select. The file with the original image also remains in memory.
- Images smaller than 640 x 480 pixels cannot be resized.
- Note that you can resize snapshots recorded with this camera only.
- If the message “The function is not supported for this file.” appears, it means that the current image cannot be resized.
- The resize operation cannot be performed if there is not enough memory to store the resized image.

Cropping an Image

Use the following procedure when you want to crop a portion of an enlarged image and use the remaining part of the image as an e-mail attachment, Web page image, etc.

1. In the **PLAY** mode, use [**◀**] and [**▶**] to scroll through images and display the one you want to crop.

2. Press [**MENU**].

3. Select the “**PLAY**” tab, select “**Trimming**”, and then press [**▶**].

- This causes a cropping boundary to appear.



4. Use [**▲**] and [**▼**] to make the cropping boundary smaller or larger.

- The size of the cropping boundary depends on the size of the image on the display.

5. When the cropping boundary is the size you want, press [**DISP**] to lock it.

- After pressing [**DISP**] to lock the size of the cropping boundary, you can press [**DISP**] again to unlock it. After that, you can repeat steps 4 and 5 to change the cropping boundary size.



6. Use [**▲**], [**▼**], [**◀**], and [**▶**] to move the cropping boundary up, down, left, or right until the area of the image you want to extract is within the boundary.

7. Press [**SET**] to extract the part of the image enclosed in the cropping boundary.

- If you want to cancel the procedure at any point, press [**MENU**].

▶▶ IMPORTANT! ◀◀

- Cropping an image creates a new file that contains the cropped image. The file with the original image also remains in memory.
- A Movie mode image cannot be cropped.
- An image recorded using another camera model cannot be cropped.
- If the message "The function is not supported for this file." appears, it means that the current image cannot be cropped.
- The cropping operation cannot be performed if there is not enough memory to store the cropped image.

Playing a Movie

Use the following procedure to play back a movie that was recorded in the movie mode.

- 1. In the PLAY mode, press [◀] and [▶] to scroll through images until the movie you want to play is displayed.**



- 2. Press [SET].**

- This start playback of the movie.

PLAYBACK

- You can perform the following operations while a movie is playing.

To do this:	Do this:
Fast forward or fast reverse the movie	Hold down [◀] or [▶].
Pause and unpause movie playback	Press [SET].
Skip forward or back one frame while paused	Press [◀] or [▶].
Cancel playback	Press [MENU].

►► IMPORTANT! ◀◀

- You cannot repeat play a movie. To play a movie more than once, repeat the steps of the above procedure.
- Note that this camera cannot play back a movie's audio. You need to transfer the movie file to a computer (page 112) to hear the audio.

Displaying the Calendar Screen

Use the following procedure to display a 1-month calendar. While the calendar is on the display, you can select a date, which displays the first image recorded on that date. This helps to make it easy to find the images you want.

- In the **PLAY** mode, press [MENU].
- Select the **“PLAY”** tab, select **“Calendar”**, and then press [▶].

- Use [▲], [▼], [◀], and [▶] to move the **date selection cursor**.

- Use the procedure under **“Changing the Date Format”** on page 102 to specify the date format.
- The image displayed on the calendar for each date is the first image that was recorded on that date.



Year/Month
Date selection cursor

PLAYBACK

- Pressing [▲] while the date selection cursor is located anywhere in the top line of the calendar causes the previous month to appear.
 - Pressing [▼] while the date selection cursor is located anywhere in the bottom line of the calendar causes the next month to appear.
 - To exit the calendar screen, press [MENU].
 - ☒ appears in place of the image when the date contains data that cannot be displayed by this camera.
- 4. To view the large version of a date's image, move the date selection cursor to the date and then press [SET].**
- This displays the first image that was recorded on the selected date.

Playing a Slide Show

Slide Show automatically plays back images in sequence at a fixed interval.



- 1. In the PLAY mode, press [MENU].**
- 2. Select the "PLAY" tab, select "Slideshow", and then press [▶].**

3. Configure the slideshow settings.

- See the pages indicated below for more information.

For information about configuring this setting:	Go here:
Images	"To specify the slideshow images" on page 79
Time	"To specify the slideshow time" on page 80
Interval	"To set the slideshow interval" on page 80

4. Use [▲] and [▼] to select "Start", and then press [SET].

- This starts the slide show.

5. To stop Slide Show, press any button.

- The slideshow will also stop automatically after the amount of time you specified for "Time" elapses.

►► IMPORTANT! ◀◀

- Note that all buttons are disabled while an image change is in progress. Wait until an image is stopped on the monitor screen before performing a button operation, or hold down the button until the image stops.
- Images copied from another digital camera or a computer may take longer time to appear than the slideshow interval time you specify.

To specify the slideshow images

1. Use [▲] and [▼] to select “Images”, and then press [▶].
2. Use [▲] and [▼] to select the setting you want, and then press [SET].

To do this:	Select this setting:
Include all images in file memory in the slideshow	All images
Display a single image	One Image
Include all images in the FAVORITE folder (page 93) in the slideshow	Favorites

3. Use [▲] and [▼] to select “Start”, and then press [SET].
 - This starts the slideshow.

■ Selecting a Particular Image for a Slideshow

When you select “One image” as the slideshow type, the slide show displays only one image, without changing it. Use this setting when you want a particular image to remain on the display while the camera is on the USB cradle (Photo Stand feature). Perform the following steps to specify which image you want displayed.

1. Select “One image”, and then press [▶].
2. Use [◀] and [▶] to scroll through the images until the one you want to use is on the monitor screen.
3. Press [SET] to register your selection and return to the menu screen.

- Pressing [MENU] instead of [SET] returns to the menu screen without registering the setting.



To specify the slideshow time

1. Use [▲] and [▼] to select “Time”.
2. Use [◀] and [▶] to specify the time setting you want, and then press [SET].
 - You can specify a time in the range of 1 to 60 minutes.
3. Use [▲] and [▼] to select “Start”, and then press [SET].
 - This starts the slideshow.

To set the slideshow interval

1. Use [▲] and [▼] to select “Interval”.
2. Use [◀] and [▶] to specify the interval setting you want, and then press [SET].
 - You can specify “MAX”, or a value in the range of 1 to 30 seconds as the interval.
 - In the case of a movie file, the movie is played from beginning to end when the slideshow interval is a value from 1 to 30. If “MAX” is specified as the slideshow interval, only the first frame of the movie file is displayed.
3. Use [▲] and [▼] to select “Start”, and then press [SET].
 - This starts the slideshow.

Using the Photo Stand Feature

The “Photo Stand” feature lets you specify what should appear on the camera’s monitor screen while the camera is on its USB cradle. You can play a Photo Stand slideshow without worrying about remaining battery power, or you can specify display of a particular image.

1. Set the camera onto the USB cradle.

- Do not place the camera onto the USB cradle while it is turned on.

2. Press the USB cradle’s [PHOTO] button.

- This starts the Photo Stand slideshow with the images or image you specified under “To specify the slideshow images” (page 79).
- Pressing [MENU] displays a screen for configuring slideshow settings. To restart the slideshow, press [MENU] while the menu screen is displayed, or select “Start” and then press [SET].

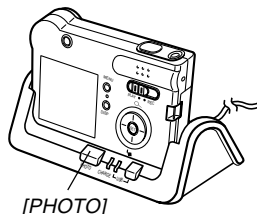

▶▶ IMPORTANT! ◀◀

- The battery is not charged while a Photo Stand slideshow is in progress. To charge the battery, stop the slideshow.

3. To stop the Photo Stand slideshow, press [PHOTO] again.

Rotating the Display Image

Use the following procedure to rotate the image 90 degrees and register the rotation information along with the image. After you do this, the image is always displayed in its rotated orientation whenever it appears during a slideshow (page 77) or on your computer screen. Note that the image is rotated automatically during a slideshow only. Rotating an image ensures that images you recorded with the camera held sideways appear correctly during a slideshow.

1. In the **PLAY** mode, press **[MENU]**.
2. Select the **“PLAY”** tab, select **“Rotation”**, and then press **[▶]**.
3. Use **[◀]** and **[▶]** to scroll through images until the one you want to rotate is on the monitor screen.

4. Use **[▲]** and **[▼]** to select **“Rotate”**, and then press **[SET]**.

- This rotates the image 90 degrees to the right.



5. After you are finished configuring settings, press the **[MENU]** button to exit the setting screen.

▶▶ IMPORTANT! ◀◀

- You cannot rotate an image that is protected. To rotate such an image, first unprotect it.

DELETING FILES

You can delete a single file, or you can delete all files currently in memory.

»» IMPORTANT! ««

- Note that file deletion cannot be undone. Once you delete a file, it is gone. Make sure you really do not need a file anymore before you delete it. Especially when deleting all files, make sure you check all the files you have stored before proceeding.
- A protected file cannot be deleted. To delete a protected file, unprotect it first (page 86).
- Delete cannot be performed when all the files in memory are protected (page 87).

Deleting a Single File

Perform the following steps when you want to delete a single file.

1. In the **PLAY** mode, press [**▼**] ()



2. Use [**◀**] and [**▶**] to scroll through files and display the one you want to delete.
3. Use [**▲**] and [**▼**] to select “Delete”.
 - To exit the file delete operation without deleting anything, select “Cancel”.
4. Press [**SET**] to delete the file.
 - Repeat steps 2 through 4 to delete other files, if you want.
5. Press [**MENU**] to exit the menu screen.

►► IMPORTANT! ◀◀

- If a file cannot be deleted for some reason, the message “The function is not supported for this file.” appears when you try to delete it.

Deleting All Files

The following procedure deletes all unprotected files currently in memory.

1. In the PLAY mode, press [▼] (🏠).
2. Use [▲] and [▼] to select “All Files Delete”, and then press [SET].
3. Use [▲] and [▼] to select “Yes”.
 - To exit the file delete operation without deleting anything, select “No”.
4. Press [SET] to delete all the files.

FILE MANAGEMENT

The file management capabilities of the camera make it easy to keep track of images. You can protect files against deletion, and even use its DPOF feature to specify images for printing.

Folders

Your camera automatically creates a directory of image storage folders in its built-in Flash memory or on the memory card.

Memory Folders and Files

An image you record is automatically stored in a folder, whose name is a serial number. You can have up to 900 folders in memory at the same time. Folder names are generated as shown below.

Example: Name of the 100th folder.

100CASIO

|
Serial number (3 digits)

Each folder can hold files numbered up to 9,999. Trying to store the 10,000th file in a folder causes the next serially numbered folder to be created. Folder names are generated as shown below.

Example: Name of the 26th file

CIMG0026.JPG

| |
Serial number (4 digits) *Extension*

- The actual number of files you will be able to store on a memory card depends on the image quality settings, capacity of the card, etc.
- For details about the directory structure, see “Memory Directory Structure” on page 124.

Protecting Files

Once you protect a file it cannot be deleted (page 83). You can protect files individually or you can protect all files in memory with a single operation.

To protect a single file

1. In the **PLAY** mode, press **[MENU]**.
2. Select the **“PLAY”** tab, select **“Protect”**, and then press **[▶]**.
 
3. Use **[◀]** and **[▶]** to scroll through files and display the one you want to protect.

4. Use **[▲]** and **[▼]** to select **“On”**, and then press **[SET]**.

- A file that is protected is indicated by the  mark.
- To unprotect a file, select **“Off”** in step 4, and then press **[SET]**.

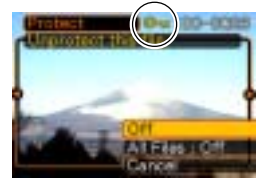

5. Press **[MENU]** to exit the menu screen.

To protect all files in memory

1. In the **PLAY** mode, press **[MENU]**.
2. Select the **“PLAY”** tab, select **“Protect”**, and then press **[▶]**.
3. Use **[▲]** and **[▼]** to select **“All Files : On”**, and then press **[SET]**.
 - To unprotect all files, press **[SET]** in step 3 so the setting shows **“All Files : Off”**.
4. Press **[MENU]** to exit the menu screen.

DPOF

The letters “DPOF” stand for “Digital Print Order Format”, which is a format for recording on a memory card or other medium which digital camera images should be printed and how many copies of the image should be printed. Then you can print on a DPOF-compatible printer or at a professional print service in accordance with the file name and number of copies settings recorded on the card.

With this camera, you should always select images by viewing them on the monitor screen. Do not specify images by file name without viewing the file contents.



■ DPOF Settings

File Name,
number of copies,
date

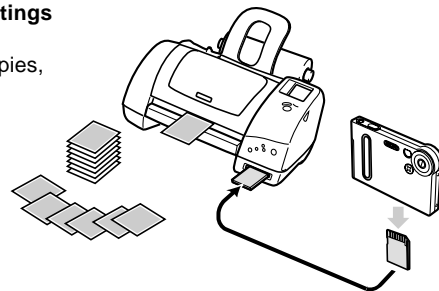

To configure print settings for a single image

1. In the PLAY mode, press [MENU].

2. Select the “PLAY” tab, select “DPOF”, and then press [▶].



3. Use [▲] and [▼] to select “Select images”, and then press [▶].

4. Use [◀] and [▶] to display the image you want.



5. Use [▲] and [▼] to specify the number of copies.

- You can specify up to 99 for the number of copies. Specify 00 if you do not want to have the image printed.

6. To turn on date stamping for the prints, press [DISP] so  is displayed.

- To turn off date stamping for the prints, press [DISP] so  is not displayed.
- Repeat steps 4 through 6 if you want to configure other images for printing.



7. After all the settings are the way you want, press [SET] to apply them.

To configure print settings for all images

1. In the **PLAY** mode, press **[MENU]**.
2. Select the “**PLAY**” tab, select “**DPOF**”, and then press **[▶]**.
3. Use **[▲]** and **[▼]** to select “**All images**”, and then press **[▶]**.
4. Use **[▲]** and **[▼]** to specify the number of copies.

- You can specify up to 99 for the number of copies. Specify 00 if you do not want to have the image printed.



5. To turn on date stamping for the prints, press **[DISP]** so  is displayed.
 - To turn off date stamping for the prints, press **[DISP]** so  is not displayed.
6. After all the settings are the way you want, press **[SET]** to apply them.

PRINT Image Matching II

Images include PRINT Image Matching II data (mode setting and other camera setup information). A printer that supports PRINT Image Matching II reads this data and adjusts the printed image accordingly, so your images come out just the way you intended when you recorded them.

* Seiko Epson Corporation holds the copyright for PRINT Image Matching and PRINT Image Matching II.



Exif Print

Exif Print is an internationally supported, open standard file format that makes it possible to capture and display vibrant digital images with accurate colors. With Exif 2.2, files include a wide range of shooting condition information that can be interpreted by an Exif Print printer to produce better-looking prints.



▶▶ IMPORTANT! ◀◀

- Information about the availability of Exif Print compatible printer models can be obtained from each printer manufacturer.

Using USB DIRECT-PRINT

Your camera supports USB DIRECT-PRINT, which was developed by Seiko Epson Corporation. When connected directly to a printer that supports USB DIRECT-PRINT, you can select images to be printed and start the print operation directly from the camera.

DPOF settings (page 87) are used to determine which images and how many copies should be printed.



1. Use the DPOF procedure on page 87 to specify the images in file memory that you want to print.
2. Connect the USB cradle to the printer.

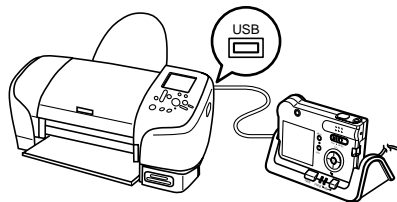

- Also, connect the AC adaptor to the USB cradle and plug the AC adaptor into an electrical outlet.
3. Set the camera on the USB cradle.
 4. Turn on the printer.
 5. Press the USB cradle [USB] button.
 - This displays the print menu on the camera's monitor screen.



6. Load paper for printing the images into the printer.

7. Configure print quality, paper, and other settings for your printer.

- See the user documentation that comes with your printer for details about configuring its settings.

8. On the camera's monitor screen, use [▲] and [▼] to select "Print", and then press [SET].

- This automatically starts printing of the images you specified with the DPOF procedure.
- If you want to print the same batch of images again, press the [USB] button on the USB cradle.
- A message appears on the monitor screen, followed by the DPOF setting screen (page 87), if there are no DPOF settings currently configured on the camera to control the printing operation. If this happens, configure the required DPOF settings and then perform step 6 of the above procedure again.
- If you want to change the current DPOF settings, select "DPOF" on the print menu to display the DPOF setting screen (page 87).

9. After printing is complete, turn off the camera and remove it from the USB cradle.

►► IMPORTANT! ◀◀

- Contact your printer manufacturer for information about models that support USB DIRECT-PRINT, upgrades, etc.
- Never disconnect the USB cable, or perform any camera or USB cradle operation while printing is in progress. Doing so causes a printer error.
- To interrupt an ongoing print operation, perform the required operation on the printer.

Using the FAVORITE Folder

You can copy scenery shots, photos of your family, or other special images from a file storage folder (page 124) to the FAVORITE folder in built-in memory (page 124). Images in the FAVORITE folder are not displayed during normal playback, so it helps to keep your personal image private as you carry them around. FAVORITE folder images are not deleted when you change memory cards, so you can always keep them on hand.

To copy a file to the FAVORITE folder

1. In the PLAY mode, press [MENU].
2. Select the "PLAY" tab, select "Favorites", and then press [▶].



3. Use [▲] and [▼] to select "Save", and then press [SET].

- This displays the names of the files in built-in memory or on the loaded memory card.



4. Use [◀] and [▶] to select the file you want to copy to the FAVORITE folder.

5. Use [▲] and [▼] to select "Save", and then press [SET].

- This copies the displayed file to the FAVORITE folder.

6. After copying all of the files you want, use [▲] and [▼] to select "Cancel", and then press [SET] to exit.

»» NOTES ««

- Copying an image file with the above procedure creates a 320 x 240-pixel QVGA-size image in the FAVORITE folder.
- A file copied into the FAVORITE folder is automatically assigned a file name that is a serial number (0001 to 9999).

To display a file in the FAVORITE folder

1. In the PLAY mode, press [MENU].
2. Select the "PLAY" tab, select "Favorites", and then press [▶].
3. Use [▲] and [▼] to select "Show", and then press [SET].
 - If the FAVORITE folder is empty, the message "No Favorites file!" appears.
4. Use [▶] (forward) and [◀] (back) to scroll through the files in the FAVORITE folder.
5. After you are finished viewing files, press [MENU] twice to exit.



»» NOTE ««

- Holding down [◀] or [▶] scrolls images at high speed.

»» IMPORTANT! ««

- Note that a FAVORITE folder is created in the camera's built-in memory only. No FAVORITE folder is created on a memory card when you use one. If you want to view the contents of the FAVORITE folder on your computer screen, you need to remove the memory card from the camera (if you are using one) before placing the camera onto the USB cradle to start data communication (pages 112, 124).

To delete a file from the FAVORITE folder

1. In the PLAY mode, press [MENU].
2. Select the "PLAY" tab, select "Favorites", and then press [▶].
3. Use [▲] and [▼] to select "Delete", and then press [SET].
4. Use [◀] and [▶] to select the file you want to delete from the FAVORITE folder.
5. Use [▲] and [▼] to select "Delete", and then press [SET].
 - This deletes the file from the FAVORITE folder.
6. After deleting all of the files you want, use [▲] and [▼] to select "Cancel", and then press [SET] to exit.

»» IMPORTANT! ««

- You cannot use the delete operations on page 83 to delete images from the FAVORITE folder. Performing the memory format operation (page 106), however, does delete FAVORITE folder files.

OTHER SETTINGS

Turning the Key Tone On and Off

Use the following procedure to turn the tone that sounds when you press a key on and off.

1. In the REC mode or the PLAY mode, press [MENU].
2. Select the “Set Up” tab, select “Beep”, and then press [▶].
3. Use [▲] and [▼] to change the setting, and then press [SET].

To do this:	Select this setting:
Turn on the key tone	On
Turn off the key tone	Off

Specifying an Image for the Startup Screen

You can specify an image you recorded with the camera as the startup screen image, which causes it to appear on the monitor screen for about two seconds whenever you turn on the camera in the REC mode.

1. In the REC mode or the PLAY mode, press [MENU].
2. Select the “Set Up” tab, select “Startup”, and then press [▶].
3. Use [◀] and [▶] to display the image you want to use as the startup image.
4. Use [▲] and [▼] to change the setting, and then press [SET].

To do this:	Select this setting:
Use the currently displayed image as the startup screen image	On
Disable the startup screen	Off

►► IMPORTANT! ◀◀

- You can select any one of the following types of image as the startup image.
 - The camera's built-in startup image
 - A snapshot you recorded with the camera
 - A movie you recorded with the camera two seconds or less in length and 200KB or less in size
- The snapshot image or movie that you select as the startup image is stored in a special memory location called "startup image memory". Only one image can be stored in startup image memory at one time. Selecting a new startup image overwrites anything that is already stored in startup image memory. Because of this, if you want to return to a previous startup image, you need to have a separate copy of that image in the camera's standard image memory. Note that you cannot delete an image from startup image memory. You can only replace it with another image.

Specifying the File Name Serial Number Generation Method

Use the following procedure to specify the method for generating the serial number used for file names (page 85).

- 1. In the REC mode or the PLAY mode, press [MENU].**
- 2. Select the "Set Up" tab, select "File No.", and then press [▶].**
- 3. Use [▲] and [▼] to change the setting, and then press [SET].**

OTHER SETTINGS

To do this for a newly saved file:	Select this setting:
Store the last file number used and increment it, regardless of whether files are deleted or whether the memory card is replaced with a new one	Continue
Find the highest file number in the current folder and increment it	Reset

Using the Alarm

You can configure up to three alarms that cause the camera to beep and display a specified image at the time you specify.

To set an alarm

1. In the **PLAY** mode, press **[MENU]**.
2. Select the **“PLAY”** tab, select **“Alarm”**, and then press **[▶]**.
3. Use **[▲]** and **[▼]** to select the alarm whose setting you want to configure, and then press **[▶]**.
4. Use **[◀]** and **[▶]** to select the setting you want to change, and then use **[▲]** and **[▼]** to change the selected setting.
 - You can set an alarm time and configure the alarm to sound either once or at the same time everyday. You can also turn the alarm on or off.

5. Press [DISP].

- You could press [SET] in place of [DISP] if you want to configure the alarm without an image.

6. Use [◀] and [▶] to select the scene you want to appear at the alarm time, and then press [SET].

7. After all the settings are the way you want, press [SET].

- You can configure up to three alarms, named “Alarm 1”, “Alarm 2”, and “Alarm 3”.

Stopping the Alarm

When an alarm time is reached while the camera is turned off, the alarm will sound for about one minute (or until you stop it), and then the camera will turn on. To stop the alarm after it starts to sound, press any button. If the camera is on the USB cradle when an alarm sounds, you can stop it by pressing the USB cradle [USB] button or [PHOTO] button, or any camera button.

►► IMPORTANT! ◀◀

- Note that the alarm sounds only if the alarm time is reached when any one of the following conditions exists.
 - While the camera is turned on
 - While a USB data communication operation is in progress
 - While a Photo Stand operation is in progress

Setting the Clock

Use the procedures in this section to select a Home Time Zone, and to change its date and time settings.

►► IMPORTANT! ◀◀

- Make sure you select your Home Time zone (the zone where you are currently located) before changing the time and date settings. Otherwise, the time and date setting will change automatically when you select another time zone.

To select your Home Time zone

1. In the REC mode or the PLAY mode, press [MENU].
2. Select the “Set Up” tab, select “World Time”, and then press [▶].
 - This displays the current World Time zone.
3. Use [▲] and [▼] to select “Home”, and then press [▶].

4. Use [▲] and [▼] to select “City”, and then press [▶].
5. Use [▲], [▼], [◀], and [▶] to select the geographical area that contains location you want to select as your Home Time zone, and then press [SET].
6. Use [▲] and [▼] to select the city you want, and then press [SET].
7. After selecting the city you want, press [SET] to register its zone as your Home Time zone.

To set the current time and date

1. In the REC mode or the PLAY mode, press [MENU].
2. Select the “Set Up” tab, select “Adjust”, and then press [▶].
3. Set the current date and the time.

To do this:	Do this:
Change the setting at the current cursor location	Press [▲] or [▼].
Move the cursor between settings	Press [◀] or [▶].
Toggle between 12-hour and 24-hour timekeeping	Press [DISP].

4. When all the settings are the way you want, press [SET] to register them and exit the setting screen.

Changing the Date Format

You can select from among three different formats for display of the date.

1. In the REC mode or the PLAY mode, press [MENU].
2. Select the “Set Up” tab, select “Date Style”, and then press [▶].
3. Use [▲] and [▼] to change the setting, and then press [SET].

Example: October 23, 2003

To display the date like this:	Select this format:
03/10/23	YY/MM/DD
23/10/03	DD/MM/YY
10/23/03	MM/DD/YY

Using World Time

You can use the World Time screen to view a time zone that is different from the home time zone when you go on a trip, etc. World Time can display the time in one of 162 cities in 32 time zones.

To display the World Time screen

1. In the REC mode or the PLAY mode, press [MENU].
2. Select the “Set Up” tab, select “World Time”, and then press [▶].
 - This displays the current World Time zone.
3. Use [▲] and [▼] to select “World”.

To do this:	Select this:
Display the time in your home time zone	Home
Display the time in a different time zone	World

4. Press [SET] to exit the setting screen.

To configure World Time settings

1. In the REC mode or the PLAY mode, press [MENU].
2. Select the “Set Up” tab, select “World Time”, and then press [▶].
 - This displays the current World Time zone.
3. Use [▲] and [▼] to select “World”, and then press [▶].
4. Use [▲] and [▼] to select “City”, and then press [▶].
5. Use [▲], [▼], [◀], and [▶] to select the geographical area you want, and then press [SET].



OTHER SETTINGS

6. Use [▲] and [▼] to select the city you want, and then press [SET].

- This displays the current time in the city you select.



7. When the setting is the way you want, press [SET] to apply it and exit the setting screen.

To configure summer time (DST) settings

1. In the REC mode or the PLAY mode, press [MENU].
2. Select the “Set Up” tab, select “World Time”, and then press [▶].
 - This displays the current World Time Settings.
3. Use [▲] and [▼] to select “World”, and then press [▶].
 - If you want to configure Home Time settings, select “Home” instead.
4. Use [▲] and [▼] to select “DST”, and then press [▶].
5. Use [▲] and [▼] to select the summer time (DST) setting you want.

To do this:	Select this:
Advance the current time setting by one hour	On
Display the current time as-is	Off

- 6. After the setting is the way you want, press [SET].**
 - This displays the current time in accordance with your setting.
- 7. Press [SET] again to exit the setting screen.**

Changing the Display Language

You can use the following procedure to select one of ten languages as the display language.

- 1. In the REC mode or the PLAY mode, press [MENU].**
- 2. Select the “Set Up” tab, select “Language”, and then press [▶].**
- 3. Use [▲], [▼], [◀], and [▶] to change the setting, and then press [SET].**

日本語 : Japanese

English : English

Français : French

Deutsch : German

Español : Spanish

Italiano : Italian

Português : Portuguese

中國語 : Chinese (Complex)

中国語 : Chinese (Simplified)

한국어 : Korean

Formatting Built-in Memory

Formatting built-in memory deletes any data stored in it.

►► IMPORTANT! ◀◀

- Note that data deleted by a format operation cannot be recovered. Check to make sure you do not need any of the data in memory before you format it.
- Formatting built-in memory deletes all files, including files in the FAVORITE folder (page 93), protected files (page 86), and Best Shot user setups (page 56).
- The startup screen image is not deleted by formatting memory.

1. Check to make sure there is no memory card loaded in the camera.

- If there is a memory card loaded in the camera, remove it (page 108).

2. In the REC mode or the PLAY mode, press [MENU].

3. Select the “Set Up” tab, select “Format”, and then press [▶].

4. Use [▲] and [▼] to select “Format”, and then press [SET].

- To exit the format operation without formatting, select “Cancel”.

USING A MEMORY CARD

You can expand the storage capabilities of your camera by using a commercially available memory card (SD memory card or MultiMedia Card). You can also copy files from built-in flash memory to a memory card and from a memory card to flash memory.



- Normally, files are stored in built-in flash memory. When you insert a memory card, however, the camera automatically stores files to the card.
- Note that you cannot save files to built-in memory while a memory card is installed in the camera.

▶▶ IMPORTANT! ◀◀

- Make sure you turn off the camera before inserting or removing a memory card.
- Be sure to orient the card correctly when inserting it. Never try to force a memory card into the slot when you feel resistance.
- See the instructions that come with the memory card for information about how to use it.
- Certain types of cards can slow down processing speeds.
- SD memory cards have a write protect switch, which you can use to protect against accidental deletion of image data. Note, however, if you write protect an SD memory card, you must remove write protection whenever you want to record to it, format it, or delete any of its files.

Using a Memory Card

To insert a memory card into the camera

1. Making sure that the contacts of the memory card are facing towards the top of the camera, carefully insert the card into the slot as far as it will go.

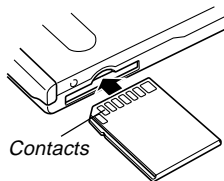

To remove a memory card from the camera

1. Press the memory card into the camera and then release it. This will cause the card to come part way out of the camera.
2. Pull the memory card out of the slot.

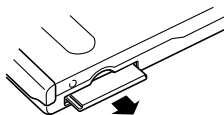
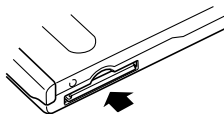

IMPORTANT!

- Never insert any other object besides a memory card into the camera's card slot. Doing so creates the risk of damage to the camera and card.
- If you are not using a memory card, be sure to insert the dummy card into this slot to protect against dust and damage.
- The dummy card is intended for use with this camera only. Never insert it into the card slot of any other type of device.
- Should water or any foreign object ever get into the card slot, immediately turn off the camera, remove the battery, and contact your dealer or nearest CASIO authorized service center.
- Never remove a card from the camera while the operation/flash charge lamp is flashing. Doing so can cause the file save operation to fail, and even damage the memory card.

Formatting a Memory Card

Formatting a memory card deletes any data already stored on it.

▶▶ IMPORTANT! ◀◀

- Be sure to use the camera to format a memory card. Formatting a memory card on a computer and then using it in the camera can slow down data processing by the camera. In the case of an SD card, formatting on a computer can result in non-conformity with the SD format, causing problems with compatibility, operation, etc.
- Note that data deleted by a memory card format operation cannot be recovered. Check to make sure you do not need any of the data on the memory card before you format it.
- Formatting a memory card that contains files deletes all the files, even those that are protected (page 86).

1. Load the memory card into the camera.
2. Turn on the camera. Next, enter the REC mode or PLAY mode and press [MENU].
3. Select the “Set Up” tab, select “Format”, and then press [▶].
4. Use [▲] and [▼] to select “Format”, and then press [SET].
 - To exit the format operation without formatting, select “Cancel”.

Memory Card Precautions

- Use only an SD memory card or a MultiMediaCard with this camera. Proper operation is not guaranteed when any other type of card is used.
- Electrostatic charge, electrical noise, and other phenomena can cause data to become corrupted or even lost. Always make sure that you always back up important data on other media (MO disc, computer hard disk, etc.)
- If a memory card starts to behave abnormally, you can restore normal operation by reformatting it. However, we recommend that you always take along more than one memory card whenever using the camera far away from the home or office.
- We recommend that you format a memory card before using it for the first time after purchasing it, or whenever the card you are using seems to be the cause of abnormal images.
- Before starting a format operation, check to make sure that the battery is fully charged. Power interruption during the format operation can result in improper formatting, and even damage the memory card and make it unusable.

Copying Files

Use the procedures below to copy files between built-in memory and a memory card.

►► IMPORTANT! ◀◀

- Only snapshot and movie files recorded with this camera can be copied. Other files cannot be copied.

To copy all the files in built-in memory to a memory card

1. Load the memory card into the camera.
2. Turn on the camera. Next, enter the **PLAY** mode and press [MENU].
3. Select the “PLAY” tab, select “Copy”, and then press [▶].



4. Use [▲] and [▼] to select “Built-in → Card”, and then press [SET].

- This starts the copy operation and displays the message “Busy... Please wait..”.
- After the copy operation is complete, the monitor screen shows the last file in the folder.

To copy a file from a memory card to built-in memory

With this procedure you can copy one file at a time.

1. Perform steps 1 through 3 of the procedure under “To copy all the files in built-in memory to a memory card”.
2. Use [▲] and [▼] to select “Card → Built-in”, and then press [SET].
3. Use [◀] and [▶] to select the file you want to copy.

4. Use [▲] and [▼] to select “Copy”, and then press [SET].

- This starts the copy operation and displays the message “Busy... Please wait..”.
- The file reappears on the monitor screen after the copy operation is complete.
- Repeat steps 3 through 4 to copy other images, if you want.

5. Press [MENU] to exit the copy operation.

»» NOTE ««

- Files are copied to the folder in built-in memory whose name has the largest number.

VIEWING IMAGES ON A COMPUTER

After using the USB cradle to establish a USB connection between the camera and your computer, you can use your computer to view images in file memory and copy images to your computer's hard disk or other storage media. In order to do this, you first need to install the USB driver located on the CD-ROM that comes bundled with the camera onto your computer.

Note that the procedure you need to perform depends on whether you are using computer running under Windows (see below) or a Macintosh (see page 117).

Using the Camera with a Windows Computer

The following are the general steps for viewing and copying files from a computer running under Windows. You can find details about each operation in the procedures that follow below. Note that you should also refer to the documentation that comes with your computer for other information about USB connections, etc.

1. If you are running Windows 98, Me, or 2000, install the USB driver onto your computer.
 - You need to perform this step only once, the first time you connect to your computer.
 - If you are running Windows XP, you do not need to install the USB driver.



2. Use the USB cradle to establish a connection between the camera and computer.



3. View and copy the images you want.

»» IMPORTANT! ««

- Do not try to establish a connection between the camera and computer before installing the USB driver onto the computer.
- If you want to transfer files from the camera's built-in memory to a computer, make sure there is no memory card loaded in the camera before you place it onto the USB cradle.

1. What you should do first depends on whether your computer is running under Windows 98/Me/2000 or Windows XP.

■ Windows 98/Me/2000 Users

- Start from step 2 to install the USB driver.
- Note that the example installation presented here uses Windows 98.

■ Windows XP Users

- Installation of the USB driver is not required, so jump directly to step 6.

2. Set the bundled CD-ROM into the CD-ROM drive of your computer.

3. On the menu screen that appears, click the language button in the upper left corner of the display, and then select a language from the list that appears.



4. Click [USB driver] and then [Install].

- This starts installation.
- The following steps show installation under the English version of Windows.

5. On the screen that appears after installation is complete, select the “Yes, I want to restart my computer now.” check box and then click [Finish] to restart your computer.

VIEWING IMAGES ON A COMPUTER

6. Connect the bundled AC adaptor to the [DC IN 5.3V] connector of the USB cradle, and then plug it in to a household power outlet.

- Note that the shape of the AC adaptor depends on the area where you purchased the camera.

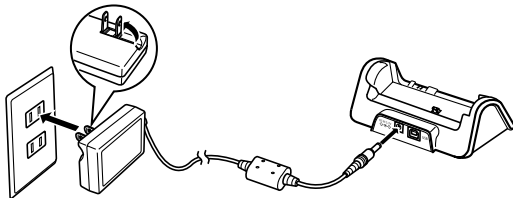
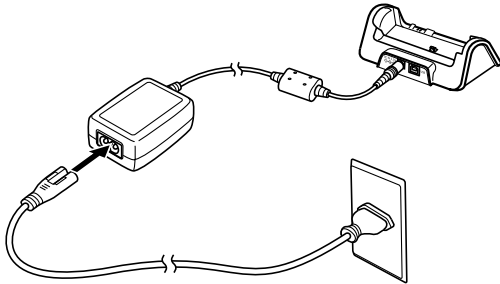

7. Connect the USB cable that comes bundled with the camera to the USB cradle and your computer's USB port.

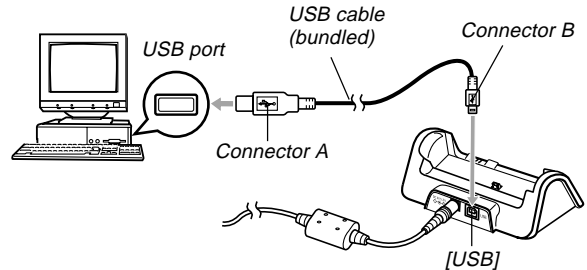

- Take care when connecting the USB cable to the USB cradle or your computer. USB ports and cable plugs are shaped for proper positioning.
- Plug the USB cable plugs into the ports securely, as far as they will go. Proper operation is not possible if connections are not correct.

8. After making sure the camera is turned off, place the camera onto the USB cradle.

- Do not place the camera onto the USB cradle while it is turned on.

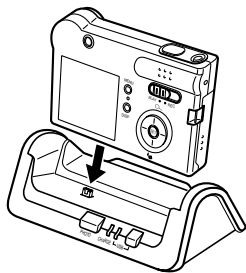

9. Press the USB cradle's [USB] button.

- This will cause the "Add New Hardware..." dialog box to appear on the computer screen as the computer automatically detects the camera's file memory. After you install the USB driver, "Add New Hardware..." dialog box will no longer appear when you perform the above steps to establish a USB connection.
- Pressing the [USB] button enters the USB mode, which causes the USB cradle's [USB] lamp to light green (page 146).
- At this point, some operating systems will display a "Removable Disk" dialog box. If your operating system does, close the dialog box.

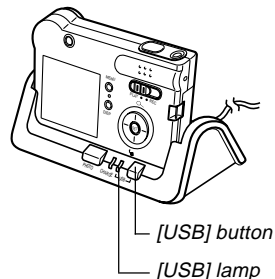

10. On your computer, double-click “My Computer”.
 11. Double-click “Removable Disk”.
 - Your computer sees the camera’s file memory as a removable disk.
 12. Double-click the “Dcim” folder.
 13. Double-click the folder that contains the image you want.
 14. Double-click the file that contains the image you want to view.
 - For information about file names, see “Memory Directory Structure” on page 124.
 15. To copy all the files in file memory to your computer’s hard disk, drag the “Dcim” folder from “Removable Disk” to the “My Documents” folder on your computer.
-
16. Depending on the version of Windows you are running, use one of the following procedures to terminate the USB connection.
 - **WindowsMe/98 Users**
 - After pressing the USB cradle [USB] button and making sure that the [USB] lamp is not lit, remove the camera from the USB cradle.
 - **Windows2000/XP Users**
 - Click card services in the task tray on your computer screen, and disable the drive number assigned to the camera. After pressing the USB cradle [USB] button and making sure that the [USB] lamp is not lit, remove the camera from the USB cradle.

USB Connection Precautions

- Be sure to read the documentation that comes with your computer for other important information about USB connections.
- Be sure to connect the AC adaptor to the USB cradle to supply power to the camera.
- USB data communication is performed regardless of the current setting of the camera's mode selector.
- Do not leave the same image displayed on your computer screen for a long time. Doing so can cause the image to "burn in" on the screen.
- Never disconnect the USB cable, or perform any camera or USB cradle operation while data communication is in progress. Doing so can cause data to become corrupted.

Using the Camera with a Macintosh Computer

The following are the general steps for viewing and copying files from a Macintosh.

You can find details about each operation in the procedures that follow below. Note that you should also refer to the documentation that comes with your Macintosh for other information about USB connections, etc.

▶▶ IMPORTANT! ◀◀

- This camera does not support operation with a computer running Mac OS 8.5.1 or lower, or Mac OS X 10.0.

1. If your operating system is anything other than Mac OS 9 or Mac OS X, install the USB driver onto your Macintosh.
 - You need to perform this step only once, the first time you connect to your computer. If you are running Mac OS 9 or Mac OS X, you do not need to install the USB driver.
2. Use the USB cradle to establish a connection between the camera and your Macintosh.
3. View and copy the images you want.

►► IMPORTANT! ◀◀

- If you want to transfer files from the camera's built-in memory to a computer, make sure there is no memory card loaded in the camera before you place it onto the USB cradle.

1. What you should do first depends on whether your Macintosh is running under Mac OS 8.6 or Mac OS 9/OS X.

■ Mac OS 8.6 Users

- Start from step 2 to install the USB driver.
- Note that the example installation presented here uses Mac OS 8.6.

■ Mac OS 9/OS X Users

- Installation of the USB driver is not required, so jump directly to step 9.
- The following steps show installation under the English OS.

2. Set the bundled CD-ROM into the Macintosh CD-ROM drive.

3. Double-click the hard disk that is specified as your startup disk.

VIEWING IMAGES ON A COMPUTER

4. On the “Hard Disk” window that opens, double-click the “System Folder” to open it.
5. On the “System Folder” window, double-click the “Extensions” folder to open it.
6. Double-click the “CASIO” folder and then the “ENGLISH” folder. Next, double-click the CD-ROM’s “USB Driver” folder to open it.
7. On the “USB Driver” window that opens, drag the “CASIO - USB StorageDriver” file and “CASIO-USB StorageClassShim” file to the “Extensions” folder window you opened above.
8. This completes USB driver installation. After checking the “Extensions” folder to make sure that it contains the “CASIO-USB StorageDriver” and “CASIO-USB StorageClassShim” files, restart your Macintosh.

9. Connect the bundled AC adaptor to the [DC IN 5.3V] connector of the USB cradle, and then plug it in to a household power outlet.

- Note that the shape of the AC adaptor depends on the area where you purchased the camera.

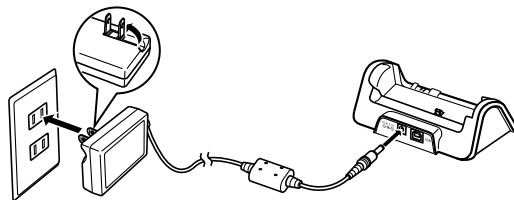
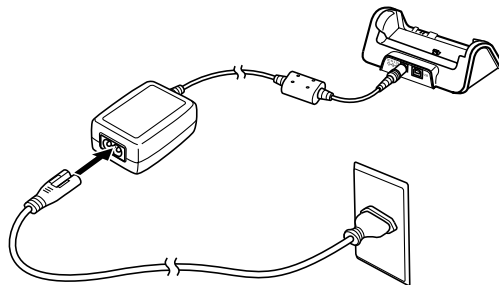

VIEWING IMAGES ON A COMPUTER

- 10. Connect the USB cable that comes bundled with the camera to the USB cradle and your computer's USB port.**

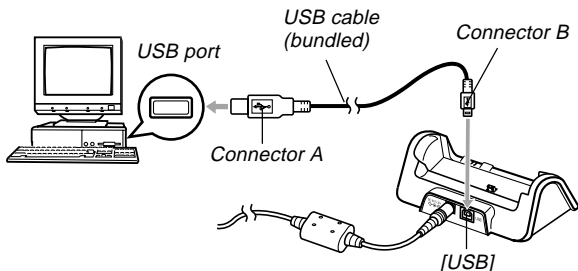

- Take care when connecting the USB cable to the USB cradle or your computer. USB ports and cable plugs are shaped for proper positioning.
- Plug the USB cable plugs into the ports securely, as far as they will go. Proper operation is not possible if connections are not correct.

- 11. After making sure the camera is turned off, place the camera onto the USB cradle.**

- Do not place the camera onto the USB cradle while it is turned on.

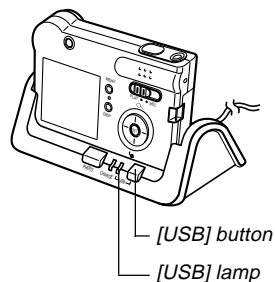

12. Press the USB cradle's [USB] button.

- Pressing the [USB] button enters the USB mode, which causes the USB cradle's [USB] lamp to light green (page 146).

13. Your Macintosh will see the camera's file memory as a drive.

- The appearance of the drive icon depends on the Mac OS version you are using.
- After installing the USB driver, your Macintosh will see the camera's file memory as a drive whenever you establish a USB connection between them.

14. Double-click the drive icon for the camera's file memory, the "DCIM" folder, and then the folder that contains the image you want.

15. Double-click the file that contains the image you want to view.

- For information about file names, see "Memory Directory Structure" on page 124.

16. To copy all the files in file memory to your Macintosh hard disk, drag the "DCIM" folder to the folder to which you want to copy it.

17. To terminate the USB connection, drag the drive icon that represents the camera to Trash. After pressing the USB cradle [USB] button and making sure that the [USB] lamp is not lit, remove the camera from the USB cradle.

USB Connection Precautions

- Be sure to read the documentation that comes with your computer for other important information about USB connections.
- Be sure to connect the AC adaptor to the USB cradle to supply power to the camera.
- USB data communication is performed regardless of the current setting of the camera's mode selector.
- Do not leave the same image displayed on your computer screen for a long time. Doing so can cause the image to "burn in" on the screen.
- Never disconnect the USB cable, or perform any camera or USB cradle operation while data communication is in progress. Doing so can cause data to become corrupted.

Operations You Can Perform from Your Computer

The following are the operations you can perform while there is a USB connection between your camera and computer. See the referenced pages for more information about each operation.

- View images in album format
.... See "Using the Album Feature" on page 127.
- Print images in album format
.... See "Using the Album Feature" on page 127.
- Automatically transfer images to your computer and manage images
.... See "Installing the Software from the CD-ROM" on page 134 for information about installing Photo Loader.
- Retouch images
.... See "Installing the Software from the CD-ROM" on page 134 for information about installing Photohands.

Using a Memory Card to Transfer Images to a Computer

The procedures in this section describe how to transfer images from the camera to your computer using a memory card.

Using a Computer with a Built-in SD Memory Card Slot

Insert the SD memory card directly into the slot.

Using a Computer with a Built-in PC Card Slot

Use a commercially available PC card adapter (for an SD memory card/MMC). For full details, see the user documentation that comes with the PC card adapter and your computer.

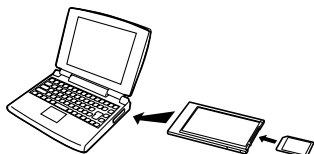

Using a Commercially Available SD Memory Card Reader/Writer

See the user documentation that comes with the SD memory card reader/writer for details about how to use it.

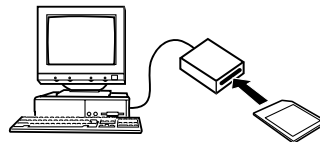

Using a Commercially Available PC Card Reader/Writer and PC Card Adapter (for SD Memory Cards and MMCs)

See the user documentation that comes with the PC card reader/writer and PC card adapter (for an SD memory card/MMC) for details about how to use them.

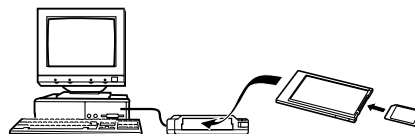

Memory Data

Images recorded with this camera and other data are stored in memory using DCF (Design rule for Camera File System) protocol. DCF protocol is designed to make it easier to exchange image and other data between digital cameras and other devices.

DCF Protocol

DCF devices (digital cameras, printers, etc.) can exchange images with each other. DCF protocol defines camera format for image file data and the directory structure for file memory, so images can be viewed using another manufacturer's DCF camera or printed on a DCF printer.

Memory Directory Structure

■ Directory Structure

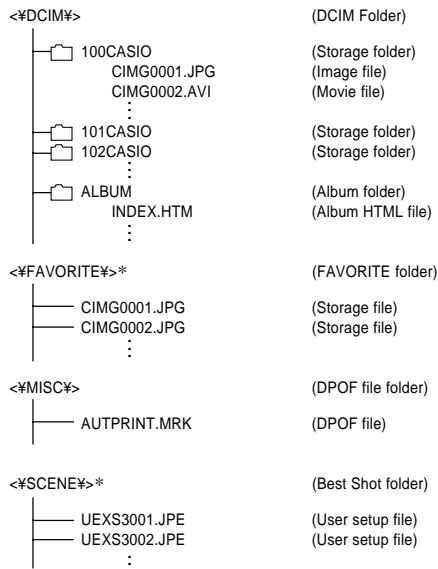

* These folders are created in built-in memory only.

■ Folder and File Contents

- **DCIM folder**
Folder that stores all of the digital camera files
- **Storage folder**
Folder for storing files created by the digital camera
- **Image file**
File that contains an image recorded with the digital camera (File Name Extension: JPG)
- **Movie file**
File that contains a movie recorded with the digital camera (File Name Extension: AVI)
- **Album folder**
Folder that contains files used by the album function
- **Album HTML file**
File used by the album function
(File Name Extension: HTM)
- **FAVORITE folder (Built-in memory only)**
Folder that contains Favorites image files
(Image Size: 320 x 240 pixels)
- **DPOF file folder**
Folder that contains DPOF files
- **Best Shot folder (Built-in memory only)**
Folder that contains Best Shot user setup files.
- **User setup files (Built-in memory only)**
Files that contain Best Shot user setups

Image Files Supported by the Camera

- Image files recorded with the CASIO EX-S3 Digital Camera
- DCF protocol image files

Certain DCF functions may not be supported. When displaying an image recorded on another camera model, it may take a long time for the image to appear on the display.

Built-in Memory and Memory Card Precautions

- Note that the folder named “DCIM” is the parent (top) folder of all the files in memory. When transferring memory contents to a hard disk, CD-R, MO disk, or other external storage, treat all the contents inside a DCIM folder as a set and always keep them together. You can change the name of the DCIM folder on your computer. Changing the name to a date is a good way to keep track of multiple DCIM folders. However, if you even want to copy the folders back to the camera’s file memory, be sure you change the name of the DCIM folder back to “DCIM” first. The camera does not recognize any folder name other than DCIM.
- We also strongly recommend that after transferring data from file memory to other external storage that you reformat the camera’s file memory and delete its contents before using it to store more files. Remember that formatting memory deletes all of its contents. Check to make sure that you no longer need any of the files in memory before you format it.

USING THE CAMERA WITH A COMPUTER

The album feature of the camera creates files that make it possible for you to view images on your computer in a photo album layout. You can also use the applications contained on the CD-ROM that comes bundled with the camera to automate image transfer and to retouch images.

Using the Album Feature

The album feature creates an HTML photo album layout that displays your images. You can use the HTML layout to post your images on a Web page, or for printing the images.



Album



Index



Info

- You can use the Web browser shown below to view or print the contents of an album. Note that to view a movie on a computer running Windows 2000 or 98, you need to install DirectX.

Microsoft Internet Explorer Ver 5.5 or later

Creating an album

1. In the PLAY mode, press [MENU].

2. Select the “PLAY” tab, select “Create Album”, and then press [▶].



Sample layout

3. Use [▲] and [▼] to select “Create”, and then press [SET].

- This starts creation of the album, and causes the message “Busy.... Please wait...”. to appear on the monitor screen.

USING THE CAMERA WITH A COMPUTER

- The PLAY mode screen reappears after creation of the album is complete.
- Creating an album causes a file folder named “ALBUM”, which contains a file named “INDEX.HTM” plus other files to be created in camera memory or on the memory card.

▶▶ IMPORTANT! ◀◀

- Never open the battery cover or remove the memory card from the camera while an album is being created. Doing so not only runs the risk of certain album files being skipped, it can also result in image data and other data in memory being corrupted.
- If memory becomes full while an album is being created, the message “Memory Full” appears on the monitor screen and album creation is terminated.
- Album creation will not be performed properly if the battery goes dead while album creation is in progress.
- You can also configure the camera to create albums automatically (page 130). However, performing the above procedure creates an album regardless of whether automatic album creation is turned on or off.

Selecting an Album Layout

You can select from among 10 different display layouts for an album.

1. In the PLAY mode, press [MENU].
2. Select the “PLAY” tab, select “Create Album”, and then press [▶].
3. Use [▲] and [▼] to select “Layout”.
4. Use [◀] and [▶] to select the layout you want.
 - Changing the layout causes the layout sample on the right side of the screen to change.

▶▶ IMPORTANT! ◀◀

- The sample layout shows the arrangement of items and the background color. It does not show whether the layout uses a list view or detailed view, or the current Image Type setting.

Configuring Detailed Album Settings

1. In the **PLAY** mode, press **[MENU]**.
2. Select the **“PLAY”** tab, select **“Create Album”**, and then press **[▶]**.
3. Use **[▲]** and **[▼]** to select **“Set Up”**, and then press **[▶]**.
4. Use **[▲]** and **[▼]** to select the item whose setting you want to change, and then press **[▶]**.
 - Details about each of the settings are provided in the following sections.
5. Use **[▲]** and **[▼]** to change the setting, and then press **[SET]**.



■ Background Color

You can specify white, black, or gray as the color of the album background using the procedure under “Configuring Detailed Album Settings”.

■ Album Type

There are two album types: Normal and Index/Info.

Normal Type : This type of album displays images in accordance with the currently selected layout.

Index/Info Type : In addition to the normal album screen, this type of album also includes thumbnails of images and detailed information about each image.

■ Image Use

This setting lets you select from among three different image uses, as described below. Select the image use that best suits the way you plan to use the image.

For this purpose:	Select this setting:
<p>Smaller images for album browsing, Website thumbnails, or archiving on a CD-R or other media, with the full-size image displayed when a thumbnail is clicked</p> <ul style="list-style-type: none"> This setting can be used for browsing with the thumbnails. Clicking a thumbnail displays a larger version for viewing or printing. 	View
<p>Small image files only for album browsing, or uploading to a Website, etc.</p> <ul style="list-style-type: none"> This option displays only the small-file images (located in the camera's "ALBUM" folder). Smaller files upload to the Internet faster. You cannot enlarge images by clicking a thumbnail or play movies while this image is selected. 	WEB
<p>Printing (high resolution)</p> <ul style="list-style-type: none"> High-resolution images take longer to display on your computer screen. You cannot enlarge images by clicking a thumbnail or play movies while this image is selected. 	Print

■ Auto Album Creation On/Off

This setting controls whether an album is created automatically whenever you turn off the camera.

To do this:	Select this option:
Turn on auto album creation	On
Turn off auto album creation	Off

- When auto album creation is turned on, an album is created automatically in built-in memory or on the memory card whenever you turn off the camera.

ⓘ IMPORTANT! ⓘ

- When you turn off the camera while auto album creation is turned on, the monitor screen turns off, but the operation/flash charge lamp continues to flash for a few seconds to indicate that the album creation process is being performed. Never open the battery cover or remove the memory card while the operation/flash charge lamp is flashing green.

NOTE

- Depending on the number of images in memory, it can take quite a bit of time to complete auto album creation when you turn off the camera. If you do not plan to use the album feature, we suggest that you keep auto album creation turned off, which shortens the amount of time the camera takes to power down completely.

Viewing Album Files

You can view and print album files using your computer's Web browser application.

1. Use your computer to access the data in built-in memory or on the memory card, or access a memory card with your computer (pages 112 and 123).
2. Open the built-in memory "ALBUM" folder or the memory card "ALBUM" folder, which is located inside the folder named "DCIM".
3. Use your computer's Web browser to open the file named "INDEX.HTM".

- This displays a list of folders in built-in memory or on the memory card.

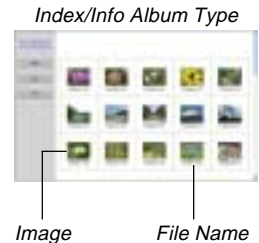

4. If you created the album after selecting “Normal” type or “Index/Info” as the album type under “Configuring Detailed Album Settings” on page 129, you can click one of the following display options.

Album: Displays an album created by the camera.

Index : Displays a list of images stored in a folder.

Info : Displays information about each image.

- If “View” is selected for “Use” (page 130), you can double-click an image on your computer screen to display the full-size version.



Album



Index



Info

USING THE CAMERA WITH A COMPUTER

- The following describes the information that appears on the Info Screen.

This Info Screen item:	Shows this:
File Size	Image file size
Resolution	Resolution
Quality	Quality
Drive mode	Drive mode
AE	Exposure mode
Light metering	Metering mode
Shutter speed	Shutter speed
Aperture stop	Aperture stop
Exposure comp	EV shift
Focusing mode	Focusing mode
Flash mode	Flash mode
Sharpness	Sharpness
Contrast	Contrast
White balance	White balance
Sensitivity	Sensitivity
Filter	Filter setting
Flash intensity	Flash intensity
Digital zoom	Digital zoom setting
World	Location
Date	Recording date and time
Model	Camera model name

» NOTES «

- When printing an album page, you should set up your Web browser as described below.
 - Select the browser frame where the images are located.
 - Set margins to the lowest possible values.
 - Set the background color to a printable color.
- See the user documentation that came with your Web browser application for details about printing and configuring settings for printing.

5. After you are finished viewing the album, exit your Web browser application.

Saving an Album

- To save an album, copy the "DCIM" folder from camera memory or the memory card to your computer's hard disk, a CD-R, an MO disk, or some other storage medium. Note that copying only the "ALBUM" folder, does not copy image data and other necessary files.
- After copying the "DCIM" folder, do not change or delete any of the files inside of it. Adding new images or deleting existing images may lead to abnormal album display.
- If you plan to use a memory card again after saving its album, first delete all of its files or format it before loading it into the camera.
- When you have "WEB" selected for the "Use" setting, the album shows only the smaller image files stored in the "ALBUM" folder. Such images can be uploaded to the Internet more quickly.

Installing the Software from the CD-ROM

About the bundled CD-ROM

The CD-ROM that comes bundled with the camera contains the applications described below. Installation of these applications is optional, and you should install only the ones you want to use.

USB Driver for Mass Storage (for Windows/Macintosh)

This is the software that makes it possible for the camera to "talk" to your personal computer over a USB connection. If you are using Windows XP, Mac OS 9, or Mac OS X, do not install the USB driver from the CD-ROM. With these operating systems, you will be able to perform USB communication simply by connecting the camera to your computer with the USB cable.

Photo Loader (for Windows/Macintosh)

This application loads image data saved in JPEG and AVI format from a digital camera to your computer.

Photohands (for Windows)

This application is for retouching and printing image files.

Internet Explorer (for Macintosh)

This is a browser application for reading HTML files. Images loaded by Photo Loader are stored in folders called "Libraries". Internet Explorer displays the contents of a library on your computer screen.

DirectX (for Windows)

This software provides an extended tool set including a codec that allows Windows 98 and 2000 to handle movie files recorded using a digital camera. You do not need to install DirectX if you are running Windows XP or Me.

Acrobat Reader (for Windows/Macintosh)

This is an application that lets you read PDF files. Use it to read the user documentation for the camera, Photo Loader, and Photohands, all of which is included on the bundled CD-ROM.

NOTE

- See the user documentation files (PDF) on the bundled CD-ROM for details about using Photo Loader and Photohands. See "Viewing User Documentation (PDF files)" on page 138 (Windows) and page 140 (Macintosh) of this manual for more information.

Computer System Requirements

Computer system requirements depend on each of the applications, as described below.

Windows

See the "Readme" file on the bundled CD-ROM.

Macintosh

See the "readme" file on the bundled CD-ROM.

Installing Software from the CD-ROM in Windows

Use the procedures in this section to install the software from the bundled CD-ROM to your computer.

NOTE

- If you already have one of the bundled applications installed on your computer, check its version. If the bundled version is newer than the one you have, you should install the newer version.

The CD-ROM includes the software and user documentation for various languages. Check the CD-ROM menu screen to see if applications and user documentation are available for a particular language.

Getting Started

Start up your computer and insert the CD-ROM into its CD-ROM drive. This will automatically launch the menu application, which displays a menu screen on your computer.



- The menu application may not start up automatically on some computers. If this happens, navigate to the CD-ROM and double-click "menu.exe" to launch the menu application.

Selecting a Language

First select a language. Note that some software is not available in all languages.

- 1. On the menu screen, click the tab for the language you want.**

Viewing the Contents of the “Read me” File

You should always read the “Read me” file for any application before installing it. The “Read me” file contains information you need to know when installing the application.

1. Click the “Read me” button for the application you are going to install.

»» IMPORTANT! ««

- Before upgrading or reinstalling Photo Loader, or before installing it onto another computer, be sure to read the “Read me” file for information about retaining existing libraries.

Installing an Application

1. Click “Install” for the application you want to install.
2. Follow the instructions that appear on your computer screen.

»» IMPORTANT! ««

- Be sure to follow the instructions carefully and completely. If you make a mistake when installing Photo Loader, you may not be able to browse your existing library information and HTML files that are created automatically by Photo Loader. In some cases, image files may be lost.
- When using an operating system other than Windows XP, never connect the camera to your computer without installing the USB driver from the CD-ROM first.

Viewing User Documentation (PDF Files)

1. In the “Manual” area, click the name of the manual you want to read.

▶▶ IMPORTANT! ◀◀

- You need to have Adobe Acrobat Reader installed on your computer to read user documentation files. If you do not already have Adobe Acrobat Reader installed, you can install it from the bundled CD-ROM.

User Registration

You can perform user registration over the Internet. To do so, of course, you need to be able to connect to the Internet with your computer.

1. Click the “Register” button.

- This starts up your Web browser and accesses the user registration website. Follow the instructions that appear on your computer screen to register.

2. After registering, terminate your connection to the Internet.

Exiting the Menu Application

1. On the menu screen, click “Exit” to exit the menu.

Installing Software from the CD-ROM on a Macintosh

The CD-ROM contains applications and user documentation in various languages in folders named for each language: English, French, German, Spanish, Italian, Dutch, and Chinese. Check the CD-ROM folders to find out if applications and user documentation are available in a particular language.

File names include one of the following codes that indicate the language of the data contained in the file as shown below.

English: e, French: f, German: g, Spanish: sp, Italian: i, Dutch: du, Chinese: ct

If your language is not included in the above, use the contents of the "English" folder.

Installing Software

Use the following procedures to install the software. We recommend that you install Internet Explorer and Outlook Express first before installing Photo Loader and Acrobat Reader.

■ To install Internet Explorer and Outlook Express

1. Open the file named "Internet Explorer".
2. Open the folder for the language version you want to install, and then open the file named "readme_casio" file.
3. Follow the instructions in the read me file to install Internet Explorer and Outlook Express.

■ To install Photo Loader

1. Open the folder named "Photo Loader".
2. Open the folder named "English", and then open the file named "Important".
3. Open the folder named "Installer", and then open the file named "readme".
4. Follow the instructions in the "readme" file to install Photo Loader.

►► IMPORTANT! ◀◀

- If you are upgrading to the new version of Photo Loader from a previous version and you want to use library management data and HTML files created using the old version of Photo Loader, be sure to read the "Important" file in the "Photo Loader" folder. Follow the instructions in the file to use your existing library management files. Failure to follow this procedure correctly can result in loss or corruption of your existing files.

■ To install Acrobat Reader

1. On the bundled CD-ROM, open the folder named "Acrobat Reader".
2. Open the folder for the language whose version of Acrobat Reader you want to install, and then open the file named "readme_casio".
 - Follow the instructions in the read me file to install Acrobat Reader.

Viewing User Documentation (PDF Files)

To perform the following procedures, you must have Acrobat Reader installed on your Macintosh.

1. On the bundled CD-ROM, open the folder named "Acrobat Reader".
2. Open the folder for the language whose version of Acrobat Reader you want to install, and then open the file named "readme_casio".
3. Follow the instructions in the read me file to install Acrobat Reader.

■ To view the camera user's guide

1. On the CD-ROM, open the "Manual" folder.
2. Open the "Digital Camera" folder, and then open the folder for the language whose user's guide you want to view.
3. Open the file named "camera_xx.pdf".
4. "xx" is the language code (English: e, French: f, German: g, Spanish: sp, Italian: i, Dutch: du, Chinese: ct).

■ To read the Photo Loader user's guide

1. On the CD-ROM, open the "Manual" folder.
2. Open the "Photo Loader" folder and then open the "English" folder.
3. Open "PhotoLoader_english".

■ To register as a user

Internet registration only is supported. Visit the following CASIO website to register:

<http://world.casio.com/qv/register/>

APPENDIX











Menu Reference

The following shows lists of menus that appear in the REC mode and PLAY mode, and their settings.

- The settings that are underlined in the following table are initial defaults.

■ REC mode

● REC tab menu

REC Mode	 (Snapshot) / <u></u> (Best Shot) /  (Movie)
Flash	<u>Auto</u> /  (Flash Off) /  (Flash On) /  (Red-eye reduction)
Self-timer	10 sec / 2 sec / X3 / <u>Off</u>
Size	<u>2048 x 1536</u> / 1600 x 1200 / 1280 x 960 / 640 x 480
Quality	Fine / <u>Normal</u> / Economy
EV Shift	-2.0 / -1.7 / -1.3 / -1.0 / -0.7 / -0.3 / <u>0.0</u> / +0.3 / +0.7 / +1.0 / +1.3 / +1.7 / +2.0
White Balance	<u>Auto</u> /  (Sunlight) /  (Shade) /  (Light Bulb) /  (Fluorescent) / Manual
ISO	<u>Auto</u> / ISO 80 / ISO 160 / ISO 320 / ISO 640
Digital Zoom	<u>On</u> / Off
Review	<u>On</u> / Off

L/R Key	<u>REC Mode</u> / Flash / EV shift / White Balance / ISO / Off
U/D Key	REC Mode / <u>Digital Zoom</u> / Flash / White Balance / Self-timer / Off

● Memory tab menu

REC Mode	<u>On</u> / Off
Flash	<u>On</u> / Off
White Balance	On / <u>Off</u>
ISO	On / <u>Off</u>
Digital Zoom	<u>On</u> / Off

APPENDIX

● Set Up tab menu

Beep	<u>On</u> / Off
Startup	On (Selectable image) / <u>Off</u>
File No.	<u>Continue</u> / Reset
World Time	<u>Home</u> / World
	Home time setup (city, DST, etc.)
	World Time setup (city, DST, etc.)
Date Style	YY/MM/DD / DD/MM/YY / MM/DD/YY
Adjust	Time setting
Language	日本語 / English / Français / Deutsch / Español / Italiano / Português / 中國語 / 中国語 / 한국어
Auto Power Off	<u>2 min</u> / 5 min
Format	Format / <u>Cancel</u>
Reset	Reset / <u>Cancel</u>

■ PLAY mode

● PLAY tab menu

Slideshow	<u>Start</u> / Images / Time / Interval
Calender	–
Favorites	<u>Show</u> / Save / Delete / Cancel
Create Album	<u>Create</u> / Layout / Set Up / Cancel
DPOF	<u>Select images</u> / All images / Cancel
Protect	<u>On</u> / All Files : On / Cancel
Rotation	<u>Rotate</u> / Cancel
Resize	<u>1280 x 960</u> / 640 x 480 / Cancel
Trimming	–
Alarm	Alarm setups
Copy	<u>Built-in → Card</u> / Card → Built-in / Cancel

● Set Up tab menu

Beep	<u>On</u> / Off
Startup	On (Selectable image) / <u>Off</u>
File No.	<u>Continue</u> / Reset
World Time	<u>Home</u> / World
	Home time setup (city, DST, etc.)
	World Time setup (city, DST, etc.)
Date Style	YY/MM/DD / DD/MM/YY / MM/DD/YY
Adjust	Time setting
Language	日本語 / English / Français / Deutsch / Español / Italiano / Português / 中國語 / 中国語 / 한국어
Auto Power Off	<u>2 min</u> / 5 min
Format	Format / <u>Cancel</u>
Reset	Reset / <u>Cancel</u>

Indicator Lamp Reference

Camera Indicator Lamps

The camera has two indicator lamps: an operation/flash charge lamp and a self-timer lamp. These lamps light and flash to indicate the current operational status of the camera.

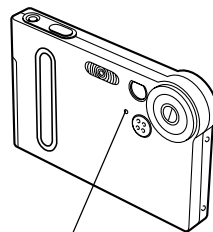

Self-timer lamp

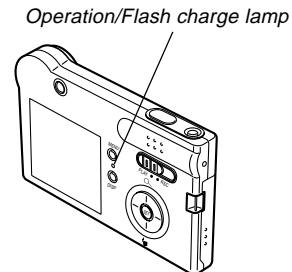

Operation/Flash charge lamp

* There are two lamp flash patterns. Pattern 1 flashes once per second, while Pattern 2 flashes twice per second. The table below explains what each flash pattern indicates.

■ REC Mode

Operation/Flash Charge Lamp		Self-timer Lamp		Meaning
Color	Status	Color	Status	
Green	Lit			Power on
Amber	Pattern 1			Flash charging
Green	Lit			Monitor screen off
Green	Pattern 2			Storing image
Green	Pattern 1	Red	Pattern 1	Self-timer countdown (10 to 3)
Green	Pattern 2	Red	Pattern 2	Self-timer countdown (3 to 1)
Red	Lit			Memory error
Red	Lit			Memory full
Red	Pattern 1			Low battery alert
Red	Pattern 1			Monitor screen disabled
Green	Pattern 2			Powering down

▶▶▶ IMPORTANT! ◀◀◀

- Never remove the memory card from the camera while the operation/flash charge lamp is flashing. Doing so will cause recorded images to be lost.

■ PLAY Mode

Operation/Flash Charge Lamp		Self-timer Lamp		Meaning
Color	Status	Color	Status	
Green	Lit			Power on
Green	Pattern 2			Deleting image
Red	Lit			Memory error
Red	Pattern 1			Low battery alert
Green	Pattern 2			Formatting
Green	Pattern 2			Powering down

USB Cradle Indicator Lamps

The USB cradle has two indicator lamps: a [CHARGE] lamp and a [USB] lamp. These lamps light and flash to indicate the current operational status of the USB cradle and camera.

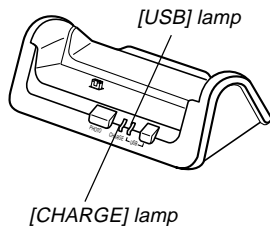

[CHARGE] lamp		[USB] lamp		Meaning
Color	Status	Color	Status	
Red	Lit			Charging
Green	Lit			Charging complete
Amber	Lit			Charge standby
Red	Flashing			Charge error
		Green	Lit	USB connection
		Green	Flashing	Accessing memory

Troubleshooting Guide

	Symptom	Possible Cause	Action
Power Supply	Power does not turn on.	<ol style="list-style-type: none"> 1) The battery is not oriented correctly. 2) The battery is dead. 	<ol style="list-style-type: none"> 1) Orient the battery correctly (page 25). 2) Charge the battery (page 26). If the battery goes dead soon after being charged, it means the battery has reached the end of its life and needs to be replaced. Purchase a separately available NP-20 rechargeable lithium ion battery.
	Camera suddenly powers down.	<ol style="list-style-type: none"> 1) Auto Power Off activated (page 34). 2) The battery is dead. 	<ol style="list-style-type: none"> 1) Turn power back on. 2) Charge the battery (page 26).
Image Recording	Image is not recorded when the shutter release button is pressed.	<ol style="list-style-type: none"> 1) The mode selector is set to "PLAY". 2) Flash unit is being charged. 3) Memory is full. 	<ol style="list-style-type: none"> 1) Align the mode selector with "REC". 2) Wait until the flash unit finishes charging. 3) Transfer files you want to keep to your computer and then delete files from image memory, or use a different memory card.
	Camera powers down during self-timer countdown.	The battery is dead.	Charge the battery (page 26).
	Recorded images are not saved in memory.	<ol style="list-style-type: none"> 1) Camera powers down before the save operation is complete. 2) Removing the memory card before the save operation is complete. 	<ol style="list-style-type: none"> 1) When the battery indicator shows , charge the battery as soon as possible (page 26). 2) Do not remove the memory card before the save operation is complete.

APPENDIX

	Symptom	Possible Cause	Action
Playback	Color of the playback image is different from the image on the monitor screen during recording.	Sunlight or light from another source is shining directly into the lens during recording.	Position the camera so sunlight does not shine directly into the lens.
	Images are not displayed.	A memory card with non-DCF images recorded with another camera is loaded in the camera.	This camera cannot display non-DCF images recorded onto a memory card using another digital camera.
Other	All buttons and switches are disabled.	Circuit problem caused by electrostatic charge, impact, etc. while the camera was connected to another device.	Remove the battery from the camera, reinsert it, and then try again.
	Monitor screen is off.	<ol style="list-style-type: none"> 1) USB communication is in progress. 2) The monitor screen is turned off (in a recording mode). 	<ol style="list-style-type: none"> 1) After the computer stops accessing camera file memory, press the [USB] button on the USB cradle. Check to make sure that the [USB] lamp on the USB cradle is off, and then remove the camera from the USB cradle. 2) Press [DISP] to turn on the monitor screen.
	Cannot transfer files over a USB connection.	<ol style="list-style-type: none"> 1) Camera is not set securely on the USB cradle. 2) USB cable is not connected securely. 3) USB driver is not installed. 4) Camera is turned off. 	<ol style="list-style-type: none"> 1) Check the connection between the camera and USB cradle. 2) Check all connections. 3) Install the USB driver on your computer (pages 112, 117). 4) Press the [USB] button on the USB cradle.

Display Messages

Battery is low.	The battery is dead.
BEST SHOT memory is full.	You are attempting to register a Best Shot setup when the "SCENE" folder already contains 999 setups.
Card ERROR	Some problem occurred with the memory card. Turn off the camera, and remove and then reinsert the memory card. If the same message appears, format the memory card (page 109). »» IMPORTANT! «« Formatting the memory card deletes all files on the memory card. Before formatting, try transferring recoverable files to a computer or some other storage device.
File could not be saved because battery is low.	The battery is dead, so the recorded image could not be saved.
Folder cannot be created.	This message appears when you try to record an image while there are 9,999 files stored in the 999th folder. If you want to record more files, delete files you no longer need (page 83).
Memory Full	Memory is full. If you want to record more files, delete files you no longer need (page 83).

Printing Error	One of the following problems occurred during printing. <ul style="list-style-type: none"> • Printer power off • Out of paper • Out of ink • Printer internal error
Record Error	Image compression could not be performed during image data storage for some reason. Record the image again.
SYSTEM ERROR	Your camera system is corrupted. Contact your retailer or a CASIO service center.
The card is locked.	The LOCK switch of the SD memory card is locked. You cannot store images to or delete images from a memory card that is locked.
The card is not formatted.	The memory card is not formatted. Format the memory card (page 109).
The function is not supported for this file.	The function you are trying to perform is not supported for the file on which you are trying to perform it.
There are no files.	There are no files in built-in memory or on the memory card.

There are no printing images.	There are no DPOF settings specifying images and the number of copies of each for printing.
Set up DPOF.	Configure the required DPOF settings (page 87).
This file cannot be played.	The image file or audio file is corrupted, or is a type that cannot be displayed by this camera.
This function cannot be used.	You attempted to copy files from built-in memory to a memory card while there is no memory card loaded in the camera (page 110).
Can not find the file.	The camera cannot find the image specified by the slideshow "Images" setting. Specify another image (page 77).

Specifications

Main Specifications

Product: Digital Camera

Model: EX-S3

■ Camera Functions

Image Files Format

Snapshots: JPEG (Exif Ver.2.2); DCF (Design rule for Camera File system) 1.0 standard; DPOF compliant

Movies: AVI (Motion JPEG)

Recording Media: 10MB built-in Flash memory
SD Memory Card
Multimedia Card

Image Size

Snapshots: 2048 x 1536 pixels
1600 x 1200 pixels
1280 x 960 pixels
640 x 480 pixels

Movies: 320 x 240 pixels

APPENDIX

Approximate Memory Capacity and File sizes:

• Snapshots

File Size (pixels)	Quality	Approximate Image File Size	Built-in flash memory 10MB	SD Memory Card* 64MB
2048 x 1536	Fine	1.6MB	5 shots	34 shots
	Normal	1.2MB	7 shots	45 shots
	Economy	630KB	14 shots	88 shots
1600 x 1200 (UXGA)	Fine	1050KB	8 shots	53 shots
	Normal	710KB	12 shots	79 shots
	Economy	370KB	24 shots	154 shots
1280 x 960 (SXGA)	Fine	680KB	13 shots	82 shots
	Normal	460KB	20 shots	126 shots
	Economy	250KB	35 shots	221 shots
640 x 480 (VGA)	Fine	190KB	46 shots	294 shots
	Normal	140KB	61 shots	386 shots
	Economy	90KB	98 shots	618 shots

• Movies (320 x 240 pixels)

Data Size	130KB/second max.
Recording Time	One Movie: 30 seconds maximum Total Movie Time: 80 seconds maximum (built-in memory) 500 seconds maximum (SD 64MB memory card)*

* Based on Matsushita Electric Industrial Co., Ltd. products. Capacity depends on card manufacturer.

* To determine the number of images that can be stored on a memory card of a different capacity, multiply the capacities in the table by the appropriate value.

Delete: Single-file, all files (with protection)

Effective Pixels 3.2 million

Imaging Element 1/1.8-inch square pixel color CCD
(Total pixels: 3.35 million)

Lens/Focal Distance F4.2; f=7.1mm (equivalent to approximately 35 for 35mm film)

Zoom: 4X digital zoom

Focusing: Fixed focal point

Approximate Focus Range (from lens surface) 80cm to ∞ (2.6' to ∞)

Exposure Control

Light Metering: Multi-pattern by CCD

Exposure: Program AE

Exposure Compensation: ... -2EV to +2EV (1/3EV units)

Shutter: CCD electronic shutter; mechanical shutter, 1 to 1/6400 second
(Depends on REC mode and ISO sensitivity setting being used.)

Aperture: F4.2/fixed

White Balance: Automatic, fixed (4 modes), manual switching

Self-timer: 10 seconds, 2 seconds, Triple Self-timer

APPENDIX

Built-in Flash

Flash Modes: AUTO, ON, OFF, Red eye reduction
Flash Range: 0.8 to 2 meters (2.6' to 6.6')
(ISO Sensitivity: "Auto")

Recording Functions: Snapshot; Best Shot; Movie

Monitor Screen: 2.0-inch TFT color LCD
84,960 pixels (354 x 240)

Viewfinder: Monitor screen and optical viewfinder

Timekeeping Functions Built-in digital quartz clock
Date and Time: Recorded with image data
Auto Calendar: To 2049

World Time: City; Date; Time; Summer time;
162 cities in 32 time zones

Input/Output Terminals: ... Cradle connector

■ Power Requirements

Power Requirements: Rechargeable lithium ion battery
(NP-20) x 1

Approximate Battery Life:

Continuous Recording (Continuous Snapshot Recording)	80 minutes (480 shots)
Continuous Playback	120 minutes

The values noted above are approximate values until power fails at normal temperature (25°C (77°F)). The above does not guarantee that you will be able to achieve this level of operation. Low temperatures shorten battery life (page 30).

Power Consumption: DC 3.7V Approximately 3.5W

Dimensions: 89.5(W) x 57(H) x 11.7(D) mm
(3.5"(W) x 2.2"(H) x 0.5"(D))
(excluding projections)

Weight: Approximately 72 g (2.5 oz)
(excluding battery and accessories)

Bundled Accessories: Rechargeable lithium ion battery (NP-20); USB cradle (CA-22); Special AC adaptor; USB cable; Dummy Card; Strap; CD-ROM; Basic Reference

APPENDIX

■ Rechargeable Lithium Ion Battery (NP-20)

Rated Voltage: 3.7 V

Rated Capacitance: 680 mAh

Operating Temperature

Range: 0°C to 40°C (32°F to 104°F)

Dimensions: 33 (W) x 50 (H) x 4.7 (D) mm
(1.3" (W) x 2.0" (H) x 0.19" (D))

Weight: Approximately 16 g (0.56 oz)

■ USB Cradle (CA-22)

Input/Output Terminals Camera connector; USB port; AC adaptor terminal (DC IN 5.3V)

Power Consumption DC 5.3V Approximately 3.4W

Dimensions 109(W) x 38.5(H) x 57(D) mm
(4.3"(W) x 1.5"(H) x 2.2"(D))
(excluding projections)

Weight Approximately 61 g (2.1 oz)

■ Special AC Adaptor (Inlet Type)

Power Requirement 100 to 240V AC, 50/60Hz, 0.12A

Output 5.3V DC, 1.0A

Dimensions 48(W) x 28(H) x 66(D) mm
(1.9"(W) x 1.1"(H) x 2.6"(D))
(excluding projections and cable)

Weight Approximately 120 g (4.2 oz)

■ Special AC Adaptor (Plug-in Type)

Power Requirement 100 to 240V AC, 50/60Hz, 0.12A

Output 5.3V DC, 1.0A

Dimensions 47(W) x 20(H) x 72(D) mm
(1.9"(W) x 0.8"(H) x 2.8"(D))
(excluding projections and cable)

Weight Approximately 110 g (3.9 oz)

APPENDIX

Power Supply

- Use only the special NP-20 rechargeable lithium ion battery to power this camera. Use of any other type of battery is not supported.
- This camera does not have a separate battery for the clock. The date and time settings of the camera are cleared whenever power is totally cut off (from both the battery and USB cradle). Be sure to reconfigure these settings after power is interrupted (page 38).

LCD Panel

- The LCD panel is a product of the latest LCD manufacturing technology that provides a pixel yield of 99.99%. This means that less than 0.01% of the total pixels are defective (they do not turn on or always remain turned on).

Free Manuals Download Website

<http://myh66.com>

<http://usermanuals.us>

<http://www.somanuals.com>

<http://www.4manuals.cc>

<http://www.manual-lib.com>

<http://www.404manual.com>

<http://www.luxmanual.com>

<http://aubethermostatmanual.com>

Golf course search by state

<http://golfingnear.com>

Email search by domain

<http://emailbydomain.com>

Auto manuals search

<http://auto.somanuals.com>

TV manuals search

<http://tv.somanuals.com>