

# CASIO®

Digital Camera

# EX-Z280

## User's Guide

E

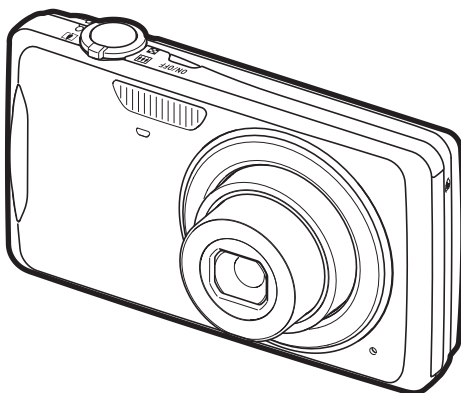

Thank you for purchasing this CASIO product.

- Before using it, be sure to read the precautions contained in this User's Guide.
- Keep the User's Guide in a safe place for future reference.
- For the most up-to-date information about this product, visit the official EXILIM Website at <http://www.exilim.com/>

To go to “Getting the Most Out of Dynamic Photo” click here!

Dynamic Photo

# EXILIM

Download from [www.Somanuals.com](http://www.Somanuals.com). All Manuals Search And Download.

## Unpacking

As you unpack your camera, check to make sure that all items shown below are included. If anything is missing, contact your original retailer.

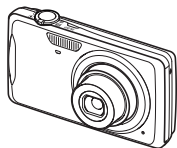

Digital camera

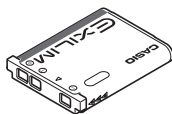

Rechargeable lithium ion battery (NP-80)

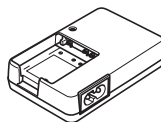

Charger unit (BC-80L)

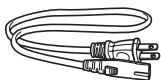

\* The shape of the power cord plug varies according to country or geographic area.

Power cord



To attach the strap to the camera

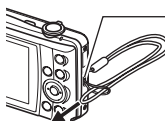

Attach strap here.

Strap



USB cable

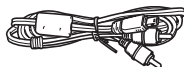

AV cable



CD-ROM

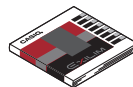

Basic Reference

## Read this first!

- The contents of this manual and the bundled Basic Reference are subject to change without notice.
- The contents of this manual have been checked at each step of the production process. Feel free to contact us if you notice anything that is questionable, erroneous, etc.
- Any copying of the contents of this User's Guide, either in part or its entirety, is forbidden. Except for your own personal use, any other use of the contents of this manual without the permission of CASIO COMPUTER CO., LTD. is forbidden under copyright laws.
- CASIO COMPUTER CO., LTD. shall not be held liable for any damages or lost profits suffered by you or any third party due to the use or malfunction of this product.
- CASIO COMPUTER CO., LTD. shall not be held liable for any damages, lost profits, or claims by third parties arising out of the use of Photo Transport or YouTube Uploader for CASIO.
- CASIO COMPUTER CO., LTD. shall not be held liable for any damages or lost profits caused by loss of memory contents due to malfunction, repair, or any other reason.
- Note that the example screens and product illustrations shown in this User's Guide may differ somewhat from the screens and configuration of the actual camera.

### LCD Panel

The liquid crystal panel of the monitor screen uses high-precision technology that provides a pixel yield in excess of 99.99%. This means that some very small number of pixels may not light or may remain lit at all times. This is due to the characteristics of the liquid crystal panel, and does not indicate malfunction.

#### Take a few test shots

Before shooting your final image, shoot a test shot to ensure that the camera is recording correctly.

# Contents

Unpacking .....	2
Read this first! .....	3
General Guide .....	9
Monitor Screen Contents .....	10

## ■ Quick Start Basics 13

---

What is a digital camera? .....	13
What you can do with your CASIO camera .....	14
First, charge the battery prior to use .....	15
■ To charge the battery .....	15
■ To load the battery .....	16
Configuring Basic Settings the First Time You Turn On the Camera .....	18
Preparing a Memory Card .....	19
■ Supported Memory Cards .....	19
■ To load a memory card .....	19
■ To format (initialize) a new memory card .....	20
Turning the Camera On and Off .....	21
■ To turn power on .....	21
■ To turn off the camera .....	21
To shoot a snapshot .....	22
Holding the Camera Correctly .....	25
Viewing Snapshots .....	26
Deleting Images .....	27
■ To delete a single file .....	27
■ To delete all files .....	27
Snapshot Shooting Precautions .....	28
■ Auto Focus Restrictions .....	28

## ■ Snapshot Tutorial 29

---

Using the Control Panel .....	29
■ Specifying Control Panel Items .....	30
Changing the Image Size .....	(Size) .. 30
Using Flash .....	(Flash) .. 33
Specifying the Auto Focus Area .....	(AF Area) .. 35
Specifying ISO Sensitivity .....	(ISO) .. 36
Using Continuous Shutter .....	(CS) .. 37
■ Specifying the Method for Saving Continuous Shutter Images .....	38
Using Face Detection .....	(Face Detection) .. 40
Shooting with the Make-up Mode .....	(Make-up) .. 42
Using the easy Mode .....	43
Changing the Control Panel Date/Time Style .....	45
Shooting with Zoom .....	45
■ Optical Zoom and Digital Zoom Switch Point .....	46

## ■ Recording Movie Images and Audio 48

---

To record a movie	48
Using Prerecord Movie	50
Shooting a Snapshot while Shooting a Movie	51
Recording Audio Only (Voice Recording)	51
■ To play back an audio recording	52

## ■ Using BEST SHOT 53

---

What is BEST SHOT?	53
■ Some Sample Scenes	53
To shoot an image with BEST SHOT	53
■ Creating Your Own BEST SHOT Setups	56
Shooting with AUTO BEST SHOT	57
Shooting ID Photographs	58
Shooting Images of Business Cards and Documents	59
Recording a Self-portrait	60
Isolating Moving Subjects (Multi-motion Image)	61

## ■ Advanced Settings 62

---

Using On-screen Menus	62
REC Mode Settings (REC)	64
■ Selecting a Focus Mode (Focus)	64
■ Using Continuous Shutter (CS)	67
■ Using the Self-timer (Self-timer)	68
■ Using Auto Shutter (Auto Shutter)	69
■ Shooting with Face Detection (Face Detection)	72
■ Reducing the Effects of Camera and Subject Movement (Anti Shake)	73
■ Specifying the Auto Focus Area (AF Area)	74
■ Changing the Focus Frame Shape (Focus Frame)	74
■ Turning Digital Zoom On or Off (Digital Zoom)	75
■ Assigning Functions to the [◀] and [▶] Keys (L/R Key)	75
■ Shooting with Quick Shutter (Quick Shutter)	76
■ Using the easy Mode (easy Mode)	76
■ Displaying the On-screen Grid (Grid)	77
■ Turning on Image Review (Review)	77
■ Using Icon Help (Icon Help)	77
■ Configuring Power On Default Settings (Memory)	78
Image Quality Settings (Quality)	79
■ Specifying Snapshot Size (Size)	79
■ Specifying Snapshot Image Quality (Quality (Snapshot))	79
■ Specifying Movie Image Quality (Quality (Movie))	80
■ Correcting Image Brightness (EV Shift)	81
■ Controlling White Balance (White Balance)	82
■ Specifying ISO Sensitivity (ISO)	83
■ Specifying the Metering Mode (Metering)	83
■ Optimizing Image Brightness (Lighting)	84
■ Using Built-in Color Filters (Color Filter)	84

■ Controlling Image Sharpness . . . . .	(Sharpness) . . . . .	84
■ Controlling Color Saturation . . . . .	(Saturation) . . . . .	85
■ Adjusting Image Contrast . . . . .	(Contrast) . . . . .	85
■ Specifying Flash Intensity . . . . .	(Flash Intensity) . . . . .	85

## ■ Viewing Snapshots and Movies 86

---

Viewing Snapshots . . . . .	86
Viewing a Movie . . . . .	86
Viewing Continuous Shutter Images . . . . .	87
■ Deleting Continuous Shutter Images . . . . .	88
■ Dividing Up a CS Group . . . . .	89
Zooming an On-screen Image . . . . .	90
Displaying the Image Menu . . . . .	91
Displaying Images in the Calendar Screen . . . . .	91
Viewing Snapshots and Movies on a TV Screen . . . . .	92

## ■ Other Playback Functions (PLAY) 94

---

Playing a Slideshow on the Camera . . . . .	(Slideshow) . . . . .	94
■ Saving Music from Your Computer to Camera Memory . . . . .		95
Laying Out Snapshots with Layout Print . . . . .	(Layout Print) . . . . .	97
Creating a Snapshot of Movie Frames . . . . .	(MOTION PRINT) . . . . .	98
Editing a Movie on the Camera . . . . .	(Movie Editing) . . . . .	99
Optimizing Image Brightness . . . . .	(Lighting) . . . . .	101
Using Red Eye Correction . . . . .	(Red Eye) . . . . .	101
Adjusting White Balance . . . . .	(White Balance) . . . . .	102
Adjusting the Brightness of an Existing Snapshot . . . . .	(Brightness) . . . . .	103
Keystone Correction . . . . .	(Keystone) . . . . .	103
Using Color Correction to Correct the Color of an Old Photograph . . . . .	(Color Correction) . . . . .	104
Selecting Images for Printing . . . . .	(DPOF Printing) . . . . .	105
Protecting a File Against Deletion . . . . .	(Protect) . . . . .	105
Editing the Date and Time of an Image . . . . .	(Date/Time) . . . . .	106
Rotating an Image . . . . .	(Rotation) . . . . .	106
Resizing a Snapshot . . . . .	(Resize) . . . . .	107
Cropping a Snapshot . . . . .	(Trimming) . . . . .	107
Adding Audio to a Snapshot . . . . .	(Dubbing) . . . . .	108
■ To play snapshot audio . . . . .		109
Copying Files . . . . .	(Copy) . . . . .	110

## ■ Dynamic Photo 111

---

To create a subject image to be inserted . . . . .	(Dynamic Photo) . . . . .	111
Inserting a Subject into a Background Image . . . . .	(Dynamic Photo) . . . . .	113
■ To view a Dynamic Photo . . . . .		114
Converting a Dynamic Photo to a Movie . . . . .	(Movie Converter) . . . . .	114

Printing Snapshots . . . . .	115
Connecting Directly to a PictBridge Compatible Printer . . . . .	116
Using DPOF to Specify Images to be Printed and the Number of Copies . . . . .	118

Things you can do using a computer. . . . .	121
Using the Camera with a Windows Computer . . . . .	122
■ Viewing and Storing Images on a Computer. . . . .	123
■ Playing Movies . . . . .	126
■ Uploading Movie Files to YouTube . . . . .	127
■ Transferring Images from Your Computer to Camera Memory . . . . .	129
■ Viewing User Documentation . . . . . (PDF Files) . . . . .	131
■ User Registration . . . . .	131
Using the Camera with a Macintosh . . . . .	132
■ Connecting the Camera to Your Computer and Saving Files . . . . .	132
■ Transferring Images Automatically and Managing Them on Your Macintosh . . . . .	134
■ Playing a Movie. . . . .	135
■ Viewing User Documentation . . . . . (PDF Files) . . . . .	136
■ User Registration . . . . .	136
Files and Folders . . . . .	137
Memory Card Data . . . . .	138

REC Mode Control Panel Display . . . . . (Panel) . . . . .	140
Selecting a PLAY Mode Screen Layout . . . . . (Display) . . . . .	141
Configuring Camera Sound Settings . . . . . (Sounds) . . . . .	142
Configuring a Startup Image . . . . . (Startup) . . . . .	142
Specifying the File Name Serial Number Generation Rule . . . . . (File No.) . . . . .	143
Configuring World Time Settings . . . . . (World Time) . . . . .	143
Time Stamping Snapshots . . . . . (Timestamp) . . . . .	144
Setting the Camera's Clock . . . . . (Adjust) . . . . .	145
Specifying the Date Style . . . . . (Date Style) . . . . .	145
Specifying the Display Language . . . . . (Language) . . . . .	146
Configuring Sleep State Settings . . . . . (Sleep) . . . . .	146
Configuring Auto Power Settings . . . . . (Auto Power Off) . . . . .	147
Configuring [ ] and [ ] Settings . . . . . (REC/PLAY) . . . . .	147
Configuring USB Protocol Settings . . . . . (USB) . . . . .	148
Selecting the Screen Aspect Ratio and Video Output System . . . . . (Video Out) . . . . .	148
Formatting Built-in Memory or a Memory Card . . . . . (Format) . . . . .	149
Resetting the Camera to Factory Defaults . . . . . (Reset) . . . . .	149

---

## ■ ■ **Configuring Monitor Screen Settings** **150**

---

Using the On-screen Histogram to Check Exposure . . . . .	150
■ How to Use the Histogram . . . . .	151

## ■ ■ **Appendix** **152**

---

Precautions during Use . . . . .	152
Power Supply . . . . .	159
■ Charging . . . . .	159
■ To replace the battery . . . . .	160
■ Battery Precautions. . . . .	160
■ Using the Camera in another Country . . . . .	161
Using a Memory Card . . . . .	161
■ To replace the memory card . . . . .	161
Computer System Requirements for Bundled Software . . . . . (Bundled CD-ROM) . . . . .	163
Reset Initial Default Settings . . . . .	164
When things don't go right... . . . .	167
■ Troubleshooting . . . . .	167
■ Display Messages. . . . .	172
Number of Snapshots/Movie Recording Time/Voice Recording Time . . . . .	175
Specifications . . . . .	177



## General Guide

The numbers in parentheses indicate the pages where each item is explained.

### ■ Camera

#### Front

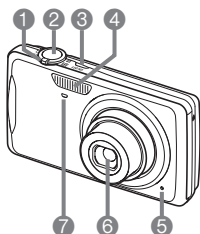

- 1 Zoom controller (pages 22, 45, 90, 91)
- 2 Shutter button (page 22)
- 3 [ON/OFF] (Power) (page 21)
- 4 Flash (page 33)
- 5 Microphone (pages 49, 108)
- 6 Lens (pages 25, 68)
- 7 Front lamp

#### Back

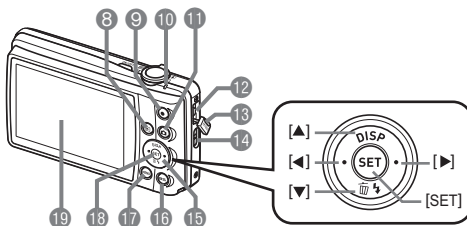

- 8 [▶] (PLAY) button (pages 21, 26)
- 9 [●] (movie) button (page 48)
- 10 Back lamp (pages 21, 23, 33)
- 11 [📷] (REC) button (pages 21, 22)
- 12 USB/AV port (pages 92, 116, 124, 133)
- 13 Connector cover
- 14 Strap hole (page 2)
- 15 Control button ([▲] [▼] [◀] [▶]) (pages 27, 29, 33, 62, 150)
- 16 [BS] button (page 53)
- 17 [MENU] button (page 62)
- 18 [SET] button (page 29)
- 19 Monitor screen (pages 10, 150)

#### Bottom

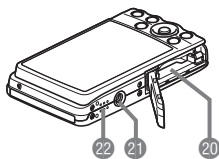

- 20 Battery/memory card slots (pages 16, 19, 160, 161)
- 21 Tripod hole  
Use this hole when attaching to a tripod.
- 22 Speaker

### ■ Charger Unit

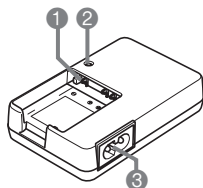

- 1 ⊕ ⊖ Contacts
- 2 [CHARGE] Lamp
- 3 AC jack

## Monitor Screen Contents

The monitor screen uses various indicators, icons, and values to keep you informed of the camera's status.

- The sample screens in this section are intended to show you the locations of all the indicators and figures that can appear on the monitor screen in various modes. They do not represent screens that actually appear on the camera.

### ■ Snapshot Recording

#### Panel : On

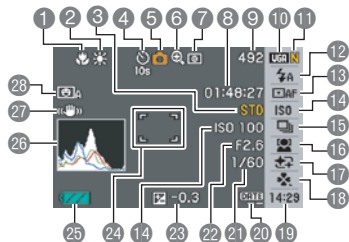

- 1 Focus mode (page 64)
- 2 White balance setting (page 82)
- 3 Movie image quality (page 80)
- 4 Self-timer (page 68)
- 5 Recording mode (page 22)
- 6 Image deterioration indicator (page 46)
- 7 Metering mode (page 83)
- 8 Remaining movie memory capacity (page 48)
- 9 Remaining snapshot memory capacity (page 175)
- 10 Snapshot image size (page 30)
- 11 Snapshot image quality (page 79)
- 12 Flash (page 33)
- 13 AF Area (page 35)
- 14 ISO sensitivity (page 36)
- 15 Continuous shutter (page 37)
- 16 Face Detection (page 40)
- 17 Make-up (page 42)
- 18 easy Mode (page 43)
- 19 Date/time (page 45)
- 20 Timestamp indicator (page 144)
- 21 Shutter speed
- 22 Aperture value
- 23 Exposure compensation (page 81)
- 24 Focus frame (pages 22, 35)
- 25 Battery level indicator (page 17)
- 26 Histogram (page 150)
- 27 Anti Shake (page 73)
- 28 Auto shutter (page 69)

#### Panel : Off

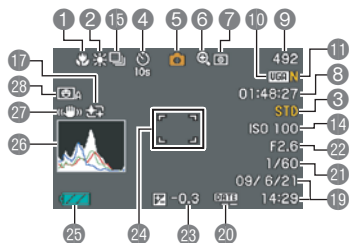

### NOTE

- If the current aperture, shutter speed, ISO sensitivity, or Auto Exposure is not correct, the setting will turn orange when you half-press the shutter button.

## easy Mode

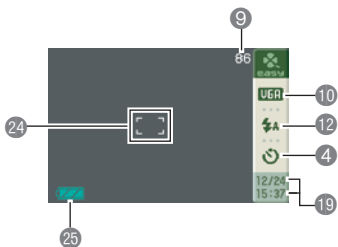

## Movie Recording

### Panel : On

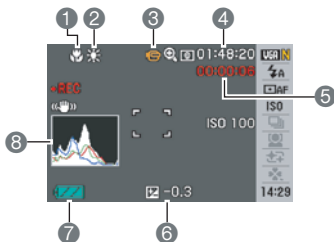

- 1 Focus mode (page 64)
- 2 White balance setting (page 82)
- 3 Recording mode (page 48)
- 4 Remaining movie memory capacity (page 48)
- 5 Movie recording time (page 48)
- 6 Exposure compensation (page 81)
- 7 Battery level indicator (page 17)
- 8 Histogram (page 150)

### Panel : Off

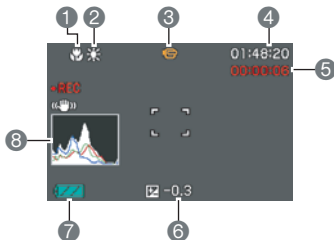

## ■ Snapshot Viewing

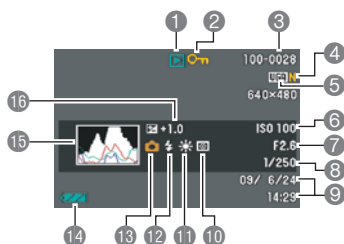

- 1 File type
- 2 Protect indicator (page 105)
- 3 Folder name/file name (page 137)
- 4 Snapshot image quality (page 79)
- 5 Snapshot image size (page 30)
- 6 ISO sensitivity (page 36)
- 7 Aperture value
- 8 Shutter speed
- 9 Date/time (page 45)
- 10 Metering mode (page 83)
- 11 White balance setting (page 102)
- 12 Flash (page 33)
- 13 Recording mode
- 14 Battery level indicator (page 17)
- 15 Histogram (page 150)
- 16 Exposure compensation (page 81)

## ■ Movie Playback

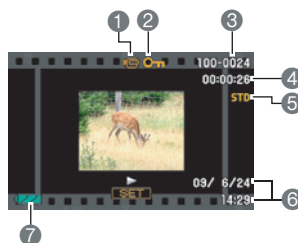

- 1 File type
- 2 Protect indicator (page 105)
- 3 Folder name/file name (page 137)
- 4 Movie recording time (page 86)
- 5 Movie image quality (page 80)
- 6 Date/time (page 45)
- 7 Battery level indicator (page 17)

# Quick Start Basics

## What is a digital camera?

A digital camera stores images on a memory card, so you can record and delete images a countless number of times.

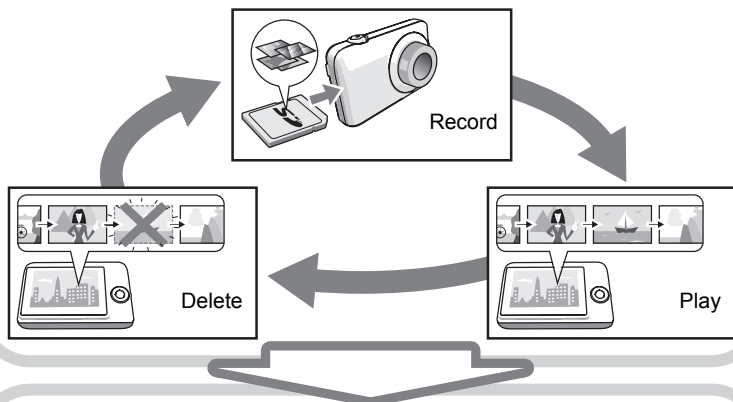

You can use the images you record in a variety of different ways.

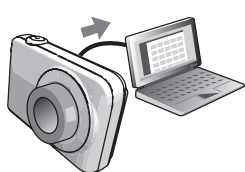

Store images on your computer.

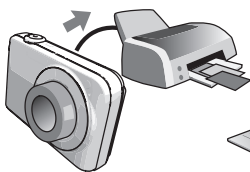

Print images.



Attach images to e-mail.

## What you can do with your CASIO camera

Your CASIO camera is packed with a powerful selection of features and functions to make recording of digital images easier, including the following three main functions.

### Dynamic Photo



Extract a moving subject out of a series of Continuous Shutter images you have shot and insert them into another image to create a Dynamic Photo image that features the moving subject.

See page **111** for more information.



### Make-up Mode

This feature smoothes the skin texture of the subject and softens facial shadows caused by harsh sunlight for better looking portraits.

See page **42** for more information.



### BEST SHOT

Simply select the sample scene you want and the camera sets up automatically. Then all you need do is press the shutter button for perfect images. An AUTO BEST SHOT mode automatically selects the appropriate BEST SHOT sample scene based on current shooting conditions.

See page **53** for more information.

## First, charge the battery prior to use.

Note that the battery of a newly purchased camera is not charged. Perform the steps under "To charge the battery" to bring the battery to a full charge.

- Your camera requires a special CASIO rechargeable lithium ion battery (NP-80) for power. Never try to use any other type of battery.

### To charge the battery

- 1. Positioning the positive  $\oplus$  and negative  $\ominus$  terminals of the battery with those of the charger unit, load the battery into the charger unit.**

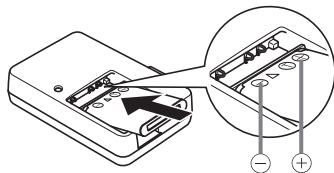

- 2. Plug the charger unit into a household power outlet.**

About 100 minutes are required to reach full charge. The [CHARGE] lamp will go out when charging is complete. Unplug the power cord from the power outlet and then remove the battery from the charger.

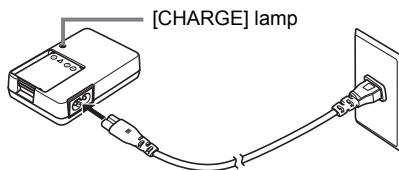

Lamp Status	Description
Lit Red	Charging
Flashing Red	Abnormal ambient temperature, charger problem, or battery problem (page 159)
Off	Charging complete

## Other Charging Precautions

- Use the special charger (BC-80L) to charge the special lithium ion battery (NP-80). Never use any other type of charger device. Attempting to use a different charger can result in unexpected accident.
- A battery that is still warm due to normal use may not charge fully. Give the battery time to cool before charging it.
- A battery discharges slightly even when it is not loaded in the camera. Because of this, it is recommended that you charge the battery immediately before you need to use it.
- Charging the camera's battery may cause interference with TV and radio reception. If this happens, plug the charger into an outlet that is further away from the TV or radio.
- Actual charging time depends on current battery capacity and charging conditions.

## To load the battery

### 1. Open the battery cover.

Pressing the battery cover, slide it in the direction indicated by the arrow.

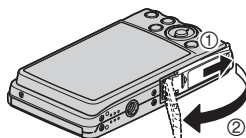

### 2. Load the battery.

With the EXILIM logo on the battery facing downwards (in the direction of the lens), hold the stopper next to the battery in the direction indicated by the arrow as you slide the battery into the camera. Press the battery in until the stopper secures it in place.

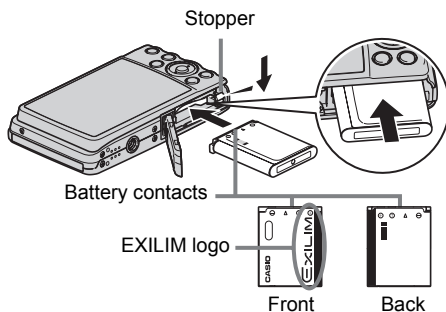



### 3. Close the battery cover.



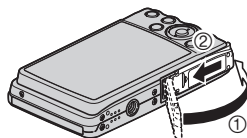

Pressing the battery cover against the camera, slide it closed.

- For information about how to replace the battery, see page 160.



### Checking Remaining Battery Power

As battery power is consumed, a battery indicator on the monitor screen indicates remaining power as shown below.

Remaining Power	High ←————→ Low
Battery Indicator	 →  →  → 
Indicator Color	Cyan → Amber → Red → Red

 indicates battery power is low. Charge the battery as soon as possible.

Recording is not possible when  is indicated. Charge the battery immediately.

- The level shown by the battery indicator may change when you switch between the REC mode and PLAY mode.
- Leaving the camera for about two days with no power supplied while the battery is dead will cause its date and time settings to be cleared. A message telling you to configure time and date settings will appear the next time you turn on the camera after restoring power. When this happens, configure date and time settings (page 145).
- See page 179 for information about battery life and memory capacity.

### Battery Power Conservation Tips

- When you do not need to use the flash, select  (Flash Off) for the flash setting (page 33).
- Enable the Auto Power Off and the Sleep features to protect against wasting battery power when you forget to turn off the camera (pages 146, 147).

## Configuring Basic Settings the First Time You Turn On the Camera

The first time you load a battery into the camera, a screen appears for configuring the display language, date, and time settings. Failure to set the date and time correctly will cause the wrong date and time data to be recorded with images.



### IMPORTANT!

- A screen for language selection will not appear in step 2 of the procedure below if you purchased a camera intended for the Japanese market. To change the display language from Japanese in this case, use the procedure under “Specifying the Display Language (Language)” (page 146). Note that a version of this manual in the language you select may not be included with a camera intended for the Japanese market.

**1. Press [ON/OFF] to turn on the camera.**

**2. Use [▲], [▼], [◀], and [▶] to select the language you want and then press [SET].**

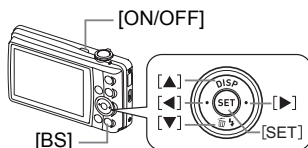

**3. Use [▲] and [▼] to select a date style and then press [SET].**

Example: 19. 12. 09

YY/MM/DD → 09/12/19

DD/MM/YY → 19/12/09

MM/DD/YY → 12/19/09

**4. Set the date and the time.**

Use [◀] and [▶] to select the setting you want to change and then use [▲] and [▼] to change it. To switch between 12-hour and 24-hour format, press [BS].



**5. After setting the date and time, use [◀] and [▶] to select “Apply” and then press [SET].**

If you make a mistake configuring display language, date, or time settings with the above procedure, refer to the following pages for information about how to correct the settings.

- Display language: Page 146
- Date and time: Page 145

## NOTE

- Each country controls its local time offset and the use of summer time, and so they are subject to change.
- Removing the battery from the camera too soon after configuring time and date settings for the first time can cause the settings to be reset to their factory defaults. Do not remove the battery for at least 24 hours after configuring settings.

## Preparing a Memory Card

Though the camera has built-in memory that can be used to store images and movies, you probably will want to purchase a commercially available memory card for greater capacity. The camera does not come with a memory card. Images recorded while a memory card is loaded are saved to the memory card. When no memory card is loaded, images are saved to built-in memory.

- For information about memory card capacities, see page 175.

## Supported Memory Cards

- SD Memory Card
- SDHC Memory Card



Use one of the above types of memory card.

\* This model does not support use of an Eye-Fi card.

## To load a memory card

### 1. Press [ON/OFF] to turn off the camera and then open the battery cover.

Pressing the battery cover, slide it in the direction indicated by the arrow.

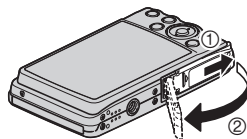

### 2. Load a memory card.

Positioning the memory card so its front is facing upwards (towards the monitor screen side of the camera), slide it into the card slot all the way in until you hear it click securely into place.

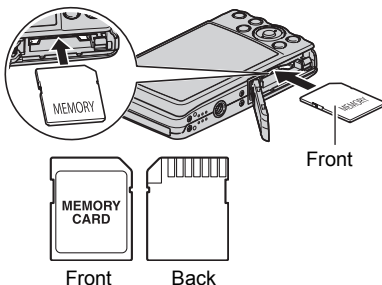

---

### 3. Close the battery cover.

Pressing the battery cover against the camera, slide it closed.

- For information about how to replace the memory card, see page 161.

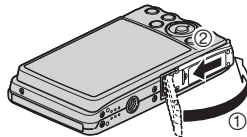

### **IMPORTANT!**

- Never insert anything besides a supported memory card (page 19) into the memory card slot.
- Should water or any foreign object ever get into the card slot, immediately turn off the camera, remove the battery, and contact your retailer or nearest CASIO authorized service center.

---

## To format (initialize) a new memory card

---

You need to format a new memory card before using it for the first time.

**1. Turn on the camera and press [MENU].**

**2. Select the “Set Up” tab, select “Format” and then press [▶].**

**3. Use [▲] and [▼] to select “Format” and then press [SET].**

### **IMPORTANT!**

- Formatting a memory card that already has snapshots or other files on it, will delete its contents. Normally you do not need to format a memory card again. However, if storing to a card has slowed down or if you notice any other abnormality, re-format the card.
- Be sure to use the camera to format a memory card. Formatting a memory card on a computer and then using it in the camera can slow down data processing by the camera. In the case of an SD or SDHC memory card, formatting on a computer can result in non-conformity with the SD format, causing problems with compatibility, operation, etc.

## Turning the Camera On and Off

### To turn power on

To enter the REC mode, press [ON/OFF] (Power) or [RECORD] (REC). To enter the PLAY mode, press [PLAY] (PLAY).

The back lamp will light (green) momentarily and the camera will turn on. If you are entering the REC mode, the lens will extend from the camera at this time.

- Take care to ensure that nothing is restricting or coming into contact with the lens as it extends. Holding the lens with your hand so it cannot extend creates the risk of malfunction.
- Pressing [PLAY] (PLAY) while in the REC mode switches to the PLAY mode. The lens retracts about 10 seconds after switching modes.
- The Sleep function or Auto Power Off (pages 146, 147) will turn off power automatically if you do not perform any operation for a preset amount of time.

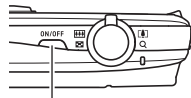

[ON/OFF] (Power)

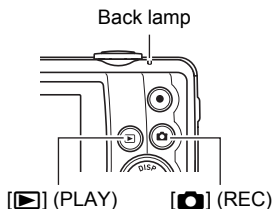

### To turn off the camera

Press [ON/OFF] (Power).

- You can configure the camera so power does not turn on when you press [RECORD] (REC) or [PLAY] (PLAY). You also can configure the camera to turn off when you press [RECORD] (REC) or [PLAY] (PLAY) (page 147).

## To shoot a snapshot

### 1. Press [📷] (REC) to turn on the camera.

Make sure  is on the display. If it isn't, see page 53.

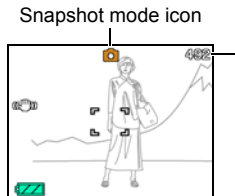

Remaining Snapshot Memory Capacity (page 175)

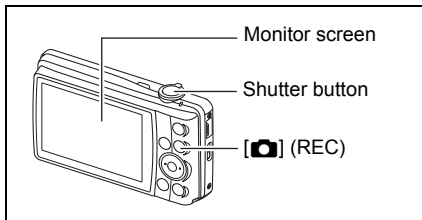

### 2. Point the camera at the subject.

You can zoom the image, if you want.

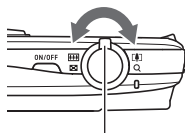

Zoom controller



 Wide Angle



 Telephoto

### 3. Half-press the shutter button to focus the image.

When focus is complete, the camera will beep, the back lamp will light green, and the focus frame will turn green.

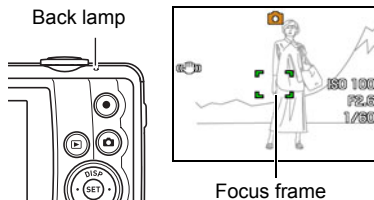

#### Half-press

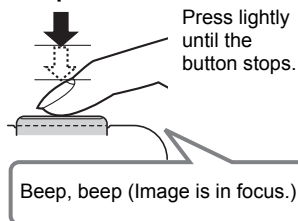

When you half-press the shutter button, the camera automatically adjusts exposure and focuses on the subject it is currently pointed at. Mastering how much pressure is required for a half-press and a full-press of the shutter button is an important technique for good-looking images.

- The focus frame in the screen shots included in this manual is shown at [ ] . Note that you can change the form of the focus frame, if you want (page 74).

### 4. Continuing to keep the camera still, press the shutter button the rest of the way down.

This records the snapshot.

#### Full-press

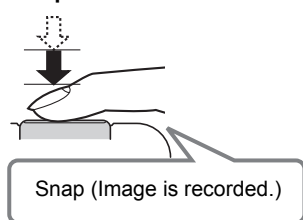

#### Shooting a Movie

Press [●] (Movie) to start movie recording. Press [●] (Movie) again to stop movie recording. See page 48 for details.

[●] (Movie)

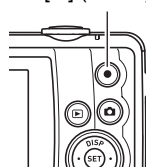

### ■ Using Quick Shutter

Fully pressing the shutter button without waiting for Auto Focus to operate will record using Quick Shutter (page 76).

- With Quick Shutter, the camera focuses faster than normal Auto Focus, which means you can capture quick moving action more easily. Note, however, that some images may be out of focus when Quick Shutter is used.
- Whenever possible, take a little extra time to half-press the shutter button in order to ensure proper focus.

### ■ If the image does not focus...

If the focus frame stays red and the back lamp is flashing green, it means that the image is not in focus (because the subject is too close, etc.) Re-point the camera at the subject and try to focus again.

### ■ If the subject is not in the center of the frame...

“Focus lock” (page 67) is the name of a technique you can use when you want to shoot an image in which the subject to be focused on is not within the focus frame in the center of the screen.

### ■ To track the movement of a moving subject

Half-press the shutter button to follow and focus automatically on a moving subject. See “ Tracking” (page 35) for more information.



## Holding the Camera Correctly

Your images will not come out clearly if you move the camera when you press the shutter button. When pressing the shutter button, be sure to hold the camera as shown in the illustration below, and keep it still by pressing your arms firmly against your sides as you shoot.

Holding the camera still, carefully press the shutter button and take care to avoid all movement as the shutter releases and for a few moments after it releases. This is especially important when available lighting is low, which slows down the shutter speed.

### Horizontal



### Vertical



Hold the camera so the flash is above the lens.

### NOTE

- Take care that your fingers and the strap do not cover any of the areas indicated in the illustration.
- To protect against accidentally dropping the camera, attach the wrist strap and make sure it is around your fingers or wrist while you are operating the camera.
- Never swing the camera around by its strap.
- The supplied strap is intended for use with this camera only. Never use it for any other purpose.

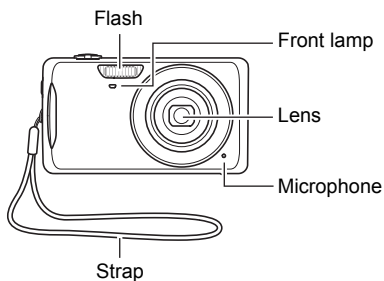

## Viewing Snapshots

Use the following procedure to view snapshots on the camera's monitor screen.

- For information about how to play back movies, see page 86.

### 1. Press [▶] (PLAY) to enter the PLAY mode.

- This will display one of the snapshots currently stored in memory.
- Information about the displayed snapshot also is included (page 175).
- You also can clear the information to view only the snapshot (page 150).
- You can zoom in on the image by sliding the zoom controller towards [▲] (page 90). If you are recording a snapshot that is very important to you, it is recommended that you zoom the image and check its details after recording it.

[▶] (PLAY)

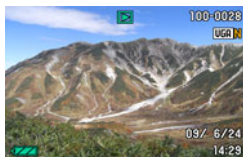
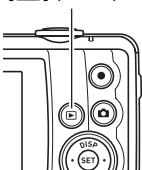

### 2. Use [◀] and [▶] to scroll between images.

- Holding down either button scrolls at high speed.



#### NOTE

- Half-pressing the shutter button while in the PLAY mode or while a menu screen is displayed will switch directly to the REC mode.

## Deleting Images

If memory becomes full, you can delete images you no longer need to free up storage and record more images.



### IMPORTANT!

- Remember that a file (image) delete operation cannot be undone.
- Deleting an audio snapshot (page 109) deletes both the snapshot and the audio file.

### To delete a single file

1. Press **[▶]** (PLAY) to enter the PLAY mode and then press **[▼]** (  ).



Delete All Files  
Delete  
Cancel

2. Use **[◀]** and **[▶]** to scroll through the files until the one you want to delete is displayed.

3. Use **[▲]** and **[▼]** to select “Delete” and then press **[SET]**.
  - To delete other files, repeat steps 2 and 3.
  - To exit the delete operation, press **[MENU]**.

### To delete all files

1. Press **[▶]** (PLAY) to enter the PLAY mode and then press **[▼]** (  ).
2. Use **[▲]** and **[▼]** to select “Delete All Files” and then press **[SET]**.
3. Use **[▲]** and **[▼]** to select “Yes” and then press **[SET]** to delete all files. This will cause the message “There are no files” to appear.

## Snapshot Shooting Precautions

### Operation

- Never open the battery cover while the back lamp is flashing green. Doing so can result in the image you just shot being saved incorrectly, damage to other images stored in memory, malfunction of the camera, etc.
- If unwanted light is shining directly onto the lens, shade the lens with your hand when shooting an image.

### Monitor Screen when Shooting Snapshots

- Subject brightness conditions can cause monitor screen response to slow and can cause digital noise in the monitor screen image.
- The image that appears on the monitor screen is for image composition. The actual image will be recorded at the quality set for the image quality setting (page 79).

### Shooting Indoors under Fluorescent Lighting

- Minute flickering of fluorescent lighting can affect the brightness or color of an image.

### Auto Focus Restrictions

- Any of the following can make proper focus impossible.
  - Solid color wall or other very low contrast subject
  - Strongly back lit subject
  - Very shiny subject
  - Blinds or other subject with a repeating horizontal pattern
  - Multiple subjects at varying distances from the camera
  - Subject in a dark location
  - Camera movement while shooting
  - Fast-moving subject
  - Subjects outside the focus range of the camera
- If you cannot focus properly, try using focus lock (page 67) or Manual Focus (page 64).

## Using the Control Panel

The Control Panel can be used to configure camera settings.

### 1. In the REC mode, press [SET].

This will select one of the Control Panel icons and display its settings.

[▲] [▼] [◀] [▶]

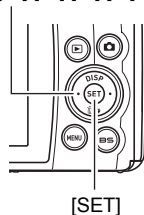

### 2. Use [▲] and [▼] to select the setting you want to change.

- 1 Image size/Quality\* (pages 30, 79)
- 2 Flash (page 33)
- 3 AF Area (page 35)
- 4 ISO sensitivity (page 36)
- 5 Continuous shutter (page 37)
- 6 Face Detection (page 40)
- 7 Make-up (page 42)
- 8 easy Mode (page 43)
- 9 Date/Time (page 45)

Available settings Control Panel

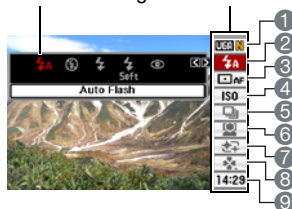

\* Snapshot image quality cannot be changed using the Control Panel.

### 3. Use [◀] and [▶] to change the setting.

### 4. If you want to configure another setting, repeat steps 2 and 3.

### 5. After all of the settings are the way you want, press [SET].

This will apply the settings and return to the REC mode.

#### NOTE

- You can configure the camera to turn off display of the Control Panel when you press [SET] (page 140).
- You also can configure settings other than those listed above (page 62).
- The Control Panel cannot be displayed while a Dynamic Photo, Prerecord Movie, For YouTube, or Voice Recording Operation is in progress.

## Specifying Control Panel Items

You can use the following procedure to specify the eight items you want on the Control Panel.

**1. In the REC mode, press [SET] to display the Control Panel. Next, press [MENU].**

- This will display a menu of Control Panel items, with the items currently selected for display shown in green.



**2. Use [▲], [▼], [◀], and [▶] to select an item you want on the Control Panel and then press [SET].**

This will cause the lamp next to the item to light.

**3. Repeat the above step to select eight items for the Control Panel.**

After you select the eighth item, the camera switches to the REC mode and displays the Control Panel.

- To exit the item select operation, press [MENU].

### NOTE

- The “Date/Time” item at the bottom of the Control Panel is fixed and cannot be changed.
- The screen shots in this manual show the initial default Control Panel items.
- To return the Control Panel items to their initial defaults, reset the camera (page 149).

## Changing the Image Size (Size)

### ■ Pixels

A digital camera image is a collection of small dots called “pixels”. The more pixels there are in an image, the more detail there will be. However, you generally can do with fewer pixels when printing an image (L size) through a print service, attaching an image to e-mail, when viewing the image on a computer, etc.

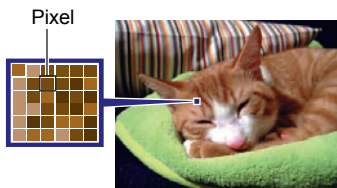

## ■ About image sizes

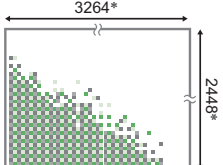
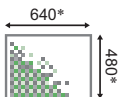

The size of an image indicates how many pixels it contains, and is expressed as horizontal pixels×vertical pixels.

8M (3264×2448) size image = Approximately 8 million pixels	 A diagram of a large image with a green and white pixelated pattern. A horizontal dimension line above the image is labeled "3264*" and a vertical dimension line to the right is labeled "2448*".
VGA (640×480) size image = Approximately 300,000 pixels	 A diagram of a smaller image with a green and white pixelated pattern. A horizontal dimension line above the image is labeled "640*" and a vertical dimension line to the right is labeled "480*".

\* Unit: pixels

## Image Size Selection Tips

Note that larger images have more pixels, so they take up more memory space.

<b>Large Number of Pixels</b>	More detail, but takes up more memory. Best when you plan to print large-size prints (such as A3 size).	 A high-resolution photograph of two small, fluffy puppies, one white and one brown, sitting together.
<b>Small Number of Pixels</b>	Less detail, but takes up less memory. Best when you want to send images by e-mail, etc.	 A low-resolution, pixelated version of the same photograph of two puppies.

- For information about image size, image quality, and number of images that can be stored, see page 175.
- For information about movie image size, see page 80.
- For information about resizing existing snapshots, see page 107.

## ■ To select the image size

1. In the REC mode, press [SET].

2. Use [▲] and [▼] to select the top Control Panel option (Image Size).

3. Use [◀] and [▶] to select an image size and then press [SET].

Image Size (Pixels)	Suggested Print Size and Application	Description
12M (4000×3000)	Poster Print	Good detail for better clarity even for images cropped (page 107) from the original
3:2 (4000×2656)	Poster Print	
16:9 (4000×2240)	HDTV	
8M (3264×2448)	A3 Print	Good detail
5M (2560×1920)	A4 Print	
3M (2048×1536)	3.5"×5" Print	Best when preserving memory capacity is relatively more important than image quality.
VGA (640×480)	E Mail	Image files are smaller, which is better when attaching images to e-mail. However, images are relatively coarser.



- The initial factory default image size setting is "12M".
- Selecting "3:2" records images with an aspect ratio of 3:2, which matches the standard aspect ratio of print paper.
- The letters "HDTV" stand for "High Definition Television". An HDTV screen has an aspect ratio of 16:9, which makes them wider than the usual 4:3 aspect ratio of television screens of the past. Your camera can record images that are compatible with the aspect ratio an HDTV screen.
- You should regard the print paper sizes suggested here as guidelines only (200 dpi print resolution).







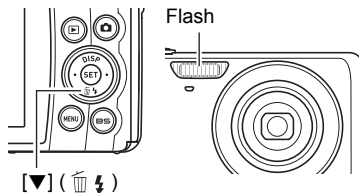

## Using Flash (Flash)

1. In the REC mode, press [▼] (  ) once.

2. Use [◀] and [▶] to select the flash setting you want and then press [SET].

When the “ Panel” menu item (page 140) is “Off” (so the Control Panel is not displayed), pressing [▼] (  ) will cycle through the available flash settings.



 <b>Auto Flash</b>	Flash fires automatically in accordance with exposure (amount of light and brightness) conditions.
 <b>Flash Off</b>	Flash does not fire.
 <b>Flash On</b>	Flash always fires. This setting can be used to brighten a subject that normally comes out dark due to daylight or backlight (daylight synchro flash).
 <b>Soft Flash</b>	Soft flash always fires, regardless of exposure conditions
 <b>Red Eye Reduction</b>	Flash fires automatically. This type of flash can be used to reduce the chance of redness in the subject's eyes.

3. Press the shutter button to shoot.



### Back lamp

Flashes orange while the flash is charging to indicate that image recording is disabled.

- You will not be able to take another flash snapshot until the lamp stops flashing orange, which indicates that charging is complete.

 indicates the flash will fire.

- For information about Flash Range, see page 178.

## NOTE

---

- Take care so your fingers and the strap do not block the flash.
- The desired effect may not be obtained when the subject is too far away or too close.
- Flash charging time (page 178) depends on operating conditions (battery condition, ambient temperature, etc.)
- Shooting with flash turned off when lighting is dim results in a slow shutter speed, which can cause image blur due to camera movement. Under such conditions, secure the camera with a tripod, etc.
- With red eye reduction, the flash is fired automatically in accordance with exposure. It does not fire in areas where lighting is bright.
- The presence of outdoor sunlight, fluorescent lighting, or some other light source can cause abnormal image colors.
- Select  (Flash Off) for the flash setting when shooting in areas where flash photograph is prohibited.

### Red-eye Reduction

Using the flash to shoot at night or in a dimly lit room can cause red spots inside the eyes of people who are in the image. This is caused when the light from the flash reflects off of the retina of the eye. When red-eye reduction is selected as the flash mode, the camera fires a pre-flash to cause the irises in the eyes of any people in the image to close, which reduces the chance of red eye. The camera also has an auto red-eye correction feature that corrects for red-eye in recorded images.



Note the following important points when using red-eye reduction.

- Red-eye reduction does not work unless the people in the image are looking directly at the camera (flash).
- Red-eye reduction may not work very well if the subjects are located far away from the camera.

### Other Useful Flash Features

- Changing the flash intensity (page 85)

## Specifying the Auto Focus Area (AF Area)

 Spot	This mode takes readings of a small area in the center of the image. This setting works well with focus lock (page 67).
 Multi	When you half-press the shutter button while this setting selected, the camera will select the optimum Auto Focus area from among nine possible areas. The focus frame of the area where the camera focuses will be displayed in green.
 Tracking	Half-pressing the shutter button focuses on the subject and causes the focus frame to track the movement of the subject.

1. In the REC mode, press [SET].
2. Use [▲] and [▼] to select the third Control Panel option from the top (AF Area).
3. Use [◀] and [▶] to select the setting you want and then press [SET].
4. Point the camera at the subject and half-press the shutter button. Wait until the camera adjusts exposure and focus automatically.
5. Press the shutter button the rest of the way down.

" Spot" or " Tracking"

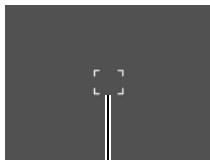

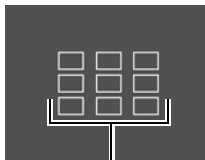

Focus frame

" Multi"



Focus frame

### IMPORTANT!

- " Multi" cannot be selected for the Auto Focus area while you are using Face Detection (page 40).
- " Tracking" cannot be selected for the Auto Focus area while you are using Auto Shutter (page 69).
- Selecting " Tracking" can cause vibration and noise to occur due to lens operation while tracking a subject. This does not indicate malfunction.

## Specifying ISO Sensitivity (ISO)

ISO sensitivity is a measure of sensitivity to light.

**1. In the REC mode, press [SET].**

**2. Use [▲] and [▼] to select the fourth Control Panel option from the top (ISO Sensitivity).**



**3. Use [◀] and [▶] to select the setting you want and then press [SET].**

<b>AUTO</b>	Adjusts sensitivity automatically according to conditions		
<b>ISO 64</b>	Lower sensitivity	Slow shutter speed	Less noise
<b>ISO 100</b>	↑ ↓	↑ ↓	↑ ↓
<b>ISO 200</b>			
<b>ISO 400</b>			
<b>ISO 800</b>			
<b>ISO 1600</b>			
<b>ISO 3200</b>	Higher sensitivity	Fast shutter speed (Set for shooting in dimly lit areas.)	Some coarseness (increased digital noise)

- “AUTO” ISO sensitivity always is applied for movies, regardless of the current ISO sensitivity setting.
- Higher ISO sensitivity values tend to result in digital noise in images.

## Using Continuous Shutter (CS)

Your camera has three continuous shutter modes.

	CS speed	Maximum CS Shots	Recorded Image Size	Flash Mode
 <b>CS: Normal Speed CS</b>	Depends on memory card capacity	Until memory full	According to image size setting	According to flash mode setting
 <b>CS: High Speed CS</b>	4 images per second	8 shots	2M (1600×1200 pixels) fixed	Flash Off
 <b>CS: Flash</b>	3 images per second	3 shots	2M (1600×1200 pixels) fixed	Flash On

\* To turn off a continuous shutter mode, select "Off".

**1. In the REC mode, press [SET].**

---

**2. Use [▲] and [▼] to select the fifth Control Panel option from the top (Continuous Shutter).**

---

**3. Use [◀] and [▶] to select the continuous shutter mode you want, and then press [SET].**

---

**4. Press the shutter button to shoot.**

Images continue to be shot as long as you keep the shutter button depressed. Releasing the shutter button stops shooting.

## Specifying the Method for Saving Continuous Shutter Images

Specify the method to use for saving images recorded with the following continuous shutter (CS) mode.

CS: High Speed CS

1. After continuous shutter shooting is finished, use [▲] and [▼] to select the save method you want and then press [SET].

### Save Selected

The shot images are played back at slow speed so you can select the images you want to save.

- ① While the shot images are playing back and an image appears that you want to save, press the shutter button. Each image that you select by pressing the shutter button will have a mark appended to it.
- ② After selecting all of the images you want to save, press [MENU].



### Buttons Used for Image Selection

[◀] [▶]	During playback, changes the playback direction and playback speed. While playback is paused, scrolls forward or back.
[SET]	Toggles between pause and play.
Shutter button	Press all the way down to select an image for saving.
[MENU]	Saves the selected images and exits the image select operation.

- ③ Use [▲] and [▼] to select the save method you want and then press [SET].  
Save Selected: Saves selected images.  
Save All : Saves all the images.  
Cancel Save : Does not save any of the images.

### Save All

Saves all the images.

- Does not save any of the images while "Cancel Save" is selected.



## **IMPORTANT!**

- If there is not enough available capacity on the memory card, you may not be able to record the number of CS images indicated on the monitor screen. Make sure your memory card has sufficient remaining capacity before shooting with using continuous shutter.
- With continuous shutter, exposure and focus for the first image are applied for successive images as well.
- When using a continuous shutter mode, keep the camera still until shooting is finished.
- Continuous shutter cannot be used in combination with any of the following.
  - Some BEST SHOT scenes (AUTO BEST SHOT, Dynamic Photo, Multi-motion Image, ID Photo, Business cards and documents, White board, etc., Prerecord (Movie), For YouTube, Voice Recording)
  - easy Mode
  - Movie Recording
  - Make-up
- The speed of “CS: Normal Speed CS” depends on the type of memory card loaded in the camera and the amount of free space available for storage. When shooting to built-in memory, continuous shutter shooting is relatively slow.
- “CS: Normal Speed CS” speed is slower when shooting with flash.
- You cannot use the self-timer in combination with “CS: Normal Speed CS”, “CS: High Speed CS”.
- Note that images recorded with “CS: High Speed CS” and “CS: Flash” are of somewhat lower resolution and more prone to digital noise than images recorded with “CS: Normal Speed CS”.
- The ISO sensitivity setting always is “AUTO” for “CS: High Speed CS” and “CS: Flash”, regardless of the camera’s current ISO sensitivity setting.
- The flash range for Flash CS is narrower than that for normal flash.
- Shooting a very bright subject can cause a vertical band or a pink cast on the monitor screen image. This does not indicate malfunction.

## Using Face Detection (Face Detection)

When shooting people, the face detection feature detects the faces of up to ten individuals and adjusts focus and brightness accordingly.

**1. In the REC mode, press [◀] or [▶] to turn off the Make-up Mode.**

- If pressing [◀] or [▶] does not turn off the Make-up Mode, it means that the Make-up Mode setting is not assigned to the [◀] and [▶] keys. Assign the setting to the keys (page 75) and perform the above step again.

**2. Use [▲] and [▼] to select the sixth Control Panel option from the top (Face Detection).**

**3. Use [◀] and [▶] to select “ Face Detection: On” and then press [SET].**

**4. Point the camera at the subject(s).**

The camera will detect human faces and display a frame around each one.

**5. Half-press the shutter button.**

The camera will focus and the frames around the faces it focuses on will turn green.

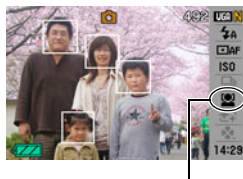

Face Detection icon

**6. Press the shutter button the rest of the way down.**



## Tips for Best Face Detection Results

- The camera performs center focus if it cannot detect a face.
- Always make sure that Auto Focus (AF) is selected as the focus mode when shooting with face detection.
- Face detection may take a bit longer when you hold the camera sideways.
- Detection of the following types of faces is not supported.
  - Face that is obstructed by hair, sunglasses, a hat, etc., or a face in dark shade
  - A profile or a face that is at an angle
  - A face that is very far away and small, or very close and large
  - A face in an area that is very dark
  - The face of a pet or some other non-human subject



### **IMPORTANT!**

- Face detection cannot be used in combination with any of the following features.
  - Some BEST SHOT scenes (Dynamic Photo, ID Photo, Business cards and documents, White board, etc., Prerecord (Movie), For YouTube, Voice Recording)
  - easy Mode
  - Movie Recording
- The following function is disabled when shooting with face detection.
  - Multi AF

## Shooting with the Make-up Mode (Make-up)

The Make-up Mode smooths the skin texture of the subject and softens facial shadows caused by harsh sunlight for better looking portraits.

### 1. In the REC mode, press [◀] or [▶] to turn on the Make-up Mode.

- The Make-up Mode icon  will be displayed on the monitor screen while the Make-up Mode is turned on.
- If pressing [◀] or [▶] does not turn on the Make-up Mode, it means that the Make-up Mode setting is not assigned to the [◀] and [▶] keys. Assign the setting to the keys (page 75) and perform the above step again.

### 2. Press [SET], and then use [▲] and [▼] to select the seventh Control Panel option from the top (Make-up).

### 3. Use [◀] and [▶] to select a level of “+1” or greater, and then press [SET].

- You can set one of 12 levels in the range of “+1 (Min.)” (Minimum correction) to “+12 (Max.)” (maximum correction). The larger the value, the greater the processing that is performed.
- Selecting a level of “0 (Off)” will exit the Make-up Mode.

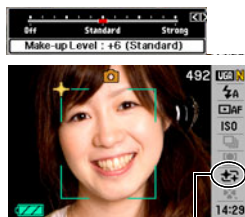

Make-up icon

### 4. Point the camera at the subject(s).

The camera will detect human faces and display a frame around each one.

### 5. Half-press the shutter button.

The camera will focus on the face, which will cause frames around it to turn green.

### 6. When you are ready to shoot, press the shutter button all the way down.

#### NOTE

- The following functions cannot be used together with the Make-up Mode. Continuous Shutter, Triple Self-timer, Face Detection, Some BEST SHOT scenes

## Using the easy Mode

The easy mode eliminates troublesome setups and simplifies snapshot recording. This mode is recommended for those who are new to digital imaging.

**1. In the REC mode, press [SET].**

---

**2. Use [▲] and [▼] to select the second Control Panel option from the bottom (easy Mode).**

---

**3. Use [◀] and [▶] to select “☒ On” and then press [SET].**

This enters the easy mode.

---

**4. Focus the image.**

While the focus frame is aligned with the subject, half-press the shutter button.

---

**5. Shoot the image.**

When the image is focused, press the shutter button the rest of the way.

This records the snapshot.

### ■ Using the easy Menu

The easy menu contains flash, self-timer, and image size settings, plus an item for exiting the easy mode.

While the camera is in the easy mode, all the other settings (besides Flash, Self-timer, Image Size, and easy Mode) on the REC tab menu (page 164) and Quality tab menu (page 165) are fixed at preset optimum values. Any settings you configured on these tabs are not used in the easy mode.

### IMPORTANT!

- To use the Set Up tab menu (page 165), you need to exit the easy mode. To do this, select the “easy Mode” item in step 2 of the following procedure, and then select **OFF** in step 3. After that, you can use the Set up tab menu as you normally do.

### 1. Press [MENU].

The easy menu displays larger text than standard menus.

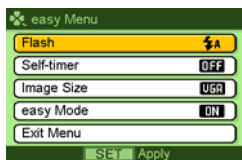

### 2. Use [▲] and [▼] to select the menu item you want, and then press [SET].

### 3. Use [▲] and [▼] to select the setting you want, and then press [SET].

Menu Item:	Available Settings:
Flash	<b>4A</b> (Auto Flash)* / <b>4</b> (Flash On) / <b>4</b> (Flash Off)
Self-timer	<b>10</b> (10-second self-timer) / <b>OFF</b> *
Image Size	<b>12M</b> * / <b>5M</b> / <b>UGA</b>
easy Mode	<b>ON</b> / <b>OFF</b> *
Exit Menu	Exit the easy menu

- An asterisk (\*) indicates reset default settings.
- See the following for details.
  - Flash (page 33)
  - Self-timer (page 68)
  - Image Size (page 30)
- The following are the settings you can select for “easy Mode”.

To do this:	Select this setting:
Stay in the easy mode, without switching to another recording type	<b>ON</b>
Switch from the easy mode to a standard recording type	<b>OFF</b>

- On-screen pop-up help text provides a brief explanation of each setting.

## Changing the Control Panel Date/Time Style

1. In the REC mode, press [SET].
2. Use [▲] and [▼] to select the bottom Control Panel option (Date/Time).  
Use [◀] and [▶] to select the date or time.

### NOTE

- You can select either of two display style (page 145) for the date: Month/Day or Day/Month.
- The time is displayed using 24-hour format.

## Shooting with Zoom

Your camera provides you with 4X optical zoom (that changes the lens focal distance), which can be used in combination with digital zoom (that digitally processes the center portion of the image to enlarge it) for total zoom capabilities of 4X to 63.8X. The image deterioration point depends on the image size (page 47).

1. In the REC mode, slide the zoom controller to zoom.



 Wide Angle



 Telephoto

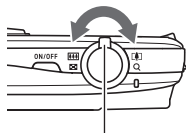

Zoom controller

 (Wide Angle) : Reduces the size of the subject and broadens the range

 (Telephoto) : Enlarges the subject and narrows the range

2. Press the shutter button to shoot the image.

### IMPORTANT!

- Digital zoom is disabled while date stamping (page 144) is turned on.

## NOTE

- The higher the digital zoom factor, the coarser the recorded image. Note that the camera also has a function that lets you record using digital zoom without image deterioration (page 47).
- Use of a tripod is recommended to protect against image blur due to camera movement when shooting with telephoto.
- Performing a zoom operation changes the lens aperture.
- Digital zoom only is available during movie recording. You can adjust the optical zoom setting before you press [●] (Movie) to start movie recording.

## Optical Zoom and Digital Zoom Switch Point

If you hold the zoom controller towards [▲] (Telephoto), the zoom operation will stop when the optical zoom factor reaches its maximum. Momentarily releasing the zoom controller and then holding it again towards [▲] (Telephoto) will switch to digital zoom, which you can use to set an even higher zoom factor.

- During zoom, a zoom bar on the monitor screen shows the current zoom setting.

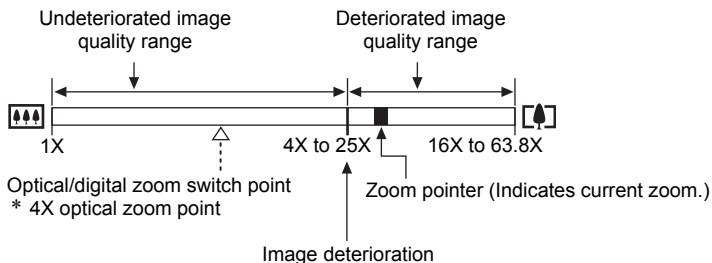
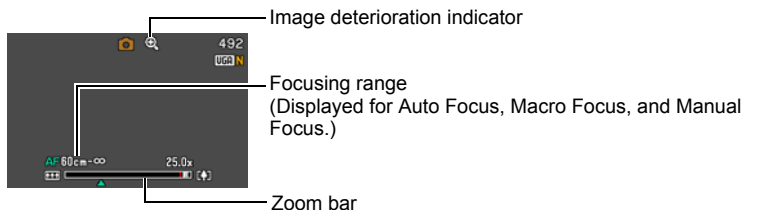

- The image deterioration point depends on the image size (page 30). The smaller the image size, the higher the zoom factor you can use before reaching the image deterioration point.
- Though digital zoom generally causes a deterioration of image quality, some digital zoom without image deterioration is possible with image sizes of "8M" and smaller. The range in which you can use digital zoom without image deterioration is indicated on the display. The deterioration point depends on the image size.

<b>Image Size</b>	<b>Maximum Zoom Factor</b>	<b>Undeteriorated zoom limit</b>
<b>12M</b>	16X	4X
<b>3:2</b>	16X	4X
<b>16:9</b>	16X	4X
<b>8M</b>	19.6X	4.9X
<b>5M</b>	25X	6.2X
<b>3M</b>	31.2X	7.8X
<b>VGA</b>	63.8X	25X

# Recording Movie Images and Audio

## To record a movie

### 1. Configure the quality setting for the movie (page 80).

The length of the movie you can record will depend on the quality setting you select.

### 2. In the REC mode, press [●] (Movie).

This will start recording and display **REC** on the monitor screen.

Movie recording includes monaural audio.

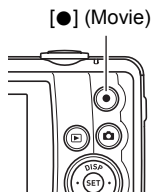

Remaining recording time  
(page 176)



Recording time

### 3. Press [●] again to stop recording.

Movie recording also will stop automatically if memory becomes full before you press [●].

- The maximum size allowed for a single movie file is 4GB. Movie recording stops automatically when a file becomes 4GB.

## Shooting with BEST SHOT

With BEST SHOT (page 53), you can select the sample scene that matches the type of movie you are trying to shoot and the camera will change its setup accordingly, for beautiful movies every time. Selecting the "Natural Green" BEST SHOT scene, for example, will shot images with vivid green trees and grass.

## Minimizing the Effects of Camera Movement during Movie Recording

You can configure the camera to minimize the effects of camera movement during movie recording (page 73). Note, however, that this does not prevent image blur due to subject movement and it makes the field of view narrower.



## NOTE

- Spending a long time using movie recording will cause the camera to become slightly warm to the touch. This is normal and does not indicate malfunction.
- The camera also records audio. Note the following points when shooting a movie.
  - Take care that the microphone is not blocked by your fingers, etc.
  - Good recording results are not possible when the camera is too far away from what you are trying to record.
  - Operating camera buttons while shooting can cause button noise to be picked up in the audio.
- Shooting a very bright subject can cause a vertical band or a pink cast on the monitor screen image. This does not indicate malfunction.
- Use of certain types of memory cards increase the time it takes to record movies, which can cause movie frames to be lost. This condition is indicated by **MEM** and **REC** flashing on the monitor screen. To avoid loss of movie frames, use of a memory card with a maximum transfer speed of at least 10MB per second is recommended (page 162).
- Only digital zoom can be used for zooming during movie recording. Since optical zoom is not possible while recording a movie, zoom as required before pressing **[●]** to start recording.
- The effects of camera movement in an image become more pronounced when you shoot close up or with a large zoom factor. Because of this, use of a tripod is recommended under these conditions.
- Auto Focus and Macro Focus become fixed focus while shooting a movie (page 64).

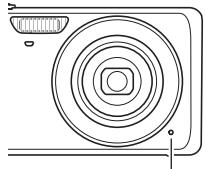

Microphone

## Using Prerecord Movie

With this feature, the camera prerecords up to four seconds of whatever is happening in front of the lens in a buffer that is continually updated. Pressing [●] saves the prerecorded action (buffer contents) followed by real-time recording. Real-time recording continues until you stop it.

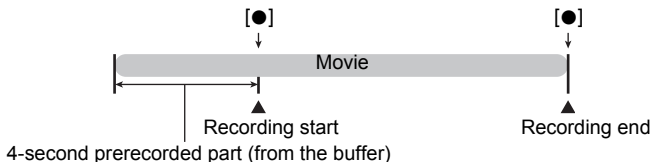

### ■ To set up the camera to shoot with Prerecord Movie

1. In the REC mode, press [BS].
2. Use [▲], [▼], [◀], and [▶] to select the “Prerecord (Movie)” scene and then press [SET].  
This causes  to appear on the monitor screen.

### ■ To shoot a Prerecord Movie

1. With the camera pointed at the subject, press [●].  
This will save four seconds of action prerecorded in the buffer and start real-time recording.
2. Press [●] again to stop recording.
  - To turn off Prerecord Movie, press [BS] and then select  (Auto).

## Shooting a Snapshot while Shooting a Movie

### 1. While a movie is being recorded, press the shutter button.

Movie recording continues after the snapshot is recorded.

#### NOTE

- You can use [▼] (  ) while shooting a movie to change the flash mode setting.
- Movie recording is interrupted for a few seconds at the point where a snapshot is recorded.
- Shooting a snapshot during movie recording is not possible while any one of the following BEST SHOT scenes is selected.  
Prerecord (Movie), Dynamic Photo, Multi-motion Image, ID Photo, Business cards and documents, White board, etc., For YouTube, Voice Recording

## Recording Audio Only (Voice Recording)

Voice Recording lets you record audio only, without a snapshot or movie.

- For information about Voice Recording capacities, see page 176.

### 1. In the REC mode, press [BS].

### 2. Use [▲], [▼], [◀], and [▶] to select the “Voice Recording” scene and then press [SET].

This causes  to appear on the monitor screen.

### 3. Press the shutter button to start recording.

- The back lamp flashes green while recording is in progress.
- Pressing [SET] during recording will insert a marker into the recording. During playback, you will be able to jump to the markers in the recording.

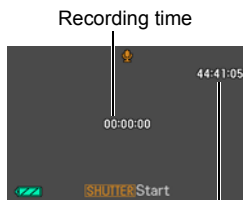

Remaining recording time

### 4. Press the shutter button again to stop audio recording.

- To create another audio recording file, repeat steps 3 and 4.
- To turn off Voice Recording, press [BS] and then select  (Auto).

## NOTE

- You can use [▲] (DISP) during audio recording to toggle the monitor screen on and off.
- When monitor screen contents are turned off, selecting the “Voice Recording” scene will cause the monitor screen to turn off immediately (page 150).

## About audio data

- Audio files can be played back on a computer with Windows Media Player or QuickTime.
  - Audio Data: WAVE/IMA-ADPCM (WAV extension)

## To play back an audio recording

1. In the PLAY mode, use [◀] and [▶] to display the Voice Recording file you want to play.

 is displayed in place of an image for a Voice Recording file.



2. Press [SET] to start playback.

## Voice Recording Playback Controls

Fast forward/fast reverse	[◀] [▶]
Play/pause	[SET]
Jump to marker	While playback is paused, press [◀] or [▶] to jump to the next marker and then press [SET] to resume playback.
Volume adjustment	Press [▼] and then press [▲] [▼]
Monitor screen on/off	[▲] (DISP)
Playback end	[MENU]

# Using BEST SHOT

## What is BEST SHOT?

BEST SHOT provides you with a collection of sample “scenes” that show a variety of different types of shooting conditions. When you need to change the setup of the camera, simply find the scene that matches what you are trying to achieve, and the camera sets up for it automatically. This helps to minimize the chance of ruined images due to poor exposure and shutter speed settings.

## Some Sample Scenes

			
Portrait	Scenery	Night Scene	Night Scene Portrait



## To shoot an image with BEST SHOT

### 1. In the REC mode, press [BS].

This will display a menu of BEST SHOT scenes.

- The initial default selection is  (Auto).

### 2. Use [▲], [▼], [◀], and [▶] to move the boundary to the scene you want to select.

- The scene menu has multiple pages. Use [▲] and [▼] to scroll between menu pages.
- You can access information about the currently selected scene. See page 54 for details.
- To return to normal snapshot recording, select Scene 1  (Auto). Pressing [MENU] while the scene selection screen or scene information screen is displayed will cause the boundary to jump directly to  (Auto).

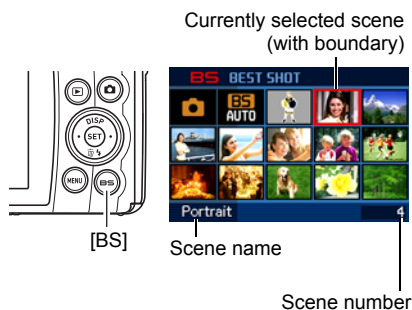

---

### 3. Press [SET] to configure the camera with the settings for the currently selected scene.

This returns to the REC mode.

- The settings of the scene you selected remain in effect until you select a different scene.
- To select a different BEST SHOT scene, repeat the above procedure from step 1.

---

### 4. Press the shutter button (if you are shooting a snapshot) or [●] (if you are shooting a movie).

#### NOTE

- The BEST SHOT YouTube scene sets up the camera for recording movies that are optimized for uploading to YouTube. Movies recorded with the YouTube scene are stored in a special folder to make them easy to locate for uploading (page 138). Maximum recording time while the YouTube scene is selected is 10 minutes.

#### ■ Using Scene Information Screen

To find out more about a scene, select it with the boundary on the scene selection screen, and then slide the zoom controller in either direction.

- To return to the scene menu, slide the zoom controller again.
- To scroll between scenes, use [◀] and [▶].
- To configure the camera with the settings for the currently selected scene, press [SET]. To return to the scene information screen for the currently selected BEST SHOT scene, press [BS].

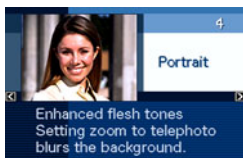

## ■ BEST SHOT Precautions

- The following BEST SHOT scenes cannot be used while recording a movie: Dynamic Photo, Multi-motion Image, ID Photo, Business cards and documents, White board, etc., Self-portrait (1 person), Self-portrait (2 people)
- The following BEST SHOT scenes cannot be used while shooting a snapshot: Prerecord (Movie), For YouTube.
- The Voice Recording scene cannot be used while shooting a snapshot or recording a movie.
- Some scenes like Night Scene and Fireworks results in a slow shutter speed setting. Since a slow shutter speed increases the chance of digital noise in the image, the camera automatically performs a digital noise reduction process when either of these scenes is selected. This means that it will take a bit longer for the image to be saved which is indicated by the back lamp flashing green. Do not perform any key operation during that time. Also, it is a good idea to use a tripod to avoid image blur due to camera movement when shooting at slow shutter speeds.
- Your camera includes a sample scene that optimizes settings for auction site images. Depending on your camera model, the sample scene is named either "For eBay" or "Auction". Images you record using the auction site sample scene are stored in a special folder so you can easily find them on your computer (page 138).
- High Sensitivity
  - The high sensitivity setting is disabled whenever the camera's flash fires.
  - High sensitivity may not produce the desired results in very dark conditions.
  - When shooting with slow shutter speeds, use a tripod to protect against blurring due to camera movement.
  - Under certain lighting conditions, the camera will perform an automatic noise filtering operation to reduce digital noise in the image. This operation causes the camera to take longer than normal to save the image and be ready for the next shot.
- BEST SHOT scene images were not shot using this camera.
- Images shot using a BEST SHOT scene may not produce the results you expected due to shooting conditions and other factors.
- You can modify the camera settings that are made after you select a BEST SHOT scene. Note, however, that the BEST SHOT settings revert to their defaults when you select another BEST SHOT scene or turn off the camera.

## Creating Your Own BEST SHOT Setup

You can save up to 999 camera setups as user BEST SHOT scenes for instant recall whenever you need them.

1. On the BEST SHOT scene menu, select the scene named BEST SHOT (Register User Scene).
2. Use [◀] and [▶] to select the snapshot or movie whose setup you want to save.
3. Use [▲] and [▼] to select “Save”, and then press [SET].  
Your BEST SHOT scene will be assigned the name “Recall User Scene”, along with a scene number.

### NOTE

- BEST SHOT snapshot scenes can be used for snapshots only and movie scenes can be used for movies only.
- You can check the settings of the currently selected BEST SHOT scene by displaying the camera's setting menus and looking at its settings.
- User snapshot scenes are assigned numbers in the sequence: SU1, SU2, and so on, while movies are assigned numbers in the sequence: MU1, MU2, and so on.
- The following are the settings that are saved for each user snapshot BEST SHOT scene.  
Face Detection, Focus, EV Shift, White Balance, Flash, ISO, Metering, Lighting, Make-up Mode, Flash Intensity, Color Filter, Sharpness, Saturation, Contrast
- The following are the settings that are saved for each user movie BEST SHOT scene.  
Focus, EV Shift, White Balance, Color Filter, Sharpness, Saturation, Contrast
- User BEST SHOT scenes are stored in built-in memory (page 138), in the SCENE folder (snapshots) or MSCENE folder (movies).
- Formatting the camera's built-in memory (page 149) deletes all user BEST SHOT scenes.
- Use the following procedure when you want to delete a user BEST SHOT scene.
  - ① Display the information screen (page 54) of the user BEST SHOT scene you want to delete.
  - ② Press [▼] (  ), select “Delete”, and then press [SET].



## Shooting with AUTO BEST SHOT

With AUTO BEST SHOT, the camera automatically selects the BEST SHOT scene that suits your subject and shooting conditions, and configures its settings accordingly. The following are the scenes selected automatically by AUTO BEST SHOT.

Portrait, Scenery, Night Scene, Night Scene Portrait, Macro, Sports, etc.

### 1. Press [BS] and then select the “AUTO BEST SHOT” scene.

### 2. Point the camera at the subject.

The camera will automatically select the BEST SHOT scene that suits your subject and shooting conditions, and configure its settings accordingly. If shooting conditions change, the camera may change to a different BEST SHOT scene automatically.

- The camera will display the scene selected on the monitor screen for a few seconds.

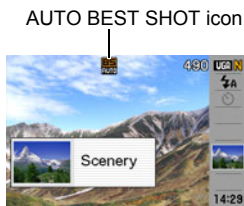

### 3. Press the shutter button to shoot the image.

- The AUTO BEST SHOT will remain activated, so the camera will select a BEST SHOT scene for the next shot after image recording is complete.

### ■ To change to a different BEST SHOT scene

If you do not want to use the BEST SHOT scene that the camera selects automatically, press [SET], use [◀] and [▶] to select a different scene, and then press [SET] again.

### ★ IMPORTANT!

- Certain subjects and/or shooting conditions can make it impossible for the camera to select an appropriate scene.
- You can temporarily toggle automatic scene selection on or off by pressing the [◀] or [▶] button.
- Shooting with AUTO BEST SHOT can cause vibration and noise to occur due to lens operation. This does not indicate malfunction.

## Shooting ID Photographs

You can use this procedure to shoot a portrait and then print it out in the following standard ID photo sizes: 30×24mm, 40×30mm, 45×35mm, 50×40mm, 55×45mm.

### 1. Press [BS] and then select the “ID Photo” scene.

### 2. Press the shutter button to shoot a portrait of the person for whom you want to create an ID photo.

### 3. Adjust the position of the face in the image.

[▲] [▼] [◀] [▶]: Moves the portrait up, down, left, and right.

Zoom controller: Zooms the portrait in and out.

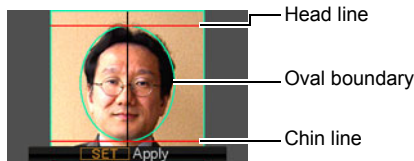

### 4. Press [SET].

This saves the image in memory.

- The resulting image is always saved as a 5M (2560×1920 pixels) size image, regardless of the camera's image size setting.

## Printing an ID Photo

The print operation outputs multiple copies of the same image on the same sheet in various standard ID photo sizes. Cut out the image(s) you need.

- Actual prints are slightly larger than the standard ID photo sizes to facilitate trimming.
- When printing an ID photo, be sure to select “4”×6” as the paper size (page 117).
- When printing an ID photo, be sure to set up your printer for “borderless print”. For full details, see the user documentation that comes with your printer.

## Shooting Images of Business Cards and Documents

A process called “keystone correction” makes lines straight and natural, even if rectangular subjects are shot from an angle.

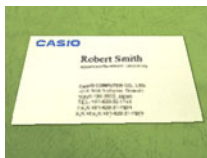

Before keystone correction

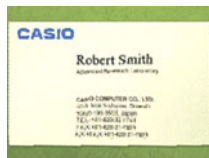

After keystone correction

BEST SHOT has two scenes.



Business cards and documents

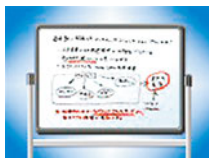

White board, etc.

**1. Press [BS] and then select the “Business cards and documents” or “White board, etc.” scene.**

**2. Press the shutter button to shoot the image.**

This image will appear on the monitor screen with a red boundary around the area that is selected for keystone correction. If there is a black boundary, it means that the camera detected more than one area that could be keystone corrected. Use [◀] and [▶] to move the boundary to the area you want to keystone correct.

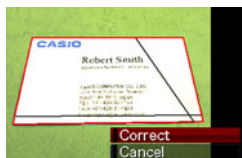

- The message “Cannot correct image!” will appear on the monitor screen if there are no areas that need to be keystone corrected, and the image will be saved to memory as it is.

**3. Use [▲] and [▼] to select “Correct” and then press [SET].**

This will correct the image and save the resulting (corrected) image.

## NOTE

- When composing an image like the ones shown above, make sure that the entire outline of the object you are trying to shoot is enclosed within the monitor screen.
- Make sure the object is against a background that allows its outline to stand out.
- VGA size images are stored as VGA size images. All other size images are stored as 2M (1600×1200 pixels) images.
- Digital zoom is disabled while shooting with the “White board, etc.” and “Business cards and documents” scenes. However, you can use optical zoom (page 45).

## Recording a Self-portrait

With this feature, you can shoot your own self-portrait simply by pointing the camera at your face.

BEST SHOT has two self-portrait scenes from which to choose.

- Self-portrait (1 person): Shoots when the face of at least one person, including you, is detected.
- Self-portrait (2 people): Shoots when the faces of at least two people, including you, are detected.

### 1. Press [BS] and then select “Self-portrait (1 person)” or “Self-portrait (2 people)”.

### 2. Press the shutter button all the way down, and point the camera at yourself.

About three seconds after you press the shutter button, the camera will go into Auto Shutter standby and start face detection. The camera will go into Auto Shutter standby and detect the faces of any people in the image.

When the camera is able to detect the number of required individuals, it will release the shutter automatically when it determines there is no image blur.

- The camera will emit a shutter sound and the front lamp will flash twice when the shutter is released.
- To cancel Auto Shutter standby, press [SET].



## NOTE

- To shoot with the self-portrait feature in combination with a continuous shutter (CS) mode (page 37), turn off the Make-up Mode (page 42). Operation is the same as that when a continuous shutter (CS) mode is used in combination with Auto Shutter. See page 71 for more information.



## IMPORTANT!

- If the camera remains in Auto Shutter standby without releasing the shutter, you can record an image by pressing the shutter button all the way down again.
- Shooting with the self-portrait feature may produce a blurred image when shooting in areas where lighting is dim, which results in a very slow shutter speed setting.
- The Auto Power Off (page 147) trigger time is fixed at five minutes while the camera is in Auto Shutter standby. Sleep (page 146) is disabled while Auto Shutter being used.

## Isolating Moving Subjects (Multi-motion Image)

Multi-motion Image can be used to isolate a moving subject within a series of multiple images and places them against a stationary background. Make sure that the camera is not moving or shaking when shooting with Multi-motion Image.



**1. Press [BS] and then select the “Multi-motion Image” scene.**

**2. Press the shutter button to start shooting.**

Continuous Shutter shooting will stop after some time, and the resulting composite image will appear on the monitor screen.

- Keep the camera still until all of the continuous shutter images are recorded.
- When using this feature, image size is fixed at 3M (2048×1536 pixels).

# Advanced Settings

The following are menu operations you can use to configure various camera settings.

- You also can use the Control Panel (page 29) to configure some of the settings that appear on the menu screen. Refer to the page references provided in this section for information about configuring settings using the Control Panel.

## Using On-screen Menus

### ■ Example Menu Screen Operation

Press [MENU] to display the menu screen.

- Menu contents are different in the REC mode and PLAY mode.

Example: REC mode menu

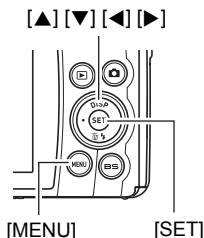
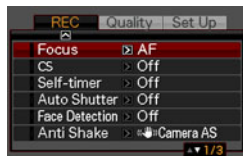

### Menu Screen Operation Buttons

[◀] [▶]	Selects tabs. [▶] is also used to display the options available for a setting.
[▲] [▼]	Selects a setting option.
[SET]	Registers the selected setting.
[MENU]	Exits the menu screen.

#### 1. In the REC mode, press [MENU].

This will display the menu screen.

#### 2. Use [◀] and [▶] to select the tab where the item you want to configure is located.

3. Use [▲] and [▼] to select the menu item you want, and then press [▶].

4. Use [▲] and [▼] to change the setting.

5. After the setting is the way you want, press [SET].

- Pressing [◀] registers the selected setting and returns to the menu.
- To configure settings on another tab after pressing [◀] to return to the menu, use [▲] to move the highlighting up to the tabs, and then use [◀] and [▶] to select the tab you want.

Example:  
When "Focus" is selected on the "REC" tab



## ■ Menu Operations in This Manual

Menu operations are represented in this manual as shown below. The following operation is the same one described under "Example Menu Screen Operation" on page 62.

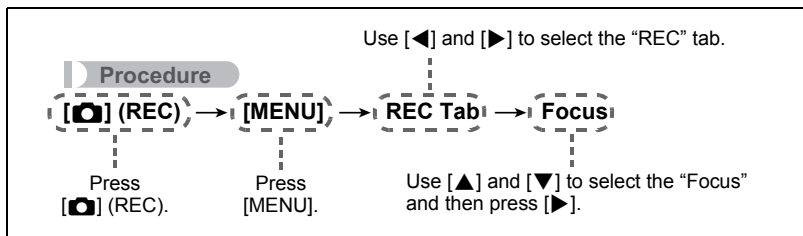





## REC Mode Settings (REC)

### Selecting a Focus Mode (Focus)

#### Procedure

[] (REC) → [MENU] → REC Tab → Focus

Settings	Type of Shot	Focus Mode		Approximate Focus Range* <sup>1</sup>	
		Snapshot	Movies	Snapshot	Movies
 Auto Focus	General recording	Auto-matic	Fixed focal point	Approximately 15 cm to ∞ (infinity) (5.9" to ∞)	Fixed distance* <sup>2</sup> , * <sup>4</sup>
 Macro	Close ups	Auto-matic		Approximately 5 cm to 50 cm (2.0" to 19.7") (First step zoom from the Widest Angle setting)	
 Pan Focus	Shooting with a relatively wide focus range	Fixed focal point		Fixed distance* <sup>2</sup> , * <sup>3</sup>	
 Infinity	Scenery and other distant subjects	Fixed	Infinity		
 Manual Focus	When you want to focus manually	Manual	Approximately 15 cm to ∞ (infinity)* <sup>2</sup> (5.9" to ∞)		

\*<sup>1</sup> The focus range is the distance from the lens surface.

\*<sup>2</sup> The minimum changes along with the optical zoom setting.

\*<sup>3</sup> The distance depends on shooting conditions, and appears on the monitor screen when the shutter button is half-pressed.



Zoom Steps	Normal		Macro
	Close Up	Telephoto	Center distance
Z1 (Wide)	Approx. 0.60 (2.0')	∞	0.23 (9.1")
2	Approx. 0.70 (2.3')	∞	0.26 (10.2")
3	Approx. 0.90 (3.0')	∞	0.28 (11.0")
4	Approx. 1.10 (3.6')	∞	0.32 (12.6")
5	Approx. 1.30 (4.3')	∞	0.37 (14.6")
6	Approx. 1.80 (5.9')	∞	0.45 (17.7")
7	Approx. 2.20 (7.2')	∞	0.52 (20.5")
8	Approx. 2.80 (9.2')	∞	0.59 (23.2")
9 (Tele)	Approx. 3.30 (10.8')	∞	0.66 (26.0")

#### NOTE

- Above values are for reference only.  
For movie macro, the focus range is a few centimeters within the center distance.

## To focus with manual focus

**1. On the monitor screen, compose the image so the subject you want to focus on is within the yellow boundary.**

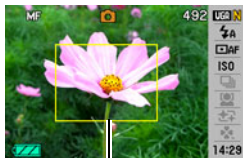

Yellow boundary

**2. Watching the image on the monitor screen use [◀] and [▶] to adjust focus.**

- At this time the image that is within the boundary will enlarge and fill the monitor screen, which aids in focusing. If you do not perform any operation for two seconds while the enlarged image is displayed, the screen in step 1 will re-appear.

### NOTE

- An Auto Macro feature detects how far the subject is from the lens and automatically selects either Macro Focus or Auto Focus accordingly.
- Use of the flash together with Macro Focus can cause the light of the flash to become blocked, which may result in unwanted lens shadows in your image.
- Auto Macro can be used when recording snapshots only.
- Whenever you perform an optical zoom operation while shooting with Auto Focus, Macro Focus, or Manual Focus, a value will appear on the monitor screen to tell you the focus range, as shown below.

Example: ○○ cm to ∞

\* ○○ is the actual focusing range value.

- The operations assigned to the [◀] and [▶] keys with the "L/R Key" setting (page 75) are disabled while Manual Focus is selected as the focus mode.

## Using Focus Lock

“Focus lock” is a technique you can use when you want to compose an image in which the subject you want to focus on is not within the focus frame in the center of the screen.

- To use focus lock, select “[**AF**] Spot” or “[**AF**] Tracking” for the Auto Focus area (page 35).

**1. Align the monitor screen’s focus frame with the subject you want to focus on and then half-press the shutter button.**

Subject to be focused on

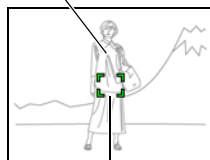

Focus frame

**2. Keeping the shutter button half-pressed (which maintains the focus setting), move the camera to compose the image.**

- When “[**AF**] Tracking” is selected as the Auto Focus area, the focus frame will move automatically and follow the subject.



**3. When you are ready to shoot the image, press the shutter button the rest of the way down.**

### NOTE

- Focus lock also locks exposure (AE).

## Using Continuous Shutter (CS)

### Procedure

[**REC**] (REC) → [MENU] → REC Tab → CS

For details, see the Control Panel procedure on page 37.

## Using the Self-timer (Self-timer)

### Procedure

[] (REC) → [MENU] → REC Tab → Self-timer

With the Self-timer, pressing the shutter button starts a timer. The shutter is released and the image is shot after a fixed amount of time.

<b>10 sec</b>	10-second Self-timer
<b>2 sec</b>	2-second Self-timer • When shooting under conditions that slow down the shutter speed, you can use this setting to prevent image blur due to camera movement.
<b>X3 (Triple Self-timer)</b>	Shoots three images: one image 10 seconds after the shutter button is pressed, and the next two images as soon as the camera is ready after shooting the previous image. How long it takes for the camera to get ready to shoot depends on the image size and quality settings, whether or not a memory card is loaded in the camera, and the flash charge condition.
<b>Off</b>	Turns off the Self-timer.

- The front lamp flashes while the Self-timer countdown is in progress.
- You can interrupt an ongoing Self-timer countdown by pressing [SET].

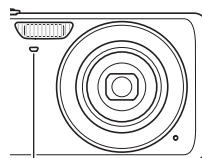

Front lamp

### NOTE



- The Self-timer cannot be used together with the following features.  
CS: Normal Speed CS/High Speed CS, some BEST SHOT scenes (Prerecord (Movie), Voice Recording)
- The Triple Self-timer cannot be used together with the following features.  
Auto Shutter, CS: Flash, Movie, Make-up Mode, easy Mode, some BEST SHOT scenes (Dynamic Photo, Multi-motion Image, ID Photo, Business cards and documents, White board, etc., For YouTube)

## Using Auto Shutter (Auto Shutter)

### Procedure

[] (REC) → [MENU] → REC Tab → Auto Shutter

With Auto Shutter, the camera releases the shutter automatically when it detects that certain conditions are present.

 <b>Detect Blur</b>	Camera releases the shutter automatically when it detects image blur to camera and subject movement are minimized.
 <b>Detect Panning</b>	When panning, the camera releases the shutter automatically when it determines there is no blur in the subject being followed.
 <b>Detect Smile</b>	Camera releases the shutter automatically when it detects the subject is smiling.

### ■ To use Detect Blur to minimize image blur (Detect Blur)

- 1. Point the camera at the subject and half-press the shutter button. Wait until the camera adjusts exposure and focus automatically.**
- 2. Press the shutter button the rest of the way down.**

The camera will go into a standby mode and start detecting hand and subject movement. The camera will release the shutter automatically the moment it determines there is no image blur.

- “● Auto” flashes on the monitor screen while detection of image blur due to hand movement or subject movement is in progress.



Indicator:  
The indicator color changes from red to green when the camera is getting ready to release the shutter.

## ■ To use Detect Panning to minimize image blur (Detect Panning)

1. Point the camera at location where the subject will pass and then half-press the shutter button to adjust exposure and focus.

2. Press the shutter button the rest of the way down.

This will put the camera into Auto Shutter standby. Move the camera to follow the movement of the subject. The camera will release the shutter automatically the moment it determines there is no blur in the subject you are following.

- “● Auto” flashes on the monitor screen while panning detection is in progress.

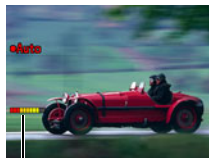

Indicator:  
The indicator color changes from red to green when the camera is getting ready to release the shutter.

## ■ To use Detect Smile to record when a subject is smiling (Detect Smile)

1. Point the camera at the subject and half-press the shutter button. Wait until the camera adjusts exposure and focus automatically.

2. Press the shutter button the rest of the way down.

The camera will go into a standby mode and start detecting whether the subject is smiling. The camera will release the shutter automatically the moment it determines the subject is smiling.

- “● Auto” flashes on the monitor screen while smile detection is in progress.







Indicator:  
The indicator color changes from red to green when the camera is getting ready to release the shutter.

## ■ To change Auto Shutter trigger sensitivity (Sensitivity)

1. Use [▲] and [▼] to select “Sensitivity” and then press [▶].

2. Use [◀] and [▶] to select the sensitivity setting you want, and then press [SET].

- You can select any one of three sensitivity levels, from  (Lowest) to  (Highest).
- With the  (Highest) setting, the auto shutter release is triggered relatively easily. Auto shutter release triggering becomes more difficult with the  (Lowest) setting, but recorded images have the least blur. Experiment with Auto Shutter trigger sensitivity settings to find the one that work best for you.

## ■ Using Auto Shutter in Combination with Continuous Shutter

The following describes how Auto Shutter works while used in combination with Continuous Shutter (page 37).

<b>With CS: Normal Speed CS, CS: High Speed CS</b>	The camera will go back into Auto Shutter standby and be ready to shoot again each time it is triggered. To stop an ongoing Continuous Shutter operation, wait until “● Auto” is flashing on the monitor screen, and then press [SET].
<b>With CS: Flash</b>	3 continuous shutter images will be shot with flash when Auto Shutter is triggered.

### Tips for Better Auto Shutter Snapshots

- Using Auto Shutter in combination with Anti Shake (page 73) reduces the chance of image blur even more.
- While recording with Detect Blur or Detect Smile, keep the camera as still as possible until the recording operation is complete.



## IMPORTANT!

- If the camera remains in Auto Shutter standby without releasing the shutter, you can record an image by pressing the shutter button all the way down again.
- Detect Blur and Detect Panning may not produce the desired effect when shooting in an area where dim lighting requires a slow shutter speed, or when the subject is moving extremely quickly.
- Since facial expressions differ from individual to individual, you may experience problems with getting the camera to release the shutter while Detect Smile is being used. If this happens, change the trigger sensitivity setting.
- The Auto Power Off (page 147) trigger time is fixed at five minutes while the camera is in Auto Shutter standby. Sleep (page 146) is disabled while Auto Shutter being used.
- To cancel Auto Shutter recording while Auto Shutter is being performed (indicated by "● Auto" flashing on the monitor screen), press [SET].
- The "[AF] Tracking" setting for the AF area cannot be used while Detect Blur or Detect Panning is selected for the Auto Shutter setting (page 35).
- Always make sure you had "[AF] Spot" selected for the AF area whenever you are using the Detect Smile Auto Shutter setting (page 35).
- Auto Shutter cannot be used in combination with any of the following features.
  - Some BEST SHOT sample scenes (AUTO BEST SHOT, Dynamic Photo, ID Photo, Business cards and documents, White board, etc., Prerecord (Movie), For YouTube, Voice Recording)
- The following function is disabled when shooting with Auto Shutter.
  - Triple Self-timer

## Shooting with Face Detection (Face Detection)

### Procedure

[CAMERA] (REC) → [MENU] → REC Tab → Face Detection

For details, see the Control Panel procedure on page 40.







## Reducing the Effects of Camera and Subject Movement (Anti Shake)

### Procedure



[] (REC) → [MENU] → REC Tab → Anti Shake

You can turn on the camera's Anti Shake feature to reduce image blur due to subject movement or camera movement when shooting a moving subject using telephoto, when shooting a fast-moving subject, or when shooting under dim lighting conditions. Your digital camera is equipped with a CCD shift type camera shake correction feature and a high-sensitivity anti image blur feature. These two features work in concert to minimize the effects of hand and subject movement.







 <b>Auto</b>	Minimizes the effects of hand and subject movement.
 <b>Camera AS</b>	Minimizes the effects of camera movement only
 <b>Image AS</b>	Minimizes the effects of subject movement only
 <b>DEMO</b>	Half-pressing the shutter button demonstrates the effect of "  Camera AS". However, the image is not recorded.
<b>Off</b>	Turns off Anti Shake settings



### IMPORTANT!

- While the "Anti Shake" setting is " Auto" or " Camera AS", half pressing the shutter will cause the camera to vibrate and emit an operation sound. This is normal and does not indicate malfunction.

### NOTE

- Only Camera Stabilizer can be used during movie recording.
- ISO sensitivity, aperture, and shutter speed do not appear on the monitor screen when you half-press the shutter button while " Auto" or " Image AS" is selected. These values will appear briefly, however, in the preview image that is displayed immediately after you shoot a snapshot.
- The ISO sensitivity setting (page 36) must be "AUTO" for Anti Shake to work.
- Shooting while " Auto" or " Image AS" is selected can cause an image to appear somewhat coarser than normal and can cause slight deterioration of image resolution.
- Anti Shake may not be able to eliminate the effects of camera or subject movement when movement is severe.
- " Camera AS" may not work properly when the camera is mounted on a tripod. Either turn off Anti Shake or select " Image AS".

## Specifying the Auto Focus Area (AF Area)

### Procedure

[CAMERA] (REC) → [MENU] → REC Tab → AF Area

For details, see the Control Panel procedure on page 35.

## Changing the Focus Frame Shape (Focus Frame)

### Procedure

[CAMERA] (REC) → [MENU] → REC Tab → Focus Frame

You can use this procedure to select from among five different shapes, including a heart shape, for the focus frame.

Settings					
		Random			

### NOTE

- Half-pressing the shutter button will cause the focus frame to change one of the shapes shown below.

Focus successful				
Focus not successful				

- While “Random” is selected, one of the four focus frames is selected randomly whenever the camera is turned on.
- When shooting with face detection or the easy mode, the frame shape is .
- Monitor screen information display is always on (page 150) when “ Multi” is selected as the AF area (page 35) while any focus frame other than is selected with this setting. Also, the following items will not appear. On-screen grid, histogram, and the following information when the shutter button is half-pressed: ISO, aperture, shutter speed.

## Turning Digital Zoom On or Off (Digital Zoom)

### Procedure

**[] (REC) → [MENU] → REC Tab → Digital Zoom**

You can use this setting to turn digital zoom on or off. When digital zoom is turned off, operating the zoom controller zooms the image with optical zoom only.

## Assigning Functions to the [◀] and [▶] Keys (L/R Key)

### Procedure

**[] (REC) → [MENU] → REC Tab → L/R Key**

You can assign one of the six functions listed below to the [◀] and [▶] keys.

Setting	[◀]/[▶] key operation
Make-up	Shoots with the Make-up Mode (page 42)
Metering	Changes the Metering Mode (page 83)
EV Shift	Adjusts the EV shift value (page 81)
White Balance	Changes the white balance setting (page 82)
ISO	Changes the ISO Sensitivity setting (page 36)
Self-timer	Sets the self-timer time (page 68)
Off	Cancels [◀] and [▶] key assignments

## Shooting with Quick Shutter (Quick Shutter)

### Procedure

[] (REC) → [MENU] → REC Tab → Quick Shutter

When Quick Shutter is turned on, you can press the shutter button all the way without waiting for Auto Focus. This will record the image using a high-speed focus operation that is much faster than Auto Focus.

<b>On</b>	Turns on Quick Shutter <ul style="list-style-type: none"><li>Some images may be out of focus when Quick Shutter is used.</li></ul>
<b>Off</b>	Turns off Quick Shutter so focus is performed using normal Auto Focus before the image is recorded. <ul style="list-style-type: none"><li>If you press fully the shutter button while Quick Shutter is turned off, images will continue to be shot without focusing.</li><li>Whenever possible, take a little extra time to half-press the shutter button in order to ensure proper focus.</li></ul>

### NOTE

- Quick Shutter is disabled when the zoom factor is greater. Recording is performed using Auto Focus at this time.

## Using the easy Mode (easy Mode)

### Procedure

[] (REC) → [MENU] → REC Tab → easy Mode

For details, see the Control Panel procedure on page 43.

## Displaying the On-screen Grid (Grid)

---

### Procedure

**[] (REC) → [MENU] → REC Tab → Grid**

The on-screen grid can be displayed on the REC mode monitor screen for easy vertical and horizontal alignment when composing images.

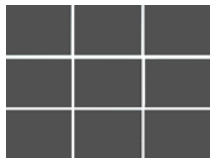

## Turning on Image Review (Review)

---

### Procedure

**[] (REC) → [MENU] → REC Tab → Review**

While Review is turned on, the camera will display a image for about one second immediately after you press the shutter button to record it.

## Using Icon Help (Icon Help)

---

### Procedure

**[] (REC) → [MENU] → REC Tab → Icon Help**

While Icon Help is turned on, a textual description will appear on the display for certain icons when you switch between REC functions.

### Functions Supported by Icon Help

- REC Mode, Flash, Metering Mode, White Balance, Self-timer, EV Shift

## Configuring Power On Default Settings (Memory)

### Procedure

[] (REC) → [MENU] → REC Tab → Memory

When you turn off the camera, it remembers the current settings of all enabled memory items and restores them when you turn it back on. Any memory item that is disabled will be returned to its initial default setting whenever you turn off the camera.

Setting	Disabled (Initial Default Setting)	Enabled
 BEST SHOT	Snapshot (Auto)	Setting at power off
Auto Shutter	Off	
Flash	Auto	
Focus	AF (Auto Focus)	
White Balance	Auto	
ISO	Auto	
AF Area	Spot	
Metering	Multi	
CS	Off	
Self-timer	Off	
Flash Intensity	0	
Digital Zoom	On	
MF Position	Position before manual focus was selected.	
Zoom Position*	Full wide	

\* Optical zoom setting only.

- If you turn the camera power off and then back on while the BEST SHOT memory item is enabled, all of the other memory items (except for zoom position) are initialized to the currently selected BEST SHOT sample scene setup, regardless of the enabled/disabled status of the other memory items.

## Image Quality Settings (Quality)

### Specifying Snapshot Size (Size)

#### Procedure

[] (REC) → [MENU] → Quality Tab → Size

For details, see the Control Panel procedure on page 32.

### Specifying Snapshot Image Quality (Quality (Snapshot))

#### Procedure

[] (REC) → [MENU] → Quality Tab →  Quality (Snapshot)

<b>Fine</b>	Gives image quality priority
<b>Normal</b>	Normal
<b>Economy</b>	Gives number of images priority

- The “Fine” setting helps to bring out details when shooting a finely detailed image of nature that includes dense tree branches or leaves, or an image of a complex pattern.
- Memory capacity (the number of images you can record) will be affected by the quality settings you configure (page 175).

## Specifying Movie Image Quality (Quality (Movie))

### Procedure

[] (REC) → [MENU] → Quality Tab → [] Quality (Movie)

Movie image quality is a standard that determines the detail, smoothness, and clarity of a movie during playback. Shooting with the high-quality (HD) setting will result in better image quality, but it also shortens the amount of time you can shoot.

Image Quality (Pixels)		Approximate Data Rate	Frame Rate
HD	1280×720	24 Megabits/second	24 frames/second
STD	640×480	10 Megabits/second	30 frames/second
LP	320×240	2.7 Megabits/second	15 frames/second

- The 16:9 aspect ratio is available only when “HD” is selected as the image quality.
- Memory capacity (Movie recording time you can shoot) will be affected by the quality settings you configure (page 176).



## Correcting Image Brightness (EV Shift)

### Procedure

[] (REC) → [MENU] → Quality Tab → EV Shift

You can manually adjust an image's exposure value (EV value) before shooting it.

- Exposure Compensation Range:  $-2.0\text{EV}$  to  $+2.0\text{EV}$
- Unit:  $1/3\text{EV}$

### 1. Use [] and [] to adjust the exposure compensation value.

[]: Increases the EV value. A higher EV value is best for light-colored subjects and backlit subjects.

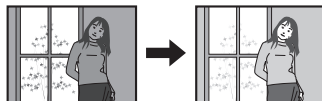

[]: Decreases the EV value. A lower EV value is best for dark-color subjects and for shooting outdoors on a clear day.

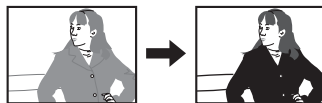

To cancel exposure compensation, change the EV value to 0.0.

### 2. Press [SET].

This applies the exposure compensation value. The exposure compensation value you set remains in effect until you change it.

### NOTE

- When shooting under very dark or very bright conditions, you may not be able to obtain satisfactory results even after performing exposure compensation.

## Controlling White Balance (White Balance)

### Procedure

[] (REC) → [MENU] → Quality Tab → White Balance

You can adjust white balance to match the source of light available where you are shooting and avoid the blue cast that results when shooting outdoors when it is cloudy, and the green cast that results when shooting under fluorescent lighting.

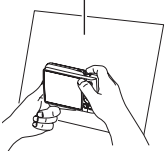
<b>Auto</b>	Configures the camera to adjust white balance automatically
<b>(Daylight)</b>	For shooting outdoors on a clear day
<b>(Overcast)</b>	For shooting outdoors on an overcast rainy day, in the shade, etc.
<b>(Shade)</b>	For shooting on a clear day in the shade of trees or buildings
<b>(Day White Fluorescent)</b>	For shooting under white or day white fluorescent lighting
<b>(Daylight Fluorescent)</b>	For shooting under daylight fluorescent lighting
<b>(Tungsten)</b>	For shooting under light bulb lighting
<b>Manual</b>	<p>For configuring the camera manually to suit a particular light source.</p> <ol style="list-style-type: none"><li>① Select "Manual".</li><li>② Under the lighting conditions you plan to use when shooting, point the camera at a blank white piece of paper so it fills the entire monitor screen and then press the shutter button.</li><li>③ Press [SET].</li></ol> <p>The white balance setting is retained even if you turn off the camera.</p> <div style="text-align: right;"><p>Blank white paper</p></div>

- When "Auto" is selected for the white balance setting, the camera automatically determines the white point of the subject. Certain subject colors and light source conditions can cause problems when the camera tries to determine the white point, which makes proper white balance adjustment impossible. If this happens, select the white balance setting that matches your shooting conditions (Daylight, Overcast, etc.)

## Specifying ISO Sensitivity (ISO)

### Procedure

[] (REC) → [MENU] → Quality Tab → ISO



For details, see the Control Panel procedure on page 36.

## Specifying the Metering Mode (Metering)

### Procedure

[] (REC) → [MENU] → Quality Tab → Metering

The metering mode determines what part of the subject is metered for exposure.

 <b>Multi</b>	Multi-pattern metering divides the image into sections and measures the light in each section for a balanced exposure reading. This type of metering provides error-free exposure settings for a wide range of shooting conditions.
 <b>Center Weighted</b>	Center weighted metering concentrates on the center of the focus area to measure light. This type of metering is best when you want some level of control over contrast.
 <b>Spot</b>	Spot metering takes readings at a very small area. Use this metering method when you want exposure to be set according to the brightness of a particular subject, without being affected by surrounding conditions.

- The currently selected metering mode is indicated by an icon on the snapshot screen. No icon is displayed when " Multi" is selected as the metering mode.

## Optimizing Image Brightness (Lighting)

---

### Procedure

[] (REC) → [MENU] → Quality Tab → Lighting

You can use this setting to optimize the balance between bright areas and dark areas when shooting images.

<b>Extra</b>	Performs a higher level of brightness correction than the “On” setting. When this option is selected, it takes longer for the image to be stored after the shutter button is pressed.
<b>On</b>	Performs brightness correction.
<b>Off</b>	Does not perform brightness correction.

- You also can optimize the balance between bright areas and dark areas in existing images (page 101).

## Using Built-in Color Filters (Color Filter)

---

### Procedure

[] (REC) → [MENU] → Quality Tab → Color Filter

Settings: Off, B/W, Sepia, Red, Green, Blue, Yellow, Pink, and Purple

## Controlling Image Sharpness (Sharpness)

---

### Procedure

[] (REC) → [MENU] → Quality Tab → Sharpness

You can specify one of five sharpness settings from +2 (sharpest) to -2 (least sharp).

## Controlling Color Saturation (Saturation)

---

### Procedure

**[CAMERA] (REC) → [MENU] → Quality Tab → Saturation**

You can specify one of five saturation settings from +2 (most saturated) to -2 (least saturated).

## Adjusting Image Contrast (Contrast)

---

### Procedure

**[CAMERA] (REC) → [MENU] → Quality Tab → Contrast**

You can specify one of five contrast settings from +2 (most contrast between light and dark) to -2 (least contrast between light and dark).

## Specifying Flash Intensity (Flash Intensity)

---

### Procedure

**[CAMERA] (REC) → [MENU] → Quality Tab → Flash Intensity**

You can specify one of five flash intensity settings, from -2 (weakest) to +2 (strongest).

- Flash intensity may not change when the subject is too far away or too close.

# Viewing Snapshots and Movies

## Viewing Snapshots

See page 26 for the procedure for viewing snapshots.

## Viewing a Movie

1. Press [▶] (PLAY) and then use [◀] and [▶] to display the movie you want to view.
2. Press [SET] to start playback.



## Movie Playback Controls

<b>Fast forward/ fast reverse</b>	[◀] [▶] <ul style="list-style-type: none"><li>• Each press of either button increases the speed of the fast forward or fast reverse operation.</li><li>• To return to normal playback speed, press [SET].</li></ul>
<b>Play/pause</b>	[SET]
<b>1 frame forward/back</b>	[◀] [▶] <ul style="list-style-type: none"><li>• Holding down either button scrolls continuously.</li></ul>
<b>Volume adjustment</b>	Press [▼] and then press [▲] [▼] <ul style="list-style-type: none"><li>• Volume can be adjusted only while movie playback is in progress.</li></ul>
<b>Information display on/off</b>	[▲] (DISP)
<b>Zoom</b>	Slide the zoom controller in the direction of [Q] (Q). <ul style="list-style-type: none"><li>• You can use [▲], [▼], [◀], and [▶] to scroll the zoomed image on the monitor screen. You can zoom a movie image up to 4.5 times normal size.</li></ul>
<b>Stop playback</b>	[MENU]

- Playback may not be possible for movies not recorded with this camera.

## Viewing Continuous Shutter Images

Each time you perform a continuous shutter (CS) operation, the camera creates a CS group that includes all of the images for that particular CS session. You can use the following procedure to play back the images in a particular CS group.

1. Press **[▶]** (PLAY) and then use **[◀]** and **[▶]** to display the CS group whose images you want to view.



2. Press **[SET]** to start playback the images in the CS group.

This will play back the images in the CS group you selected.



### Playback Controls

<b>[◀] [▶]</b>	During playback, changes the playback direction and playback speed. While playback is paused, scrolls forward or back. <ul style="list-style-type: none"><li>• Playback speed cannot be adjusted while the displayed image is zoomed.</li></ul>
<b>[SET]</b>	Toggles between pause and play.
<b>Zoom controller</b>	Zooms the image. <ul style="list-style-type: none"><li>• You can use <b>[▲]</b>, <b>[▼]</b>, <b>[◀]</b>, and <b>[▶]</b> to scroll the zoomed image on the monitor screen.</li></ul>
<b>[MENU]</b>	Exits CS group playback.
<b>[▲] (DISP)</b>	Cycles through information display formats.
<b>[▼]</b>	Displays the delete menu.

## NOTE

---

- Multiple images shot using “CS: Normal Speed CS” are stored individually and are not grouped. This means they can be displayed individually (page 26) but not as a CS group.

## Deleting Continuous Shutter Images

---

You can use the following procedures to delete images while playback is in progress or paused.

### ■ Deleting a Specific CS Group File

1. While CS image playback is in progress or paused, press [▼].
2. Use [◀] and [▶] to display the image you want to delete.
3. Use [▲] and [▼] to select “Delete” and then press [SET].
  - To delete other files, repeat steps 2 and 3.
  - To exit the delete operation, press [MENU].

### ■ Deleting All Files in a CS Group

1. While CS image playback is in progress or paused, press [▼].
2. Use [▲] and [▼] to select “Del Group Images” and then press [SET].
3. Use [▲] and [▼] to select “Yes”, and then press [SET].



## Dividing Up a CS Group

---

Use the following to divide up a CS Group into individual images.

### ■ Dividing Up a Specific CS Group

1. While a CS group folder is displayed, press [MENU].
2. Use [◀] and [▶] to select “PLAY” tab.
3. Use [▲] and [▼] to select “Divide Group” and then press [▶].
4. Use [◀] and [▶] to display the CS group folder whose CS group you want to divide up.
5. Use [▲] and [▼] to select “Divide” and then press [SET].
  - To divide up other CS group files, repeat steps 4 and 5.

### ■ Dividing Up All CS Groups

1. While a CS group folder is displayed, press [MENU].
2. Use [◀] and [▶] to select “PLAY” tab.
3. Use [▲] and [▼] to select “Divide Group” and then press [▶].
4. Use [▲] and [▼] to select “Divide All Groups” and then press [SET].
5. Use [▲] and [▼] to select “Yes”, and then press [SET].
  - Once a CS group is divided, it cannot be regrouped.

## Zooming an On-screen Image

1. In the PLAY mode, use [◀] and [▶] to scroll through the images until the one you want is displayed.



2. Slide the zoom controller towards [🔍] (🔍) to zoom.

You can use [▲], [▼], [◀], and [▶] to scroll the zoomed image on the monitor screen. Slide the zoom controller towards [🔍] to unzoom the image.

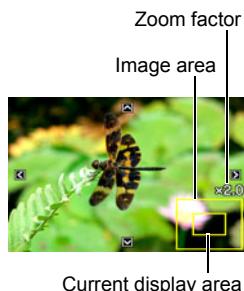
- When monitor screen contents are turned on, a graphic in the lower right corner of the screen shows what part of the zoomed image is currently displayed.
  - To exit the zoom screen, press [MENU] or [BS].
  - Though the maximum image zoom factor is 8X, certain image sizes may not allow zooming up to the full 8X.
- Pressing [SET] will lock the current zoom factor for the on-screen image. You can then use [◀] and [▶] to scroll between images, using the same zoom factor. Pressing [SET] again will unlock the zoom factor and allow you to use [▲], [▼], [◀] and [▶] to move around the currently displayed images.



## Displaying the Image Menu

1. In the **PLAY** mode, slide the zoom controller towards  .

Use [▲], [▼], [◀] and [▶] to move the selection boundary around the image menu.

To view a particular image, use [▲], [▼], [◀], or [▶] to move the selection boundary to the image you want and then press [SET].

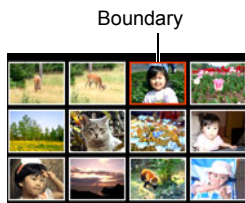

## Displaying Images in the Calendar Screen

1. In the **PLAY** mode, slide the zoom controller towards   twice.

This will display the calendar screen that shows the first image recorded on each day.

To display the first image recorded on a particular day, use [▲], [▼], [◀], and [▶] to move the selection boundary to the day you want and then press [SET].

To exit the calendar screen, press [MENU] or [BS].

- If you save an image using any one of the following functions, the image will appear in the calendar on the date that you last saved it.

Lighting, White Balance, Brightness, Keystone Correction, Color Restoration, Resizing, Cropping, Copy, Layout Print, MOTION PRINT

If you edit the date and time of an image, the image still will appear on the date it was originally recorded.



## Viewing Snapshots and Movies on a TV Screen

### 1. Use the AV cable that comes with the camera to connect it to the TV.

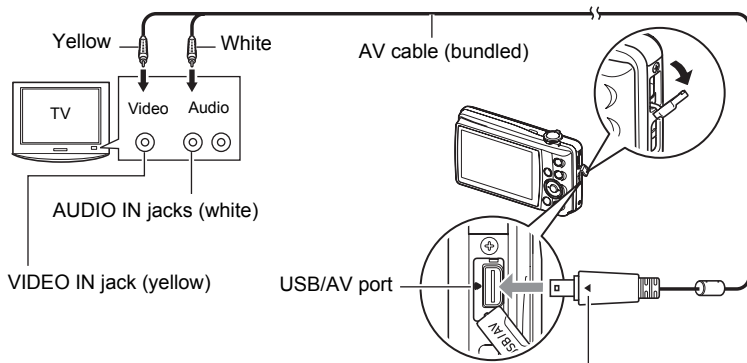

Making sure that the ► mark on the camera is aligned with the ◀ mark of the AV cable connector, connect the cable to the camera.

- Make sure that you insert the cable connector into the USB/AV port until you feel it click securely into place. Failure to insert the connector fully can result in poor communication or malfunction.
- Note that even while the connector is fully inserted, you still will be able to see the metal part of the connector as shown in the illustration.

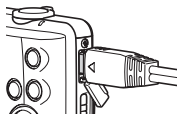

### 2. Turn on the TV and select its video input mode.

If the TV has more than one video input, select the one where the camera is connected.

---

### 3. Press **[▶]** (PLAY) to turn on the camera.

This will cause an image to appear on the TV screen, without anything appearing on the camera's monitor screen.

- Pressing [ON/OFF] or **[⏻]** (REC) will not turn on the camera while the AV cable is connected.
- You also can change the aspect ratio of the screen and the video output system (page 148).

---

### 4. Now you can display images and play back movies as you normally do.



#### **IMPORTANT!**

- Before connecting to a TV to display images, be sure to configure the camera's **[⏻]** (REC) and **[▶]** (PLAY) buttons for "Power On" or "Power On/Off" (page 147).
- Audio is initially output by the camera at maximum volume. When you first start displaying images, set the TV volume control at a relatively low level and then adjust it as required.

---

#### **NOTE**

- Audio is monaural.
- Certain TVs may cut off part of the images.
- All icons and indicators that appear on the monitor screen also appear on the TV screen. You can use **[▲]** (DISP) to change the display contents.

### **Recording Camera Images to a DVD Recorder or Video Deck**

Use one of the following methods to connect the camera to the recording device using the camera's bundled AV cable.

- DVD recorder or video deck: Connect to the VIDEO IN and AUDIO IN terminals.
- Camera: USB/AV port

You can play a slideshow of snapshots and movies on the camera and record it on a DVD or video tape. You can record movies by selecting "**[📷]** Only" for the slideshow "Images" setting (page 94). When recording images to an external device, use **[▲]** (DISP) to clear all indicators from the monitor screen (page 150).

For information about connecting a monitor to the recording device and about how to record, see the user documentation that comes with the recording device you are using.

# Other Playback Functions (PLAY)







This section explains menu items that you can use to configure settings and perform other playback operations.

For information about menu operations, see page 62.

## Playing a Slideshow on the Camera (Slideshow)

### Procedure

[] (PLAY) → [MENU] → PLAY Tab → Slideshow

<b>Start</b>
Starts the slideshow
<b>Images</b>
Specifies the type of images to be included in the slideshow All images: Snapshots, movies, and audio recordings  Only: Snapshots and audio snapshots only  Only: Movies only One Image: One single selected image (selected using [  ] and [  ])
<b>Time</b>
Time from the start to the end of the slideshow 1 to 5 minutes, 10 minutes, 15 minutes, 30 minutes, 60 minutes
<b>Interval</b>
Amount of time each image remains displayed Use [  ] and [  ] to select a value from 1 to 30 seconds, or "MAX". If you specify a value from 1 to 30 seconds, images change at the specified interval, but the audio portion of movies and audio snapshots will continue to play until the end. When the slideshow reaches a movie file while "MAX" is selected, only the first frame of the movie will be displayed. Voice Recording files are not played back when "MAX" is selected.

## Effect

Select the effect you want.

Pattern 1 to 5: Plays background music and applies an image change effect.

- Patterns 1 through 4 have different background music, but they all use the same image change effect.
- Pattern 5 can be used for playback of snapshots only, and the "Interval" setting is ignored.
- The currently selected image change effect setting is disabled automatically in following cases.
  - When playing a slideshow for which "☑ Only" or "One Image" is selected for the "Images" setting
  - When the interval setting is "MAX", 1 second or 2 seconds.
  - Before and after playback of a movie or Voice Recording file

Off: No image change effect or background music

- To stop the slideshow, press [SET]. Pressing [MENU] instead of [SET] stops the slideshow and returns to the menu screen.
- Adjust audio volume by pressing [▼] and then press [▲] or [▼] during playback.
- All button operations are disabled while the slideshow is transitioning from one image to another.
- The time required for transition from one image to another may be longer in the case of an image that was not recorded with this camera.

## Saving Music from Your Computer to Camera Memory

You can replace the built-in slideshow background music with other music from your computer.

### Supported File Types:

- IMA-ADPCM format WAV files
- Sampling Frequencies: 22.05 kHz/44.1 kHz
- Quality: Monaural

### Number of Files: 9

### File names: SSBGM001.WAV to SSBGM009.WAV

- Create the music files on your computer using the above names.
- Regardless of which effect pattern you select, the BGM files you store in camera memory are played back in name sequence.

## **1. Connect the camera to your computer (pages 123, 132).**

If you plan to save the music files to the camera's memory card, make sure the card is loaded in the camera.

---

## **2. Perform one of the following operations to open the memory card or built-in memory.**

This will cause the camera to be recognized by your computer as a Removable Disk (Drive).

- Windows
    - ① Windows Vista: Start → Computer
    - Windows XP: Start → My Computer
    - Windows 2000: Double-click "My Computer".
    - ② Double-click "Removable Disk".
  - Macintosh
    - ① Double-click the camera's drive icon.
- 

## **3. Create a folder named "SSBGM".**

## **4. Double-click the "SSBGM" folder you created and copy the background music file to it.**

- See the user documentation that comes with your computer for information about moving, copying, and deleting files.
  - If there are background music files both in built-in memory and on the memory card loaded in the camera, the files on the memory card take priority.
  - See page 138 for information about camera folders.
- 

## **5. Disconnect the camera from the computer (pages 125, 134).**



## Laying Out Snapshots with Layout Print (Layout Print)

### Procedure

[▶] (PLAY) → Snapshot Screen → [MENU] → PLAY Tab → Layout Print

You can use the following procedure to insert existing snapshots into the frames of a layout and produce a new image that contains multiple snapshots.



Layout Pattern  
(2 images)



Layout Pattern  
(3 images)

1. Use [◀] and [▶] to select the layout pattern you want and then press [SET].
2. Use [◀] and [▶] to select the background color and then press [SET].
3. Use [◀] and [▶] to select the images you want to include in the layout then press [SET].
4. Press [SET] and repeat step 3 for the remaining frames in the layout.  
The final layout image will be saved after you insert the final snapshot into it.

### NOTE

- You will not be able to save the new image unless there is a snapshot in all of the layout frames.
- 3:2 and 16:9 images cannot be included in a Layout Print image.
- The recording date of the resulting Layout Print image is the recording date if the image you place into the final frame, not the date you create the Layout Print image.
- The Layout Print image is saved as 7M (3072×2304 pixels) size.

## Creating a Snapshot of Movie Frames (MOTION PRINT)

### Procedure

[▶] (PLAY) → Movie Screen to be Used → [MENU] → PLAY Tab → MOTION PRINT

1. Use [◀] and [▶] to scroll through the movie frames and display the one you want to use as the image of the MOTION PRINT image.

Holding down [◀] or [▶] scrolls at high speed.

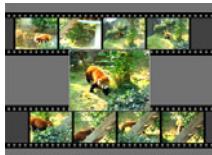

9 frames

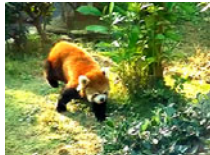

1 frame

2. Use [▲] and [▼] to select either “9 frames” or “1 frame” and then press [SET].



- When “9 frames” is selected, the frame you select in step 1 will be in the center of the MOTION PRINT image.
- Only the frames of movies recorded on this camera can be used in a MOTION PRINT image.

## Editing a Movie on the Camera (Movie Editing)

### Procedure

[▶] (PLAY) → Movie Screen of Movie to be Edited → [MENU] → PLAY Tab → Movie Editing

The Movie Editing feature lets you use one of the following procedures to edit out a specific part of a movie.

 <b>Cut (To-Point Cut)</b>	Cuts everything from the beginning of the movie up to the current location.
 <b>Cut (Point-To-Point Cut)</b>	Cuts everything between two points.
 <b>Cut (From-Point Cut)</b>	Cuts everything from the current location to the end of the movie.

1. Use [▲] and [▼] to select the editing method you want to use and then press [SET].

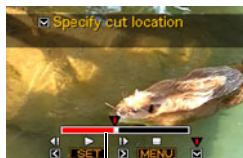

2. Use [◀] and [▶] to scroll through the movie and search for the frame (point) from which or to which you want to cut the movie (the cut point).

- You also can search for the cut location by playing back the movie and pressing [SET] to pause. During playback, you can press [◀] or [▶] to perform fast reverse or fast forward.



Cut range (red)

**3. When the frame where you want the cut point to be is displayed, press [▼].**

 <b>Cut (To-Point Cut)</b>	While the frame you want the cut to be up to is displayed, press [▼].
 <b>Cut (Point-To-Point Cut)</b>	① While the frame you want the first (From) cut to be is displayed, press [▼]. ② While the frame you want the second (To) cut to be is displayed, press [▼].
 <b>Cut (From-Point Cut)</b>	While the frame you want the cut to be from is displayed, press [▼].

**4. Use [▲] and [▼] to select “Yes” and then press [SET].**

The selected cut operation will take considerable time to complete. Don't try to perform any camera operation until the “Busy... Please wait...” message disappears from the monitor screen. Note that a cut operation can take a long time if the movie being edited is long.

 **IMPORTANT!**

- When you edit a movie, only the result is saved. The original movie is not retained. An editing operation cannot be undone.

**NOTE**

- A movie that is shorter than five seconds cannot be edited.
- Editing of movies recorded with a different type of camera is not supported.
- You will not be able to edit a movie if the amount of remaining memory capacity is less than the size of the movie file you want to edit. If there is not enough memory available, delete files you no longer need to free up more.
- Splitting of a movie into two movies and splicing of two different movies into a single movie are not supported.
- You also can start a movie editing operation while the movie you want to edit is playing back. Press [SET] to pause playback, and then press [▼] to display the menu of editing options. Perform editing using the same procedures as described above.

## Optimizing Image Brightness (Lighting)

### Procedure

**[ ] (PLAY) → Snapshot Screen → [MENU] → PLAY Tab → Lighting**

You can use this setting to optimize the balance between bright areas and dark areas in existing images.

<b>+2</b>	Performs a higher level of brightness correction than the “+1” setting.
<b>+1</b>	Performs brightness correction.
<b>Cancel</b>	Does not perform brightness correction.

### NOTE

- Correcting the lighting when shooting produces better results (page 84).
- Altering the lighting of an image causes the original image and the new (altered) version to be stored as separate files.
- When you display an altered image on the camera's monitor screen, the date and time indicates when the image was originally recorded, not when the image was altered.

## Using Red Eye Correction (Red Eye)

### Procedure

**[ ] (PLAY) → Snapshot Screen → [MENU] → PLAY Tab → Red Eye**

Using the flash to shoot at night or in a dimly lit room can cause red spots inside the eyes of people who are in the image. This is caused when the light from the flash reflects off of the retina of the eye. Red eye correction corrects the eye colors of subjects to their normal colors when red eye occurs while using the flash.

<b>Correct</b>	Turns on red eye correction.
<b>Cancel</b>	Turns off red eye correction.

### NOTE







- The original snapshot is retained in memory and not deleted.
- Red eye correction may not be possible in the case of small faces or profiles.
- Red eye correction may not produce the desired effect under certain conditions.

## Adjusting White Balance (White Balance)

### Procedure

[] (PLAY) → Snapshot Screen → [MENU] → PLAY Tab → White Balance

You can use the white balance setting to select a light source type for a recorded image, which will affect the colors of the image.

 Daylight	Outdoors, fair weather
 Overcast	Outdoors, cloudy to rain, in tree shade, etc.
 Shade	Very high temperature light, such as building shade, etc.
 Day White Fluorescent	White or daywhite fluorescent lighting, without suppressing color cast
 Daylight Fluorescent	Daylight fluorescent lighting, while suppressing color cast
 Tungsten	Suppressing of the appearance of light bulb lighting
Cancel	No white balance adjustment

### NOTE

- You also can adjust the white balance when recording images (page 82).
- The original snapshot is retained in memory and not deleted.
- When you display an altered image on the camera's monitor screen, the date and time indicates when the image was originally recorded, not when the image was altered.

## Adjusting the Brightness of an Existing Snapshot (Brightness)

### Procedure

[**▶**] (PLAY) → Snapshot Screen → [MENU] → PLAY Tab → Brightness

You can select one of five brightness levels, from +2 (brightest) to -2 (least bright).

### NOTE

- The original snapshot is retained in memory and not deleted.
- When you display an altered image on the camera's monitor screen, the date and time indicates when the image was originally recorded, not when the image was altered.

## Keystone Correction (Keystone)

### Procedure

[**▶**] (PLAY) → Snapshot Screen → [MENU] → PLAY Tab → Keystone

You can use keystone correction to correct rectangular and square shapes in a snapshot that do not appear normal because they were not shot straight on. The corrected image is saved as 2M (1600×1200 pixels) size.

**1. Use [**◀**] and [**▶**] to select the shape in the snapshot that you want to correct.**

**2. Use [**▲**] and [**▼**] to select "Correct" and then press [SET].**



### NOTE

- If the original image is smaller than 2M size, the new (corrected) version will be the same size as the original.
- The original snapshot is retained in memory and not deleted.
- When you display an altered image on the camera's monitor screen, the date and time indicates when the image was originally recorded, not when the image was altered.

## Using Color Correction to Correct the Color of an Old Photograph (Color Correction)

### Procedure

**[▶] (PLAY) → Snapshot Screen → [MENU] → PLAY Tab → Color Correction**

Color Correction lets you correct the color of an old photograph. The corrected image is saved as 2M (1600×1200 pixels) size.

#### 1. Perform the above operation.

- An image of the photograph you are restoring will appear on the monitor screen with a red boundary around it. If there is a black boundary, it means that the camera detected more than one rectangular area in the image. Use [◀] and [▶] to move the boundary and select the area of the photograph.

#### 2. Use [▲] and [▼] to select “Trim”, and then press [SET].

This will display a selection boundary for trimming the on-screen image.

#### 3. Slide the zoom controller to resize the selection boundary and specify the image size you want.

#### 4. Use [▲], [▼], [◀], and [▶] to move the selection boundary to it encloses the area of the image you want to trim to and then press [SET].

### NOTE

- If the original image is smaller than 2M size, the new (corrected) version will be the same size as the original.
- The original snapshot is retained in memory and not deleted.
- If you do not want a border around the resulting image, select an area that is smaller than the original image.
- When you display a color corrected image on the camera’s monitor screen, the date and time indicates when the image was originally recorded, not when the image was color corrected.



## Selecting Images for Printing (DPOF Printing)

### Procedure









[] (PLAY) → Snapshot Screen → [MENU] → PLAY Tab → DPOF Printing

See page 118 for details.

## Protecting a File Against Deletion (Protect)

### Procedure

[] (PLAY) → [MENU] → PLAY Tab → Protect

<b>On</b>	<p>Protects specific files.</p> <ol style="list-style-type: none"><li>① Use [] and [] to scroll through the files until the one you want to protect is displayed.</li><li>② Use [] and [] to select "On" and then press [SET]. An image that is protected is indicated by the  icon.</li><li>③ To protect other files, repeat steps 1 and 2.</li></ol> <p>To exit the protect operation, press [MENU]. To unprotect a file, select "Off" instead of "On" in step 2 above.</p>	
<b>All Files: On</b>	<p>Protects all files.</p> <ol style="list-style-type: none"><li>① Use [] and [] to select "All Files: On" and then press [SET].</li><li>② Press [MENU].</li></ol> <p>To unprotect all files, select "All Files: Off" instead of "All Files: On" in step 1 above.</p>	



### **IMPORTANT!**

- Note that even if a file is protected, it will be deleted if you perform the format operation (page 149).

## Editing the Date and Time of an Image (Date/Time)

### Procedure

[] (PLAY) → Snapshot Screen → [MENU] → PLAY Tab → Date/Time

[▲] [▼]	Changes the setting at the cursor location
[◀] [▶]	Moves the cursor between settings
[BS]	Toggles between 12-hour and 24-hour format

When the date and time settings are what you want, press [SET] to apply them.

### NOTE

- The date and time stamped into an image using the Time Stamp (page 144) cannot be edited.
- You cannot edit the date and time of an image that is protected.
- You can input any date from 1980 to 2049.

## Rotating an Image (Rotation)

### Procedure

[] (PLAY) → Snapshot or Movie Screen → [MENU] → PLAY Tab → Rotation

- 1. Use [▲] and [▼] to select “Rotation” and then press [SET].**  
Each press of [SET] will rotate the displayed image 90 degrees left.
- 2. When the displayed image is at the orientation you want, press [MENU].**

### NOTE

- Note that this procedure does not actually change the image data. It simply alters how the image is displayed on the camera's monitor screen.
- An image that has been protected or zoomed cannot be rotated.
- The original (unrotated) version of the image will be displayed on the image menu screen and the calendar screen.

## Resizing a Snapshot (Resize)

### Procedure

[▶] (PLAY) → Snapshot Screen → [MENU] → PLAY Tab → Resize

You can reduce the size of a snapshot and save the result as a separate snapshot. The original snapshot is also retained. You can select resize an image to one of three image sizes: 8M, 5M, VGA.

- Resizing a 3:2 or 16:9 size snapshot will create an image with an aspect ratio of 4:3, with both sides cut off.
- The recording date of the resized version of the snapshot will be the same as the recording date of the original snapshot.

## Cropping a Snapshot (Trimming)

### Procedure

[▶] (PLAY) → Snapshot Screen → [MENU] → PLAY Tab → Trimming

You can crop a snapshot to trim parts you do not need, and save the result in a separate file. The original snapshot is also retained.

Use the zoom controller to zoom the image to the size you want, use [▲], [▼], [◀], and [▶] to display the portion of the image you want to cut out, and then press [SET].

- The image produced by cropping a 3:2 or 16:9 image will have an aspect ratio of 4:3.
- The recording date of the cropped image will be the same as the recording date of the original snapshot.

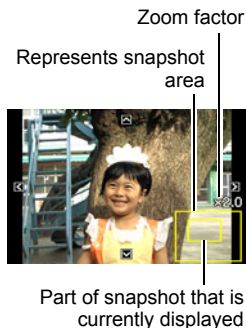

## Adding Audio to a Snapshot (Dubbing)

### Procedure

[**▶**] (PLAY) → Snapshot Screen → [MENU] → PLAY Tab → Dubbing

You can add audio to a snapshot after you shoot it. You can re-record a snapshot's audio whenever you want. You can record up to about 30 seconds of audio for a single snapshot.

#### 1. Press the shutter button to start audio recording.



Remaining recording time

#### 2. Press the shutter button again to stop audio recording.

- Take care that you do not block the camera's microphone with your fingers while recording.
- Good recording results are not possible when the camera is too far away from what you are trying to record.
- Your camera supports the following audio data formats.
  - Audio Format: WAVE/IMA-ADPCM (WAV extension)
- Adding audio (dubbing) is not possible for the following types of images.
  - Images created using MOTION PRINT
  - Protected images
- To delete audio, perform the following operation:  
Dubbing → Delete → [SET] → [MENU].

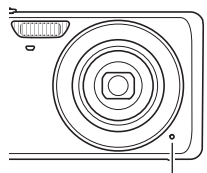

Microphone



#### **IMPORTANT!**

- Note that you cannot restore the original audio of an Audio Snapshot after you delete or re-record it.

## To play snapshot audio

1. In the **PLAY** mode, use [◀] and [▶] to scroll through the images until the **Audio Snapshot** you want is displayed.

An audio snapshot is one that has a  icon.

2. Press [SET] to start playback.

### Voice Recording Playback Controls

Fast forward/fast reverse	[◀] [▶]
Play/pause	[SET]
Volume adjustment	Press [▼] and then press [▲] [▼]
Display content switching	[▲] (DISP)
Stop playback	[MENU]







- Audio of an Audio Snapshot also can be played back on a computer with Windows Media Player or QuickTime.

## Copying Files (Copy)

### Procedure

[] (PLAY) → Snapshot Screen → [MENU] → PLAY Tab → Copy

Files can be copied from the camera's built-in memory to a memory card or from a memory card to built-in memory.

<b>Built-in → Card</b>	Copies all files from built-in camera memory to a memory card. This option copies all the files in built-in camera memory. It cannot be used to copy a single file.
<b>Card → Built-in</b>	Copies a single file on the memory card to camera built-in camera memory. Files are copied to the folder in built-in memory whose name has the largest serial number. ① Use [  ] and [  ] to select the file you want to copy. ② Use [  ] and [  ] to select "Copy" and then press [SET].

### NOTE

- You can copy snapshots, movies, audio snapshots, or Voice Recording files you recorded with this camera.
- When a copied image appears on the full-month calendar screen, it is displayed on the date that it was copied (page 91).

# Dynamic Photo

You can use the procedures in this section to crop either a moving subject or a still subject out of a snapshot and then insert it into another snapshot.

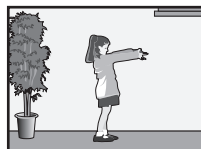

Moving Subject



Other Image

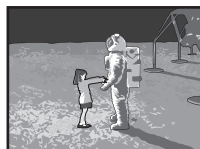

Dynamic Photo Image

## To create a subject image to be inserted (Dynamic Photo)

1. Press [BS] and then select the “Dynamic Photo” scene.
2. Press [SET], use [▲] and [▼] to specify the subject type, and then press [SET].

	CS speed	Number of Shots	Subject type
<b>Moving Subject 1sec (20fps)</b>	20 images per second	20 shots	Records multiple images of the subject, which are cropped and combined to create movement against the background image.
<b>Moving Subject 2sec (10fps)</b>	10 images per second	20 shots	
<b>Moving Subject 4sec (5fps)</b>	5 images per second	20 shots	
<b>Still Subject</b>	—	1 shot	Records a single subject, which is cropped and inserted into the background image.

- To create a still subject, select “Still Subject”.

### 3. First, shoot an image that includes the subject you want to extract.

- Shoot an image in which the subject is as large as possible. Also, the image should include some easily identifiable reference point that you can use for later alignment in step 4, below.
- If you selected “Moving Subject” the camera will record multiple subject images. Do not move the camera until shooting is complete.
- Flash is turned off automatically at this time.



### 4. Next, compose the image again, this time without the subject you want to extract. Take care so the image composition here is as close as possible to the image composition in step 3. This second image will let the camera know what part of the image in step 3 needs to be cropped.

- A semi-transparent view of the image you shot in step 3 (which includes the subject) will be visible on the monitor screen to help you compose the background image properly.

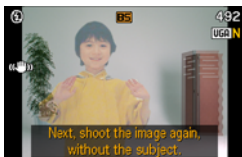

### 5. Press the shutter button to shoot the background only.

The camera compares the images you shot in steps 3 and 5 and extracts the subject. The extracted subject image will appear on the monitor screen. If you selected “Moving Subject”, the subject image will be moving on the display.

- You can interrupt an ongoing image extraction process at any time by pressing [MENU] or [BS].



#### **IMPORTANT!**

- When shooting the subject image, shoot against a white wall or some other surface of a color that is different from that of the subject. The camera will not be able to crop the subject image properly if it is the same or similar color as the background.
- The camera may not be able to cleanly crop a subject that is not clearly defined on the monitor screen due to backlighting, shadows, light smear, insufficient lighting, etc. When shooting the subject, make sure that it is clearly defined and outlined on the monitor screen.
- The background you shoot in step 5 of the above procedure is not saved. Only the cropped subject image is saved.





## Inserting a Subject into a Background Image (Dynamic Photo)

Use the following procedure to insert a subject into a new background image. A Dynamic Photo with a moving subject is saved as a 2M (1600×1200 pixels) or smaller size image. A Dynamic Photo with a still subject is saved as a 6M (2816×2112 pixels) or smaller size image.

### Procedure

[] (PLAY) → [MENU] → PLAY Tab → Dynamic Photo

**1. Use [] and [] to select the background image you want and then press [SET].**

- Only an image that satisfies the following conditions can be used as a background image.
  - An image recorded with this camera or an image transferred to this camera's memory using Photo Transport (page 129)
  - An image with an aspect ratio of 4:3

---

**2. Use [] and [] to select the subject image you want to insert and then press [SET].**

---

**3. Use the zoom controller to adjust the size of the subject and use [], [], [], and [] to adjust its position.**

---

**4. When everything is the way you want, press [SET].**

This inserts the subject into the background image and creates a Dynamic Photo.

- If the original still image into which a moving subject is inserted is smaller than 2M size, the Dynamic Photo will be the same size as the original.
- If the original still image into which a still subject is inserted is smaller than 6M size, the Dynamic Photo will be the same size as the original.

## NOTE

- The camera comes with a number of extracted sample subjects in its built-in memory, which you can use to create Dynamic Photos, if you like.
- Performing a delete or format operation will delete the sample subjects in built-in memory. If you delete the sample subjects, you can download them from the Dynamic Photo Special Site (<http://dp.exilim.com/>) and restore them to built-in camera memory.
- You can copy the sample subjects to a memory card using the “Built-in → Card” copy operation (page 110).

## To view a Dynamic Photo

1. Press **[▶]** (PLAY) and then use **[◀]** and **[▶]** to display the Dynamic Photo you want to view.
2. If the Dynamic Photo has a moving subject, press **[SET]**.
  - Subject movement is repeated as a continuous loop.

## Converting a Dynamic Photo to a Movie (Movie Converter)

A Dynamic Photo (a background image plus subject) is stored as a series of 20 still images. You can use the following procedure to convert the 20 images that make up a Dynamic Photo to a movie.

### Procedure

**[▶]** (PLAY) → Dynamic Photo Screen → **[MENU]** → **PLAY Tab** → **Movie Converter**

- The final movie format is Motion JPEG.
- The final movie image size is 640×480 pixels.



### IMPORTANT!

- This operation can be used only to convert Dynamic Photos to movies.
- Following conversion, the movie will be played back three times.

# Printing

## Printing Snapshots

### Professional Print Service

You can take a memory card that contains the images you want to print to a professional print service and have them printed.



### Printing on a Home Printer

#### Printing Images on a Printer with Memory Card Slot

You can use a printer equipped with a memory card slot to print images directly from a memory card. For details, see the user documentation that comes with your printer.



#### Connecting Directly to a PictBridge Compatible Printer

You can print on a printer that supports PictBridge (page 116).

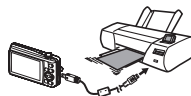

### Printing with a Computer

After transferring the images to your computer, use commercially available software to print.

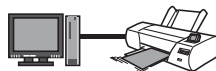

- You can specify which images you want to print, the number of copies, and date stamp settings before printing (page 118).

## Connecting Directly to a PictBridge Compatible Printer

You can connect the camera directly to a printer that supports PictBridge and print images without going through a computer.

### ■ To set up the camera before connecting to a printer

1. Turn on the camera and press [MENU].

2. On the “Set Up” tab, select “USB” and then press [▶].

3. Use [▲] and [▼] to select “PTP (PictBridge)”, and then press [SET].

### ■ Connecting the Camera to a Printer

Use the USB cable that comes bundled with the camera to connect the camera to your printer's USB port.

- The camera does not draw power over the USB cable. Make sure the camera's battery is sufficiently charged before connecting.
- Make sure that you insert the cable connector into the USB/AV port until you feel it click securely into place. Failure to insert the connector fully can result in poor communication or malfunction.
- Note that even while the connector is fully inserted, you still will be able to see the metal part of the connector as shown in the illustration.
- When connecting the USB cable to a USB port, make sure you align the connector correctly with the port.

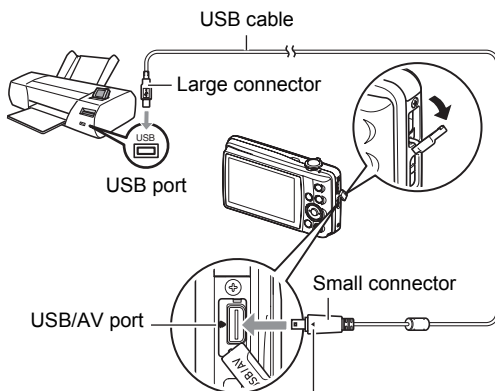

Making sure that the ▶ mark on the camera is aligned with the ◀ mark of the USB cable connector, connect the cable to the camera.

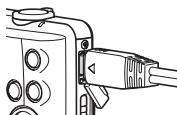

## ■ To print

### 1. Turn on the printer and load paper.

### 2. Turn on the camera.

This will display the print menu screen.

### 3. Use [▲] and [▼] to select “Paper Size”, and then press [▶].



### 4. Use [▲] and [▼] to select a paper size and then press [SET].

- The following are the available paper sizes.  
3.5"×5", 5"×7", 4"×6", A4, 8.5"×11", By Printer
- Selecting “By Printer” prints using a paper size selected on the printer.
- See the documentation that comes with your printer for information about paper settings.

### 5. Use [▲] and [▼] to specify the print option you want.

1 Image : Prints one image. Select and then press [SET]. Next, use [◀] and [▶] to select the image you want to print.

DPOF Printing : Prints multiple images. Select and then press [SET]. With this option, images will be printed in accordance with DPOF settings (page 118).

- To toggle date stamping on and off, press [BS].  
The date stamp will be printed when “On” is indicated on the monitor screen.

### 6. Use [▲] and [▼] to select “Print” and then press [SET].

Printing will start and the message “Busy... Please wait...” will appear on the monitor screen. The message will disappear after a short while, even though printing is still being performed. Pressing any camera button will cause the printing status to re-appear. The print menu screen will re-appear when printing is complete.

- If you selected “1 Image”, you can repeat the procedure from step 5, if you want.



### 7. After printing is complete, turn off the camera and disconnect the USB cable from the printer and camera.

## Using DPOF to Specify Images to be Printed and the Number of Copies



### ■ Digital Print Order Format (DPOF)

DPOF is a standard that allows you to include image type, number of copy, and time stamp on/off information on the memory card with the images. After configuring settings, you can use the memory card to print on a home printer that supports DPOF or take the memory card to a professional print service.

- Whether or not you will be able to use DPOF settings for printing depends on the printer you are using.
- Some professional print services may not support DPOF.

### ■ Configuring DPOF Settings Individually for Each Image

#### Procedure

[] (PLAY) → Snapshot Screen → [MENU] → PLAY Tab → DPOF Printing → Select images

1. Use [] and [] to scroll through the files until the image you want to print is displayed.

---

2. Use [] and [] to specify the number of copies.  
You can specify a value up to 99. Specify 00 if you do not want to print the image.
  - If you want to include the date in the images, press [BS] so “On” is shown for date stamping.
  - Repeat steps 1 and 2 to configure settings for other images, if you want.

---

3. Press [SET].

### ■ Configuring the Same DPOF Settings for All the Images

#### Procedure

[] (PLAY) → Snapshot Screen → [MENU] → PLAY Tab → DPOF Printing → All images

1. Use [] and [] to specify the number of copies.  
You can specify a value up to 99. Specify 00 if you do not want to print the image.
  - If you want to include the date in the images, press [BS] so “On” is shown for date stamping.

---

2. Press [SET].

## **DPOF settings are not cleared automatically after printing is complete.**

The next DPOF print operation you execute will be performed using the last DPOF settings you configured for the images. To clear DPOF settings, specify "00" for the number of copies of all images.

## **Tell your print service about your DPOF settings!**

If you take a memory card to a professional print service, be sure to tell them that it includes DPOF settings for the images to be printed and the number of copies. If you don't, the print service may print all the images without regard to your DPOF settings, or they may ignore your date stamp setting.

## **■ Date Stamping**

You can use one of the following three methods to include the recording date in the printout of an image.

<b>Configuring camera settings</b>
Configure DPOF settings (page 118). You can turn date stamping on and off each time you print. You can configure settings so some images include the date stamp and some don't.
Configure the Camera's Time Stamp setting (page 144). <ul style="list-style-type: none"><li>• The camera's Time Stamp setting imprints the date into a snapshot when you shoot it, so the date is always included when you print. It cannot be deleted.</li><li>• Do not turn on DPOF date stamping for an image that includes a date stamped with the camera's Time Stamp function. Doing so can cause the two stamps to be overprinted.</li></ul>
<b>Configuring computer settings</b>
You can use commercially available image management software to date stamp images.
<b>Professional print service</b>
Request date stamping when ordering prints from a professional print service.

## ■ Standards Supported by the Camera

- PictBridge

This is a standard of the Camera and Imaging Products Association (CIPA). You can connect the camera directly to a printer that supports PictBridge, and perform image selection and printing using the camera monitor screen and controls.



- PRINT Image Matching III

Using image editing software and printing on a printer that supports PRINT Image Matching III makes it possible to use information about shooting conditions that is recorded with the image, and produce exactly the type of image you want. PRINT Image Matching and PRINT Image Matching III are trademarks of Seiko Epson Corporation.



- Exif Print

Printing on a printer that supports Exif Print (Exif 2.2) uses information about shooting conditions recorded with the image to enhance printed image quality. Contact your printer manufacturer for information about models that support Exif Print, printer upgrades, etc.







# Using the Camera with a Computer

## Things you can do using a computer...

You can perform the operations described below while the camera is connected to a computer.

<b>Save images to a computer and view them there</b> 	<ul style="list-style-type: none"><li>• Save images and view them manually (USB connection) (pages 123, 132).</li></ul>
<b>Transfer images stored on your computer to camera memory</b> 	In addition to images, you also can transfer screen shot images from your computer to the camera (Photo Transport*) (page 129).
<b>Playback and edit movies</b> 	<ul style="list-style-type: none"><li>• You can play back movies (pages 126, 135).</li><li>• To edit movies, use commercially available software as required.</li></ul>

\* Windows only

The procedures you need to perform when using the camera with your computer and when using the bundled software are different for Windows and the Macintosh.

- Windows users should refer to "Using the Camera with a Windows Computer" on page 122.
- Macintosh users should refer to "Using the Camera with a Macintosh" on page 132.

## Using the Camera with a Windows Computer

Install the required software in accordance with the version of Windows you are running and what you want to do.

When you want to do this:	Operating System Version	Install this software:	See page:
Save images to a computer and view them there manually	Vista / XP / 2000	Installation not required.	123
Play movies	Vista / XP / 2000	Installation not required. <ul style="list-style-type: none"> <li>Windows Media Player, which is already installed on most computers, can be used for playback.</li> <li>If your computer is running Windows 2000 and does not have DirectX 9.0c or higher installed, download DirectX from the Microsoft DirectX site and install it on your computer.</li> </ul>	126
Edit movies	Vista / XP / 2000	– <ul style="list-style-type: none"> <li>Use commercial software as required.</li> </ul>	–
Upload movie files to YouTube	Vista / XP (SP2/SP3) / 2000 (SP4)	<b>YouTube Uploader for CASIO*</b>	127
Transfer images to the camera	Vista / XP / 2000	<b>Photo Transport 1.0*</b>	129
View the User's Guide	Vista / XP (SP2/SP3) / 2000 (SP4)	<b>Adobe Reader 8</b> (Not required if already installed.)	131

\* YouTube Uploader for CASIO and Photo Transport will not run under 64-bit versions of Windows Vista.

## ■ Computer System Requirements for Bundled Software

Computer system requirements are different for each of the applications. See the “Read me” file that comes with each application for details. Information about computer system requirements also can be found under “Computer System Requirements for Bundled Software (Bundled CD-ROM)” on page 163 of this manual.

## ■ Precautions for Windows Users

- Except for Adobe Reader, the bundled software requires Administrator privileges to run.
- Operation on a self-made computer is not supported.
- Operation may not be possible under certain computer environments.

## Viewing and Storing Images on a Computer

---

You can connect the camera to your computer in order to view and store images (snapshot and movie files).

### ■ To connect the camera to your computer and save files

1. Turn on the camera and press [MENU].
  2. On the “Set Up” tab, select “USB” and then press [▶].
  3. Use [▲] and [▼] to select “Mass Storage”, and then press [SET].
-

---

#### 4. Turn off the camera and then use the USB cable that comes with the camera to connect it to your computer.

- The camera does not draw power over the USB cable. Make sure the camera's battery is sufficiently charged before connecting.
- Make sure that you insert the cable connector into the USB/AV port until you feel it click securely into place. Failure to insert the connector fully can result in poor communication or malfunction.
- Note that even while the connector is fully inserted, you still will be able to see the metal part of the connector as shown in the illustration.
- When connecting the USB cable to a USB port, make sure you align the connector correctly with the port.
- Your computer may not be able to recognize the camera if you connect via a USB hub. Always connect directly to the computer's USB port.

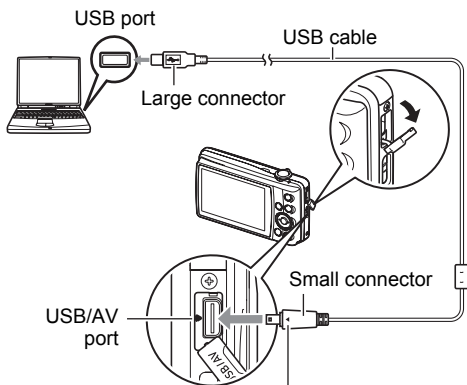

Making sure that the ► mark on the camera is aligned with the ◀ mark of the USB cable connector, connect the cable to the camera.

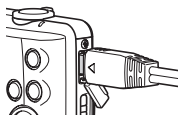

---

#### 5. Turn on the camera.

---

#### 6. Windows Vista users: Click "Start" and then "Computer". Windows XP users: Click "Start" and then "My Computer". Windows 2000 users: Doubleclick "My Computer".

---

#### 7. Double-click "Removable Disk".

- Your computer recognizes the memory card loaded in the camera (or built-in memory if there is no card) as a removable disk.

---

**8. Right-click the “DCIM” folder.**

---

**9. On the shortcut menu that appears, click “Copy”.**

---

**10. Windows Vista users: Click “Start” and then “Documents”.**

**Windows XP users: Click “Start” and then “My Documents”.**

**Windows 2000 users: Doubleclick “My Documents” to open it.**

- If you already have a “DCIM” folder in “My Documents”, the next step will overwrite it. If you want to keep the existing “DCIM” folder, you need to change its name or move it to a different location before performing the next step.

---

**11. On the “My Documents” “Edit” menu, select “Paste”.**

This will paste the “DCIM” folder (and all the image files it contains) into your “My Documents” folder. You now have a copy of the files that are in camera memory on your computer.

---

**12. After you finish copying images, disconnect the camera from the computer.**

**Windows Vista, Windows XP**

On the camera, press [ON/OFF] to turn off the camera. After making sure that the back lamp is unlit, disconnect the camera from the computer.

**Windows 2000**

Click card services in the task tray on your computer screen, and disable the drive number assigned to the camera. Next, after making sure that the back lamp is unlit, press the camera’s [ON/OFF] button to turn off the camera and disconnect the camera from your computer.

## ■ To view images you copied to your computer

**1. Double-click the copied “DCIM” folder to open it.**

---

**2. Double-click the folder that contains the images you want to view.**

---

### 3. Double-click the image file you want to view.

- For information about file names, see "Memory Folder Structure" on page 138.
- An image that was rotated on the camera will be displayed on your computer screen in its original (unrotated) orientation.

**Never use your computer to modify, delete, move, or rename any image files that are in the camera's built-in memory or on its memory card.**

Doing so can cause problems with the camera's image management data, which will make it impossible to play back images on the camera and can drastically alter remaining memory capacity. Whenever you want to modify, delete, move, or rename an image, do so only on images that are stored on your computer.

### **IMPORTANT!**

- Never unplug the USB cable, or operate the camera while viewing or storing images. Doing so can cause data to become corrupted.

---

## **Playing Movies**

Windows Media Player, which is already installed on most computers, can be used for movie playback. To play back a movie, first copy the movie to your computer and then double-click the movie file.

### **Minimum Computer System Requirements for Movie Playback**

The minimum system requirements described below are necessary to play back movies recorded with this camera on a computer.

Operating System : Vista / XP / 2000

CPU : Image Quality "HD":

Pentium 4 3.2 GHz or higher

Image Quality "STD" or "LP":

Pentium M 1.0 GHz or higher

Pentium 4 2.0 GHz or higher

Required Software: Windows Media Player, DirectX 9.0c or higher

- The above are recommended system environments. Configuring one of these environments does not guarantee proper operation.
- Certain settings and other installed software may interfere with proper playback of movies.

## ■ **Movie Playback Precautions**

- Be sure to move the movie data to the hard disk of your computer before trying to play it. Proper movie playback may not be possible for data accessed over a network, from a memory card, etc.
- Proper movie playback may not be possible on some computers. If you experience problems, try the following.
  - Try recording movies with a quality setting of “STD” or “LP”.
  - Try upgrading Windows Media Player to the latest version.
  - Quit any other applications you have running, and stop resident applications.

Even if proper playback is not possible on the computer, you can use the AV cable that comes bundled with the camera to connect to the video input terminal a TV or computer and play back movies that way.

## ■ **Uploading Movie Files to YouTube**

---

Installing YouTube Uploader for CASIO from the CD-ROM that comes with your camera simplifies uploading of movie files you recorded with the “For YouTube” BEST SHOT scene to YouTube.

### ■ **What is YouTube?**

YouTube is a movie sharing site managed by YouTube, LLC where you can upload movies and view movies uploaded by others.

### ■ **To install YouTube Uploader for CASIO**

- 1. On the CD-ROM menu screen, select “YouTube Uploader for CASIO”.**
- 2. After reading the information about installation conditions and system requirements for installation in the “Read me” file, install YouTube Uploader for CASIO.**

## ■ To upload a movie file to YouTube

- Before you can use YouTube Uploader for CASIO, you need to go to the YouTube website (<http://www.youtube.com/>) and register as a user there.
- Do not upload any video that is copyrighted (including neighboring copyrights) unless you yourself own the copyright or you have obtained the permission of the applicable copyright holder(s).
- The maximum file size for each upload is 1024 MB.

**1. Record the movie you want to upload using the “For YouTube” BEST SHOT movie scene.**

---

**2. If it isn't already, connect your computer to the Internet.**

---

**3. Connect the camera to your computer (page 123).**

---

**4. Turn on the camera.**

YouTube Uploader for CASIO will start up automatically.

- If this is the first time you are using the application, configure the YouTube user ID and network environment settings, and then click the [OK] button.
- 

**5. The left side of the display will have an area for inputting a title, category, and other information required for uploading to YouTube. Enter the required information.**

---

**6. The right side of the display shows a list of movie files in camera memory. Select the check box next to the movie file you want to upload.**

---

**7. When everything is ready, click the [Upload] button.**

This will upload the movie file(s) to YouTube.

- After uploading is complete, click the [Exit] button to exit the application.



## Transferring Images from Your Computer to Camera Memory

---

If you want to transfer images from your computer to the camera, install Photo Transport on your computer from the CD-ROM that comes with the camera.

### ■ To install Photo Transport

1. On the CD-ROM menu screen, select “Photo Transport”.

---

2. After reading the information about installation conditions and system requirements for installation in the “Read me” file, install Photo Transport.

### ■ To transfer images to the camera

1. Connect the camera to your computer (page 123).

---

2. On your computer, click the following: Start → All Programs → CASIO → Photo Transport.  
This starts up Photo Transport.

---

3. Drag the file(s) you want to transfer to the [Transfer] button.

---

4. Follow the instructions that appear on the display to complete the transfer.
  - The details of the instructions that appear on the display and the transferred images will depend on your Photo Transport setup. For details, click the [Settings] button or [Help] button and check the setup.

### Transfer Data

- Only image files with the following extensions can be transferred to the camera: jpg, jpeg, jpe, bmp (bmp images are converted to jpeg image automatically when transferred.)
- Certain types of images may not be able to be transferred.
- You cannot transfer movies to the camera.

## ■ To transfer computer screen captures to the camera

### 1. Connect the camera to your computer (page 123).

---

### 2. On your computer, click the following: Start → All Programs → CASIO → Photo Transport.

This starts up Photo Transport.

---

### 3. Display the screen whose screen capture you want to transfer.

---

### 4. Click the [Capture] button.

---

### 5. Draw a boundary around the area you want to capture.

Move your mouse pointer to the upper left corner of the area you want to capture and then hold down the mouse button. Keeping the mouse button depressed, drag the pointer down to the lower right corner of the area and then release the mouse button.

---

### 6. Follow the instructions that appear on the display.

This will send an image of the area you selected to the camera.

- The transfer operation converts screen captures to JPEG format.
- The instructions that appear on the display and details about the transferred images will depend on your Photo Transport setup. For details, click the [Settings] button or [Help] button and check the setup.

## ■ About settings and help

Click the [Settings] button when you want to change the Photo Transport setup. For help about operation procedures and troubleshooting, click the Photo Transport [Help] button.

## Viewing User Documentation (PDF Files)

---

**1. Start up your computer, and place the bundled CD-ROM into its CD-ROM drive.**

Normally, this should cause the menu screen to appear automatically. If your computer does not display the menu screen automatically, navigate to the CD-ROM on your computer and then double-click the "AutoMenu.exe" file.

---

**2. On the menu screen, click the "Language" down arrow button and then select the language you want.**

**3. Click "Manual" to select it and then click "Digital Camera".**

 **IMPORTANT!**

- You must have Adobe Reader or Adobe Acrobat Reader installed on your computer in order to view the contents of a PDF file. If you do not already have Adobe Reader or Adobe Acrobat Reader installed, install Adobe Reader from the bundled CD-ROM.

## User Registration

---

You can perform user registration over the Internet. To do so, of course, you need to be able to connect to the Internet with your computer.

**1. On the CD-ROM menu screen, click the "Register" button.**

- This starts up your Web browser and accesses the user registration website. Follow the instructions that appear on your computer screen to register.

## Using the Camera with a Macintosh

Install the required software in accordance with what version of the Macintosh OS you are running and what you want to do.

When you want to do this:	Operating System Version	Install this software:	See page:
Save images to your Macintosh and view them there manually	OS 9	Installation not required.	132
	OS X		
Save images to your Macintosh automatically/ Manage images	OS 9	Use commercially available software.	134
	OS X	Use iPhoto, which comes bundled with some Macintosh products.	
Play movies	OS 9 / OS X	You can playback with QuickTime, which comes bundled with your operating system.	135

## Connecting the Camera to Your Computer and Saving Files



### IMPORTANT!

- The camera does not support operation with Mac OS 8.6 or earlier, or Mac OS X 10.0. Operation is supported with Mac OS 9, X (10.1, 10.2, 10.3, 10.4, 10.5) only. Use the standard USB driver that comes with your supported operating system.

### ■ To connect the camera to your computer and save files

1. Turn on the camera and press **[MENU]**.
2. On the “Set Up” tab, select “USB” and then press **[▶]**.
3. Use **[▲]** and **[▼]** to select “Mass Storage”, and then press **[SET]**.

---

#### 4. Turn off the camera and then use the USB cable that comes with the camera to connect it to your Macintosh.

- The camera does not draw power over the USB cable. Make sure the camera's battery is sufficiently charged before connecting.
- Make sure that you insert the cable connector into the USB/AV port until you feel it click securely into place. Failure to insert the connector fully can result in poor communication or malfunction.
- Note that even while the connector is fully inserted, you still will be able to see the metal part of the connector as shown in the illustration.
- When connecting the USB cable to a USB port, make sure you align the connector correctly with the port.
- Your computer may not be able to recognize the camera if you connect via a USB hub. Always connect directly to the computer's USB port.

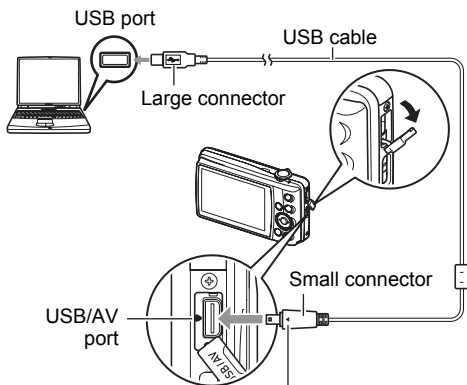

Making sure that the ► mark on the camera is aligned with the ◀ mark of the USB cable connector, connect the cable to the camera.

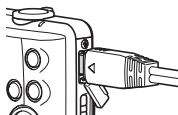

---

#### 5. Turn on the camera.

The camera's back lamp will light green at this time. In this mode, your Macintosh recognizes the memory card loaded in the camera (or the camera's built-in memory if it does not have a memory card loaded) as a drive. The appearance of the drive icon depends on the Mac OS version you are using.

---

#### 6. Double-click the camera's drive icon.

---

#### 7. Drag the "DCIM" folder to the folder to which you want to copy it.

- 
8. After the copy operation is complete, drag the drive icon to Trash.
  9. On the camera, press [ON/OFF] to turn off the camera. After making sure that the green back lamp is unlit, disconnect the camera from the computer.

#### ■ To view copied images

1. Double-click the camera's drive icon.
2. Double-click the "DCIM" folder to open it.
3. Double-click the folder that contains the images you want to view.
4. Double-click the image file you want to view.
  - For information about file names, see "Memory Folder Structure" on page 138.
  - An image that was rotated on the camera will be displayed on your Macintosh screen in its original (unrotated) orientation.

**Never use your computer to modify, delete, move, or rename any image files that are in the camera's built-in memory or on its memory card.**

Doing so can cause problems with the camera's image management data, which will make it impossible to play back images on the camera and can drastically alter remaining memory capacity. Whenever you want to modify, delete, move, or rename an image, do so only on images that are stored on your computer.



#### **IMPORTANT!**

- Never unplug the USB cable, or operate the camera while viewing or storing images. Doing so can cause data to become corrupted.

## **Transferring Images Automatically and Managing Them on Your Macintosh**

If you are running Mac OS X, you can manage snapshots using iPhoto, which comes bundled with some Macintosh products. If you are running Mac OS 9, you will need to use commercially available software.

## Playing a Movie

---

You can use QuickTime, which comes bundled with your operating system, to play back movies on a Macintosh. To play back a movie, first copy it to your Macintosh and then double-click the movie file.

### ■ Minimum Computer System Requirements for Movie Playback

The minimum system requirements described below are necessary to play back movies recorded with this camera on a computer.

Operating System : Mac OS X 10.3.9 or higher

Required Software: QuickTime 7 or higher

- The above are recommended system environments. Configuring one of these environments does not guarantee proper operation.
- Certain settings and other installed software may interfere with proper playback of movies.

### ■ Movie Playback Precautions

Proper movie playback may not be possible on some Macintosh models. If you experience problems, try the following.

- Change the movie image quality setting to “STD” or “LP”.
- Upgrade to the latest version of QuickTime.
- Shut down other applications that are running.

Even if proper playback is not possible on your Macintosh, you can use the AV cable that comes bundled with the camera to connect to the video input terminal a TV or Macintosh and play back movies that way.

### **IMPORTANT!**

- Be sure to move the movie data to the hard disk of your Macintosh before trying to play it. Proper movie playback may not be possible for data accessed over a network, from a memory card, etc.

## Viewing User Documentation (PDF Files)

---

You must have Adobe Reader or Adobe Acrobat Reader installed on your computer in order to view the contents of a PDF file. If you don't, go to the Adobe Systems Incorporated website and install Acrobat Reader.

- 1. On the CD-ROM, open the "Manual" folder.**
- 2. Open the "Digital Camera" folder and then open the folder for the language whose user's guide you want to view.**
- 3. Open the file named "camera\_xx.pdf".**
  - "xx" is the language code (Example: camera\_e.pdf is for English.)

## User Registration

---

Internet registration only is supported. Visit the following CASIO website to register:  
<http://world.casio.com/qv/register/>



## Files and Folders

The camera creates a file and saves it each time you shoot a snapshot, record a movie, or perform any other operation that stores data. Files are grouped by storing them in folders. Each file and folder has its own unique name.

- For details about how folders are organized in memory, see “Memory Folder Structure” (page 138).

Name and Maximum Number Allowed	Example
<b>File</b>	
Each folder can contain up to 9999 files named CIMG0001 through CIMG9999. The extension on the file name depends on the file type.	26th file name:  CIMG0026.JPG                 Extension Serial number (4 digits)
<b>Folders</b>	
Folders are named from 100CASIO to 999CASIO There can be up to 900 folders in memory. <ul style="list-style-type: none"><li>• The BEST SHOT (page 53) includes a sample scene that optimizes settings for auction site images. Depending on your camera model, the sample scene is named either “For eBay” or “Auction”.<ul style="list-style-type: none"><li>– Images recorded with the eBay scene are stored in a folder named “100_EBAY”.</li><li>– Images recorded with the Auction scene are stored in a folder named “100_AUCT”.</li></ul></li><li>• BEST SHOT also has a scene named “For YouTube” that optimizes movie settings for recording movies for upload to YouTube. Images recorded with the YouTube scene are stored in a folder named “100YOUTB”.</li></ul>	100th folder name:  100CASIO   Serial number (3 digits)

- You can view folder and file names on your computer. For details about how file names are displayed on the camera’s monitor screen, see page 12.
- The total number of folders and files allowed depends on the image size and quality, and capacity of the memory card being used for storage.

## Memory Card Data

The camera stores images you shoot in accordance with the Design Rule for Camera File System (DCF).

### ■ About DCF

DCF is a standard that makes it possible to view and print images recorded on one manufacturer's camera on DCF-compliant devices produced by other manufacturers. You can transfer DCF-compliant images recorded with another camera to this camera and view them on this camera's monitor screen.

### ■ Memory Folder Structure

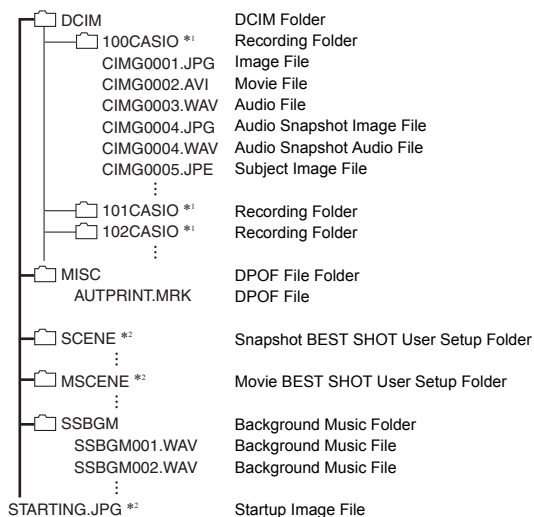

\*1 Other folders are created when the following BEST SHOT scenes are used for recording: "For eBay" or "Auction" (scene name depends on camera model), or "For YouTube". The following shows the name of the folder created for each scene.

- eBay scene: 100\_EBAY
- Auction scene: 100\_AUCT
- YouTube scene: 100YOUTB

\*2 This folder or file can be created in built-in memory only.

## ■ Supported Image Files

- Image files shot with this camera
- DCF-compliant image files

This camera may not be able to display an image, even if it is DCF-compliant. When displaying an image recorded on another camera, it may take a long time for the image to appear on this camera's monitor screen.

## ■ Built-in Memory and Memory Card Data Handling Precautions

- Whenever copying memory contents to your computer, you should copy the DCIM folder and all of its contents. A good way to keep track of multiple DCIM copies of the DCIM folders is to change its name to a date or something similar after you copy it to your computer. If you later decided to return the folder to the camera, however, be sure to change its name back to DCIM. The camera is designed to recognize only a root file with the name DCIM. Note the camera also will not be able to recognize the folders inside the DCIM folder unless they have the names they originally had when you copied them from the camera to your computer.
- Folders and files must be stored in accordance with the "Memory Folder Structure" shown on page 138 in order for the camera to be able to recognize them correctly.
- You also can use a PC card adapter or a memory card reader/writer to access camera files directly from the camera's memory card.
- A Subject Image File (CIMG\*\*\*\*.JPE) contains special image data. Never edit a Subject Image File on your computer and transfer it back to the camera. Doing so can cause abnormal camera operation.

## Other Settings (Set Up)

This section explains menu items that you can use to configure settings and perform other operations in both the REC mode and PLAY mode.

For information about menu operations, see page 62.

### REC Mode Control Panel Display ( Panel)

#### Procedure

[MENU] → Set Up Tab →  Panel

The REC mode screen layout settings let you select the layout of icons.

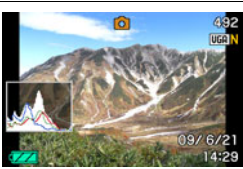
<b>On</b>	Displays the Control Panel. The Control Panel makes it quick and easy to change certain camera settings.	 A camera viewfinder showing a landscape of mountains. The right side of the screen is overlaid with a control panel containing icons for exposure mode (A), ISO, white balance (WB), and other settings. The top right corner shows '492' and '14:29'.
<b>Off</b>	Turns off Control Panel display. This setting helps to view more of the image when the 16:9 aspect ratio is selected. Certain camera settings are indicated by icons on the image.	 A camera viewfinder showing the same landscape as the 'On' setting. Instead of a full control panel, small icons for camera settings are overlaid on the image. The bottom right corner shows '09/6/21' and '14:29'.



- All screens shots in this manual show what appears while “On” is selected for the above setting.

## Selecting a PLAY Mode Screen Layout ( Display)

### Procedure

[MENU] → Set Up Tab →  Display

The PLAY mode screen layout settings let you select how display images are shown on the monitor screen.

<b>Wide</b>	With this setting, the display image is the maximum possible size that allows the entire image to be displayed horizontally. With some aspect ratios, the top and bottom of the image will be cut off.	
<b>4:3</b>	100% of the display image is always visible. With some aspect ratios, black bands may appear above and below, or to the left and right of the image.	

## Configuring Camera Sound Settings (Sounds)

### Procedure

[MENU] → Set Up Tab → Sounds

<b>Startup</b>	
<b>Half Shutter</b>	Specifies the startup sound
<b>Shutter</b>	Sound 1 - 5: Built-in sounds (1 through 5) Off: Sound off
<b>Operation</b>	
<b>Operation (L)</b>	Specifies the sound volume. This setting is also used as the audio level during video output (page 92).
<b>Play (R)</b>	Specifies the volume of movie and Audio Snapshot audio output. This volume setting is not used during video output (from the USB/AV port).

- Setting a volume level of 0 mutes output.

## Configuring a Startup Image (Startup)

### Procedure

[MENU] → Set Up Tab → Startup

Display the image you want to use as your startup image and then select “On”.

- The startup image does not appear when you turn on the camera by pressing [▶] (PLAY).
- You can specify a snapshot you recorded as the startup image, or you can use the special startup image provided in the camera’s built-in memory.
- If you select an audio snapshot as the startup image, the audio will not play at startup.
- Formatting built-in memory (page 149) will delete the current startup image setting.

## Specifying the File Name Serial Number Generation Rule (File No.)

### Procedure

[MENU] → Set Up Tab → File No.

Use the following procedure to specify the rule that governs generation of the serial number used in file names (page 137).

<b>Continue</b>	Tells the camera to remember the last used file number. A new file will be named using the next sequential number, even if files are deleted or if a blank memory card is loaded. If a memory card is loaded and that card already has files stored on it and the largest sequential number in the existing file names is greater than the largest sequential number remembered by the camera, numbering of new files will start from the largest sequential number in the existing file names plus 1.
<b>Reset</b>	Restarts the serial number from 0001 whenever all files are deleted or when the memory card is replaced with a blank one. If a memory card is loaded and that card already has files stored on it, numbering of new files will start from the largest sequential number in the existing file names number plus 1.

## Configuring World Time Settings (World Time)

### Procedure

[MENU] → Set Up Tab → World Time

You can use the World Time screen to view the current time in a zone that is different from your Home City when you go on a trip, etc. World Time displays the current time in 162 cities in 32 time zones around the globe.

**1. Use [▲] and [▼] to select “World” and then press [▶].**

- To change the geographic area and city for the time where you normally use the camera, select “Home”.

**2. Use [▲] and [▼] to select “City” and then press [▶].**

- To change the “World” setting to summer time, use [▲] and [▼] to select “DST” and then select “On”. Summer time is used in some geographical areas to advance the current time setting by one hour during the summer months.

---

3. Use [▲], [▼], [◀], and [▶] to select the geographic area you want and then press [SET].

---

4. Use [▲] and [▼] to select the city you want and then press [SET].

---

5. Press [SET].



**IMPORTANT!**

- Before configuring World Time settings, make sure that the Home City setting is the place where you live or normally use the camera. If it isn't, select "Home" on the screen in step 1 and configure the Home City, date, and time settings as required (page 145).

## Time Stamping Snapshots (Timestamp)

### Procedure

[MENU] → Set Up Tab → Timestamp

You can configure the camera to stamp the recording date only, or date and time in the lower right corner of each snapshot.

- Once date and time information is stamped into a snapshot, it cannot be edited or deleted.

Example: December 19, 2009, 1:25 p.m.

<b>Date</b>	2009/12/19
<b>Date&amp;Time</b>	2009/12/19 1:25pm
<b>Off</b>	No stamping of date and/or time

- Even if you do not stamp the date and/or time with Timestamp, you can do so later using the DPOF function or some printing application (page 119).
- Digital zoom is disabled while date stamping is turned on.
- Date stamping is not possible for the following types of images.
  - Images recorded with certain BEST SHOT scenes (Dynamic Photo, ID Photo, Business cards and documents, White board, etc.)



## Setting the Camera's Clock (Adjust)

### Procedure

[MENU] → Set Up Tab → Adjust

[▲] [▼]	Change the setting at the cursor location
[◀] [▶]	Move the cursor between settings
[BS]	Toggles between 12-hour and 24-hour format

When the date and time settings are what you want, select "Apply" and then press [SET] to apply them.

- You can specify a date from 2001 to 2049.
- Be sure to select your Home City (page 143) before setting the time and date. If you set the time and date while the wrong city is selected for your Home City, the times and dates of all of the World Time cities (page 143) will be wrong.

## Specifying the Date Style (Date Style)

### Procedure

[MENU] → Set Up Tab → Date Style

You can select from among three different styles for the date.

Example: December 19, 2009

YY/MM/DD	09/12/19
DD/MM/YY	19/12/09
MM/DD/YY	12/19/09

- This setting also affects the Control Panel date format as shown below (page 29).  
YY/MM/DD or MM/DD/YY: MM/DD  
DD/MM/YY: DD/MM

## Specifying the Display Language (Language)

### Procedure

[MENU] → Set Up Tab → Language

#### ■ Specify the display language you want.

- ① Select the tab on the right.
- ② Select "Language".
- ③ Select the language you want.



## Configuring Sleep State Settings (Sleep)

### Procedure

[MENU] → Set Up Tab → Sleep

This feature turns off the monitor screen whenever no camera operation is performed for a preset amount of time. Press any button to turn the monitor screen back on.

Trigger Time Settings: 30 sec, 1 min, 2 min, Off (Sleep is disabled while "Off" is selected.)

- Sleep is disabled under any of the following conditions.
  - In the PLAY mode
  - While the camera is connected to a computer or other device
  - During a slideshow
  - During Auto Shutter standby
  - During Voice Recording playback or recording
  - During movie recording and playback
- When both sleep and Auto Power Off are turned on, Auto Power Off takes priority.

## Configuring Auto Power Settings (Auto Power Off)

### Procedure

#### [MENU] → Set Up Tab → Auto Power Off

Auto Power Off turns off the camera whenever no camera operation is performed for a preset amount of time.

Trigger Time Settings: 1 min, 2 min, 5 min (The trigger time is always 5 minutes in the PLAY mode.)

- Auto Power Off is disabled under any of the following conditions.
  - While the camera is connected to a computer or other device
  - During a slideshow
  - During Voice Recording playback or recording
  - During movie recording and playback

## Configuring [📷] and [▶] Settings (REC/PLAY)

### Procedure

#### [MENU] → Set Up Tab → REC/PLAY

<b>Power On</b>	Camera turns on whenever [📷] (REC) or [▶] (PLAY) is pressed.
<b>Power On/Off</b>	Camera turns on or off whenever [📷] (REC) or [▶] (PLAY) is pressed.
<b>Disable</b>	Camera does not turn on or off whenever [📷] (REC) or [▶] (PLAY) is pressed.

- With “Power On/Off”, the camera turns off when you press [📷] (REC) in the REC mode or [▶] (PLAY) in the PLAY mode.
- Change this setting to anything besides “Disable” before connecting to a TV for image viewing.

## Configuring USB Protocol Settings (USB)

### Procedure

#### [MENU] → Set Up Tab → USB

You can use the procedure below to select the USB communication protocol, which is used when exchanging data with a computer, printer, or other external device.

<b>Mass Storage</b>	Select this setting when connecting to a computer (pages 123, 132). With this setting, the computer sees the camera as an external storage device. Use this setting for normal transfer of images from the camera to a computer.
<b>PTP (PictBridge)</b>	Select this setting when connecting to a printer that supports PictBridge (page 116). This setting simplifies the transfer of image data to the connected device.

## Selecting the Screen Aspect Ratio and Video Output System (Video Out)

### Procedure

#### [MENU] → Set Up Tab → Video Out

You can use the procedure in this section to select either NTSC or PAL as the video output system. You can also specify an aspect ratio of 4:3 or 16:9.

<b>NTSC</b>	Video system used in Japan, the U.S., and other countries
<b>PAL</b>	Video system used in Europe and other areas
<b>4:3</b>	Normal TV screen aspect ratio
<b>16:9</b>	Wide screen aspect ratio

- Select the aspect ratio (4:3 or 16:9) that matches the type of TV you plan to use. Images will not display correctly if you select the wrong aspect ratio.
- Images will not display correctly unless the camera's video signal output setting matches the video signal system of the TV or other video equipment.
- Images cannot be displayed correctly on a TV or video equipment that is not NTSC or PAL.

## Formatting Built-in Memory or a Memory Card (Format)

### Procedure

#### [MENU] → Set Up Tab → Format

If a memory card is loaded in the camera, this operation will format the memory card. It will format built-in memory if no memory card is loaded.

- The format operation will delete all contents on the memory card or in built-in memory. It cannot be undone. Make sure you do not need any data currently on the card or in built-in memory before you format it.
- Formatting built-in memory will delete the following data.
  - Protected images
  - BEST SHOT user setups
  - Startup screen
- Formatting a memory card will delete the following data.
  - Protected images
- Make sure the camera's battery is sufficiently charged before starting a formatting operation. Formatting may not be performed correctly and the camera may stop operating normally if the camera powers down while formatting is in progress.
- Never open the battery cover while formatting is in progress. Doing so can cause the camera to stop operating normally.

## Resetting the Camera to Factory Defaults (Reset)

### Procedure

#### [MENU] → Set Up Tab → Reset

See page 164 for details about the camera's factory default settings.

The settings below are not reset.

World Time settings, clock settings, date style, screen language, video output

# Configuring Monitor Screen Settings

You can turn display information on and off by pressing [▲] (DISP). You can configure separate settings for the REC mode and PLAY mode.

<b>Information display on</b>	Displays information about image settings, etc.	
<b>Information display + Histogram on</b>	Turns on display of camera setting and other indicators, along with a histogram (page 151)	 Histogram
<b>Information display off</b>	No information displayed	

## Using the On-screen Histogram to Check Exposure

Displays a histogram on the monitor screen which you can use to check the exposure of an image before you shoot it. You also can display the histogram in the PLAY mode for information about the exposure levels of images.

- You can use key customization (page 75) to configure the [◀] and [▶] buttons so they control the EV shift setting (page 81), and perform EV shift while viewing the results on the on-screen histogram.

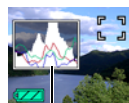

Histogram

### NOTE

- A centered histogram does not necessarily guarantee optimum exposure. The recorded image may be over-exposed or under-exposed, even though its histogram is centered.
- Due to the limitations of exposure compensation, you may not be able to achieve an optimum histogram configuration.
- Use of the flash and certain shooting conditions can cause the histogram to indicate exposure that is different from the actual exposure of the image when it is shot.

## How to Use the Histogram

A histogram is a graph that represents the lightness of an image in terms of the number of pixels. The vertical axis indicates the number of pixels, while the horizontal axis indicates lightness. If the histogram appears too lopsided for some reason, you can use EV shift to move it left or right in order to achieve better balance. Optimum exposure can be achieved by EV shifting so the graph is as close to the center as possible. For snapshots, you can even display individual histograms for R (red), G (green), and B (blue).

### Example Histograms

A histogram towards the left side results when the overall image is dark. A histogram that is too far to the left may result in “black out” of the dark areas of an image.



A histogram towards the right side results when the overall image is light. A histogram that is too far to the right may result in “white out” of the light areas of an image.



An overall well-balanced histogram results when the overall image is at optimal lightness.



## Precautions during Use

### ■ Avoid Use While In Motion

- Never use the camera to record or play back images while operating an automobile or other vehicle, or while walking. Looking at the monitor while in motion creates the risk of serious accident.

### ■ Directly Viewing the Sun or Bright Light

- Never look at the sun or any other bright light through the camera's viewfinder. Doing so can damage your eyesight.

### ■ Flash

- Never use the flash unit in areas where flammable or explosive gas may be present. Such conditions create the risk of fire and explosion.
- Never fire the flash in the direction of a person operating a motor vehicle. Doing so can interfere with the driver's vision and create the risk of accident.
- Never fire the flash too close to the eyes of the subject. Doing so creates the risk of loss of eyesight.

### ■ Monitor Screen

- Should the monitor screen ever become cracked, never touch any of the liquid inside the monitor screen. Doing so creates the risk of skin inflammation.
- Should monitor screen liquid ever get into your mouth, immediately rinse your mouth out and contact your physician.
- Should monitor screen liquid ever get into your eyes or onto your skin, immediately rinse with clean water for at least 15 minutes and contact your physician.

### ■ Connections

- Never plug any devices that are not specified for use with this camera into connectors. Connecting a non-specified device creates the risk of fire and electric shock.

### ■ Transport

- Never operate the camera inside of an aircraft or anywhere else where operation of such devices is restricted. Improper use creates the risk of serious accident.



### ■ **Smoke, abnormal odor, overheating, and other abnormalities**

- Continued use of the camera while it is emitting smoke or strange odor, or while it is overheating creates the risk of fire and electric shock. Immediately perform the following steps whenever any of the above symptoms are present.
  1. Turn off the camera.
  2. Remove the battery from the camera, taking care to protect yourself against burn injury.
  3. Contact your dealer or nearest CASIO authorized service center.

### ■ **Water and Foreign Matter**

- Water, other liquids, or foreign matter (especially metal) getting inside the camera creates the risk of fire and electric shock. Immediately perform the following steps whenever any of the above symptoms are present. Particular care is required when using the camera where it is raining or snowing, near the ocean or other body of water, or in a bathroom.
  1. Turn off the camera.
  2. Remove the battery from the camera.
  3. Contact your dealer or nearest CASIO authorized service center.

### ■ **Dropping and Rough Treatment**

- Continued use of the camera after it is damaged by dropping or other rough treatment creates the risk of fire and electric shock. Immediately perform the following steps whenever any of the above symptoms are present.
  1. Turn off the camera.
  2. Remove the battery from the camera.
  3. Contact your dealer or nearest CASIO authorized service center.

### ■ **Keep Away From Fire**

- Never expose the camera to fire, which can cause it to explode and creates the risk of fire and electric shock.

### ■ **Disassembly and Modification**

- Never try to take the camera apart or modify it in any way. Doing so creates the risk of electric shock, burn injury, and other personal injury. Be sure to leave all internal inspection, maintenance, and repair up to your dealer or nearest CASIO authorized service center.

## ■ Locations To Be Avoided

- Never leave the camera in any of the following types of locations. Doing so creates the risk of fire and electric shock.
  - Areas subject to large amounts of humidity or dust
  - Food preparation areas or other locations where oil smoke is present
  - Near heaters, on a heated carpet, in areas exposed to direct sunlight, in a closed vehicle parked in the sun, or other areas subject to very high temperatures
- Never place the camera on an unstable surface, on a high shelf, etc. Doing so can cause the camera to fall, creating the risk of personal injury.

## ■ Backing Up Important Data

- Always keep backup copies of important data in camera memory by transferring it to a computer or other storage device. Note that data can be deleted in the case of camera malfunction, repair, etc.

## ■ Memory Protection

- Whenever replacing the battery, be sure to follow the correct procedure as described in the documentation that comes with the camera. Incorrectly replacing the battery can result in corruption or loss of data in camera memory.

## ■ Rechargeable Battery

- Use only the specified charger unit or the specified device to charge the battery. Attempting to charge the battery by an unauthorized means creates the risk of battery overheating, fire, and explosion.
- Do not expose or immerse the battery in fresh water or salt water. Doing so can damage the battery, and cause deterioration of its performance and loss of service life.
- The battery is intended for use with a CASIO Digital Camera only. Use with any other device creates the risk of the battery damage, or deterioration of battery performance and service life.
- Failure to observe any of the following precautions creates the risk of battery overheating, fire, and explosion.
  - Never use or leave the battery near open flame.
  - Do not expose the battery to heat or fire.
  - Make sure the battery is oriented correctly when it is connected to the charger unit.
  - Never carry or store the battery together with items that can conduct electricity (necklaces, pencil lead, etc.)
  - Never disassemble the battery, pierce it with a needle, or expose it to strong impact (hit it with a hammer, step on it, etc.), and never apply solder to it. Never place the battery into a microwave oven, heater, high-pressure generating device, etc.

- Should you ever notice leakage, strange odor, heat generation, discoloration, deformation, or any other abnormal condition while using, charging, or storing a battery, immediately remove it from the camera or charger unit and keep it away from open flame.
- Do not use or leave the battery under direct sunlight, in an automobile parked in the sun, or in any other area subject to high temperatures. Doing so can damage the battery, and cause deterioration of its performance and loss of service life.
- If battery charging does not end normally within the specified charging time, stop charging anyway and contact your local CASIO authorized service center. Continued charging creates the risk of battery overheating, fire, and explosion.
- Battery fluid can damage your eyes. Should battery fluid get into your eyes accidentally, immediately rinse them with clean tap water and then consult a physician.
- Be sure to read the user documentation that comes with the camera and special charger unit before using or charging the battery.
- If a battery is to be used by young children, make sure that a responsible adult makes them aware of the precautions and proper handling instructions, and make sure that they handle the battery correctly.
- Should fluid from a battery accidentally get onto clothing or your skin, immediately rinse it off with clean tap water. Prolonged contact with battery fluid can cause skin irritation.

## ■ Battery Life

- Battery continuous operation times provided in this manual represent the approximate amount of time before the camera turns off due to low battery power when being powered by the special battery under normal temperature (23°C (73°F)). They do not guarantee that you will be able to achieve the indicated level of operation. Actual battery life is greatly affected by ambient temperature, battery storage conditions, the amount of time spent in storage, etc.
- Leaving the camera on can run down the battery and cause the low battery warning to appear. Turn off the camera whenever you are not using it.
- The low battery warning indicates that the camera is about to turn off due to low battery power. Charge the battery as soon as possible. Leaving a low or dead battery in the camera can lead to battery leakage and data corruption.

## ■ Data Error Precautions

Your digital camera is manufactured using precision digital components. Any of the following creates the risk of corruption of data in camera memory.

- Removing the battery or memory card while the camera is performing some operation
- Removing the battery or memory card while the back lamp is flashing green after turning off the camera
- Disconnecting the USB cable while communication is in progress
- Using a battery that is low
- Other abnormal operations

Any of the above conditions can cause an error message to appear on the monitor screen (page 172). Perform the action indicated by the message that appears.

## ■ Operating Environment

- Operating Temperature: 0 to 40°C (32 to 104°F)
- Operating Humidity: 10 to 85% (non condensation)
- Do not place the camera in any of the following locations.
  - In an area exposed to direct sunlight, or large amounts of moisture, dust, or sand.
  - Near an air conditioner or in other areas subjected to extreme temperature or humidity
  - Inside of a motor vehicle on a hot day, or in an area subjected to strong vibration

## ■ Condensation

Sudden and extreme temperature changes, such as when the camera is moved from the outdoors on a cold winter day into a warm room, can cause water droplets called “condensation” to form on the interior and the exterior of the camera, which creates the risk of malfunction. To prevent condensation from forming seal the camera in a plastic bag before changing locations. Then leave the bag sealed to allow the air inside to naturally change to the same temperature as the air in the new location. After that, remove the camera from the bag and open the battery cover for a few hours.

## ■ Lens

- Never apply too much force when cleaning the surface of the lens. Doing so can scratch the lens surface and cause malfunction.
- You may sometimes notice some distortion in certain types of images, such as a slight bend in lines that should be straight. This is due to the characteristics of lenses, and does not indicate malfunction of the camera.

## ■ Caring for your camera

- Never touch the lens or flash window with your fingers. Finger smudges, dirt, and other foreign matter on the lens or flash window can interfere with proper operation of the camera. Use a blower or other means to keep the lens and flash window free of dirt and dust, and wipe gently with a soft, dry cloth.
- To clean the camera, wipe it with a soft, dry cloth.

## ■ Old Rechargeable Battery Handling Precautions

- Insulate the positive and negative terminals with tape, etc.
- Do not peel the covering off of the battery.
- Do not try to take the battery apart.

## ■ Charger Unit Handling Precautions



- Never plug the power cord into an outlet whose voltage rating is different from that marked on the power cord. Doing so creates the risk of fire, malfunction, and electric shock.
  - Take care to protect the power cord against damage and breaking. Never place heavy objects onto the power cord, or expose it to intense heat. Doing so can damage the power cord, creating the risk of fire and electric shock.
  - Never try to modify the power cord, or subject it to severe bending, twisting, or pulling. Doing so creates the risk of fire, malfunction, and electric shock.
  - Never plug in or unplug the power cord while your hands are wet. Doing so creates the risk of electric shock.
  - Do not plug the power cord into an outlet or extension cord that is shared by other devices. Doing so creates the risk of fire, malfunction, and electric shock.
  - Should the power cord ever become damaged (to the point that internal wires are exposed or cut), immediately contact your original retailer or authorized CASIO authorized service center to request repair. Continued use of a damaged power cord creates the risk of fire, malfunction, and electric shock.
- The charger unit becomes slightly warm during charging. This is normal and does not indicate malfunction.
  - Unplug the power cord from the power outlet when you are not using the charger unit.
  - Never use detergent to clean the power cord (especially the plug).
  - Never cover the charger unit with a blanket, etc. Doing so creates the risk of fire.

## ■ Other Precautions

The camera becomes slightly warm during use. This is normal and does not indicate malfunction.

## ■ Copyrights

Except for your own personal enjoyment, unauthorized use of use of snapshots or movies of images whose rights belong to others, without the permission of the right holder, is forbidden by copyright laws. In some cases, shooting of public performances, shows, exhibitions, etc. may be restricted entirely, even if it is for your own personal enjoyment. Regardless of whether such files are purchased by you or obtained for free, posting them on a website, a file sharing site, or any other Internet site, or otherwise distributing them to third parties without the permission of the copyright holder is strictly prohibited by copyright laws and international treaties. For example, uploading or distributing on the Internet images of TV programs, live concerts, music videos, etc. that were photographed or recorded by you may infringe upon the rights of others. Note that CASIO COMPUTER CO., LTD. shall not be held liable for use of this product in any way that infringes on the copyrights of others or that violates copyright laws.

The following terms, which are used in this manual, are registered trademarks or trademarks of their respective owners.

Note that trademark <sup>™</sup> and registered trademark <sup>®</sup> are not use within the text of this manual.

- The SDHC logo is a trademark.
- Microsoft, Windows, Internet Explorer, Windows Media, Windows Vista, and DirectX are registered trademarks or trademarks of Microsoft Corporation in the United States and other countries.
- Macintosh, Mac OS, QuickTime, and iPhoto are trademarks of Apple Inc.
- Adobe and Reader are trademarks or registered trademarks in the United States and other countries of Adobe Systems Incorporated.
- YouTube, the YouTube logo, and "Broadcast Yourself" are trademarks or registered trademarks of YouTube, LLC.
- EXILIM, Photo Transport, Dynamic Photo, and YouTube Uploader for CASIO are registered trademarks or trademarks of CASIO COMPUTER CO., LTD.
- All other company or product names mentioned herein are registered trademarks or trademarks of their respective companies.

Any and all unauthorized commercial copying, distribution, and copying of the bundled software over a network are prohibited.

This product contains PrKERNELv4 Real-time OS of eSOL Co., Ltd. Copyright © 2007 eSOL Co., Ltd.

PrKERNELv4 is a registered trademark of eSOL Co., Ltd. in Japan.



This product contains the software of FotoNation, Inc. FotoNation is a registered trademark of FotoNation, Inc. FaceTracker is a trademarks of FotoNation, Inc.



This product's YouTube upload functionality is included under license from YouTube, LLC. The presence of YouTube upload functionality in this product is not an endorsement or recommendation of the product by YouTube, LLC.

## Power Supply

### Charging

#### If the [CHARGE] lamp does not light red...

Charging cannot be performed because ambient temperature or the temperature of the charger is too hot or too cold. Leave the camera in a location whose temperature is within the range where charging can be performed. When the camera returns to a temperature where charging can be performed, the [CHARGE] lamp will light red.

#### If the [CHARGE] lamp flashes red...

The battery is faulty or the battery is loaded in the charger incorrectly. Remove the battery from the charger and check if its contacts are dirty. If contacts become dirty, wipe them clean with a dry cloth. When experiencing charging problems, also check to make sure that the power cord is not disconnected from the power outlet or charger.

If problems continue to occur after you perform the above steps, it could mean that the battery is faulty. Contact your nearest CASIO authorized service center.

## To replace the battery

### 1. Open the battery cover and remove the current battery.

With the monitor screen side of the camera facing upwards, slide the stopper in the direction indicated by the arrow in the illustration. After the battery pops out, pull it the rest of the way out of the camera.

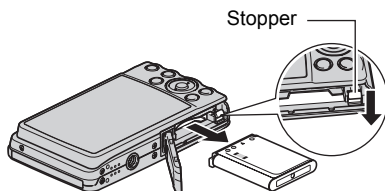

### 2. Load a new battery.

## Battery Precautions

### ■ Precautions during Use

- Operation provided by a battery under cold conditions is always less than operation under normal temperatures. This is due to the characteristics of the battery, not the camera.
- Charge the battery in an area where the temperature is within the range of 5°C to 35°C (41°F to 95°F). Outside this temperature range charging can take longer than normal or even fail.
- Do not tear or remove the battery outer label.
- If a battery provides only very limited operation following a full charge, it probably means the battery has reached the end of its service life. Replace the battery with a new one.

### ■ Storage Precautions

- Storing the battery for a long time while it is charged can cause deterioration of battery characteristics. If you do not plan to use a battery for some time, fully use up its charge before storing it.
- Always remove the battery from the camera when you are not using it. A battery left in the camera can discharge and go dead, which will require some time to charge when you need to use the camera.
- Store batteries in a cool, dry place (20°C (68°F) or lower).
- To prevent over discharging of an unused battery, fully charge it, and then load it in the camera and fully use up the charge about once every six months.



## Using the Camera in another Country

### ■ Precautions during Use

- The bundled charger is designed for operation with any power supply in the range of 100V to 240V AC, 50/60Hz. Note, however, that the shape of the power cord plug depends on each country or geographic area. Before taking the camera and charger along on a trip, check with travel agent about the power supply requirements in your destination(s).
- Do not connect the charger to a power supply through a voltage converter or similar device. Doing so can lead to malfunction.

### ■ Extra Batteries

- Taking along extra fully charged batteries (NP-80) is recommended while on a trip in order to avoid not being able to shoot images due to the battery going dead.

## Using a Memory Card

See page 19 for information about supported memory cards and how to load a memory card.

### To replace the memory card

Press the memory card and then release it. This will cause it to pop out of the memory card slot slightly. Pull the card out the rest of the way and then insert another one.

- Never remove a card from the camera while the back lamp is flashing green. Doing so can cause the image save operation to fail and even damage the memory card.

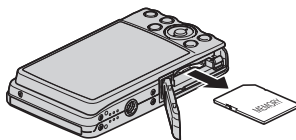

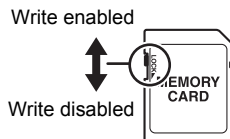

## ■ Using a Memory Card

- SD memory cards and SDHC memory cards have a write protect switch. Use the switch when you need to guard against accidentally deleting data. Note, however, if you write protect an SD memory card you must then turn write protection off whenever you want to record to it, format it, or delete any of its images.
- If a memory card starts to behave abnormally during image playback, you can restore normal operation by reformatting it (page 149). However, it is recommended that you always take along multiple memory cards whenever using the camera far away from the home or office.
- As you record data to and delete data from a memory card a number of times, it loses its ability to retain data. Because of this, periodic re-formatting of a memory card is recommended.
- Electrostatic charge, electrical noise, and other phenomena can cause data to become corrupted or even lost. Make sure that you always back up important data on other media (CD-R, CD-RW, hard disk, etc.)



## ■ Memory Card Handling Precautions

Certain types of cards can slow down processing speeds. In particular, you may experience problems saving high-quality (HD and STD) movies. Use of certain types of memory cards increase the time it takes to record movies, which can cause movie frames to be lost. This condition is indicated by  and  flashing on the monitor screen. Use of a memory card with a maximum transfer speed of at least 10MB per second is recommended.

## ■ Discarding or Transferring Ownership of a Memory Card or the Camera

The format and delete functions of the camera do not actually delete files from the memory card. The original data remains on the card. Note that responsibility for the data on a memory card lies with you. The following procedures are recommended whenever you discard a memory card or the camera, or if you transfer ownership to another party.

- When discarding a memory card, either physically destroy the memory card or use commercially available data delete software to completely delete the data on the memory card.
- When transferring ownership of a memory card to another party, use commercially available data deletion software to completely delete the data on it.
- Use the format function (page 149) to completely delete the data in built-in memory before discarding or transferring ownership of the camera.

## Computer System Requirements for Bundled Software (Bundled CD-ROM)

Computer system requirements are different for each of the applications. Be sure to check the requirements for the particular application you are trying to use. Note that the values provided here are minimum requirements for running each application. Actual requirements are greater, depending on the number of images and the sizes of the images being handled.

### ● Windows

#### **YouTube Uploader for CASIO**

Operating System : Windows Vista / XP (SP2/SP3) / 2000 (SP4)

Other : Sufficient memory to run the operating system

Computer configuration that enables playback of movies on the YouTube site

Computer configuration that enables upload of movies to the YouTube site

#### **Photo Transport 1.0**

Operating System : Windows Vista / XP / 2000

Memory : At least 64MB

Hard Disk Drive Space: At least 2MB

#### **Adobe Reader 8**

Operating System : Windows Vista / XP (SP2/SP3) / 2000 (SP4)

CPU : Pentium III Class

Memory : At least 128MB

Hard Disk Drive Space: At least 180MB

Other : Internet Explorer 6.0 or higher installed

For details about the minimum system requirements for each software application, see the “Read me” files on the CASIO Digital Camera Software CD-ROM that comes bundled with the camera.

## Reset Initial Default Settings



The tables in this section show the initial default settings that are configured for menu items (displayed when you press [MENU]) after you reset the camera (page 149).

Menu items depend on whether the camera is in the REC mode or PLAY mode.

- A dash (-) indicates an item whose setting is not reset or an item for which there is no reset setting.



### ■ REC Mode

#### “REC” Tab

<b>Focus</b>	<b>AF</b> (Auto Focus)
<b>CS</b>	Off
<b>Self-timer</b>	Off
<b>Auto Shutter</b>	Off
<b>Face Detection</b>	Off
<b>Anti Shake</b>	 Camera AS
<b>AF Area</b>	 Spot
<b>Focus Frame</b>	[ ]
<b>Digital Zoom</b>	On
<b>L/R Key</b>	Make-up
<b>Quick Shutter</b>	On
<b>easy Mode</b>	Off





<b>Grid</b>	Off
<b>Review</b>	On
<b>Icon Help</b>	On
<b>Memory</b>	<b>BS BEST SHOT:</b> Off / Auto Shutter: Off / Flash: On / Focus: Off / White Balance: Off / ISO: Off / AF Area: On / Metering: Off / CS: Off / Self-timer: Off / Flash Intensity: Off / Digital Zoom: On / MF Position: Off / Zoom Position: Off

## “Quality” Tab

<b>Size</b>	12M (4000×3000)
 <b>Quality (Snapshots)</b>	Normal
 <b>Quality (Movies)</b>	STD
<b>EV Shift</b>	0.0
<b>White Balance</b>	Auto
<b>ISO</b>	Auto

<b>Metering</b>	 Multi
<b>Lighting</b>	Extra
<b>Color Filter</b>	Off
<b>Sharpness</b>	0
<b>Saturation</b>	0
<b>Contrast</b>	0
<b>Flash Intensity</b>	0

## “Set Up” Tab

 <b>Panel</b>	On
 <b>Display</b>	Wide
<b>Sounds</b>	Startup: Sound 1 / Half Shutter: Sound 1 / Shutter: Sound 1 / Operation: Sound 1 /  Operation: ■■■□□□□ /  Play: ■■■□□□□
<b>Startup</b>	Off
<b>File No.</b>	Continue
<b>World Time</b>	Home
<b>Timestamp</b>	Off

<b>Adjust</b>	–
<b>Date Style</b>	–
<b>Language</b>	–
<b>Sleep</b>	1 min
<b>Auto Power Off</b>	2 min
<b>REC/PLAY</b>	Power On
<b>USB</b>	Mass Storage
<b>Video Out</b>	–
<b>Format</b>	–
<b>Reset</b>	–

## ■ PLAY Mode

### “PLAY” Tab

<b>Slideshow</b>	Images: All images / Time: 30 min / Interval: 3 sec / Effect: Pattern 1
<b>Dynamic Photo</b>	–
<b>Movie Converter</b>	–
<b>Layout Print</b>	–
<b>MOTION PRINT</b>	9 frames
<b>Movie Editing</b>	–
<b>Lighting</b>	–
<b>Red Eye</b>	–
<b>White Balance</b>	–
<b>Brightness</b>	0

<b>Keystone</b>	–
<b>Color Correction</b>	–
<b>DPOF Printing</b>	–
<b>Protect</b>	–
<b>Date/Time</b>	–
<b>Rotation</b>	–
<b>Resize</b>	–
<b>Trimming</b>	–
<b>Dubbing</b>	–
<b>Copy</b>	–
<b>Divide Group</b>	–







### “Set Up” Tab

- The contents of the “Set Up” tab are the same in the REC mode and PLAY mode.



## When things don't go right...

### Troubleshooting

Problem	Possible Cause and Recommended Action
<b>Power Supply</b>	
Power does not turn on.	<ol style="list-style-type: none"><li>1)The battery may not be loaded correctly (page 16).</li><li>2)The battery may be dead. Charge the battery (page 15). If the battery goes dead soon after being charged, it means the battery has reached the end of its life and needs to be replaced. Purchase a separately available CASIO NP-80 rechargeable lithium ion battery.</li></ol>
The camera suddenly powers down.	<ol style="list-style-type: none"><li>1)Auto Power Off may have activated (page 147). Turn power back on.</li><li>2)The battery may be dead. Charge the battery (page 15).</li><li>3)The camera's protection function may have activated because camera temperature is too high. Turn off the camera and wait until it cools down before trying to use it again.</li></ol>
Power will not turn off. Nothing happens when a button is pressed.	Remove the battery from the camera and then reload it.
<b>Image Recording</b>	
Image is not recorded when the shutter button is pressed.	<ol style="list-style-type: none"><li>1)If the camera is in the PLAY mode, press [RECORD] (REC) to enter the REC mode.</li><li>2)If the flash is charging, wait until the charge operation finishes.</li><li>3)If the message "Memory Full" appears, transfer images to your computer, delete images you no longer need, or use a different memory card.</li></ol>
Auto Focus does not focus properly	<ol style="list-style-type: none"><li>1)If the lens is dirty, clean it off.</li><li>2)The subject may not be in the center of the focus frame when you compose the image.</li><li>3)The subject you are shooting may not be a type that is compatible with Auto Focus (page 28). Use manual focus (page 64).</li><li>4)You may be moving the camera when shooting. Try shooting with Anti Shake or use a tripod.</li><li>5)You may be pressing the shutter button all the way without waiting for Auto Focus. Half-press the shutter button and allow enough time for Auto Focus to focus.</li></ol>

Problem	Possible Cause and Recommended Action
The subject is out of focus in the recorded image.	The image may not be focused properly. When composing the image, make sure the subject is located inside the focus frame.
The flash does not fire.	1) If  (Flash Off) is selected as the flash mode, change to another mode (page 33). 2) If the battery is dead, charge it (page 15). 3) If a BEST SHOT scene that uses  (Flash Off) is selected, change to a different flash mode (page 33) or select a different BEST SHOT scene (page 53).
The  (Flash Off) icon flashes red on the monitor screen and the flash does not fire.	The flash unit may be malfunctioning. Contact a CASIO service center or your original retailer. Note that though the flash will not fire, you still can use the camera for non-flash shots.
Camera powers down during Self-timer countdown.	The battery may be dead. Charge the battery (page 15).
The monitor screen image is out of focus.	1) You may be using Manual Focus and have not focused the image. Focus the image (page 64). 2) You may be using  (Macro) for scenery or portraits. Use Auto Focus for scenery and portrait shots (page 64). 3) You may be trying to use Auto Focus or  (Infinity) when shooting a close-up shot. Use the  (Macro) for close ups (page 64).
There is a vertical line in the monitor screen image.	Shooting a very brightly lit subject can cause a vertical band to appear in the monitor screen image. This is a CCD phenomenon known as “vertical smear”, and does not indicate malfunction of the camera. Note that vertical smear is not recorded with the image in the case of a snapshot, but it is recorded in the case of a movie.
There is digital noise in images.	1) Sensitivity may have been increased automatically for a dark subject, which increases the chance of digital noise. Use a light or some other means to illuminate the subject. 2) You may be attempting to shoot in a dark location with  (Flash Off) selected, which can increase digital noise and make images appear coarse. In this case, turn on flash (page 33) or use lights for illumination. 3) Shooting with a high ISO sensitivity setting or with the Lighting feature can cause an increase in digital noise. Use a light or some other means to illuminate the subject.



Problem	Possible Cause and Recommended Action
A recorded image was not saved.	1) Camera power may have been turned off before the save operation was complete, which will result in the image not being saved. If the battery indicator shows  , charge the battery as soon as possible (page 17). 2) You may have removed the memory card from the camera before the save operation was complete, which will result in the image not being saved. Do not remove the memory card before the save operation is complete.
Though available lighting is bright, the faces of people in the image are dark.	Not enough light is reaching the subjects. Change the flash mode setting to  (Flash On) for daylight synchro flash (page 33), or adjust EV shift to the + side (page 81).
Night shots come out bad.	Use the following BEST SHOT scenes (page 53) when shooting at night. <ul style="list-style-type: none"> <li>• Night Scene (for shooting night scenery only)</li> <li>• Night Scene Portrait (for shooting people against night scenery)</li> </ul>
Subjects are too dark when shooting images in a seashore or ski area.	Sunlight reflected by water, sand, or snow, can cause underexposure of images. Change the flash mode setting to  (Flash On) for daylight synchro flash (page 33), or adjust EV shift to the + side (page 81).
The focus frame does not appear on the monitor screen.	Normally, turning off the camera while “Detect Smile” is selected for Auto Shutter will cause the camera’s face detection setting to change. You will need to change the face detection setting again after turn on the camera. You can tell the camera to remember the Auto Shutter setting by selecting “On” for the “Auto Shutter” power on default setting (page 78).
Digital zoom (including HD zoom) does not work. The zoom bar indicates zoom only up to a zoom factor of 4.0.	1) The digital zoom setting may be turned off. Turn on digital zoom (page 75). 2) Date stamping may be turned on, which will cause digital zoom to be disabled. Turn off date stamping (page 144). 3) Digital zoom is disabled when some BEST SHOT scenes (Business cards and documents, White board, etc.) are selected. Select another scene (page 53).

Problem	Possible Cause and Recommended Action
When shooting with Auto Shutter, the shutter does not trigger.	Auto Shutter may not trigger when shooting under very bright or very dark conditions, or when shooting a fast moving subject, etc. If this happens, try changing the Auto Shutter Trigger Sensitivity setting (page 71), or press the shutter button all the way down to release the shutter and shoot the image.
The image is out of focus during movie recording.	1)Focusing may not be possible because the subject is outside the focus range. Shoot within the allowable range. 2)The lens may be dirty. Clean the lens (page 156).
<b>Playback</b>	
The color of the playback image is different from what appears on the monitor screen when shooting.	Sunlight or light from another source may be shining directly into the lens when you are shooting. Position the camera so sunlight does not shine directly into the lens.
Images are not displayed.	This camera cannot display non-DCF images recorded onto a memory card using another digital camera.
Images cannot be edited (with Layout Print, resizing, trimming, keystone correction, color restoration, date/ time editing, rotation).	1)Note that you cannot edit the following types of snapshots. <ul style="list-style-type: none"> <li>• Snapshots created using MOTION PRINT</li> <li>• Movies</li> <li>• Snapshots recorded with another camera</li> </ul> 2)With keystone correction and color restoration, editing is not possible if the camera cannot find a shape to edit within the frame on the monitor screen (pages 103, 104).
<b>Other</b>	
The wrong date and time are displayed, or the wrong date and time are being stored along with image data.	The date and time setting is off. Set the correct date and time (page 145).
The messages on the display are in the wrong language.	The wrong display language is selected. Change the display language setting (page 146).

Problem	Possible Cause and Recommended Action
Images cannot be transferred over a USB connection.	<ol style="list-style-type: none"> <li>1)The USB cable may not be connected securely. Check all connections.</li> <li>2)The wrong USB communication protocol is selected. Select the correct USB communication protocol in accordance with the type of device you are connecting (pages 123, 132).</li> <li>3)If the camera is not turned on, turn it on.</li> <li>4)Your computer may not be able to recognize the camera if you connect via a USB hub. Always connect directly to the computer's USB port.</li> </ol>
Language selection screen appears when the camera is turned on.	<ol style="list-style-type: none"> <li>1)You did not configure initial settings after purchasing the camera or the battery may have been left with a dead battery. Check the camera setup (pages 18, 146).</li> <li>2)There may be a problem with the camera's memory data. If this is the case, perform the reset operation to initialize the camera's setup (page 149). After that, configure each setting. If the language selection screen does not re-appear when you turn the camera on, it means that the camera's memory management data has been restored. If the same message appears after you turn power back on, contact your retailer or a CASIO authorized service center.</li> </ol>
The time and date settings configured the first time after purchasing the camera are reset to their factory defaults when remove the camera's battery.	<p>Load the camera's battery and reconfigure the time and date settings (page 18). Do not remove the battery from the camera for at least 24 hours after configuring time and date settings. After that, the settings will not be reset if you remove the battery.</p> <ul style="list-style-type: none"> <li>• If the time and date are reset to their factory default settings when you remove the battery after it has been loaded for more than 24 hours, it could mean that the camera's setting memory is defective. Contact your retailer or a CASIO authorized service center.</li> </ul>

## Display Messages

<b>ALERT</b>	The camera's protection function may have activated because camera temperature is too high. Turn off the camera and wait until it cools down before trying to use it again.
<b>Battery is low.</b>	Battery power is low.
<b>Cannot correct image!</b>	Keystone correction of the image cannot be performed for some reason. The image will be stored as-is, without correction (page 59).
<b>Cannot find the file.</b>	The image you specified with the slideshow "Images" setting cannot be found. Change the "Images" setting (page 94) and try again.
<b>Cannot register any more files.</b>	You are attempting to save a user BEST SHOT scene in the "SCENE" folder when the folder already contains 999 user scenes (page 56).
<b>Card ERROR</b>	<p>1) There is something wrong with the memory card. Turn off the camera, remove the memory card and then reload it into the camera. If this message re-appears when you turn the camera back on, format the memory card (page 149).</p> <p> <b>IMPORTANT!</b></p> <ul style="list-style-type: none"><li>• Formatting a memory card deletes all its files. Before formatting, try transferring recoverable files to a computer or some other storage device.</li></ul> <p>2) Are you trying to use an Eye-Fi card? This camera does not support use of an Eye-Fi card.</p>
<b>Check connections!</b>	You are attempting to connect the camera to a printer while the camera's USB settings are not compatible with the USB system of the printer (page 116).
<b>Files could not be saved because battery is low.</b>	Battery power is low, so an image file could not be saved.
<b>Folder cannot be created.</b>	You are trying to record a file while there are already 9999 files stored in the 999th folder. If you want to record more, delete files you no longer need (page 27).

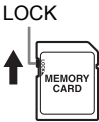
<b>LENS ERROR</b>	This message appears and the camera turns off whenever lens performs some unexpected operation. If the same message appears after you turn power back on, contact a CASIO authorized service center or your original retailer.
<b>LENS ERROR 2</b>	The Camera Shake unit may be malfunctioning. If the same message appears after you turn power back on, contact your retailer or a CASIO service center.
<b>Load paper!</b>	The printer ran out of paper while printing.
<b>Memory Full</b>	Memory is full with images you recorded and/or files saved by editing operations. Delete files you no longer need (page 27).
<b>No subjects in memory. Use the BS “Dynamic Photo” to shoot a subject.</b>	There is no extracted subject in camera memory that can be inserted into a background image.
<b>Printing Error</b>	An error occurred while printing. <ul style="list-style-type: none"> <li>• The printer is turned off.</li> <li>• The printer generated an error, etc.</li> </ul>
<b>Record Error</b>	Image compression could not be performed for some reason during image data storage. Shoot the image again.
<b>RETRY POWER ON</b>	The lens came into contact with an obstruction while moving. The camera will turn off automatically when this message appears. Remove the obstruction and turn power back on again.
<b>SYSTEM ERROR</b>	Your camera system is corrupted. Contact your retailer or an authorized CASIO authorized service center.
<b>The card is locked.</b>	The LOCK switch of the SD or SDHC memory card loaded in the camera is in the locked position. You cannot store images to or delete images from a memory card that is locked. <div style="float: right; text-align: center;"> <p>LOCK</p>  </div>
<b>There are no files.</b>	There are no files in built-in memory or on the memory card.
<b>There are no printing images. Set up DPOF.</b>	There are currently no files specified for printing. Configure the required DPOF settings (page 118).

<b>There is no image to register.</b>	The setup you are trying to save is for an image that cannot be saved as a user BEST SHOT scene.
<b>This card is not formatted.</b>	The memory card loaded in the camera is not formatted. Format the memory card (page 149).
<b>This file cannot be played.</b>	The file you are trying to access is corrupted or is a type that cannot be displayed by this camera.
<b>This function cannot be used.</b>	You attempted to copy images from built-in memory to a memory card while there is no memory card loaded in the camera (page 110).

## Number of Snapshots/Movie Recording Time/ Voice Recording Time

### Snapshot

Image Size (Pixels)	Image Quality	Approximate Image File Size	Built-in Memory (Approx. 35.7MB*1) Snapshot Recording Capacity	SD Memory Card (1GB*2) Snapshot Recording Capacity
12M (4000×3000)	Fine	7.87 MB	4	122
	Normal	4.13 MB	8	234
	Economy	2.76 MB	13	350
3:2 (4000×2656)	Fine	6.87 MB	5	140
	Normal	3.62 MB	10	267
	Economy	2.43 MB	15	398
16:9 (4000×2240)	Fine	5.66 MB	6	165
	Normal	3.0 MB	12	322
	Economy	2.02 MB	18	478
8M (3264×2448)	Fine	4.59 MB	7	210
	Normal	2.46 MB	14	393
	Economy	1.67 MB	21	579
5M (2560×1920)	Fine	2.99 MB	12	323
	Normal	1.62 MB	22	597
	Economy	1.12 MB	32	863
3M (2048×1536)	Fine	2.0 MB	18	483
	Normal	1.15 MB	31	840
	Economy	720 KB	49	1342
VGA (640×480)	Fine	330 KB	107	2928
	Normal	190 KB	186	5084
	Economy	140 KB	252	6900

## Movies

Image Quality (Pixels)	Maximum File Size	Approximate Data Rate (Frame Rate)	Built-in Memory (Approx. 35.7MB*1) Movie Recording Capacity	SD Memory Card (1GB*2) Movie Recording Capacity	File Size of 1-minute Movie
HD 1280×720	Maximum Movie Size: 4 GB	24 Megabits/second (24 frames/second)	11 seconds	5 minutes 27 seconds	179.8 MB
STD 640×480		10 Megabits/second (30 frames/second)	27 seconds	13 minutes 10 seconds	74.8 MB
LP 320×240		2.7 Megabits/second (15 frames/second)	1 minute 40 seconds	49 minutes 36 seconds	19.8 MB
YouTube 640×480	Maximum Movie Length: 10 minutes	10 Megabits/second (30 frames/second)	27 seconds	13 minutes 10 seconds	74.8 MB

## Voice Recording

File Format	Maximum File Size	File Size	Built-in Memory (Approx. 35.7MB*1) Voice Recording Capacity	SD Memory Card (1GB*2) Voice Recording Capacity
WAV IMA-ADPCM	4 GB	5.5 KB/second	1 hour 52 minutes	49 hours 33 minutes

\*1 Built-in memory capacity after formatting

\*2 The above values are based on use of a PRO HIGH SPEED SD memory card (Panasonic Corporation). The number of images you can save depends on the type of memory card you are using.

- Snapshot, movie recording capacity, and voice recording capacity values are approximate and intended for reference only. Actual capacity depends on image contents.
- File size and data rate values are approximate and intended for reference only. Actual values depend on the type of image being shot.
- When using a memory card with a different capacity, calculate the number of images as a percentage of 1GB.



## Specifications

<b>File Format</b>	Snapshots: JPEG (Exif Version 2.2); DCF 1.0 standard; DPOF compliant Movies: Motion JPEG AVI, IMA-ADPCM audio (monaural) Audio (Voice Recording): WAV (monaural)
<b>Recording Media</b>	Built-in Memory (Image Storage Area: 35.7MB*) SD/SDHC * Built-in memory capacity after formatting
<b>Recorded Image Sizes</b>	Snapshot: 12M (4000×3000), 3:2 (4000×2656), 16:9 (4000×2240), 8M (3264×2448), 5M (2560×1920), 3M (2048×1536), VGA (640×480) Movies: HD (1280×720), STD (640×480), LP (320×240), YouTube (640×480)
<b>Delete</b>	1 file; all files (with memory protection feature)
<b>Effective Pixels</b>	12.10 Megapixels
<b>Imaging Element</b>	Size: 1/2.3-inch square pixel CCD Total Pixels: 12.39 Megapixels
<b>Lens/Focal Distance</b>	F2.6 (W) to 5.9 (T) f= 4.65 to 18.6 mm (equivalent to 26 to 104 mm in 35 mm format) Seven lenses in six groups, including aspherical lens.
<b>Zoom</b>	4X optical zoom, 4X digital zoom (16X in combination with optical zoom) 25X maximum HD Zoom (in combination with optical zoom, VGA size)
<b>Focusing</b>	Contrast Detection Auto Focus • Focus Modes: Auto Focus, Macro Focus, Pan Focus, Infinity, Manual Focus • AF Area: Spot, Multi, Tracking
<b>Approximate Focus (Snapshot) (From Lens Surface)</b>	Auto Focus: 15 cm to ∞ (5.9" to ∞) (Wide Angle) Macro Focus: 5 cm to 50 cm (2.0" to 19.7") (First step zoom from the Widest Angle setting) Infinity: ∞ (Wide Angle) Manual: 15 cm to ∞ (5.9" to ∞) (Wide Angle) * Range is affected by optical zoom.
<b>Metering</b>	Multi-pattern, center weighted, and spot by imaging element
<b>Exposure Control</b>	Program AE

<b>Exposure Compensation</b>	-2.0 EV to +2.0 EV (in 1/3EV steps)
<b>Shutter</b>	CCD shutter, mechanical shutter
<b>Shutter Speed</b>	Snapshot (Auto): 1/2 to 1/2000 second Snapshot (Night Scene): 4 to 1/2000 second * May differ due to the camera setup.
<b>Aperture Value</b>	F2.6 (W) to F7.8 (W) (When used with ND filter) * Using optical zoom changes the aperture value.
<b>White Balance</b>	Auto, Daylight, Overcast, Shade, Day White Fluorescent, Daylight Fluorescent, Tungsten, Manual WB
<b>Sensitivity (Standard Output Sensitivity, Recommended Exposure Index)</b>	Snapshots: Auto, ISO 64, ISO 100, ISO 200, ISO 400, ISO 800, ISO 1600, ISO 3200 equivalent Movies: Auto
<b>Self-timer</b>	Approximate Trigger Times: 10 seconds, 2 seconds, Triple Self-timer
<b>Flash Modes</b>	Auto, Off, On, Soft, Red-eye reduction
<b>Flash Range (ISO Sensitivity: Auto)</b>	Normal: 0.15 m to 4.2 m (0.5' to 13.8') (Wide Angle) 0.6 m to 1.9 m (2.0' to 6.2') (Telephoto) Flash CS: 0.6 m to 1.6 m (2.0' to 5.2') (Wide Angle) 0.6 m to 0.7 m (2.0' to 2.3') (Telephoto) * Range is affected by optical zoom.
<b>Flash Charging Time</b>	Approximately 6 seconds maximum
<b>Recording</b>	Snapshots; Macro; Self-timer; Continuous Shutter (CS: Normal Speed CS/High Speed CS/Flash); BEST SHOT; Make-up; Auto Shutter; Face Detection; easy Mode; Dynamic Photo; Movies (normal movie, Prerecord Movie, and For YouTube) (with monaural audio); Audio (Voice Recording)
<b>Approximate Maximum Audio Recording Times</b>	After Recording: 30 seconds per image Voice Recording: 112 minutes (when using built-in memory)
<b>Monitor Screen</b>	2.7-inch wide TFT color LCD 114,960 (479×240) dots
<b>Viewfinder</b>	Monitor Screen
<b>Timekeeping Function</b>	Built-in quartz digital clock Date and Time: Recorded with image data Auto Calendar: To 2049
<b>World Time</b>	162 cities in 32 time zones City name, date, time, summer time
<b>Input/Output Terminals</b>	USB/AV port, Hi-Speed USB compatible

<b>Microphone</b>	Monaural
<b>Speaker</b>	Monaural
<b>Power Requirements</b>	Rechargeable lithium ion battery (NP-80) ×1

### Approximate Battery Life

All of the values provided below represent the approximate amount of time under normal temperature (23°C (73°F)) before the camera turns off. These values are not guaranteed. Low temperatures shorten battery life.

<b>Number of Shots (CIPA) (Operating Time)*1</b>	250 shots
<b>Continuous Playback (Snapshots)*2</b>	7 hours 30 minutes
<b>Approximate continuous movie recording time</b>	2 hours
<b>Continuous Voice Recording*3</b>	6 hours 20 minutes

- Battery: NP-80 (Rated Capacity: 700 mAh)
- Recording Medium: 1GB SD memory card (PRO HIGH SPEED (Panasonic Corporation))
- Measurement Conditions

\*1 Approximate number of shots (CIPA) (Operating Time)

In accordance with CIPA (Camera and Imaging Products Association) standards  
Normal temperature (23°C (73°F)), monitor on, zoom operation between full wide and full telephoto every 30 seconds, during which two images are shot with flash; power turned off and back on every time 10 images are shot.

\*2 Approximate playback time

Standard temperature (23°C (73°F)), one-image scroll approximately every 10 seconds

\*3 Approximate continuous recording time

- The above values are based a new battery, starting from a full charge. Repeated charging shortens battery life.
- Frequency of flash, zoom, and Auto Focus usage, and the time the camera is on greatly affects recording time and number of shots values.

<b>Power Consumption</b>	3.7 V DC, Approximately 3.0 W
<b>Dimensions</b>	98.2 (W) × 54.9 (H) × 20.1 (D) mm (3.9" (W) × 2.2" (H) × 0.8" (D)) (excluding projections; 19.6 mm (0.77") at thinnest point)
<b>Weight</b>	Approximately 112 g (4.0 oz) (excluding battery and bundled accessories)

## ■ Rechargeable lithium ion battery (NP-80)

<b>Rated Voltage</b>	3.7 V
<b>Rated Capacitance</b>	700 mAh
<b>Operating Temperature</b>	0 to 40°C (32 to 104°F)
<b>Dimensions</b>	31.4 (W) × 39.5 (H) × 5.9 (D) mm (1.24" (W) × 1.56" (H) × 0.23" (D))
<b>Weight</b>	Approximately 19 g (0.67 oz)

## ■ Charger unit (BC-80L)

<b>Input Power</b>	100 to 240 V AC, 80 mA, 50/60 Hz
<b>Output Power</b>	4.2 V DC, 550 mA
<b>Operating Temperature</b>	5 to 35°C (41 to 95°F)
<b>Supported Battery Type</b>	Rechargeable lithium ion battery (NP-80)
<b>Charging Time</b>	100 minutes
<b>Dimensions</b>	52 (W) × 20 (H) × 81 (D) mm (2.0" (W) × 0.79" (H) × 3.2" (D)) (excluding projections)
<b>Weight</b>	Approximately 50 g (1.8 oz)

- Power cord precautions for use in Singapore  
The power cord set is not supplied. The power cord used must comply with relevant national and/or international standards.

**CASIO®**

**CASIO COMPUTER CO.,LTD.**  
6-2, Hon-machi 1-chome  
Shibuya-ku, Tokyo 151-8543, Japan

# Dynamic Photo

## Getting the Most Out of Dynamic Photo

Dynamic Photo  
Special Site

For a wealth of information about Dynamic Photo including explanations about how to use Dynamic Photo images, the Dynamic Studio image conversion service, sample images, and more, visit the special Dynamic Photo website at:

<http://dp.exilim.com/>

This manual provides an introduction to Dynamic Photo, which creates a whole new way to enjoy digital imaging.

- All screen shots shown in this manual are in English. However, the camera allows you to select another display language, if you want.

### Contents

<b>Dynamic Photo! A totally new way to enjoy digital photography!</b> .....	<b>2</b>
Dynamic Photo Technology .....	2
<b>Using the Dynamic Photo Extracted Sample Subjects</b> .....	<b>3</b>
Step 1: Shoot the snapshot into which you want to insert an extracted sample subject.....	3
Step 2: Perform the following procedure to create a Dynamic Photo image. ....	3
<b>Creating a Dynamic Photo Image</b> .....	<b>5</b>
Step 1: Shoot the subject .....	5
Step 2: Create the Dynamic Photo image.....	7
■ Four Tips for Good Subject Cropping .....	9
■ Specifying the Subject Type and CS Speed .....	11
Step 3: Have fun with Dynamic Photo. ....	12
Step 4: Convert a Dynamic Photo to a Movie (Movie Converter). ....	12
Step 5: Use Dynamic Studio to expand use of Dynamic Photo images to other applications. ....	13

# Dynamic Photo! A totally new way to enjoy digital photography!

Dynamic Photo makes it easy to crop a moving subject out of a series of images and insert it into other images! A simple operation on the camera extracts a moving subject automatically by cropping up to 20 Continuous Shutter images. Become the star of your digital images! Create the images of your dreams! All on the camera, without using a computer! With Dynamic Photo you can shoot, create, and view images, just about anywhere!

## Dynamic Photo Technology

Dynamic Photo lets you extract a moving subject from a series of Continuous Shutter (CS) images and insert it into another image. This makes it possible to combine images in ways that create exciting, totally unbelievable scenes.

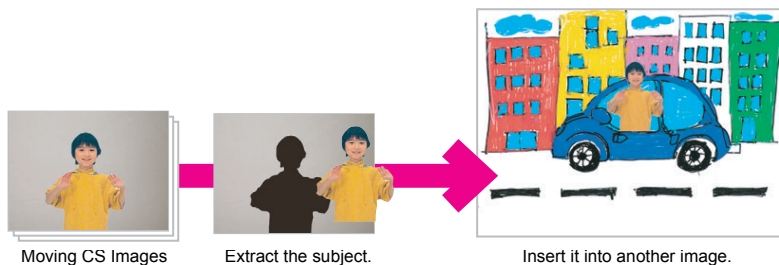

You can create a Dynamic Photo image by inserting a moving subject into a background image. Before performing the following steps, you should record the background image into which you want to insert the moving subject.

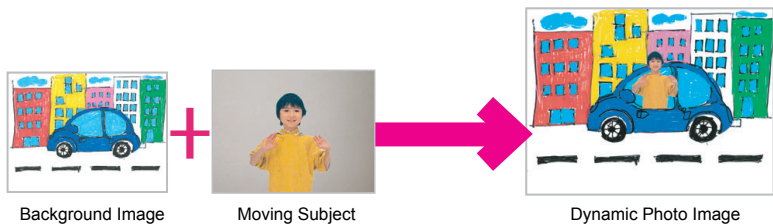

# Using the Dynamic Photo Extracted Sample Subjects

Your digital camera comes with a number of extracted sample subjects in its built-in memory. You can use these sample subjects to practice creating Dynamic Photo images by inserting them into your original snapshots.

## Step 1: Shoot the snapshot into which you want to insert an extracted sample subject.

### 1. Remove the memory card from the camera (if one is loaded).

You will not be able to access the extracted sample subjects in built-in camera memory while a memory card is loaded in the camera.



### 2. In the REC mode, compose the image and press the shutter button to shoot a standard snapshot.

You will insert the extracted sample subject into the snapshot you shoot here.

## Step 2: Perform the following procedure to create a Dynamic Photo image.

### 1. Press [▶] to enter the PLAY mode.

### 2. Perform the following operation on the camera [MENU] → PLAY tab → “Dynamic Photo”.



### 3. Use [◀] and [▶] to select the snapshot you shot in Step 1 above, and then press [SET].

### 4. Use [◀] and [▶] to select the extracted sample subject in built-in camera memory that you want to insert into the snapshot and then press [SET].

### 5. Use the zoom controller to adjust the size of the subject and use [▲], [▼], [◀], and [▶] to adjust its position. When everything is the way you want, press [SET].

This inserts the extracted sample subject into the snapshot and creates a Dynamic Photo image.





---

**6. After creation of the Dynamic Photo image is complete, the finished image with the inserted moving subject will appear on the monitor screen.**

After you master the above procedure using extracted sample subjects, you will be ready to create your own extracted subjects and insert them into snapshots for totally original Dynamic Photo images.

**Important!**

- You will not be able to access the extracted sample subjects in built-in camera memory while a memory card is loaded in the camera. If you want to use the extracted sample subjects while a memory card is loaded in the camera, use the “Built-in → Card” copy operation to copy the extracted sample subjects from built-in camera memory to the memory card.
- Performing a delete or format operation will delete the extracted sample subjects in built-in camera memory. After deleting the extracted sample subjects, you can download them from the Dynamic Photo website (<http://dp.exilim.com/>) and restore them to built-in camera memory.
- Note that the extracted sample subjects include some subjects that cannot be created using the Dynamic Photo feature of this camera.

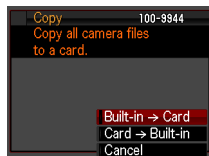

# Creating a Dynamic Photo Image

## Step 1: Shoot the subject.

Dynamic Photo images are created by extracting the subject out of one image, and inserting it into another image. The term "subject" as used here refers to what you extract or crop out of the first image. Perform the following steps to shoot and extract the subject.

**To extract the subject, you shoot once with the subject against a background. Then you shoot the same background again, this time without the subject.**

(Shoot twice.)



① With the subject



② The same angle against the same background, without the subject. Do not allow the camera to move.



The camera will extract the subject automatically.

### 1. Turn on the camera and press the [BS] button.

### 2. Select "Dynamic Photo".

On the BEST SHOT scene menu screen, select "Dynamic Photo", which is the third scene.

Use [◀] and [▶] to move the red frame

□ to  and then press the [SET] button.

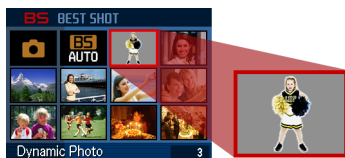

### 3. First, shoot the subject.

Best results can be obtained with the camera secured on a tripod. With the camera pointed at the moving subject, press the shutter button to record. If you selected "Moving Subject", the camera will record a series of Continuous Shutter (CS) images over a few seconds.

- To help ensure good cropping results...  
→ See "[Four Tips for Good Subject Cropping](#)".
- You can select the subject type and configure other settings here by pressing the [SET] button.  
→ See "[Specifying the Subject Type and CS Speed](#)" for more information.
- Flash is turned off (🚫) automatically when shooting with Dynamic Photo.

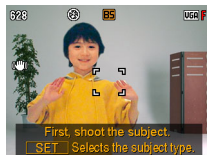

First, let's just have the subject wave or perform some other simple movement as we shoot.

### 4. Next, shoot the same background again, but this time without the subject.

After shooting the first image with the subject, have the subject exit the frame. Keep the camera still so you can maintain the same background composition as the first image (with the subject). When everything is ready, press the shutter button.

Only one shot (not CS images) of the background is recorded at this time.

As shown in the image to the right, there is no need to carefully compose the two images when shooting against a flat wall that has no visible marks at all.

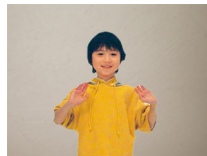
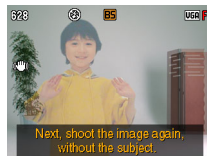

## Complete!

The camera compares the images you shot in steps 3 and 4 and extracts the subject. The extracted subject image will appear on the monitor screen. If you selected “Moving Subject”, the 20 subject images that were recorded will scroll on the screen, creating the illusion of movement.



- The background you shoot is not saved. Only the 20 cropped subject images are saved.
- You can interrupt an ongoing image extraction process at any time by pressing [MENU] or [BS].

## Step 2: Create the Dynamic Photo image.

Use the following procedure to insert the subject you extracted in Step 1 above into a photograph (new background image) and create the final Dynamic Photo image.

**1. Press [▶] to enter the PLAY mode.**

**2. Perform the following operation on the camera [MENU] → PLAY tab → “Dynamic Photo”.**



**3. Use [◀] and [▶] to select the background image you want and then press [SET].**

Select the image you want to use as the background. You should record the background image you want to use before starting this procedure.

- \* Only images that are able to be used as background images will appear at this time.
- Only an image that satisfies the following conditions can be used as a background image.
  - An image recorded with this camera or an image transferred to this camera's memory using Photo Transport
  - An image with an aspect ratio of 4:3

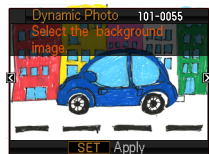

**4. Use [◀] and [▶] to select the subject you want to insert and then press [SET].**

\* Only subjects that can be inserted into other images will appear at this time.

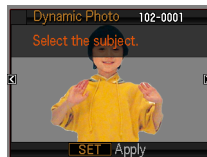

**5. Use the zoom controller to adjust the size of the subject and use [▲], [▼], [◀], and [▶] to adjust its position. When everything is the way you want, press [SET].**

This inserts the subject into the background image and creates a Dynamic Photo.



**6. After creation of the Dynamic Photo image is complete, the finished image with the moving subject will appear on the monitor screen.**



**Complete!**

- The size of a Dynamic Photo image created by inserting a moving subject into a background image is 2M. If the background image into which a moving subject is inserted is smaller than 2M, the resulting image will be the same size as the background image.
- The size of a Dynamic Photo image created by inserting a stationary subject into a background image is 6M. If the background image into which a stationary subject is inserted is smaller than 6M, the resulting image will be the same size as the background image.

## Four Tips for Good Subject Cropping

- When shooting the subject image, shoot against a white wall or some other surface whose color is different from that of the subject. The camera will not be able to crop the subject image properly if its color is the same as or similar to the background color.
- Select a blank wall for the subject background, not one with a complex pattern or shapes.



**Find a blank wall whose color is different from that of the subject.**

Recommended!!

### Shooting Technique ①



**Look for a flat wall that has no markings.**

Best cropping results are obtained when the background is a wall that is completely free of visible markings like the one shown above. In this case, it is not necessary to take pains to position the camera correctly when shooting the second (background only) image required by Dynamic Photo. When shooting against a blank wall, you can move the camera around as much as you like while shooting CS images of a moving subject.

### Shooting Technique ②



**Find some reference points and use a tripod.**

When there are reference points in the image as shown above, you need to compose the second (background only) image precisely according to the reference points. In this case, you will need to keep the camera as still as possible when shooting the first image (subject and background) and the second image (background only). Use a tripod whenever possible, and make sure that image is composed exactly the same for both the first image and the second image.

---

## Move the subject away from the wall to avoid shadows!

The camera may mistake shadows on the wall or floor caused by strong sunlight, illumination, or other light sources as part of the subject. Shadows tend to form when the subject is too close to a wall. Have the subject move as far away as possible from the wall.



---

## Do not use a moving background!

Good cropping is not possible if anything besides the subject is moving in the images. For example, avoid breaking waves, trees blowing in the wind, etc.



## Specifying the Subject Type and CS Speed

Pressing [SET] during step 1 of “3. First, shoot the subject.” will display a screen for specifying the subject type and CS speed.

You can select from among the four subject types listed below. You also can specify a stationary subject (one frame only) in addition to a moving subject.

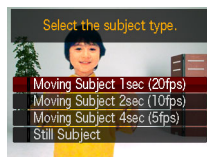

	CS speed	Number of images	Subject type
<b>Moving Subject 1sec (20fps)</b>	20 frames per second	20 images	Creates a moving subject from the CS images. <ul style="list-style-type: none"> <li>The subject is cropped out of each of the CS images.</li> <li>“Moving Subject 1sec (20fps)” provides smooth subject movement, but recording time is limited to one second.</li> <li>“Moving Subject 4sec (5fps)” provides more recording time, but subject movement is slightly rough.</li> </ul>
<b>Moving Subject 2sec (10fps)</b>	10 frames per second	20 images	
<b>Moving Subject 4sec (5fps)</b>	5 frames per second	20 images	
<b>Still Subject</b>	–	1 image	Records a single subject, which is cropped and inserted into the background image.



## Step 3: Have fun with Dynamic Photo.

You can use the Dynamic Photo image you created in Step 2 in a variety of fun ways.



### On the camera

Dynamic Photo images play back automatically as soon as you display them on the EXILIM monitor screen.



### On a TV

Connect your EXILIM to a TV with the AV cable and you can enjoy watching Dynamic Photo images on your TV screen.



## Step 4: Convert a Dynamic Photo to a Movie (Movie Converter).

A Dynamic Photo is stored as a series of 20 still images. You can use the following procedure to convert the 20 images that make up a Dynamic Photo to a movie.

1. Press **[▶]** to enter the **PLAY** mode.
2. Use **[◀]** and **[▶]** to display the Dynamic Photo you want to convert.
3. Perform the following operation on the camera **[MENU] → PLAY tab → "Movie Converter"**.



4. Press **[SET]** to convert the displayed Dynamic Photo.
  - The final movie format is Motion JPEG.
  - The final movie image size is 640×480 pixels.
5. Save the converted Dynamic Photo to your computer.

### Complete!

- This operation can be used only to convert Dynamic Photos to movies.
- Following conversion, the movie will be played back three times.

## Step 5: Use Dynamic Studio to expand use of Dynamic Photo images to other applications.

<http://dynamicstudio.jp>

Dynamic Studio is a free online service that can be used to convert the moving subject extracted from Continuous Shutter images created during a Dynamic Photo operation to a movie file quickly and easily. This makes it possible to view Dynamic Photo images you created with a CASIO EXILIM digital camera to a format that can be played back as a movie on a PC, digital photo frame, cell phone or other device. Now you can enjoy your Dynamic Photo images on a virtually unlimited number of different devices.

\* Dynamic Studio service availability and content are subject to change without notice.

### DYNAMIC STUDIO

*Dynamic Photo Data Conversion Service*

#### On a PC

Enjoy watching Dynamic Photo images on your PC screen.



#### In a digital photo frame

Play Dynamic Photo images in a digital photo frame.



#### On a cell phone

View Dynamic Photo images on your cell phone screen.

#### Share with your friends

Send the Dynamic Studio URL to your friends and share your Dynamic Photo creations with them.



#### e-Greeting Cards

Send animated e-greeting cards to your special friends and family members.

#### For presentations

Animation GIF files can be included in presentation data for an impression that really lasts.



## Free Manuals Download Website

<http://myh66.com>

<http://usermanuals.us>

<http://www.somanuals.com>

<http://www.4manuals.cc>

<http://www.manual-lib.com>

<http://www.404manual.com>

<http://www.luxmanual.com>

<http://aubethermostatmanual.com>

Golf course search by state

<http://golfingnear.com>

Email search by domain

<http://emailbydomain.com>

Auto manuals search

<http://auto.somanuals.com>

TV manuals search

<http://tv.somanuals.com>