

LCD Digital Camera
QV-700
 Owner's Manual

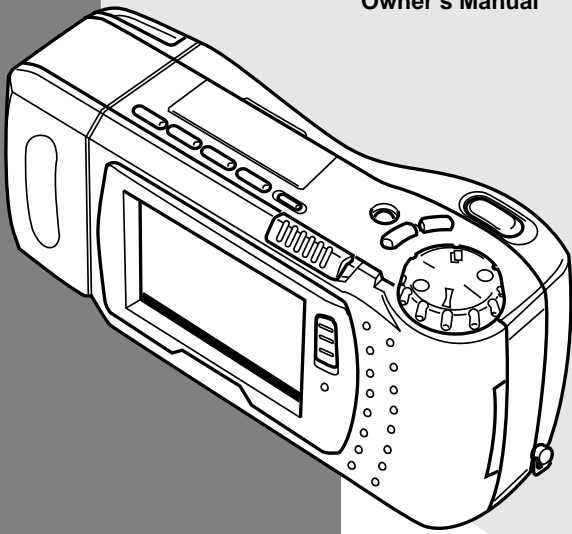

CASIO®

Introduction

Congratulations upon your selection of the QV-700 LCD Digital Camera. The QV-700 comes with its own built-in liquid crystal color monitor that let's you instantly view the pictures you take.

To get the most out of the QV-700, be sure to carefully read this manual and follow the instructions contained in it.

Contents

Precautions 5

Unpacking 11

General Guide 12

 Top and Display / Lens 12

 Bottom 13

 Dial 13

 Monitor Screen 14

 Connecting the Wrist Strap 15

 Using the Soft Case 15

Memory Cards 16

 To insert a memory card into the camera 16

 To remove a memory card from the camera 17

 Formatting a Memory Card 18

Power Supply 22

 To load batteries 22

 Using AC Power 26

Setting the Current Date and Time 28

 To set the date and time 28

 To select the date format 29

Recording Images 31

 To record an image 31

 How to avoid hand movement... 33

Fluorescent Lighting 33

Shooting Images Outdoors 34

Shooting with the Flash 34

Changing the Lens Orientation 34

NORMAL/MACRO Switch 36

Resolution Modes 36

Exposure Adjustment 37

Record Mode Displays 38

Low Battery Indicator 39

Memory Remaining Indicators 40

Using the Flash 41

Repeat Recording 42

Using the Self-timer 44

Using the Timer 45

Using Panorama Recording 48

Manual Recording 49

Playing Back Images 51

 Displaying Images on the Camera's LCD 51

 Playback Mode Displays 52

 Producing a Multi-Page Display 53

 Using the Zoom Function 55

 Superimposing a Title on an Image 57

 Rotating an Image 61

 Filtering an Image 62

 Mixing Images 64

 Using Auto Play 65

 Using Folders 68

 Image protection 71

 Unprotecting Images 73

 To unprotect all images in a folder or
 all images on the memory card 74

 Hiding Protected Memory Pages 74

Deleting Memory Pages 75

 Deleting Images 75

 Deleting All the Images in a Folder 77

Resolution Conversion 80

Connecting to Other Devices 81

 The camera terminals 81

Using the Camera with a Connected Device 82

**Accessing Memory Card Contents
 with Your Computer** 90

 Memory Card Slot 90

 PC Card Slot 90

 Other Desktop Computer Configurations 90

Troubleshooting 91

Error Messages 96

Specifications 98

About the camera's backlight... 100

- CASIO COMPUTER CO., LTD. assumes no responsibility for any damage or loss resulting from the use of this manual.
- CASIO COMPUTER CO., LTD. assumes no responsibility for any loss or claims by third parties which may arise through the use of the QV-700.
- CASIO COMPUTER CO., LTD. assumes no responsibility for any damage or loss caused by deletion of data as a result of malfunction, repairs, or battery replacement. Be sure to back up all important data on other media to protect against its loss.
- *Windows is a registered trademark of Microsoft Corporation.*
- *Apple and Macintosh are registered trademarks of Apple Computer, Inc.*
- *COMPACTFLASH is a registered trademark of SanDisk Corporation.*

Precautions

General Precautions

Be sure to observe the following important precautions whenever using the QV-700.

All references in this manual to "this camera" and "the camera" refer to the CASIO QV-700 Digital Camera.

- Never try to take pictures or use the built-in display while operating a motor vehicle or while walking. Doing so creates the danger of serious accident.
- Never try to open the case of the camera or attempt your own repairs. High-voltage internal components create the risk of electrical shock when exposed. Always leave maintenance and repair work up to authorized CASIO service providers.
- Keep the camera away from water and other liquids, and never let it get wet. Moisture creates the danger of fire and electrical shock. Never use the camera outdoors in the rain or snow, at the seashore or beach, in the bathroom, etc.
- Should foreign matter or water ever get into the unit, immediately turn power off, unplug the AC adaptor from the power outlet, and contact your dealer or nearest CASIO service provider. Using the unit under these conditions creates the danger of fire and electrical shock.
- Should you ever notice smoke or a strange odor coming out of the unit, immediately turn power off and unplug the AC adaptor from the power outlet. Using the unit under these conditions creates the danger of fire and electrical shock. After making sure there is no more smoke coming from the unit, take it to your nearest CASIO service provider for repair. Never attempt your own maintenance.
- If the unit's case should ever become cracked due to dropping it or otherwise subjecting it to rough treatment, immediately turn power off, unplug the AC adaptor from the power outlet, and contact your nearest CASIO service provider.

5

LCD Digital Camera

- Never use the unit inside of an air craft or in any other areas where its use is prohibited. Doing so can result in an accident.
- Physical damage and malfunction of this unit can cause the image data stored in its memory to be deleted. Be sure to always keep backup copies of data by transferring them to personal computer memory.
- Never open the battery compartment cover, disconnect the AC adaptor from the camera or unplug it from the wall socket while the "WAIT" message is on the LCD. Doing so will not only make storage of the current image impossible, it can also corrupt other image data already stored in camera memory.

Data Errors

Any of the following conditions can result in corruption of data stored on a memory card.

- Removal of camera batteries, disconnection of the AC adaptor, or removal of the memory card while a record or data communication operation is taking place
- Disconnection of the cable while a data communication operation is taking place
- Other abnormal operation

6

Precautions

A data error causes camera operation to lock up and one of the messages shown below to appear on the monitor screen. When this happens, perform one of the procedures indicated below.



Memory card error message



Perform the procedure on page 96 of this Owner's Manual.



System error message



Take the camera to your nearest authorized CASIO Service Provider.

Battery Life Notes

- The battery life figures noted in the specifications of this Owner's Manual indicate the number of hours before battery failure under normal operating temperatures (25°C). They do not guarantee that batteries will perform for any amount of time.
- The actual number of hours of service provided by batteries varies widely depending upon manufacturer, battery age, and temperature.
- Long term continued use of the camera can cause the low battery indicator to appear sooner than expected. Be sure to turn off power whenever the camera is not being used.
- Appearance of the low battery indicator means that batteries are about to go dead. Be sure to replace all four batteries a fresh set of new ones as soon as possible. Leaving dead batteries in the camera creates the danger of leaking batter fluid and corruption of stored image data.

7

LCD Digital Camera

Operating conditions

- This camera is designed for use in temperatures ranging from 0°C to 40°C (32°F to 104°F).
- Do not use or keep the camera in the following areas.
 - In areas subject to direct sunlight
 - In areas subject to high humidity or dust
 - Near air conditioners, heaters, or other areas subject to temperature extremes
 - Inside of a closed vehicle, especially one parked in the sun
 - In areas subject to strong vibration

Condensation

- When you bring the camera indoors on a cold day or otherwise expose it to a sudden change of temperature, there is the possibility that condensation can form on the exterior or on interior components. Condensation can cause malfunction of the camera, so you should avoid exposing it to conditions that might cause condensation.
- To keep condensation from forming, place the camera into a plastic bag before moving it into a location that is much warmer or colder than your current location. Leave it in the plastic bag until the air inside the bag has a chance to reach the same temperature as the new location. If condensation does form, remove the batteries from the camera and leave the battery compartment cover open for a few hours.

8

GUIDELINES LAID DOWN BY FCC RULES FOR USE OF THIS UNIT IN THE U.S.A. (not applicable to other areas).

This device complies with Part 15 of the FCC Rules. Operation is subject to the following two conditions: (1) this device may not cause harmful interference, and (2) this device must accept any interference received, including interference that may cause undesired operation.

NOTICE

This equipment has been tested and found to comply with the limits for a Class B peripheral, pursuant to Part 15 of the FCC Rules. These limits are designed to provide reasonable protection against harmful interference in a residential installation. This equipment generates, uses and can radiate radio frequency energy and, if not installed and used in accordance with the instructions, may cause harmful interference to radio communications. However, there is no guarantee that interference will not occur in a particular installation. If this equipment does cause harmful interference to radio or television reception, which can be determined by turning the equipment off and on, the user is encouraged to try to correct the interference by one or more of the following measures:

- Reorient or relocate the receiving antenna.
- Increase the separation between the equipment and receiver.
- Connect the equipment into an outlet on a circuit different from that to which the receiver is connected.
- Consult the dealer or an experienced radio/TV technician for help.

FCC WARNING

Changes or modifications not expressly approved by the party responsible for compliance could void the user's authority to operate the equipment.

Properly shielded cables with ferrite core must be used for connection to host computer and/or peripherals in order to meet FCC emission limits.

THE SPECIAL VIDEO CABLE THAT COMES WITH THE CAMERA ---- THE CAMERA TO A VIDEO IN TERMINAL OF A COMPUTER
THE SPECIAL CONNECTION CABLE THAT COMES WITH QV-Link SOFTWARE ---- THE CAMERA TO A PROPER TERMINAL OF A COMPUTER

Declaration of Conformity

Model Number: QV-700
 Trade Name: CASIO COMPUTER CO.,LTD.
 Responsible party: CASIO INC.
 Address: 570 MT. PLEASANT AVENUE,
 DOVER,NEW JERSEY 07801
 Telephone number: 201-361-5400

This device complies with Part 15 of the FCC Rules.
 Operation is subject to the following two conditions:
 (1) This device may not cause harmful interference, and
 (2) this device must accept any interference received, including interference that may cause undesired operation.

CASIO COMPUTER CO.,LTD. QV-700



Tested To Comply
 With FCC Standards

FOR HOME OR OFFICE USE

Unpacking

Check to make sure that all of the items shown below are included with your camera. If something is missing, contact your dealer as soon as possible.

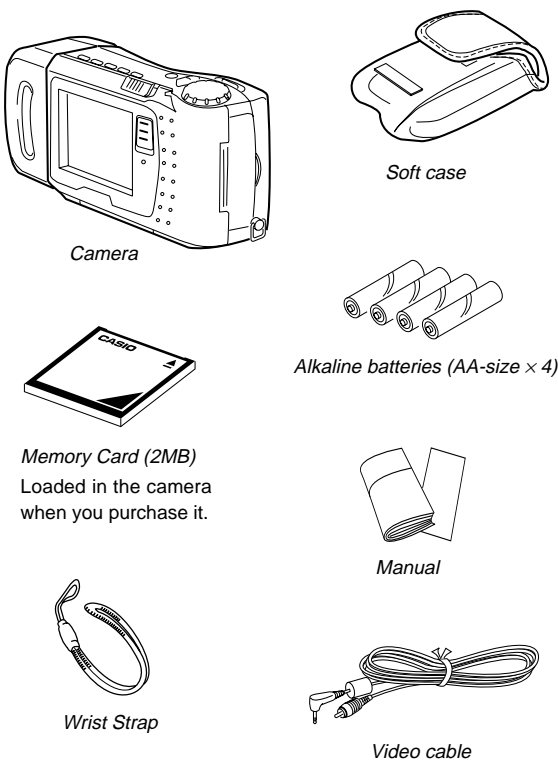

General Guide

The following illustrations show the names of each component, button and switch on the camera.

Top and Display / Lens

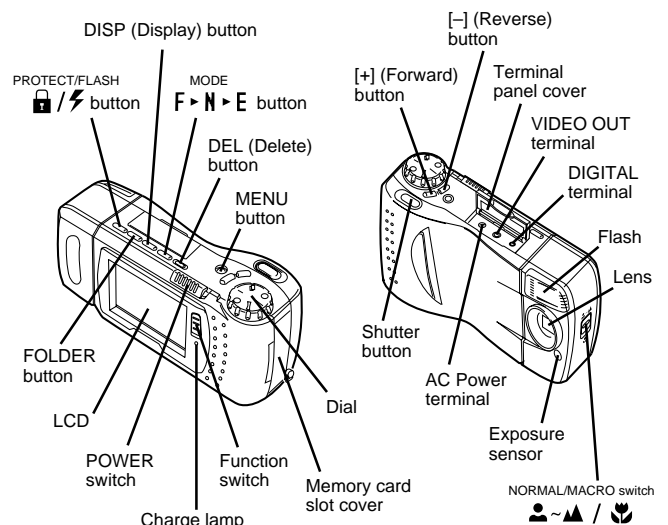

Opening the Terminal Panel Cover

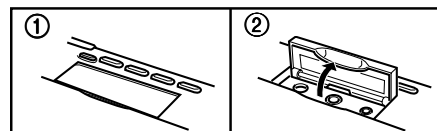

Bottom

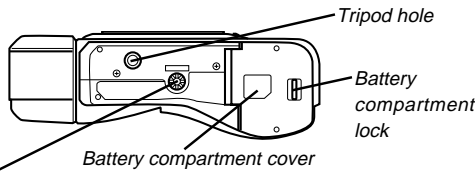

BRIGHT (brightness) control

- BRIGHT control adjusts the brightness of the image on the LCD. The brightness is set at the factory to the optimum setting, and normally does not need adjustment.

Dial

- Normal Recording For normal photography (page 31)
- Repeat Recording For recording of a sequential series of shots (page 42)
- Timer Recording For image recording using the timer (page 45)
- Title Recording For recording of an image with a title (page 57)
- Panorama Recording .. For recording of a panoramic image (page 48)
- Self-timer Recording ... For image recording using the self-timer (page 44)

Monitor Screen

Recording Mode

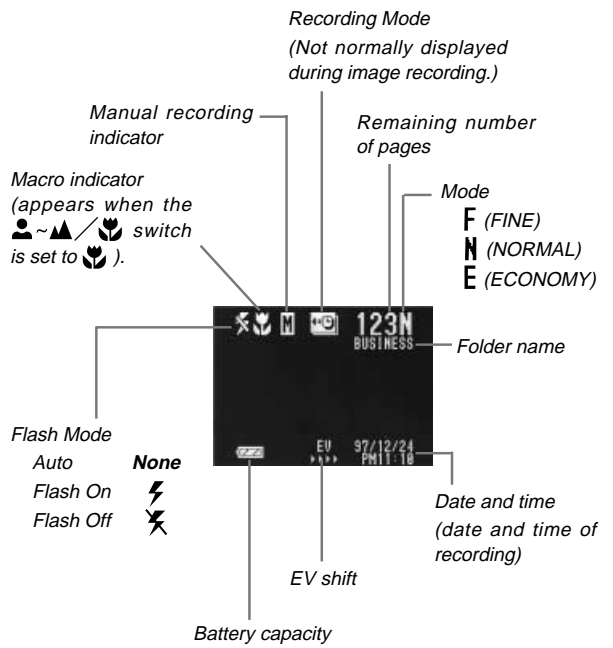

Playback Mode

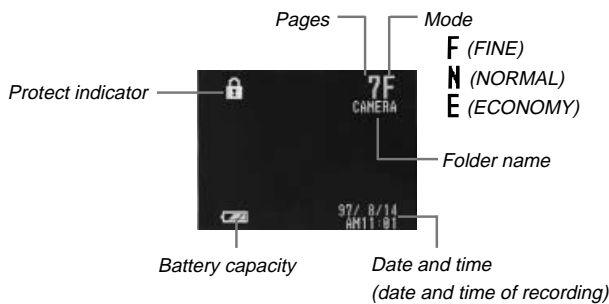

Connecting the Wrist Strap

Pass the wrist strap through the hole on the side of the camera as shown in the illustration.

Important!

Be sure to keep the wrist strap around your wrist whenever using the camera to protect against accidentally dropping it.

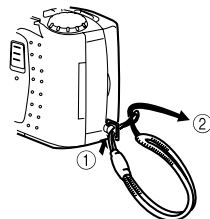

Using the Soft Case

Keep the camera in its soft case to protect it when not in use.

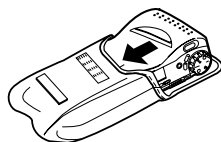

Memory Cards

This camera uses a memory card (COMPACTFLASH cards) for image memory, and a memory card is loaded in the camera when you purchase it.

Important!

- Make sure that the power of the camera is turned off before you insert or remove a memory card.
- When inserting a memory card into the camera, make sure that the card is oriented correctly. Make sure that the correct side of the card is facing up, and that you insert the correct end of the card into the camera.

To insert a memory card into the camera

1. Open the memory card slot cover.
2. As shown in the illustration, slide the memory card into the slot and push it in as far as it will go.
3. While pulling the eject button, fold it into the camera.
 - Do not try to force the eject button into the camera without pulling it. Doing so can result in damage to the eject button.
4. Close the memory card slot cover.

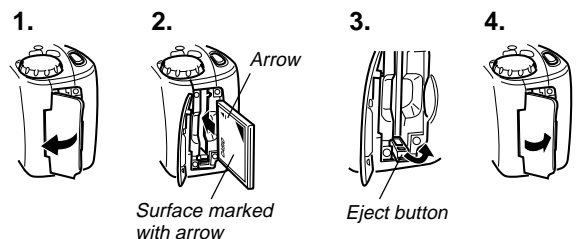

To remove a memory card from the camera

1. Open the memory card slot cover.
2. Unfold the eject button.
3. Press the eject button straight down.
4. Remove the memory card.
5. Close the memory card slot cover.

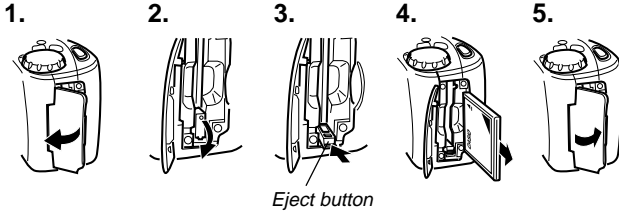

Note

To ensure proper performance, be sure to use only CASIO brand memory cards: CF-2V (2MB), CF-4V (4MB), CF-10V (10MB), or CF-15V (15MB).

Important!

- Insert only memory cards into the memory card slot. Inserting any other type of card can cause malfunction.
- Should water or any other foreign matter get into the memory card slot, immediately turn off power, unplug the AC adaptor, and contact your original retailer or nearest CASIO Service Provider.

17

Formatting a Memory Card

You can format a memory card to delete all of the data stored on it.

Important!

Data deleted by a memory card format operation cannot be recovered! Be sure to carefully check and confirm that you no longer need the data stored in a memory card before formatting it.

To format a memory card

1. Slide the function switch to the PLAY position.
2. Press MENU.

- When there are no images on the memory card, the display shows MENU in place of MENU 1.

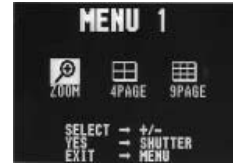

3. Use [+] and [-] to select FORMAT, and then press the shutter button.

- FORMAT is located in MENU 3.



4. Use [+] and [-] to select FORMAT, and then press the shutter button.

18

Memory Card Precautions

- Images cannot be recorded with this camera unless a memory card is installed in it.
- Be sure to use only CASIO memory cards. Proper operation with other memory cards is not guaranteed.
- Static electricity, electrical noise, and other electrical phenomena can cause corruption or even total loss of the data stored on a memory card. Because of this, you should always make backup copies of important images on other media (magnetic optical disk, floppy diskette, computer hard disk, etc.).
- Memory card problems can be corrected by reformatting the memory card (page 18). Reformatting a memory card deletes all images stored on the card, but you can use a computer to copy the images you want to keep to the computer's hard disk before reformatting your card. If you plan to be recording images where you do not have access to a computer, it is a good idea to take along an extra memory card or two just in case you experience an unexpected memory card problem.

Memory Card Folder Precautions

- The folders (directories) (page 20) are automatically created if the card you are using does not already have similarly named folders (page 68).
- Any folders (created on the memory card by a personal computer) other than those shown on page 20 do not appear on the camera's display.
- You can store up to 250 images in a single folder. Any images above this number (placed in the folder using a personal computer) are not displayed by the camera.

19

- When calculating remaining memory capacity, the camera compares the total capacity of the memory card with the number of images that can be stored in each folder. The value indicating the number of images that still can be recorded is the lower of these two values.
- Images in camera memory are assigned names that are generated according to the following format:

<First 5 characters of folder name> + <3-digit number> + .CAM

The 3-digit number starts with 001 and is incremented for each additional image. Deleting or moving images causes all following images to be renamed (renumbered) so there are never any breaks in the sequential numbering.

Folder Names

Folders are named: CAMERA, BUSINESS, PRIVATE, AAAAA, BBBB, CCCCC.

Renaming After Deletion

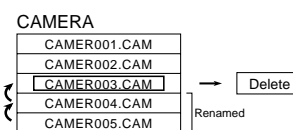

20

Renaming After Move

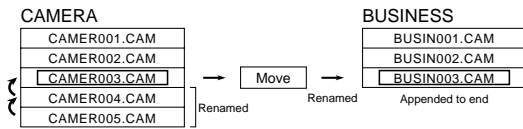

Renaming After Application of Special Effect

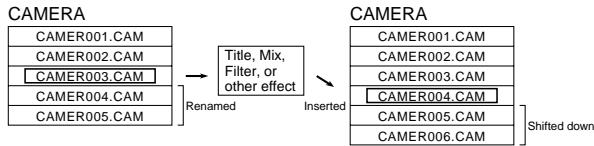

- If you assign a name that does not conform to the rules described above on your PC, the file will be renamed automatically when you place it into a folder.

21

Power Supply

The camera features a two-way power supply that lets you use either batteries (AA-size Alkaline or Lithium) or household AC current.

To load batteries

Be sure that camera power is turned off whenever loading or replacing batteries.

1. Slide the battery compartment lock on the bottom of the camera in the direction indicated by arrow ①, and swing open the battery compartment cover as indicated by arrow ②.

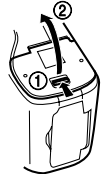

2. Insert four batteries and close the battery compartment cover.

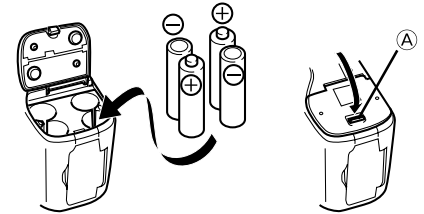

Be sure to use **Alkaline** or **Lithium** batteries. Never use manganese batteries (see precautions on the next page).

- Make sure that the positive \oplus and negative \ominus ends of the batteries are facing correctly.
- Press down on the battery compartment cover at the point marked \textcircled{A} in the above illustration until the cover locks into place with a click.

22

Battery Handling Precautions

Incorrect use or handling of batteries can cause them to leak or burst and seriously damage your camera. Be sure to note the following important precautions to avoid problems with batteries.

Caution

- Use only LR6 (AM-3) type alkaline or FR6 type lithium dry cell batteries with this camera. Never mix old batteries with new ones. Failure to do so can result in bursting or leaking of batteries, creating the danger of fire or personal injury.
- Always make sure that the positive $[+]$ and negative $[-]$ ends of the batteries are facing correctly, as noted by the markings on the camera itself. Improper loading of batteries can result in bursting or leaking of batteries, creating the danger of personal injury or soiling of objects nearby.

- Remove batteries from the camera if you do not plan to use it for more than two weeks.
- Never recharge batteries, never allow direct connection between two ends of a battery, and never try to take batteries apart.
- Do not expose batteries to direct heat or dispose of them by burning. Doing so can create the danger of explosion.
- Never mix batteries of different types.
- Dead batteries are susceptible to leakage, which can cause serious damage to your camera. Remove batteries from the camera as soon as you notice they are dead.
- The batteries that power this camera normally become warm when they lose power. This does not indicate malfunction.

23

Getting Acquainted

Standard Battery Life

The battery life reference values given below indicate the amount of time at standard temperature (25°C) until power automatically turns off due to battery failure. They do not guarantee that batteries will perform the amount of service indicated. Battery life is reduced by low temperatures and continued use.

LR6(AM3) AA-size alkaline batteries

Approximately 160 minutes (Auto Play)

Approximately 550 images (continuous recording)

FR6 AA-size lithium batteries

Approximately 270 minutes (Auto Play)

Approximately 1,050 images (continuous recording)

“Continuous recording” is made without use of the camera’s flash. Regardless of use of the camera’s flash, turning on and off the power switch, as well as other operating conditions may affect the above values.

Note

The above values are obtained based on Panasonic’s alkaline batteries and Fujifilm’s lithium batteries.

They may vary if other manufacturer’s batteries are used. For your reference, the values when the camera is operated with Duracell’s batteries are shown below.

Type of Operation	AA-size alkaline batteries LR6
Auto Play	Approximately 80 minutes
Continuous Recording	Approximately 170 images

24

Low Battery Indicator

The low battery indicator (⊗) appears in the center of the LCD whenever batteries are about to go dead. It tells you that power will soon turn off automatically if you continue using the camera without replacing batteries. Be sure to replace all four batteries with a fresh set of new ones.

Auto Power Off

Power automatically turns off whenever you do not perform any camera operation for a period of time. Power turns off after about two minutes in the Record Mode or after about five minutes in the Playback Mode.

- To restore power, simply slide the POWER switch to the right as you normally do.

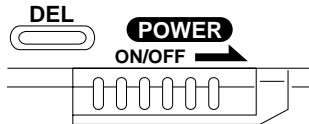

Important!

The Auto Power Off function does not operate under the following conditions.

- During Auto Play (page 65)
- When operations are being performed on a computer connected to the camera via the camera's DIGITAL terminal.
- Whenever the AC adaptor is connected to the camera.

25

Using AC Power

To power the camera from standard AC power, use the optional AC adaptor (AD-C620).

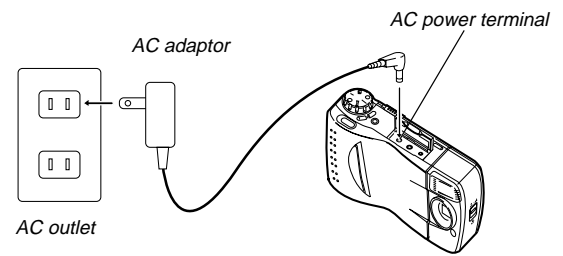

AC Adaptor precautions

- Never use an electrical outlet whose voltage is outside the rating marked on the camera. Doing so can create the danger of fire or electrical shock. Use only the optional AC adaptor specified for this camera.
- Should the cord of the AC adaptor become damaged (exposed internal wiring or shorts), request a replacement from an authorized CASIO service provider. A damaged AC adaptor cord creates the danger of fire or electrical shock.



Caution

26



Caution

- Always be sure to use the AD-C620 AC adaptor only. Using any other AC adaptor can cause damage to the camera not covered by the warranty.
- When unplugging the AC adaptor from the wall socket, be sure to grasp the adaptor (not the cord).
- Avoid an undue bending, pulling, and twisting of the AC adaptor's cord, and never try to lengthen the cord by splicing it with other wire.

- Be sure to switch power off before connecting or disconnecting the adaptor.
- Always turn camera power off before disconnecting the AC adaptor, even if the camera has batteries installed. If you don't, the camera will turn off automatically when you disconnect the AC adaptor. Even so, you run the risk of damaging the camera whenever you disconnect the AC adaptor without first turning power off.
- The AC adaptor may become warm to the touch after extended periods of use. This is normal and is not cause for alarm.
- After use turn off the power switch of the camera and unplug adaptor from the AC outlet.

27

Setting the Current Date and Time

Use the following procedures to set the current date and time, and to select the date format.

Important!

No date and time data is registered for recorded images unless you use the procedure below to set the current date and time.

To set the date and time

- Slide the function switch to the PLAY position.

- Press MENU.

- When there are no images on the memory card, the display shows MENU in place of MENU 1.



- Use [+] and [-] to select ADJUST, and then press the shutter button.

- ADJUST is located in MENU 4.



28

- Use [+] and [-] to select ADJUST, and then press the shutter button.

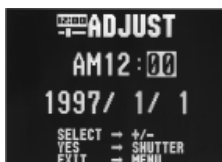

- Set the current date and time.

- Use [+] and [-] to select the setting that is highlighted on the monitor screen, and then press the shutter button to advance to the next setting. Repeat this for all of the settings on the monitor screen.

- After making all the settings on the monitor screen, press MENU to register them.

To select the date format

Example: May 12, 1998

You can select any one of the following formats for the above date: 1998/5/12, 12/5/1998, 5/12/1998.

- Slide the function switch to the PLAY position.
- Press MENU.



- Use [+] and [-] to select ADJUST, and then press the shutter button.



- Use [+] and [-] to select STYLE, and then press the shutter button.



- Use [+] and [-] to select the date format you want, and then press the shutter button.

Recording Images

The following procedure provides the basic steps for recording an image.

To record an image

- Enter the Record Mode.

- Slide the function switch to the REC position.

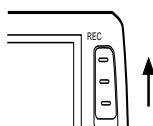

- Set the dial to  for normal recording.

- You can perform steps 1 and 2 in either order (1 then 2, or 2 then 1).



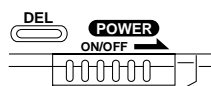

- Turn on the camera.

- Slide the POWER switch in the direction indicated by the arrow.
- The POWER switch automatically slides back to its original position when you release it.



- When power comes on, the image of the object that is in front of the camera's lens appears on the LCD.

- Set the NORMAL/MACRO switch to  ~  (NORMAL) position.

- If the object whose image you are recording is about 15 centimeters from the lens (about 6 inches), set the NORMAL/MACRO switch to  (MACRO). See page 36 for details on using this switch.

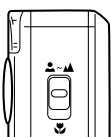

- Use F > N > E button to enter the resolution mode you want.

- Each press of F > N > E button cycles the resolution in the following sequence: F (FINE) → N (NORMAL) → E (ECONOMY).
- See "Resolution Modes" on page 36 for details on the number of images that can be stored on the memory card for each resolution.

- Record the image.

- Compose the image you want to record while viewing it on the LCD.
- It is best to look at the LCD directly, and not from an angle.
- Take care that your finger is not blocking the lens and exposure sensor.
- When the image is situated on the LCD as you want it, press the shutter button.
- Press the shutter button lightly to avoid moving the camera. See page 33 for information on how to avoid hand movement.
- Here you could change the function switch to the PLAY position and view the image you just recorded.
- Note that you can also select a memory card folder into which recorded images should be placed (page 68).

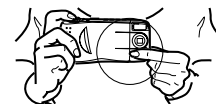

Caution

Never open the battery compartment cover, disconnect the AC adaptor from the camera or unplug it from the wall socket while the "WAIT" message is on the LCD. Doing so will not only make storage of the current image impossible, it can also corrupt other image data already stored in camera memory.

How to avoid hand movement...

Any hand movement when you press the shutter button can cause blurring of the recorded image. Note the following points on avoiding hand movement.

- Make sure there is no excessive movement of the image of the object on the LCD.

Fluorescent Lighting

Fluorescent lighting actually flickers at a frequency that cannot be detected by the human eye. When using the camera indoors under such lighting, you may experience some brightness or color problems with recorded images.

33

Shooting Images Outdoors

Note that strong direct or reflected light can cause vertical lines in an image. This is due to the characteristics of the camera's charge-coupled device (CCD), and it does not indicate malfunction of the camera.

Shooting with the Flash

With the AUTO Flash Mode, the camera automatically fires the flash whenever it detects that lighting is too low. Note that the monitor screen image disappears and the charger lamp flashes to indicate that the flash unit is recharging. See "Using the Flash" on page 41 for full details on using the flash.

Important!

Do not fire the flash when it is located a very short distance from a person, especially when it is pointed at the person's face. Doing so creates the danger of eye damage.

Changing the Lens Orientation

The lens of the camera is built into a lens body that is designed to rotate. This means you can change the angle of the lens without moving the rest of the camera.

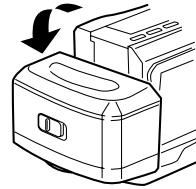

Rotates up to 90°
towards the front

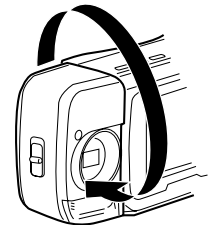

Rotates up to 180°
towards the back

34

- Any images recorded while the lens body is rotated so the lens is pointed from the back of the camera are stored as mirror images of the image that appears in the LCD before the shutter button is pressed.

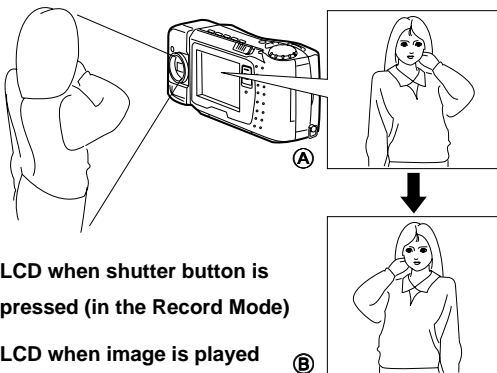

A LCD when shutter button is pressed (in the Record Mode)

B LCD when image is played back from camera memory

Important!

- Do not apply excessive force when rotating the lens body. Doing so can cause serious damage to the lens.
- Do not carry the camera or move it around while holding onto only the lens body.
- Return the lens body to its normal position (with the lens pointing from the front of the camera) before storing the camera.

35

NORMAL/MACRO Switch

The NORMAL/MACRO switch tells the camera how much distance there will be between the lens and the object whose image you are recording. The following table describes the conditions covered by each switch setting.

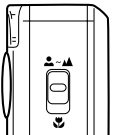

☘ is shown on the monitor screen whenever the macro position is in use.

	☘~▲ (NORMAL)	☘ (MACRO)
Focus Range	0.7 meters to ∞ (2.3' ~ ∞)	14 to 16 cm (5.5" ~ 6.3")

The above figures indicate the distance from the lens protection filter to the subject.

Resolution Modes

The camera has three resolution modes: FINE (F), NORMAL (N), and ECONOMY (E). The following shows the number of images that can be recorded on a 2MB memory card in each mode.

- To determine the number of images that can be stored on a memory card of a different capacity, multiply the capacities in the table by the appropriate value. In the case of a 4MB memory card, for example, multiply by 2.
- The actual number of images that can be recorded may differ somewhat from the values provided below, due to the amount of memory required for storage of different types of images.

Resolution Mode	Indicator	Number of Images
FINE	F	Approximately 14 (approximately 133KB compressed)
NORMAL	N	Approximately 26 (approximately 70KB compressed)
ECONOMY	E	Approximately 47 (approximately 38KB compressed)

36

Exposure Adjustment

This camera features a program AE function that automatically changes shutter speed and aperture in accordance with available light. In addition, you can also manually adjust the exposure to compensate for backlighting, indirect indoor lighting, dark backgrounds, and other special conditions.

To manually adjust the exposure

1. Set the function switch to the REC position.
2. Use [+] and [-] to perform exposure compensation and display a bar graph on the monitor screen.
 - Pressing [+] makes the image on the LCD brighter. Use it to adjust for dim indoor lighting and backlighting.
 - Pressing [-] makes the image on the LCD darker. Use it to adjust for bright sunlight.

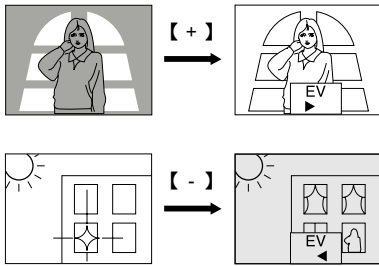

- The bar graph turns red whenever the compensation value is at its limit.

3. After adjusting the exposure, press the shutter button to record the image.

37

Notes

- Exposure adjustment is generally expressed in terms of an exposure adjustment value. The exposure adjustment value is always set to zero whenever you turn on the camera.
- The exposure adjustment value is changed by 0.5EV with each press of [+] or [-]. The range of the value is -2EV to +2EV.
- The exposure adjustment value automatically reverts to zero whenever the shutter button is pressed. You can manually reset the exposure adjustment value by using [+] and [-] to change the value back to zero, which is indicated when the bar graph disappears from the monitor.

Important!

- When the exposure adjustment is too bright or too dark, you may not be able to adjust within the range of -2EV to +2EV.
- The aperture setting of this camera switches automatically in accordance with available lighting when an image is recorded. The switching operation causes the camera to emit a noise. This is normal and does not indicate malfunction.

Record Mode Displays

Use the following procedure to display various parameters about an image.

1. Slide the function switch to the REC position.

38

2. Press the DISP button.

- * Each press of DISP cycles the contents of the display in the following sequence: page → date and time → page/date and time.

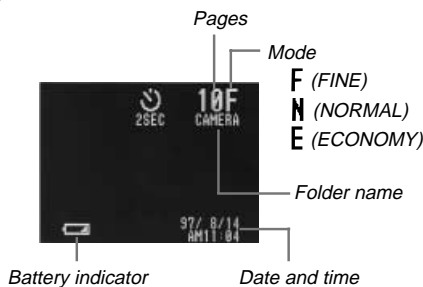

Low Battery Indicator

A low battery indicator (🔋) appears on the monitor screen whenever remaining battery capacity drops below a certain level. Appearance of this indicator tells you that batteries are about to go dead and need to be replaced with a full set of four new ones as soon as possible.

Note that the camera may automatically shut down at a somewhat higher level of remaining battery capacity when a computer is connected to its DIGITAL terminal for data communication. This is to protect against problems caused by sudden power outage during data communications. Because of this, we strongly recommend that you use the optionally available AC adaptor to power the camera whenever performing data communication with a personal computer.

- See page 22 for details on how to replace the batteries.

39

Memory Remaining Indicators

The message "REMAINING" indicates that you must change to a different mode (resolution) in order to record more images. This message appears in either of the two following cases.

- When you are recording in the FINE mode and remaining memory capacity cannot accept any more FINE images but can accept additional NORMAL or ECONOMY images.
- When you are recording in the NORMAL mode and remaining memory capacity cannot accept any more NORMAL images but can accept additional ECONOMY images.

In either of the above cases, use **F ▶ N ▶ E** button to change to a lower resolution mode if you want to continue recording images.

Should the "MEMORY FULL" message appear, it means that you will not be able to record any more images or use certain functions (such as filters, mixing and titles) until you delete some images currently on the memory card (page 75), convert some FINE images to NORMAL or some NORMAL images to ECONOMY images (page 80), or replace the memory card with a different one (page 16).

- Note that the image capacity numbers provided in this Owner's manual are for reference purposes only. They do not guarantee that you will be able to actually store the number of images indicated.

40

Using the Flash

You can use the camera's built in flash when recording images.

To change the flash mode

Press button to cycle through flash modes in the following sequence: Auto Flash → Flash On → Flash Off.

- None** Auto Flash Camera automatically decides whether or not to fire the flash in accordance with exposure conditions.
- Flash On Flash is always fired, regardless of exposure conditions.
- Flash Off Flash is not fired, regardless of exposure conditions.

Important!

- When aiming the camera, make sure that your fingers do not block the flash or sensor. A block flash or sensor can ruin your picture.
- The flash should be used when recording images from a distance from about 0.7 meters (2.3') to about 3 meters (9.8'). Recording an object outside of this range may not produce desired results.
- Depending on current conditions, recharging can take anywhere from a few seconds to as long as about 10 seconds.
- The flash does not fire when you shoot a sequential series of images. appears on the monitor screen to indicate that the flash will not fire.
- The flash unit may not be able to recharge when camera battery power is low. This condition is indicated by flashing red on the monitor screen. Be sure to replace batteries as soon as possible in order to prevent improper exposure due to improper firing of the flash.

41

Repeat Recording

You can use any of the three following methods to record a consecutive series of images.

- Shutter Button (CONT.S)
Images are continuously recorded (at intervals of about one second) as long as you keep the shutter button pressed.
- TIME Recording (Past)
With TIME Recording (Past), the camera constantly records images, even when the shutter button is not pressed. Pressing the shutter button produces a series of four images that include the image when the shutter button is pressed, and three images 0.05, 0.1, and 0.15 seconds before the shutter button is pressed.
- TIME Recording (Future)
With this method, the camera records a series of four shots based at intervals of about 0.05 second.

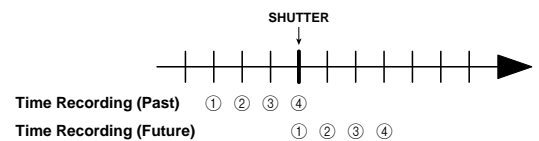

Important!

- The flash cannot be used in combination with repeat recording, regardless of the method you use.
- The ability to repeat record depends on the amount of unused capacity available on your memory card.
- After performing a TIME Recording (Past) or TIME Recording (Future) operation, the monitor screen shows the third image that was recorded.

42

To record a consecutive series of images

1. Slide the function switch to the REC position.
2. Align the dial with to select repeat recording.
 - Pressing the shutter button here, performs repeat recording using the last method you previously selected.
3. Press MENU.
4. Use [+] and [-] to select the repeat method you want to use, and then press the shutter button.
5. Point the camera at the subject and press the shutter button.
 - If you are using the shutter button for repeat recording, keep it held down long enough to record the number of images you want.

43

Using the Self-timer

You can use the self-timer to perform any of the following recording operations.

- One shot after 10 seconds
Use this method when you want to include yourself in the photograph.
- One shot after two seconds
Use this method when you want to eliminate the effects of camera movement caused when the shutter button is pressed.
- Four shots after 10 seconds
Use this method when you want to record a series of images, from which you can select the best one.

Important!

The flash cannot be used in combination with four shots after 10 seconds self-timer recording.

To record using the self-timer

1. Slide the function switch to the REC position.
2. Align the dial with to select self-timer recording.
 - Pressing the shutter button here, performs self-timer recording using the last method you previously selected.
3. Press MENU.



44

4. Use [+] and [-] to select the type of self-timer recording you want to perform, and then press the shutter button.
5. Point the camera at the subject and press the shutter button.

Note

During self-timer recording, you may find it helpful to rotate the swivel lens mechanism 180 degrees so the monitor screen faces the same direction as the lens. This way you can always see how much time is left until the start time is reached and recording begins.

Using the Timer

You can use the timer to perform any one of the following operations.

- Interval Recording
Use this method to record a series of images at fixed time intervals.
- Timer Recording
Use this method to record a single image after passage of a fixed amount of time.
- Interval Timer Recording
Use this method to record a series of images at fixed time intervals, starting after passage of a fixed amount of time.

45

To record using timer recording

1. Mount the camera onto a tripod.
2. Slide the function switch to the REC position.
3. Align the dial with  to select timer recording.
 - Pressing the shutter button here, performs timer recording using the last method you previously selected.
4. Press MENU.



5. Use [+] and [-] to select the number of shots you want to record, and then press the shutter button.
 - If you select 1, jump skip step 6 and jump directly to step 7.
6. Use [+] and [-] to select the interval between shots, and then press the shutter button.
 - You can specify an interval of from 1 to 60 minutes, in 1-minute steps.
7. Use [+] and [-] to select the start time of the record operation, and then press the shutter button.
 - You can specify any amount of time up to 24 hours from the present.

46

8. Point the camera at the subject and press the shutter button.

- When the start time you set is reached, the charge lamp lights and image recording starts.
- Following exposure correction (page 37), the corrected exposure value is applied to the first image recorded only. The exposure automatically returns to its initial default setting of zero for subsequent images.

Turning on Power During Timer Operation

The display shown below appears on the monitor screen whenever you turn on camera power while a timer operation is in progress, and the timer operation is automatically cancelled.

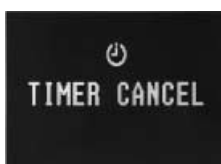

47

Using Panorama Recording

You can link multiple images together on your personal computer to create an exciting panoramic effect. Use the following procedure to record images to be used to create a panorama.

To record a panorama

1. Slide the function switch to the REC position.
2. Align the dial with  to select panorama recording.
 - Pressing the shutter button here, performs panorama recording using the last method you previously selected.
3. Press MENU.



4. Use [+] and [-] to select either HORIZONTAL or VERTICAL.
 - If you select VERTICAL, you should position the camera as shown in the illustration when shooting the image.

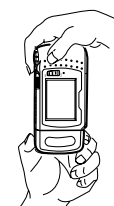

5. Point the camera at the subject and press the shutter button.
 - The previous image you recorded remains on the monitor screen, so you can use it to correctly compose the next image.

48

Manual Recording

With manual recording, you can set the aperture and white balance manually to produce exactly the effect you want.

To record an image manually

1. Slide the function switch to the REC position.
2. Align the dial to  for normal recording.
3. Press MENU.



- APT (Aperture Priority)
You can specify AUTO, F2, or F8 for this setting. F8 provides the widest photographic range.
- WB (White Balance)
AUTO : Automatic
WB1 : Corrects for reddish tint under incandescent lighting
WB2 : Corrects for reddish tint under fluorescent lighting
WB3 : Outdoors

49

4. Use [+] and [-] to select the APT (Aperture Priority) setting you want, and then press the shutter button.
5. Use [+] and [-] to select the WB (White Balance) setting you want, and press the shutter button.
 - The setting you make here remains in effect until you turn off camera power.
6. After you are finished making the setting, press MENU.
 - The letter "M" appears in the upper left of the monitor screen.
7. Compose the image on the monitor screen and press the shutter button.
 - To return to the camera to its standard settings, turn it off.

50

Playing Back Images

This section describes how to recall and view images stored in camera memory.

Displaying Images on the Camera's LCD

The following procedure describes how to display images on the camera's built-in LCD.

1. Enter the Playback Mode and turn on the camera.

- Slide the function switch to the PLAY position.

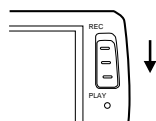

2. Scroll through the memory pages until the image you want to view is displayed.

- Press [+] to display the next memory page or [-] to display the previous memory page.
- To jump to the first (lowest numbered) image in memory, press the shutter button and [-] button at the same time.
- Holding down [+] or [-] starts high-speed scrolling of images.



Notes

- If you set the function switch to PLAY after recording an image, that image appears on the LCD first.
- The message "NO IMAGE" appears on the LCD if there are no images stored in folder when you enter the Playback Mode.

51

Playback Mode Displays

Use the following procedure to display various parameters about an image.

1. Enter the Playback Mode.

- Set the function switch to the PLAY position.

2. Press the DISP button.

- Each press of DISP cycles the contents of the display in the following sequence : page→date and time→page/date and time.

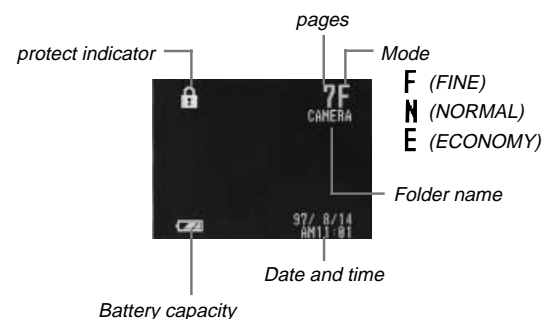

52

Producing a Multi-Page Display

Four or nine memory pages can be displayed at the same time. This feature can be used to display multiple memory pages on the camera's built-in LCD, or on the screen of a connected TV.

Multi-Page Display

1. Slide the function switch to the PLAY position.

2. Press the MENU button.

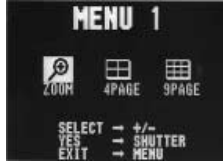

3. Specify the screen size.

- Use the [+] and [-] buttons to select 4PAGE or 9PAGE.

4. Press the shutter button.

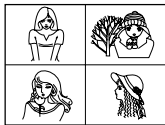

5. Scroll through the images.

- Use the [+] and [-] buttons to scroll images forward and back. Each press shows a new screen of four or nine new images.



- To clear the multi-page display and return to the normal single-page display, press any button besides [+], [-] or DISP button.

When using the multi-page display, the brightness of the camera's monitor screen and the screen of the connected TV is somewhat different from the brightness of a single-image display. This is due to operation of the camera's AGC(Auto Gain Control) function, which automatically adjusts the brightness of the screen in accordance with the brightest of the images that make up the multi-image display.

Selecting a Memory Page in a Multi-Page Display

You can use the following procedure to select one of the memory pages in a multi-page display. Then when you return to the 1-page display, the memory page you selected will be the one displayed. The following procedure uses the 4-page display as an example, but you can use the same procedure with the 9-page display.

1. While a multi-page display (either 4-page or 9-page) is on the screen, press the DISP button.

- This displays the image number on the upper left image.

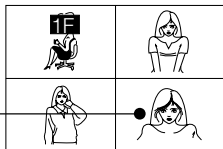

In this example, we will select this page.

2. Display the image number of the images you want to select.

- Use the [+] and [-] buttons to change the image number selection.

3. Press the shutter button.

- The selected image appears on a single-page display.



Using the Zoom Function

This function lets you select a specific part of a stored image and enlarge it to twice its normal size.

1. Slide the function switch to the PLAY position.

2. Press the MENU button.



3. Use [+] and [-] to select "ZOOM".

4. Press the shutter button.

- At this time the image is doubled in size. The portion that appears on the screen is the center of the image.



5. Scroll the image on the screen.

- Use [+] and [-] to scroll as shown in the illustration below.

6. To clear the zoomed display and return to the normal size display, press any button besides [+], [-], or DISP.

Changing the Location of the Zoom Area

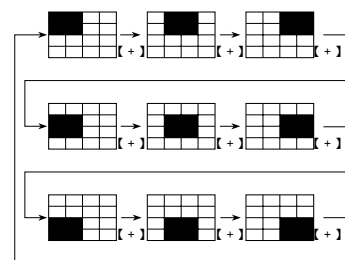

- Pressing [-] moves the zoom area in the opposite direction.

Notes

- If the page number is displayed in the upper right corner of the screen when you perform a zoom operation, the number is replaced by a zoom area indicator (). This indicator shows you what part of the image is currently enlarged on the display. You can turn the zoom area indicator on and off by pressing the DISP button.
- Note that turning display of the zoom area indicator on and off also affects the playback image data display (page 52) and the record mode image data display (page 39).

Superimposing a Title on an Image

With this camera you can record a title and then superimpose the title onto another image. Note that you have to prepare a paper copy of your title before performing the following procedure.

To record the title

- 1. Slide the function switch to the REC position.**
- 2. Align the Dial with  to select TITLE.**
 - You can use [+] and [-] to perform exposure compensation (page 37).
- 3. Align the frame with the title you want to record and press the shutter button.**
- 4. Use [+] and [-] to adjust brightness within a range of ±30 levels.**



5. Press the shutter button.

- The title is recorded at the brightness level you specified in step 4.

Important!

Recording a title causes anything that was previously recorded to be deleted.

Note

The title can be inserted in the area defined by the outer line of the frame.

To superimpose a title on an image

Important!

- You cannot superimpose a title on the image while memory is full (indicated by the "Memory Full" message).
- You cannot superimpose a title on a rotated image (page 61).
- The recording date of an image remains as that when the image was recorded, even if you superimpose a title on the image.

- 1. Slide the Function switch to the PLAY position.**
- 2. Use the [+] and [-] buttons to scroll through the images in memory until the one you want to superimpose a title onto is on the monitor screen.**

3. Press the MENU button.



4. Use the [+] and [-] buttons to select the "TITLE" item and press the shutter button.

- TITLE is located in MENU 2.



5. Use the [+] and [-] buttons to select the color of the title.

- Each press of [+] cycles forward through the colors, while [-] cycles back.
- There are 10 title color patterns and 10 highlight patterns.

6. Press the shutter button to register the selected color.

7. Use the [+] and [-] buttons to select a plate for the title.

- Each press of [+] cycles forward through the plates, while [-] cycles back.
- There are 7 plates and No Plate.



8. Press the shutter button to register the selected plate.

- If you selected "No Plate" in step 7, skip to step 11 here. Otherwise, proceed with step 9.

9. Use the [+] and [-] buttons to select the color of the plate.

- Each press of [+] cycles forward through the plate colors, while [-] cycles back.
- There are 12 plate color patterns.



10. Press the shutter button to register the selected color.

11. Use the [+] and [-] buttons to specify the location of the title.

- Each press of [+] cycles forward through the locations of the titles, while [-] cycles back.
- There are 5 locations.

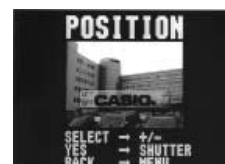



12. Press the shutter button to register the selected position.

- The image with the superimposed title is stored in the memory page immediately following the memory page where the original image is stored. All images in the following memory pages are shifted to make room.

Rotating an Image

Use the following procedure to rotate an image in 90° increments.

To rotate an image

- Slide the function switch to the **PLAY** position.
- Use the **[+]** and **[-]** buttons to scroll through the images in memory until the one you want to rotate is on the monitor screen.
- Press the **MENU** button.
 
- Use the **[+]** and **[-]** buttons to select the **"ROTATE"** item.
 - ROTATE is located in MENU 3.
- Press the shutter button.
 
- Use the **[+]** and **[-]** buttons to select the rotation angle.
 - If you selected a rotation angle of 0° or 180°, skip to step 8 here. Otherwise, proceed with step 7.

61

7. Use the MENU button to select the background color.

- Each press of **[+]** cycles forward through the background colors, while **[-]** cycles back.
- There are 10 background colors.

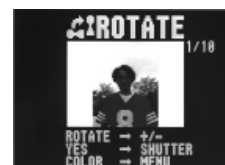

8. Press the shutter button to complete the rotation operation.

Important!

The rotation operation affects the displayed image only. It does not actually change the data stored in camera memory. Because of this the image retains its normal, non-rotated orientation when you print it or transfer it to a personal computer.

Filtering an Image

Images can be filtered to produce a variety of special effects.

Important!

- You cannot filter an image while memory is full (indicated by the "Memory Full" message).
- You cannot filter on a rotated image (page 61).

To filter an image

- Slide the function switch to the **PLAY** position.
- Use the **[+]** and **[-]** buttons to scroll through the images in memory until the one you want to filter is on the monitor screen.

62

3. Press the MENU button.



4. Use the [+] and [-] buttons to select the "FILTER" item.

- FILTER is located in MENU 2.

5. Press the shutter button.



6. Use the [+] and [-] buttons to select the filter type.

- Each press of **[+]** and **[-]** changes to one of the five available filters.

7. Press the shutter button to register the currently selected filter.

- The filtered image is stored in the memory page immediately following the memory page where the original, unfiltered image is stored. All images in the following memory pages are shifted to make room.
- The amount of time the camera needs to filter an image depends on the image's composition and coloring.

63

Mixing Images

Use the following procedure to mix two different images.

Important!

- You cannot mix images while memory is full (indicated by the "Memory Full" message).
- You cannot mix on a rotated image (page 61).

To mix two images

- Slide the function switch to the **PLAY** position.
- Use **[+]** and **[-]** to display the first image.
- Press **MENU**.



4. Use [+] and [-] to select MIX, and then press the shutter button.

- MIX is located in MENU 2.



5. Use [+] and [-] to select the mask pattern you want to use, and then press the shutter button.

- You can select one of 4 different mask patterns.

64

6. Use [+] and [-] to select the locations you want to use, and then press the shutter button.
 - You can move the image vertically and horizontally.
7. Use [+] and [-] to select the background you want to use, and then press the shutter button.
 - If you select the vertical ellipse and small circle, you also need to perform step 8, below.
8. Use [+] and [-] to select the locations for the trimming image, and then press the shutter button.

Using Auto Play

Auto play lets you automatically scroll through the contents of a folder quickly and easily. You can specify the speed of the scroll operation.

Important!

The camera's Auto Power Off function (page 25) does not function while an auto play operation is in progress. If you forget to turn the camera off, there is the danger that auto play will continue until batteries are dead. To avoid this, make sure that you stop the auto play operation and turn the camera off when you finish viewing.

To start the auto play operation

1. Enter the Playback Mode and turn on the camera.

2. Start the auto play operation.

- Hold down the [+] and [-] buttons until the message "AUTO PLAY START" appears.

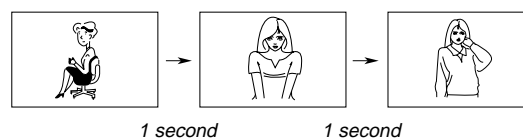

- Auto play continues to loop through the memory pages. This means that when it reaches the last page, it starts again from the first page.

3. Press the shutter button to stop the auto play operation.

- Pressing any button except the MENU button stops the auto play operation.
- Note that the buttons of the camera do not operate while a page change operation is in progress. Make sure that an image is shown on the display when you press a button to stop the auto play operation.

To set auto play speed

Use the following procedure to specify how long each image remains on the display, within the range of 1 to 30 seconds.

1. Perform steps 1 and 3 under "To start the auto play operation" on page 65 to start auto play.
2. Press MENU to enter the Auto Play Setting Mode.
 - Be sure to press MENU while an image is stopped on the monitor, and not while images are changing.



3. Use [+] (increase) and [-] (decrease) to change the current speed setting.
 - You can set the speed within a range of 1 to 30 seconds, in one-second increments.
4. To start auto play using your newly set speed setting, press the shutter button.
 - To exit the auto play setting mode at any time, change the function switch position to REC and then back to PLAY, or turn power off. Either of these methods cancels any settings you made and returns to the settings in effect when you entered the Auto Play Setting Mode.
 - You can use auto play in combination with the multi-page display (page 53) or Zoom function (page 55). First change to the multi-page format, and then perform the auto play operation.
 - The following table shows the minimum number of displayable images (images that are not hidden) that is required in order to use the various display formats with Auto Play.

Display Format	Minimum Number of Images
1-page	2
4-page	5
9-page	10

Using Folders

Folders help you to group your images into any arrangement you like. You can use folders, for example, to keep your personal images separate from images you need for business. There are six folders from which to choose. Any image you record is automatically placed into in the currently selected folder.

Important!

You can store up to 250 images in each folder.

To select a folder using the FOLDER button

1. Each press of FOLDER sequentially selects available folders.
 - Any image you record is automatically placed into the currently selected folder.

To select a folder using the MENU button

1. Slide the function switch to the PLAY position.
2. Press the MENU button.



3. Use [+] and [-] to select FOLDER, and then press the shutter button.

- FOLDER is located in MENU 3.



4. Use [+] and [-] to select SELECT, and then press the shutter button.

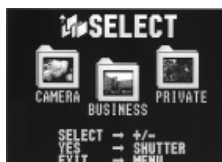

5. Use [+] and [-] to select the folder you want, and then press the shutter button.

To move an image from one folder to another

Important!

Make sure the folder that contains the image you want to move is currently selected before you start the following procedure.

1. Slide the function switch to the PLAY position.
2. Press the MENU button.



3. Use [+] and [-] to select FOLDER, and then press the shutter button.



4. Use [+] and [-] to select MOVE, and then press the shutter button.



5. Use [+] and [-] to select the folder to which you want to move the image, and then press the shutter button.



6. Use [+] and [-] to select the image you want to move, and then press the shutter button.

7. Repeat step 6 to move additional images into the selected folder.

8. After you are finished moving images, press MENU twice to complete the operation.

Image protection

The procedures described here tell you how to protect images against accidental deletion. You can protect a single image, all the images in a particular folder, or all images currently stored on the memory card.

- Note that you cannot protect or unprotect memory pages when protected memory pages are hidden (page 74).

To protect a single image

1. Slide the function switch to the PLAY position.
2. Press / button.



3. Use [+] and [-] to select PAGE, and then press the shutter button.



4. Use [+] and [-] to select the image you want to protect.

5. Press the shutter button.

- This causes the indicator to appear to indicate that it is protected.

6. Repeat steps 4 and 5 if you want to protect more images.

7. When you are finished, press the / button again to close the PROTECT PAGE menu.

- The PROTECT PAGE menu also closes automatically if you do not perform any operation for about 20 seconds.

To protect all images in a folder or all images on the memory card

1. Slide the function switch to the PLAY position.
2. Press / button.



3. Use [+] and [-] to select FOLDER (to protect all images in a particular folder) or ALL (to protect all images on the memory card), and then press the shutter button.

- If you selected FOLDER in the above step, use [+] and [-] to select the folder whose images you want to protect.







4. Use [+] and [-] to select ALL, and then press the shutter button.

- Now when the playback mode displays are turned on, the  indicator is shown in the upper left of all images that are protected.



Unprotecting Images

You can unprotect a single image, all the images in a particular folder, or all images currently stored on the memory card.

To unprotect a single image

- 1. Press  /  button.**
- 2. Use [+] and [-] to select PAGE, and then press the shutter button.**
 - This causes the PROTECT PAGE menu to appear.
- 3. Use [+] and [-] to select the image you want to unprotect.**
- 4. Press the shutter button.**
 - This causes the  indicator to disappear to indicate that it is no longer protected.
- 5. Repeat steps 3 and 4 if you want to unprotect more images.**
- 6. When you are finished, press the  /  button again to close the PROTECT PAGE menu.**
 - The PROTECT PAGE menu also closes automatically if you do not perform any operation for about 20 seconds.

To unprotect all images in a folder or all images on the memory card

- 1. Press  /  button.**
- 2. Use [+] and [-] to select FOLDER (to unprotect all images in a particular folder) or ALL (to unprotect all images on the memory card), and then press the shutter button.**
 - If you selected FOLDER in the above step, use [+] and [-] to select the folder whose images you want to unprotect.
- 3. Use [+] and [-] to select CANCEL, and then press the shutter button.**
 - Now when the playback mode displays are turned on, the  indicator to disappear to indicate that it is no longer protected.

Hiding Protected Memory Pages

This function makes it possible for you to hide protected memory pages so their images do not appear on the monitor during playback.

To hide protected memory pages

While holding down the [+] button, turn on the camera.

Important!

You cannot protect or unprotect pages (pages 73~74) while protected pages are hidden.

To unhide protected memory pages

While holding down the [-] button, turn on the camera.

Deleting Memory Pages

Use the procedures described in this section to delete images. You can delete a single image, all the images in a particular folder, or all images currently stored on the memory card.

Warning!

The delete operation cannot be undone!

Before performing any of the procedures described in this section, make sure that you really do not need the images recorded on the memory pages you are deleting. Be especially careful when you are using the all delete operation.

Deleting Images

Note that you cannot delete images if they are protected. See page 73 for details on how to unprotect images.

To delete a single image

Important!

Note that you must select the folder where the image is located to delete it. See page 68 for details on how to change the folder.

- 1. Select the Playback Mode and turn on power.**
 - Slide the function switch to the PLAY position.
 - Slide the POWER switch in the direction indicated by the arrow.
- 2. Display the DELETE Menu.**
 - Press the DEL button to display the DELETE Menu.



- 3. Select "PAGE".**
 - Use [+] and [-] to select "PAGE".
- 4. Press the shutter button.**
- 5. Use [+] and [-] to display the image you want to delete.**
 - Any images that are protected (page 71) do not appear on the screen during this operation.
- 6. Double check to make sure that you really want to delete the image that is on the screen.**
 - To abort the delete operation without deleting anything, press any button other than [+], [-], or the shutter button.
- 7. Press the shutter button to delete the page.**
 - After you delete an image, the image on the next page appears on the screen.
- 8. To delete more images, repeat steps 5 through 7.**
 - After you finish deleting all the images you want, press any button other than [+], [-], or the shutter button to clear the image delete screen.



Note

Deleting a page causes the remaining pages to be renumbered. Blank pages are not left inserted between non-blank pages.

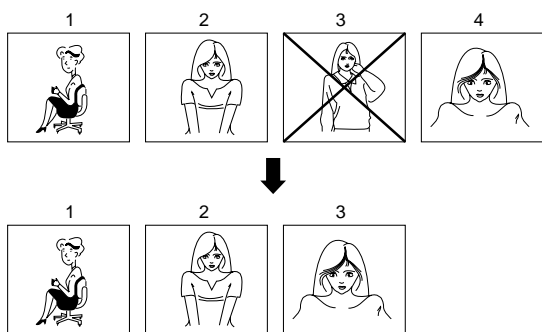

Deleting All the Images in a Folder

Use the following procedure to delete all the images in a particular folder. Note that any images in the folder that are protected against deletion are not deleted by this procedure.

To delete all images in a folder

1. Slide the function switch to the PLAY position.
2. Press DEL.



3. Use [+] and [-] to select FOLDER, and then press the shutter button.



4. Use [+] and [-] to select the folder whose images you want to delete, and then press the shutter button.



5. To abort the delete operation without deleting anything, select EXIT.

6. Use [+] and [-] to select ALL, and then press the shutter button.

Resolution Conversion

You can convert FINE Mode images to NORMAL Mode images, and NORMAL Mode images to ECONOMY Mode images.

- Note that converting an image automatically deletes the original version.

1. Select the Playback Mode and turn on power.

- Slide the function switch to the PLAY position.
- Slide the POWER switch in the direction indicated by the arrow.

2. Display the CONVERT Menu.

- Press the F > N > E button to display the CONVERT Menu.



3. Display the image you want to convert.

- Use [+] and [-] to scroll through the images.
- Any images that are protected (page 71) do not appear on the screen during this operation.

4. Press the shutter button to start the conversion.

5. After the conversion is complete, you can repeat steps 3 and 4 to convert more images.

- After you are finished converting images, press any button besides [+], [-], or the shutter button to clear the conversion screen.

To delete all images on the memory card

1. Enter the Playback Mode.

- Slide the function switch to the PLAY position.

2. Display the DELETED Menu.

- Press the DEL button to display the DELETED Menu.



3. Select "ALL".

- Use [+] and [-] to select "ALL" and press the shutter button.

4. Select "ALL".

- Use [+] and [-] to select "ALL".
- To clear the selection screen and quit this procedure, select the EXIT icon.



5. Press the shutter button to delete all images on the memory card.

- After all images are deleted, the message "NO IMAGE" appears on the screen.

Connecting to Other Devices

The camera terminals

The following describes which the camera terminal you should use for each type of connection.

VIDEO OUT – Use this terminal when connecting to the VIDEO IN terminal of a TV, video tape deck, video printer, or other similar devices. Use the special video cable that comes with the camera for such connections.

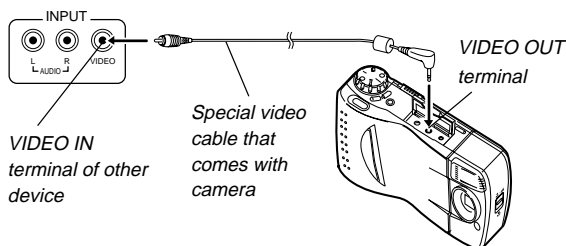

DIGITAL – Use this terminal to connect to a personal computer (requires optional Connection Kit), another CASIO Digital Camera, or a QV Color Printer. The illustration below shows how to connect to another digital camera.

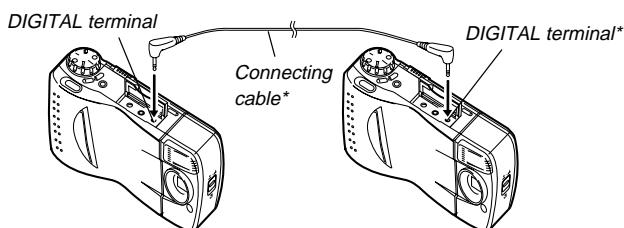

* The type of connecting cable you should use depends on the type and shape of the terminals equipped on the digital camera you are connecting to. See pages 81 through 88 for details.

81

Using the Camera with a Connected Device

The following section provides specific information on how you can use the camera after connecting to various types of devices. In each case, the camera terminal you should connect to is indicated in the title as VIDEO and DIGITAL.

Important!

- Make sure that the power of all devices is turned off before connecting them.
- You should also check the owner's manuals of the device you are connecting to the camera for precautions and other information.

Television VIDEO

Use the special video cable that comes with the camera to connect it to a television, and you can then view the images stored in camera memory on the TV's screen.

Important!

- The camera can be connected only to a TV that is equipped with a VIDEO IN terminal.
- Make sure that the power of both the camera and the TV are turned off when making connections.
- The signal output through this camera's VIDEO OUT terminal is an NTSC signal. An image output through this terminal will not look normal if the camera is connected to a PAL or other type of TV or video deck.
- Leaving the same image displayed on a TV or computer CRT screen for very long periods can cause that image to "burn in", leaving a ghost of the image even after the original image is cleared. Be sure not to leave an image on a TV or CRT screen for long periods.

82

Using the Camera with a Connected Device

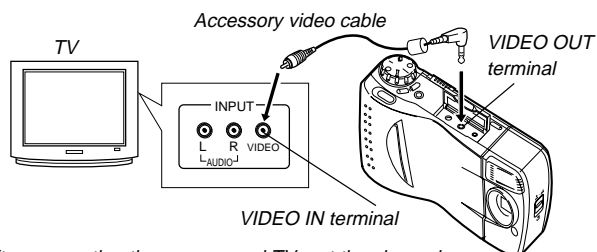

After connecting the camera and TV, set the channel of the TV to the channel used for video input.

After connecting the camera and TV, use the same procedures as those described under "Displaying Images on the Camera's LCD" on page 51.

Video Tape Deck VIDEO

You can use the video tape deck to record images from the camera.

To record camera images on video tape

1. Use the special video cable that comes with the camera to connect to the VIDEO IN terminal of the video tape deck.
 2. Set up the video tape deck to record images input through its VIDEO IN terminal.
- Consult the owner's guide that comes with the tape deck for details about how to set up for recording.
3. Enter the camera Playback Mode and start the video deck record operation.
- It is probably best to use auto play when recording camera images to video tape, because it changes pages automatically at a preset speed.

83

Using the Camera with a Connected Device

Indicators or symbols (page 39) are also recorded on the video tape if they are turned on. Be sure to turn off display of remaining pages if you do not want them in the taped images.

If the low battery indicator (page 25) is displayed while you are recording to video tape, it will also be recorded with the image. If this happens, either replace batteries or use the AC adaptor.

Video Printer VIDEO

You can use Video Printer to print copies of images in camera memory.

To print camera images on a Video Printer

1. Use the special video cable that comes with the camera to connect to the VIDEO IN terminal of the video printer.
 2. Set up the video printer to print images input through its VIDEO IN terminal.
- Consult the owner's guide that comes with the video printer for details about how to set up for printing.
3. Enter the camera Playback Mode and display the image you want to print.
 4. Start the video printer's print operation.
- Indicators or symbols (page 39) are also included on the print if they are turned on. Be sure to turn off display of remaining pages if you do not want them in the print.
 - If the low battery indicator (page 25) is displayed while you are printing, it will also be printed with the image. If this happens, either replace batteries or use the AC adaptor.

84

Connecting to another CASIO Digital Camera

DIGITAL

You can connect the camera to another CASIO digital camera and exchange image data between them. Connect the DIGITAL terminals of the two cameras using the optionally available SB-62 connecting cable.

To connect the two cameras

1. Turn both cameras off.
2. Connect the two cameras by plugging the optional SB-62 connection cable into their DIGITAL terminals.
3. Turn both cameras on.

To send data from this camera to another camera

1. Set the function switches of both cameras to PLAY.
 2. Use the [+] and [-] buttons of this camera to find the image you want to send.
- You cannot send images between two cameras while either of their function switches is set to REC.
 - You cannot send images while using the multi-page display or zoom function.
3. Press the shutter button of this camera.



Send icon

4. Use the [+] and [-] buttons to move the pointer to the send icon.
 5. After you make the setting you want, press the shutter button again.
- Pressing the shutter button sends the selected image to the other camera.
 - You can send only one image at a time. To send more images, repeat steps 2 through 5.

To receive data to this camera from another camera

1. Set the function switches of both cameras to PLAY.
 2. Use the [+] and [-] buttons of other camera to find the image you want to receive.
- You cannot receive images between two cameras while either of their function switches is set to REC.
 - You cannot receive multi-page display or zoomed images.
 - If you try to receive a multi-page display or zoomed images, other camera's monitor automatically changes to normal display of page 1.
3. Press the shutter button of this camera.



Receive icon

4. Use the [+] and [-] buttons to move the pointer to the receive icon.
- As soon as you perform the above step, all of the buttons and controls on the other camera become disabled.
5. After you make the setting you want, press the shutter button again.
- Pressing the shutter button receives the selected image from the other camera.

* You can receive only one image at a time. To send more images, repeat steps 2 through 5.

Important!

- Never disconnect the cable, turn power off, or change the function switch setting while a data communication operation is in progress. Doing so can damage the camera.
- When the QV-700 is connected to another model camera, be sure to perform all operations on the QV-700.
- Make sure that both cameras are set up to display images using the 1-Page display.

How data transfer affects resolution

- QV-700 → QV-100/QV-120/QV-200/QV-300 FINE
- QV-700 ← QV-100/QV-120/QV-200/QV-300 NORMAL ← FINE
QUARTER ← NORMAL
- QV-700 → QV-10/QV-10A/QV-11/QV-30/QV-70 ... NORMAL
- QV-700 ← QV-10/QV-10A/QV-11/QV-30/QV-70 ... QUARTER ← NORMAL

Connecting to a QV Color Printer DIGITAL

You can connect this camera to a CASIO QV Color Printer and print out images that are in camera memory. Use the communication cable that comes with the printer to connect the camera's DIGITAL terminal to the printer's terminal.

Applicable printer models: CASIO QG-100, DP-8000, DP-300

- After connecting to a printer, slide the function switch to the PLAY position. See the documentation that comes with the printer you are using for details on its operation.

Important!

Image numbers greater than 200 may not appear correctly on the monitor screen of the camera when you are selecting images for printing on a connecting DP-8000 QV Printer. Because of this, you should always look at the image itself (rather than just the image number) to confirm that it is the one you want, before actually starting the printing operation.

Using QV-Link Software and a Connection Cable

The optionally available QV-Link Software and connection cable lets you transfer images from your digital camera to a personal computer. The following are the models of QV-Link software that support this camera.

Windows Version: LK-11

Macintosh Version: LK-21

Important!

This camera does not fully support the software that comes with the LK-1, LK-1A, LK-10V connection kits for Windows, and the LK-2, LK-2A, LK-2V connection kits for the Macintosh. Never try to use the software that comes with these connections kits with this digital camera.

Computer (Video Capture) VIDEO

You can use the special video cable that comes with the camera to connect directly to the VIDEO IN terminal of a personal computer equipped with video capture capabilities.

To transfer camera images to a personal computer (video capture)

1. Use the special video cable that comes with the camera to connect to the VIDEO IN terminal of the computer.
 2. Enter the camera Playback Mode and display the image you want to send.
 3. Perform the required operation on the computer.
- Consult the owner's guide that comes with the computer or its video capture board for details about how to set up to capture images.

Important!

- With this configuration, you cannot send images from the personal computer to the camera.
- The camera can be connected directly to a personal computer or video capture board that is equipped with a VIDEO IN terminal (RCA pin jack). It cannot be connected directly to an S-VIDEO terminal.

Accessing Memory Card Contents with Your Computer

You can use any of the three methods described below to access the contents of a memory card with your computer.

Important!

QV-LINK software is required to use your computer to view images stored on a memory card.

Memory Card Slot

If your computer has a memory card slot, insert the camera's memory card into the slot.

PC Card Slot

In this case you need an optionally available CASIO CA-10 PC Card Adaptor. See the instructions that come with the PC Card Adaptor and the documentation that comes with your computer for details on using this type of configuration.

Other Desktop Computer Configurations

Some desktop computers require a separately available PC card reader/writer and the optionally available CASIO CA-10 PC Card Adaptor to read memory card contents. See the instructions that come with the PC card reader/writer and the PC Card Adaptor for details on using this type of configuration.

Troubleshooting

	Symptom	Probable Cause	Action
Power Supply	No power	1. Batteries not loaded correctly. 2. Dead batteries 3. Wrong AC adaptor 4. Open memory card slot cover	1. Correctly load batteries (page 22). 2. Replace batteries with new ones (page 22). 3. Use only recommended AC adaptor. 4. Securely close memory card slot cover.
	Sudden power failure	1. Operation of Auto Power Off 2. Low battery power 3. Use of manganese batteries.	1. Turn power back on. 2. Replace batteries with new ones (page 22). 3. Replace manganese batteries with alkaline batteries.
	 indicator on LCD	Batteries are about to go dead.	Replace all four batteries with a set of new ones (page 22).
Recording	No recording when shutter button is pressed	1. Function switch sets to PLAY. 2. Insufficient memory card capacity or no memory card loaded in camera	1. Set function switch to REC. 2. Load a memory card
	Power failure during self-timer operation	Low battery power	Replace batteries (page 22).

Reference

	Symptom	Probable Cause	Action
Recording	Poor LCD image focus	Incorrect NORMAL/MACRO switch setting	Use NORMAL for scenery and group photos, and MACRO for close-ups (page 36).
	Poor color and brightness when indoors	Indoor fluorescent lighting	Shoot under incandescent or other non-fluorescent lighting (page 33).
Playback	Color of recorded image is strange.	Reflection from sunlight or light from another source	Reorient the camera so that light is not shining directly into lens.
	No +/- button operation during multi-page display	Button operation during page change	Wait until an image is on the LCD before performing a button operation.
	All pages do not appear during auto play.	1. Protected memory pages are hidden. 2. Images are in a different folder.	1. Unhide protected memory pages (page 74). 2. Correctly select folder that contains images.

Troubleshooting

	Symptom	Probable Cause	Action
Playback	Camera is connected to a TV, but LCD monitor contents do not appear on TV screen.	1. Incorrect camera-TV connection 2. Wrong TV set up	1. Connect correctly using the special video cable that comes with the camera (page 83). 2. Set up the TV correctly.
	Some images are missing.	1. Protected memory pages are hidden. 2. No images in selected folder	1. Unhide protected memory pages by holding down [-] while turning power on (page 74). 2. Check other folders for images
	Cannot use multi-page display.	No images in selected folder	Check other folders for images
	Cannot protect memory pages.	Protected memory pages are hidden.	Unhide protected memory pages by holding down [-] while turning power on (page 74).
	ALL DATA IS PROTECTED stays on monitor and images do not appear.	Protected memory pages are hidden.	Unhide protected memory pages by holding down [-] while turning power on (page 74).

93

Reference

	Symptom	Probable Cause	Action
Deletion	Delete operation does not start when DEL is pressed.	1. All pages are protected. 2. Multi-page display (page 53) or zoom display (page 55)	1. Unprotect the page you want to delete (page 73). 2. Change to a normal-size, 1-page display format.
	All buttons and switches do not operate.	Malfunction due to static electrical charge or strong impact. Camera is connected to a computer or QV Color Printer.	Remove batteries and disconnect the AC adaptor if you are using one. Restore power and turn the camera on. If this does not work, contact your dealer or an authorized CASIO service provider.
Other	Very bright or very dark LCD image.	Wrong BRIGHT setting	Adjust the BRIGHT setting (page 13).
	Cannot exchange data between two cameras	1. Incorrect cable connection 2. Camera connected to is not turned on. 3. Function switch sets to REC.	1. Connect correctly (page 81). 2. Turn power on after connecting cable. 3. Set function switch to PLAY (page 51).

94

Troubleshooting

	Symptom	Probable Cause	Action
Other	Pressing F ▶ N ▶ E does not change the CONVERT Menu.	There are no convertible images in memory.	
	Cannot transfer data (error keeps occurring)	1. Sending camera's memory is empty. 2. Receiving camera's memory is full 3. Receiving camera's function switch is in REC position. 4. The message "ALL DATA IS PROTECTED" is on the monitor of the sending camera. 5. Low battery (indicated by ) 6. Disconnection of cable during data communication	1. Correct the situation and try again. 2. Correct the situation and try again. 3. Change function switch setting of receiving camera to PLAY (page 51). 4. The sending camera's protected memory pages are hidden. Unhide protected memory pages by holding down [-] while turning power on (page 74). 5. Replace batteries or use the AC adaptor (page 22). 6. Securely reconnect the cable.
	Keys of connected camera are disabled.	Connected camera operation is disabled during data communications.	Normal operation will return when you exit data communications by pressing EXIT.

95

Error Messages

ALL DATA IS PROTECTED	Camera is set up to hide protected images, and all images are protected. When a folder name is displayed, all images in folder are protected.
ERROR	Error during data communication. Check cable connections and mode settings.
CF CF ERROR FORMAT → MENU	<p>Perform the following procedure whenever a memory card starts to behave abnormally.</p> <p>Important! The procedure described below deletes all images stored in the memory card. Make sure all of your important images are backed up onto a computer hard disk or other storage medium before performing this procedure.</p> <p>To reformat a memory card</p> <ol style="list-style-type: none"> Connect the AC adaptor to the camera and switch to AC power or load a new set of alkaline or lithium batteries into the camera. <ul style="list-style-type: none"> Power failure while a format operation is being performed aborts the reformat operation. Press MENU. <div data-bbox="1332 1702 1492 1937" data-label="Image"> </div> Use [+] and [-] to select FORMAT, and then press the shutter button. <ul style="list-style-type: none"> Select EXIT if you want to abort the reformat procedure without deleting anything. Press the shutter button to start the memory card format operation. <ul style="list-style-type: none"> To interrupt a format operation part way through, turn off camera power. Completion of the format operation is indicated by the message "NO IMAGE" appearing on the monitor screen. This message also indicates that the memory card was formatted successfully.

96

Error Messages

SYSTEM ERROR CALL TECH SUPPORT	Problem with internal memory. Contact your dealer or an authorized CASIO service provider.
REMAINING	Not enough memory for recording in current resolution mode. Press F ▶ N ▶ E to change to another resolution mode, delete some images from memory, or change resolution of stored images from FINE to NORMAL or NORMAL to ECONOMY.
MEMORY FULL	Not enough memory for further recording. Delete some images from memory or change resolution of stored images from FINE to NORMAL or NORMAL to ECONOMY. When a folder name is displayed, this message indicates folder is full.
FULL	Folder is full. Note that each folder can contain up to 250 images.
NO IMAGE	No images are stored in memory. When a folder name is displayed, this message indicates there are no images in the folder.

97

Specifications

Recording System	Digital (JPEG base)
Signal System	NTSC
Recording Medium	Memory card (2MB card included)
Memory Capacity (2MB Card)	
FINE	Approximately 14 images (Approximately 133KB compressed)
NORMAL	Approximately 26 images (Approximately 70KB compressed)
ECONOMY	Approximately 47 images (Approximately 38KB compressed)
Image Deletion	Single image; all images in a folder; all images in memory (with image protection)
Imaging Element	1/4-inch CCD (350,000 pixels)
Lens	Fixed focal point with macro position; F2, f = 3.94mm
Focus Range	NORMAL : 0.7m to ∞ (2.3' to ∞) MACRO : 14cm to 16cm (5.5" to 6.3") (From surface of protective lens.)
Light Metering	TTL center priority by CCD
Exposure Metering	Program AE, Aperture Priority AE
Exposure Range	EV +5 to 18
Exposure Correction	-2EV to +2EV
Shutter	CCD shutter
Shutter Speed	1/8 to 1/4000 second
White Balance	Automatic, Fixed
Self-timer	10 seconds, 2 seconds
Flash Modes	Auto Flash, Flash On, Flash Off
Resolution Modes	FINE, NORMAL, ECONOMY
Monitor	2.5" TFT, low-glare color LCD (84,480 pixels)

98

Specifications

Computer Output Image ...	480 x 640 pixels
Input/Output Terminals ...	DIGITAL OUT, VIDEO OUT, AC adaptor connector, memory card connector
Clock	January 1, 1997 00:00:00 to December 31, 2049 11:59:59 (Auto Calendar)
Power Supply	Four batteries (AA-size alkaline or lithium batteries)/AC adaptor (AD-C620)
Power Consumption	Approximately 6.4 W
Battery Life	

The values noted below indicate the number of hours before battery failure under normal operating temperature (25°C), as estimated by battery manufacturers. These values are for reference only, and do not guarantee that any particular set of batteries actually will provide the service life indicated. Low temperatures shorten battery life.

Type of Operation	AA-size Alkaline Batteries LR6	AA-size Lithium Batteries FR6
Continuous Playback	Approximately 160 minutes	Approximately 270 minutes
Continuous Recording	Approximately 550 shots	Approximately 1,050 shots

"Continuous recording" is made without use of the camera's flash. Regardless of use of the camera's flash, turning on and off the power switch, as well as other operating conditions may affect the above values.

Note

The above values are obtained based on Panasonic's alkaline batteries and Fujifilm's lithium batteries.

They may vary if other manufacturer's batteries are used. For your reference, the values when the camera is operated with Duracell's batteries are shown below.

Type of Operation	AA-size alkaline batteries LR6
Auto Play	Approximately 80 minutes
Continuous Recording	Approximately 170 images

99

Reference

Dimensions	147(W) x 69(H) x 50(D) mm / 5.8" (W) x 2.7" (H) x 2.0" (D)
Weight	Approximately 290g / 10.2oz (excluding batteries)
Standard Accessories ..	Memory card; wrist strap; soft case; special video cable; four LR6 alkaline batteries; owner's manual

- The liquid crystal panel built into this camera is the product of precision engineering, with an effective pixel rate of 99.99%. This also means, however that 0.01% of the pixels can be expected to fail to light or to remain lit at all times.

About the camera's backlight...

- The camera is equipped with a fluorescent light source to provide the back lighting for its LCD.
- The normal service life of the backlight is approximately six years, when the camera is used for about two hours a day.
- Should the LCD image appear abnormally dark, take the camera to your dealer or an authorized CASIO service provider to have the light source replaced. Note that you will be charged for this replacement.
- Under very cold conditions, the backlight may require more time than normal to light, or reddish bands may appear in the image. These conditions do not indicate malfunction, and normal operation should return at higher temperatures.

100

Free Manuals Download Website

<http://myh66.com>

<http://usermanuals.us>

<http://www.somanuals.com>

<http://www.4manuals.cc>

<http://www.manual-lib.com>

<http://www.404manual.com>

<http://www.luxmanual.com>

<http://aubethermostatmanual.com>

Golf course search by state

<http://golfingnear.com>

Email search by domain

<http://emailbydomain.com>

Auto manuals search

<http://auto.somanuals.com>

TV manuals search

<http://tv.somanuals.com>