

CTK-2000 CTK-3000

USER'S GUIDE

Please keep all information for future reference.

Safety Precautions

Before trying to use the keyboard, be sure to read the separate "Safety Precautions".

GUÍA DEL USUARIO

Guarde toda información para tener como referencia futura.

Precauciones de seguridad

Antes de intentar usar el teclado, asegúrese de leer las "Precauciones de seguridad" separadas.

ES

English

Español

CTK2000/3000ES1B

CASIO®

NOTICE

This equipment has been tested and found to comply with the limits for a Class B digital device, pursuant to Part 15 of the FCC Rules. These limits are designed to provide reasonable protection against harmful interference in a residential installation. This equipment generates, uses and can radiate radio frequency energy and, if not installed and used in accordance with the instructions, may cause harmful interference to radio communications. However, there is no guarantee that interference will not occur in a particular installation. If this equipment does cause harmful interference to radio or television reception, which can be determined by turning the equipment off and on, the user is encouraged to try to correct the interference by one or more of the following measures:

- Reorient or relocate the receiving antenna.
- Increase the separation between the equipment and receiver.
- Connect the equipment into an outlet on a circuit different from that to which the receiver is connected.
- Consult the dealer or an experienced radio/TV technician for help.

FCC WARNING

Changes or modifications not expressly approved by the party responsible for compliance could void the user's authority to operate the equipment.

Declaration of Conformity

Model Number: CTK-2000/CTK-3000

Trade Name: CASIO COMPUTER CO., LTD.

Responsible party: CASIO AMERICA, INC.

Address: 570 MT. PLEASANT AVENUE, DOVER, NEW JERSEY 07801

Telephone number: 973-361-5400

This device complies with Part 15 of the FCC Rules, Operation is subject to the following two conditions:

(1) This device may not cause harmful interference, and (2) this device must accept any interference received, including interference that may cause undesired operation.

Important!

Please note the following important information before using this product.

- Before using the optional AD-5 Adaptor to power the unit, be sure to check the AC Adaptor for any damage first. Carefully check the power cord for breakage, cuts, exposed wire and other serious damage. Never let children use an AC adaptor that is seriously damaged.
- Never attempt to recharge batteries.
- Do not use rechargeable batteries.
- Never mix old batteries with new ones.
- Use recommended batteries or equivalent types.
- Always make sure that positive (+) and negative (-) poles are facing correctly as indicated near the battery compartment.
- Replace batteries as soon as possible after any sign they are getting weak.
- Do not short-circuit the battery terminals.
- The product is not intended for children under 3 years.
- Use only CASIO AD-5 adaptor.
- The AC adaptor is not a toy.
- Be sure to disconnect the AC adaptor before cleaning the product.



This mark applies in EU countries only.



Manufacturer:
CASIO COMPUTER CO., LTD.
6-2, Hon-machi 1-chome, Shibuya-ku, Tokyo 151-8543, Japan

Responsible within the European Union:
CASIO EUROPE GmbH
Bornbarch 10, 22848 Norderstedt, Germany

- Company and product names used in this manual may be registered trademarks of others.
- Any reproduction of the contents of this manual, either in part or its entirety, is prohibited. Except for your own, personal use, any other use of the contents of this manual without the consent of CASIO is prohibited under copyright laws.
- IN NO EVENT SHALL CASIO BE LIABLE FOR ANY DAMAGES WHATSOEVER (INCLUDING, WITHOUT LIMITATION, DAMAGES FOR LOSS OF PROFITS, BUSINESS INTERRUPTION, LOSS OF INFORMATION) ARISING OUT OF THE USE OF OR INABILITY TO USE THIS MANUAL OR PRODUCT, EVEN IF CASIO HAS BEEN ADVISED OF THE POSSIBILITY OF SUCH DAMAGES.
- The contents of this manual are subject to change without notice.

Contents

General Guide E-2

- Using the 10-key Pad (10) E-4
- Using the Setting Button (S) E-4

Getting Ready to Play E-5

- Preparing the Music Stand E-5
- Power Supply E-5

Playing the Digital Keyboard E-6

- Turning on Power and Playing E-6
- Using Headphones E-6
- Changing Keyboard Response to Touch Pressure (Touch Response) (CTK-3000 only) E-7
- Using the Metronome E-8

Controlling the Keyboard Sounds E-9

- Select from a variety of musical instrument sounds E-9
- Using Reverb E-10
- Using a Pedal E-10
- Changing the Pitch (Transpose, Tuning) E-11
- Using the Pitch Bend Wheel to Shift the Pitch of Notes (CTK-3000 Only) E-11
- Sampling a Sound and Playing It on the Keyboard (Sampling) E-12
- Using a Sampled Sound in a Rhythm (Drum Assign) E-14

Playing Built-in Songs E-15

- Playing the Demo Songs E-15
- Playing Back a Particular Song E-15

Using Built-in Songs to Master Keyboard Play E-19

- Phrases E-19
- Step Up Lesson Flow E-19
- Selecting the Song, Phrase, and Part You Want to Practice E-20
- Lessons 1, 2, and 3 E-21
- Lesson Settings E-22
- Using Auto Step Up Lesson E-23

Music Challenge Keyboard Game E-25

Using Auto Accompaniment E-27

- Playing the Rhythm Part Only E-27
- Playing All Parts E-28
- Using Auto Accompaniment Effectively E-30
- Using One-Touch Preset E-31

Connecting External Devices E-32

- Connecting a Computer E-32
- MIDI Settings E-33
- Connecting to Audio Equipment E-35

Reference E-36

- Troubleshooting E-36
- Specifications E-38
- Operating Precautions E-39
- Song List E-40
- Chord Chart E-41

MIDI Implementation Chart

Included Accessories

- Music Stand
- Song Book
- Leaflets
 - Safety Precautions
 - Appendix
 - Other (Warranty, etc.)

Items included as accessories are subject to change without notice.

Separately Available Accessories









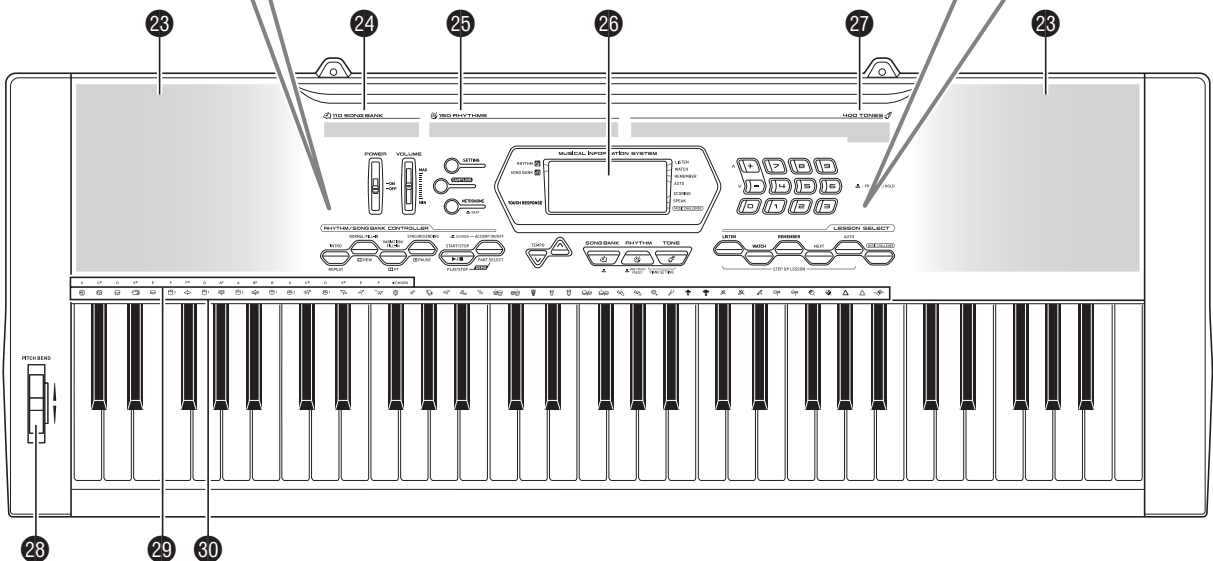
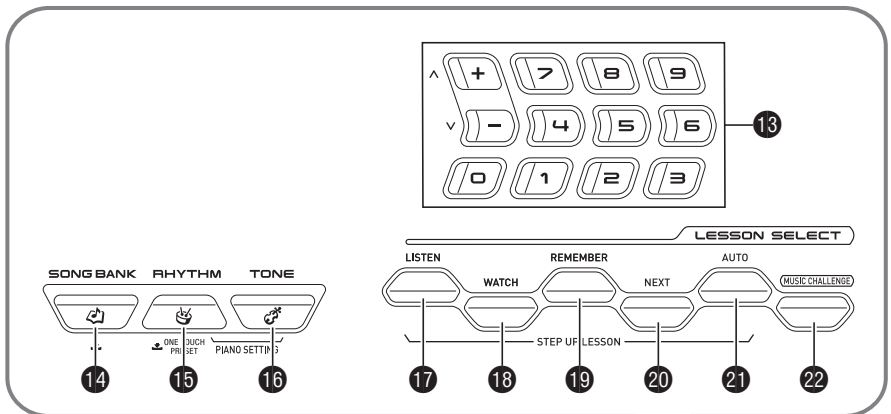
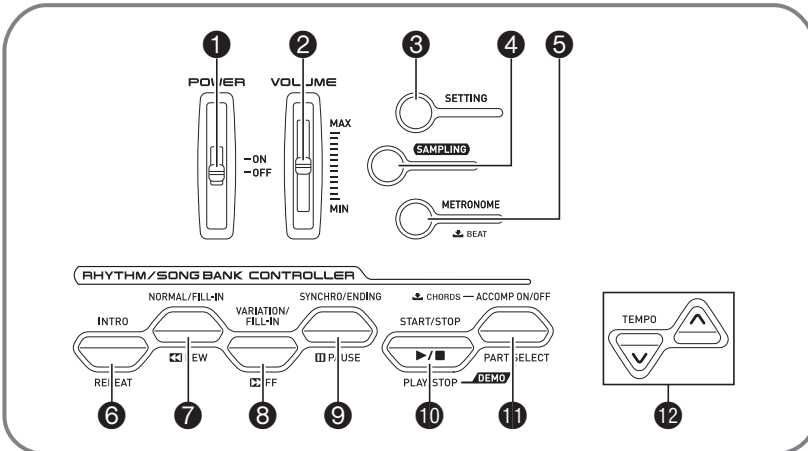





- You can get information about accessories that are separately for this product from the CASIO keyboard catalog available from your retailer, and from the CASIO website at the following URL.











<http://world.casio.com/>

General Guide

- In this manual, the term “Digital Keyboard” refers to the CTK-2000/CTK-3000.
- Illustrations in this User’s Guide show the CTK-3000.
- **In this manual, buttons and other controllers are identified using the numbers shown below.**





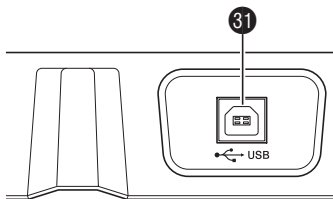

- ❶ **POWER** switch  E-6
- ❷ **VOLUME** slider  E-6
- ❸ **SETTING** button  E-4
- ❹ **SAMPLING** button  E-12
- ❺ **METRONOME** button  E-8
- ❻ **INTRO, REPEAT** button  E-16, 17, 22, 30
- ❼ **NORMAL/FILL-IN, REW** button  E-16, 20, 27, 30
- ❽ **VARIATION/FILL-IN, FF** button  E-16, 20, 30
- ❾ **SYNCHRO/ENDING, PAUSE** button  E-16, 30, 31
- ❿ **START/STOP, PLAY/STOP** button  E-15, 16, 18, 21, 22, 27
- ⓫ **ACCOMP ON/OFF, PART SELECT** button  E-15, 18, 20, 22, 28, 34
- ⓬ **TEMPO** buttons  E-8, 17, 31
- ⓭ Number buttons, [-]/[+] buttons  E-4
- ⓮ **SONG BANK** button  E-15, 17, 20

- ⓯ **RHYTHM, ONE TOUCH PRESET** button  E-9, 27, 31
- ⓰ **STONE** button  E-6, 9
- ⓱ **LISTEN** button  E-21
- ⓲ **WATCH** button  E-21
- ⓳ **REMEMBER** button  E-22
- ⓴ **NEXT** button  E-20
- ⓵ **AUTO** button  E-23
- ⓶ **MUSIC CHALLENGE** button  E-25
- ⓷ Speakers
- ⓸ Song Bank list
- ⓹ Rhythm list
- ⓺ Display
- ⓻ Tone list
- ⓼ **PITCH BEND** wheel (CTK-3000 only)  E-11
- ⓽ CHORD root names  E-28
- ⓿ Percussion instrument list  E-9

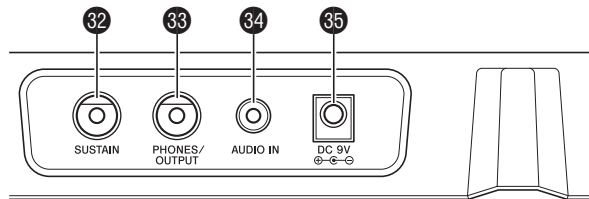

❶ **USB** port  E-32



- ❷ **SUSTAIN** jack  E-10
- ❸ **PHONES/OUTPUT** jack  E-6, 35
- ❹ **AUDIO IN** jack  E-12, 35
- ❺ **DC 9V** terminal  E-5



Using the 10-key Pad (13)

Use the number buttons and the [-] and [+] buttons to change the settings of the parameters that appear in the upper left area of the display.

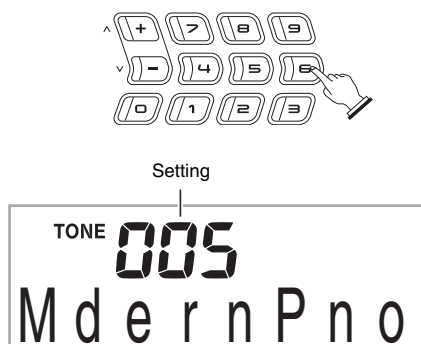

Number Buttons

Use the number buttons to enter numbers and values.

- Enter the same number of digits as the currently displayed value.

Example: To enter tone number 005, input 0 → 0 → 5.

NOTE

- Negative values cannot be input using the number buttons. Use [+] (increase) and [-] (decrease) instead.

[-] and [+] Buttons

You can use the [+] (increase) and [-] (decrease) buttons to change the displayed number or value.

- Holding down either button scrolls the displayed setting.
- Pressing both buttons at the same time will revert to the initial default setting or the recommended setting.

Using the Setting Button (3)

Use the Setting button (3) to access settings that let you select the reverb type, pedal effect, etc.

1. Press 3.

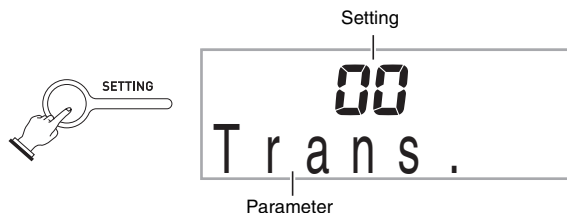

2. Next press 3 until the parameter whose setting you want to change is displayed.

Each press of 3 cycles through the available parameters.

	Parameter	Display	See Page
1	Transpose	Trans.	E-11
2	Accompaniment Volume	AcompVol	E-31
3	Song Volume	Song Vol	E-17
4	Touch Response (CTK-3000 only)	Touch	E-7
5	Tuning	Tune	E-11
6	Reverb	Reverb	E-10
7	Voice Fingering Guide	Speak	E-22
8	Note Guide	NoteGuid	E-23
9	Performance Evaluation	Scoring	E-23
10	Phrase	PhraseLn	E-23
11	Sampling Start	SmplAuto	E-13
12	Keyboard Channel	Keybd Ch	E-33
13	Navigate Channels	Navi. Ch	E-33
14	Local Control	Local	E-34
15	Accomp Out	AcompOut	E-34
16	Pedal Effect	Jack	E-10
17	Pitch Bend Range (CTK-3000 only)	Bend Rng	E-11

3. When the parameter you want is displayed, use 13 (10-key) to change its setting.

- The parameter setting will disappear from the upper left area of the screen if you do not perform any operation for some time.

IMPORTANT!

- The tone and other parameters revert to their initial defaults whenever you turn on power (page E-6).

Getting Ready to Play

Preparing the Music Stand

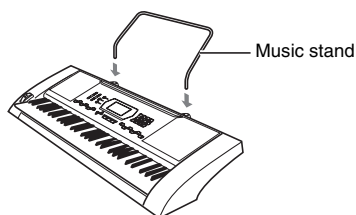

Power Supply

Either an AC adaptor or batteries can be used to power this Digital Keyboard. Normally, use of AC adaptor power is recommended.

- The AD-5 AC adaptor does not come with this Digital Keyboard. Purchase it separately from your retailer. See page E-1 for information about options.

Using the AC Adaptor

Use the AD-5 AC adaptor when you want to power the Digital Keyboard from a household electrical outlet.

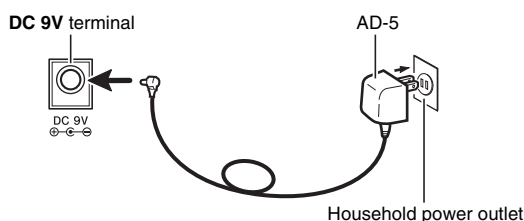

IMPORTANT!

- Be sure to turn off Digital Keyboard power before connecting or disconnecting the AC adaptor.

Using Batteries

IMPORTANT!

- Be sure to turn off power before loading batteries.
- It is up to you to prepare six commercially available AA-size batteries. Do not use oxyride batteries or any other nickel based batteries.

1. Open the battery cover on the bottom of the Digital Keyboard.

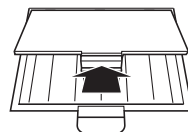

2. Load six AA-size batteries into the battery compartment.

Make sure the positive (+) and negative (-) ends of the batteries are facing as shown in the illustration.

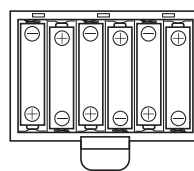

3. Insert the tabs of the battery cover into the holes on the side of the battery compartment, and close the cover.

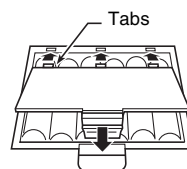

Low Battery Indication

The indicator shown below starts to flash to let you know when battery power is low. Replace the batteries with new ones.

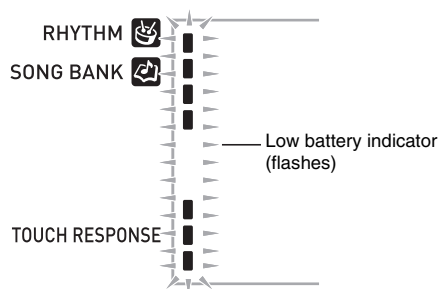

Playing the Digital Keyboard

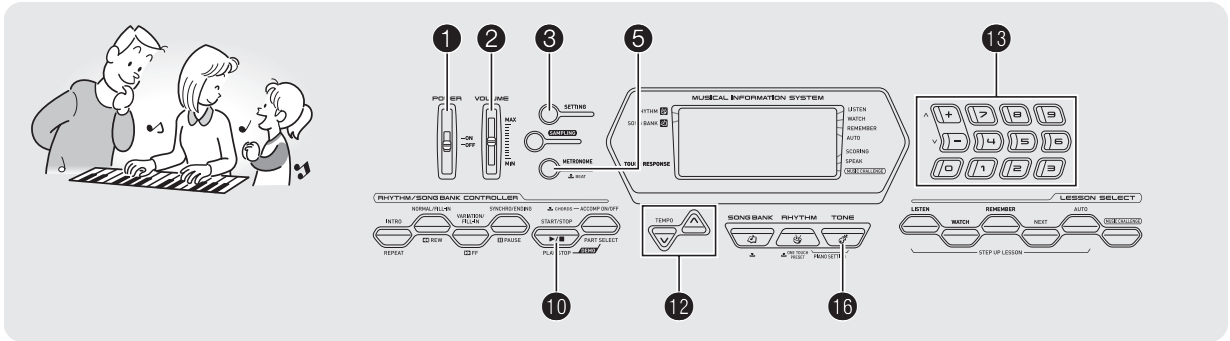

Turning on Power and Playing

- 1. Turn on ①.**
This turns on power.
- 2. Try playing something on the keyboard. Use ② to adjust volume.**

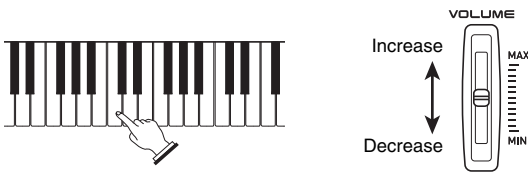

- IMPORTANT!**
- Turning off the keyboard power causes all current settings and sampled sounds (page E-12) to be cleared. The keyboard will revert to initial default settings the next time you turn it on.

Auto Power Off (Using Batteries)

While you are using batteries for power, power will turn off automatically if you do not perform any operation for about six minutes. Auto Power Off is disabled while the AC adaptor is being used for power.

- Disabling Auto Power Off**
- You can disable Auto Power Off to ensure that power is not turned off automatically during a concert, etc.

- 1. While holding down ⑩, turn on power.**
Auto Power Off will be disabled.

Using Headphones

- Using headphones cuts off output from the built-in speakers, which means you can practice playing even late at night without disturbing others.
- Be sure to turn down the volume level before connecting headphones.

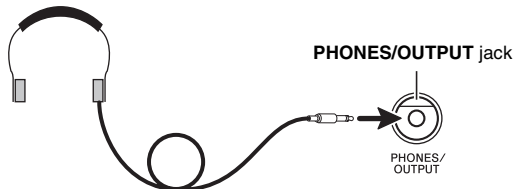

- NOTE**
- Headphones do not come with the Digital Keyboard.
 - Use commercially available headphones. See page E-1 for information about options.

- IMPORTANT!**
- Do not listen to very high volume output over headphones for long period. Doing so creates the risk of hearing damage.
 - If you are using headphones that require an adaptor plug, make sure you do not leave the adaptor plugged in when removing the headphones.

Changing Keyboard Response to Touch Pressure (Touch Response) (CTK-3000 only)

Touch Response alters tone volume in accordance with keyboard pressure (speed). This provides you some of the same expressivity you get on an acoustic piano.

Keyboard Instrument Sound Intensity

■ Sound intensity depends on the speed that keys are pressed.

People normally believe that the stronger the pressure applied to a piano keyboard, the louder the sound. Actually, however, the intensity of the notes played depends on the speed at which keys are pressed. Notes are louder when keys are pressed quickly, and quieter when keys are pressed slowly. Keeping this in mind as you play a keyboard musical instrument lets you control note volume without striving to apply too much pressure with your fingertips.

■ The playability of an acoustic piano

Your Digital Keyboard provides you with key touch that is the next best thing to an acoustic piano. Note volume changes automatically in accordance with key press speed.

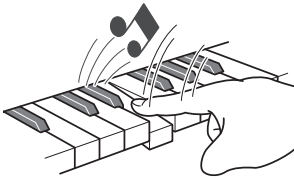

Pressing fast produces louder notes.

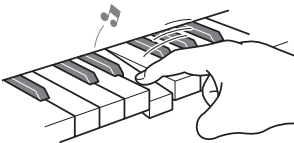

Pressing slowly produces softer notes.

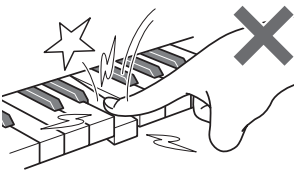

Do not try to use too much pressure.

Changing Touch Response Sensitivity

Use the procedure below to control how much the volume of played notes change in accordance with playing speed. Select the setting that best matches your playing style.

1. Press **Ⓢ** a number of times until “Touch” appears on the display (page E-4).



2. Use **Ⓢ** (10-key) [-] and [+] keys to select one of the three Touch Response sensitivity settings.

Off (oFF)	Touch Response is turned off. Sound volume is fixed, regardless of key press speed.
Type 1 (1)	Normal Touch Response
Type 2 (2)	More sensitive Touch Response than Type 1

TOUCH RESPONSE

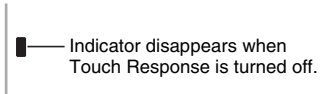

Using the Metronome

The metronome lets you play and practice along with a steady beat to help keep you on tempo.

Start/Stop

1. Press **5**.

This starts the metronome.

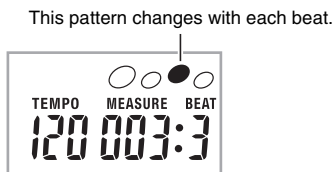

2. Press **5** again to stop the metronome.

Changing the Beats Per Measure

You can configure the metronome to use a bell sound for the first beat of each measure of the song you are playing.

- You can specify 0, or a value from 2 to 6 as the number of beat per measure.
- When playing a built-in song, the beats per measure setting (which determines when the bell sounds) is configured automatically for the currently selected song.

1. Hold down **5** until the beats per measure setting screen appears on the display.



- If you do not perform any operation for after the beats per measure setting screen appears, the display will return to the screen displayed before you pressed **5**.

2. Use **13** (10-key) to enter the number of beats per measure.

- The bell will not sound if you specify 0 for this setting. In this case, all beats are indicated by a click sound. This setting lets you practice with a steady beat, without worrying how many beats there are in each measure.

Changing the Metronome Tempo

Use the following procedure to change the tempo of the metronome.

1. Press **12**.

Use **V** (slower) and **^** (faster) to change the tempo setting. Holding down either button changes the setting at high speed.

- Pressing **V** and **^** at the same time will initialize the tempo setting in accordance with the currently selected song or rhythm.
- Pressing **12** causes the tempo value to flash on the display. While the tempo value is flashing, you can use **13** (10-key) to change it.

Note that you must input leading zeros, so 89 is input as 089.

- The tempo value will stop flashing if you do not perform any operation for a short while.

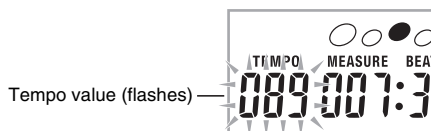

Changing the Metronome Sound Volume

The metronome volume setting is changed automatically with the volume level of the currently selected Auto Accompaniment or song. The metronome volume cannot be adjusted independently.

- For information about changing the Auto Accompaniment volume, see page E-31.
- For information about changing the song volume, see page E-17.

NOTE

- You cannot adjust the balance between the metronome and note volume during Auto Accompaniment and built-in tune play.

Controlling the Keyboard Sounds

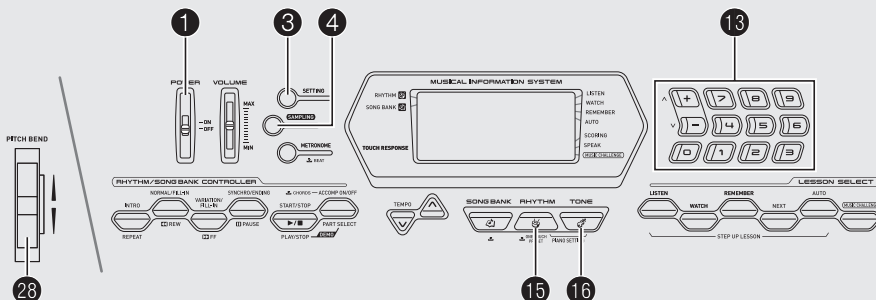

Select from a variety of musical instrument sounds

Your Digital Keyboard lets you select tones for a wide variety of musical instrument sounds, including violin, flute, orchestra, and more. Even the same song sound takes on a different feel by changing the instrument type.

To select an instrument for playing

1. Press **16**.

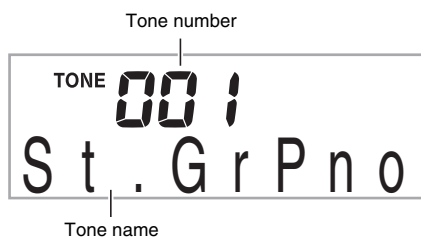

2. Use **13** (10-key) to select the tone number you want.

The corresponding tone number and tone name will appear on the screen.

NOTE

- See the separate "Appendix" for a complete list of available tones.
- You also can find out instrument numbers using the tone groups printed on the Digital Keyboard's console.
- Use the number buttons to enter the tone number. Specify three digits for the tone number.
Example: To select 001, enter 0 → 0 → 1.
- When one of the drum sets is selected (tone numbers 395 through 400), each keyboard key is assigned a different percussion sound.

3. Try playing something on the keyboard.

The tone of the instrument you selected will sound.



Playing with a Piano Tone (Piano Setup)

1. Press **15** and **16** at the same time.

This selects the grand piano tone.

Settings

Tone Number:	"001"
Reverb:	"06"
Transpose:	00
Touch Response:	Off: Returns to initial default On: No change
Pedal Effect:	SUS
Rhythm Number:	"131"
Accompaniment:	Rhythm part only
Local Control:	On
Drum Assign:	Off

Using Reverb

Reverb adds reverberation to notes. You can change the duration of the reverb.

1. Press **Ⓢ** a number of times until “Reverb” appears on the display (page E-4).



2. Use the **Ⓢ** (10-key) [-] and [+] keys to select the reverb setting you want.

Off (oFF)	Turns off reverb.
1 to 10	The larger the number selected, the longer the reverb duration.

Indicator disappears when reverb is turned off.



Using a Pedal

A pedal can be used to change notes in various ways while playing.

- A pedal unit does not come with the Digital Keyboard. Purchase one separately from your retailer. See page E-1 for information about options.

Connecting a Pedal Unit

Connect an optional pedal unit.

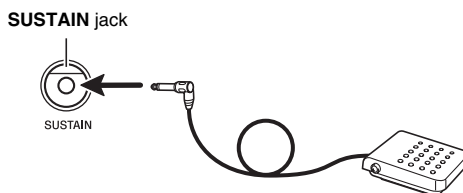

Selecting the Pedal Effect

1. Press **Ⓢ** a number of times until “Jack” appears on the display (page E-4).



2. Use the **Ⓢ** (10-key) [-] and [+] keys to select the pedal effect you want.

- The following shows the available pedal effects.

Sustain (SUS)	Sustains notes played while the pedal is depressed. Organ and other similar tone notes are sustained even if the pedal is not pressed.
Sostenuto (SoS)	Sustains notes that are playing when the pedal is depressed before the keyboard keys are released.
Soft (SFt)	Slightly softens notes played while the pedal is depressed.
Rhythm (rHy)	Pressing the pedal starts and stops Auto Accompaniment or song playback.

Changing the Pitch (Transpose, Tuning)

Changing the Pitch in Semitone Steps (Transpose)

The transpose feature lets you change the pitch, in semitone steps. A simple operation lets you instantly change the pitch to match that of a singer.

- The transpose setting range is -12 to +12 semitones.

1. Press **3**.



2. Use the **13** (10-key) [-] and [+] keys to select the transpose setting you want.

Fine Tuning (Tuning)

Use the tuning feature when you need to adjust the pitch slightly to play along with another musical instrument. Also, some artists perform their music with slightly altered tuning. You can use the tuning feature to adjust tuning so it exactly matches a performance on a CD.

- The tuning setting range is -99 to +99 cents.

1. Press **3** a number of times until "Tune" appears on the display (page E-4).



2. Use the **13** (10-key) [-] and [+] keys to adjust the tuning.

Using the Pitch Bend Wheel to Shift the Pitch of Notes (CTK-3000 Only)

You can use the pitch bend wheel to slide the pitch of notes smoothly upwards and downwards. This technique makes it possible to produce effects that are similar to sounds produced when bending notes on a saxophone or electric guitar.

To play with the pitch bend wheel

1. While playing a note on the keyboard, rotate the pitch bend wheel on the left of the keyboard upwards or downwards.

The amount the note bends depends on how much you rotate the pitch bend wheel.

- Do not have the pitch bend wheel rotated as you turn on the keyboard.

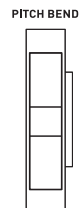

Specifying the Pitch Bend Range

Use the following procedure to specify how much the pitch of the note changes whenever the pitch bend wheel is rotated upwards or downwards. You can specify a range from 0 to 12 semitones (one octave).

1. Press **3** a number of times until "Bend Rng" appears on the display (page E-4).



2. Use the **13** (10-key) [-] and [+] keys to change the range.

Sampling a Sound and Playing It on the Keyboard (Sampling)

You can use the Digital Keyboard to sample a sound from a portable audio player, or other device, and then play the sound with keyboard keys. For example, you could sample the bark of your dog and then use the sound in a melody. You also can sample and use passages from a CD. The sampling feature is a great way to create new sounds that are highly creative.

Connection

Connect an external device.

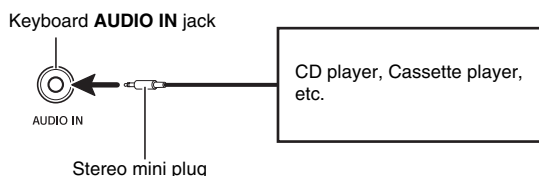

NOTE

- Connection requires commercially available connecting cords, supplied by you. The connecting cords should have a stereo mini plug on one end and a plug that matches the configuration of the external device on the other end.

IMPORTANT!

- Turn off the external device and the Digital Keyboard before connecting them.
- Sampled sounds are recorded in monaural.

Sampling a Sound and Playing It

1. Turn the volume levels of the external device and Digital Keyboard down.
2. Turn on the external device and then the Digital Keyboard.
3. Press **4**.
This enters record standby.

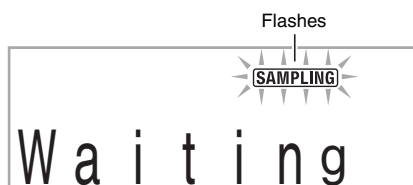

4. Output the sound from the external device.

The Digital Keyboard will start sampling automatically, and stop after one second.

What you sample is stored as tone number 401.

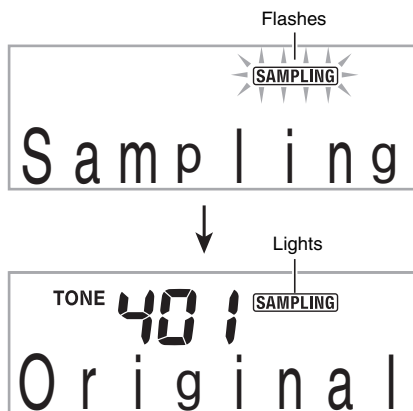

5. Try playing something on the keyboard.

NOTE

- Sampling will not start if the volume level of the external device is too low.
- A new sample replaces sample data currently stored as tone number 401. The old data is deleted.

Turning off power clears sampled data!

Turning off power will cause any sampled sound data on the keyboard to be deleted.

■ How sampled sounds are played

Pressing Middle C (C4) will play back the original sound. The keys to the left and right of C4 play the sound at different pitches.

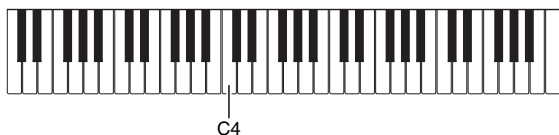

Starting a Sampling Operation Manually

1. Press **3** a number of times until “SmpAuto” appears on the display (page E-4).



2. Press **10** (10-key) [-] key to select the OFF setting.

This enables manual sampling. When this setting is selected, sampling will not start until you press **4**.

! IMPORTANT!

- When the above setting is “oFF”, sampling starts when you release **4**, not when you press it. Sampling will not start if you keep **4** depressed.

Applying Effects to a Sampled Sound

You can apply various effects to the sample sound stored at tone number 401.

1. Use **10** (10-key) to select a tone number from 402 to 411.

Tone numbers 402 to 411 actually represent effects assigned to tone number 401. Selecting a tone will play the sampled sound in a loop, along with the applicable effect, as described below.

	Effect Name	Description
402	Loop 1	Loops the sampled sound.
403	Loop 2	Loops the sample sound and raises the pitch of the resonating sound when the keyboard key is released.
404	Loop 3	Loops the sample sound and lowers the pitch of the resonating sound when the keyboard key is released.
405	Pitch 1	Changes the pitch from low to high, at an increasing rate.
406	Pitch 2	Changes pitch from high to low, at a decreasing rate.
407	Pitch 3	Changes pitch from high to low, at a decreasing rate, and then raises the pitch when the key is released.
408	Tremolo	Alternates volume between high and low.
409	Funny 1	Adds vibrato and changes pitch by a gradually increasing amount.
410	Funny 2	Alternates between high pitch and low pitch.
411	Funny 3	Adds vibrato and changes pitch from low to high.

Using a Sampled Sound in a Rhythm (Drum Assign)

Use the following procedure to replace a percussive instrument with a sound you sampled and play auto accompaniment rhythms (page E-27) with the sampled sound.

1. Press **3** and **4** at the same time.

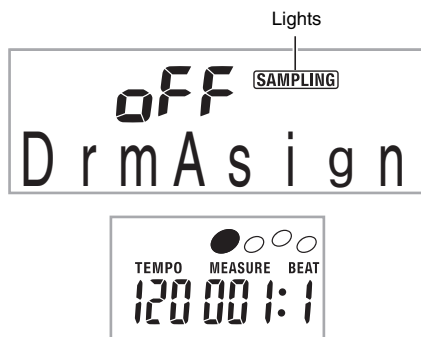

The display will return to the previous screen if you do not perform the next step for some time.

2. Use the **10** (10-key) [-] and [+] keys to select the drum assign type you want.

Off (oFF)	Sampled sound does not sound.
Type 1 (dr1)	Replaces the bass drum and snare drum of the rhythm with the sampled sound.
Type 2 (dr2)	Replaces more of the percussive instruments than Type 1 with the sampled sound.

3. Start rhythm play (page E-27).

The rhythm sounds in accordance with the drum assign type you selected in step 2.

NOTE

- If the rhythm does not include a bass drum and snare drum, the sampled sound will not sound while Type 1 is selected.
- Rhythm numbers 140, and 142 to 150 do not use percussive instruments, so the sampled sound does not sound when these rhythm numbers are selected.

Playing Built-in Songs

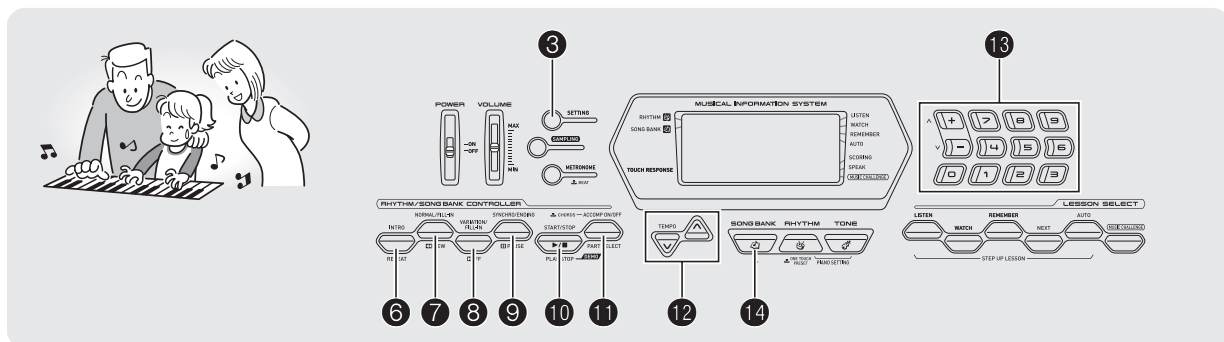

With this Digital Keyboard, built-in tune data is referred to as “songs”. You can listen to the built-in songs for your own enjoyment, or you can play along with them for practice.

NOTE

- In addition to simple listening enjoyment, the built-in songs can be used with the lesson system (page E-19) for practice.

Playing the Demo Songs

Use the following procedure to play back built-in songs (001 to 090).

1. Press **10** and **11** at the same time.

This will start playback of the demo songs. Demo playback continues until you stop it.

- See page E-40 for a complete list of available songs.
- Demo playback always starts from song number 001.

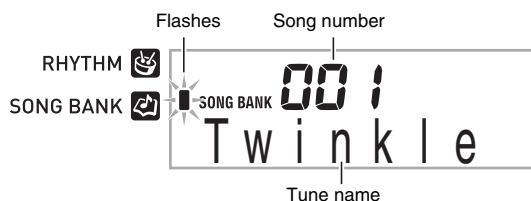

2. To change to another song while demo playback is in progress, use **13** (10-key) [-] and [+] keys to enter the song number you want (page E-4).

This will cause demo playback to jump to the song whose number you entered.

- You cannot use **13** (10-key) number buttons to select a song.

3. To stop demo playback, press **10**.

Demo playback continues until you stop it by pressing **10**.

Playing Back a Particular Song

Use the procedure below to play back one of the built-in songs. You can play along on the keyboard with song playback.

Start/Stop

1. Press **14**.

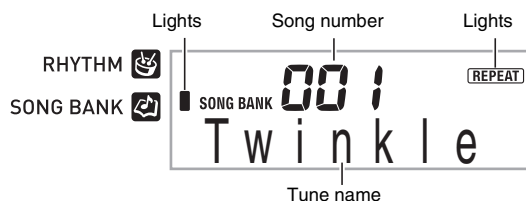

2. Use **13** (10-key) to enter the number of the song you want.

- See page E-40 for a complete list of available songs.
- Song group names are printed on the Digital Keyboard's console.

3. Press 10.

This starts playback of the song.

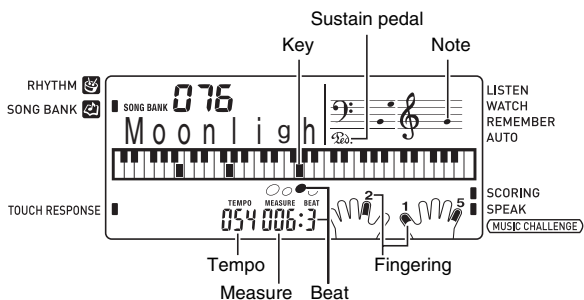

4. Press 10 again to stop playback.

Song playback will continue (repeat) until you press 10 to stop it. You can cancel song repeat by pressing 6 ("REPEAT" indicator disappears from the display).

Pause, Skip Forward, Skip Back

Use the operations in this section to perform pause, skip forward, and skip back operations.

Pause

1. Press 9.

This pauses song playback.

2. Press 9 again to resume playback from the point where you paused it.

Skip Forward

1. Press 8.

This skips song playback forward to the next measure. Each press of 8 skips ahead one measure. Holding down 8 skips forward at high speed until you release it.

- Pressing 8 while song playback is stopped performs lesson function phrase skip forward (page E-20).

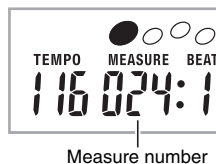

Skip Back

1. Press 7.

This skips song playback back to the previous measure. Each press of 7 skips back one measure. Holding down 7 skips back at high speed until you release it.

- Pressing 7 while song playback is stopped performs lesson function phrase skip back (page E-20).

Repeating Playback of Specific Measures

You can use the procedure in this section to repeat particular measures for practice playing along until you master it. You can specify the start measure and the end measure of the section you want to play and practice.

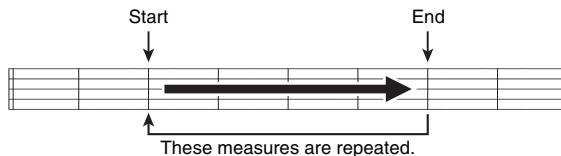

1. Press 6 to temporarily turn off song repeat ("REPEAT" disappears from the display).

2. When song playback reaches the measure you want to specify as the start measure, press 6.

This specifies the measure as the start measure.



3. When playback reaches the measure you want to select as the end measure, press **6** again.

This specifies the measure as the end measure and starts repeat playback of the measures in the specified range.

- During repeat play you can use **9** to pause playback, **8** to skip forward, or **7** to skip back.



4. Pressing **6** again returns to normal playback.

Changing the song number clears the start measure and end measure of the repeat operation.



Adjusting the Song Volume

Use the following procedure to adjust the balance between the volume of what you play on the keyboard and song playback volume.

1. Press **3** a number of times until "Song Vol" appears on the display (page E-4).

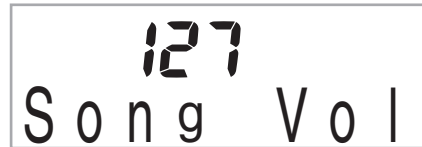

2. Use the **13** (10-key) [-] and [+] keys to adjust the song volume.

Playing with the Tone as Song Playback

The procedure below lets you select the same keyboard tone as the one being used in the song and play along with your favorite tunes.

1. After selecting a song, hold down **14** for about two seconds until the displayed tone name changes to the tone name of the song.
 - If your currently selected tone is the same as the song tone, the display contents will not change.

2. Play along with song playback.

NOTE

- If you select a song that uses different tones for left and right hand play, the right hand part tone is assigned to the keyboard.

Changing Playback Speed (Tempo)

You can use the following procedure to change the speed (tempo) in order to slow down playback to practice difficult passages, etc.

1. Press **12**.

Use **V** (slower) and **^** (faster) to change the tempo setting. Holding down either button changes the setting at high speed.

- Pressing **V** and **^** at the same time will return the current song to its original default tempo.
- Pressing **12** causes the tempo value to flash on the display. While the tempo value is flashing, you can use **13** (10-key) to change it. The tempo value will stop flashing if you do not perform any operation for a short while.
- Changing the song number will return the song to its original default tempo.

Turning Off the Part of One Hand for Practice (Part Select)

You can turn off the right hand part or the left hand part of a song during playback and practice playing the along with the remaining part.

1. Press **II** to select the part you want to turn off.

Each press of **II** cycles through the settings shown below.

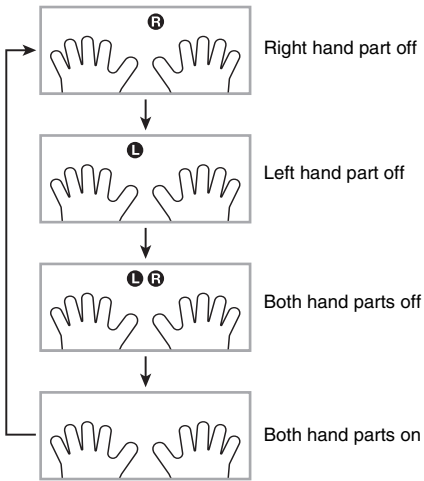

2. Press **IO**.

This starts playback in accordance with the setting you selected in step 1.

NOTE

- During playback with one part turned off, only the notes of the part that is turned off are shown on the display.

Using Built-in Songs to Master Keyboard Play

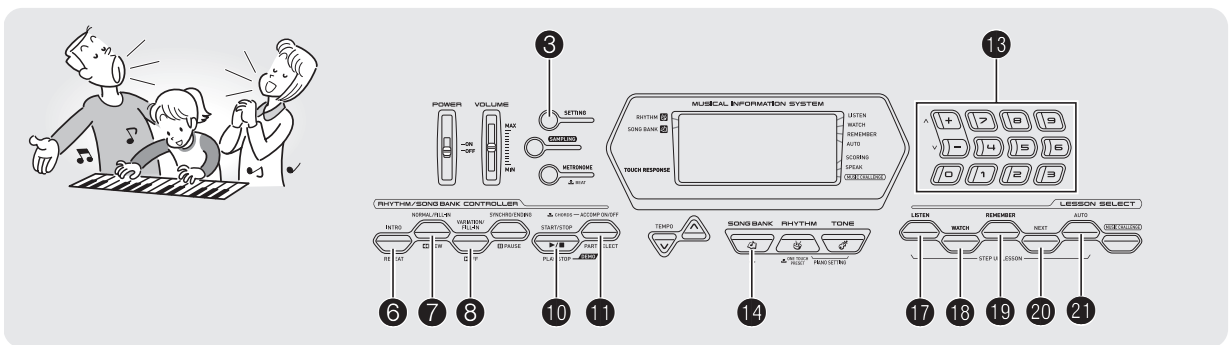

To master a song, it is best to break it up into shorter parts (phrases), master the phrases, and then put everything together. Your Digital Keyboard comes with a Step Up Lesson feature that helps you to do just that.

Phrases

The built-in songs are pre-divided into phrases to help you master keyboard play.

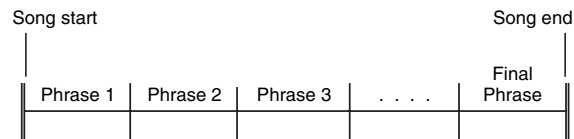

Step Up Lesson Flow

Step Up Lesson takes you through practice of the right hand part, left hand part, and both hand parts for each phrase of a song. Master all of the phrases and you master the song.

Phrase 1

- Right Hand Lesson 1, 2, 3
- Left Hand Lesson 1, 2, 3
- Both Hand Lesson 1, 2, 3



Repeat the above to practice phrase 2, 3, 4, and so on, until you reach the final phrase of the song.

After mastering all of the phrases, practice the entire song.

Now you have mastered the entire song!



Messages that Appear during Lessons

The following are the messages that appear on the display during Step Lessons.

Message	Description
<Phrase>	Appears when you select a phrase, when a lesson starts, etc. <ul style="list-style-type: none"> Note that certain phrases will cause "Wait" to appear instead of "Phrase".
<Wait>	Appears when the lesson starts with an intro or fill-in phrase that is not included in the phrases to be practiced. Play toll advance automatically to the next phrase after the un-included phrase plays, so wait until then to start playing on the keyboard.
NextPhrs	Appears when advancing automatically to the next phrase. This message appears following a phrase for which "Wait" (see above) is displayed, and during an Auto Step Up Lesson (page E-23).
From Top	This message appears during Auto Step Up Lesson (page E-23) immediately before practice from Phrase 1 up until the phrase currently being practiced.
Complete	Appears at the end of Auto Step Up Lesson (page E-23).

Selecting the Song, Phrase, and Part You Want to Practice

First, select the song, phrase, and part you want to practice.

1. Select the song you want to practice (page E-15).

This will select the first phrase of the song.

2. Press **20** (or **8**) to move forward one phrase, or **7** to move back one phrase.

- Holding down **8** or **7** scrolls through phrases at high speed.
- The keyboard remembers the last phrase you practiced for up to 20 songs. To recall the last practice phrase for the current song (if it is available), hold down **20**.

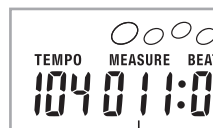
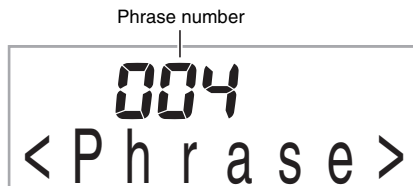

First measure of the selected phrase

3. Press **11** to select the part you want to practice. Each press of **11** cycles through the settings shown below.

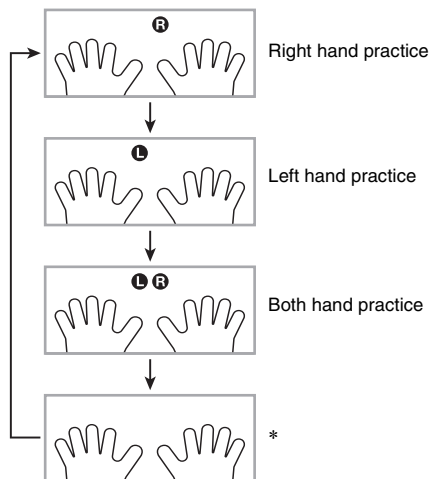

* This indicator (setting) is skipped if you press **11** while a lesson is in progress.

4. Hold down **14** for about two seconds.

The same tone used for song playback will be assigned to the keyboard (page E-17).

Lessons 1, 2, and 3

Now it is time to start the lessons. First, select the song and part you want to practice.

Lesson 1: Listen to the song.

First, listen to the example a few times to familiarize yourself with what it sounds like.

1. Press **17**.

This starts example play.



2. To stop Lesson 1, press **17** or **10**.

Lesson 2: Watch how the song is played.

Play the song on the keyboard. During this lesson, the display shows the key you need to press next. Voice fingering guide also uses a simulate voice to announce which finger you should use. Follow the instructions to press the correct keyboard keys and play the notes. Don't worry if you play the wrong note. Song playback will wait until you play the correct note. Take your time and play at your own pace.

1. Press **18**.

This starts Lesson 2.



2. Play notes on the keyboard in accordance with the instructions provided on the display and by voice fingering guide.

During this lesson, the display shows the key you need to press next. Voice fingering guide uses a simulate voice to announce which finger you should use.

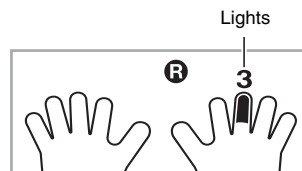
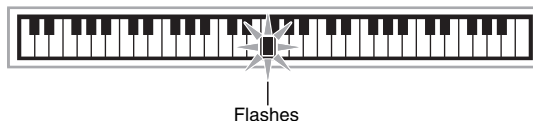

<Lesson 2 Guidance>

Master playing the correct note with the correct finger as instructed by the guidance. Practice playing with the correct timing.



Song playback will wait for you to play the correct note.

- Keyboard key goes from flashing to lit.
- Note guide sounds the correct note to be played.
- Voice Fingering Guide tells you what finger to use.



Pressing the correct keyboard key causes song playback to resume and the key for the next note flashes.

3. To stop Lesson 2, press **18** or **10**.

- If you complete Lesson 2 play to the end, a score that rates your play appears on the screen.

Bravo!	You pass! Advance to the next lesson.
Again!	Go back and try again.

Lesson 3: Remember what you learned as you play.

Though song playback stands by waiting for you to press the correct keys as in Lesson 2, the Digital Keyboard does not provide any guidance about what note you need to play next. Remember everything you have learned up to Lesson 2 as you play.

1. Press **19**.

This starts Lesson 3.



2. Play the song along with the song playback.

<Lesson 3 Guidance>

Press the keyboard keys you learned in Lesson 2.



Song playback will wait for you to play the correct note.

- Note guide sounds the correct note to be played.



If you are still unable to press the correct keyboard key, the Digital Keyboard will display keyboard guidance and voice fingering guide will tell you what finger to use, just as in Lesson 2.



Pressing the correct key will cause song playback to resume.

3. To stop Lesson 3, press **19** or **10**.

- If you complete Lesson 3 play to the end, a score that rates your play appears on the screen the same as with Lesson 2.

Playing a Particular Song All the Way Through

After you successfully complete all of the phrases in Lessons 1, 2, and 3, it is time to try playing the entire song from beginning to end.

1. Use **11** to turn off both hand parts and then press **10**.

Try playing with both hands and find out how the Digital Keyboard evaluates your effort.

Lesson Settings

Playing without Phrase Repeat

You can turn off phrase repeat for Lessons 1, 2, and 3.

1. Press **6**.

This disables phrase repeat play.



Turning Off Voice Fingering Guide

Use the following procedure to turn off voice fingering guide, which tells you which finger to use to play each note in Lesson 2 and Lesson 3.

1. Press **3** a number of times until "Speak" appears on the display (page E-4).



2. Press the **13** (10-key) [-] key to select the OFF setting.

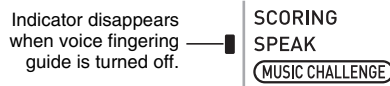

Turning Off Note Guide

Use the following procedure to turn off note guide, which sounds the note to be played next in Lesson 2 and Lesson 3.

1. Press **Ⓢ** a number of times until “NoteGuid” appears on the display (page E-4).



2. Press the **Ⓜ** (10-key) [-] key to select the OFF setting.

Turning Off Performance Evaluation

Use the following procedure to turn off performance evaluation, which evaluates your performance and displays a score in Lesson 2 and Lesson 3.

1. Press **Ⓢ** a number of times until “Scoring” appears on the display (page E-4).



2. Press the **Ⓜ** (10-key) [-] key to select the OFF setting.

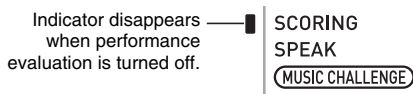

Lesson Play without Dividing Songs into Phrases

When the phrase function is turned off, lessons go through an entire song from beginning to end, without dividing it up between phrases.

1. Press **Ⓢ** a number of times until “PhraseLn” appears on the display (page E-4).



2. Press the **Ⓜ** (10-key) [-] key to select the OFF setting.

Using Auto Step Up Lesson

With Auto Step Up Lesson, the Digital Keyboard advances through each lesson automatically.

1. Select the song and part you want to practice (page E-15).

2. Press **Ⓢ**.

Listen to the first phrase in Lesson 1.

- In Lesson 1, the sample phrase is played only once before advancing to Lesson 2.



3. Auto Step Up Lesson stops automatically after you are able to get through all of the lessons successfully.

- In Lesson 2 and Lesson 3, the Digital Keyboard advances to the next lesson if you are able to achieve the “Bravo!” evaluation result.
- To cancel a lesson, press **Ⓢ** or **Ⓜ**.

NOTE

- You can change the step and phrase during Auto Step Up Lesson using **Ⓢ**, **Ⓢ**, and **Ⓢ** to **Ⓢ**.
- Starting Auto Step Up Lesson automatically turns on phrase repeat (page E-22) and play evaluation (page E-23). These features cannot be turned off during lessons.

■ Auto Step Up Lesson Procedure

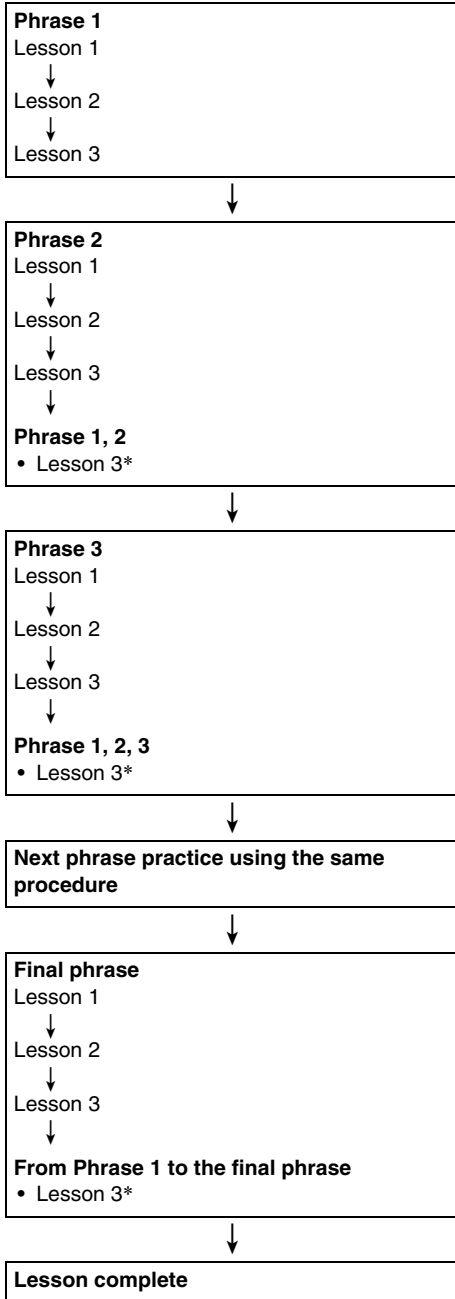

* Auto Step Up Lesson advances to the next phrase, regardless of whether the "Bravo!" result is attained.

Music Challenge Keyboard Game

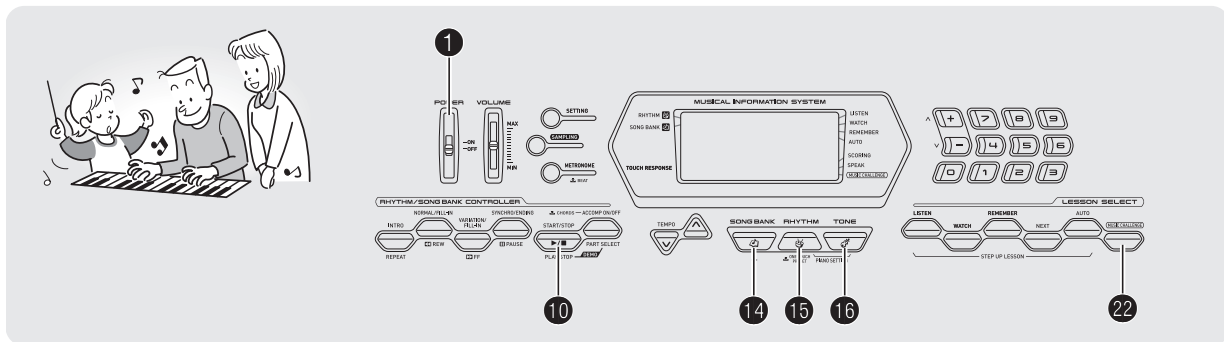

Music Challenge is a game that measures your reaction speed as you press keys in response to on-screen keyboard indicators and fingering guide indications.

1. Press 22.

This causes a key on the on-screen keyboard to start to flash, and starts the Music Challenge song.



Number of remaining notes

Fingering
Displayed during a game.

2. After the on-screen keyboard indicator changes from flashing to lit, press the indicated key with the indicated finger as quickly as possible.

This causes the on-screen keyboard key to go out to let you know that you cleared the first note. The next on-screen keyboard key starts to flash, so get ready to press the next key.

- The time it takes you to press the keyboard key after the on-screen key lights appears on the display (Unit: 0.1 sec). The shorter the time, the higher your score.
- Pressing a keyboard key before the on-screen key goes from flashing to lit, will not advance to the next note.

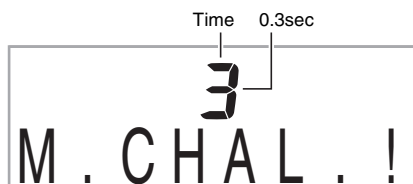

3. The game ends when you advance successfully through 20 notes.

- Your score and playing time appear on the display. After a short while, the playing time display changes to an evaluation result. To clear the evaluation result from the display, press **14**, **15**, or **16**.
- You can cancel a game at any time by pressing **20** or **10**.

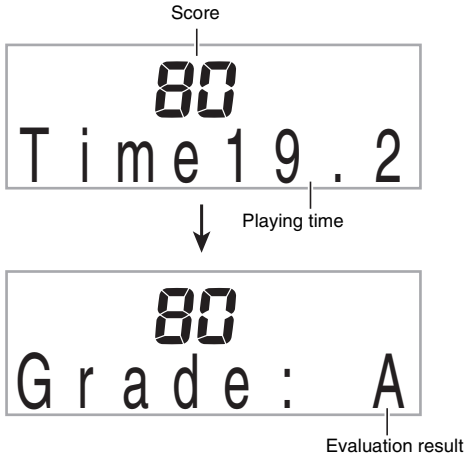

Evaluation Result

S	↑ <High> Evaluation Ranges ↓ <Low>
A	
B	
C	
D	

NOTE

- Notes and fingering guide fingers are indicated randomly.
- The tempo of the game songs cannot be changed.
- All buttons except **1**, **10**, and **20** are disabled while a game is in progress.

Using Auto Accompaniment

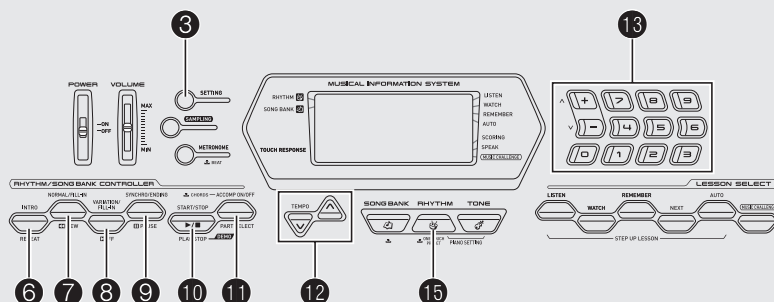

With Auto Accompaniment, simply select an accompaniment pattern. Each time you play a chord with your left hand the appropriate accompaniment will play automatically. It's like having a personal backup group along with you wherever you go.

NOTE

- Auto Accompaniments are made up of the following three parts.
 - Rhythm
 - Bass
 - Harmony

You can have only the rhythm part play, or you can have all three parts play at the same time.

Playing the Rhythm Part Only

The rhythm part is the foundation each Auto Accompaniment. Your Digital Keyboard comes with a variety of built-in rhythms, including 8-beat and waltz. Use the following procedure to play the basic rhythm part.

Starting and Stopping the Rhythm Part Only

- Press **15**.

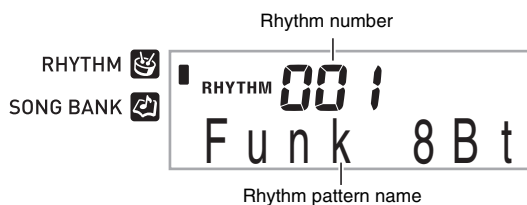

- Use **13** (10-key) to select the rhythm number you want.

- See the separate "Appendix" for information about individual rhythms.
- You also can find out rhythm numbers using the rhythm groups printed on the Digital Keyboard's console.

- Press **10** or **7**.

This starts the rhythm.

This pattern changes with each beat.

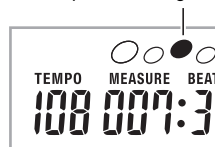

- Play along with the rhythm.

- To stop the rhythm, press **10** again.

Playing All Parts

Auto Accompaniment with Chords

Playing a chord with your left hand automatically adds bass and harmony accompaniment parts to the currently selected rhythm. It is just like having your own personal back up group on call.

1. Start play of the Auto Accompaniment rhythm part.

2. Press **11.**

This enables chord input on the accompaniment keyboard.

Accompaniment keyboard



Lights

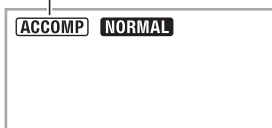

3. Use the accompaniment keyboard to play chords.

This will cause bass and harmony Auto Accompaniment parts to be added to the rhythm part.

Chords
(no melody played)

Melody

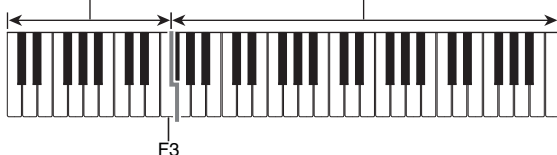

Example: Pressing D-F[#]-A-C on the accompaniment keyboard

Accompaniment for the D-F[#]-A-C chord (D7) sounds.

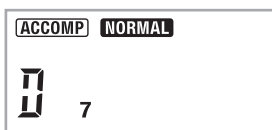

4. Play other chords with left hand as you play the melody with your right hand.

5. Pressing **11 again returns to rhythm only accompaniment.**

NOTE

- For information about starting Auto Accompaniment as soon as a chord is played, see "Using Synchro Start" on page E-31.

Selecting a Chord Input Mode

You can select from among the following five chord input modes.

- FINGERED 1
- FINGERED 2
- FINGERED 3
- CASIO CHORD
- FULL RANGE CHORD

1. Hold down **11 until the chord input mode selection screen appears on the display.**

Chord input mode

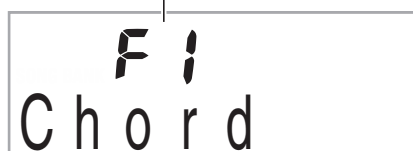

2. Use the **10 (10-key) [-] and [+] keys to select the chord input mode you want.**

- For information about each chord input mode, see the separate "Appendix".
- If you do not perform any operation after the chord input mode selection screen appears, the display will return automatically to the screen that was displayed before you held down **11**.

■ FINGERED 1, 2, and 3

With these three input modes, you finger 3-note or 4-note chords on the accompaniment keyboard. Note that with some chords, even if you do not finger the third or fifth note, they will be played anyway.

Accompaniment keyboard

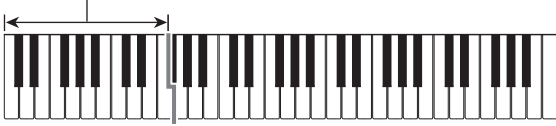

● FINGERED 1

Play the component notes of the chord on the keyboard.



● FINGERED 2

Unlike FINGERED 1, 6th input is not possible. m7 or m7^b5 is input.



● FINGERED 3

Unlike FINGERED 1, allows input of fraction chords with the lowest keyboard note as the bass note.



■ CASIO CHORD

With CASIO CHORD, you can use simplified fingerings to play the four types of chords described below.

Accompaniment keyboard

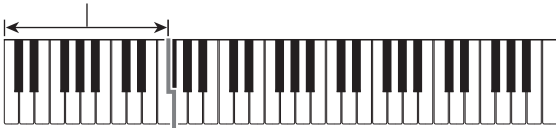

CASIO CHORD Fingering

Chord Type	Example
Major Chords Letters above the accompaniment keyboard indicate the chord assigned to each key. Pressing a single accompaniment area key in the CASIO CHORD mode will play the major chord whose name is marked above the key. All of the accompaniment area keys that are marked with the same chord name play exactly the same chord.	C (C Major)
Minor Chords To play a minor chord, press the accompaniment area key that corresponds to the major chord, while also pressing one other accompaniment area key to the right.	Cm (C Minor)
Seventh Chords To play a seventh chord, press the accompaniment area key that corresponds to the major chord, while also pressing two other accompaniment area keys to the right.	C7 (C Seventh)
Minor Seventh Chords To play a minor seventh chord, press the accompaniment area key that corresponds to the major chord, while also pressing three other accompaniment area keys to the right.	Cm7 (C Minor Seventh)

NOTE

- When playing a minor, seventh, or minor seventh chord, it makes no difference whether the additional keys you press are black or white.

■ FULL RANGE CHORD

With this mode, you can use the full range of the keyboard to play chords and the melody.



Accompaniment keyboard / Melody keyboard

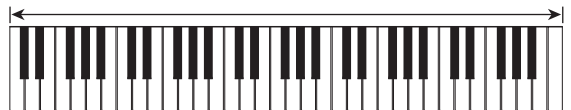

Using Auto Accompaniment Effectively

Auto Accompaniment Pattern Variations

Use the following procedures to play intro and ending patterns, to play fill-in patterns, and to play variations of basic Auto Accompaniment patterns.

Auto Accompaniment Variation

Each Auto Accompaniment pattern has a basic “normal pattern” as well as a “variation pattern”.

1. Press ③.

This starts the variation pattern.

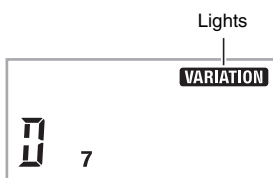

2. Pressing ⑦ returns to normal pattern.

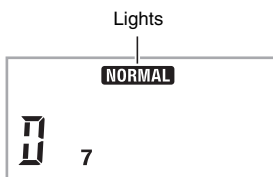

Auto Accompaniment Intro

Use the following procedure to play an intro of a few measures.

1. Press ⑥.

This starts the intro pattern. Normal pattern play will start when the intro pattern is finished.

- If you press ③ while an intro pattern is being played, the variation pattern will start when the intro pattern is finished.

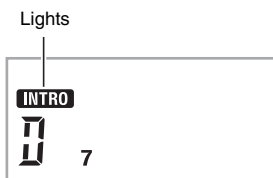

Auto Accompaniment Fill-in

Use the procedure below to play a fill-in pattern during a performance.

- A “fill-in” is a short phrase played where you want to change the mood of a piece. A fill-in pattern can be used to create a link between two melodies or an accent.
- Normal and variation patterns have their own unique fill-in patterns.

Normal Pattern Fill-in

1. While a normal pattern is playing, press ⑦.

This plays the fill-in for the normal pattern.

- Normal pattern play will resume after the fill in pattern is complete.

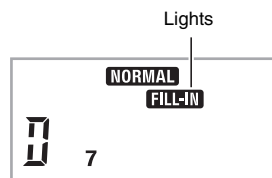

Variation Pattern Fill-in

1. While a variation pattern is playing, press ③.

This plays the fill-in for the variation pattern.

- Variation pattern play will resume after the fill in pattern is complete.

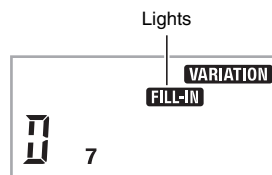

Auto Accompaniment Ending

Use the following procedure to play an ending of a few measures.

1. While an Auto Accompaniment is playing, press ⑨.

This will play the ending pattern and then stop Auto Accompaniment play automatically.

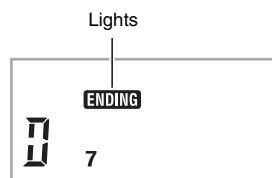

■ Using Synchro Start

Use the following procedure to configure the Digital Keyboard to start Auto Accompaniment play as soon as you press a keyboard key.

1. Press **9**.

This enters accompaniment start standby.

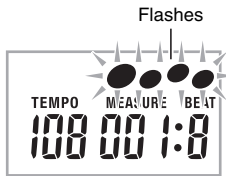

2. Play a chord on the keyboard.

This will start full part accompaniment (normal).

Any of the following operations can be performed while in synchro standby to start a non-normal pattern.

- To start with intro pattern, press **6**.
- To start with variation pattern play, press **8**.

Changing Auto Accompaniment Speed (Tempo)

Use the following procedure to change Auto Accompaniment speed to a level that suits you.

1. Press **12**.

Use **V** (slower) and **^** (faster) to change the tempo setting. Holding down either button changes the setting at high speed.

- Pressing **V** and **^** at the same time will initialize the rhythm setting in accordance with the currently selected rhythm.
- While the tempo value is flashing, you also can use **13** (10-key) to change it.
- If you do not perform any operation for after the tempo setting screen appears, the display will return to the screen displayed before you pressed **12**.

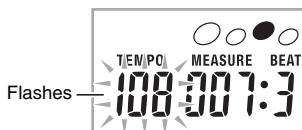

Adjusting the Accompaniment Volume

Use the following procedure to adjust the balance between what you are playing on the keyboard and the volume of the Auto Accompaniment.

1. Press **3** a number of times until "AcompVol" appears on the display (page E-4).



2. Use the **13** (10-key) [-] and [+] keys to adjust the accompaniment volume.

Using One-Touch Preset

With One-Touch Preset, the Digital Keyboard automatically configures optimal tone, tempo, and other settings in accordance with the rhythm pattern you select.

1. Hold down **15** until the current tone screen appears on the display.

This will automatically apply the One-Touch Preset settings in accordance with the rhythm pattern that is currently selected.

2. Play a chord on the keyboard.

This will start accompaniment automatically.



Connecting External Devices

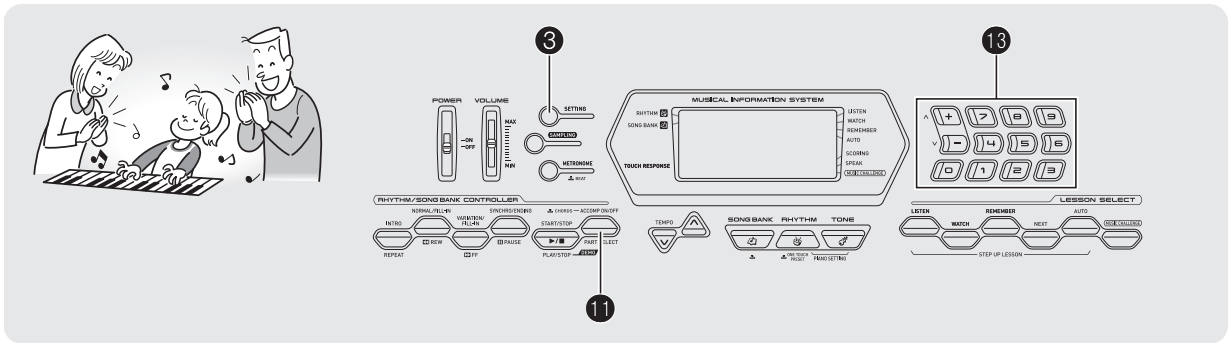

Connecting a Computer

You can connect the Digital Keyboard to a computer and exchange MIDI data between them. You can send play data from the Digital Keyboard to music software running on your computer, or you can send MIDI data from your computer to the Digital Keyboard for playback.

Minimum Computer System Requirements

The following shows the minimum computer system requirements for sending and receiving MIDI data. Check to make sure that your computer complies with these requirements before connecting the keyboard to it.

• Operating System

Windows® XP (SP2 or later)*1

Windows Vista® *2

Mac OS® X (10.3.9, 10.4.11 or later, 10.5.2 or later)

*1: Windows XP Home Edition

Windows XP Professional (32-bit)

*2: Windows Vista (32-bit)

• USB port

! IMPORTANT!

- Never connect to a computer that does not conform to the above requirements. Doing so can cause problems with your computer.

Connecting the Keyboard to Your Computer

! IMPORTANT!

- Make sure you follow the steps of the procedure below exactly. Connecting incorrectly can make data send and receive impossible.

1. Turn off the keyboard and then start up your computer.
 - Do not start up the music software on your computer yet!
2. After starting up your computer, use a commercially available USB cable to connect it to the keyboard.

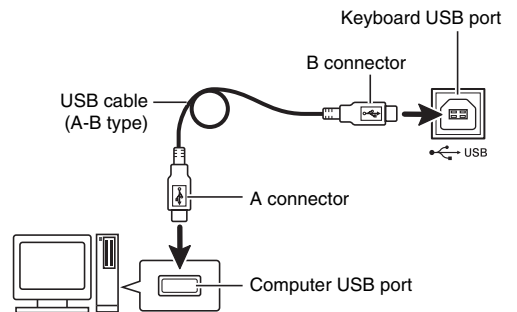

3. Turn on the keyboard.

- If this is the first time you are connecting the keyboard to your computer, the driver software required to send and receive data will be installed on your computer automatically.

4. Start up your computer's music software.

5. Configure the music software settings to select one of the following as the MIDI device.

CASIO USB-MIDI: (For Windows Vista, Mac OS X)
 USB Audio Device: (For Windows XP)

- For information about how to select the MIDI device, see the user documentation that comes with the music software you are using.

IMPORTANT!

- Be sure to turn on the keyboard first before starting up your computer's music software.
- USB send and receive is disabled during playback of a Song Bank song (page E-15).

NOTE

- Once you are able to connect successfully, there is no problem with leaving the USB cable connected when you turn off your computer and/or keyboard.
- This Digital Keyboard conforms to General MIDI Level 1 (GM).
- For detailed specifications and connections that apply to MIDI data send and receive by this keyboard, see the latest support information provided by the website at the following URL.
<http://world.casio.com/>

MIDI Settings

Keyboard Channel

A keyboard channel is the channel used for sending Digital Keyboard data to a computer. You can select the channel you want for sending Digital Keyboard data to a computer.

1. Press **Ⓢ** a number of times until "Keybd Ch" appears on the display (page E-4).



2. Use the **Ⓢ** (10-key) [-] and [+] keys to change the keyboard channel.

Navigate Channels

The navigate channels can be used to display only the notes of a particular channel (part) as on-screen guide information from among the note information of a tune sent from the computer.

■ Specifying the Navigate Channels

From among the 16 available channels (numbered 1 to 16), you can specify any two neighboring channels (such as 05 and 06) as navigate channels. The smaller numbered channel is the navigate (L) channel, while the larger numbered channel is the navigate (R) channel. Specifying the navigate (R) channel will automatically configure the navigate (L) channel as well.

1. Press **Ⓢ** a number of times until "Navi. Ch" appears on the display (page E-4).



2. Use the **Ⓢ** (10-key) to specify the navigate (R) channel.

This also will automatically configure the next lower channel number as the navigate (L) channel.

Turning Off the Navigate Channel Sound and Playing the Part on the Keyboard

You can turn off the sound on one or both of the navigate channels and play the cancelled part on the keyboard yourself.

1. Press **F11** to select the channel setting you want to turn off.

Each press of **F11** cycles through settings (1) through (4) described below.

- If you turn off one channel, you can play the cancelled part on the keyboard using the same tone as the channel you turned off. If you turn off both channels (option (3)), what you play on the keyboard sounds using the tone of the navigate (R) channel.

Selected channel indicator appears.

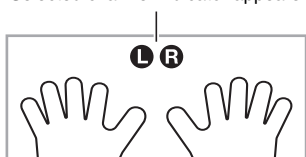

	Navigate (L) Channel		Navigate (R) Channel	
	Sound	On-screen Guide	Sound	On-screen Guide
(1) R only displayed	○	×	×	○
(2) L only displayed	×	○	○	×
(3) LR displayed	×	○	×	○
(4) LR nor displayed	○	○	○	○

Local Control

There are times when exchanging data with a computer when you may not want the Digital Keyboard to sound notes you play on its keyboard. The local control setting lets you do just that.

1. Press **F3** a number of times until “Local” appears on the display (page E-4).



2. Use the **F13** (10-key) [-] and [+] keys to specify the local control setting.

Accomp Out

Enabling the Accomp Out setting causes Auto Accompaniment data to be sent to the computer.

1. Press **F3** a number of times until “AcompOut” appears on the display (page E-4).



2. Use the **F13** (10-key) [-] and [+] keys to turn Accomp Out on or off.

Connecting to Audio Equipment

This keyboard can be connected to commercially available stereo, amplifier, or recording equipment, to a portable audio player or other equipment.

Outputting Keyboard Notes to Audio Equipment

Connection requires commercially available connecting cords, supplied by you. The connecting cords should have a stereo standard plug on one end and a plug that matches the configuration of the external device on the other end.

IMPORTANT!

- **Turn off the external device when making connections. After connecting, turn down the keyboard and external device volume levels whenever turning power on or off.**
- **After connecting, turn on the Digital Keyboard and then the external device.**
- **If keyboard notes sound distorted when they are sounded from external audio equipment, lower the keyboard's volume setting.**

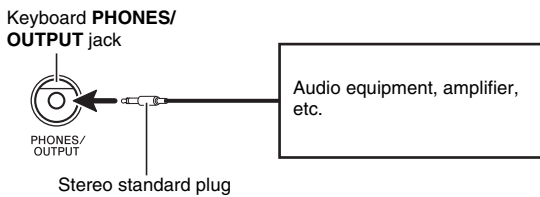

Playing an External Device from the Keyboard

Connection requires commercially available connecting cords, supplied by you. The connecting cords should have a stereo mini plug on one end and a plug that matches the configuration of the external device on the other end.

IMPORTANT!

- **Turn off the keyboard when making connections. After connecting, turn down the keyboard and external device volume levels whenever turning power on or off.**
- **After connecting, turn on the external device and then the Digital Keyboard.**
- **If notes are distorted when they are sounded on the external device, lower the volume setting of the external device.**

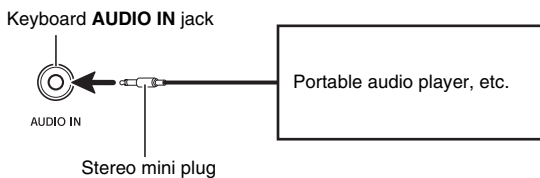

Troubleshooting

Symptom	Action
Included Accessories	
I can't find something that should be here.	Carefully check inside all of the packing materials.
Power Requirements	
Power will not turned on.	<ul style="list-style-type: none"> • Check the AC adaptor or make sure that the batteries are facing correctly (page E-5). • Replace the batteries with new ones or switch over to AC adaptor power (page E-5).
The Digital Keyboard outputs a loud sound and then suddenly powers down.	Replace the batteries with new ones or switch over to AC adaptor power (page E-5).
The Digital Keyboard suddenly powers down after a few minutes.	This happens when Auto Power Off (page E-6) is triggered.
Display	
The display keeps going out or are flashing.	Replace the batteries with new ones or switch over to AC adaptor power (page E-5).
On-screen keyboard keys or notes remain on the display.	A Step Up Lesson is in progress and the Digital Keyboard is waiting for you to play the next note in the song. To stop this from happening, cancel the lesson (page E-21).
Screen contents are visible only from straight ahead.	This is dues to production limitations. It does not indicate malfunction.
Sound	
Nothing happens when I press any keyboard key.	<ul style="list-style-type: none"> • Adjust the main volume setting (page E-6). • Check if something is plugged into the PHONES/OUTPUT jack (🔊) on the back of the Digital Keyboard. • Turn power off and then back on to initialize all keyboard settings (page E-6).
Nothing happens or notes do not play normally when I play notes on the left side of the keyboard.	Press ⏸ to disable chord input in the accompaniment keyboard area (page E-28).
Nothing happens when I start an Auto Accompaniment.	<ul style="list-style-type: none"> • With rhythms 140, and 142 to 150, nothing will sound until you play a chord on the keyboard. Try playing a chord (page E-28). • Check and adjust the accompaniment volume setting (page E-31). • Turn power off and then back on to initialize all keyboard settings (page E-6).
Nothing happens when I start playback of a built-in song.	<ul style="list-style-type: none"> • It takes a little time after you press the button until the song starts to play. Wait for a moment for the song to start. • Check and adjust the song volume (page E-17). • Turn power off and then back on to initialize all keyboard settings (page E-6).
The metronome does not sound.	<ul style="list-style-type: none"> • Check and adjust the accompaniment volume setting (page E-31). • Check and adjust the song volume (page E-17). • Turn power off and then back on to initialize all keyboard settings (page E-6).
Notes keep sounding, without stopping.	<ul style="list-style-type: none"> • Turn power off and then back on to initialize all keyboard settings (page E-6). • Replace the batteries with new ones or switch over to AC adaptor power (page E-5).

Symptom	Action
Some notes are cut off while they are playing.	Notes are cut off whenever the number of notes being sounded exceeds the maximum polyphony value of 48 (24 for some tones). This does not indicate malfunction. See "Maximum Polyphony" in the "Tone List" in the separate "Appendix".
The volume or tone setting I made has changed.	<ul style="list-style-type: none"> Adjust the main volume setting (page E-6). Turn power off and then back on to initialize all keyboard settings (page E-6). Replace the batteries with new ones or switch over to AC adaptor power (page E-5).
Output volume does not change even though is change my keyboard touch (CTK-3000 only).	<ul style="list-style-type: none"> Change the Touch Response setting (page E-7). Turn power off and then back on to initialize all keyboard settings (page E-6).
In certain keyboard ranges, the volume and tone quality sound are slightly different from those in other keyboard ranges.	This is due to system limitations. It does not indicate malfunction.
With some tones, octaves do not change at the far ends of the keyboard.	This is due to system limitations. It does not indicate malfunction.
The pitch of the notes does not match other accompanying instruments or sounds strange when played long with other instruments.	<ul style="list-style-type: none"> Check and adjust the transpose (page E-11) and tuning settings (page E-11). Turn power off and then back on to initialize all keyboard settings (page E-6).
The reverb of notes seems to change suddenly.	<ul style="list-style-type: none"> Check and adjust the reverb setting (page E-10). Turn power off and then back on to initialize all keyboard settings (page E-6).
Sounds I sampled were deleted.	Sampled data is deleted whenever keyboard power is turned off (page E-13).
Operation	
When I perform a skip forward or skip back operation, the skip operation moves multiple song measures instead of only a single measure.	While song playback is stopped or a Step Up Lesson is in progress, skip forward and skip back operations are performed in phrase units (page E-16).
Computer Connection	
I can't exchange data between the Digital Keyboard and a computer.	<ul style="list-style-type: none"> Check to make sure that the USB cable is connected to the keyboard and computer, and that the device is selected correctly with your computer's music software settings (page E-32). Turn off the keyboard and then exit the music software on your computer. Next, turn the keyboard back on and then restart the music software on your computer.

Specifications

Models	CTK-2000/CTK-3000
Keyboard	61 standard-size keys
Touch Response (CTK-3000 only)	2 types, Off
Maximum Polyphony	48 notes (24 for certain tones)
Tones	
Built-in Tones	400
Sampling Tones	1
	Sampling time: 1 second (fixed)
	Effects: 10 types
Reverb	1 to 10, Off
Metronome	
Beats per Measure	0, 2 to 6
Tempo Range	30 to 255
Song Bank	
Tunes	110
Step Up Lesson	
Lessons	4 (Listen, Watch, Remember, Auto)
Lesson Part	L, R, LR
Functions	Repeat, Voice Fingering Guide, Note Guide, Performance Evaluation
Music Challenge	20 notes
Auto Accompaniment	
Rhythm Patterns	150
Other Functions	
Transpose	±1 octaves (-12 to +12 semitones)
Tuning	A4 = approx. 440 Hz ±100 cents
MIDI	16 multi-timbre received, GM Level 1 standard
Musical Information Function	Tone, Rhythm, Song Bank, numbers and names; staff notation, fingering, pedal operation, tempo, measure and beat number, chord name, etc.
Pitch Bend Wheel (CTK-3000 only)	
Pitch Bend Range	0 to 12 semitones
Inputs/Outputs	
USB port	TYPE B
Sustain jack	Standard jack (sustain, sostenuto, soft, rhythm start/stop)
Phones/Output jack	Stereo standard jack
	Output Impedance: 200Ω, Output Voltage: 4.8V (RMS) MAX
Audio In jack	Stereo mini jack
	Input Impedance: 40kΩ, Input Sensitivity: 200mV
Power Jack	9V DC
Power Supply	2-way
Batteries	6 AA-size zinc-carbon batteries or alkaline batteries
Battery Life	Approximately 4 hours continuous operation on alkaline batteries
AC Adaptor	AD-5
Auto Power Off	Approximately 6 minutes after last key operation (Operates during battery use only)
Speakers	10cm × 2
Output	2W + 2W

Power Consumption	9V --- 7.7W
Dimensions	94.9 × 35.4 × 11.2 cm (37 ³ / ₈ × 13 ¹⁵ / ₁₆ × 4 ⁷ / ₁₆ inch)
Weight	CTK-2000: Approximately 3.8kg (8.4 lbs) (without batteries) CTK-3000: Approximately 3.9kg (8.6 lbs) (without batteries)

- Design and specifications are subject to change without notice.

Operating Precautions

Be sure to read and observe the following operating precautions.

■ Location

Avoid the following locations for this product.

- Areas exposed to direct sunlight and high humidity
- Areas subjected to temperature extremes
- Near a radio, TV, video deck, or tuner

The above devices will not cause malfunction of the product, but interference from the product can cause audio or video interference of a nearby device.

■ User Maintenance

- Never use benzene, alcohol, thinner, or other chemical agents to clean the product.
- To clean the product or its keyboard, wipe with a soft cloth moistened in a weak solution of water and a mild neutral detergent. Wring all excess moisture from the cloth before wiping.

■ Included and Optional Accessories

Use only accessories that are specified for use with this product. Use of unauthorized accessories creates the risk of fire, electric shock, and personal injury.

■ Weld Lines

Lines may be visible on the exterior of the product. These are “weld lines” that result from the plastic molding process. They are not cracks or scratches.

■ Musical Instrument Etiquette

Always be aware of others around you whenever using this product. Be especially careful when playing late at night to keep the volume at levels that do not disturb others. Other steps you can take when playing late at night are closing the window and using headphones.

Song List





















































































SONG BANK

WORLD	
001	TWINKLE TWINKLE LITTLE STAR
002	LIGHTLY ROW
003	LONG LONG AGO
004	ON TOP OF OLD SMOKEY
005	SAKURA SAKURA
006	WHEN THE SAINTS GO MARCHING IN
007	AMAZING GRACE
008	AULD LANG SYNE
009	COME BIRDS
010	DID YOU EVER SEE A LASSIE?
011	MICHAEL ROW THE BOAT ASHORE
012	DANNY BOY
013	MY BONNIE
014	HOME SWEET HOME
015	AURA LEE
016	HOME ON THE RANGE
017	ALOHA OE
018	SANTA LUCIA
019	FURUSATO
020	GREENSLEEVES
021	JOSHUA FOUGHT THE BATTLE OF JERICHO
022	THE MUFFIN MAN
023	LONDON BRIDGE
024	UNDER THE SPREADING CHESTNUT TREE
025	SIPPIN' CIDER THROUGH A STRAW
026	GRANDFATHER'S CLOCK
027	ANNIE LAURIE
028	BEAUTIFUL DREAMER
029	IF YOU'RE HAPPY AND YOU KNOW IT, CLAP YOUR HANDS
030	MY DARLING CLEMENTINE
031	LITTLE BROWN JUG
032	HOUSE OF THE RISING SUN
033	SHE WORE A YELLOW RIBBON
034	YANKEE DOODLE
035	MY OLD KENTUCKY HOME
036	SZLA DZIEWECZKA
037	TROIKA
038	WALTZING MATILDA
039	ON THE BRIDGE OF AVIGNON
040	I'VE BEEN WORKING ON THE RAILROAD
041	OH! SUSANNA
042	CAMPTOWN RACES
043	JEANNIE WITH THE LIGHT BROWN HAIR
044	TURKEY IN THE STRAW
045	JAMAICA FAREWELL

EVENT	
046	SILENT NIGHT
047	WE WISH YOU A MERRY CHRISTMAS
048	JINGLE BELLS
049	JOY TO THE WORLD
050	O CHRISTMAS TREE
PIANO/CLASSICS	
051	MARY HAD A LITTLE LAMB
052	LE CYGNE FROM "LE CARNAVAL DES ANIMAUX"
053	JE TE VEUX
054	SONATA op.13 "PATÉTIQUE" 2nd Mov.
055	HEIDENRÖSLEIN
056	AIR FROM "SUITE no.3"
057	SPRING FROM "THE FOUR SEASONS"
058	HABANERA FROM "CARMEN"
059	BRINDISI FROM "LA TRAVIATA"
060	HUNGARIAN DANCES no.5
061	MINUET IN G MAJOR
062	MUSETTE IN D MAJOR
063	GAVOTTE (GOSSEC)
064	ARABESQUE (BURGMÜLLER)
065	CHOPSTICKS
066	DECK THE HALL
067	ODE TO JOY
068	AVE MARIA (GOUNOD)
069	SONATINA op.36 no.1 1st Mov.
070	PRELUDE op.28 no.7 (CHOPIN)
071	RÊVERIE
072	GYMNOPIÉDIES no.1
073	GOING HOME FROM "FROM THE NEW WORLD"
074	FÜR ELISE
075	TURKISH MARCH (MOZART)
076	SONATA op.27 no.2 "MOONLIGHT" 1st Mov.
077	ETUDE op.10 no.3 "CHANSON DE L'ADIEU"
078	THE ENTERTAINER
079	WEDDING MARCH FROM "MIDSUMMER NIGHT'S DREAM"
080	AMERICAN PATROL
081	FRÖHLICHER LANDMANN
082	LA CHEVALERESQUE
083	SONATA K.545 1st Mov.
084	LA PRIÈRE D'UNE VIERGE
085	VALSE op.64 no.1 "PETIT CHIEN"
086	LIEBESTRÄUME no.3
087	JESUS BLEIBET MEINE FREUDE
088	CANON (PACHELBEL)
089	SERENADE FROM "EINE KLEINE NACHTMUSIK"
090	MARCH FROM "THE NUTCRACKER"
EXERCISE	
091-100	EXERCISE I
101-110	EXERCISE II

Chord Chart

Root \ Chord Type	M	m	7	m7	dim7	M7	dim	m7 ⁻⁵
C								
C [♯] /(D [♭])								
D								
(D [♯])/E [♭]								
E								
F								
F [♯] /(G [♭])								
G								
(G [♯])/A [♭]								
A								
(A [♯])/B [♭]								
B								

Root \ Chord Type	aug	sus4	7sus4	m add9	mM7	7-5	add9
C							
C [♯] /(D [♭])							
D							
(D [♯])/E [♭]							
E							
F							
F [♯] /(G [♭])							
G							
(G [♯])/A [♭]							
A							
(A [♯])/B [♭]							
B							

MIDI Implementation Chart

Function	Transmitted	Recognized	Remarks
Basic Channel Default Changed	1 1 - 16	1 - 16 1 - 16	
Mode Default Messages Altered	Mode 3 X * * * * * * * * * *	Mode 3 X * * * * * * * * * *	
Note Number True voice	36 - 96 * * * * * * * * * *	0 - 127 0 - 127 *1	
Velocity Note ON Note OFF	0 9nH v = 100 (CTK-2000) 1 - 127 (CTK-3000) X 9nH v = 0	0 9nH v = 1 - 127 X 9nH v = 0, 8nH V = **	** : no relation ** : sin relación
After Touch Key's Ch's	X X	X O	
Pitch Bender	X (CTK-2000) O (CTK-3000)	O	
0, 32 1 6, 38 7 10 11 64	O X X (CTK-2000) O (CTK-3000) *2 O O X O *4	O (MSB only) O O *3 O O O O	Bank select Modulation Data entry Volume Pan Expression Hold 1
Control Change			

66 67 91 100, 101 120 121	O *4 O *4 X X (CTK-2000) O (CTK-3000) *2 X X O	O O O *3 O O O	Sostenuto Soft pedal Reverb send RPN LSB, MSB All sound off Reset all controller
Program Change : True #	O O	O O	
System Exclusive	O *5	O *6	
System Common : Song Pos : Song Sel : Tune	X X X	X X X	
System Real Time : Clock : Commands	O O	X X	
Aux Messages : Local ON/OFF : All notes OFF : Active Sense : Reset	X O X X	X O O X	
Remarks	<p>*1: Depends on tone *2: RPN : Pitch Bend Sensitivity (CTK-3000 only) *3: RPN : Pitch Bend Sensitivity, Fine Tune, Coarse Tune *4: In accordance with pedal effect setting. *5: Universal System Exclusive Message : Master Fine Tuning, Master Coarse Tuning, Reverb Time *6: Universal System Exclusive Messages : GM System On/Off, Master Fine Tuning, Master Coarse Tuning, Reverb Time</p> <ul style="list-style-type: none"> For details about footnotes 2, 3, 5, 6, see MIDI implementation at http://world.casio.com/. 		

Mode 1 : OMNI ON, POLY
Mode 3 : OMNI OFF, POLY

Mode 2 : OMNI ON, MONO
Mode 4 : OMNI OFF, MONO

O : Yes
X : No



This recycle mark indicates that the packaging conforms to the environmental protection legislation in Germany.

Esta marca de reciclaje indica que el empaquetado se ajusta a la legislación de protección ambiental en Alemania.

CASIO®

CASIO COMPUTER CO.,LTD.

6-2, Hon-machi 1-chome
Shibuya-ku, Tokyo 151-8543, Japan

 MA0811-B Printed in China
CTK2000/3000ES1B

Free Manuals Download Website

<http://myh66.com>

<http://usermanuals.us>

<http://www.somanuals.com>

<http://www.4manuals.cc>

<http://www.manual-lib.com>

<http://www.404manual.com>

<http://www.luxmanual.com>

<http://aubethermostatmanual.com>

Golf course search by state

<http://golfingnear.com>

Email search by domain

<http://emailbydomain.com>

Auto manuals search

<http://auto.somanuals.com>

TV manuals search

<http://tv.somanuals.com>