

**Cateye**  
FITNESS



# Cateye Ergometer

MODEL EC-C400R

Instruction Manual



**Cateye**  
FITNESS

RECUMBER-C400R

# HOW TO USE THIS MANUAL

After first reading the "Start Guide," assemble the machine and give the Model EC-C400R Ergometer type Cat eye Fitness a try.











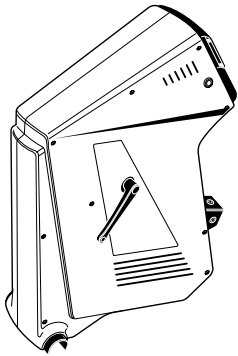

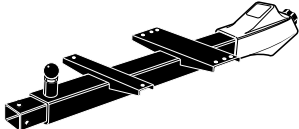

Once you've become accustomed to the machine, read the "Operation Guide" and experiment with the EC-C400R's wealth of functions.

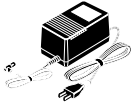
Make use of the "Reference Guide" as needed.

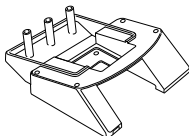
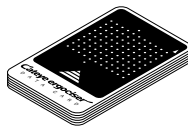
## CONTENTS

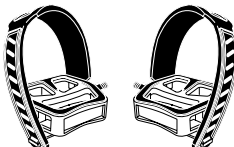
Start Guide	Operation Guide	Reference Guide
1 Starting with assembly ..... 7	1 Training goals ..... 24	1 Chest-belt heart rate sensor ..... 46
2 How to adjust each part ..... 10	2 Your strength level and training index ..... 26	2 Other useful functions ..... 48
3 Adapting the pulse sensor ..... 12	3 Fitness test ..... 28	3 Troubleshooting ..... 49
4 Trying out the EC-C400R for the first time ..... 13	4 Fitness test (2) ..... 30	4 Daily maintenance/repair service warranty/additional parts ..... 50
5 The 6 kinds of programs ..... 16	5 HR control training ..... 32	5 Product specifications ..... 51
6 Using the EC-C400R without a data card ..... 18	6 Constant wattage control training ..... 34	
	7 Hill training ..... 36	
	8 Interval training ..... 38	
	9 Quick start ..... 40	
	10 How to make a data card ..... 42	

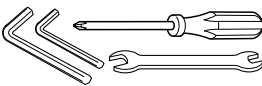
Check that you have all the parts.

 <p>Main body</p>	 <p>Rear support pipe</p>	 <p>Front and rear legs</p>	 <p>Seat pipe, Inner pipe</p>		
	 <p>Seat</p>	 <p>Control unit</p>	 <p>Sensor clip</p>	 <p>AC adapter</p>	
 <p>Handlebar</p>	 <p>Control unit base</p>	 <p>Data card (10) Start card (1)</p>	 <p>Pulse sensor</p>	 <p>Grip</p>	
 <p>Pedals (L,R)</p>	 <p>Operating Instructions Warranty card</p>	 <p>Tools</p>	 <p>Mounting screws (4 large, 4 small)</p>		

# INTRODUCTION

Thank you very much for your purchase of the Model EC-C400R Cateye Ergometer. The model EC-400R is a new high-tech exerciser with a built-in computerized training system designed specifically to promote cardiovascular fitness and overall endurance, the keystone of good health. With its endurance test program and four training programs, the EC-C400R will help you to maintain or improve your physical strength in a fun and pleasant way. We hope you will make good use of your Cateye Ergometer for years to come.

Before using your new exerciser, please read this manual carefully. Then store it in a safe place along with the warranty card.

## Symbol marks used for safety precautions in this manual

The descriptions accompanying the following symbol marks in this manual refer to very important matters in terms of your safety and handling of the unit.

You are strongly urged to observe these precautions.

 **Warning** Failure to observe this warning could result in serious injury or death.

 **Caution** Failure to observe this warning could result in physical injury or damage to the EC-C400R.

**Important** Operations which require caution, items which should be observed in particular as well as certain additional information are presented in this manual.

**Reference** This symbol mark denotes helpful information or associated items.















# FOR SAFE OPERATION

For safe use, always observe the following rules.

## WARNING

- Before using the EC-C400R, it is important to consult a medical specialist if you are suffering from any of the following: heart disease (angina pectoris, myocardial infarction), hypertension, diabetes, respiratory disease (asthma, chronic bronchitis, pulmonary emphysema, etc.), articular metamorphosis, rheumatism, gout, or other diseases and physical complaints. Pregnant women should also consult their doctor before commencing a training program.
- If you are not used to regular physical activity, it may be dangerous to suddenly engage in strenuous activity. Increase your exercise level gradually.
- If you feel sick or sense something is wrong with your body during exercise, stop immediately.
- Close supervision is necessary when this exerciser is used by, or near children, persons in poor health, or disabled persons.

## CAUTION

- |   |   |
|---|---|
|  <p>Always unplug from the electrical outlet immediately after using and before cleaning. Do not leave plugged in.</p>   |  <p>Never operate the exerciser with the air vents blocked. Keep the air vents free of lint, hair, and the like.</p>   |
|  <p>Turn all controls to the off position before removing the plug from the outlet. Remove the plug without pulling the cord.</p>  |  <p>Never drop or insert any object into an opening.</p>   |
|  <p>Do not operate where aerosol (spray) products are being used or where oxygen is being administered.</p>  |  <p>Avoid using the unit in manners other than those described in this manual. When repairing the unit, be sure to use genuine parts for Cateye EC-C400R only.</p> |
|  <p>Keep the cord away from heated surfaces.</p>   |  <p>Avoid using or storing the unit outdoors or in areas where it is exposed to direct sunlight.</p>   |
|     <p>Do not use the unit if the cord or plug is damaged, when the unit does not operate normally, when it has been dropped or damaged, or when it is wet. If such events have occurred, contact our authorized dealer in your location.</p> |  <p>Do not use the unit in areas where temperature or humidity are high.</p>   |
|   |  <p>Do not touch the main unit or plug if your hands are wet.</p>  |
|   |  <p>Close supervision is necessary when this exerciser is used by, or near children, persons in poor health, or disabled persons.</p>                              |

This equipment has been certified to comply with the limits for a Class B computing device, pursuant to Subpart J of Part 15 of FCC Rules. Only peripherals (computer input/output devices, terminals, printers, etc.) certified to comply with the Class B limits may be attached to this computer. Operation with non-certified peripherals is likely to result in interference to radio and TV reception.

# PART NAMES

## Main body

## Control unit

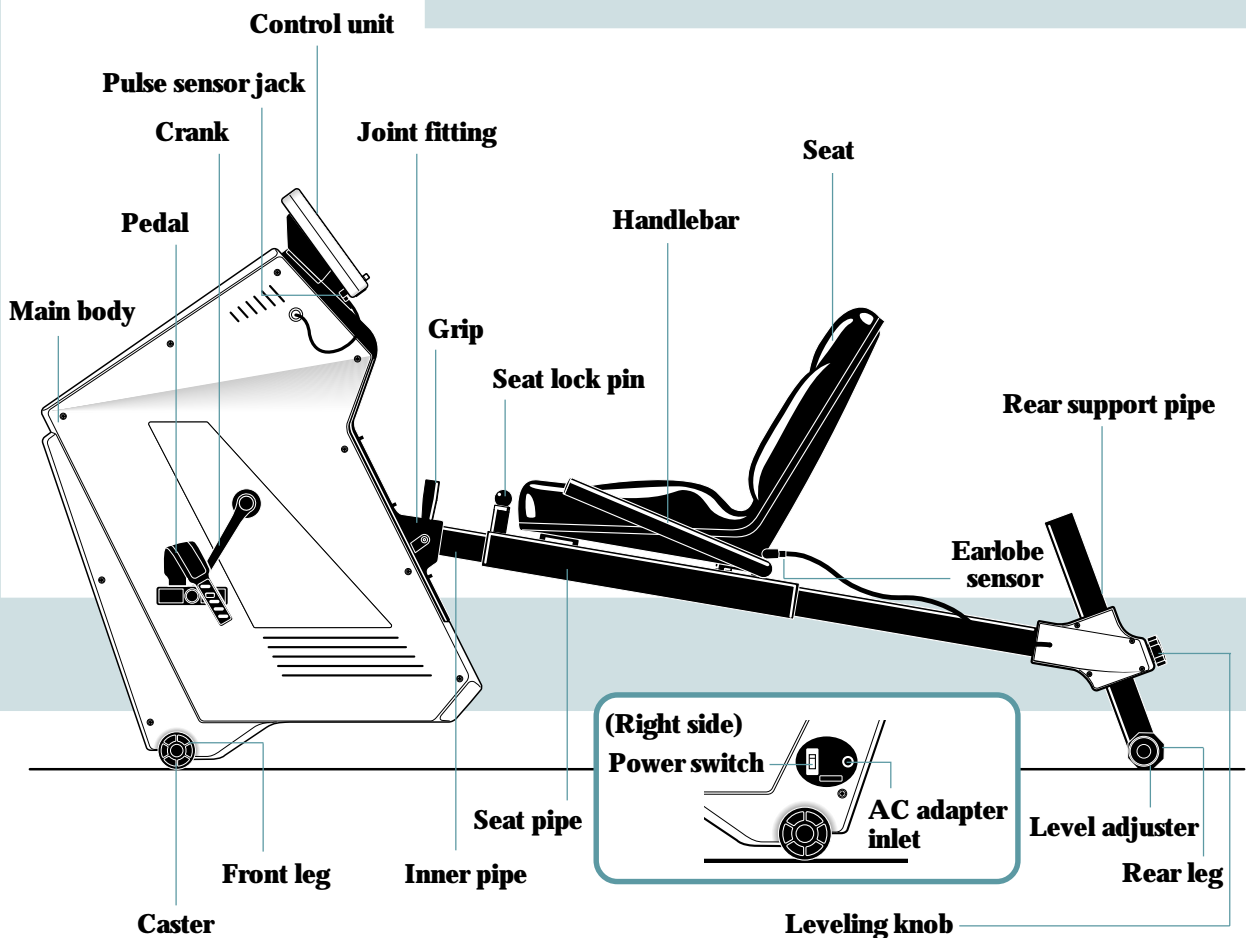
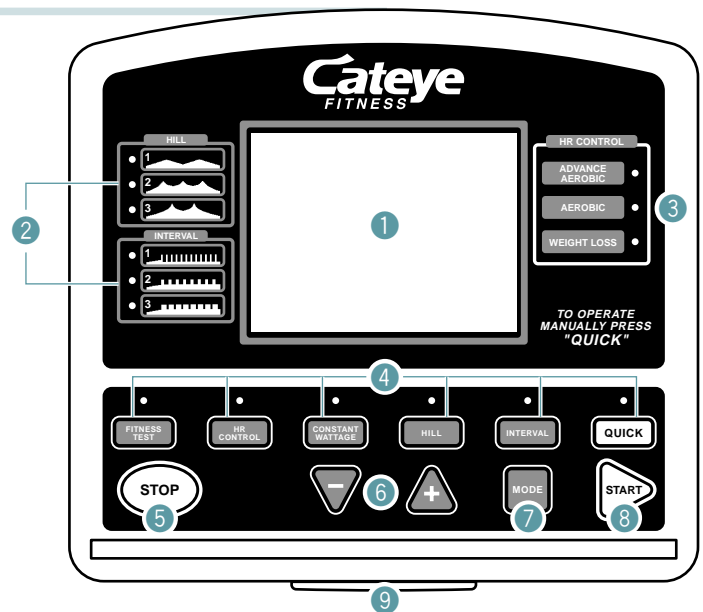
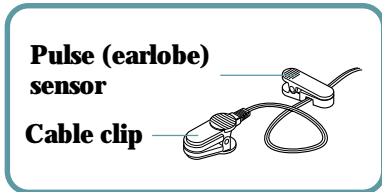

**1 Liquid crystal display (LCD)**

**2 Pattern display**

When Hill training or Interval training have been selected, the pattern (hill shape or training interval) which is set is indicated by a lamp.

**3 Target pulse**

Lights and displays the target pulse when the HR control training has been selected.

**4 Training select buttons**

FITNESS TEST .. Fitness test is selected.  
HR CONTROL ... HR control training is selected.  
CONSTANT  
WATTAGE ..... Constant wattage control training is selected.  
HILL ..... Hill training is selected.  
INTERVAL ..... Interval training is selected.  
QUICK ..... Quick start training is selected.

**5 STOP button**

Skips the cool-down phase, or ends the program.

**6 Number +/- buttons**

When entering data:  
Used to increase or decrease the numeric value or to select an item.

During exercise:  
Used to increase or decrease the pedal torque (resistance) or wattage.

When the training program finishes:  
Used to scroll an exercise graph to assess the training history.

**7 MODE button**

When entering data:  
Used to go to the next item in the condition settings. Pressing this button when the check display is in view reverts to the initial display.

During exercise, or when an exercise program finishes:  
Used to switch the numeric value display at the right-hand side of the display.

**8 START button**

Sends the program to the next stage.

**9 Card slot (Safety key slot)**

Insert a data card.  
Insert the safety key when the safety key function is activated.

**LCD**

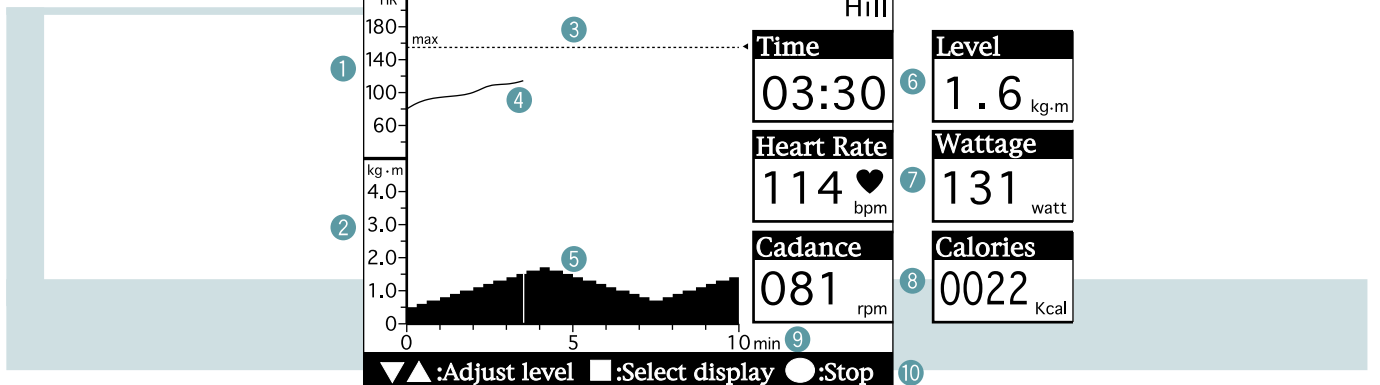

**1 Pulse Scale (pulse/minute)**

**2 Load Scale (Pedal Resistance) (kg·m)**

**3 Upper Pulse Limit**

The upper pulse limit determined by your age is displayed.

**4 Pulse Graph**

**5 Load Graph (Pedal Resistance)**

**6 Exercise Time**

Pressing the MODE [MODE] button switches to the loading level (pedal resistance) display.

**7 Pulse (bpm: pulse/minute)**

Pressing the MODE [MODE] button switches to the wattage display.

**8 Pedal Cadance (rpm)**

Pressing the MODE [MODE] button switches to the consumed calories display.

**9 Time Scale (minute)**

**10 Button navigation**

Pressing a particular button brings up the corresponding information.

# STARTING UP

## START GUIDE

<b>1</b>	<b>Starting with assembly .....</b>	<b>7</b>
<b>2</b>	<b>How to adjust each part .....</b>	<b>10</b>
<b>3</b>	<b>Connecting the pulse sensor .....</b>	<b>12</b>
<b>4</b>	<b>Trying out the EC-C400R for the first time .....</b>	<b>13</b>
<b>5</b>	<b>The 6 kinds of programs .....</b>	<b>16</b>
<b>6</b>	<b>Using the EC-C400R without a data card .....</b>	<b>18</b>

# 1

## STARTING WITH ASSEMBLY

Follow the steps starting from the next page and assemble the unit as shown in the figure below.

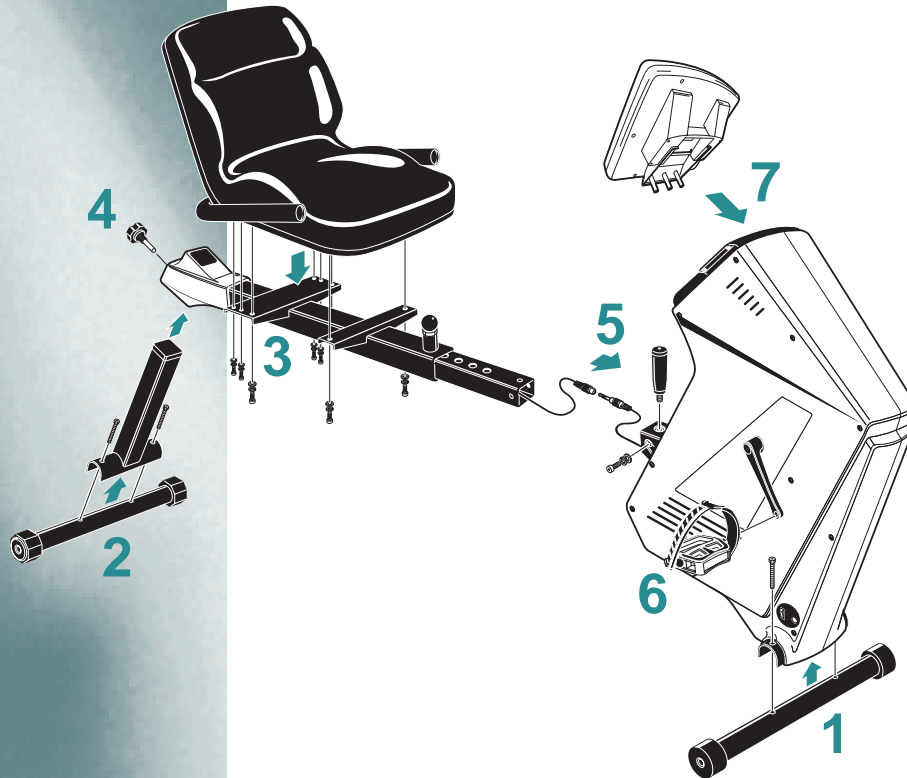

### 1 Mount the front leg.

- Remove the leg plate from the main unit. (This plate will not be used for assembly.)
- Place the front leg (with casters) under the main unit as shown in figure and fasten screws securely with the hexagon wrench making sure nuts locate at the bottom of the leg.

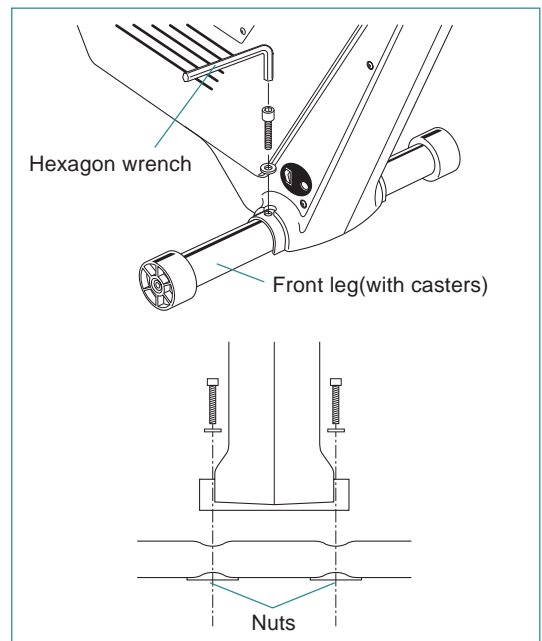

### 2 Mount the rear leg.

- Place the rear leg (with level adjuster) under the rear support pipe as shown in figure and fasten screws securely with the hexagon wrench making sure nuts locate at the bottom of the leg.

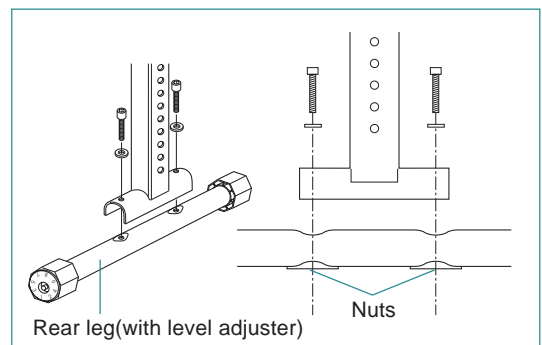

3

### Mount the seat and handlebar.

- Mount the seat to the seat pipe using the large screws and the handlebar using the small ones.

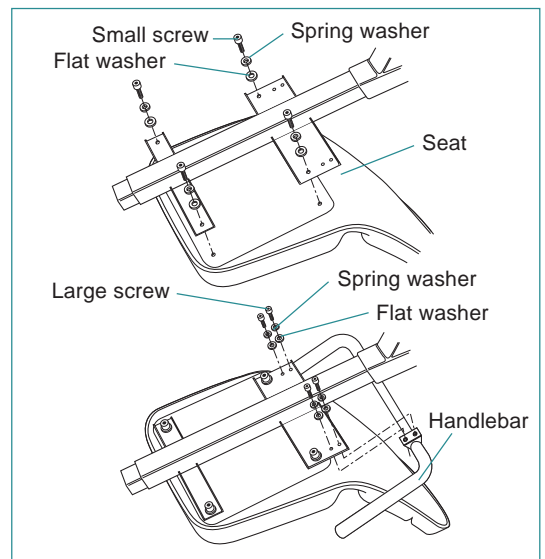

4

### Assemble the rear frame.

- Loosen and remove the seat height lock knob.
- Insert the rear support pipe into the socket of seat pipe. Select any height and tighten the knob.

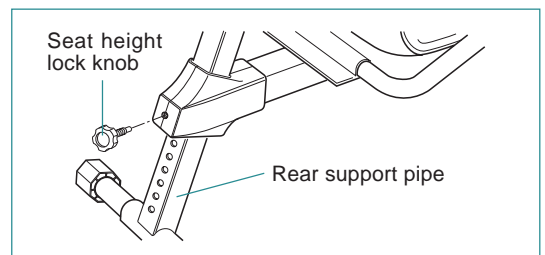

5

### Connect the Inner pipe.

- First, connect the pulse sensor cables.
  - Caution:** If the connection is incomplete, the pulse rate will not be displayed. Be sure to fully insert the connector.
- Insert the front end of the inner pipe into the joint of the main unit and fasten it securely with the two screws and the grip.

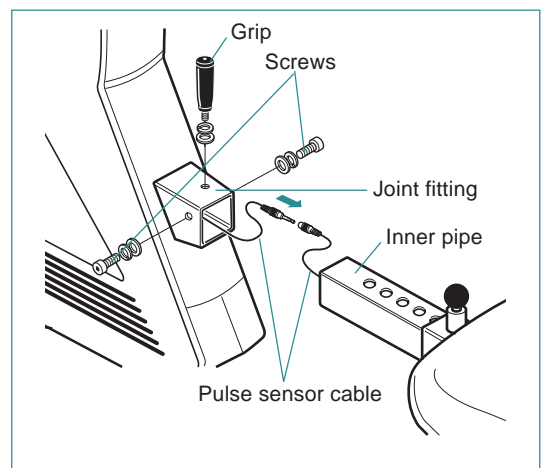

- Caution:**
  - To prevent the connected cord from becoming slack, bundle the cords into the inner pipe. If the pipe is inserted though the cord is not taut, the cord may get caught, result in disconnection.
  - When removing the inner pipe, ensure that two persons carry out this task. When removing the inner pipe, the pulse sensor cord may be pulled accidentally resulting in disconnection.

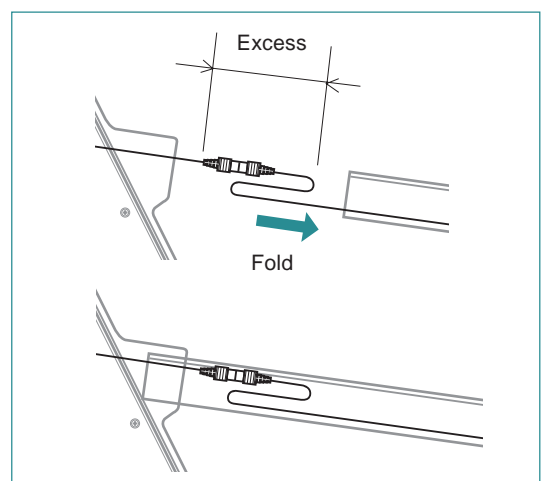



## 6

**Attach the pedals.**

- Use the No.15 end of the spanner to attach the pedals firmly to the cranks.
- The right and left pedals are different, so be sure to check for R and L marks.
- Tighten the right pedal by turning clockwise, and the left pedal by turning counterclockwise.

**Caution:** If the pedals are not attached firmly enough to the crank, they can cause an irritating noise. Be sure to attach them firmly.

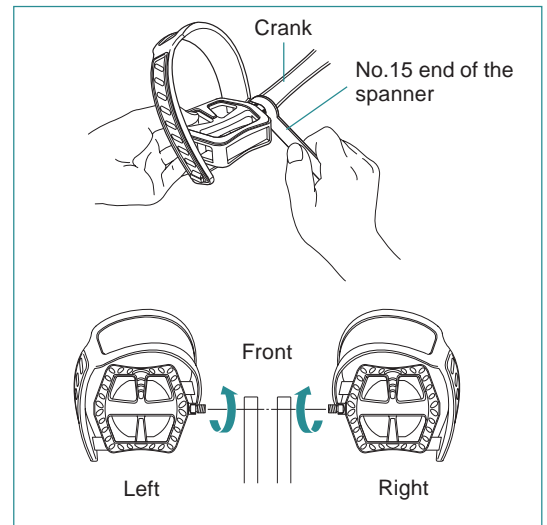

## 7

**Attach the control unit base to control unit.**

**Reference:** Units of weight, and units of pedaling resistance can be changed using the select switches at the back of the control unit. The settings before shipping are as follows; units of weight: lbs, and units of pedaling resistance unit: kg·m.

For information on the various settings which can be carried out with these switches, refer to the Reference section on page 48.

- Attach the control unit base to the back of the control unit as illustrated and fasten the base by the 4 screws.

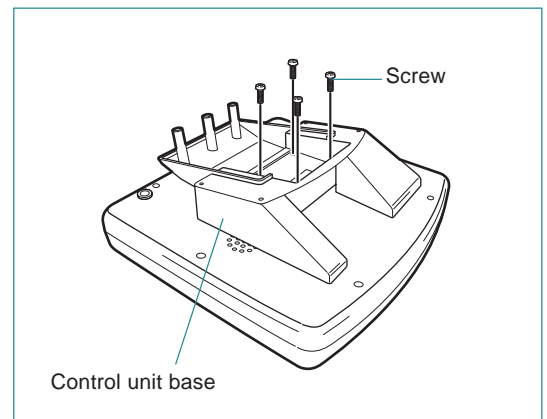

- Insert the cable connector coming out of the main unit into the cable inlet at the back of the control unit, until it clicks into place.

**Caution:** Ensure that the connector is completely connected. If the connection is insufficient the unit will not work.

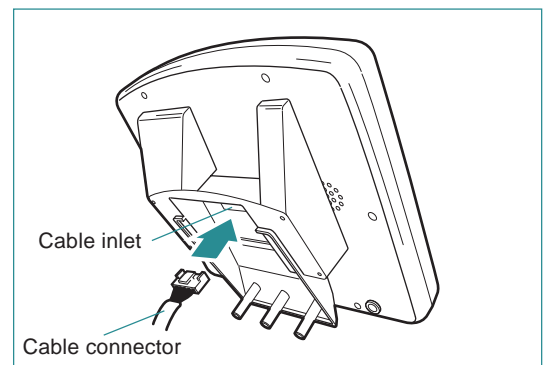

- Place the control unit on the main unit as illustrated and fasten it by the 4 screws.

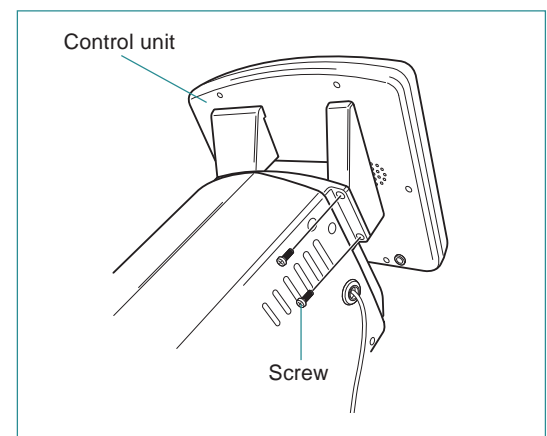

# 2 HOW TO ADJUST EACH PART

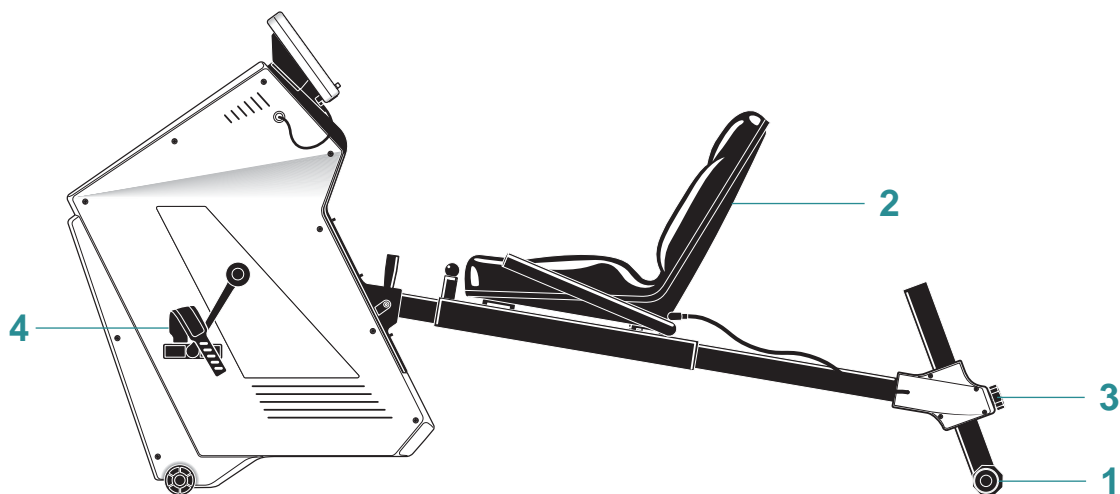

## 1 Level Adjustment

- Turn the level adjuster on the rear leg so that the unit is placed stably.
- When the indication line on the level adjuster is at the top, the rear leg is at the same level as the caster of the front leg.

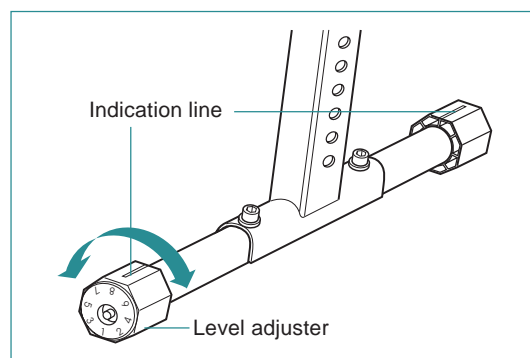

## 2 Adjust the seat position.

- Pull the seat slide lock pin to allow the seat to slide forward/backward sitting on the seat. When the seat reaches the desired position, release your hand from the seat slide lock pin and then attempt to move the seat slightly. The seat position can be adjusted while pulling up the seat lock pin. When desired seat position is obtained, release the lock pin free and move the seat slightly and the lock pin will click into the nearest hole by spring pressure. Holes are provided at an interval of 3 cm (1-3/16").

- Caution:**
- When adjusting the seat position, make sure to slide the seat while the grip is being held. If the seat is slid while the control unit is being held, the unit may be damaged.
  - When the seat height is set at a lower position, do not pull the spring lock pin while seated, as the seat may suddenly slide down backward.
  - When sliding the seat, take care not to break the pulse sensor cable.

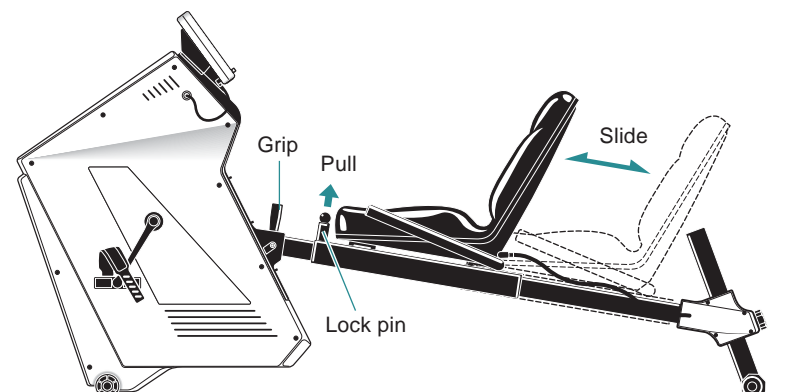

3

**Adjust the seat height.**

- The seat height can be adjusted at your choice.
- Loosen and remove the seat height lock knob, supporting the seat pipe with the other hand.
- Move up or down the seat pipe to the desired height and screw-in the seat height lock knob. While tightening the knob lift the seat pipe slightly for easier screwing. Holes are provided at an interval of 3 cm(1-3/16").

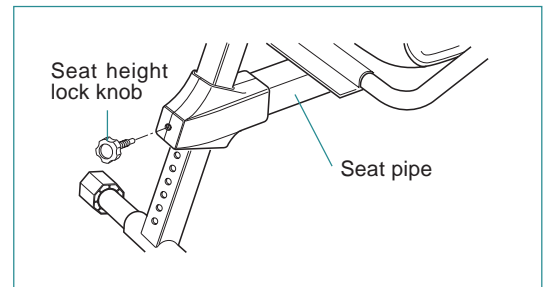

4

**Adjust the pedal belts.**

- It is possible to adjust the pedal belt length according to your shoes size.

5

**Recommended exercise posture.**

- Adjust the seat position as illustrated. Find the position where your knee is slightly bent when the pedal is at the farthest position.

**Caution:** When moving the main unit, lift the rear frame holding by the seat height lock knob, and roll the casters.

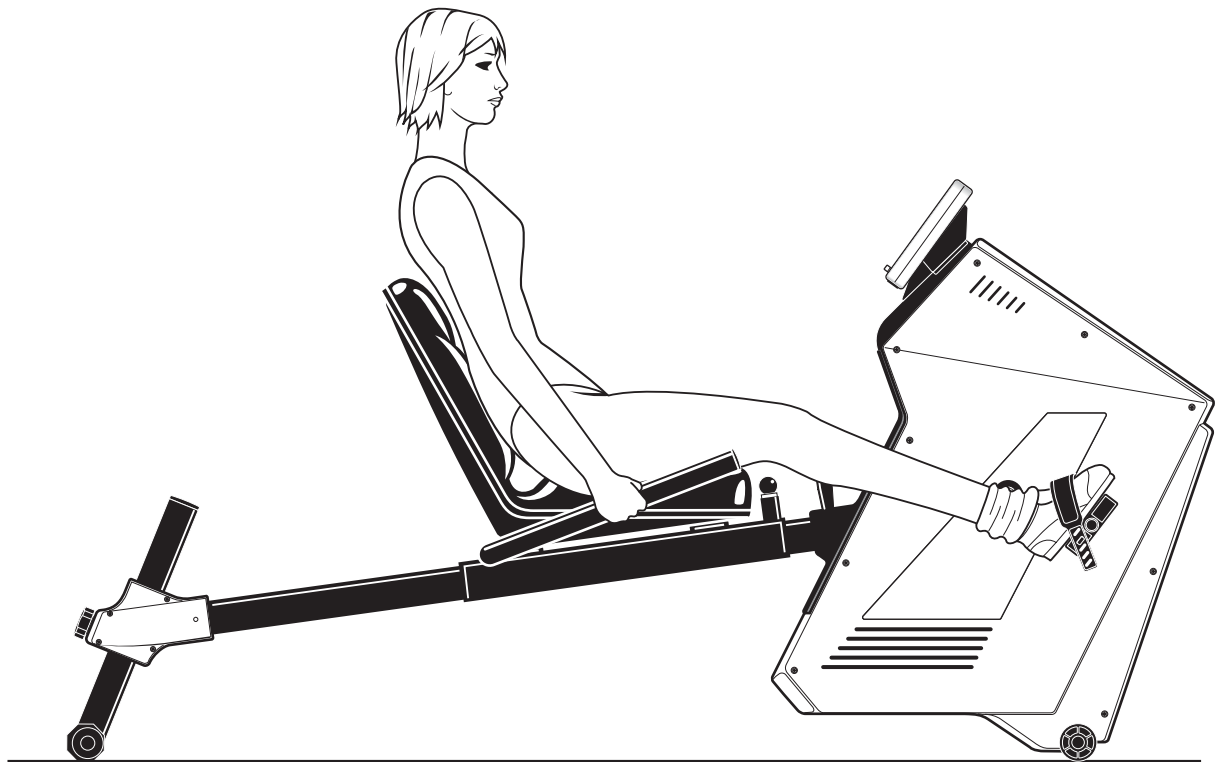

# 3

## CONNECTING THE PULSE SENSOR

This model detects and displays your pulse rate during exercise by the earlobe sensor from your earlobe. Being a sensitive electronic part, the earlobe sensor must be handled with sufficient care.

**Important:** When the chest-belt sensor is used, remove the earlobe sensor plug from the control unit. Signals from the chest-belt sensor cannot be received if the earlobe sensor is connected.

### 1 Connect the pulse sensor.

- Insert the plug of the cable (coming out of the left side of the main unit) into the pulse sensor jack at the back of the control unit.
- Insert the pulse sensor plug into the jack on the side of the inner pipe end cover.

**Caution:** If the plug is not pushed fully home, the pulse might not be measured correctly.

- Attach the sensor clip to the handlebar, clipping the sensor cable in position.

**Caution:** Pulling the pulse sensor with forth may result in disconnection. Handle the sensor carefully.

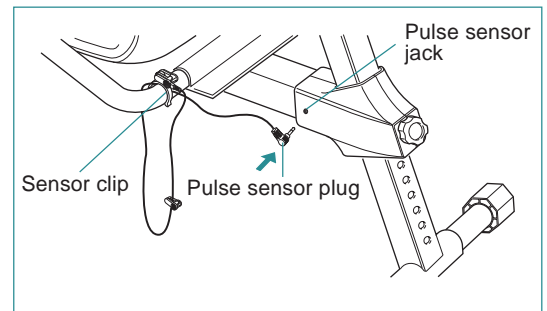
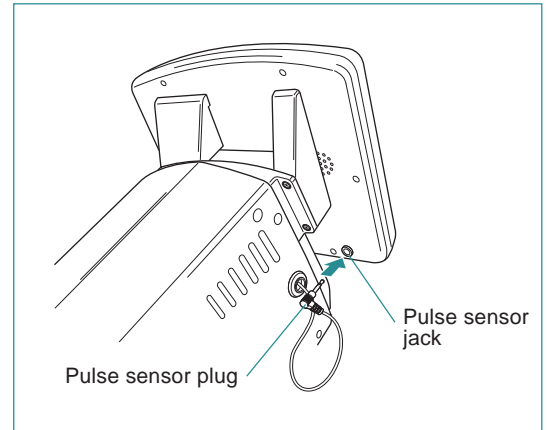
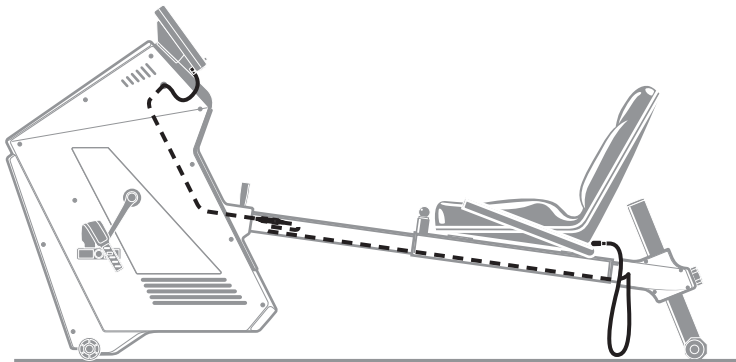

### 2 Use of sensor clip.

- Always clip the pulse sensor to the sensor clip when it is not being used. This sensor clip can also be used to adjust the slack of the cable.

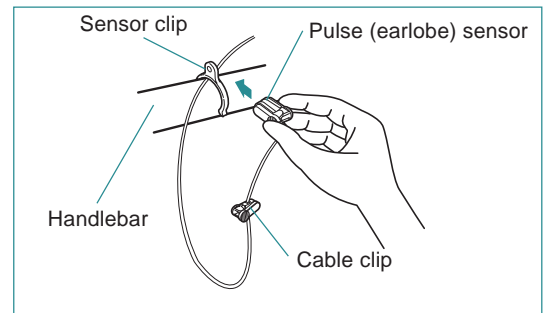

### 3 Use pulse (earlobe) sensor during exercise.

- Clip the pulse sensor at the center of your right or left earlobe.
- When it is cold, massage your earlobe before use to improve blood circulation.
- Attach the cable clip to your clothes to prevent excessive swinging of the sensor cable.
- Ear rings or other ornaments must be removed before attaching the sensor and during exercise.
- Try not to change the position of the pulse sensor during the exercise.
- When removing the pulse sensor after exercise, be sure to remove also the cable holder.

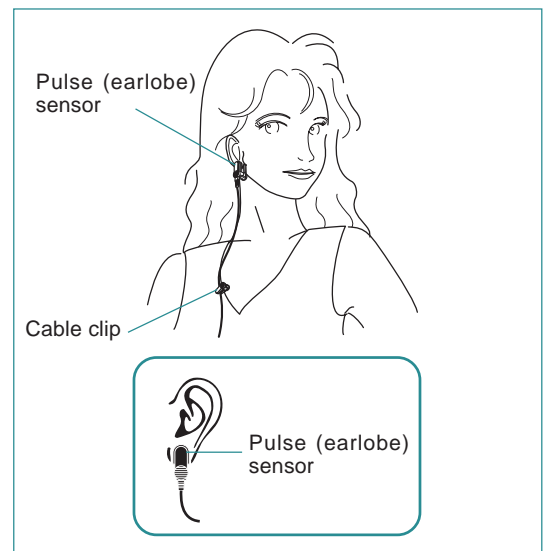

# 4

## TRYING OUT THE EC-C400R FOR THE FIRST TIME

### 1 Turn on power and attach earlobe sensor.

- Insert the AC adaptor into the AC adapter inlet at the rear of the exerciser.
- Insert the plug of the AC adaptor into any household AC outlet (120V).



#### Warning

Because of the danger of electric shock, do not insert the AC plug into an outlet if your hands are wet.

#### Caution:

- Do not use any AC adaptor other than the one supplied with the Model EC-C400R.
- Connect the power plug directly to a power socket, for example one on the wall. If two or more machines are connected using an extension cord, etc., a power voltage failure may occur and the machine may not operate properly.
- Turn on the power switch.
- The initial display appears and prompts you to insert the card or to select a training mode.
- Attach the earlobe sensor to your earlobe. When it is cold, rub your earlobe to facilitate blood circulation before attaching the earlobe sensor.

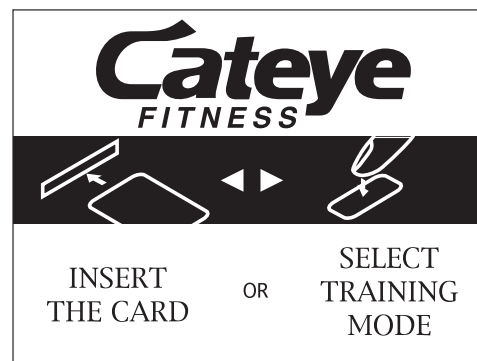
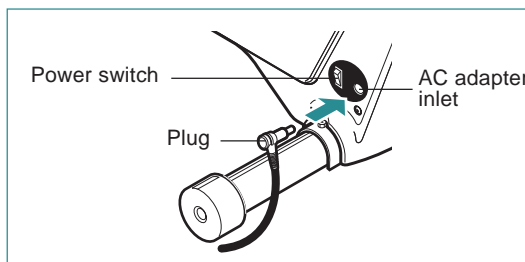

### 2 Insert the start card (the red card provided).

- Find the red card (start card) in the packaging of the exerciser. Insert this card into the slot of the control unit (card slot). If the card is inserted in the wrong direction, a card read error occurs and operation does not start. Make sure to insert the card in the direction shown in the diagram.

**Caution:** Use only the red card at this stage. It is a sample card with exercise data already stored in it. The unit will not work with the black cards since they do not contain any data yet.

- For information on how to make a data card, refer to page 42.

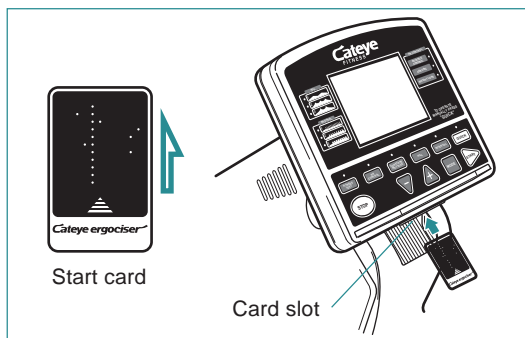

### 3 Check the screen display.

- The display on which the training conditions can be checked appears, as described below. The function of each button is shown at the bottom of the display.

**Important:** If this display does not appear or if a card error appears in the display, pull the card out and insert it again slowly.

**Reference:** Settings which have already been specified can be changed on the display. For now, however, the goal is get you acquainted with Model EC-C400R. Please proceed, therefore, to the following instructions. For information on how to change various settings, refer to “Using the EC-C400R without a data card” on page 18.

- The numeric values in the display represent various training condition settings.
  - 1 “Hill” shows the type of training program and is short for “Hill training” where the pedal load (i.e. resistance) changes automatically to simulate the effect of cycling in mountainous terrain.
  - 2 “Pattern 1” indicates the shape of the mountain to be climbed. “1” is the gentlest slope.
  - 3 “Age 50” is your age. For now, leave this setting as it is.
  - 4 “Exercise Time 16:00” is the exercise time of this training session. For now, leave this setting as it is.

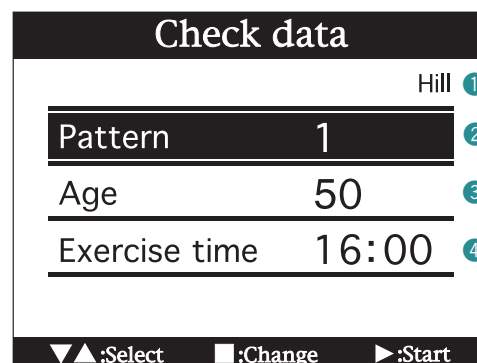

# 4

## Press the button to start.

- Press the  button.
- A buzzer sounds and the hill training display appears.
- “START” as well as a mountain-like shape appear in the display, signifying that the hill training session has started. Start pedaling slowly.

Starting exercise

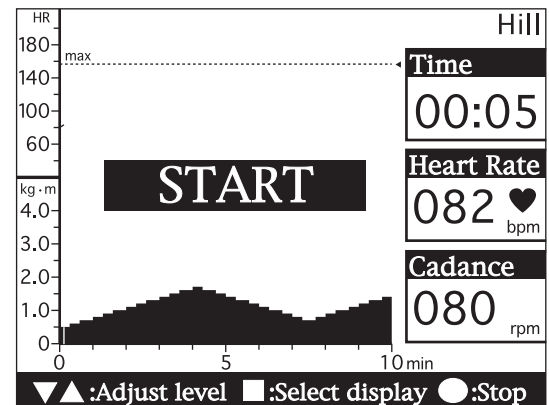
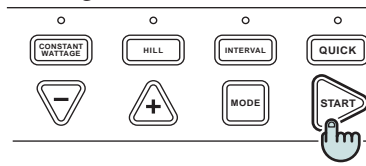

- This display shows various conditions as they apply to you during training.

## LCD

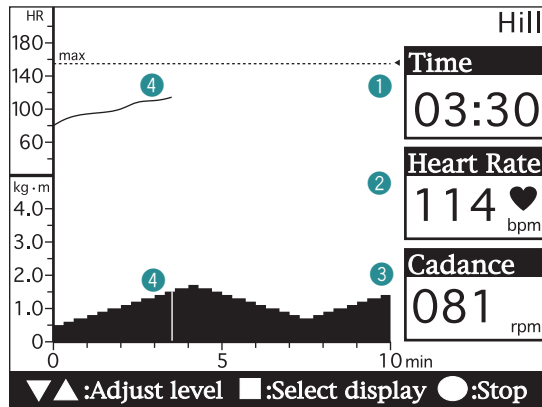

- 1 Elapsed time since start of training session
- 2 Pulse rate, per a minute
- 3 Revolutions, per minute, of the pedal cranks
- 4 Changes in pulse rate and pedal resistance are shown on the graph. As time elapses, the blinking point in the graph moves. When 10 minutes elapses, 5-minutes' worth of graphical data scrolls to the left. This accumulated data can be analyzed, via scrolling, after the training session has been completed.
- 5 Pressing the  button toggles between displays A and B.  
(A: exercise time, heart rate, pedal cadence, B: pedal loading level, wattage, consumed calories)

# 5

## Bring up the calories display by pressing **MODE** button

- Pressing the **MODE** button changes from the display with the exercise time, heart rate, and pedal cadence to that with the pedal loading level, wattage, and consumed calories. Pressing the **MODE** button again reverts to the first display.
- You are now on the exerciser for your first ride. As you train, the pedal resistance will change and accordingly your pulse rate will change. The EC-C400R Ergometer thus allows you to monitor all such information while you train.

Changing the display

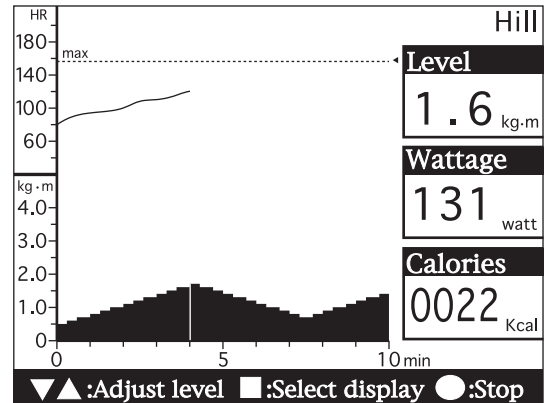
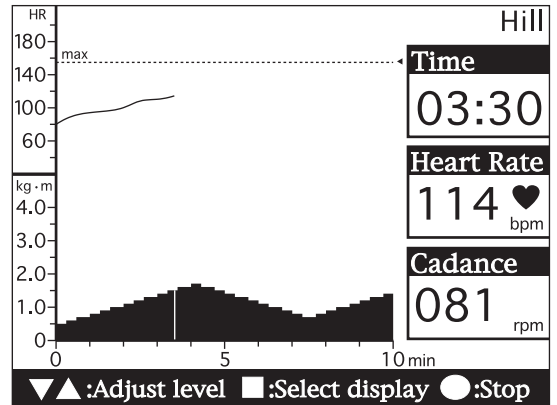
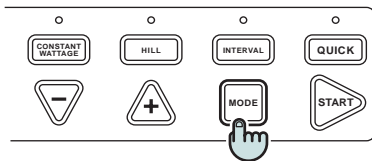

# 6

## Finish your training.

- After 16 minutes, a buzzer sounds, and the screen enters the cool-down phase.
  - Reference:** If you do not wish to complete the full 16-minute training session, you may stop the session at any time by pressing the **STOP** button. The cool-down phase starts when the **STOP** button is pressed.
- The cool-down phase lasts for five minutes. This can be skipped by pressing the **STOP** button at any time during the cool-down phase.
- When the 5-minute cool-down phase elapses or when the **STOP** button is pressed during that time, the training session finishes. The LCD does not go off even though the training session is now over. With regard to the graphic display of information related to the training session after 10 minutes, the information can be “scrolled” and viewed using the **-** and **+** buttons.
- Pressing the **STOP** button again ends the program and the initial display then reappears.

Finishing training

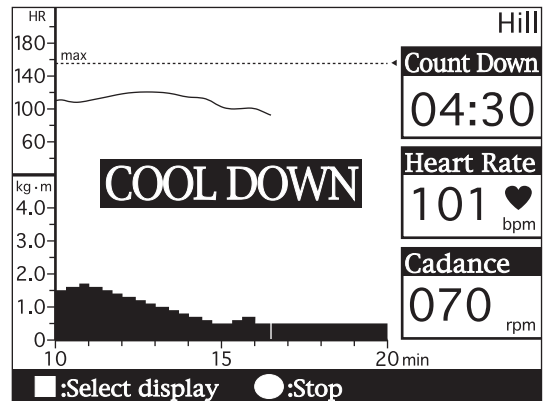
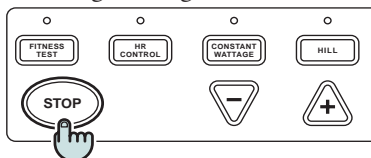

So far we have covered only the beginning of the Model EC-C400R Cateye Ergometer functions. Let us move on to an explanation of other functions.

### Fitness Test (physical fitness test)

- Over a period of 10 minutes, you will encounter three different levels of pedal resistance. Your pulse will change in response to the different levels of resistance, and this change in pulse will be used to calculate your overall fitness level, also expressed as MOU (VO<sub>2</sub> max). MOU stands for maximum oxygen uptake. The higher your overall fitness level, the greater your endurance.
- Your MOU value is compared with the MOU values of other people who are the same age and sex as you. You are given a physical strength number from 1 to 5 depending on how you rank.
- These results should give you a good idea of your own fitness level and help you to determine what sort of training program will be the most effective for you. For information on how to choose a training program, refer to “Your strength level and training index” on page 26~27 in the Operation section on this booklet.



### HR control training (training at a constant pulse rate)

- You set the pulse rate at which you want to exercise and the Ergometer automatically adjusts pedal resistance to maintain that pulse rate. This is an ideal basic form of aerobic training.
- As you repeat the exercise at a certain pulse rate and make progress in your fitness level, you will be able to create a greater work intensity under the same pulse rate. Further, you will be able to try exercising at a higher target pulse rate.



### Constant Wattage Control Training (training at a constant energy expenditure)

- The wattage (work intensity) shown on the screen of the Ergometer is calculated from pedal resistance (kg·m) and cadence (rpm).
- In constant wattage control training, you set the desired work intensity in wattage. The Ergometer automatically adjusts the pedal resistance (kg·m) depending on your pedal cadence (rpm), so as to keep a constant wattage (work intensity).
- This type of training is also called constant load, and is often used in cardio-vascular rehabilitation.

Control range:

cadence: 40~100 rpm

wattage: 25~200 watts

**Caution:** If you set your target wattage as under 50 watts, control limit of cadence (rpm) becomes under 100 rpm.



### Hill training ( training by cycling up mountains )

- Pedal resistance changes over time to simulate the effect of cycling in the mountains. All changes in pedal resistance are shown on the screen.
- The following three types of mountain profiles plus one customized pattern are programmed.

Pattern-1: the Rockies (U.S.A.)

Pattern-2: the Cascades (U.S.A.)

Pattern-3: the Pyrenees (France, Spain)

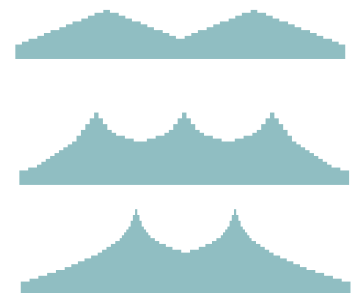

- The mountain profiles from 1 to 3 are arranged in order of ascending difficulty. Do not strain yourself, but rather enjoy the form of each mountain.
- The cycle time for a given pattern is 15 minutes. The same pattern is repeated in accordance with the exercise time.



## Interval training (exercise + relief periods)

- By switching back and forth between exercise and relief periods of varying length, interval training gives you the kind of program that professionals use to build their stamina and energy.
- On the Model EC-C400R, 3 patterns of interval training programs are preset for developing dashing power, speed, or your stamina respectively.

Pattern-1: dash strength training (sprint power)  
15 seconds exercise followed by a 45 second relief.



Pattern-2: speed training (anaerobic power)  
30 seconds of exercise followed by a 60 second relief.



Pattern-3: stamina training (aerobic power)  
60 seconds of exercise followed by a 30 second relief.



- Choose one of the above patterns, and adjust the level of intensity by specifying pedal resistance (torque:kg-m)
- During the exercise period (increased load portion of interval), you should pedal with your greatest effort, then you should pedal slower and lighter during relief period (lower load portion of interval).
- In the Pattern-3 stamina training program, it is advisable to pedal fast enough in the exercise period to keep your pulse rate at 60~80% of the maximum pulse rate for your age. (Refer to page 24~25)

## Quick start (training at any desired pedal resistance)

- You choose the pedal resistance (torque: kg-m), and it stays constant regardless of your pulse rate or pedal cadence. This is the most traditional way in which stationary bicycles have been used.

Torque setting range: 0.5~4.0 kg-m



Minimum graduation: 0.1 kg-m





### When the upper pulse limit alarm occurs

**Caution:** If your heart rate reaches the upper limit, an alarm sounds and “STOP EXERCISE” blinks in the display. Accordingly, the pedal resistance reaches the minimum and the program terminates forcibly.

### Checking the progress of the training session

After training, you can check the progress of the training session just completed. If the exercise time is longer than 10 minutes, all graphical information can be displayed by scrolling the data using the  and  buttons.

 button: Used to scroll the display rightward for 5-minutes' worth of data.

 button: Used to scroll the display leftward for 5-minutes' worth of data.

Pressing the  button to end the program deletes data for the training session from the memory of the exerciser.

# 6

## USING THE EC-C400R WITHOUT A DATA CARD

The red card you used for your first session serves to input the type and conditions of training. But it is also possible to do the same thing without the card, by using the buttons on the control unit.

### 1 Turn on the power supply.

- Plug in the exerciser and turn on the power switch at the back of the main unit.
- The initial display appears and prompts you to insert the card or to select a training mode.

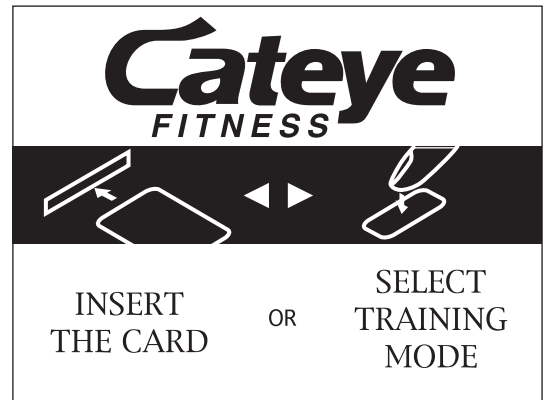

### 2 Select a training program.

- Attach the earlobe sensor, and then select a training program using one of the six training selection buttons.
- The six training selection buttons are aligned in the following order from the left:
  - 1 Fitness test
  - 2 HR control training
  - 3 Constant wattage control training
  - 4 Hill training
  - 5 Interval training
  - 6 Quick start training
- This time we will choose “HR control” as an example.
- Choose the program by pressing the  on the training select button.

Training mode

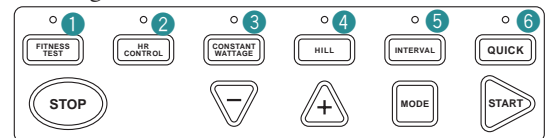



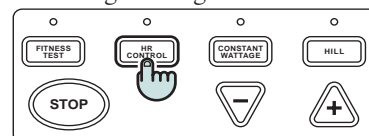

Selecting training mode









### 3

#### Input training conditions.

- The screen prompts you to set the training conditions.
- The screen changes as shown here, and the initial value for age (40) is shown.
- Your age can be increased or decreased as desired using the  and  buttons. The value changes rapidly if one or other button is pressed and held for longer than one second.
- For example, press the  button to change the value for age from 40 to 52.
- After inputting your age, go on to the next screen by pressing the  button.

**Caution:**

- Do not press the  button before completely inputting the data. If you press the  button before completing data input except the age, the skip function is activated, and exercise begins.
- Input contents vary depending on the program.

- Try changing the displayed target pulse rate from 117 to 109.
- In accordance with the target pulse rate, the arrow moves from aerobics to weight loss.
- After finish inputting your target pulse rate, go to the next screen by pressing the  button.
- Input the exercise time.
- Press the  button to bring up the display in which the various training conditions can be checked. Check that the training conditions are correct.
- To change the settings, display and highlight the desired item using the  and  buttons and then press the  button. The input display for the selected item appears, allowing the particular settings to be changed, as desired.

**Reference:**The card is a tool to instantly set a program and training conditions. Usually you have to set such conditions by pressing buttons before each session, but the data card saves you the trouble. The age, upper pulse limit setting, and target pulse rate will be automatically entered. See “How to make a data card” on page 42.

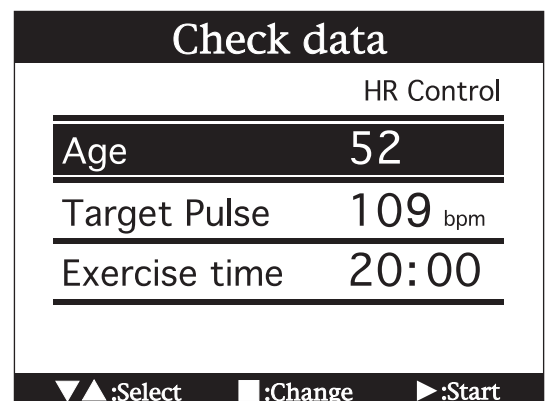
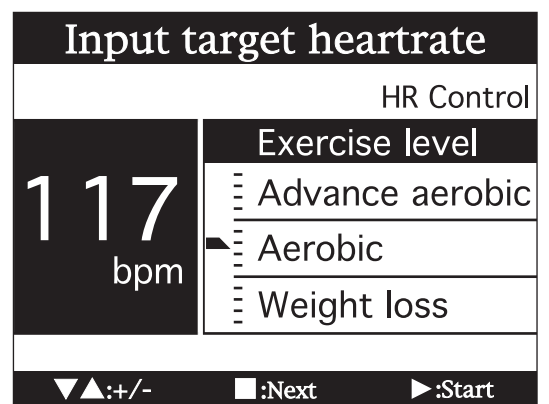
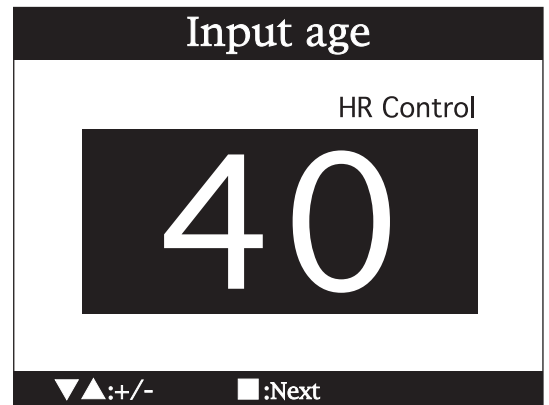

#### 4 Start your exercise.

- When you have finished setting training conditions, press the **START** button and start exercise. The message “Start warming-up” is displayed to announce that the HR control training program has started. Start pedaling slowly.
 

**Reference:** To skip the warm-up period and start a HR control training session immediately, press the **START** button.
- The pedal resistance can be changed arbitrarily during or after warm-up. To change the pedal resistance, press the **-** or **+** button.
- Within a few moments, the pedal resistance (torque) is automatically adjusted  $\pm 0.1$  kg·m every 15 or 30 seconds so that the difference between the measurement value and the target value becomes within  $\pm 3$  bpm.

- Pressing the **MODE** button during exercise toggles between the display with the exercise time, heart rate, and pedal cadence and that with the pedal loading level, wattage, and consumed calories. The pulse change is shown in the upper part of the graph and the pedal resistance change is shown in the lower part of the graph.

**Reference:** After 10 minutes of the session have elapsed, 5-minutes’ worth of session data scrolls off the display, to the left.

#### 5 Finish your exercise.

- A buzzer will sound when the exercise time previously set has elapsed.
 

**Reference:** You can stop training at any time, even before the buzzer sounds.
- The pedal resistance (torque) drops to the minimum of 0.5 kg·m, and the 5-minutes cool-down phase then starts.
- To complete the cool-down phase, remain in cool-down mode. Measurement still continues during the cool-down phase and the exercise time switches to the remaining cool-down time.
- If the 5-minute cool-down time is not necessary, press the **STOP** button to skip this phase.

#### Starting exercising

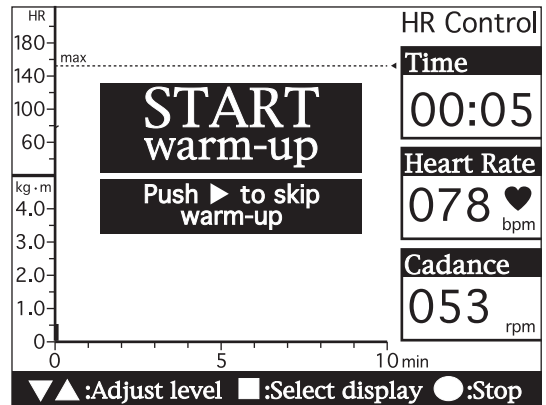
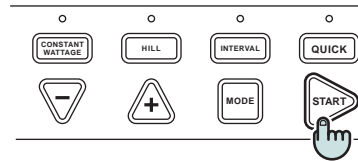

#### Changing the display

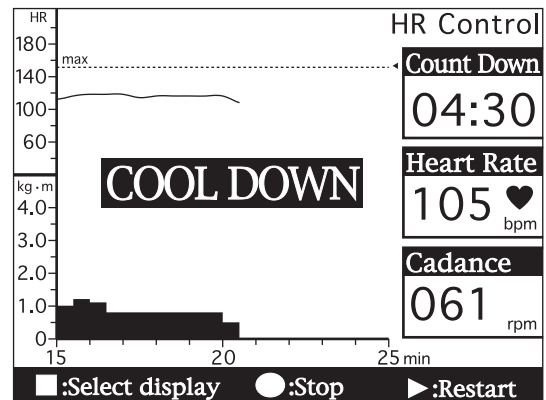
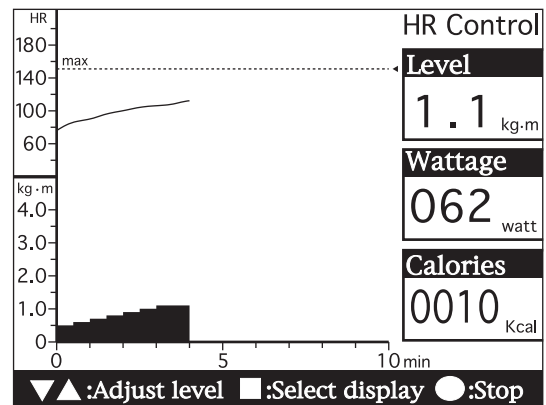
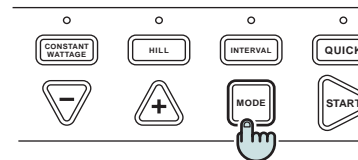

## 6

### Check your exercise record by scrolling the screen.

- After training, you can view your workout data on the display. If the session has lasted for longer than 10 minutes, graphical information for the entire session can be viewed by scrolling the display using the ▾ and ▲ buttons. Pressing the ▾ button scrolls 5 minutes' worth of data to the left while the ▲ button scrolls 5 minutes' worth of data to the right.
- After checking the session data, press the (STOP) button to complete the program. The initial display reappears.

#### Scrolling screen

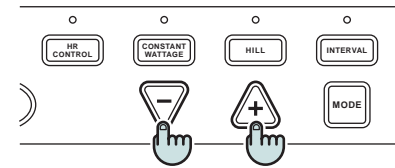

#### Ending program

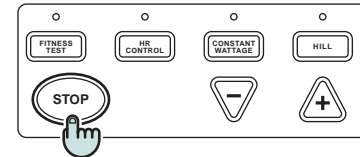

For further details about this product, proceed to the “Operation Guide” section once you are accustomed to using this unit.



## OPERATION GUIDE

<b>1</b>	<b>Training goals</b> .....	<b>24</b>
<b>2</b>	<b>Your strength level and training index</b> .....	<b>26</b>
<b>3</b>	<b>Fitness test</b> .....	<b>28</b>
<b>4</b>	<b>Fitness test (2)</b> .....	<b>30</b>
<b>5</b>	<b>HR control training</b> .....	<b>32</b>
<b>6</b>	<b>Constant wattage control training</b> .....	<b>34</b>
<b>7</b>	<b>Hill training</b> .....	<b>36</b>
<b>8</b>	<b>Interval training</b> .....	<b>38</b>
<b>9</b>	<b>Quick start</b> .....	<b>40</b>
<b>10</b>	<b>How to make a data card</b> .....	<b>42</b>



# 1 TRAINING GOALS

## Training goals

- Have you ever been out of breath after climbing a flight of stairs or after a brisk walk? When we are walking, running and even sleeping, our body is taking in oxygen and generating energy. Oxygen taken in by the lungs is sent to the entire body via the circulatory system. If the function of the circulatory system, i.e. aerobic power, is insufficient, we may experience being "out of breath" or experience yet other physical problems.
- We therefore perform "sports for the heart" (aerobic exercise), which causes the heart to work a little more a few times a week, thus increasing the oxygen supply to the body via the circulatory system. The purpose of exercise with the EC-C400R Ergometer is to improve both your physical strength and the functioning of the circulatory system: to improve our aerobic power.

## Training plan

- To effectively perform "sports for the heart" and to improve your aerobic power, it is necessary to exercise according to your age and physical fitness. If exercise exceeds your physical fitness level you only injure your body. On the other hand, if the exercise is insufficient, a positive effect cannot be expected.
- The EC-C400R Ergometer has 6 types of computer-controlled programs. One program is the "Fitness Test program". This test program evaluates your physical fitness level, while the other 5 programs are for actual exercise.
- The "Fitness Test" evaluates your physical fitness level so that you can determine the training index and begin exercise based on the measured result. After exercising for a while (about 3 months), you become aware of the effect on your body. Test your physical fitness level again and gradually set a higher training index, thus maintaining and improving your physical fitness level. A special feature of the EC-C400R Ergometer is that it combines testing with exercise.



## Exercise Frequency and Time

- At least 15 minutes are required for one exercise period, however if possible a 20 ~ 30 minute period is even better.
- To maintain your present condition, exercise at least twice a week, 3 times a week would improve your condition even more. The ideal however is to exercise every day or 5 ~ 6 times a week.

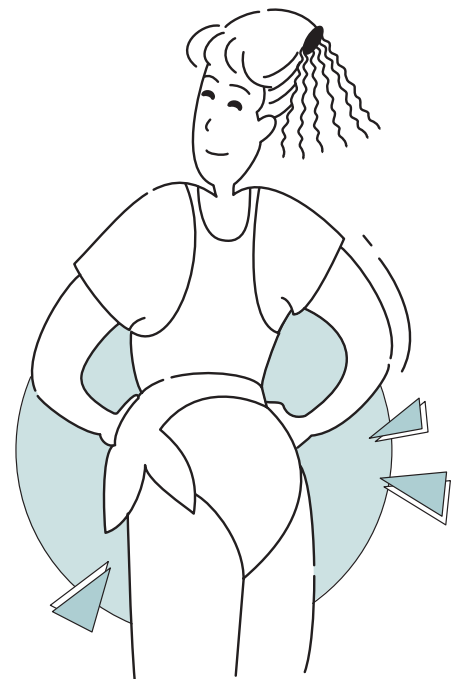
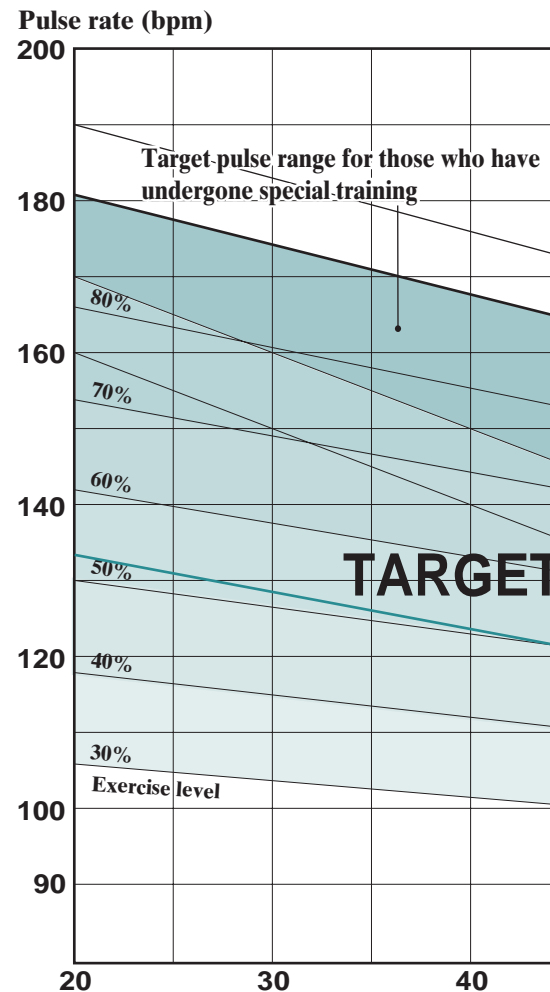



**Target Pulse Rate Chart**

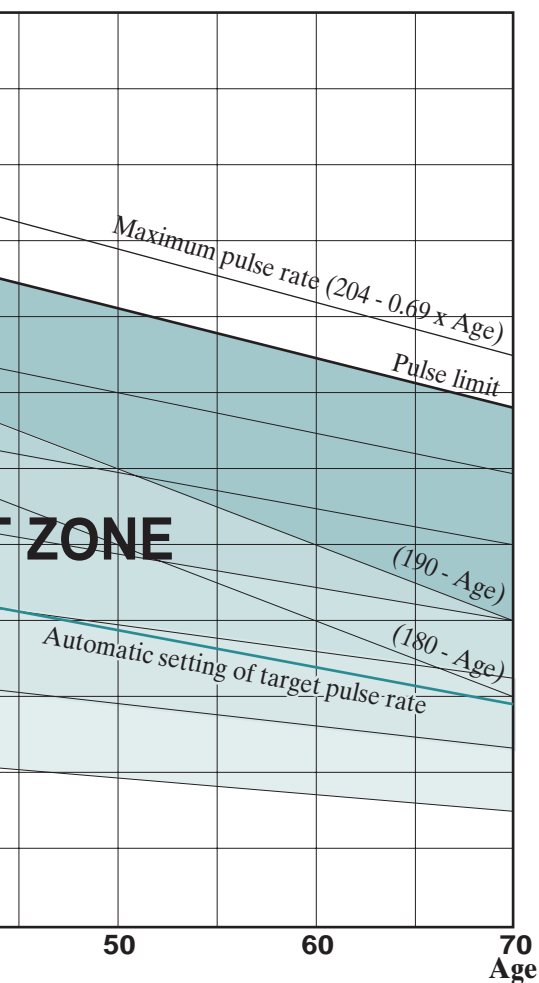

## Terminology

### Maximum Heart Rate

The heart rate increases according to the intensity of exercise, there is however a limit. The maximum heart rate that a person can sustain is called the "maximum heart rate". Generally the heart rate declines as we get older, this differs however between individuals, and is largely due to how much one exercises.

### The difference between heart rate and pulse rate

The heart rate is the rate of the heart beat per minute measured by an electrocardiograph. On the other hand, the pulse rate is measured as follows.

- By palpating an artery near the skin surface, such as the carotid artery, measure the pulse count of a blood vessel.
- Transmit a sensor light to an earlobe or finger tip, and measure the pulse count via the subtle changes of the sensor light transmission caused by the heart beat.

Although the measurement principle and method are different, both the heart and pulse rates have the same value per minute, and are therefore regarded as synonymous.

Since earlobes move very little during exercise and are not influenced very much by physical movement, it is appropriate to use an earlobe to measure the pulse rate during exercise. The EC-C400R Ergometer therefore measures the pulse rate by detecting changes in the circulation of the earlobe.

### Pulse Limit

For the relation between the maximum heart rate and age, "220 - Age", "204 - 0.69 x Age", and other formulas are used as standard. In this model, the 95% of the "204 - 0.69 x Age" is referred to as the "Pulse Limit", which is considered to be maximum pulse rate at which a person can carry out exercise safely.

### Target Pulse Rate

The pulse rate to maintain during exercise as a target is called the "target pulse rate". In the "HR control training" program, this pulse rate is automatically maintained. However, even with other programs, always be conscious of your target pulse rate during exercise. Refer to the illustration on the left.

### Exercise Level Based on the Pulse Rate

Pulse rate increases according to the intensity of the exercise. In other words, the pulse rate during exercise is a measure for the exercise level. The exercise level can be expressed in percentages by using the following formula.

$$\text{Exercise level(\%)} = \frac{\text{Pulse rate during exercise} - \text{Pulse rate at rest}}{\text{Maximum heart rate} - \text{Pulse rate at rest}} \times 100$$

Therefore, if you want to determine the target exercise level (target pulse rate) from the pulse rate, you can calculate as follows.

$$\text{Target pulse rate} = (\text{maximum heart rate} - \text{pulse rate at rest}) \times \frac{\text{Exercise level(\%)}}{100} + \text{pulse rate at rest}$$

If you are a beginner, you can start the exercise with a target pulse rate of "160 - your age". If you can continue your exercise at the target pulse rate of "180 - your age", your exercise can be considered effective enough. Upgrade your exercise gradually so that you can reach the suggested final target of "190 - your age".

# 2

## YOUR STRENGTH LEVEL AND TRAINING INDEX

### HR control training

- In this program, the exercise intensity is set by the target pulse rate (beats per minute: bpm). Select your target pulse rate from the following table, based on your age and physical fitness level (PFL) from 1 to 5.
- If the target you select is difficult, reduce the target pulse rate by 10 bpm. You need not work hard from the beginning, continuing is most important.
- This table is arranged so that even people who have not exercised so much can benefit. The targets in this table may be too easy for people who exercise often. If you have confidence, increase your target in 10 bpm units, referring to the target zone in the illustration on page 24 ~ 25.
- Exercise for at least a 15 minute period. If possible a 20 ~ 30 minute period is even better.
- If overweight control (calorie combustion) is the purpose of the exercise, set the target pulse rate lower so that you can easily exercise even while watching TV, but extend your exercise time longer, exceeding 30 minutes.

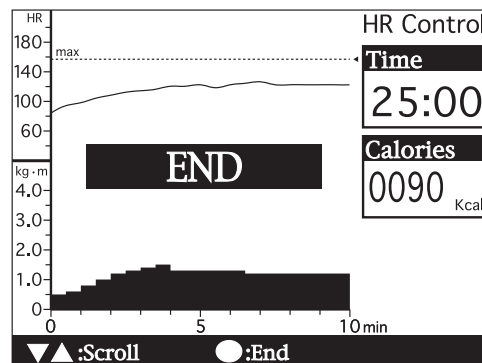

PFL	20 ~ 30s	40 ~ 50s	over 60s
1	110bpm	100bpm	95bpm
2 ~ 3	120bpm	110bpm	105bpm
4 ~ 5	130bpm	120bpm	115bpm

### Constant wattage control training

- In this program the exercise intensity is set by the work rate: wattage. Select the target wattage from the table shown below, according to your PWCmax. value provided by the Aerobic Power Measurement.
- If the selected wattage proves too hard for you, try again at the level 10 watts lower. When it becomes easy enough, raise the target by 10 watts.
- Exercise for at least a 15 minute period. If possible a 20 ~ 30 minute period is even better. Since warm up takes 3 minutes, set your actual exercise time to "actual exercise time + 3 minutes".

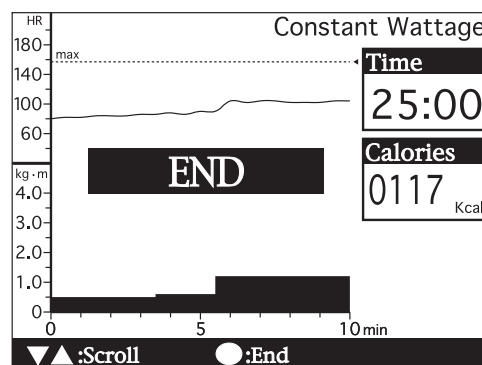

PWC max	Target Wattage	PWC max	Target Wattage
100 watt	40 watt	220 watt	90 watt
120 watt	50 watt	240 watt	95 watt
140 watt	55 watt	260 watt	105 watt
160 watt	65 watt	300 watt	120 watt
180 watt	70 watt	350 watt	140 watt
200 watt	80 watt	400 watt	160 watt

### Hill training

- Merely select one of the 3 hill profile training patterns in this program. Try different hill profiles (shape of the mountain) in a range where you don't feel too much difficulty. The exercise intensity can also be adjusted by pedaling slower or faster depending on the changes of pedal resistance.
- First, choose the most suitable preference (PRF) according to your PWCmax value, from the table shown right.
- The cycle time for a given pattern is 15 minutes. The same pattern is repeated in accordance with the exercise time.
- The calorie consumption provided right is based on the cadence of 60 rpm and the exercise time of 20 minutes. The calorie expenditure will vary in proportion with the pedal cadence and the exercise time.

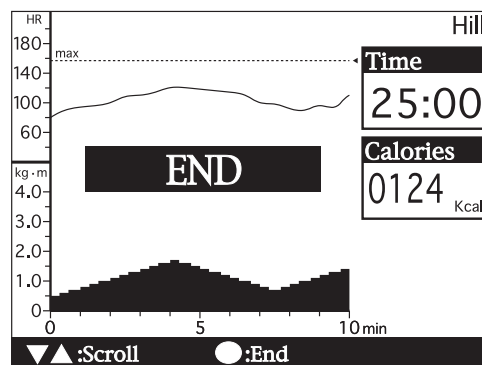

PWC max	140 watt	195 watt	240 watt
Exercise Pattern	1	3	2
Caloric Consumption	88 kcal	107 kcal	116 kcal

## Interval training

- In this program, select one of the 3 patterns depending on the power you want to improve. As for the exercise intensity, adjust the pedal resistance (torque: kg·m) during training, using ▽ and ▲ buttons.
- This program is for people with a long history of exercise.
- The following is a reference. Settings should match your physical fitness level and purpose.
- Exercise for at least a 15 minute period. If possible a 20 ~ 30 minute period is even better. Since warm up takes 3 minutes, set your exercise time to "actual exercise time + 3 minutes".
- Depending on the physical fitness level and purpose, some people may exercise at a higher pulse limit than the value calculated by age. In such instances, set the pulse limit slightly higher, being conscious of your own physical condition.
- If you select the stamina training (aerobic power) pattern (Pattern 3), maintain your pulse rate in the 60 ~ 80% range of the illustration on page 24~25.

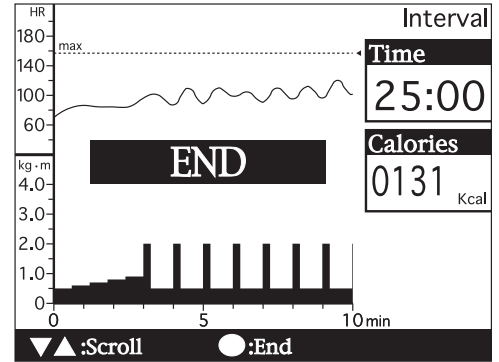

Pattern 1		Pattern 2		Pattern 3	
PWC max	Pedal Torque	PWC max	Pedal Torque	PWC max	Pedal Torque
220 watt	1.5 kg·m	220 watt	1.4 kg·m	220 watt	1.3 kg·m
240 watt	2.0 kg·m	240 watt	2.8 kg·m	240 watt	1.7 kg·m
260 watt	2.5 kg·m	260 watt	2.3 kg·m	260 watt	2.1 kg·m
300 watt	3.0 kg·m	300 watt	2.8 kg·m	300 watt	2.6 kg·m
350 watt	3.5 kg·m	350 watt	3.2 kg·m	350 watt	3.0 kg·m
400 watt	4.0 kg·m	400 watt	3.7 kg·m	400 watt	3.5 kg·m

- The numeric values show the case in which the pedal cadence during exercise is 80 rpm.

## Quick start training

- This program is the Ergometer's basic training program in which an exercise is started simply by pressing the **QUICK** training selection button.
- This program does not automatically change, and is therefore different to other programs. A workout can be undertaken while adjusting the desired pedal resistance (torque: kg·m).
- The exercise time for a given training session is 15 minutes. A 20 ~ 30-minute exercise is preferable.
- Since the exercise time has not yet been set, training can be finished at whatever time is preferable. One dot indicates three seconds in the display. When the exercise time exceeds 10 minutes, 5-minutes' worth of data scrolls to the left on the display.
- In the quick start program, the upper pulse limit is fixed to 160 bpm.

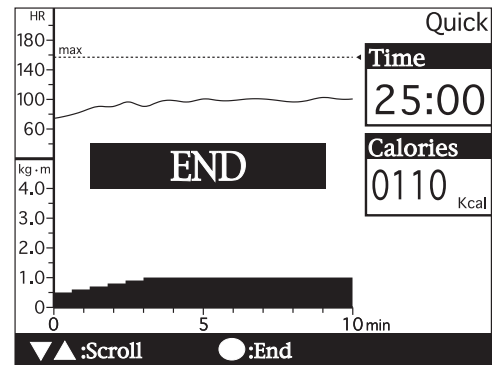

PWC max	Pedal Torque (kg·m)			PWC max	Pedal Torque (kg·m)		
	50 rpm	50 rpm	50 rpm		50 rpm	50 rpm	50 rpm
120 watt	0.9	0.7	0.9	220 watt	1.9	1.3	1.1
140 watt	1.1	1.8	1.1	240 watt	2.0	1.5	1.1
160 watt	1.2	1.9	1.2	260 watt	2.1	1.6	1.2
180 watt	1.4	1.0	1.4	300 watt	2.3	1.7	1.3
200 watt	1.6	1.1	1.6	350 watt	2.7	1.9	1.5
220 watt	1.7	1.2	1.7	400 watt	3.1	2.2	1.7

# 3

## FITNESS TEST

### 1 Select the Fitness test program.

- Attach the earlobe sensor, and press the  training selection button to select the program.

Selecting training program

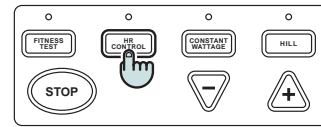











### 2 Input the conditions.

- Enter your age, weight, and sex in that order. The initial display, prior to data input, is as shown in the table below:

	Initial value	Setting range
Age	40 years	10 - 99 years
Weight	160 lb	66 -286 lb
Sex	Male	

**Reference:** The upper pulse limit is automatically determined and is displayed in the upper part of the graph after your age has been entered.

- Enter your age. You can increase or decrease the value by pressing the  or  button. The value changes rapidly if one or other button is pressed and held for more than a second.
- Pressing the  button switches the display to the weight and then to sex.
- Again, in the case of weight, the value can be increased or decreased by pressing the  or  button; for sex, the  and  buttons alternate between male and female.
- When the sex has been specified and the  button is pressed, the data check display with the specified conditions appears.

**Reference:** To change the conditions, display and highlight the desired item using the  and  buttons, and then press the  button. The input display then appears.

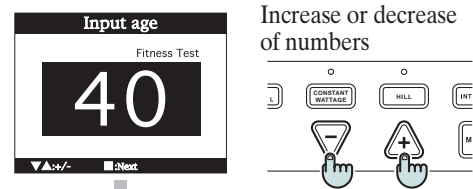

Increase or decrease of numbers

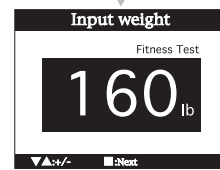

Changing item for input

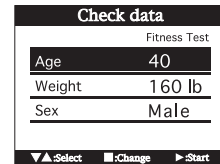
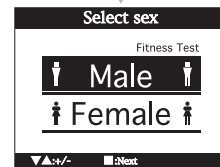

### 3 Start the program.

- After specifying the conditions, press the  button to start the fitness test.
- The pulse measurement starts, and “READY” appears in the display. Wait for one minute without pedaling.
- When one minute has elapsed, “START” appears in the display, and a buzzer sounds; start pedaling now. Keep pedaling so that the 60 rpm of the pedal cadence can be maintained.
- The pedal resistance (torque) is indicated in the lower part of the graph on the display. One dot along the horizontal axis represents three seconds while two dots along the vertical axis represent 0.1 kg·m.
- The blinking numeric value in the upper part of the graph indicates the pulse at that point. One dot along the vertical axis represents 2 bpm.
- Every three seconds, a row of dots blinks toward the right of the graph. Thus, the training status can be monitored.
- At the fourth and seventh minutes, the pedal resistance changes according to your pulse rate and it is indicated in the lower part of the graph. For information related to the changes in pedal resistance, refer to “EC-C400R test protocol” on page 31.

Starting program

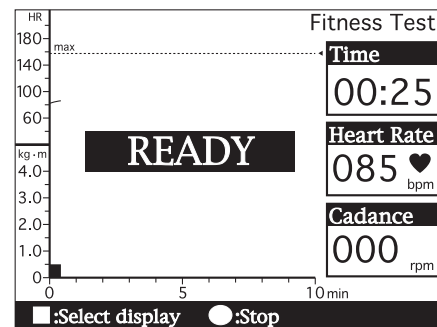
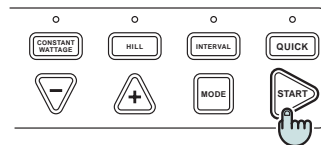

- Pressing the **[MODE]** button changes the numeric value displayed. Thus, the pedal loading level (resistance), wattage, and consumed calories can be checked.

- Caution:**
- If the pedal cadence is not detected for five seconds, a fitness test measurement cannot be carried out. "ERROR" blinks in the display and the test finishes.
  - If your pulse rate exceeds the upper pulse limit, "STOP EXERCISE" blinks in the display and the fitness test finishes forcibly.

**Reference:** A maximum of 10-minutes' worth of data can be displayed. After 10 minutes, 5-minutes' worth of exercise graph scrolls to the left.

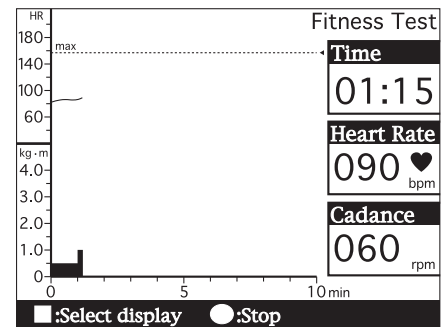

#### Changing the display

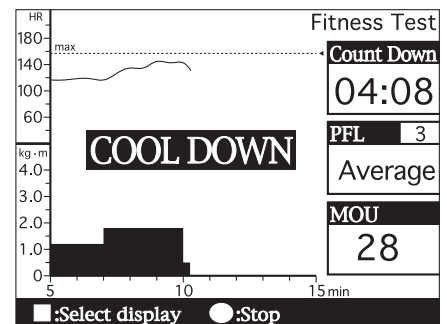
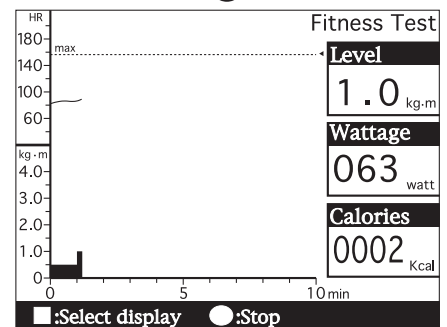
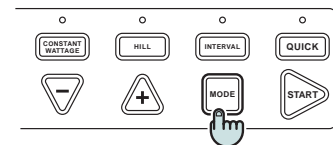

#### Finishing Fitness test

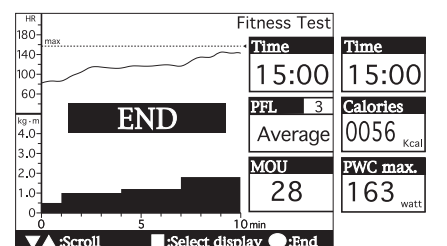
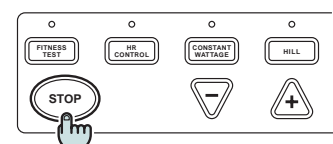

#### Ending program

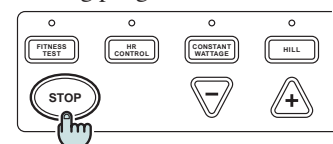

## 4 Test result display and cool down

- A buzzer sounds after ten minutes and the test result is displayed on the screen. The program then enters the 5-minute cool-down phase.
- To complete the cool-down phase, remain in cool-down mode. The remaining cool-down time (Count Down) as well as your test result are displayed.

## 5 Finish the Fitness test.

- When the five minute phase has elapsed or when the **[STOP]** button has been pressed, the cool-down phase ends and the fitness test finishes. The exercise progression at the end of the fitness test appears in the display.
- Pressing the **[MODE]** button toggles between displays A and B.
  - A: "Time", "PFL", and "MOU" from the top
  - B: "Time", "Calories", and "PWC max." from the top
- Check the information displayed in the test result, such as "PFL", "Calories", and others.
- You can monitor the exercise progression graph by scrolling the screen using the **[▽]** and **[▲]** buttons.

## 6 End the program.

- Press the **[STOP]** button to bring up the initial display again.
- To finish the entire program, turn off the power switch at the back of the main unit.

# 4

## FITNESS TEST (2)

### Physical Fitness Level (PFL)

- There are five physical fitness levels: 1 ~ 5. These levels are relative evaluations that compare your maximum oxygen uptake (MOU), estimated by the Fitness test program, with the values of other people of the same age and sex (Physical Fitness Level Test Table).

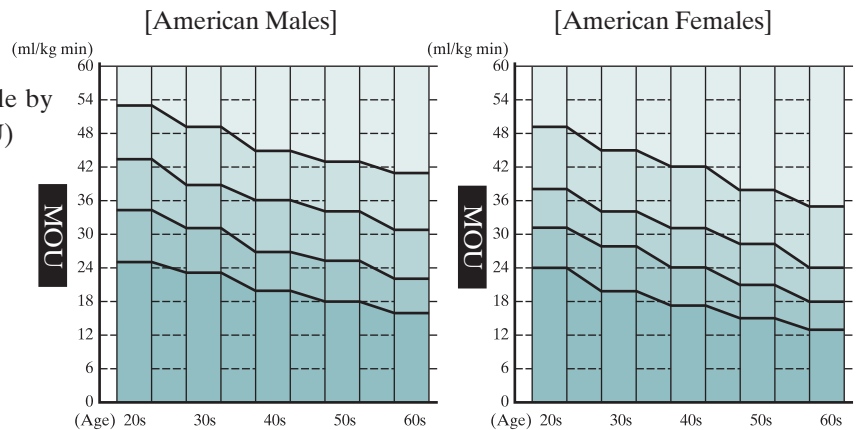
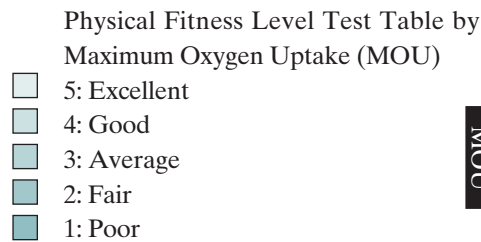

### Maximum Oxygen Uptake (MOU)

- MOU is widely used as an index for total physical endurance. MOU indicates the amount of oxygen one can intake at the limit of their physical work capacity. In the EC-C400R Ergometer, MOU is calculated based on the maximum physical work capacity (PWC max.) explained below, assuming that

1 litre of oxygen corresponds to 5.0 Kcal, and  
the human body efficiency rate for a bicycle exercise is 23%

### Maximum Physical Work Capacity (PWC max.)

- In the EC-C400R Ergometer “Fitness test” program the weight of the pedals are changed at 3 levels, and the pulse rate at the end point of each level is measured. Based on the result, the relationship between the work rate (wattage) and the pulse rate is analyzed by linear regression. Extend the regression line until reaching the maximum heart rate ( $=204 - 0.69 \times \text{age}$ ) which is estimated by age. The work rate (wattage) of this point becomes the maximum physical work capacity.
- PWC max. safely estimates how much exercise is possible at the limit of physical work capacity, that is, at maximum heart rate without performing actual exercise.

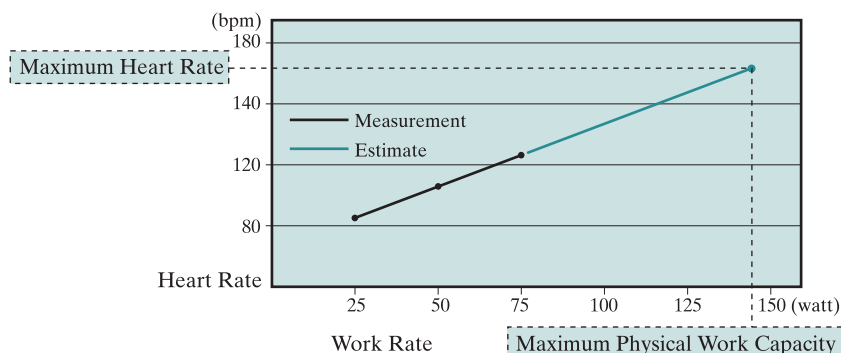

## Test Protocol

- In the “Fitness test” program of the EC-C400R Ergometer, the workload (pedal resistance: torque) for the subsequent stage is determined depending on your pulse rate at the previous stage. The workload (pedal resistance: torque) will be increased along one of the routes illustrated below, depending on your pulse rate <sup>TM</sup> during the program.
- The pulse rates specified below represent the protocol for a person of 20 years. For the people over 20, the borderline of pulse rate will be adjusted by the age adjustment coefficient (K), which is obtained by the following formula:

$$K = \frac{204 - 0.69 \times \text{Age}}{204 - 0.69 \times 20}$$

- For people over 60 years, the coefficient (K) is calculated as 60.

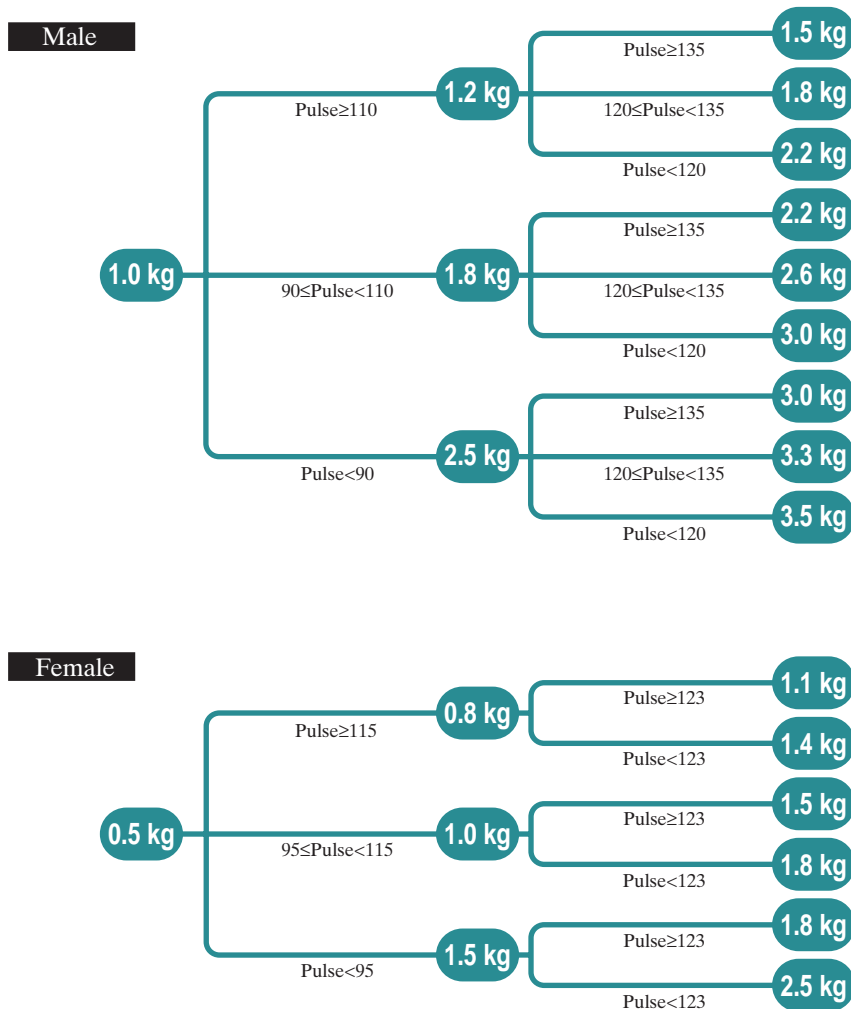

**Reference:** The load change for males over 50 years of age is the same as for females.  
When the age is less than 20, the load changes as if the age were 20.

## 1 Select the HR control training program.



- Attach the earlobe sensor, and press the training selection  button to select the program.



## 2 Input the conditions.

- Enter your age, target pulse, and desired exercise time, in that order. The initial display, prior to data input, is as shown in the table below:

	Initial value	Setting range
Age	40 years	10 - 99 years
Target Pulse	123 bpm	75 - 168 bpm
Exercise Time	20 minutes	1 - 95 minutes



**Reference:** The upper pulse limit is automatically determined and is displayed in the upper part of the graph after your age has been entered.

- Enter your age. You can increase or decrease the value by pressing the  or  button. The value changes rapidly if one or other button is pressed and held for more than one second.
- Pressing the  button switches the display to the target pulse and then to the exercise time.

**Reference:** • The initial value of the target pulse is determined according to the age entered. When the numeric value is increased/decreased using the  or  button, an arrow indication of the level moves accordingly.

- When the exercise time has been entered and the  button is pressed, the data check display appears with the specified conditions.

**Reference:** • When only the age is entered and the  button is pressed, training can start immediately.

• To change the conditions, display and highlight the desired item using the  and  buttons, and then press the  button. The input display then appears.



## 3 Start the program.

- After carrying out settings of the desired conditions, press the  button to start the training program.

A buzzer sounds, and the various measurements start.

## 4 Start the warm-up.

- "START WARM-UP" appears in the display. Start pedaling slowly.
- During the 3-minute warm-up, the pedal resistance automatically changes so that your pulse rate approaches the target pulse. If your pulse rate exceeds the target pulse even though the three minutes has not yet elapsed yet, the warm-up ends.

**Reference:** During warm-up, the pedal resistance can be adjusted by pressing the  or  button.

- The pedal resistance (torque) is indicated in the lower part of the graph on the display. One dot along the horizontal axis represents three seconds while two dots along the vertical axis represent 0.1 kg·m.
- The blinking numeric value in the upper part of the graph indicates the pulse at that point. One dot along the vertical axis represents 2 bpm.
- Every three seconds, a row of dots blinks. Thus, the training status can be monitored.
- When the  button is pressed during warm-up, the warm-up function is skipped.

### Selecting training program

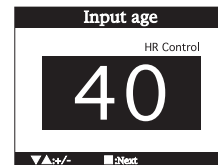
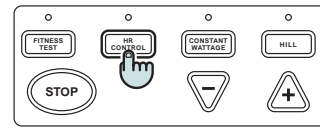

### Increase or decrease of numbers

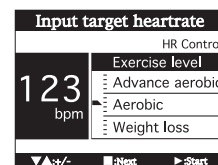
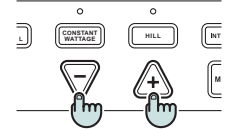

### Changing item for input

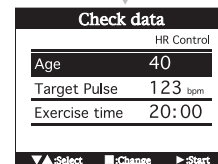
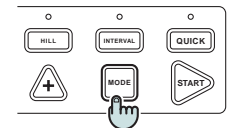

### Starting program

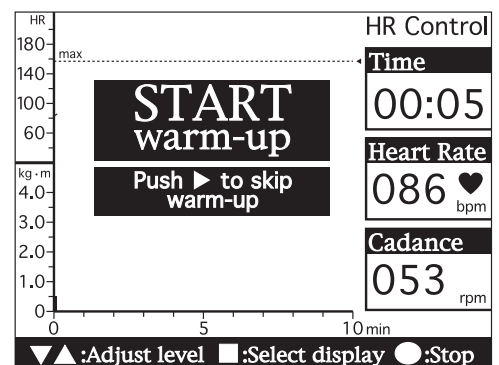
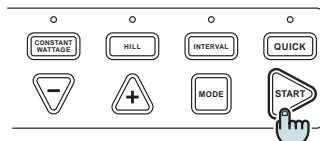



## 5

### Continue the training, maintaining the target pulse.

- When finishing the warm-up phase, the pedal resistance is automatically adjusted (0.1 kg·m every 15 seconds so that the difference between the measurement value and the target value becomes (3 bpm). Thus, training can continue while the target pulse is being maintained.
- You can adjust the pedal resistance using the and buttons.
- Pressing the button switches the numeric value displayed.

**Caution:** If your pulse rate exceeds the upper limit, "STOP EXERCISE" blinks in the display, training finishes forcibly, and the pedal resistance drops to the minimum.

- Reference:**
- If the pedal cadence is not detected for five seconds, the pause display appears. At this time, the specified training duration is interrupted and "PAUSE" blinks in the display. When pedaling starts again, the specified training duration recommences.
  - A maximum of 10-minutes' worth of data can be displayed. After 10 minutes, 5-minutes' worth of exercise graph scrolls to the left.

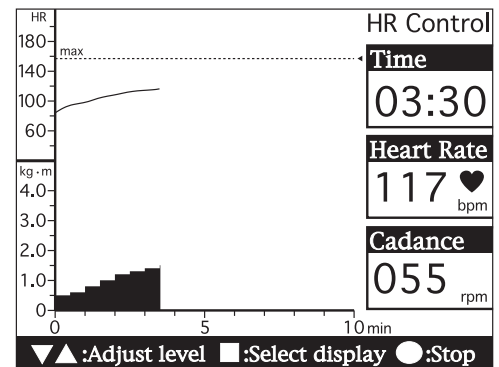

#### Changing the display

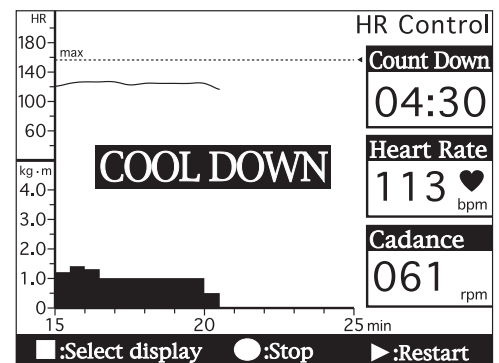
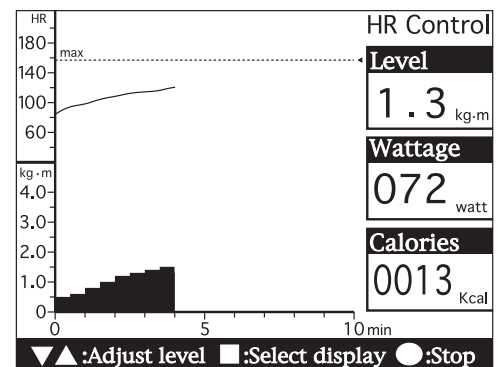
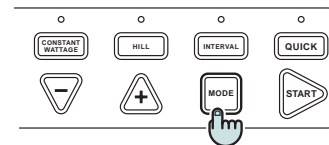

#### Continuing the training session

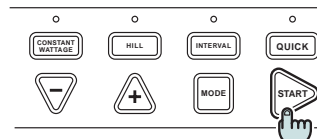

#### Ending program

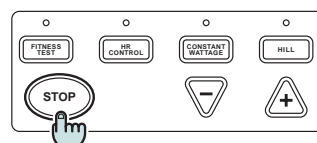

## 6

### Finish your exercise.

- When the specified duration elapses or when the button is pressed, a buzzer sounds and the 5-minute cool-down phase begins. Pulse detection stops, and the pedal resistance drops to the minimum of 0.5 kg·m.

**Reference:** If the button is pushed during cool-down, the machine is restated to continue with training. At this time, the pedal resistance starts from that at the cool-down phase. At restart, the cool-down phase starts only when the button is pressed.

- To complete the cool-down phase, remain in cool-down mode. Data such as the remaining cool-down time (Count Down), your pulse rate, and other information are displayed. The total calories are accumulated.
- When a period of five minutes elapses or when the button is pressed, the cool-down phase ends and the training program finishes. The exercise progression at the end of the training program appears in the display.

**Caution:** You cannot return to the cool-down display or the exercise display from the end display.

- You can monitor the exercise progression graph by scrolling the screen using the and buttons.

## 7

### End the program.

- Press the button to bring up the initial display again.
- To finish the entire program, turn off the power switch at the back of the main unit.

# 6

## CONSTANT WATTAGE CONTROL TRAINING

### 1 Select the Constant wattage control training program.

- Attach the earlobe sensor, and press the training selection  button to select the program.



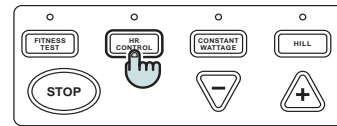

Selecting training program







### 2 Input the conditions.

- Enter the wattage, your age, and exercise time in that order. The initial display, prior to data input, is as shown in the table below:

	Initial value	Setting range
Wattage	50 watt	25 - 200 watt
Age	40 years	10 - 99 years
Exercise Time	20 minutes	1 - 95 minutes

- Reference:**
- When the  button is pressed, training can be started immediately under the initial conditions.
  - The upper pulse limit is automatically determined and is displayed in the upper part of the graph after your age has been entered.
- Enter a wattage. You can increase or decrease the value by pressing the  or  button. The value changes rapidly if one or other button is pressed and held for more than one second.
  - Pressing the  button switches the display to the age input display and then to the exercise time input display.
  - When the exercise time has been entered and the  button is pressed, the data check display appears with the specified conditions.

- Reference:**
- To change the conditions, display and highlight the desired item using the  and  buttons, and then press the  button. The input display then appears.
  - When the  button is pressed at any of the input displays, training can start immediately under the conditions which have been specified up to that point.

### 3 Start the program.

After carrying out settings of the desired conditions, press the  button to start the training program.

A buzzer sounds, and the various measurements start.

### 4 Start the warm-up.

- "START WARM-UP" appears in the display. Start pedaling slowly.
- The pedal resistance automatically changes so that the specified wattage is reached within three minutes of the start of warm-up.
- The pedal resistance (torque) is indicated in the lower part of the graph on the display. One dot along the horizontal axis represents three seconds while two dots along the vertical axis represent 0.1 kg·m.
- The blinking numeric value in the upper part of the graph indicates the pulse at that point. One dot along the vertical axis represents 2 bpm.
- Every three seconds, a row of dots blinks. Thus, the training status can be monitored.
- When the  button is pressed during warm-up, the warm-up function is skipped.

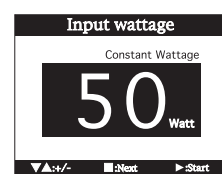

Increase or decrease of numbers

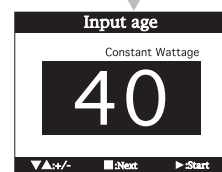
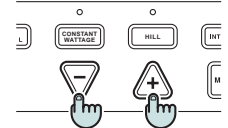

Changing item for input

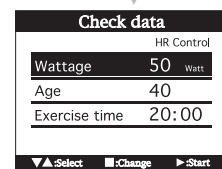
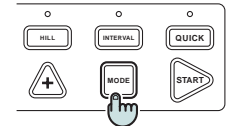

Starting program

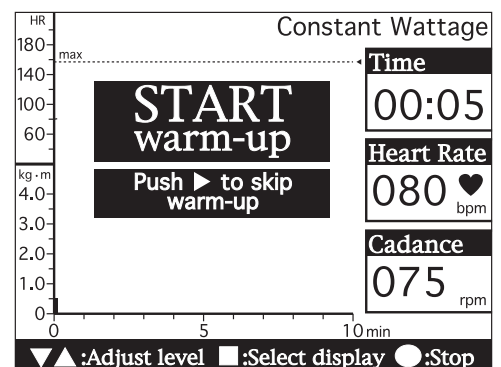
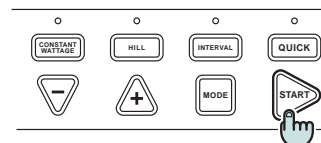

## 5 Continue the training, maintaining the wattage.

- When warm-up finishes, the pedal resistance is automatically adjusted according to the pedal cadence so that the specified wattage is reached. Thus, training can continue while maintaining the wattage.
- The wattage can be adjusted using the ▾ and ▲ buttons.
- Pressing the [MODE] button switches the numeric value displayed.

**Caution:** If your pulse rate exceeds the upper limit, "STOP EXERCISE" blinks in the display, training finishes forcibly, and the pedal resistance drops to the minimum.

- Reference:**
- If the pedal cadence is not detected for five seconds, the pause display appears. At this time, the specified training duration is interrupted and "PAUSE" blinks in the display. When pedaling starts again, the specified training duration recommences.
  - A maximum of 10-minutes' worth of data can be displayed. After 10 minutes, 5-minutes' worth of exercise graph scrolls to the left.

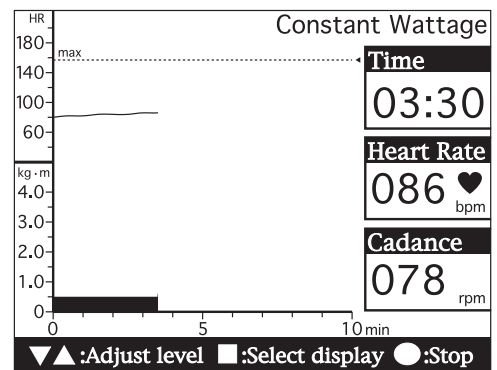

### Changing the display

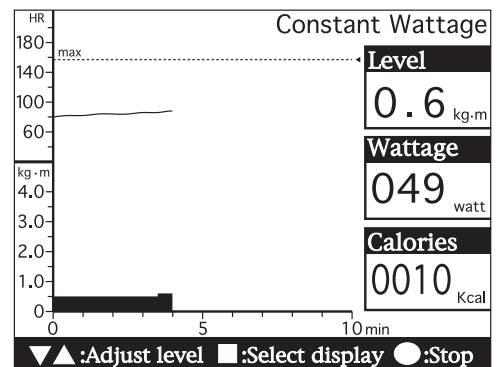
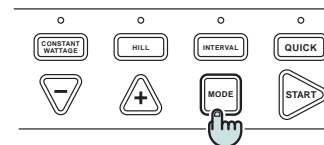

## 6 Finish your exercise.

- When the specified duration elapses or when the [STOP] button is pressed, a buzzer sounds and the 5-minute cool-down phase begins. Automatic adjustment of the wattage stops, and the pedal resistance drops to the minimum of 0.5 kg·m.

**Reference:** If the [START] button is pushed during cool-down, the machine is restated to continue with training. At this time, the pedal resistance starts from that at the cool-down phase. At restart, the cool-down phase starts only when the [STOP] button is pressed.

- To complete the cool-down phase, remain in cool-down mode. Data such as the remaining cool-down time (Count Down), your pulse rate, and other information are displayed. The total calories are accumulated.
- When a period of five minutes elapses or when the [STOP] button is pressed, the cool-down phase ends and the training program finishes. The exercise progression at the end of the training program appears in the display.

**Caution:** You cannot return to the cool-down display or the exercise display from the end display.

- You can monitor the exercise progression graph by scrolling the screen using the ▾ and ▲ buttons.

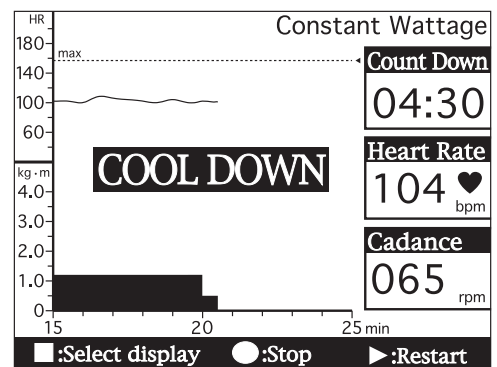

### Continuing the training session

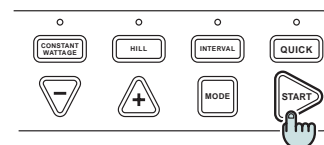

### Ending program

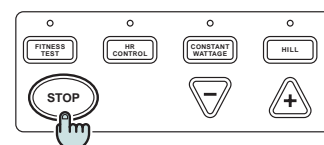

## 7 End the program.

- Press the [STOP] button to bring up the initial display again.
- To finish the entire program, turn off the power switch at the back of the main unit.

# 7

## HILL TRAINING

### 1 Select the Hill training program.

- Attach the earlobe sensor, and press the training selection  button to select the program.

Selecting training program

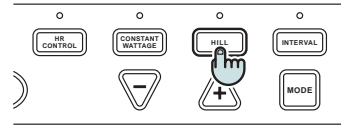











### 2 Input training conditions.

- Enter your Exercise pattern, Age, and desired exercise time, in that order. The initial display, prior to data input, is as shown in the table below:

	Initial Value	Setting Range
Exercise pattern	1	1 - 3
Age	40 years	10 - 99 years
Exercise time	20 minutes	1 - 95 minutes

- Reference:**
- When the  button is pressed, training can be started immediately under the initial conditions.
  - The upper pulse limit is automatically determined and is displayed in the upper part of the graph after your age has been entered.

- Select an exercise pattern. The pattern of the pedal resistance is displayed. A pattern can be selected by pressing the  and  buttons.
- Pressing the  button switches the display to the age input display and then to the exercise time input display.
- You can increase or decrease the numeric value by pressing the  or  button in the age input display and the exercise time setting display. The value changes rapidly if one or other button is pressed and held for longer than one second.
- When the exercise time has been entered and the  button is pressed, the data check display appears with the specified conditions.

- Reference:**
- To change the conditions, display and highlight the desired item using the  and  buttons, and then press the  button. The input display then appears.
  - When the  button is pressed at any of the input displays, training can start immediately under the conditions which have been specified up to that point.

#### Exercise patterns

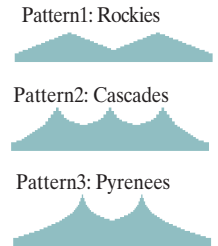

#### Increase or decrease of numbers

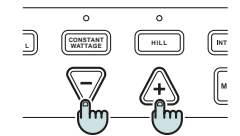

#### Changing item for input

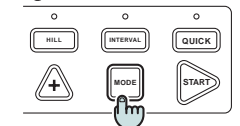

### 3 Start the program.

- After carrying out settings of the desired conditions, press the  button to start the training program. A buzzer sounds, and the various measurements start.

Starting program

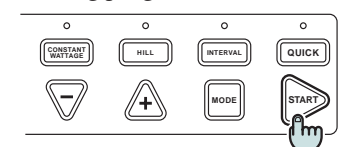

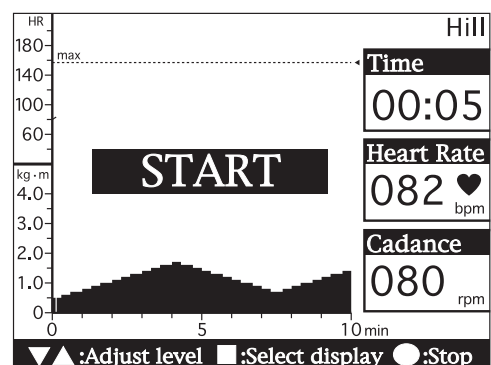

### 4 Start the training.

- The hill pattern appears in the display. Start pedaling slowly.
- Reference:** There is no warm-up function in the Hill training program.
- The mountain-like shape appears in the lower part of the graph of the display. One dot along the horizontal axis represents three seconds while two dots along the vertical axis represent 0.1 kg·m.
  - The blinking numeric value in the upper part of the graph indicates the pulse at that point. One dot along the vertical axis represents 2 bpm.
  - Every three seconds, a row of dots blinks toward the right of the graph. Thus, the training status can be monitored.
  - Pressing the  button switches the display.



## 5

### Continue the training.

- The pedal resistance automatically changes according to the pattern.
- A mountain-like shape represents a 15-minute interval. Every 15 minutes, the same mountain-like shape appears repeatedly.
- You can change the pedal resistance using the  and  buttons. The pedal resistance can be changed in the range between the highest point of the convex shape (4.0 kg·m) and the lowest point of the concave shape (0.5 kg·m); it increases/decreases while the exercise pattern is maintained.

**Reference:** When the pedal resistance is changed, the entire pattern changes. However, the data for the exercises already completed does not change.

**Caution:** **If your pulse rate exceeds the upper limit, "STOP EXERCISE" blinks in the display, training finishes forcibly, and the pedal resistance drops to the minimum.**

- Reference:**
- If the pedal cadence is not detected for five seconds, the pause display appears. At this time, the specified training duration is interrupted and "PAUSE" blinks in the display. When pedaling starts again, the specified training duration recommences.
  - A maximum of 10-minutes' worth of data can be played. After 10 minutes, 5-minutes' worth of exercise graph scrolls to the left.

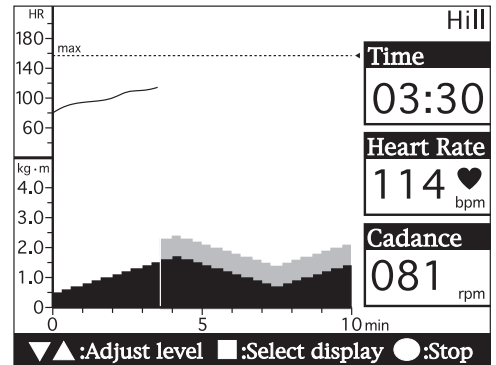

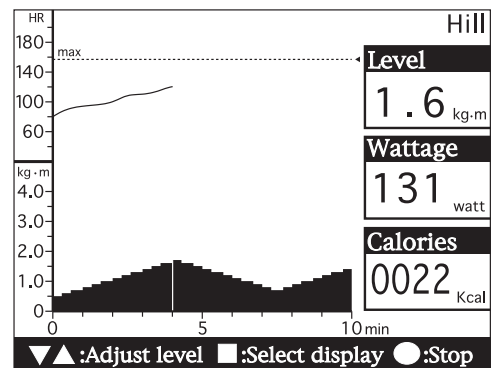
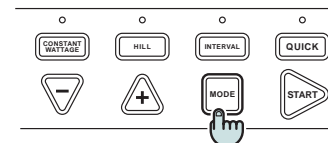

#### Changing the display





## 6

### Finish your exercise.

- When the specified duration elapses or when the  button is pressed, a buzzer sounds and the 5-minute cool-down phase begins. Pulse detection stops, and the pedal resistance drops to the minimum of 0.5 kg·m.
- To complete the cool-down phase, remain in cool-down mode. Data such as the remaining cool-down time (Count Down), your pulse rate, and other information are displayed. The total calories are accumulated.
- When a period of five minutes elapses or when the  button is pressed, the cool-down phase ends and the training program finishes. The exercise progression at the end of the training program appears in the display.

**Caution:** **You cannot return to the exercise display from the cool-down display or the end display.**

- You can monitor the exercise progression graph by scrolling the screen using the  and  buttons.

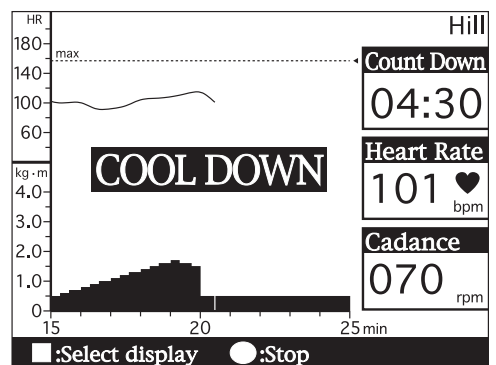

#### Ending program

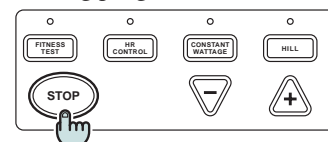

## 7

### End the program.

- Press the  button to bring up the initial display again.
- To finish the entire program, turn off the power switch at the back of the main unit.

### 1 Select the Interval training program.







- Attach the earlobe sensor, and press the training selection  button to select the program.





### Input training conditions.

- Enter your Exercise pattern, Age, and desired exercise time, in that order. The initial display, prior to data input, is as shown in the table below:

	Initial Value	Setting Range
Exercise pattern	1	1 - 3
Age	40 years	10 - 99 years
Exercise time	20 minutes	1 - 95 minutes

- Reference:**
- When the  button is pressed, training can be started immediately under the initial conditions.
  - The upper pulse limit is automatically determined and is displayed in the upper part of the graph after your age has been entered.

- Select an exercise pattern. The pattern of the pedal resistance is displayed. A pattern can be selected by pressing the  and  buttons.
- Pressing the  button switches the display to the age input display and then to the exercise time input display.
- You can increase or decrease the numeric value by pressing the  or  button in the age input display and the exercise time setting display. The value changes rapidly if one or other button is pressed and held for longer than one second.
- When the exercise time has been entered and the  button is pressed, the data check display appears with the specified conditions.

- Reference:**
- To change the conditions, display and highlight the desired item using the  and  buttons, and then press the  button. The input display then appears.
  - When the  button is pressed at any of the input displays, training can start immediately under the conditions which have been specified up to that point.

### 3 Start the program.

After carrying out settings of the desired conditions, press the  button to start the training program.

A buzzer sounds, and the various measurements start.

### 4 Start the warm-up.

- "START WARM-UP" appears in the display. Start pedaling slowly.
- The pedal resistance is automatically changed so that the resistance reaches half of its peak within three minutes of the start of warm-up.
- The pedal resistance (torque) is indicated in the lower part of the graph on the display. One dot along the horizontal axis represents three seconds while two dots along the vertical axis represent 0.1 kg·m.
- The blinking numeric value in the upper part of the graph indicates the pulse at that point. One dot along the vertical axis represents 2 bpm.
- Every three seconds, a row of dots blinks. Thus, the training status can be monitored.
- When the  button is pressed during warm-up, the warm-up function is skipped.

### Selecting training program

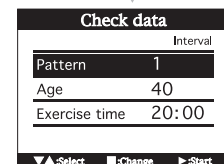
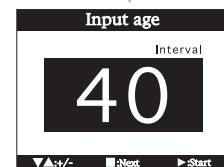
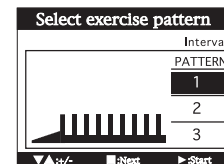
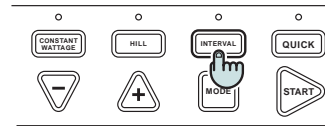

### Exercise patterns

Pattern1: Dash strength training  
15 seconds of exercise with 45 seconds of rest

Pattern2: Speed training  
30 seconds of exercise with 60 seconds of rest

Pattern3: Stamina training  
60 seconds of exercise with 30 seconds of rest

Increase or decrease of numbers

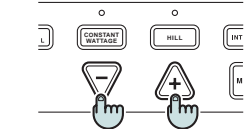

Changing item for input

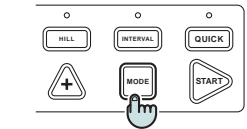

### Starting program

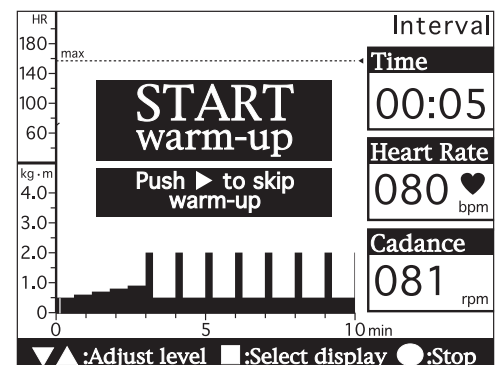
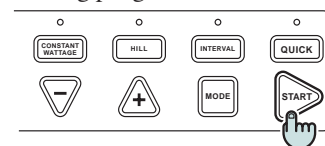

## 5

### Continue the training by repeating "exercise" and "rest."

- The pedal resistance changes periodically according to the exercise pattern.
- During the exercise period, you should pedal faster, then slower and lighter during the relief period.
- You can change the pedal resistance using the and buttons. The pedal resistance can be changed in the range between the maximum of "exercise period" (4.0 kg·m) and the minimum of "relief period" (0.5kg·m); it increases/decreases while the exercise pattern shape is maintained.

**Reference:** When the pedal resistance is changed, the entire pattern changes. However, the data for the exercises already completed does not change.

- Pressing the button switches the numeric value displayed.

**Caution:** If your pulse rate exceeds the upper limit, "STOP EXERCISE" blinks in the display, training finishes forcibly, and the pedal resistance drops to the minimum.

- Reference:**
- If the pedal cadence is not detected for five seconds, the pause display appears. At this time, the specified training duration is interrupted and "PAUSE" blinks in the display. When pedaling starts again, the specified training duration recommences.
  - A maximum of 10-minutes' worth of data can be displayed. After 10 minutes, 5-minutes' worth of exercise graph scrolls to the left.

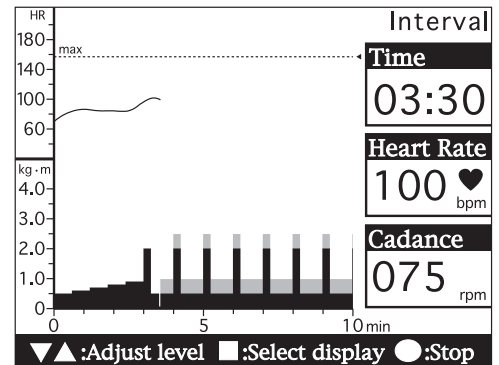

### Changing the display

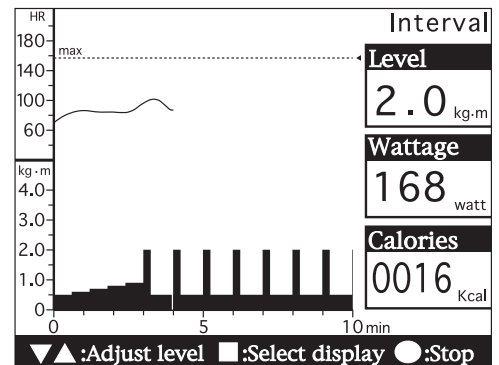
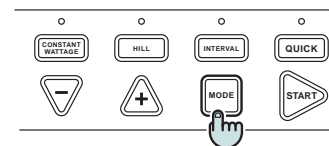

## 6

### Finish your exercise.

- When the specified duration elapses or when the button is pressed, a buzzer sounds and the 5-minute cool-down phase begins. Pulse detection stops, and the pedal resistance drops to the minimum of 0.5 kg·m.
- To complete the cool-down phase, remain in cool-down mode. Data such as the remaining cool-down time (Count Down), your pulse rate, and other information are displayed. The total calories are accumulated.
- When a period of five minutes elapses or when the button is pressed, the cool-down phase ends and the training program finishes. The exercise progression at the end of the training program appears in the display.

**Caution:** You cannot return to the exercise display from the cool-down display or the end display.

- You can monitor the exercise progression graph by scrolling the screen using the and buttons.

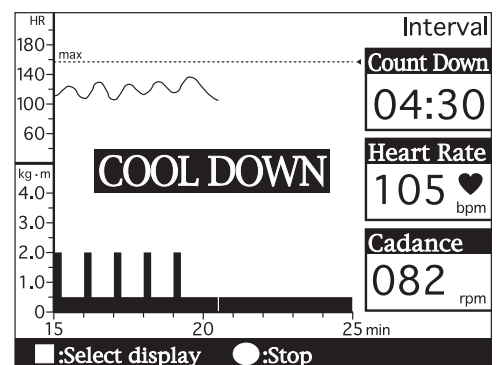

## 7

### End the program.

- Press the button to bring up the initial display again.
- To finish the entire program, turn off the power switch at the back of the main unit.

### Ending program

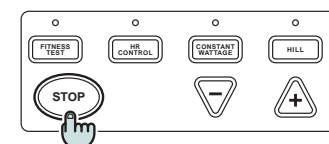

## 1 Select the Quick start program.

- Attach the earlobe sensor, and press the **QUICK** training selection button to start the Quick start training program.
- A buzzer sounds, and start the training.

**Reference:**

- In the Quick start training program, no conditions are specified. The upper pulse limit is fixed to 160 bpm.
- Maximum exercise time is 95 minutes. If it exceeds 95 minutes, cool-down phase begins automatically.

## Start the warm-up.

- "START WARM-UP" appears in the display. Start pedaling slowly.
- The pedal resistance automatically changes so that it becomes 1.0 kg·m within three minutes of the start of warm-up.

**Reference:** When the **START** button is pressed during warm-up, or when the pedal resistance is changed to 1.0 kg·m or more using the **▽** or **△** button, the warm-up is skipped.

- The pedal resistance (torque) is indicated in the lower part of the graph on the display. One dot along the horizontal axis represents three seconds while two dots along the vertical axis represent 0.1 kg·m.
- The blinking numeric value in the upper part of the graph indicates the pulse at that point. One dot along the vertical axis represents 2 bpm.
- Every three seconds, a row of dots blinks. Thus, the training status can be monitored.

Selecting training program

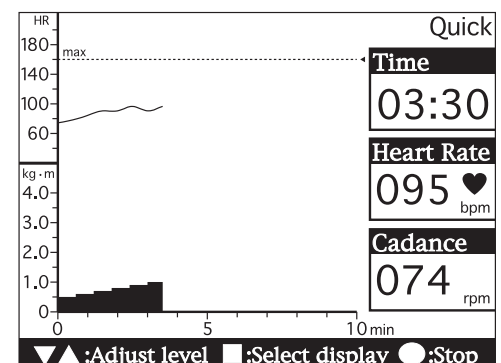
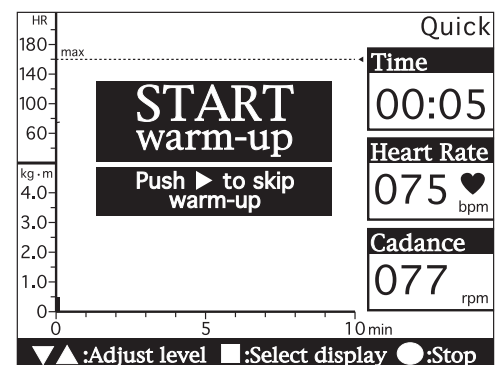
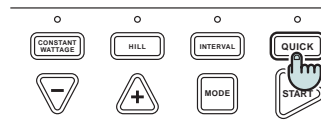

## 2 Continue the training.

- When the warm-up period finishes, change the pedal resistance as desired using the **▽** and **△** buttons and then proceed with the training program.
- Pressing the **MODE** button switches the numeric value displayed.

**Caution:** If your pulse rate exceeds the upper limit, "STOP EXERCISE" blinks in the display, training finishes forcibly, and the pedal resistance drops to the minimum.

**Reference:**

- If the pedal cadence is not detected for five seconds, the pause display appears. At this time, the specified training duration is interrupted and "PAUSE" blinks in the display. When pedaling starts again, the specified training duration recommences.
- A maximum of 10-minutes' worth of data can be displayed. After 10 minutes, 5-minutes' worth of exercise graph scrolls to the left.

Changing the display

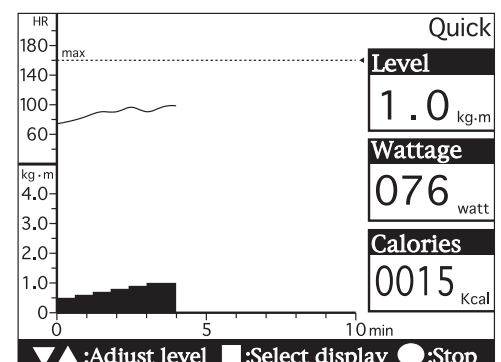
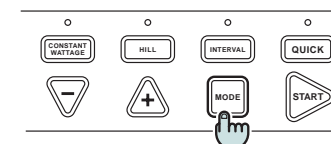



### 3 Finish your exercise.

- To stop the program, press the **STOP** button; the training program ends and the 5-minute cool-down period begins. The pedal resistance drops to the minimum of 0.5 kg·m.
- To complete the cool-down phase, remain in cool-down mode. Data such as the remaining cool-down time (Count Down), your pulse rate, and other information are displayed. The total calories are accumulated.
- When a period of five minutes elapses or when the **STOP** button is pressed, the cool-down phase ends and the training program finishes. The exercise progression at the end of the training program appears in the display.  
**Caution:** You cannot return to the exercise display from the cool-down display or the end display.
- You can monitor the exercise progression graph by scrolling the screen using the **▽** and **△** buttons.

### 4 End the program.

- Press the **STOP** button to bring up the initial display again.
- To finish the entire program, turn off the power switch at the back of the main unit.

#### Finishing training

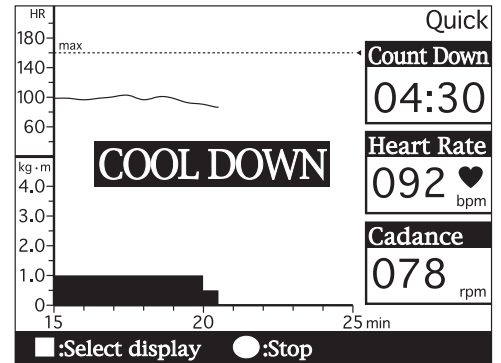
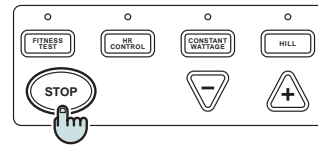

#### Ending program

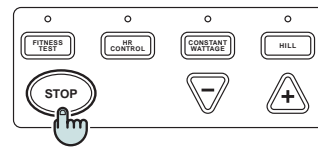

# 10

## HOW TO MAKE A DATA CARD

If you record your training conditions to this "Data Card", you can set the conditions merely by inserting the card into the card inlet of the control unit. You can start a program just by inserting the card and pressing the  button, saving all the button operation process.

To record your conditions to the data card, scratch off the appropriate silver part on the back of the card with a coin etc. This removal allows the photo scanner in the control unit to detect the position of the exposed part. Now let's make your "Data Card."

**Caution:** One Data Card is necessary for each of the desired conditions. You cannot specify two or more conditions on one card.

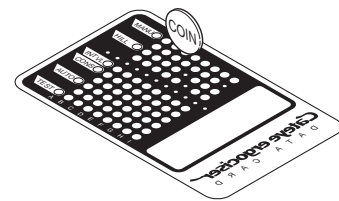
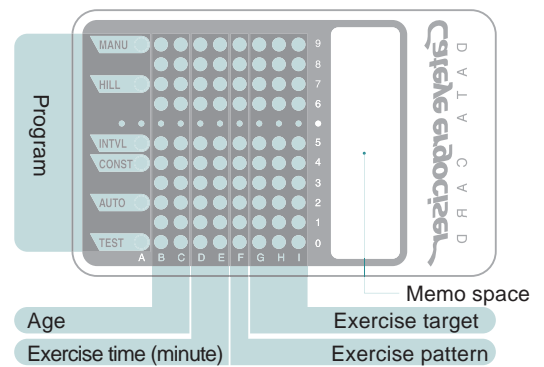

### 1 Specify program.

- Specify the program in "A".
  - HR control training: AUTO
  - Constant wattage control training: CONST
  - Hill training: HILL
  - Interval training: INTVL

**Caution:** Though MANU (= Quick start) is shown on the Data Card, this program cannot be specified on the model EC-C400R Ergometer.

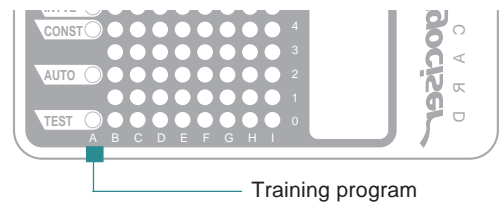

### 2 Specify age.

- Specify your age in "B" and "C".
- "B" indicates the first digit of your age, "C" indicates the second.

Example: Age 35 years  
 Enter "3" in "B" column  
 Enter "5" in "C" column

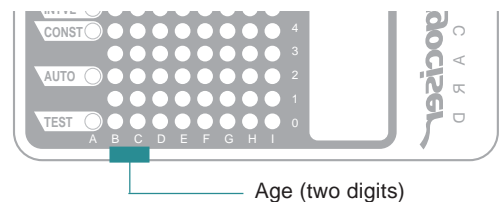

### 3 Specify exercise time.

- Specify your exercise time in "D" and "E".
- "D" indicates the first digit of the exercise time, "E" indicates the second.

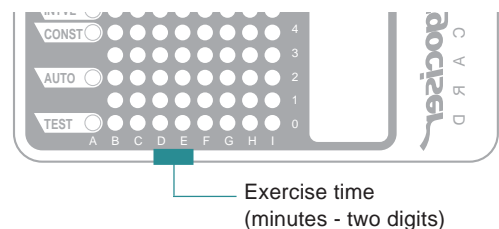

### 4 Specify exercise pattern.

- Specify the exercise pattern in "F" when the "Interval training" or "Hill training" is selected.
- What you specify in "F" is invalid for other exercise programs.
- For Interval training, choose one of 1 ~ 3.
- For Hill training, choose one of 1 ~ 3.

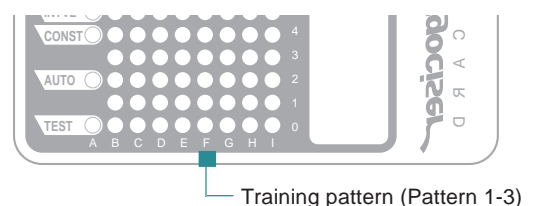

## 5 Specify training target.

- Specify the training target in "G", "H" and "I".
  - HR control training  
Specify the target pulse rate. "G" indicates the first digit of the value, "H" indicates the second and "I" indicates the third digit.
  - Constant Wattage Control Training  
Specify the set wattage. "G" indicates the first digit of the wattage, "H" indicates the second, and "I" indicates the third digit.
  - Hill training  
What you specify in "G", "H", "I" is invalid.
  - Interval training  
What you specify in "G", "H", "I" is invalid.

**Reference:** When making a Fitness test data card

Specify your weight in "D", "E", and "F". "D" is for the third digit, "E", the second digit, and "F", the first digit. Your sex is specified in "G". "0" indicates female, and "1" indicates male.

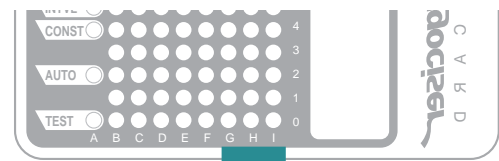

Target pulse rate (bpm - 3 digits)

### Sample data cards

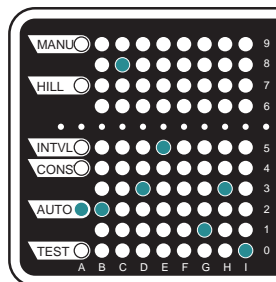

#### HR control training

Age: 28 years  
Exercise time: 35 minutes  
Target pulse rate: 130 bpm

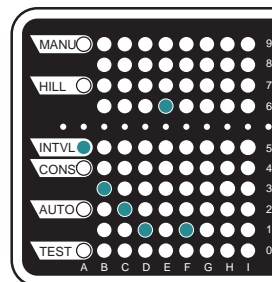

#### Interval training

Age: 32 years  
Exercise time: 16 minutes  
Pattern: 1

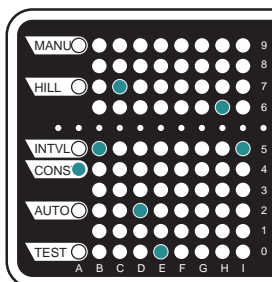

#### Constant Wattage training

Age: 57 years  
Exercise time: 20 minutes  
Target wattage: 65 watts

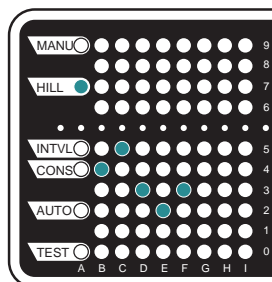

#### Hill training

Age: 45 years  
Exercise time: 32 minutes  
Pattern: 3 (The Pyrenees)

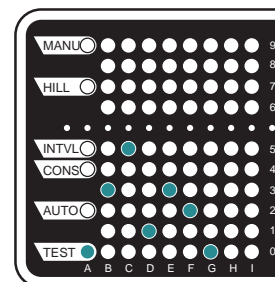

#### Fitness test

Age: 35 years  
Weight: 132 lb  
Sex: Female

### Cautions on Handling the Data Card

- Treat the card with care. Do not bend or allow the card to become wet.
- Scratch only the necessary part of the silver ink. Otherwise the sensor will not read out the data.
- Wipe the residue of the scratched silver ink off the card before inserting the card into the control unit.
- The blank space on the card can be utilized as memo space to enter the programmed data, user's name etc.
- If you have scratched incorrect data, use "white out" to cover the hole. If the light doesn't go through the hole that you have covered up, the card can be used normally.

**Caution:** If "CARD ERROR" appears on the LCD when you insert the card, check whether any incorrect or unnecessary point has been scratched out.

## REFERENCE GUIDE

<b>1</b>	<b>Chest-belt heart rate sensor .....</b>	<b>46</b>
<b>2</b>	<b>Other useful functions.....</b>	<b>48</b>
<b>3</b>	<b>Troubleshooting.....</b>	<b>49</b>
<b>4</b>	<b>Daily maintenance/repair service warranty/ additional parts .....</b>	<b>50</b>
<b>5</b>	<b>Product specifications .....</b>	<b>51</b>



# 1

## CHEST-BELT HEART RATE SENSOR

### Use the wireless chest-belt heart rate sensor.

In the EC-C400R, the heart rate can be measured using the optional wireless chest-belt heart rate sensor instead of the earlobe sensor.

Therefore, in cases where it is difficult to detect the heart rate using the earlobe sensor, the heart rate measurement can still be carried out accurately.

The heart rate sensor receiver is embedded in the control unit. Thus, a wireless measurement can be carried out by simply adding the chest-belt heart rate sensor.

**Important:** When the chest-belt sensor is used, remove the earlobe sensor plug from the control unit. Signals from the chest-belt sensor cannot be received if the earlobe sensor is connected.

### Function of the chest-belt heart rate sensor

The wireless chest-belt heart rate sensor uses a miniaturized and simplified version of the of electrocardiography concept used in hospitals. For an electrocardiogram, multiple electrodes are attached to the body, and the electric potential difference between them is used to calculate the heart rate. The chest-belt heart rate sensor's two internal electrodes are applied to the body and detect the electric potential difference, providing a simpler way of detecting heartbeats. This information is sent to the control unit by radio waves, so even hard training is possible. The chest-belt heart rate sensor uses the chest-belt (transmitter) and the signal-receiving circuit board (receiver) contained in the control unit to read your heart rate and calculate and display your per-minute pulse.

### Before putting on the chest-belt heart rate sensor



**Warning** Pace maker users should never use this device.

#### Caution:

- Put on the chest-belt heart rate sensor at the center of your chest and in contact with your skin.
- To increase measurement effectiveness, dampen the electrode area with water or electrocardiograph electrolyte cream.
- People with sensitive skin can put on the chest-belt over a thin shirt with electrode area damped with water.
- Hair on the chest may interfere with accurate measurements.

### Put on the chest-belt heart rate sensor.

Put it on following the procedure below.

1. Adjust the length of the attachment belt to fit your chest.

**Caution:** May be painful if tightened too much.

2. Hook the attachment belt to the electrode belt. Place the electrode area at the center of your chest. Be sure that the electrode area is held firmly against your skin.

**Reference:** When wearing the chest-belt heart rate sensor over a shirt it is necessary to moisten the electrode area for the better results. In the winter season when skin can be dried, errors may occur even when the electrodes are in direct contact with your skin. This can be improved by moistening the electrodes.

3. Adjust the belt so that the transmitter is at the center (just above your diaphragm) of your chest.

**Reference:** When wearing the chest-belt heart rate sensor over a shirt it is necessary to moisten the electrode area for the better results.

The chest-belt heart rate sensor uses a lithium battery. The lithium battery has a limited lifetime; when changing the battery, refer to the Reference Guide, page 47, "Maintenance of the chest-belt heart rate sensor."

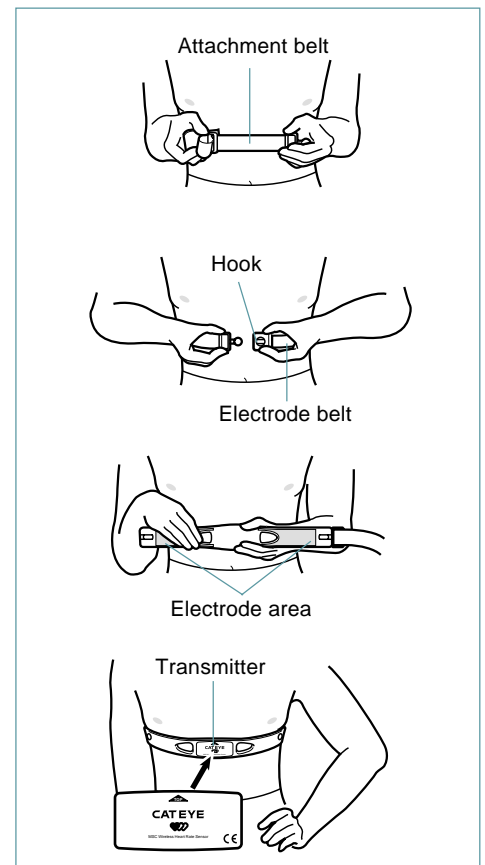

## Maintenance of the chest-belt heart rate sensor



### Warning

After removing the battery from the sensor, dispose of it properly. Be sure to keep it out of the reach of small children. If through some accident it is swallowed, contact a physician immediately.

### Replace the battery.

Battery life: approx. 2 years (if used for 1 hour per day)

\* The battery life shown in this manual is not definitive and it varies depending on the use environment.

**Caution:**

- **The chest-belt heart rate sensor continues to consume battery while being attached to your body. When you are not measuring heart rate, remove it from your chest to save the battery life.**
- **The battery cover seal is critical for maintaining its watertight capacity. Check the battery cover for proper fit and positioning closing.**

When the factory loaded battery has worn out, replace it with a new one according to the following instruction:

1. Remove the battery cover on the back of the transmitter with a coin.
2. Remove the battery and insert a new lithium battery (CR2032). Insert as shown in the picture, so that the + side is visible.
3. Close the battery cover tightly.

### Replace the electrode belt.

The electrode belt will deteriorate after a long time of use. If there are cracks in the outer surface, or if measurement errors occur, follow the procedure below to change the electrode belt.

1. Loosen the 4 screws at the back of the transmitter.
2. Remove the spacers. Separate the transmitter from the electrode belt.
3. Wipe any dirt off of the two conducting parts of the transmitter, then insert it into a new electrode belt.

**Caution:** If there is dirt on the conducting parts, the heart rate sensor fail to detect the heart rate.

4. Fit the spacers on the right and left sides of the transmitter, and securely tighten the 4 screws.

**Reference:** When replacing the electrode belt, also check the transmitter's battery life.

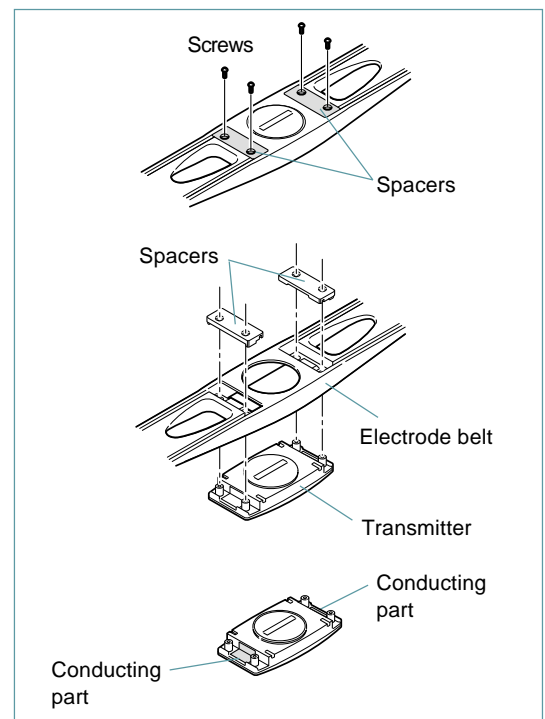
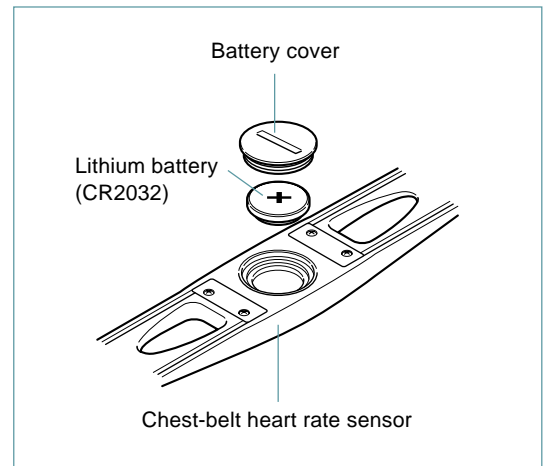

### Maintenance of the chest-belt heart rate sensor

For daily maintenance of the sensor:

- If the chest-belt heart rate sensor is dirty, wash with water, or wipe with a diluted neutral detergent and a soft cloth. Then wipe it dry. Do not use organic solvents such as benzene and alcohol, which will damage the surface.
- The attachment belt will become particularly soaked with sweat. This can be unhygienic if left as is. Clean the belt with a neutral detergent.

# 2

## OTHER USEFUL FUNCTIONS

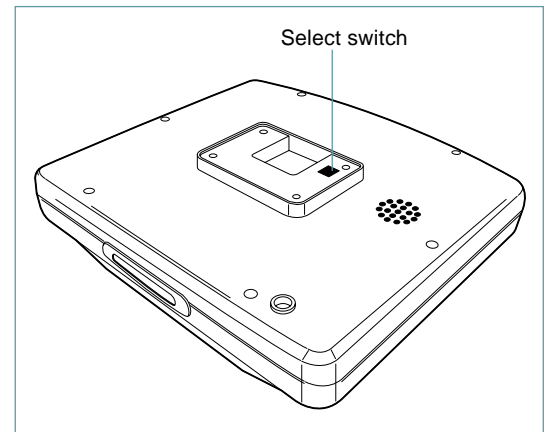

### Change the units of weight.

No. 1	Units of weight
ON .....	lb
OFF .....	kg

- The units of weight can be changed using select switch No. 1 at the back of the control unit.
- When the switch is “ON”, units are in lbs “pounds”. When the switch is “OFF”, units are in kg (“kilograms”).

**Reference:** When the select switch settings have been changed and the power switch is then turned on, the new settings become activated.

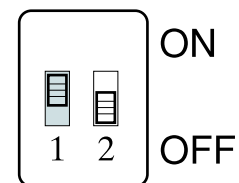

### Change the units of resistance of pedaling.

No. 2	Units of resistance of pedaling
ON .....	N·m
OFF .....	kg·m

- The units of resistance of pedaling can be changed using select switch No. 2 at the back of the control unit.
- When the switch is “ON”, units are in is N·m. When the switch is “OFF”, units are in kg·m.

**Reference:** When the select switch settings have been changed and the power switch is then turned on, the new settings become activated.

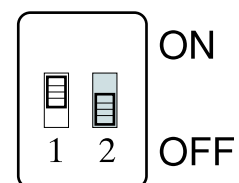



# 3

## TROUBLESHOOTING

### Troubleshooting

In the following cases, the machine is not broken. Be sure to check the following before asking for the machine to be serviced.

<b>Problem</b>	<b>Item to check</b>	<b>Countermeasure</b>
Display does not appear.	Is the power supply connected?	Connect the AC adaptor correctly. (see page 13)
	Is the power switch on?	Turn the power on. (see page 13)
	Isn't the cable of the AC Adapter damaged?	Replace the AC Adapter if its interior circuit or the cable is damaged. Use only CAT EYE AC Adapter.
ERROR or irregular display appears when you insert the data card.	Isn't the data card reversed?	Hold the card yellow arrow side up, and insert to the direction of arrow.
	Didn't you insert the card too quickly?	Insert the card slowly.
	Didn't you specify two or more programs, or open unnecessary holes?	Refer to P.42~43 and specify the program and conditions correctly.
When the pulse (earlobe) sensor is used, the pulse rate displayed on the control unit remains at "0". The pulse rate increases abnormally.	Is the earlobe sensor attached correctly to your earlobe?	Attach the sensor correctly to your earlobe and take care not to swing the sensor or sensor cable during the exercise. If the sensor cable proves to be damaged, replace the whole pulse sensor with a new one.
	Is the sensor plug completely inserted into the sensor jack?	
	Isn't the sensor cable damaged?	
When the chest-belt sensor is used, the pulse rate displayed on the control unit remains at "0".	Is the earlobe sensor plug connected to the control unit?	When the earlobe sensor is connected, signals from the chest-belt sensor are not received. Remove the earlobe sensor plug from the control unit.
	Is the chest belt attached correctly?	Attach the chest belt correctly according to the procedure.
	Is the chest belt loose?	Attach the chest belt with the electrode area making contact with your body.
	Is the air dry? (especially in winter)	Slightly dampen the electrode area of the chest belt.
	Has the electrode belt deteriorated or has it become worn or damaged due to long-term use?	Replace it with a new electrode belt.
	Is the battery low?	Replace it with a new battery.
When the chest-belt sensor is used, the pulse rate displayed on the control unit indicates "0" or measurement starts.	Is the chest belt attached correctly?	Attach the chest belt correctly according to the procedure.
	Does the pulse rate indicate "0" at a distance from the control unit and does measurement start when closer to the unit?	The battery is low. Replace it with a new battery. If the problem persists, check the receiving board in the control unit.
The evaluation of fitness level seems incorrect.	Is the weight unit correct?	Set the weight unit correctly. (see page 48)
The exercise program indicates "STOP EXERCISE" and ends prematurely.	Does a buzzer sound because your pulse rate exceeds the upper pulse limit specified in the program?	Set your age properly so that the alarm does not sound.
Clattering noise is heard with the pedal rotation.	Are the pedals firmly attached to the crank? If not, noise may be produced.	Attach the pedals firmly.

# 4

## DAILY MAINTENANCE

## /REPAIR SERVICE WARRANTY/ADDITIONAL PARTS

Please observe the following to ensure that you will have many years of good use from your EC-C400R Ergometer.



### Caution

- When the EC-C400R is not in use, shut the power switch OFF and disconnect the power cord from the outlet.
- Do not wipe the main unit with organic solvents such as thinner, kerosene, gasoline and alcohol. When dirty, wipe the unit with a cloth soaked in a neutral detergent, then wipe well with a dry cloth.
- In case of problems contact your dealer where the unit was purchased.

### About the repair service warranty

- If trouble with this EC-C400R Ergometer due to material of manufacturing defect should occur, under normal usage conditions, within three (3) years from the date of purchase, Cat Eye Co., Ltd. will repair or replace the product/part, subject to the contents of the included warranty card.
- If service is necessary, please contact your dealer where the unit was purchased.
- The warranty covers the main unit and control unit only. Accessories such as the pulse sensor are not covered.

### Accessories/Consumable Parts

Data cards (10 cards)  
(Part no. 7816120)

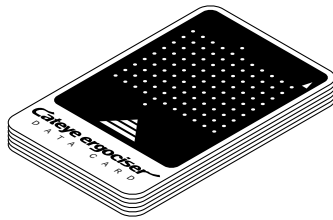

Pulse sensor (Middle)  
(Part no. 7801102)

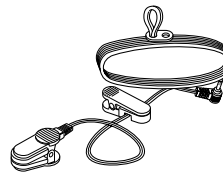

### Additional Parts

Chest-belt heart rate sensor  
(Part no. 1699806)

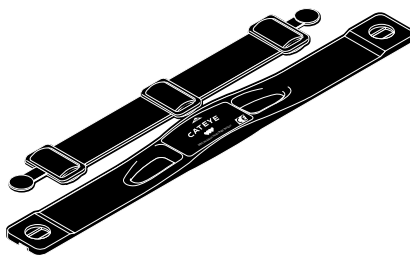

Replacement electrode belt  
(Part no. 1699826)

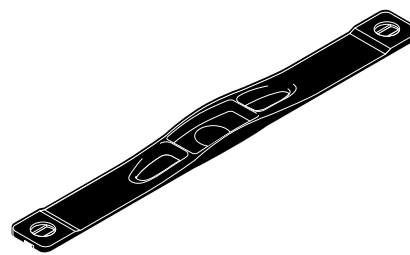

Mounting belt  
(Part no. 1699816)

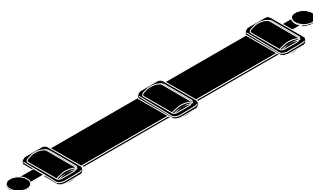

Lithium battery CR2032  
(For chest-belt heart rate sensor)  
(Part no. 1665150)





# PRODUCT SPECIFICATIONS

Item	Specifications		
Power source	Domestic power (AC120V)		
Power consumption	Max. approx. 20W		
Loading system	Eddy current system		
Speed increasing mechanism	2-step speed increase via timing belt		
Control system	8-bit microcomputer control system		
Display system	Back-lit liquid crystal display (full dot: 320x240)		
Display functions	Function	Display range	
	Pulse rate	Line chart display	40 to 200 bpm
		Numeric display	0 (50) to 200 bpm
	Pedal cadence	Numeric display	20 to 199 rpm
	Exercise Time	Numeric display	0'00" to 95'59"
	Calories consumption	Numeric display	0 to 999 Kcal (Estimated value)
	Load level (Pedal resistance)	Histogram display (blinking at the current point)	0 to 4.0 kg·m (0 to 40 N·m)
			Numeric display
		Wattage	Numeric display
	Date input system	Optical card (Use specified cards only) and buttons	
Pulse sensor	Photoelectric pulse wave detection type earlobe pulse sensor (with special external light reduction system) [Receiver board for the wireless heart rate sensor embedded: Can be received using the optional "Chest belt" (Polar compatible)]		
Exercise program	Program	Specifications	
	Fitness test	Fitness test by measuring the MOU value Measurement range: Age 20 to 69	
	HR control	Training program with a fixed pulse rate Setting range: 75 to 168 bpm	
	Constant wattage control	Training with a fixed wattage Setting range: 25 to 200 watt	
		Interval	Interval training selected from three types of exercise pattern
	Hill profile	Hill profile training which is selected from three types of mountain-like exercise pattern	
	Quick	Training with a fixed pedal resistance (changed using buttons) Setting range: 0.5 to 4.0 kg·m (5 to 40 N·m)	
Alarm function	Upper pulse limit alarm, Setting time end alarm		
Buzzer sound	Buzzer when a button is pressed, Buzzer when training starts		
User's weight limit	286 lb (130kg)		
Dimension/weight	Length	75-3/16" (1910 mm)	
	Height	38" (965 mm)	
	Width	22-1/16" (560 mm)	
	Seat to crank axle distance	14-31/32 to 26-25/32" (380 to 680 mm)	
		Seat height	11-11/32 to 19-3/32" (288 to 485 mm)
	Crank axle	17/1/8" (435 mm)	
	Weight	approx. 79 lb (approx. 36 kg)	

Copyright© 2001  
Cateye Co., Ltd.  
Printed in Japan  
ECMEC40R-020225-2

U.S. Pat Nos. 4775145/5230673 and Design Patented.

\* The specifications and design are subject to alteration without notice for improvement purpose.

\*\* "CAT EYE" is registered trademarks of CAT EYE CO., LTD.



**CATEYE CO., LTD.**

---

2-8-25, Kuwazu, Higashi Sumiyoshi-ku, OSAKA, 546-0041 JAPAN  
PHONE: 81-6-6719-7781 FAX: 81-6-6719-2362

CE

066660061 (E)

## Free Manuals Download Website

<http://myh66.com>

<http://usermanuals.us>

<http://www.somanuals.com>

<http://www.4manuals.cc>

<http://www.manual-lib.com>

<http://www.404manual.com>

<http://www.luxmanual.com>

<http://aubethermostatmanual.com>

Golf course search by state

<http://golfingnear.com>

Email search by domain

<http://emailbydomain.com>

Auto manuals search

<http://auto.somanuals.com>

TV manuals search

<http://tv.somanuals.com>