

# PROGRAMMING GUIDE

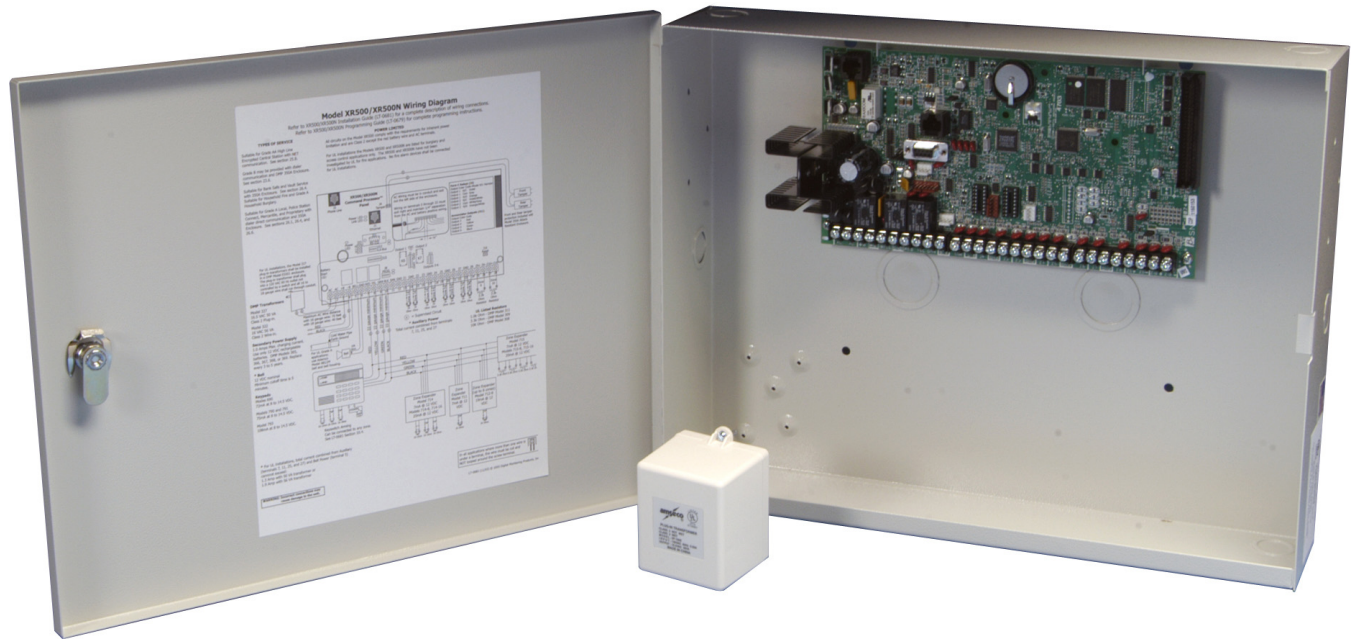

## **XR500 SERIES CANADIAN COMMAND PROCESSOR™ PANEL**

# **MODEL XR500 SERIES CANADIAN ACCESS CONTROL COMMAND PROCESSOR™ PANEL PROGRAMMING GUIDE**

Contains programming Instructions for use with the Model  
XR500, XR500N, XR500E Canadian Access Control Command Processor™ Panels.

When using the XR500 Series Canadian panel for any ULC other listing organization's approved methods, refer to this manual and the XR500 Series Canadian Installation Guide (LT-0681CAN). These documents outline the installation and programming requirements of all applications for which the XR500 Series is approved.

## **INDUSTRY CANADA NOTICE**

This Class A digital apparatus complies with Canadian ICES-003.

© 2009 Digital Monitoring Products, Inc.

Information furnished by DMP is believed to be accurate and reliable.  
This information is subject to change without notice.

# TABLE OF CONTENTS

1.1	Before you Begin .....	1
	Programming Information Sheet .....	1
1.2	Getting Started .....	1
1.3	Encrypted Communications (XR500N/XR500E only).....	2
1.4	Programmer Operation.....	2
1.5	Programmer Lockout Codes.....	2
1.6	Reset Timeout.....	2
1.7	Power Up .....	3
1.8	Keypads .....	3
1.9	Special Keys .....	3
1.10	Entering Alpha Characters .....	4
1.11	Entering Non-Alpha Characters .....	4
1.12	Keypad Displays Current Programming .....	4
1.13	Multiple Displays.....	5
1.14	Asterisks in Programming .....	5
<b>Initialization.....</b>		<b>6</b>
2.1	Initialization .....	6
2.2	Clear All Memory .....	6
2.3	Clear All Codes .....	6
2.4	Clear All Schedules .....	6
2.5	Clear Display Events Memory.....	6
2.6	Clear Zone Information .....	6
2.7	Clear Area Information.....	6
2.8	Clear Output Information .....	6
2.9	Clear Communication and Remote Options .....	7
2.10	Set to Factory Defaults.....	7
<b>Communication.....</b>		<b>8</b>
3.1	Communication .....	8
3.2	Account Number.....	8
3.3	Transmit Delay .....	8
3.4	Communication Path.....	8
3.5	Communication Type.....	8
3.6	Path Type.....	9
3.7	Test Report .....	9
3.8	Test Frequency .....	9
3.9	Test Day .....	9
3.10	Test Time.....	9
3.11	Check In .....	9
3.12	Fail Time.....	9
3.13	Encryption (XR500E only).....	9
3.14	Receiver IP.....	9
3.15	Receiver Port.....	10
3.16	First Telephone Number .....	10
3.17	Second Telephone Number .....	10
3.18	Advanced Programming .....	10
3.19	First GPRS APN / Second GPRS APN.....	10
3.20	Fail Test Hours.....	10
3.21	Protocol .....	10
3.22	Retry Seconds .....	11
3.23	Substitution Code .....	11
3.24	232 Communication Port .....	11
3.25	232 Setup String.....	11
3.26	893A.....	11
3.27	Alarm Switch .....	11
3.28	Duplicate Alarms.....	11
3.29	Alarm Reports .....	12
3.30	Supervisory/Trouble Reports.....	12
3.31	Opening/Closing and User Reports.....	12
3.32	Door Access Report.....	12
3.33	Send Communication Trouble .....	12
3.34	Send Path Information .....	12
<b>Network Options (XR500N/XR500E only) .....</b>		<b>13</b>
4.1	DHCP Mode Enabled .....	13
4.2	Local IP Address .....	13

# TABLE OF CONTENTS

4.3	Gateway Address .....	13
4.4	Subnet Mask .....	13
4.5	DNS Server .....	13
4.6	Passphrase (XR500E only) .....	13
<b>Messaging Setup .....</b>		<b>14</b>
5.1	Messaging Setup .....	14
5.2	Enable Messaging .....	14
5.3	System Name .....	14
5.4	Destination 1 .....	14
5.5	Destination 1 User Number .....	14
5.6	Destination 2 .....	14
5.7	Destination 2 User Number .....	14
5.8	Destination 3 .....	14
5.9	Destination 3 User Number .....	15
5.10	Email Communication Type .....	15
5.11	O/C Email .....	15
5.12	O/C SMS .....	15
5.13	Monthly Limit .....	15
5.14	SMTP Server .....	15
5.15	SMTP Server Port .....	15
5.16	SMTP Username .....	15
5.17	SMTP Password .....	15
5.18	From Email Address .....	15
<b>Device Setup .....</b>		<b>16</b>
6.1	Device Setup .....	16
6.2	Device Number .....	16
6.3	Door Name .....	16
6.4	Access Areas .....	16
6.5	Egress Areas .....	16
6.6	Display Areas .....	17
6.7	Strike Time .....	18
6.8	Strike Delay .....	18
6.9	Fire Exit Release .....	18
6.10	Output Group .....	18
6.11	Schedule Override .....	18
6.12	Auto Force Arm Device? .....	18
6.13	Door Real-Time Status? .....	18
6.14	Send Door Forced Message? .....	18
6.15	Program 734 Options .....	19
6.15.1	Activate Zone 2 Shunt .....	19
6.15.2	Zone 2 Soft-Shunt Time .....	19
6.15.3	Relock on Zone 2 Fault? .....	19
6.15.4	Activate Zone 3 Request to Exit .....	19
6.15.5	Zone 3 REX Strike Time .....	19
6.15.6	Activate Onboard Speaker .....	20
6.15.7	Card Options .....	20
6.15.8	Custom Card Definitions .....	20
6.15.8.1	Site Code Position .....	20
6.15.8.2	Site Code Length .....	20
6.15.8.3	User Code Position .....	20
6.15.8.4	User Code Length .....	20
6.15.9	Require Site Code .....	21
6.15.9 .	Site Code Display .....	21
6.15.10	Number of User Code Digits .....	21
6.15.11	Degraded Mode .....	21
<b>Remote Options .....</b>		<b>22</b>
7.1	Remote Options .....	22
7.2	Remote Key .....	22
7.3	Remote Disarm .....	22
7.4	Allow Dialer Remote .....	22
7.4.1	Armed Answer Rings .....	22
7.4.2	Disarmed Answer Rings .....	22
7.4.3	PC Modem .....	23
7.4.4	Manufacturer Authorization .....	23
7.5	Allow Network Remote .....	23
7.5.1	Network Programming Port .....	23

# TABLE OF CONTENTS

7.5.2	Encrypt Network Remote.....	23
7.6	Allow Cellular Remote .....	23
7.6.1	First GPRS APN / Second GPRS APN.....	23
7.6.2	Encrypt Cellular Remote .....	23
7.7	Allow RS-232 Remote.....	23
7.8	Entré Connection .....	23
7.8.1	Entré Incoming TCP Port .....	23
7.8.2	Entré IP Address.....	23
7.8.3	Entré Outbound TCP Port .....	23
7.8.4	Entré Backup IP Address .....	24
7.8.5	Entré Backup TCP Port .....	24
7.8.6	Entré Checkin .....	24
7.8.7	Entré Passphrase .....	24
7.9	Send Local Changes.....	24
7.9.1	Remote Change IP.....	24
7.9.2	Remote Change Port.....	24
7.9.3	Remote Telephone Number .....	24
<b>System Reports.....</b>		<b>25</b>
8.1	System Reports .....	25
8.2	Abort Report .....	25
8.3	Restoral Reports .....	25
8.4	Bypass Reports.....	25
8.5	Schedule Change Reports.....	25
8.6	Code Change Reports .....	25
8.7	Access Keypads .....	25
8.8	Ambush .....	26
8.9	Panic Test Communication (XR500N/XR500E only) .....	26
<b>System Options.....</b>		<b>27</b>
9.1	System Options .....	27
9.2	System .....	27
9.3	Instant Arming .....	27
9.4	Closing Wait.....	27
9.5	Entry Delay 1 .....	27
9.6	Cross Zone Time.....	28
9.7	Zone Retard Delay .....	28
9.8	Power Fail Delay .....	28
9.9	Swinger Bypass Trips .....	28
9.10	Reset Swinger Bypass .....	28
9.11	Time Zone Changes .....	28
9.12	Latch Supervisory Zones.....	29
9.13	Programming Menu Language .....	29
9.14	User Menu and Status List Language .....	29
9.15	Bypass Limit.....	30
9.16	Card Plus PIN (XR500E only) .....	30
9.17	House Code.....	30
9.18	Detect Wireless Jamming .....	30
9.19	Wireless Audible Annunciation .....	31
9.20	Enable Keypad Panic Keys .....	31
9.21	Occupied Premises.....	31
9.22	Enhanced Zone Test.....	31
9.23	Dual EOL.....	31
9.24	Send 16 Character Names .....	31
<b>Bell Options.....</b>		<b>32</b>
10.1	Bell Options.....	32
10.2	Bell Cutoff Time.....	32
10.3	Automatic Bell Test .....	32
10.4	Bell Output.....	32
10.5	Bell Action.....	32
10.5.1	Fire Bell Action .....	32
10.5.2	Burglary Bell Action.....	32
10.5.3	Supervisory Bell Action.....	32
10.5.4	Panic Bell Action .....	32
10.5.5	Emergency Bell Action.....	32
10.5.6	Auxiliary 1 Bell Action.....	32
10.5.7	Auxiliary 2 Bell Action.....	32

# TABLE OF CONTENTS

<b>Output Options.....</b>	<b>33</b>
11.1 Output Options.....	33
11.2.1 Cutoff Output .....	33
11.2.2 Output Cutoff Time.....	33
11.3 Communication Trouble Output.....	33
11.4 Fire Alarm Output.....	33
11.5 Fire Trouble Output.....	33
11.6 Panic Alarm Output.....	34
11.7 Ambush Output .....	34
11.8 Entry Output .....	34
11.9 Exit Output.....	34
11.10 Ready Output.....	34
11.11 Telephone Trouble Output .....	34
11.12 Late To Close Output .....	34
11.13 Device Fail Output .....	34
11.14 Sensor Reset Output.....	34
11.15 Closing Wait Output.....	35
11.16 Arm-Alarm Output .....	35
<b>Output Information .....</b>	<b>36</b>
12.1 Output Information.....	36
12.2 Output Number .....	36
12.3 Output Name .....	36
12.4 Output Real-Time Status .....	36
12.5 Serial Number .....	36
12.6 Supervision Time .....	36
<b>Output Groups .....</b>	<b>37</b>
13.1 Output Groups.....	37
13.2 Group Number.....	37
13.3 Group Name .....	37
13.4 Output Number .....	37
<b>Menu Display.....</b>	<b>38</b>
14.1 Menu Display .....	38
14.2 Armed Status .....	38
14.3 Time .....	38
14.4 Arm/Disarm.....	38
<b>Status List.....</b>	<b>39</b>
15.1 Status List .....	39
15.2 Display Keypads .....	39
15.3 System Monitor Troubles .....	39
15.4 Fire Zones .....	39
15.5 Burglary Zones .....	40
15.6 Supervisory Zones .....	40
15.7 Panic Zones.....	40
15.8 Emergency Zones .....	40
15.9 Auxiliary 1 Zones .....	40
15.10 Auxiliary 2 Zones .....	40
15.11 Communication Trouble.....	40
<b>Printer Reports .....</b>	<b>41</b>
16.1 Printer Reports .....	41
16.2 Arm and Disarm Reports .....	41
16.3 Zone Reports.....	41
16.4 User Command Reports.....	41
16.5 Door Access Reports .....	41
16.6 Supervisory Reports .....	41
<b>PC Log Reports.....</b>	<b>42</b>
17.1 PC Log Reports.....	42
17.2 Communication Type.....	42
17.3 Net IP Address .....	42
17.4 Net Port .....	42
17.5 232 Communication Port .....	42
17.6 232 Setup .....	42
17.7 Arm and Disarm Reports .....	42
17.8 Zone Reports.....	42

# TABLE OF CONTENTS

17.9	User Command Reports.....	42
17.10	Door Access Reports .....	43
17.11	Supervisory Reports .....	43
17.12	PC Log Real-Time Status .....	43
<b>Area Information .....</b>		<b>44</b>
18.1	Area Information .....	44
18.2	Exit Delay.....	44
18.3	Burglary Bell Output.....	44
18.4	Opening/Closing Reports .....	44
18.5	Closing Check.....	45
18.6	Closing Code .....	45
18.7	Any Bypass .....	45
18.8	Area Schedules.....	45
18.9	Early Morning Ambush (XR500N/XR500E only) .....	45
18.10	Area Number.....	45
18.10.1	All/Perimeter Programming.....	45
18.10.2	Home/Sleep/Away Programming.....	46
18.11	Area Name.....	46
18.12	Account Number.....	46
18.13	Automatic Arming .....	46
18.14	Bad Zones .....	46
18.15	Automatic Disarming.....	46
18.16	Armed Output Number.....	47
18.17	Late Output Number .....	47
18.18	Late Arm Delay.....	47
18.19	Bank Safe & Vault (XR500N/XR500E only) .....	47
18.20	Common Area .....	47
18.21	Arm First Area .....	47
18.22	Two Man Rule (XR500N/XR500E only).....	47
<b>Zone Information.....</b>		<b>48</b>
19.1	Zone Information.....	48
19.2	Zone Number .....	48
19.3	Zone Name .....	48
19.4	Zone Type .....	49
19.5	Area Assignment.....	49
19.6	Fire Bell Output .....	49
19.7	Arming Zone Area Assignment.....	50
19.8	Style .....	50
19.9	Next Zone .....	51
19.10	Wireless.....	51
19.10.1	Serial Number Entry.....	51
19.10.2	Contact .....	51
19.10.3	Supervision Time .....	52
19.10.4	LED Operation .....	52
19.10.5	Disarm/Disable .....	52
19.10.6	PIR Pulse Count.....	52
19.10.7	PIR Sensitivity .....	52
1100 Series Key Fobs.....		53
19.11.1	Key Fob User Number .....	53
19.11.2	Key Fob Serial Number.....	53
19.11.3	Key Fob Supervision Time .....	53
19.11.4	Number of Key Fob Buttons .....	53
19.11.5	Key Fob Button Selection (Four Buttons).....	53
19.11.6	Key Fob Button Selection (Two Buttons) .....	53
19.11.7	Button Action .....	54
19.11.8	Button Press Time .....	54
19.11.9	Arm/Disarm Area Selection.....	54
19.11.10	Output Number .....	55
19.11.11	Output Action .....	55
19.11.12	Next Zone .....	55
19.12	Wireless.....	56
19.12.1	Check-in Time .....	56
19.12.2	Internal Contact .....	56
19.12.3	End-of-Line .....	56
19.12.4	Normally Open .....	56
19.12.5	Next Zone .....	56



# TABLE OF CONTENTS

19.13	Alarm Action.....	56
19.14	Disarmed Open .....	56
19.15	Report to Transmit.....	57
19.16	Output Number .....	57
19.17	Output Action.....	57
19.18	Swinger Bypass .....	58
19.19	Prewarn Keypad Addresses.....	58
19.20	Entry Delay .....	58
19.21	Zone Retard Delay .....	58
19.22	Presignal Keypad Addresses .....	58
19.23	Fast Response .....	58
19.24	Cross Zone .....	58
19.25	Priority .....	59
19.26	Fire Panel Slave Input .....	59
19.27	Area Follower .....	59
19.28	Zone Real-Time Status .....	59
19.28.1	Door Number .....	59
19.29	Zone Audit Days .....	59
19.30	Report with Account Number for Area .....	59
<b>Stop.....</b>		<b>60</b>
20.1	Stop .....	60
<b>Set Lockout Code .....</b>		<b>60</b>
21.1	Set Lockout Code.....	60
<b>Feature Upgrade .....</b>		<b>61</b>
22.1	Feature Upgrade.....	61
22.1.1	Encryption.....	61
22.1.2	All No Yes Option.....	61
22.1.3	Service User Authentication .....	61
	Purchasing Feature Upgrades .....	61
<b>Appendix .....</b>		<b>62</b>
23.1	False Alarm Reduction.....	62
	System Recently Armed report.....	62
23.2	Diagnostics function.....	62
23.3	Using the 984 Command Function.....	64
	Keypad Displays .....	64
23.4	Using the Walk Test .....	65
	Walk Test .....	65
	Zone Types.....	65
	Trip Counter For Walk Test .....	65
	Trip Counter For DMP Wireless Check-in Test (WLS) .....	66
	Test End Warning .....	66
	Local Printer for Walk Test.....	66
23.5	Keypad Speaker Operation .....	66
23.6	Cross Zoning .....	67
23.7	Events Manager.....	67
23.8	User Profiles.....	67
23.9	User Profiles Record.....	67
23.10	FA Series Transmitter Information .....	68
	Cross Talk .....	68
23.10.1	Wireless Check-in and Supervision Definitions .....	
23.11	Keypad Bus and LX-Bus Zone Type Descriptions.....	69
23.12	Zone Type Specifications .....	69
23.12.1	Keypad Bus Zone Type Defaults .....	70
23.14	Area Account Number Messages .....	73
<b>Revisions to This Document.....</b>		<b>74</b>
	Listings and Approvals .....	75



This page intentionally left blank.

## Introduction

### 1.1 Before you Begin

This guide provides programming information for the DMP XR500, XR500N, and XR500E Command Processor™ Panel. After this Introduction, the remaining sections describe the functions of each programming menu item along with the available options. Before starting to program, we recommend that you read through the contents of this guide. The information contained here allows you to quickly learn the programming options and operational capabilities of the XR500, XR500N, and XR500E panels.

In addition to this guide, you should also read and be familiar with the following XR500 Series Canadian documents:

- XR500 Series Canadian Installation Guide (LT-0681CAN)
- XR500 Series Canadian Programming Sheet (LT-0678CAN)
- XR100/XR500 Canadian Security Command® User's Guide (LT-0683CAN)

#### Internal Programmer

The panel contains all of its programming information in an on-board processor and does not require an external programmer. You can perform all programming tasks through a 32-character DMP alphanumeric keypad set to address one.

#### Programming Information Sheet

Included with each panel are the Programming Information Sheets. These list the various programming prompts and available options for programming the panel. Before starting to program, we recommend you completely fill out each sheet with the programming options you intend to enter into the panel.

Having completed programming sheets available before entering data helps prevent errors and can shorten the time you spend programming. Completed sheets also provide you with an accurate panel program record you can keep on file for future system service or expansion. The remainder of this Introduction provides instructions for starting and ending a programming session using the alphanumeric keypad.

### 1.2 Getting Started



**Ground Yourself Before Handling the Panel!** Touch any grounded metal, such as the enclosure, before touching the panel to discharge static.



**Remove All Power From the Panel!** Remove all AC and Battery power from the panel before installing or connecting any modules, cards, or wires to the panel.

Before starting to program the XR500 Series Canadian panel, make sure the panel is properly grounded and AC and battery power is applied to the appropriate panel terminals. All wiring connections and grounding instructions are detailed in the XR500 Series Canadian Installation Guide (LT-0681) (LT-0759).

#### Accessing the Programmer

1. Install the reset jumper across the two J16 reset pins for two seconds.
2. Remove the reset jumper and place it over just one pin for future use.
3. Enter the code 6653 (PROG) into a 32-character alphanumeric keypad set to address one, supervised mode. Press COMMAND.

4. The keypad displays PROGRAMMER.  
You are now ready to start programming the panel.

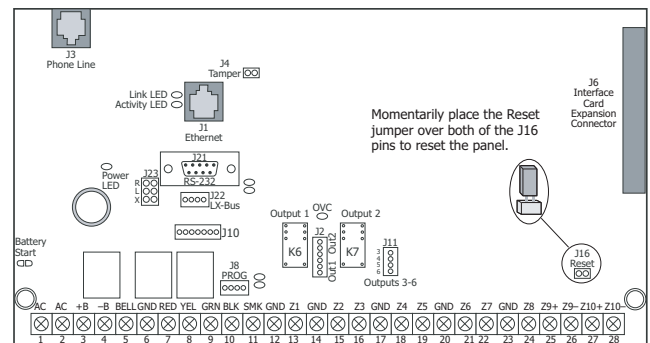

Figure 1: XR500 Series Canadian Panel Showing Reset

# INTRODUCTION

## 1.3 Encrypted Communications (XR500N/XR500E only)

Some installations require secure data communications. DMP offers NIST approved AES encrypted communication. Use a unique passphrase to enable encrypted communications and provide a secure means for data communications. See Network Options.

An XR500E panel communicates using AES encryption. If you currently have an XR500N panel installed, you may purchase a separate feature key to activate encrypted communications using the Feature Upgrade process. Encrypted communication cannot be enabled on a standard XR500 panel. For more information on the Feature Upgrade process see Section 21 in this document.

## 1.4 Programmer Operation

There are 21 programming sections to choose from:

Programming Item	Section in This Manual	Programming Item	Section in This Manual
Initialization	2	Output Information	12
Communication	3	Output Groups	13
Network Options	4	Menu Display	14
Messaging Setup	5	Status List	15
Device Setup	6	Printer Reports	16
Remote Options	7	PC Log Reports	17
System Reports	8	Area Information	18
System Options	9	Zone Information	19
Bell Options	10	Stop	20
Output Options	11	Set Lockout Code	21
		Feature Upgrade	22

To choose a section for programming, press any top row Select key when the keypad displays the name of that section. Sections 2 through 22 contain detailed instructions for each programming step.

## 1.5 Programmer Lockout Codes

The panel allows you to enter the programming function without entering a lockout code using steps 1 to 4 listed in Getting Started. We recommend, however, that you install a Lockout Code to restrict programming to only those persons your company authorizes. You can do this by using the SET LOCKOUT CODE feature in the Programmer. The Lockout Code restricts any unauthorized panel programming.

After resetting the panel and entering the code 6653, the keypad displays PROGRAMMER. Press COMMAND to advance through the programming sections until SET LOCKOUT CODE displays (after STOP). Press any top row Select key. The keypad displays ENTER CODE: -. Enter a 3 to 5 digit Programmer Lockout Code and press COMMAND. The keypad displays ENTER AGAIN followed by ENTER CODE: -. Enter the same 3 to 5 digit code a second time and press COMMAND. The keypad displays CODE CHANGED.

Note: The panel does not accept a 5-digit Lockout Code higher than 65535.

Before accessing programmer functions enter the new code number. Write the Lockout Code number down and keep it in a secure place with access limited to authorized persons only. Lost Lockout Codes require the panel to be sent back to DMP for repair. You may cancel a Lockout Code by entering 00000 at the Set Lockout Code command.

## 1.6 Reset Timeout

The panel has a feature that requires you to enter the Programmer within 30 minutes of resetting the panel. After 30 minutes, if you attempt to program by entering the 6653 (PROG) code, the keypad displays: RESET PANEL. You must reset the panel and enter the program code then begin programming within the next 30 minutes.

If you are already in the Programmer and do not press any keys on the programming keypad for 30 minutes, the panel terminates programming. All data entered up to that time is Not saved unless you run the Stop routine.

Note: Use the Stop routine to exit panel Programming. Ensure the keypad displays "SAVING PROGRAM" to save all programming changes entered.

## 1.7 Power Up

When the XR500 Series Canadian panel is powered up after an AC power failure, any zone transitions are not recognized for 60 seconds. Normal zone processing resumes at the end of the 60 seconds.

## 1.8 Keypads

DMP offers multiple keypads in a variety of styles. All DMP keypads provide the same programming capabilities. Each keypad and its operation are shown and described in the following sections.

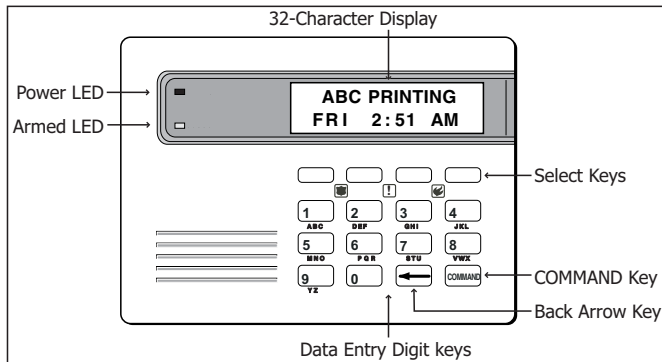

Figure 3: Security Command Keypad

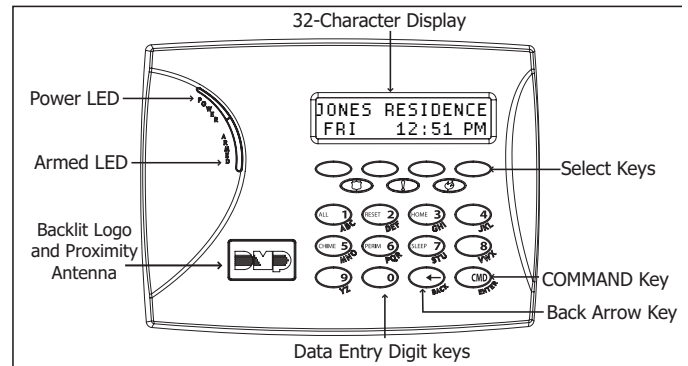

Figure 4: Thinline/Aqualite Keypad

## 1.9 Special Keys

The following special keys/areas are common to all DMP keypads.

### COMMAND (CMD) Key

Pressing the COMMAND key allows you to go forward through the programming menu and through each step of a programming section. As you go through the programming, the keypad display shows any current programming already stored in the panel memory. If no change is required for a prompt, press the COMMAND key to advance to the next step.

The COMMAND key is also used to enter information into the panel's memory such as phone numbers or zone names. Press the COMMAND key after entering information.

### Back Arrow (←) Key

Use the Back Arrow key to back up one step while programming. The Back Arrow key is also used when an error is made while entering information. Press the Back Arrow key once to erase the last character entered.

### Select Keys/Areas

The top row of keys are called the Select keys on Security Command, Thinline, and Aqualite keypads. Each time you need to press a Select key, the keypad displays the function or options above one of the keys or in the Select Area. Displaying choices above individual Select keys or in Select Areas allows them to be used for many different applications. For example, you can enter AM or PM when programming the automatic test time or answer YES or NO for a system option.

During programming, the Select keys/areas also allow you to change information currently in panel memory by pressing the appropriate Select key/area under or on the display. You then enter the new information using the keypad data entry digit keys.

When there are more than four response options available, press the COMMAND key to display the next one to four options. Pressing the Back Arrow key allows you to review the previous four choices.

The Select keys/areas are also used for choosing a section from the programming menu. Press any Select key or touch the Select Area when the programming section name you want displays.

**Note:** On Security Command, Thinline and Aqualite keypads, when instructed to press the first Select key, press the far left Select key; the second Select key is the second from the left; third Select key is second from the right; and the fourth Select key is the far right key. See Figures 6 and 7.

# INTRODUCTION

## 1.10 Entering Alpha Characters

Some options during programming require you to enter alpha characters. To enter an alpha character, press or touch the key that has that letter written below it. The keypad displays the number digit of the key. Next, press the Select key/area that corresponds to the location of the letter under the key. Pressing a different Select key/area changes the letter. When another digit key is pressed, the last letter displayed is retained and the process starts over.

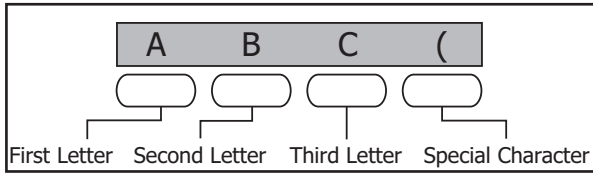

Figure 5: Security Command Select Keys

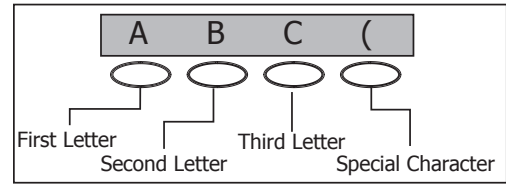

Figure 6: Thinline/Aqualite Select Keys

## 1.11 Entering Non-Alpha Characters

To enter a space in an alpha entry, press the 9 digit key followed by the third Select key/area. The three characters on the 9 digit key are Y, Z, and space. You can also enter the following characters: - (dash), . (period), \* (asterisk), and # (pound sign) using the 0 (zero) key and the four Select keys/areas from left to right. For example, to enter a - (dash), press the 0 (zero) key and then the left Select key/area. A dash now appears in the keypad display. Figures 7 and 8 show the character location for Security Command, Thinline, and Aqualite keypads.

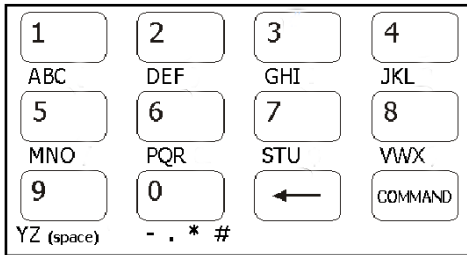

Figure 7: Security Command Special Characters

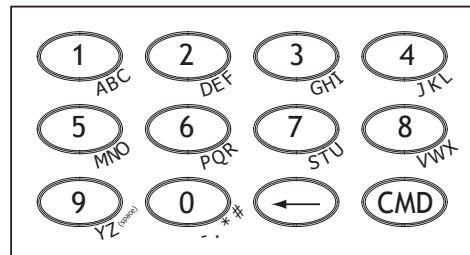

Figure 8: Thinline/Aqualite Special Characters

## 1.12 Keypad Displays Current Programming

Each programming prompt displayed at the keypad shows the currently selected option in the panel memory. These options are either shown as a number, a blank, or a **NO** or **YES**. To change a number or blank to a new number, press any top row Select key or touch any Select Area. The current option is replaced with a dash. Press the number(s) on the keypad you want to enter as the new number for that prompt. It is not necessary to enter numbers with leading zeros. The panel automatically right justifies the number when you press the **COMMAND** key.

To change a programming prompt that requires a **NO** or **YES** response, press the Select key or touch the Select Area for the response not selected. See Figure 12.

For example, if the current prompt is selected as **YES** and you want to change it to **NO**, on Security Command, Thinline, or Aqualite keypads press the third top row Select key. The display changes to **NO**. Press the **COMMAND** key to display the next prompt.

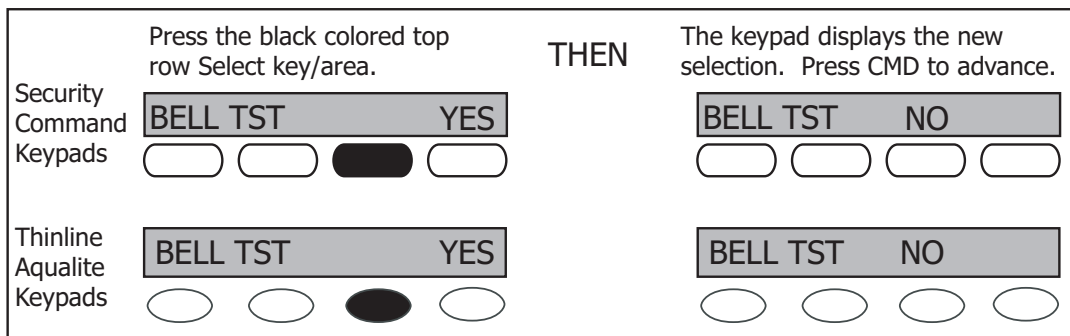

Figure 9: Changing the Current Programming Option

## 1.13 Multiple Displays

For many programming and user options, such as **Area** selections, **Menu Displays**, and **Status Lists**, there are several displays containing programming. For example, when programming **Menu Displays**, keypads 1 through 16 display on two separate displays. First, keypads 1 through 8 display. Press the **COMMAND** key to display keypads 9 through 16. This same scheme is used for areas 1 through 32.

**Note:** Areas not pre-programmed at installation to display at this keypad cannot be viewed.

## 1.14 Asterisks in Programming

Asterisks display next to a programming option that is already selected. As shown in the example, options that are selected to display the current programming selection have an asterisk next to the number. Those that are not selected simply display the number. In the **Devices** example, keypads 3, 8, 9, and 15 are not selected. In the **Areas** example, areas 3, 8, 9, 15, 19, 23, 25, and 31 are not selected. In both examples the numbers with asterisks are selected.

Devices								Areas							
*1	*2	3	*4	9	*10	*11	*12	*17	*18	19	*20				
*5	*6	*7	8	*13	*14	15	*16	*21	*22	23	*24				
				9	*10	*11	*12					25	*26	*27	*28
				*13	*14	15	*16					*29	*30	31	*32

To select or deselect a number, simply enter the number using the digit keys on the keypad. This same scheme is used when viewing the panel armed status and other programming and operational functions. Remember to press the **COMMAND** key to display the rest of the device or area numbers.

## Initialization

**NOTE: WHEN ANY PANEL PROGRAMMING IS CHANGED, THE STOP ROUTINE MUST BE RUN AND 'SAVING PROGRAM' MUST DISPLAY ON THE KEYPAD IN ORDER TO SAVE THE PROGRAMMING CHANGES. SEE SECTION 17.1.**

### 2.1 INITIALIZATION Initialization

This function allows you to clear selected parts of the panel program back to the factory defaults in preparation for system programming. Run the initialization function on all new installations.

For each section of the panel program you can initialize, a NO or YES option is provided.

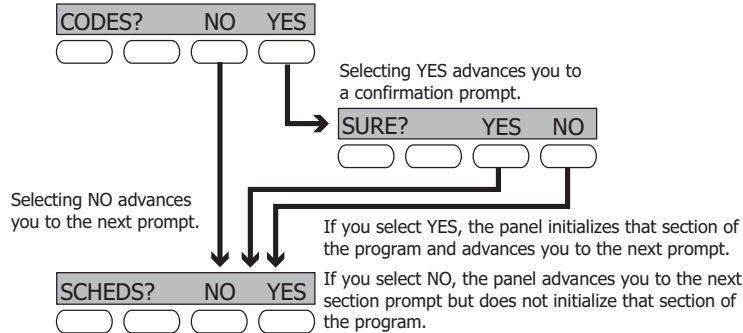

### 2.2 INIT ALL? NO YES SURE? YES NO Clear All Memory

**NO** - Leaves existing programming intact then displays Clear All Codes.

**YES** - Clears all memory then displays Reset Panel. Reset the panel by shorting J16 and re-enter programming mode to continue.

### 2.3 CODES? NO YES SURE? YES NO Clear All Codes

**NO** - Leaves existing codes intact.

**YES** - Clears the user code and user profile memory and assigns user code number 99 to the highest user position.

**Note:** The user name for the default user code is created using the current programmed primary user language.

### 2.4 SCHEDULES? NO YES SURE? YES NO Clear All Schedules

**NO** - Leaves existing schedules intact.

**YES** - Clears all shift, and output schedules.

### 2.5 EVENTS? NO YES SURE? YES NO Clear Display Events Memory

**NO** - Leaves existing event memory intact.

**YES** - Clears the events memory.

### 2.6 ZONES? NO YES SURE? YES NO Clear Zone Information

**NO** - Leaves existing zone information intact.

**YES** - Clears the zone information for all zones. All zones are marked \* UNUSED \* and must be renamed before being able to display on any system keypad.

### 2.7 AREAS? NO YES SURE? YES NO Clear Area Information

**NO** - Leaves existing area information intact.

**YES** - Clears the area information for all areas. All areas are marked \* UNUSED \* and must be renamed before being able to display on any system keypad.

### 2.8 OUTPUTS? NO YES SURE? YES NO Clear Output Information

**NO** - Leaves existing output information intact.

**YES** - Clears all programmed Output names and any output cutoff assignment.



2.9

COM/RMT?	NO	YES
----------	----	-----

## Clear Communication and Remote Options

SURE?	YES	NO
-------	-----	----

NO - Leaves existing communication and remote options intact.

YES - Clears communication and remote options programming to factory defaults.

2.10

DEFAULTS	NO	YES
----------	----	-----

## Set to Factory Defaults

SURE?	YES	NO
-------	-----	----

NO - Leaves existing panel programming intact.

YES - Sets the remainder of the panel programming back to the factory defaults.

**Note:** Sets the Programming and User language to English.

## Communication

- 3.1** COMMUNICATION **Communication**  
Configure the communication options for the panel. The information you program varies with the Communication Type you select.
- 3.2** ACCOUNT NO: 12345 **Account Number**  
The Account Number is a 1 to 5 digit number used to identify which panel is sending a message. Enter the account number sent to the SCS-1R Receiver. Messages may be sent to a central station or via PC Log Reports to a PC. The default is 12345.  
**NET, CELL, 232 and DD** - The range of valid account numbers for a panel is 1 to 65535. For accounts of four digits or less, do not enter leading zeros.  
**CID** - Choose an account number between 1 and 9999.
- 3.3** XMIT DELAY: 30 **Transmit Delay**  
Enter the number of seconds (15 to 45) the panel waits before sending burglary zones (Night, Day, or Exit) reports to the receiver. Other zone type reports are sent immediately. Alarm bells and relay outputs are not delayed during this period. Program Burglary Outputs for pulsed or steady, and set Abort Reports to YES if Opening and Closing reports are not being sent. Enter 0 (zero) to disable this function. The default is 30.  
If the area where the alarm occurred is disarmed during the Transmit Delay time, only an Abort Report (S45) message is sent to the receiver. If the area where the alarm occurred is disarmed after the alarm message is sent to the receiver but before the Bell Cutoff time expires even if the alarm was silenced, an Alarm Cancelled (S49) message is sent. Otherwise the alarm is sent at the end of the delay. The Alarm Cancelled report cannot be disabled.  
**Note: For Commercial Burglary Installations, the combined Transmit Delay (Abort Window) and Entry Delay must not exceed one (1) minute.**
- 3.4** PATH: - **Communication Path**  
Up to eight communication paths may be programmed. Each path is designated as a primary or backup communication route. Path 1 is always Primary but other paths may be programmed as additional primary or backup.  
Each primary path establishes a new path group. A path group is made up of the primary path and its subsequent backup paths. Typical communication takes place on the primary path with backup paths being used only when the primary path fails or when the backup path is programmed to duplicate messages. There is no option to backup path 8.
- 3.5** COMM TYPE: DD **Communication Type**  
Specifies the communication method the panel uses on this path to report system events to DMP SCS-1R Receivers or non-DMP receivers. Default is DD for Path 1, and NONE for Path 2-8.  
NONE DD NET CID **NONE** - For local systems. Selecting NONE ends communication programming.  
**DD** - Digital Dialer communications to a DMP SCS-1R Receiver.  
**NET** - Network communication using the panel onboard network connection. The DMP Network/Output reporting format is transmitted over a data network to the SCS-1R Receiver.  
**CID** - This option allows the panel to communicate to non-DMP receivers using the Contact ID format.  
CELL 232 **CELL** - This option allows communication over the GPRS network using digital cellular technology with the 463G or CellCom Series Digital Cellular Communicator.  
**232** - This option sends serial data and can be used for radio backup or other communication options, and uses the on-board serial port.  
Select 232 when using a 462N Interface Card or DB-9 backup communications by directly connecting to the RS-232 port on the panel. If using the on-board RS-232 port, set the XR500 Series Canadian panel J23 jumper to R and briefly reset the panel using the J16 jumper to activate RS-232 operation. Refer to the XR500 Series Canadian Installation Guide (LT-0681CAN).

- 3.6** PATH TYPE: **BACKUP** **Path Type**  
PRIMARY    **BACKUP** The Path Type defines if the path is Primary or Backup. Because Path 1 is Primary, this prompt only displays for paths 2-8. Default is Backup.  
**Note:** If the Primary Communication Type is CELL, then the backup Communication Type can only be NET or 232.
- 3.7** TEST RPT: **YES** **Test Report**  
NO YES DEFER Test Report determines if test reports are sent on this path. Reports are sent according to the programming in Test Frequency and Test Time. Default is Yes. Select YES to allow the programmed test report to be sent on the path currently being programmed. Select DEFER to not send a test report if the panel communicates any message to the receiver within the time set in Test Frequency. Select NO to not send test reports on this path.
- 3.8** TEST FREQ: **1 DY** **Test Frequency**  
 Test Frequency determines the frequency of the test report. Enter a number from 1 to 60 and select DY (Day) or HR (Hour) by pressing the far right top row select key. Default is 1 Day.
- 3.9** TEST DAY: **SUN** **Test Day**  
 Use this option to set the day of the Test Report. This prompt appears only when Test Report is Yes, Test Frequency is Day and a multiple of seven. Press the COMMAND key to display the first four days of the week. Press the COMMAND key to display the last three days. Select the day of the week to send the test report. Default is Sunday.
- 3.10** TEST TIME:  
**0:00 AM** **Test Time**  
 Use this option to select the time of day for Test Reports. Select the hour, minute and AM/PM. Enter 0:00 AM to disable this feature. Default is 0:00 AM.
- 3.11** CHECKIN: NO YES **Check In**  
 This option displays if the COMM TYPE is NET, 232 or CELL. Check-in reports are a method of supervising the panel for communication with the receiver. For NET the default is YES. For CELL or 232 the default is NO.  
CHECKIN:  
NO YES RND ADPT Select RND (Random) for the panel to check-in at random times from 6 to 60 minutes when all areas are disarmed. If any area is armed a check-in is sent every 6 minutes. Select ADPT (Adaptive) for a backup path to adapt to the check-in programming from this groups primary path if the primary path becomes unavailable. Check-in programming includes Check-in and Fail Time.  
CHECKIN:  
ADP3 Select ADP3 (Adaptive 3) for a backup path to adapt using a 3 minute Check-in and Fail Time if the primary path becomes unavailable. This option also indicates a Communication Trouble (S10) if the cell tower is unavailable for 3 minutes.  
CHECKIN MINS: **200** When YES is selected, enter the number of minutes between check-in reports, from 2 to 240 for NET and 232 or 3 to 240 for CELL, when the panel is armed or disarmed. For CELL or 232 the default is 0. For NET the default is 200.
- 3.12** FAIL TIME: **240** **Fail Time**  
 This option displays if CHECKIN is set to YES. Entering a FAIL TIME allows the receiver to miss multiple check-ins before logging that the panel is missing. The maximum fail time is 240 minutes. For example, if CHECKIN is 10 and FAIL TIME is 30, the receiver only indicates a Panel Not Responding after 30 minutes. The FAIL TIME must be equal to or greater than the CHECKIN time. Default is 0 for CELL and 232. Default is 240 for NET.
- 3.13** ENCRYPT **NO** YES **Encryption (XR500E only)**  
 Select Yes to enable encryption for the path currently being programmed. Default is NO.
- 3.14** RECEIVER IP **Receiver IP**  
000.000.000.000 This option displays only if the Communication Type is NET or CELL. Enter the Receiver IP address where the panel sends network messages. The Receiver IP Address must be unique and cannot be duplicated on the network. Enter all 12 digits and leave out the periods. For example, enter IP address 192.168.0.250 as 192168000250. The periods display automatically.

## 3.15 **Receiver Port**

Enter the receiver port number. Valid range is 1 to 65,535. Default is 2001.

## 3.16 **First Telephone Number**

This option displays only if the Communication Type is DD or CID.

This is the first number the panel dials when sending reports to the receiver. Phone numbers can have two lines of 16 characters each to equal up to 32 characters.

Enter P to program a three-second pause in the dialing sequence. The P character counts as part of the 32 allowable characters.

Enter R as the first character for rotary (pulse) phone function. The R character counts as part of the 32 allowable characters.

**Call Waiting:** You can place the “\* 7 0 P” (Star, Seven, Zero, Pause) in the telephone number first position to cancel Call Waiting. For example, program NET with second line DD and phone number \*70P555-1212, and you have NET with Call Waiting cancelled on the second line.



**Caution:** A call waiting cancel programmed on a non-call waiting telephone line would prevent communication to the central station.

## 3.17 **Second Telephone Number**

The panel dials the second number when two successive tries using the first number fail. If the panel cannot reach the receiver after two attempts using the second number, it returns to the first number and makes two additional attempts. A total of ten dialing attempts are made using the first and second phone numbers.

Each number can be up to 32 characters in length including any P or R characters entered for pause or rotary connections or call waiting cancel option.

Should all ten attempts fail, the panel continues to attempt sending the message using the next programmed path. If all programmed communication paths fail, the panel clears the communication buffer and makes one communication attempt each hour to send a TRANSMIT FAILED (S87) report to the receiver. Access the User Menu Display Events feature to view the report information not sent to the receiver or download the report with DMP Remote Link™ software.

## 3.18 **Advanced Programming**

Select Yes to enter the Advanced Programming menu for the communication path currently being programmed.

## 3.19 **First GPRS APN**

Enter the first APN (Access Point Name). This allows an access point for cellular communication and is used to connect to a DNS network. The APN may contain two lines of 16 characters to equal 32 characters. Default is set to SECURECOM400.

## **Second GPRS APN**

Enter the second APN (Access Point Name). This works as a backup in case the first APN fails. The APN may contain two lines of 16 characters to equal 32 character. Default is set to SECURECOM400.

## 3.20 **Fail Test Hours**

This option sets the frequency for a Backup or Adaptive path to send a test report when the closest previous path fails within its path group.

For example, if a backup path is programmed to send a weekly test report and the Fail Test Frequency is set to 2 hours, when the previous path fails within its group, the backup path starts sending a test every 2 hours until the previous path restores. If Fail Test Frequency is set to 0, test reports are sent only according to Test Report programming. Range is 0 to 24 hours. Default is 0.

## 3.21 **Protocol**

This option displays only when Communication Type is NET.

Select TCP to communicate over the network using TCP protocol. Select UDP to communicate using UDP protocol. Default is TCP.

- 3.22** RETRY SECONDS: 6 **Retry Seconds**  
 This option displays for NET or 232 Communication Types.  
 Enter the number of seconds (between 6 and 15) the panel should wait before retrying to send a message to the receiver if an acknowledgment was not received. The panel retries as many times as possible for a period of one minute before sending a network trouble message. For example, if retry time is set to 15, the panel retries four times. The default Retry Time is 6 seconds.  
**Note:** If TCP is enabled, the minimum Retry Time programmed is 6 seconds.
- 3.23** SUB CODE NO **Substitution Code**  
 This option displays when the Communication Type is NET, CELL or 232. The Panel Substitution Code increases the level of security by helping to ensure that the panel sending the message to the receiver has not been substituted by another panel. The default is NO.  
NO YES SHARED Select YES to send a substitution code with every message.  
 Select SHARED (SHR) to use the same substitution code as operating in the previous path.
- 3.24** 232 COMM PORT: 0 **232 Communication Port**  
 This option displays when Communication Type is 232.  

O	A	B	C
D	E		

 This option sets the physical RS-232 port to the on-board connector or one of the DMP Model 461 Interface Adaptor Card slots labeled A, B, C, D, or E. Use slot A if using a 462N Network Interface Card with or without the 461 card.  
 Enter O to use the on-board connector. Set the XR500 Series Canadian panel J23 jumper to R and briefly reset the panel using the J16 jumper to activate RS-232 operation. Default is O (On-board).
- 3.25** 232 SETUP: **232 Setup String**  

-
-

 This option displays when the Communication Type is 232. Enter up to two lines of 16 characters to equal up to 32 characters for the destination address that may include an IP address. Example: If using a DMP iCOM, enter AT#UCXXX.XXX.XXX.XXX#PPPPP where X is the IP address and P is the port number.
- 3.26** 893A: NO YES **893A**  
 This option displays when the Communication Type is DD or CID.  
 The 893A option allows reports to be sent to the receiver on a second DD line using the 893A module. Default is No.  
 When using this option, Test Report messages (S07 Automatic Recall Test or S88 Unrestored System Recall Test) are sent to the receiver at the frequency programmed in Test Frequency, alternating between the first and second phone line. For example, a DD path with an 893A module set for daily test report frequency sends a test report through phone line 1 one day and phone line 2 the next day.  
2ND LINE PREFIX: - If 893A option is set to YES, enter up to a 3 digit prefix to be dialed before the second phone number. If no prefix is entered, the second phone number is dialed as originally entered.
- 3.27** ALARM SWITCH: 1 **Alarm Switch**  
 This prompt displays for DD or CID Communication Types.  
 Enter the number of attempts to send an alarm message before switching to the next path. Range is from 1 to 10. All non-alarm messages are sent for 10 attempts on the dialer before a switch is initiated. If the path immediately following this channel is not a backup path, this option has no effect. Default is 1.  
NO YES
- 3.28** DUPLICATE ALARMS **Duplicate Alarms**  
 This prompt displays for BACKUP paths. If Yes is selected, the current backup path duplicates all alarms occurring on its group primary path. Default is No.

- 3.29**  ALARM  YES **Alarm Reports**  
This prompt displays when the Path Type is Primary. All backup paths within the group follow the same programming for Alarm Reports. Default is Yes.
- NO  YES  FIRE  
When YES is selected, the following reports are sent to the receiver for all zone types:
- Alarm
  - Bypass
  - Reset
  - Restore
- When FIRE is selected, the following reports are sent for Fire, Fire Verify and Supervisory Zones:
- Alarm
  - Bypass
  - Reset
  - Restore
- 3.30**  SPV/TRBL  YES **Supervisory/Trouble Reports**  
This prompt displays when the Path Type is Primary. All backup paths within the group follow the same programming for Supervisory/Trouble Reports. Default is Yes.
- NO  YES  FIRE  
When YES is selected, the following reports are sent for all zone types:
- Trouble
  - Low Battery
  - Missing
  - Fault
  - Restorals
  - System Troubles
  - System Restoral
- When FIRE is selected, the following reports are sent for Fire, Fire Verify, and Supervisory Zones:
- Trouble
  - Low Battery
  - Missing
  - Fault
  - Restorals
  - System Troubles
  - System Restoral
- 3.31**  O/C USER  NO  YES **Opening/Closing and User Reports**  
This prompt displays when the Path Type is Primary. All backup paths within the group follow the same programming for Opening/Closing and User Reports. Default is Yes.
- When YES is selected, the following reports by user are sent to this receiver.
- Opening
  - Closing
  - Bypass
  - Reset
  - Code changes (including adding, deleting, changing)
  - Schedule changes (temporary, permanent, shift)
  - Holiday date changes
- 3.32**  DOOR ACS  YES **Door Access Report**  
This prompt displays when the Path Type is Primary. All backup paths within the group follow the same programming for Door Access Reports. Default is Deny.
- NO  YES  DENY  
Select YES to enable Door Access Granted and Denied reports to this receiver whenever a door access is granted to a user. The Door Access Granted report is only sent if the keypad number has also been selected in Access Keypads under the SYSTEM REPORTS programming.
- Note:** To minimize cellular data, Door Access Granted reports are not sent on a CELL path type.
- Select DENY to enable Door Access Denied reports only to this receiver when a door access is denied to a user.
- 3.33**  SEND COMM TRBL:  NO  YES **Send Communication Trouble**  
This prompt displays for each path and determines if and how communication trouble on the path is sent to the receiver. A trouble message indicates both the path number and communication type that failed. Default is Yes.
- 3.34**  SEND PATH INFO:  NO  YES **Send Path Information**  
This prompt displays for each path and if YES, each panel message includes path information such as path number, communication type, and path type. Default is No.



## Network Options (XR500N/XR500E only)

Network Options are provided to define the network configuration for the panel. This information will be used during communication of messages via network or email.

**Note:** IP addresses and port numbers may need to be assigned by the network administrator. When entering an IP, Gateway, or Subnet Mask address be sure to enter all 12 digits and leave out the periods. For example, IP address 192.168.000.250 is entered as 192168000250.

- 4.1**  DHCP  YES **DHCP Mode Enabled**  
 If the panel uses a dynamic IP address select YES. When set to YES, the panel operates using DHCP and does not use the Local IP Address number. When the DHCP option is set to NO, the panel uses the IP address entered in Local IP Address. The default value for DHCP mode is YES.
- 4.2**  **Local IP Address**  
 Enter the local IP address. The Local IP Address must be unique and cannot be duplicated. The default local IP address is 192.168.0.250.
- 4.3**  **Gateway Address**  
 Enter the local gateway address. The Gateway IP Address is needed to exit your local network. The default gateway address is 192.168.0.1.
- 4.4**  **Subnet Mask**  
 Enter the local subnet mask assigned to the panel. The default subnet mask address is 255.255.255.000.
- 4.5**  **DNS Server**  
 Enter the IP address of the DNS (Domain Name System) used by the panel to resolve domain names into IP addresses. The default address is 192.168.0.1.
- 4.6**  **Passphrase (XR500E only)**  
 To enable encryption type an 8 to 16-character Passphrase using alphanumeric characters. If you leave the Passphrase blank, the panel communicates with the SCS-1R Receiver, but the data is not encrypted. The Passphrase is blank by default.

The XR500E panel is capable of communicating encrypted data to an SCS-101 Network Line Card installed at the receiver. The XR500E panel and the SCS-101 must have the same secret password called a Passphrase.



**Note: DO NOT LOSE THE PASSPHRASE.** A lost or forgotten Passphrase requires that the XR500E panel and every iCOM-E unit reporting in to the same iCOM-E unit at the receiver be individually reprogrammed with a new passphrase.

**Note:** An XR500E panel communicates using AES encryption. If you currently have an XR500N panel installed, you may purchase a separate feature key to activate encrypted communications using the Feature Upgrade process described in the Feature Upgrade Section. Encrypted communication cannot be enabled on a standard XR500 panel.



## Messaging Setup

### 5.1 **Messaging Setup**

This section allows you to enter the information needed to receive messages directly from the panel via email and In Touch™ SMS Text using Network or Cellular communication. All of the name and password options below allow up to 32 lowercase characters to be entered. The Destination addresses allow up to 48 characters to be entered. System Name is displayed with initial caps.

The transmitted messages are:

- Zone Alarms by Zone Name
- Zone Troubles by Zone Name
- Zone Bypass by User
- Arming (Closings) by User
- Disarming (Openings) by User
- Late to Close
- AC Power Trouble and Restoral
- System Low Battery
- Ambush
- Abort, Cancel and Alarm Verified by User
- Check-in by user

### 5.2 **Enable Messaging**

Select **YES** to allow the panel to send messages to three programmed destinations. Default is **NO**.

### 5.3 **System Name**

Enter a unique name for the panel. The panel name is used as the sender of the message. The text entered is displayed with initial caps. If this field is left blank, the panel account number is sent.

### 5.4 **Destination 1**

Enter the first email address or cell phone number where messages will be sent. The message can be sent to any device (computer, cell phone, PDA) as long as a valid email address or cell phone number is entered. When entering email addresses, press the 7 digit key followed by the fourth Select Key to add the @ symbol and the 9 digit key followed by the fourth Select Key to add the \_ symbol. See the Entering Non-Alpha Characters section for additional symbols.

**Note:** Mail servers that require Transport Layer Security (TLS) encryption are not supported by the XR500 Series.

### 5.5 **Destination 1 User Number**

If Destination 1 is a 10-digit cellular number, enter a user's user number from this account. This option is used when sending commands such as arming or disarming back to the panel using In Touch™ SMS Text from the same cell phone or PDA. The user number must have the authority to perform the commands as if it occurred at the keypad. In Touch™ SMS Text command operation is available in XR500 Series panels using version 205 or higher. Entering 0 (zero) disables this option. Default is 0.

### 5.6 **Destination 2**

Enter the second destination email address or cell phone number.

### 5.7 **Destination 2 User Number**

If Destination 2 is a cellular number, enter the user's User Number for arming/disarming authorization.

### 5.8 **Destination 3**

Enter the third destination email address or cell phone number.

- 5.9**  **Destination 3 User Number**  
 If Destination 3 is a cellular number, enter the user's User Number for arming/disarming authorization.
- 5.10**  **Email Communication Type**  
 Choosing NET sends email messages over the network. Choosing CELL sends email messages via cellular communication. Default is NET. This prompt appears only if any destination above is an e-mail address and the panel is a network panel (has an Ethernet connector).
- 5.11**  **O/C Email**  
 Select YES to allow the panel to send Opening and Closing reports via email. Default is NO. This prompt displays if any destination above is an email address.
- 5.12**  **O/C SMS**  
 Select YES to allow the panel to send Opening and Closing messages to a cell phone via SMS protocol. Default is NO. This option displays if any destination above is a cell phone number.
- 5.13**  **Monthly Limit**  
 This option displays if any programmed destination is a cell phone number using NET or CELL communication or an email address using CELL communication. If all destinations are email addresses using NET communication, this option does not display. This number limits the monthly incoming and outgoing SMS messages allowed to be sent or received by the panel.  
 A panel event that causes messages to be sent to destination cell phone numbers or destination email addresses is counted towards the panel's monthly limit. For example, if an alarm message is sent to a cell phone number and an email address using CELL communication, a total of 2 messages are counted towards the monthly limit for the panel. SMS messages sent from a cell phone to the panel, including status requests and In Touch™ SMS Text messaging commands, also count toward the monthly limit. The limit is reset at midnight on the 14th of every month. Range is from 0 to 999. When 0 is entered, there is no limit on the number of messages able to be sent or received by the panel. Default is 0.  
**Note:** The SecureCom Wireless text plan selected for the panel should match or exceed the programmed Monthly Limit.
- The remaining options only appear if email messaging has been selected to be sent via network. The options allow the email server to be selected by the installing dealer. Typically this is the email service provided by the installing dealer. This allows opportunity for additional services to be provided to the end user.
- 5.14**  **SMTP Server**  
 Enter the SMTP (Simple Mail Transfer Protocol) Server name. The SMTP email server is responsible for sending the email to its destination. An example SMTP email server name is: mail.somedomain.com. The domain should be the email server that provides email support for your alarm customers.
- 5.15**  **SMTP Server Port**  
 The SMTP server port number is the port that the panel uses to initiate a TCP connection with the email server. The default port is 25.
- 5.16**  **SMTP Username**  
 Most SMTP servers require a username to send email. This is sent to the SMTP server in conjunction with the SMTP Password to provide email authentication to the server.
- 5.17**  **SMTP Password**  
 Most SMTP servers require a password to send email. This is sent to the SMTP server in conjunction with the SMTP Username to provide email authentication to the server. Passwords display as lowercase.
- 5.18**  **From Email Address**  
 Enter the email address on file with the email service. This displays in the email message as the sender's address.

## Device Setup

- 6.1** DEVICE SETUP **Device Setup**  
This section allows you to define the XR500 Series Canadian panel physical configuration. You can install and address up to sixteen **supervised** devices on the keypad data bus.
- 6.2** DEVICE NO:- **Device Number**  
DEVICE 1: DOOR Enter the device number on the keypad bus you are programming. The keypad bus can have up to 16 devices.  
**Note:** After you program each option for the first device, repeat these programming steps for each additional devices.
- DOOR KPD FI NONE **DOOR - (XR500 Version 205)** The device is an access control device and is either a keypad or a Wiegand Interface Module.  
**KEYPAD - (XR500 Version 205)** The device is either a keypad or a zone expander device.  
**FIRE** - The device is a Remote Fire Command Center.  
**NONE** - No device is set for this address.
- 6.3** DOOR NAME 1 **Door Name**  
The door name displays. To change the name, press any top row Select key then enter up to 16 characters for the door name. Press COMMAND to continue device setup programming.
- 6.4** ACCESS AREAS: **Access Areas**  
Press the COMMAND key to program Access Areas. To select an area, enter the area number using the digit keys on the keypad. When an area is selected, an asterisk appears next to the area number. Enter the number again to deselect the area. Press COMMAND to display the next set of areas. Refer to the Multiple Displays section at the beginning of this document.  
Users must have matching access area numbers assigned to their code to receive a door access at this device.  
If you do not enter any area numbers, all users with Door Access authority receives a door access without regard to schedules. If the user code is programmed for Anti-Pass YES, then the user is logged into all matching areas. This user is not allowed to access these areas again until they have egressed the area. See Egress Areas.  
When all areas accessed by a door are armed, the door is locked by the panel.  
**Note: For an All/Perimeter, Home/Sleep/Away, or Home/Sleep/Away with Guest system, Access Areas should be left at factory default settings.**
- 6.5** EGRESS AREAS: **Egress Areas**  
Press the COMMAND key to program Egress Areas. To select an area, enter the area number using the digit keys on the keypad. When an area is selected, an asterisk appears next to the area number. Enter the number again to deselect the area. Press COMMAND to display the next set of areas. Refer to the Multiple Displays section at the beginning of this document.  
**Note: For an All/Perimeter, Home/Sleep/Away, or Home/Sleep/Away with Guest system, Egress Areas should be left at factory default settings.**  
**Note:** If an area is programmed as an access area, it cannot be programmed as an egress area and therefore does not display during Egress Areas programming.  
Use this option to detect Anti-passback violations. Anti-passback requires a user to properly exit (egress) an area they have previously accessed. If users fail to exit through the proper card reader location they are not granted access on their next attempt. Users must have matching access area numbers assigned to their profile, to receive a door access at this device. If the user is programmed for Anti-Pass YES, then the user is logged out of all matching areas. This allows the user to again access the area. See **Access Areas** section.  
If you do not enter any area numbers, all users with Door Access authority receives a door access without regard to schedules. If you are not using the Anti-Pass feature leave **Egress Areas** blank.

6.6

DISPLAY AREAS:			
*1	*2	*3	*4
*5	*6	*7	*8
*9	*10	*11	*12
*13	*14	*15	*16
*17	*18	*19	*20
*21	*22	*23	*24
*25	*26	*27	*28
*29	*30	*31	*32

**Display Areas**

Press the COMMAND key to program Display Areas. To select an area between 1 and 32, enter the area number using the keypad digit keys. When an area is selected, an asterisk appears next to the area number. Enter the number again to deselect the area. Press COMMAND to display the next set of areas. Default is all area numbers. Refer to the Multiple Displays section at the beginning of this document.

Display Areas allows the XR500 Series burglary activities to be segmented so that only specific area(s) and their associated operation appear at a particular keypad. Area number(s) selected in this field affect the way users interact with the system from this particular device. For example: Program Device 1 to show only the zone activities and armed status of Area 1.

Enter the area number(s) that this keypad is to display. This allows specific area control from specific keypads, as well as annunciation of zones assigned to those area(s). When Display Areas is left defaulted (all areas selected), Menu Display and Status List items determine whether zone alarms and troubles display at this device, regardless of area assignment. Also, all system areas may be armed and disarmed from this device.

**Note: For an All/Perimeter or Home/Sleep/Away system, Display Areas should be left at factory default settings.**

For Home/Sleep/Away with Guest arming systems, the Display Areas selection determines which system the keypad arms and disarms. With areas 1, 2 or 3 being the first areas selected, the keypad is assigned to the Main system. With area 4, 5 or 6 being the first areas selected, the keypad is assigned to the Guest 1 system. With area 7, 8 or 9 being the first areas selected, the keypad is assigned to the Guest 2 system. Keypads can have additional areas assigned for Event Display.

**User Action Allowed**

When an area(s) is selected, the following user actions are allowed:

- Arming or Disarming of the area(s) selected from the ARM or DISARM menu
- Alarm Silence for the area(s) selected
- Zone Bypass of zones assigned to the area(s) selected
- Zone Monitor of zone assigned to the area(s) selected
- Shift schedule changes allowed for the area(s) selected
- Closing Check Schedule Extend is allowed for the area(s) selected
- Door Schedules changes are allowed for devices that have a matching area(s) as defined in Device Access Areas
- Door On/Off Menu operation is allowed for devices that have a matching area(s) as defined in Device Access Areas

**Note:** The previous user actions also require the matching area(s) be programmed in User Profile: Arm/Disarm area(s).

**Status Display Allowed**

When an area(s) is chosen, the following displays are allowed:

- Armed Status of the selected area(s)
- Zone Alarms and troubles for burglary (NT, DY, EX, A1, A2) type zones assigned to the selected area(s)
- Late to Close status of the selected area(s)
- Zone Status (normal/fault) of zones that are assigned to the selected area(s)

**Options and Actions Not Affected**

The following options are not affected by the Display Areas operation. The User Code authority level controls access to these items.

- Sensor Reset Menu
- System Test/Panic Test
- Service Request
- Fire Drill
- 24-hour zones display at keypads based on Status List programming only
- Outputs On/Off Menu
- User Profiles
- Set System Time and Date
- Display Events
- System Status Menu
- Forgive Anti-Passback

**Note:** A common area and its operations cannot be assigned to a specific keypad.

Display Areas example: When Device 1 has Display Areas set to 20, 21, and 22, it annunciates troubles and alarms only for zones assigned to those areas.

When arming/disarming from Device 1, only areas 20, 21, and 22 may be armed/disarmed, even when the User Profile has authority to arm/disarm other system areas.

Exception: Disarming of other areas not selected in Display Areas can be accomplished by presenting a card that has disarming authority and matching profile areas with areas assigned in Device Access Areas.

- 6.7**  **Strike Time**  
This option displays if DOOR is selected as Device Type.  
Enter a door access time, between 1 and 250 seconds, during which a keypad or access control device relay is activated. Magnetic locks or electric door strikes are connected to the relay and released for the length of the strike time. Default is 5 seconds.  
Enter 0 (zero) to activate the device relay with a toggle action. This allows the user to activate or deactivate the device relay each time a valid user code is entered. The device relay is activated or deactivated until a user code is entered again.  
**Note:** The Request to Exit door access time of a keypad or Model 733 Wiegand Interface Module is not affected by this selection. It remains at 5 seconds.
- 6.8**  **Strike Delay**  
This option displays if DOOR is selected as Device Type.  
Enter the number of minutes, 0 to 9, to delay a door strike after a valid code is entered or a card read occurs. When a valid code or card read or code is received, the activation of the door strike is delayed for the number of minutes programmed. The standard door strike message is sent to the Central Station receiver and logged in the Display Events at the time of card read or code entry and is not delayed. During this delay, all subsequent codes entered or cards presented to the reader for a door strike are ignored and no record of the attempt is stored. Enter 0 (zero) to disable. Default is 0 (zero).
- 6.9**  **Fire Exit Release**  
Select **YES** to allow the door access relay at this address to be released whenever Fire panic keys are pressed or a Fire or Fire Verify zone alarm is in the Status List. The relay is reset whenever a Sensor Reset is performed to remove all Fire and Fire Verify zone alarms from the Status List. Select **NO** to not allow the door access relay at this address to be released.
- 6.10**  **Output Group**  
Select **YES** to allow the output group (relays) assigned to the user profile to turn ON when the device relay is activated for the programmed strike time. This could be used to operate an elevator control. Default is **NO**. See the **User Profiles** section in the Appendix of this document for more information about profiles.
- 6.11**  **Schedule Override**  
Use this option to allow door ON/OFF schedules to be overridden by the armed condition of the system. Selecting **YES** causes the on time for a door schedule to be ignored when all areas assigned to Access Areas for this device are armed. Should any area become disarmed after the door schedule on time, the device output turns on. A door output which is on during a disarmed period automatically turns off when all access areas assigned to the device become armed, even if the scheduled off time has not been reached. This feature can be used to keep doors locked when a factory opens late, or is forced to close early, due to a snow storm or other cause. Select **NO** to allow door schedules to operate independent of system armed status.  
**Note:** When **OVERRIDE** is **YES** and there are no areas programmed in **ACCESS AREAS**, the door schedule for that device does not work. Either set **OVERRIDE** to **NO** or enter an area number in **ACCESS AREAS**.
- 6.12**  **Auto Force Arm Device?**  
Select **YES** to have all Display Areas assigned to this keypad automatically arm and force arm faulted zones at arming. The user is not prompted to select areas to arm or force arm faulted zones after choosing ARM at the keypad. If Closing Code is programmed as **YES**, only the matching areas between the Display Areas and the User Code's authorized areas arm. Also, when **YES** is selected, the user is not prompted to select areas to disarm after entering a code at Entry Delay or after choosing Disarm at the keypad. All matching areas assigned to the User Code and to this keypad are automatically disarmed. When **NO** is selected, the user is prompted to select areas (ALL NO YES) and choose to force arm or bypass at arming and disarming. Default is **NO**.
- 6.13**  **Door Real-Time Status?**  
Select **YES** to have real-time door status messages sent to PC Log reporting and Entré reporting for this device. Messages are sent anytime the panel turns the door relay on or off. Default is **NO**.
- 6.14**  **Send Door Forced Message?**  
Select **YES** to have the panel send a real-time door status message of Forced Open (FO) to PC Log reporting and Entré reporting when the door relay is off, but the door zone has transitioned from its normal state. Default is **NO**.



**6.15** PROGRAM 734  
 OPTIONS? **NO** YES

**Program 734 Options**

Select **YES** to program the 734 Wiegand Interface Module. Device type must be set to DOOR.

**6.15.1** ACTIVATE ZONE 2  
 SHUNT? **NO** YES

**Activate Zone 2 Shunt**

Select **YES** to activate the Soft-Shunt™ option.

Selecting **NO** allows standard zone operation on Zone 2 and displays the ACTIVATE ZONE 3 REX option. Default setting is **NO**.

If the door being released by the 734 module is protected (contact installed), you can provide a programmable Soft-Shunt entry/exit timer by connecting its contact wiring to the 734 module Zone 2. When the on-board Form C relay activates and the user opens the door connected to Zone 2, the zone is shunted for the number of seconds programmed in ZONE 2 SOFTSHUNT TIME allowing the user to enter/exit.

If Zone 2 does not restore (door closed) within the programmed time minus ten seconds, the piezo sounds every other second during the timer last ten seconds. If Zone 2 restores prior to the end of the programmed time, the piezo silences. If the zone does not restore after the ten second piezo time, the 734 ends the shunt and indicates the open or short zone condition to the panel.

If you select **YES**, pressing the **COMMAND** key displays ZONE 2 SOFTSHUNT TIME. The Back Arrow returns to the Program 734 Options.

**6.15.2** ZONE 2 SOFTSHUNT  
 TIME: **40**

**Zone 2 Soft-Shunt Time**

Enter the number of Soft-Shunt seconds to elapse before the Soft-Shunt timer expires. Range is from 20 to 250 seconds. Press any top row select key to enter the number of seconds. If the door remains open when the timer expires a zone open/short is sent to the panel for Zone 2. The default is 40 seconds.

Press the **COMMAND** key to move forward to RELOCK ON ZONE 2 FAULT. The Back Arrow returns to the ACTIVATE ZONE 2 SHUNT option.

**6.15.3** RELOCK ON ZONE 2  
 FAULT? **NO** YES

**Relock on Zone 2 Fault?**

Selecting **NO** leaves the relay on when Zone 2 faults to an open or short condition during Soft-Shunt. Selecting **YES** turns the relay off when Zone 2 faults open or short during Soft-Shunt. The default is **NO**.

Press the **COMMAND** key to display ACTIVATE ZONE 3 REX:. The Back Arrow returns to the ZONE 2 SOFTSHUNT TIME: option.

**6.15.4** ACTIVATE ZONE 3  
 REX? **NO** YES

**Activate Zone 3 Request to Exit**

Selecting **YES** activates the Zone 3 Request to Exit (REX) option.

Selecting **NO** allows standard zone operation on Zone 3 and displays the ACTIVATE ONBOARD SPEAKER option. Default setting is **NO**.

Optionally connect a PIR (or other motion sensing device) or a mechanical switch to Zone 3 to provide REX capability to the system. When Zone 3 shorts, the on-board Form C relay activates for the programmed number of seconds. During this time, the user can open the protected door to start the programmed Soft-Shunt™ entry/exit timer. After the programmed number of seconds, the relay restores the door to its locked state.

The 734 module provides a shunt-only option for REX on Zone 3. When Zone 3 opens from a normal state, only a Soft-Shunt occurs: the on-board relay does not activate. This shunt-only option uses two methods of REX. The first REX device provides the programmed Soft-Shunt entry/exit timer. The second REX device, or manual device such as a door knob, unlocks the door.

An example of the shunt-only configuration is a door to an office that is locked 24 hours a day. Users pass a REX motion detector positioned by the door to begin the programmed exit timer. Within the programmed number of seconds the user must then manually activate a second device, such as a REX device or manual door knob, to unlock the door. If the door is opened after the programmed number of seconds, the zone goes into alarm.

If you select **YES**, pressing the **COMMAND** key displays ZONE 3 REX STRIKE TIME. The Back Arrow returns to the ACTIVATE ZONE 2 SHUNT option.

**6.15.5** ZN 3 REX STRIKE  
 TIME: **5**

**Zone 3 REX Strike Time**

Enter the number of REX seconds to elapse. Range is from 5 to 250 seconds. Press any top row select key to enter the number of seconds. The default is 5 seconds.

Press the **COMMAND** key to move forward to the ACTIVATE ONBOARD SPEAKER option. The Back Arrow returns to ACTIVATE ZONE 3 REX.

**6.15.6**

ACTIVATE ONBOARD SPEAKER?	NO	<b>YES</b>
---------------------------	----	------------

## Activate Onboard Speaker

Select YES to enable the onboard piezo speaker for local annunciation. Select NO to turn the piezo off for all operations. This does not affect remote annunciator open collector (RA) operation. The default is YES.

Press the COMMAND key to display the CARD OPTIONS option. The Back Arrow returns to ACTIVATE ZONE 3 REX.

**6.15.7**

CARD OPTIONS:	<b>DMP</b>
---------------	------------

## Card Options

Press any top row Select key to display options. Press the select key under DMP or CUSTOM to select that option. Select DMP to indicate the reader sends a 26-bit DMP data string. Press the COMMAND key to display REQUIRE SITE CODE.

CARD OPTIONS:	
<b>DMP</b>	CUSTOM

**Note:** When set to DMP, the 734 converts 17 bits of the 26-bit data string into a 5-digit number.

Select CUSTOM if using a non-DMP card or user code length of 6 to 10 digits. Default is DMP.

**6.15.8**

WIEGAND CODE LENGTH:	<b>26</b>
----------------------	-----------

## Custom Card Definitions

When using a custom product, enter the total number of bits to be received in Wiegand code including parity bits.

Press any top row Select key to enter a number between 0-255 to equal the number of bits. Default is 26 bits.

Typically, an access card contains data bits for a site code, a user code, and start/stop/parity bits. The starting position location and code length must be determined and programmed into the 734 Module.

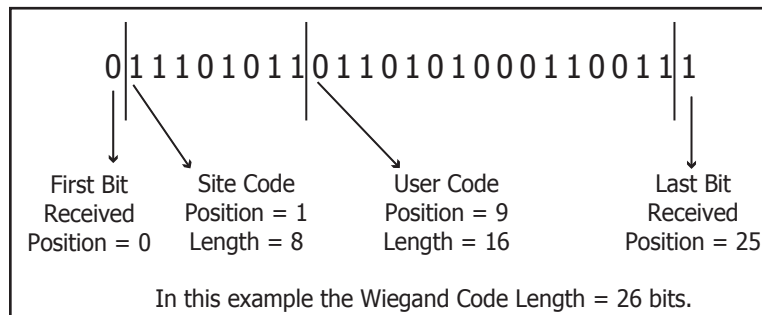

**6.15.8.1**

SITE CODE POSITION:	<b>1</b>
---------------------	----------

### Site Code Position

Enter the site code start position in the data string. Press any top row Select key to enter a number between 0-255. Default is 1.

**6.15.8.2**

SITE CODE LENGTH:	<b>8</b>
-------------------	----------

### Site Code Length

Enter the number of characters the site code contains. Press any top row Select key to enter a number between 1-16. Default is 8.

**6.15.8.3**

USER CODE POSITION:	<b>9</b>
---------------------	----------

### User Code Position

Define the User Code start bit position. Press any top row Select key to enter a number between 0-255. Default is 9.

**6.15.8.4**

USER CODE LENGTH:	<b>16</b>
-------------------	-----------

### User Code Length

Define the number of User Code bits. Press any top row Select key to enter a custom number. Custom numbers can only be a number between 16-32. The default is the DMP value of 16 which is pre-programmed.



**6.15.9** REQUIRE SITE CODE? **NO** YES

**Require Site Code**

Press the top row Select key under YES to use a site code.

In addition to User Code verification, door access is only granted when any one site code programmed at the SITE CODE ENTRY option matches the site code received in the Wiegand string.

**6.15.9 .1** SITE CODE 1: -

**Site Code Display**

You can program up to eight three-digit site codes. Site code range is 0-999. Any previously programmed site codes display. Dashes represent blank site codes.

Site Code 1 displays first. Enter a three-digit site code number followed by the command key to advance to the next prompt, Site Code 2. To delete an existing site code, press any select key. Either enter a new site code followed by command, or press command to leave blank and continue to the next site code. Repeat these steps to change, delete, or add up to 8 site codes.

**Note:** A card with a site code greater than three digits cannot be used. Use only cards with three-digit site codes.

**6.15.10** NO OF USER CODE DIGITS: **5**

**Number of User Code Digits**

The 734 module recognizes user codes from four to ten digits in length. Press any top row Select key to enter a user code digit length between 4-10 digits. This number must match the user code number length being used by the panel. Default is 5. For an XR500 Area System, use 4 to 10 digits (typically 5). For all other systems and panels, use 4 digits.

Any selection above 5 digits require entry of the custom card definitions with custom site and user code positions for the Wiegand string. When searching the bit string for the user code, the digits are identified and read from left to right.

**6.15.11**

**Degraded Mode**

This option defines the relay action when communication with the panel has not occurred for five seconds. Press any top row Select key to display relay action options. Press the Back Arrow key to return to the NO OF USER CODE DIGITS:.

DEGRADED MODE:  
OFF SITE ANY ON

Choose the Degraded Mode Action required.

DEGRADED MODE:  
RELAY ALWAYS OFF

Press the first Select key to choose OFF [Default] (Relay Always Off) – The relay does not turn on when any Wiegand string is received. Off does not affect any REX operation.

DEGRADED MODE:  
ACCEPT SITE CODE

Press the second Select key to choose SITE (Accept Site Code) – Door access is granted when the Wiegand site code string received matches any site code programmed at SITE CODE ENTRY. For details refer back to the REQUIRE SITE CODE option.

DEGRADED MODE:  
ANY WIEGAND READ

Press the third Select key to choose ANY (Any Wiegand Read) – Door access is granted when any Wiegand string is received.

DEGRADED MODE:  
RELAY ALWAYS ON

Press the fourth Select key to choose ON (Relay Always On) – The relay is always on. Press the COMMAND key to display the next action.

DEGRADED MODE:  
LAST

DEGRADED MODE:  
PRESERVE LAST

Press the first Select key to choose LAST (Keep Last State) – The relay remains in the same state and does not change when communication is lost.

After choosing the action, the DEGRADED MODE option and the newly defined action display.

Programming is now complete. Press the COMMAND key to display DEVICE NO. Press the Back Arrow to return to the NO OF USER CODE DIGITS option.

## Remote Options

- 7.1**

REMOTE OPTIONS
----------------

**Remote Options**  
This section allows you to enter the information needed for Remote Command/Remote Programming operation.
- 7.2**

REMOTE KEY:
-------------

**Remote Key**  
This option allows you to enter a code of up to 16 characters. The Remote Link™ program must give the correct key to the panel before being allowed any remote functions. All panels are shipped from the factory with the key preset as blank. To enter a remote key or change the current one, press a top row Select key and enter any combination of up to 16 digits. Press COMMAND. The current key display as asterisks.
- 7.3**

REMOTE DISARM?
NO YES

**Remote Disarm**  
YES allows the panel to be disarmed remotely. NO disables remote disarming. Default is NO.
- 7.4**

ALLOW DIALER
REMOTE? NO YES

**Allow Dialer Remote**  
YES allows remote programming over the phone line. Default is YES.
- Receiver Key Operation:**  
With YES selected, the panel requests the receiver's key during its first message to the SCS-1R Receiver and this becomes the alarm receiver key. A receiver key is an alphanumeric code programmed into the receiver and identifies it to alarm panels. The panel retains this alarm receiver key in memory and allows remote commands to be accepted over the dialer from the alarm receiver. If an alarm occurs during a remote connect, the alarm report is immediately sent to the alarm receiver and does not appear at the remote programming software. YES also enables remote commands and programming to be accepted from a secondary receiver other than the alarm SCS-1R Receiver. The panel requests the service receiver key the first time it is contacted by another receiver and this becomes the service receiver key. The panel retains this service receiver key in memory and accepts remote commands from the service receiver. If an alarm occurs during a remote connect, the panel disconnects from the service receiver and calls the alarm receiver. Alarm reports are only sent to the alarm receiver. It is important that the alarm receiver key and the service receiver key programmed into the receiver at the central station are NOT the same so the panel can determine the difference between receivers. When NO is selected, remote commands and programming are not accepted from the SCS-1R Receiver using digital dialer and all memory of receiver keys is cleared.
- 7.4.1**

ARMED ANSWER
--------------

**Armed Answer Rings**  

RINGS: 8
----------

  
Enter the number of rings the panel counts before answering the phone line when all system areas are armed. Any number from 0 to 15 can be entered. If 0 (zero) is entered, the panel does not answer the phone when all system areas are armed. The default is 8 (eight).  
**Answering machine bypass procedure:** Entering a number greater than 0 (zero) into either Armed Rings or Disarmed Rings, allows a central station operator to connect remotely with the panel.  
**How it works:** The operator calls the panel, allows the telephone to ring one time, and then hangs up. The panel stores this as an attempt to communicate. The operator then calls back within 30 seconds. The panel seizes the telephone line to allow remote programming.  
**Note:** This feature does not interfere with the normal operation of the Arm Rings or Disarm Rings functions.
- 7.4.2**

DISARMED ANSWER
-----------------

**Disarmed Answer Rings**  

RINGS: 8
----------

  
Enter the number of rings the panel counts before answering the phone line while any system areas are disarmed. Any number from 0 to 15 can be entered. If 0 (zero) is entered, the panel does not answer the phone when any system area is disarmed. The default number is 8 (eight).

- 7.4.3** PC MODEM  NO  YES **PC Modem**  
 YES allows the panel to answer the telco link and connect with Remote Link through the PC Modem at 2400 baud. NO disables PC Modem communication.
- 7.4.4** MANUFACTURER  
AUTH?  NO  YES **Manufacturer Authorization**  
 Select YES to allow DMP Technical Support technicians to access the panel during system service or troubleshooting. This authorization automatically expires within one hour.  
 DMP remote service is provided on a read only basis: DMP technicians can look at the system programming and make suggestions only. Alterations can only be accomplished by installing company service personnel.
- 7.5** ALLOW NETWORK REMOTE?  NO  YES **Allow Network Remote**  
 This option displays only if the panel has network capability. YES allows remote programming over the network. Changing this prompt does not change any other network programming prompts. Default is YES.
- 7.5.1** NETWORK PROG  
PORT:  **Network Programming Port**  
 Enter the programming port number. The programming port identifies the port used to communicate messages from the panel. The default Programming Port setting is 2001.
- 7.5.2** ENCRYPT NETWORK REMOTE?  NO  YES **Encrypt Network Remote**  
 YES encrypts data sent over network. Default is NO.
- 7.6** ALLOW CELL REMOTE?  NO  YES **Allow Cellular Remote**  
 YES allows remote programming using cellular connection. Default is YES.
- 7.6.1** FIRST GPRS APN:  
SECURECOM400  
- **First GPRS APN**  
 Enter the first APN (Access Point Name). This allows an access point for cellular communication and is used to connect to a DNS network. The APN may contain two lines of 16 characters to equal 32 characters. Default is set to SECURECOM400.
- SECOND GPRS APN:  
SECURECOM400  
- **Second GPRS APN**  
 Enter the second APN (Access Point Name). This works as a backup in case the first APN fails. The APN may contain two lines of 16 characters to equal 32 character. Default is set to SECURECOM400.
- 7.6.2** ENCRYPT CELL REMOTE?  NO  YES **Encrypt Cellular Remote**  
 YES encrypts data sent over a cellular connection. Default is NO.
- 7.7** ALLOW 232 REMOTE?  NO  YES **Allow RS-232 Remote**  
 YES allows remote programming over the on-board RS-232 port. Default is YES.
- 7.8** ENTRE CONNECTION:  **Entré Connection**  
 This option displays only if the panel has network capability. Select NET to allow a dedicated network connection with Entré. Options are NONE or NET. Default is NONE.
- 7.8.1** ENTRE INCOMING TCP PORT:  **Entré Incoming TCP Port**  
 This option displays only if NET is chosen for the Entré connection. Enter the programming port number for the incoming Entré connection. The programming port identifies the port used to communicate messages to and from the Entré software. This port cannot be the same port as programmed in Network Programming Port. The default Programming Port setting is 2011.
- 7.8.2** ENTRE IP  
000.000.000.000 **Entré IP Address**  
 This option displays only if NET is chosen for the Entré connection. Enter the Entré IP address where the panel sends network messages. The Entré IP Address must be unique and cannot be duplicated on the network. Enter all 12 digits and leave out the periods. For example, enter IP address 192.168.0.250 as 192168000250. The periods display automatically. Default is 0.0.0.0
- 7.8.3** ENTRE OUTBOUND TCP PORT:  **Entré Outbound TCP Port**  
 This option displays only if NET is chosen for the Entré connection. Enter the programming port number for the outbound Entré connection. The programming port identifies the port used to communicate messages to the Entré software. Default is 2001.

# REMOTE OPTIONS

- 7.8.4**   
 **Entré Backup IP Address**  
This option displays only if NET is chosen for the Entré connection. Enter the IP backup address where the panel sends network messages if the first Entré IP Address fails. The Entré IP Address must be unique and cannot be duplicated on the network. Enter all 12 digits and leave out the periods. For example, enter IP address 192.168.0.250 as 192168000250. The periods display automatically. Default is 0.0.0.0
- 7.8.5**   
 **Entré Backup TCP Port**  
This option displays only if NET is chosen for the Entré connection. Enter the backup programming port number for the outbound Entré connection in case the connection to the primary IP fails. Default is 2001.
- 7.8.6**   
 **Entré Checkin**  
Select the rate at which check-in messages are sent over the Entré connection. Select 0 (zero) to disable check in messages. Range is 0, 3-240 minutes. Default is 0.
- 7.8.7**   
 **Entré Passphrase**  
To enable encryption enter an 8 to 16-character Passphrase using alphanumeric characters. If you leave the Passphrase blank, the panel communicates with Entré, but the data is not encrypted. The Passphrase is blank by default.
- 7.9**   
 **Send Local Changes**  
This option allows the panel to automatically update Remote Link at the central station with any changes made to the panel.  
  
 Select NET or DD to send local programming changes or User Menu changes to user codes, user profiles, schedules, or holiday dates to Remote Link after exiting the programming or User Menu. If NET is selected, changes are sent using Network. If DD is selected, changes are sent using Dialer. Default is NO to disable this feature.
- 7.9.1**   
 **Remote Change IP**  
This option displays when NET is selected for Send Local Changes. Enter the IP address containing up to 12 digits. The Net IP Address must be unique and cannot be duplicated on the network. Enter all 12 digits and leave out the periods. For example, enter IP address 192.168.0.250 as 192168000250. The periods display automatically. Default is 000.000.000.000
- 7.9.2**   
 **Remote Change Port**  
This option displays when NET is selected for Send Local Changes. Enter the Port number. Valid numbers are from 0 to 65535. Default is 2002.
- 7.9.3**   
  
 **Remote Telephone Number**  
This option displays when DD is selected for Send Local Changes. Press COMMAND to enter the phone number the panel dials when sending programming changes. After entering a phone number, the panel sends any panel changes to Remote Link.  
The phone number can have two lines of 16 characters each to equal 32. Enter a P to program a two second pause in the dialing sequence. The P character counts as part of the 32 allowable characters. Enter \*70P as the string first characters to cancel call waiting. Dial tone detect is an automatic panel function.

**System Reports**

**8.1**

**SYSTEM REPORTS**

**System Reports**

Select specific system reports the panel sends to the receiver.

**8.2**

**ABORT NO YES**

**Abort Report**

**YES** allows the panel to send an alarm abort report to the receiver any time an area is disarmed during Transmit Delay before an alarm report is sent and the Bell Cutoff Time has not expired. After disarming an area, if any other area remains armed and has zone(s) in alarm, the alarm abort report is not sent.

If the communication type is set to DD, a Warning: Alarm Bell Silenced report is also sent if the alarm bell is silenced.

**Note:** Abort Reports are not sent for Fire, Fire Verify, or Supervisory type zones.

**8.3**

**RESTORAL: YES**

**Restoral Reports**

This option allows you to control when and if a zone restoral report is sent to the central station receiver. Press any Select key to display the following options:

**NO YES DISARM**

**NO** - Disables the zone restoral report option. Zones continue to operate normally but do not send restoral reports to the receiver.

**YES** - Enables the zone restoral report option. Zone restorals are sent whenever a zone restores from a trouble or alarm condition.

**DISARM** - Causes the panel to send restoral reports for a non-24-hour zone whenever a zone that has restored from a trouble or alarm condition is disarmed. All 24-hour zones send restoral reports as they restore.

**8.4**

**BYPASS NO YES**

**Bypass Reports**

**YES** allows the panel to send all zone bypasses, resets, and force arm reports to the receiver. The bypass report includes the zone number, zone name, and the user name and number of the individual operating the system. Reports are only sent if O/C User in Communications is set YES for Receiver 1 or Receiver 2.

**8.5**

**SCHD CHG NO YES**

**Schedule Change Reports**

**YES** allows the panel to send all schedule changes to the receiver. The report includes the day, opening time, closing time, extend schedule time, and the user name and number of the individual making the change. Schedule changes made through Remote Link™ are not sent to the printer or Display Events.

**8.6**

**CODE CHG NO YES**

**Code Change Reports**

**YES** allows the panel to send all code additions, changes, and deletions to the receiver. The code change report includes the user name and number added or deleted and the user name and number of the individual making the change. Code changes made through Remote Link™ are not sent to the printer or Display Events. Reports are only sent if O/C User in Communications is set YES for Receiver 1 or Receiver 2. The default setting is YES.

**8.7**

**ACCESS KEYPADS:**

**Access Keypads**

Select the keypad addresses (1 through 16) that send door access reports to the receiver. Enter the keypad number using the digit keys. An asterisk next to the number indicates that the keypad is selected. Press COMMAND to display the next set of keypads.

A report is sent with each door access made from the selected keypads. Keypads at addresses not selected still operate the door relay but do not send access reports. The report includes the user number, user name, keypad address, and device name.

## SYSTEM REPORTS

- 8.8**  AMBUSH  NO  YES **Ambush**  
YES allows an ambush report to be sent anytime user code number 1 is entered at a keypad. NO disables the ambush report and allows user number 1 to operate the same as all other codes.
- 8.9**  PANIC TST  NO  YES **Panic Test Communication (XR500N/XR500E only)**  
YES allows the panic zone test verification and failure results to be sent to the central station receiver. NO disables the panic test report. The default setting is NO. The system test start, stop, panic zone verification, and panic zone failure messages sent to the central station and the trips count operation are the same as used under the Walk test. See Using the Walk Test section in the Appendix.



**System Options**

9.1

SYSTEM OPTIONS

**System Options**

This section allows you to select system-wide parameters.

9.2

SYSTEM: AREA

**System**

This option allows you to program how the areas operate for arming and disarming. The options you can choose are listed below:

AREA A/P H/A GST

**AREA** - All 32 areas can be programmed and operated independently.

**ALL/PERIMETER** - Area 1 is the Perimeter and Area 2 is the Interior.

**HOME/SLEEP/AWAY** - Area 1 is the Perimeter, Area 2 is the Interior, and Area 3 is the Bedrooms. With the HOME/SLEEP/AWAY option, the user can:

1. Select HOME to arm just the perimeter.
2. Select SLEEP to arm the perimeter and interior (non bedroom areas).
3. Select AWAY to arm all three areas.

**Note:** A Home/Sleep/Away system can be configured to use all three areas or only use the Home and Away areas.

**HOME/SLEEP/AWAY WITH GUEST**- This allows the alarm system to be divided into a main house HOME/SLEEP/AWAY system and two other guest houses that also are set up as HOME/SLEEP/AWAY systems.

Areas 1, 2, and 3 are the Perimeter, Interior, and Bedrooms for the Main house system. Areas 4, 5, and 6 are the Perimeter, Interior, and Bedrooms for the Guest 1 house system. Areas 7, 8, and 9 are the Perimeter, Interior, and Bedrooms for the Guest 2 house system. These areas are automatically assigned per system and cannot be changed. See Display Areas in Device Setup to assign keypads to a system. Zones are assigned to a system by assigning the system's area numbers to the zone in Zone Information programming.

When either All/Perimeter or Home/Sleep/Away is selected, the area names are automatically assigned and cannot be modified.

**Note:** Areas 3-32 in an All/Perimeter system, areas 4-32 in a Home/Sleep/Away system, and areas 10-32 in a Home/Sleep/Away with Guest system are not available for use and are initialized.

9.3

INST ARM NO YES

**Instant Arming**

When YES is selected, the arming keypad displays INSTANT for selection during the exit countdown delay when arming fewer than all areas of the system. At the time instant arming is selected, any entry and exit delays programmed for the areas being armed are ignored. The entry delay for previously armed areas is not affected by instant arming. When NO is selected, INSTANT does not display during arming. Default is NO for an Area System, and YES for an All/Perimeter or Home/Sleep/Away system.

9.4

CLS WAIT NO YES

**Closing Wait**

When YES is selected, the keypad displays ONE MOMENT... while waiting for an acknowledgement from the receiver before arming the selected area(s) and performing a Bell Test (if selected). Exit delays begin after the Closing Wait. Opening/Closing reports must be YES to enable Closing Wait.

9.5

ENTRY DLY 1: 30

**Entry Delay 1**

ENTRY DLY 2: 60

Enter the Entry Delay time for all Exit type zones programmed to use Entry Delay 1.

ENTRY DLY 3: 90

When an armed Exit type zone is faulted, the keypad prewarn tone begins sounding. All keypads programmed to prewarn for that zone display ENTER CODE:- and the name of the zone causing the entry delay. When the first digit of a code is entered, the prewarn tone stops at that keypad. If an invalid code is entered, the prewarn tone begins sounding again. The area must be disarmed before the delay expires or an alarm report is sent to the receiver and an alarm sounds. All zones in that area are delayed along with the Exit zone. Entry Delay times can be from 30 to 250 seconds. Repeat the above for each entry delay being used in the system.

ENTRY DLY 4: 120

**Note:** Specific Exit Error operation is based on the Entry Delay used (1-4) with an EX type zone. See Exit Delay.



- 9.6**  **Cross Zone Time**  
Enter the time allowed between zone faults. When zones are cross zoned, the same zone or a second cross zoned zone must fault within this time in order for an alarm report for both zones to be sent to the receiver. If the cross zone time expires without the second zone faulting, only a zone fault from the first zone is reported. Cross-zone time can be from 4 to 250 seconds. Entering 0 (zero) disables this function. Default is 4. See the Appendix.
- 9.7**  **Zone Retard Delay**  
Enter the retard time assigned to Fire, Supervisory, Auxiliary 1, Auxiliary 2, Arming, and Panic type zones. The retard delay only functions when the zone is shorted. The zone must remain shorted for the entire length of the Retard Delay before being recognized by the panel. The Zone Retard Delay can be from 1 to 250 seconds. Entering a 0 (zero) disables this function.
- 9.8**  **Power Fail Delay**  
This option tracks the duration of an AC power failure. When the AC power is off for the length of the programmed delay time, an AC power failure report is sent to the receiver. The delay time can be from 1 to 15 hours. Entering a 0 (zero) sends the power failure report after a 15-second delay. The default setting is 1.
- 9.9**  **Swinger Bypass Trips**  
Enter the number of times (1 or 2) a zone can go into an alarm or trouble condition within one hour before being automatically bypassed. You can select one or two trips. Bypassed zones are automatically reset when the area they are assigned to is disarmed. All 24-hour zones are reset when any area of the system is disarmed. A programming Stop operation restores a bypassed zone. Entering 0 (zero) disables this function. Default is 1.
- How it works**  
The panel hour timer starts at 59 minutes past the hour. If the hour timer expires before the trip counter is exceeded, the trip counter returns to 0 (zero). If the trip counter is exceeded before the hour expires, the zone is automatically bypassed by the panel. A Bypass Report is sent to the receiver if Bypass Reports is YES.
- 9.10**  **Reset Swinger Bypass**  
When YES is selected, an automatically bypassed zone is reset if it remains in a normal condition for one complete hour after being bypassed. A report of the automatic reset is sent to the receiver if Bypass Reports has been selected as YES. Default is NO.
- 9.11**  **Time Zone Changes**  
This function allows the panel to request automatic time changes from the DMP SCS-1R Receiver on Path 1. For the receiver to send time changes, it must be programmed to send time changes and must be receiving time change updates from the network automation computer at least every 24 hours. Default is YES.
- When time zone is programmed YES, enter the number (0-23) that indicates the Greenwich Time zone (GMT) where the panel is located. The default is 6.

GMT	City/Time Zone
0	London, Monrovia, Lisbon, Dublin, Casablanca, Edinburgh
1	Cape Verde Island, Azores
2	Mid-Atlantic, Fernando de Noronha
3	Buenos Aires, Georgetown, Brasilia, Rio de Janeiro
4	Atlantic Time (Canada), Caracas, La Paz, Santiago
5	Eastern Time (US, Canada) Bogota, Lima, Arequipa
6	Central Time (US, Canada), Mexico City, Saskatchewan
7	Mountain Time (US, Canada), Edmonton
8	Pacific Time (US, Canada), Tijuana
9	Alaska
10	Hawaii
11	Midway Island, Samoa
12	Fiji, Marshall Island, Wellington, Auckland, Kwajalein, Kamchatka

GMT	City/Time Zone
13	New Cadelonia
14	Guam, Sydney
15	Tokyo, Seoul
16	Hong Kong, Singapore
17	Bangkok, Hanoi
18	Dhaka, Almaty
19	Islamabad, Karachi
20	Abu Dhabi, Kazan
21	Moscow, Bagdad
22	Eastern Europe
23	Rome, Paris, Berlin

## 9.12 LATCH SV NO YES **Latch Supervisory Zones**

Selecting YES latches supervisory zone alarms on the keypad display until the sensor reset operation is performed. Selecting NO automatically clears the alarm from the keypad display when the supervisory zone restores to a normal condition. Default is YES.

## 9.13 PROG LANGUAGE **Programming Menu Language**

Press the COMMAND key to select the programming language. Any changes in PROG LANGUAGE do not take effect until the STOP routine completes.

PRI LANG: ENGLISH The current primary programming language displays. The default language is English. Press a Select key to change the primary programming language.

ENG SPN FRN Select the primary programming language.  
 ENG = English (ENGLISH)  
 SPN = Spanish (ESPAÑOL)  
 FRN = French (FRANCAIS)

SEC LANG: NONE The current secondary programming language displays. Selecting a secondary language allows the installer to view programming in English, Spanish, or French. When the Programming Menu is accessed, the installer is prompted to choose the programming display language. If SEC LANG: is set to NONE, the option to choose a language does not display. To select a secondary language, press the Select key below the language. Default is NONE.

NONE ENG SPN FRN Select the secondary programming language.  
 NONE = No secondary language options are displayed  
 ENG = English (ENGLISH)  
 SPN = Spanish (ESPAÑOL)  
 FRN = French (FRANCAIS)

## 9.14 USER LANGUAGE **User Menu and Status List Language**

Press the COMMAND key to select User language.

PRI LANG: ENGLISH The current primary user language displays. The default language is English. Press a Select key to change the primary User language.

ENG SPN FRN Select the primary user language.  
 ENG = English (ENGLISH)  
 SPN = Spanish (ESPAÑOL)  
 FRN = French (FRANCAIS)

SEC LANG: NONE The current secondary user language displays. Selecting a secondary user language allows the user to view the User Menu and Status List text in English, Spanish, or French. When the User Menu is accessed, the user is prompted to choose the display language. Status List text displays in the selected language until another language is chosen. If SEC LANG: is set to NONE, the option to choose a language does not display. To select a secondary language, press the Select key below the language. Default is NONE.

# SYSTEM OPTIONS

For example, when Spanish is selected at a keypad, the User Menu and Status List text display in Spanish at **that** keypad. When the user later accesses the keypad, pressing the COMMAND key once displays the option for English, Spanish, or French. Pressing the COMMAND key again continues to display the Status List text in Spanish. Later on, if English or French is selected at **that** keypad, the User Menu and Status List text display in the selected language at **that** keypad.

NONE ENG SPN FRN

Select the secondary user language.

NONE = No secondary language options are displayed

ENG = English (ENGLISH)

SPN = Spanish (ESPAÑOL)

FRN = French (FRANCAIS)

9.15

BYPASS LIMIT 0

## Bypass Limit

Enter the maximum number of zones (0 to 8) that can be bypassed in any single area when that area is being armed at a keypad. If more zones than the limit are in a non-normal state or already bypassed at arming, arming does not occur and Arming Stopped displays. The Bypass limit does not affect auto arming or keyswitch arming. Entering 0 (zero) allows no limit. Default is 0 (zero).

9.16

CARD PLUS PIN:  
NO YES

## Card Plus PIN (XR500E only)

Select YES to require all users to present a proximity credential and enter a PIN number wherever user code entry is required for system functions accessed from a keypad. Select NO to disable Card Plus PIN operation. Default is NO.

**Note:** The Card Plus PIN option is not designed to operate with All/Perimeter or Home/Sleep/Away systems.

For an XR500E system using Card Plus PIN, two code entries are required by a user to operate the system from a keypad. The first must be a code entered from a Wiegand interface device (card, fob, etc.) using a reader such as the built-in reader of a DMP Keypad. An external reader may also be used. The second code (User Pin) is keyed in at the keypad or could be a second card or fob.

For a Card Plus PIN system, user codes (Card and PIN) are typically administered using DMP System Link software.

When this option is first turned on at a keypad, the factory default (user number 9999, user code 99) must be available to enter the user menu at a keypad to then add user codes and PIN numbers or to change existing users to add their PIN number. If user 9999 was previously removed, re-enter this user and then set Card Plus Pin = YES. Afterwards, user 9999 can be removed and the system only allows card plus PIN entries.

**Note:** Current users of an existing system are immediately affected in that they must have their user code information changed to add the user PIN.

9.17

WIRELESS  
HOUSE CODE: 0

## House Code

When using a DMP wireless system, enter a house code between 1 and 50. When using FA Series wireless enter 99. See Wireless programming in Zone Information. Default is 0 indicating no wireless system is being used.

The DMP house code identifies the panel, DMP receiver, and DMP transmitters to each other. When operating, the DMP receiver listens for transmissions that have the programmed house code and transmitter serial number.

**Note:** The flexibility of DMP two-way wireless operation allows an existing house code to be changed in the panel at any time. The transmitters may take up to two minutes to learn the new house code and continue operation.

**Note:** When any wireless zone programming is changed in the panel, wireless receiver zone programming is updated. At that point, all wireless zones display as normal for approximately 1 minute, regardless of the actual state of the zone.

9.18

DETECT WIRELESS  
JAMMING: NO YES

## Detect Wireless Jamming

This option displays when the House Code entered is for a DMP 1100 Series Wireless system (1-50). When enabled and the wireless receiver detects jamming, a trouble or alarm message displays in the Status List and is sent to the central station receiver. Select YES to enable jamming messages to display in the Status List. Select NO to disable jamming messages. Default is NO.

**9.19**

WLS AUDIBLE: DAY

**Wireless Audible Annunciation**

This option displays when the House Code entered is for a DMP 1100 Series Wireless system (1-50). Press any top row key to select the keypad buzzer annunciation method for wireless low battery and missing messages. Select ANY to enable annunciation anytime. Select DAY to enable annunciation except during sleeping hours (9 PM to 9 AM). Select MIN (minimum) to annunciate only Fire and Fire Verify zones during daytime hours (9 AM to 9 PM). Default is DAY.

WIRELESS AUDIBLE  
ANY **DAY** MIN

**9.20**

KEYPAD PANIC KEYS  
ENABLED: NO **YES**

**Enable Keypad Panic Keys**

This option allows the two-button panic key operation selected at the keypad to send the Panic, Emergency, or Fire message to the central station receiver. Select YES to enable the two-button panic operation to operate. To disable the two-button panic operation, select NO. Default is YES.

**9.21**

OCCUPIED  
PREMISES: NO **YES**

**Occupied Premises**

For All/Perimeter or Home/Sleep/Away systems, select YES to allow the panel to automatically disarm the interior area(s) when arming all areas and a perimeter zone is not tripped during the exit delay. Select NO to disable this feature. Default is YES.

**Note:** With a Home/Sleep/Away with Guest arming system, this feature only applies to the main system.

**9.22**

ENHANCED ZONE  
TEST: NO **YES**

**Enhanced Zone Test**

Select YES to allow enhanced zone test operation. The default is NO.

Enhanced operation allows:

- Panic Test and Walk Test functions can be restricted to operate only during an Area 32, Shift 4 schedule if programmed. If no schedule is entered, the walk test always operates.
- A Verify message is sent each time a zone is tested. If a zone is tripped multiple times, a Verify message is sent for each trip. This allows the Central Station to record the number of devices per zone.
- The Verify message for each zone test is sent at the time the trip occurs instead of at the end of Walk Test.
- The System Test Begin and System Test End Central Station messages indicate the type of zone being tested. The System Test Begin message also includes the user name and number.

**9.23**

DUAL EOL NO **YES**

**Dual EOL**

Select YES to enable the use of dual 1K EOL resistors on panel zones one to eight. This zone operation is used for medium or high risk ULC Listed applications. Please see Dual EOL section in the XR500 Series Canadian Installation Guide for complete details. Select NO to disable this feature. Default is YES.

**9.24**

SEND 16 CHAR  
NAMES: NO **YES**

**Send 16 Character Names**

This option allows central stations to select being sent either the first 16 characters of the name field or the entire programmed name, up to 32 characters, for user name, user profile, zone name, area name, output name, and group name.

Select YES to have the first 16 characters of the name field sent to the central station. Select NO to send the exact number of characters entered in the name field from 1 up to the maximum of 32 characters. Default is YES.

**Note:** Using 32 character names increases the length of the DMP Serial 3 message from the panel to the receiver. The SCS-1R receiver does not require an update to pass these messages to the Host Automation System of the Central Station. Before using names longer than 16 characters, determine whether the Host Automation System of your Central Station can accept 17 to 32 character names. If not, only use 16 character names.

## Bell Options

- 10.1**

BELL OPTIONS
--------------

**Bell Options**  
This section allows you to program the panel bell output functions.
- 10.2**

BELL CUTOFF: 15
-----------------

**Bell Cutoff Time**  
Enter the maximum time from 1 to 99 minutes the Bell Output remains on. If the area is disarmed, the cutoff time resets. Enter 0 (zero) to provide continuous bell output. The default is 15 minutes.  
**Note:** To support the Alarm Verify feature on an All/Perimeter or Home/Sleep/Away system, set the Bell Cutoff Time to greater than 0.  
**Note:** For SIA CP-01 False Alarm Reduction Installations, the Bell Cutoff Time must be set to a minimum of six (6) minutes.
- 10.3**

BELL TST NO YES
-----------------

**Automatic Bell Test**  
Select YES to turn on the Bell Output for 2 seconds each time the system is completely armed from a keypad. This test is delayed until the Closing Wait acknowledge is received (if programmed). If the Closing Wait acknowledge is not received within 90 seconds, the bell test does not occur. Arming performed from an Arming zone or from Remote Link™ does not activate the Bell Test.
- 10.4**

BELL OUTPUT: 0
----------------

**Bell Output**  
Enter the output number when needed to follow the panel Bell Output operation for all action and off conditions. Enter 0 (zero) to disable.  
**Note:** When BELL ACTION is set to T for Temporal Code 3, the Bell Output action for an LX-Bus output is pulse.
- 10.5**

BELL ACTION . . . . .
-----------------------

**Bell Action**  
This section defines the type of Bell Output for zone alarms. Press COMMAND to display the default Bell Output for each zone type. Press any Select key and enter S for a Steady Bell Output, P for a Pulsed output, T for a Temporal Code 3 output, and N for no Bell Output.  
**Note:** Trouble conditions do not activate the Bell Output.
- 10.5.1**

FIRE TYPE: P
--------------

**Fire Bell Action**  
Defines Bell Action for Fire Type zones. The default is P.
- 10.5.2**

BURGLARY TYPE: S
------------------

**Burglary Bell Action**  
Defines Bell Action for Burglary Type zones and Exit Error output. The default is S.
- 10.5.3**

SUPRVSRY TYPE: N
------------------

**Supervisory Bell Action**  
Defines Bell Action for Supervisory Type zones. The default is N.
- 10.5.4**

PANIC TYPE: N
---------------

**Panic Bell Action**  
Defines Bell Action for Panic Type zones. The default is N.
- 10.5.5**

EMERGENCY TYPE: N
-------------------

**Emergency Bell Action**  
Defines Bell Action for Emergency Type zones. The default is N.
- 10.5.6**

AUXLRY 1 TYPE: N
------------------

**Auxiliary 1 Bell Action**  
Defines Bell Action for Auxiliary 1 Type zones. The default is N.
- 10.5.7**

AUXLRY 2 TYPE: N
------------------

**Auxiliary 2 Bell Action**  
Defines Bell Action for Auxiliary 2 Type zones. The default is N.



**Output Options**

**11.1**

OUTPUT OPTIONS

**Output Options**

This section allows you to program panel output options. The panel provides two Form C relays (1 and 2) and four switched ground (open collector) outputs numbered 3 to 6. Expand the system up to 500 additional relay outputs using J22 LX-Bus on the panel, multiple 716 Output Expander Modules, and up to five interface cards. In addition, 45 wireless outputs are available when using the 1100X wireless receiver. Refer to the XR500 Series Canadian Installation Guide (LT-0681) for complete information.

Select from the following output numbers:

- 1 to 6
- 450 to 474 – Slow response time\* wireless outputs (activates within 15 seconds)
- 480 to 499 – Fast response time\* wireless outputs (activates within 1 second)
- 500 to 999 – LX-Bus output, Relay output, Zone expansion output
- D1 to D16 – Keypad door strike relay for addresses 1-16
- G1 to G20 – Output group

\* The response time of a wireless output is the time it takes for a wireless output to activate once the panel event occurs. You determine whether a wireless output is a slow or fast response based on the output number assigned. A slow response output number extends battery life, but response time may be up to 15 seconds. A fast response output number responds within 1 second, but reduces battery life. Refer to the specific wireless output installation guide to determine battery life.

**11.2.1**

CO OUTS: - - - - -

**Cutoff Output**

Outputs 1 to 6 can be entered here to turn off after a time specified in CUTOFF TIME. To disable this option, press any Select key to clear the display then press COMMAND. The Cutoff Output displays dashes when no outputs are selected.

**11.2.2**

CUTOFF TIME: 0

**Output Cutoff Time**

If a Cutoff Output (1-6) is assigned, enter a Cutoff Time of 1 to 99 minutes for the output to remain on. Enter 0 (zero) for continuous output.

**11.3**

COMM TRBL OUT: 0

**Communication Trouble Output**

Enter the output number to turn on when a DD system fails to communicate on three successive dial attempts or if the backup communication line transmits a report. The Communication Trouble Output also turns on when NET is selected as the primary communication method and NET communication fails after one minute. When NET communication is restored the Communication Trouble Output automatically turns off.

To manually turn the output off, disarm any area or select Off for the output number in the User Menu Outputs On/Off section. Enter 0 (zero) to disable this output.

**11.4**

FIRE ALR OUT: 0

**Fire Alarm Output**

Enter the output number to turn on when a fire type zone is placed in alarm. The output is turned off using the Sensor Reset option while no additional fire type zones are in alarm. Enter 0 (zero) to disable. This output is not compatible with Cutoff Outputs.

**11.5**

FIRE TRB OUT: 0

**Fire Trouble Output**

Enter the output number to turn on when a fire type zone is placed in trouble, when a supervisory type zone is placed in alarm or trouble, or when any system monitor (AC, Battery, Phone Line 1 or Phone Line 2) is placed in trouble. The output turns off when all fire and supervisory type zones, or system monitors are restored to normal. Enter 0 (zero) to disable this output. This output is not compatible with Cutoff Outputs. This output can be connected to a lamp, LED, or buzzer using the DMP Model 716 Output Expansion Module.

# OUTPUT OPTIONS

11.6

PANIC ALM OUT: 0

## Panic Alarm Output

Enter the output number to turn on when any Panic type zone is placed in an alarm condition. The output is turned off after all Panic zones are restored from an alarm condition and a Sensor Reset is performed. Enter 0 (zero) to disable.

### Wireless Outputs

- The Panic Alarm is compatible with the Model 1118 Wireless Remote Indicator Light and the Model 1116 Wireless Relay Output connected to a Model 572 Indicator LED.
- When a Panic Alarm occurs, the LED turns on steady for five minutes and then turns off.
- When a Panic Test is initiated from the keypad, the LED flashes quickly for five minutes.
- For a Panic Alarm, a fast response wireless output number is recommended.

11.7

AMBUSH OUT: 0

## Ambush Output

Enter the output number to turn on when an Ambush code is entered at a keypad. The output is turned off using the Sensor Reset option. Enter 0 (zero) to disable.

11.8

ENTRY OUT: 0

## Entry Output

Enter the output number to turn on at the start of the entry delay time. The output turns off when the area is disarmed or the entry delay time expires. Enter 0 (zero) to disable.

11.9

EXIT OUT: 0

## Exit Output

Enter the output number to turn on when an exit delay time starts in any area of the system. The output turns off when the area arms or when the arming has been stopped. Enter 0 (zero) to disable.

11.10

READY OUT: 0

## Ready Output

Enter the output number to turn on when all disarmed burglary zones are in a normal state. The output is turned off when any disarmed burglary type zone is in a bad state. Enter 0 (zero) to disable. This output is not compatible with Cutoff Outputs.

11.11

PH TRBL OUT: 0

## Telephone Trouble Output

Enter the output number to turn on when the phone line monitor on the panel phone line is lost. Enter 0 (zero) to disable this output.

11.12

LATE CLS OUT: 0

## Late To Close Output

Enter the output number to turn on at the expiration of a Closing schedule. The output activates simultaneously with the CLOSING TIME! keypad display. The output is turned off when the area is armed, the Closing is extended, or the schedule is changed. Enter 0 (zero) to disable this output.

11.13

DVC FAIL OUT: 0

## Device Fail Output

Enter the output number to turn on when an addressed device fails to respond to polling from the panel. A Missing Device report is sent to the receiver. The output is turned off when the device responds to polling or is removed from programming in the system. Enter 0 (zero) to disable this output and LX-Bus™ device fail reporting to the receiver. If any addressed device is unsupervised, this output cannot be used.

11.14

SNRSR RST OUT: 0

## Sensor Reset Output

Enter the output number to turn on when a Sensor Reset is performed at a keypad. The output turns off automatically 5 seconds later. This function can be used to reset smoke detectors that are operated by an external power supply through a Model 716 Output Expander Module. Enter 0 (zero) to disable this output.



## 11.15

CLS WAIT OUT: 0

### Closing Wait Output

Enter the output number to turn on for approximately four (4) seconds when Closing Wait is programmed as YES and the panel successfully communicates the closing message at arming. If the closing message does not communicate successfully, this output does not turn on.

## 11.16

ARM-ALARM OUT: 0

### Arm-Alarm Output

Enter the output number to turn on steady when any area of the system is armed. If an alarm occurs causing the keypads to turn Red, this output pulses and continues to pulse for approximately five (5) minutes after the panel is disarmed. Enter 0 (zero) to disable.

#### Wireless Outputs

- The Arm-Alarm Output is compatible with the Model 1117 Wireless LED Annunciator and the Model 1116 Wireless Relay Output connected to a Model 572 Indicator LED.
- When the Model 1117 is battery operated, the LED is off when the system is armed to conserve battery life. If an alarm occurs, the output flashes quickly.
- When using the Model 1116 connected to a Model 572, the LED is on when the system is armed. If an alarm occurs, the output pulses.
- To operate the Arm-Alarm output within one second, program a fast response number from 480 to 499. Fast response operation reduces overall wireless output battery life.
- To operate the Arm-Alarm output within 15 seconds, program a slow response number from 450 to 474. Slow response operation increases overall wireless output battery life.

## Output Information

- 12.1**

OUTPUT INFO
-------------

**Output Information**  
This section allows you to program wireless outputs and name wired outputs.
- 12.2**

OUTPUT NO. X X X
------------------

**Output Number**  
Enter an output number. Entry range is 1 to 6, 450 to 474, 480 to 499, 500 to 999.
- 12.3**

OUTPUT NAME
-------------

**Output Name**  
This section allows you to define a 32 character alphanumeric name for any output numbers. The name can display on the keypad when a user performs the browser feature at Outputs On/Off. See the XR100/XR500 User's Guide (LT-0683CAN) Appendix for browser operation.
- 12.4**

OUTPUT REAL-TIME STATUS NO YES
--------------------------------

**Output Real-Time Status**  
Selecting YES allows Real-Time Status reports, such as Output ON, OFF, PULSE, or TEMPORAL to be sent using PC Log reports. Selecting NO disables Real-Time Status for this output device. Default is NO.
- 12.5**

SERIAL#: XXXXXXXX
-------------------

**Serial Number**  
This option and the next option only display when the output number entered is for a wireless output. Enter the eight-digit serial number found on the wireless device.
- |                               |
|-------------------------------|
| ALREADY IN USE OUTPUT NO: XXX |
|-------------------------------|

 This message displays when the serial number is already programmed for another output. The programmed output number displays.
- 12.6**

SUPRVSN TIME: 240
-------------------

**Supervision Time**  
Press any top row key to select the supervision time required for the wireless output. Press COMMAND to accept the default time. Default is 240 minutes.
- Note:** Refer to the Wireless Check-in and Supervision Time Definitions section of the Appendix for supervision information.
- |                               |
|-------------------------------|
| SELECT MINUTES:<br>0 3 60 240 |
|-------------------------------|

 Press the Select key under the required number of minutes. The wireless output must check in at least once during this time or a missing condition is indicated for that output. Zero (0) indicates an unsupervised transmitter.
- Note:** When the panel is reset, a receiver is installed or powered down and powered up, or programming is complete, the supervision timer restarts for all wireless outputs.

## Output Groups

13.1

OUTPUT GROUPS

### Output Groups

This function allows you to assign outputs to groups. Output groups can be assigned to other areas of programming such as Output Options or Alarm Action of Zone Information, just like single outputs are assigned. This allows the entire group of outputs to turn on and off as required by the programming option.

13.2

GROUP NO: -

### Group Number

Enter a group number from 1 to 20. Up to 20 different groups may be assigned.

13.3

GROUP NAME X X

### Group Name

The group name displays. To change the default name, press any top row Select key then enter up to 32 characters for the group name. Press COMMAND to enter the outputs to be assigned to the group.

13.4

OUTPUT NO 1: 0

OUTPUT NO 2: 0

OUTPUT NO 3: 0

OUTPUT NO 4: 0

OUTPUT NO 5: 0

OUTPUT NO 6: 0

OUTPUT NO 7: 0

OUTPUT NO 8: 0

### Output Number

Enter the Output number. Entry range is 1 to 6, 450 to 474, 480 to 499, 500 to 999 (outputs), D1 to D16 (doors), and G1 to G20 (groups). The maximum number of outputs that can be assigned to a specific group is eight.

An output group may be assigned as one of the output numbers in another output group.

**Example:** Output Group 1 consists of only four assigned outputs. Output Group 1 could be assigned as one output in Output Group 2. Output Group 2 could still have 7 other outputs assigned to that group. When Output Group 2 is turned on, 11 outputs could be turned on. This allows Output Groups to be assigned within other Output Groups providing many combinations.

Output groups 1 to 10 can be assigned by a user profile for applications such as elevator control. See the XR500 User's Guide (LT-0683CAN) Output Group section for additional information.

Output groups 11 to 20 cannot be assigned to a profile and are available for installation applications such as special lighting, etc. To assign these groups to a profile, use Remote Link™ or System Link™ software from DMP.

## Menu Display

- 14.1** MENU DISPLAY **Menu Display**  
Menu Display allows you to select at which keypad addresses the user can access the following functions.  
To select a keypad, enter the device number (keypad address) using the digit keys on the keypad. When a keypad is selected, an asterisk appears next to the keypad address. Enter the number again to deselect the keypad. Press the COMMAND key to display the next set of keypads (9 through 16). Refer to the Multiple Displays section at the beginning of this document.
- 14.2** ARMED STATUS: **Armed Status**  
Enter the keypad addresses (1 through 16) that show the armed areas. The User Menu Armed Areas function also displays the custom area name you enter in Area Information.  
When only areas one to eight are used, the Armed Status display is 1 2 3 4 5 6 7 8. When areas nine or higher are used the system Armed Status display reads ALL SYSTEM ON or SYSTEM ON. Press the COMMAND key to display additional areas. Refer to the Multiple Displays section at the beginning of this document and in the XR500 User's Guide (LT-0683CAN).
- 14.3** TIME DISPLAY: **Time**  
Enter the keypad addresses that can display the time and day of the week.
- 14.4** ARM/DIS DISPLAY: **Arm/Disarm**  
Enter the keypad addresses from which users can arm and disarm areas.

## Status List

### 15.1 STATUS LIST **Status List**

This function allows you to select the zone alarms and troubles, and system monitor troubles displayed at the keypads. The Status List function operates automatically when the keypad is not performing any other function.

The keypad stays in the Status List until the user arms or disarms or selects a menu option. Status List alternates with the Armed Status on keypad addresses selected in the **Menu Display - Armed Status** section. You can choose to have System Monitor troubles placed in the list, the different zone types placed in the list, and at which keypad addresses they display.

To select a keypad, enter the device number (keypad address) using the digit keys on the keypad. When a keypad is selected, an asterisk appears next to the keypad address. Enter the number again to deselect the keypad. Press the COMMAND key to display the next set of keypads (9 through 16). Refer to the Multiple Displays section at the beginning of this document.

### 15.2 DISPLAY KEYPADS: **Display Keypads**

This option defines which keypad addresses display the various status information. Any combination of addresses can be entered to display the status items that follow. If you do not want a particular status item to display, do not enter any addresses.

### 15.3 SYSTEM TROUBLES: **System Monitor Troubles**

Specifies the keypad addresses (1 through 16) where any trouble on a System Monitor displays. The System Monitors include the following:

- AC Power
- Battery Power
- Closing Check
- Panel Box Tamper
- Phone Line 1
- Phone Line 2 (requires the 893A Dual Phone Line Module)
- Wireless Receiver Trouble
- Wireless Jamming Trouble or Alarm

The System Monitor name is placed in the Status List and the keypad steady trouble buzzer sounds. The buzzer remains on until any keypad top row Select key is pressed. The name remains in the list until the condition is restored. The buzzer sounds at 10:00 am daily until the system trouble is cleared from the Status List.

### 15.4 FIRE ZONES: **Fire Zones**

Specifies the keypad addresses (1 through 16) where all fire zone alarms and troubles display. The zone name displays and, if it is a trouble condition, the keypad steady trouble buzzer sounds. The buzzer remains on until any top row Select key is pressed and a user code is entered. If a trouble condition remains in the display, the buzzer sounds at 10:00 am daily until the trouble is cleared from the Status List.

When using LCD Keypads, the panel provides distinct speaker tones from the keypad for Fire:

**On** - Fire zone alarm and Bell Output or Fire Bell Output is ON.

**Off** - Alarm Silence

## 15.5 BURGLARY ZONES: **Burglary Zones**

Specifies the keypad addresses (1 through 16) where all burglary zone alarms and troubles display. Burglary zones include Night, Day, and Exit type zones. Burglary zone troubles remain in the list until the zone restores. All keypads are selected by default.

For zone alarms, only the last burglary zone tripped remains in the list. The alarm remains in the list until another burglary zone goes into alarm, any area of the system is disarmed, or 10 minutes elapse without an alarm. This ensures that if a burglary is in progress the last zone tripped remains in the list even if the zone is restored.

The keypad buzzer sounds for one second on burglary alarms.

When using LCD Keypads, the panel provides distinct speaker tones from the keypad for Burglary:

**On** - Burglary zone alarm and Bell Output or Burglary Bell Output is ON.

**Off** - Alarm Silence.

You can further define which keypad address shows a Burglary Zone event by entering that area number in the Display Areas menu during Device Setup.

## 15.6 SPRVISORY ZONES: **Supervisory Zones**

Specifies the keypad addresses (1 through 16) where all supervisory zone alarms and troubles display. Supervisory zones are entered in the status list and sound the keypad buzzer until a valid user code is entered at any keypad address. If a trouble condition remains in the display, the buzzer sounds at 10:00 am daily until the supervisory trouble is cleared from the Status List.

## 15.7 PANIC ZONES: **Panic Zones**

Specifies the keypad addresses (1 through 16) where all panic zone alarms and troubles display. The name of the zone remains in the list until the zone restores. The keypad buzzer does not sound for panic alarms or troubles.

## 15.8 EMERGENCY ZONES: **Emergency Zones**

Specifies the keypad addresses (1 through 16) where all emergency zone alarms and troubles display. The name of the zone remains in the list until the zone restores. The keypad buzzer does not sound for emergency alarms or troubles.

## 15.9 AUX 1 ZONES: **Auxiliary 1 Zones**

Specifies the keypad addresses (1 through 16) where all Auxiliary 1 zone alarms and troubles display. The name of the zone remains in the list until the zone restores. The keypad buzzer does not sound for Auxiliary 1 alarms or troubles.

You can further define which keypad address shows an Auxiliary 1 Zone event by entering that area number in the Display Areas menu during Device Setup.

## 15.10 AUX 2 ZONES: **Auxiliary 2 Zones**

Specifies the keypad addresses (1 through 16) where all Auxiliary 2 zone alarms and troubles display. The name of the zone remains in the list until the zone restores. The keypad buzzer does not sound for Auxiliary 2 alarms or troubles.

You can further define which keypad address shows an Auxiliary 2 Zone event by entering that area number in the Display Areas menu during Device Setup.

## 15.11 COMM PATH TRBL: ALL NO YES **Communication Trouble**

Specifies when communication troubles are displayed on keypads that are programmed to display System Monitor Troubles. Default is NO.

Select YES to display communication trouble when any communication path fails.

Select ALL to display communication trouble only when all paths have failed.



## Printer Reports

- 16.1**  PRINTER REPORTS  **Printer Reports**  
This section allows you to define the operation of a local printer connected to the panel through the use of a DMP 462P Printer Interface Card. The 462P allows you to connect the DMP SCS-PTR or other compatible 40-character or 80-character serial printer to the panel.
- Printing the panel event buffer**  
The Display Events option in the User Menu contains a PRINT command that allows the user to send the contents of the panel event buffer to a local printer. The PRINT option is visible whether or not a 462P Printer Interface Card is attached to the panel.
- 16.2**  ARM/DIS  NO  YES **Arm and Disarm Reports**  
Prints arming, disarming, and Late to Close reports. Includes the area number, name, and action (armed, disarmed, or late), the user number, user name, and time and date.
- 16.3**  ZONE  NO  YES **Zone Reports**  
Prints changes in the active zones status. Includes the zone number, name, and type as well as the action (alarm, trouble, bypass, etc.) user number (if applicable) and area name. When the Walk Test or Panic Zone Test is performed, Verify and Fail messages also print for each zone.
- 16.4**  USR CMDS  NO  YES **User Command Reports**  
Prints user code changes, outputs turned ON or OFF (if operated by a schedule, SCH is shown in Display Events in place of the user number), schedule changes, and User Menu functions.
- 16.5**  DOOR ACS  NO  YES **Door Access Reports**  
Prints door access activity. Includes the door number, first and second user number, first and second user name, and the time and date of the door access.
- 16.6**  SUPV MSG  NO  YES **Supervisory Reports**  
Prints System Monitor Troubles and system events. See Status List - System Monitor Troubles.

## PC Log Reports

- 17.1**  PC LOG REPORTS **PC Log Reports**  
This section allows you to program the types of PC Log Reports the panel sends through the 462N Network Interface Card or through the J21 Serial Connector directly on the XR500 Series Canadian panel. The reports include information such as the type of activity, time and date of the activity, and user name and number. These data reports can be accessed from a PC using the Advanced Reporting Module. See the Installation Guide (LT-0681CAN) for detailed J21 setup information or the User's Guide (LT-0683CAN) for more information.  
**Note:** The network connection that sends PC Log Reports is not monitored for network trouble. The PC Log Reports option should NOT replace the primary communication method or act as a backup communication method.  
If there is trouble with the network connection, the panel continues to attempt to send the PC Log Reports until the connection is reestablished. The panel then sends the reports. A Network Trouble message is **NOT** sent if the connection is lost since this report tool is not designed to be monitored by a receiver. The PC Log Reports have the lowest priority of panel reports sent.  
For information about the 462N card capabilities with PC Log Reports and Network Communication method, see 462N Card Examples in the Appendix.  
**Note:** The PC Log Address String entered CANNOT be the same as that entered in Communication.
- 17.2**  COMM TYPE: **NONE** **Communication Type**  
 NONE NET 232 Select the Communication Type to send the PC Log Reports. Default is NONE.
- 17.3**  NET IP ADDRESS **Net IP Address**  
This option displays when the Communication Type for PC Log Reports is NET. Enter the IP address containing up to 16 characters. The Net IP Address must be unique and cannot be duplicated on the network. Enter all 12 digits and leave out the periods. For example, enter IP address 192.168.0.250 as 192168000250. The periods display automatically.
- 17.4**  NET PORT **2001** **Net Port**  
This option displays when Communication Type for PC Log Reports is Net. Enter the Port number. Valid numbers are from 0 to 65535. Default is 2001.
- 17.5**  232 COMM PORT: **0** **232 Communication Port**  
This option displays when Communication Type for PC Log Reports is 232. To enable PC Log Reports, select either the on-board connector (O) or select A, B, C, D or E for the corresponding slot in use on the DMP Model 462N Network Interface card. The slots are labeled from left to right, beginning with A. Default is O.  
Set the XR500 Series panel J23 jumper to R and briefly reset the panel using the J16 jumper to activate RS-232 operation.
- 17.6**  232 SETUP: **232 Setup**  
This option displays when Communication Type for PC Log Reports is 232. Enter up to 32 characters.
- 17.7**  ARM/DIS **NO YES** **Arm and Disarm Reports**  
Sends arming, disarming and Late to Close events. Includes the area number, name and action, the user number and name, and the time and date.
- 17.8**  ZONE **NO YES** **Zone Reports**  
Sends changes in the status of active zones. Includes the zone number, name, type, the action (alarm, trouble, bypass, etc.), user number (if applicable), and area name. For a Walk Test, Verify and Fail messages are sent for each zone.
- 17.9**  USR CMDS **NO YES** **User Command Reports**  
Sends user code changes, schedule changes, and door access denied events.

## 17.10 DOOR ACS NO YES **Door Access Reports**

Sends door access activity: door number, user number and name, and time and date.

## 17.11 SUPV MSG NO YES **Supervisory Reports**

Sends system monitor reports, such as AC and battery, and system event reports.

Supervisory Reports also sends the following reports:

- Abort
- System Recently Armed
- \*Late to Close
- Exit Error
- Alarm Bell Silenced
- \* Only sent as a Supervisory Report if **Area Schedules** is not enabled, **Closing Check** is enabled, and an opening/closing schedule has been programmed.
- Ambush
- Unauthorized Entry

**Note:** To send these reports to the PC Log, you must enable SUPV MSG.

## 17.12 PC LOG REAL-TIME STATUS NO YES **PC Log Real-Time Status**

Select YES to send Real-Time Status reports for zones, doors, and outputs. The specific reports must also be selected by individual zone or output. The Real-Time Status messages are sent to a PC running a graphic display software. Default is NO.

The messages that can be sent are:

- Door Open with zone number
- Door Closed with zone number
- Door Open with door number
- Door Closed with door number
- Output On
- Output Off
- Output Pulse
- Output Temporal

## Area Information

### 18.1 AREA INFORMATION **Area Information**

Allows you to assign functions to the different areas in the system. All non-24-hour zones must be assigned to an active area. See Zone Information.

You activate an area by assigning it a name. See Area Name. A name is given to each active area in place of a number to assist the user during arming and disarming.

When only areas one to eight are used, the Armed Status display is 1 2 3 4 5 6 7 8.

When areas nine or higher are used the system Armed Status display reads ALL SYSTEM ON or SYSTEM ON. Press the COMMAND key to display additional areas.

Refer to the Multiple Displays section at the beginning of this document and in the XR500 User's Guide (LT-0683CAN).

### 18.2 EXIT DELAY: 60 **Exit Delay**

Enter the exit delay time for all Exit type zones in this area. When the exit delay time starts, all activity on that zone and other non-24-hour zone types in the area is ignored until the exit delay expires. The keypad displays the Exit Delay time countdown and annunciates the Exit Delay tone at 8 second intervals until the last 10 seconds when annunciation is at 3 second intervals.

The exit delay can be from 30 to 250 seconds. Default is 60 seconds.

During Exit Delay, if an exit zone trips, then restores, and trips again, the Exit Delay timer restarts. This restart can occur only once. The Exit Delay restart is disabled when programmed for High Line Security operation.

**Exit Error Operation:** At arming, when an entry/exit zone (EX) is **faulted** at the end of the exit delay then one of two sequences occur:

For Entry Delay 1 EX type zones:

- the bell sounds for the length of time set in Bell Cutoff programming.
- the Entry Delay operation starts requiring code entry to disarm
- if not disarmed, a zone alarm and an exit error are sent to the receiver.

For Entry Delay 2-4 EX type zones:

- the zone is force armed and a zone force arm message is sent to the receiver
- an Exit Error is sent to the receiver
- the bell sounds for the length of time set in Bell Cutoff programming

### 18.3 BURG BELL OUT: 0 **Burglary Bell Output**

Enter the output number (0 to 6, 500 to 999, G1 to G20, or D1 to D16) that is turned on any time a Burglary type zone is placed in alarm. The output is turned off when you disarm any area and no other Burglary type zones are in alarm. The output can also be turned off using the Alarm Silence option in the User Menu or by entering a user code with the authority to silence alarms. The duration of this bell output follows the time entered in the System Options>Bell Cutoff Time prompt. See the **Output Options - Bell Cutoff Time** section. If Bell Test is selected **YES**, the Burglary Bell Output entered here is turned on for two seconds each time the system is armed.

### 18.4 O/C RPTS NO YES **Opening/Closing Reports**

This option allows an Opening report to be sent to the receiver whenever any area is disarmed. A Closing report is also sent to the receiver when any area is armed.

- 18.5** CLS CHK    **NO**   YES **Closing Check**  
 Select YES to enable the panel to verify that all areas in the system are armed after permanent or extended schedules expire. If the Closing Check finds any areas disarmed past the scheduled time, the keypads selected to display System Trouble Status displays CLOSING TIME! and emits a steady beep. When Area Schedules is set to YES in Area Information, the specific area and name display followed by – LATE. When Auto Arm is NO, if within ten minutes the system is not armed or if the schedule is not extended, a Late to Close report is sent to the SCS-1R Receiver. When Auto Arm is YES, the area arms. See Automatic Arming section.  
 If the area becomes disarmed outside of any schedule, the Closing Check sequence occurs after the Late Arm Delay time. See Late Arm Delay.  
 When Closing Check is NO and Auto Arm is YES, the system immediately arms when the schedule expires. No warning tone occurs.  
 In addition, when Closing Check is NO, the option to extend a schedule does not display when the schedule expires.
- 18.6** CLS CODE   **NO**   YES **Closing Code**  
 When YES is selected, a code number is required for system arming. If NO is selected, a code number is not required for system arming.
- 18.7** ANY BYPS   **NO**   YES **Any Bypass**  
 When YES is selected, zones can be bypassed without a code number during the arming sequence. A code number is always required to use the Bypass Zones option from the menu.
- 18.8** AREA SCH   **NO**   YES **Area Schedules**  
 Select YES to allow each area to set its own shift schedules 1 to 4. Enter NO to provide one set of schedules for this system.  
**Note:** Area Schedules are not designed to operate with All/Perimeter or Home/Sleep/Away systems.
- 18.9** EARLY AMBUSH:   0 **Early Morning Ambush (XR500N/XR500E only)**  
 Enter the number of minutes (1 to 15) before a silent alarm (Early Morning Ambush S33) is sent to the central station using the area 1 account number. Enter 0 (zero) to disable this option.  
 When a user code is entered to disarm area 1 at a keypad or reader with Access Areas assigned to area 1, the same or different user code must be entered within the programmed number of minutes to prevent an ambush message from being sent to the receiver. The second user code also must have authority to disarm area 1.  
 In addition, a zone activation with Alarm Action Message C also cancels the Early Morning Ambush timer and stops an Ambush message from being sent to the receiver. See Report to Transmit section in Zone Information.  
 The keypad does not display any indication that the ambush timer is running. Indications can be provided by assigning an output number to Entry Out and Ambush Out in Output Options. Entry Out turns on one minute before the timer expires and turns off at expiration. Ambush Out turns on at the timers' expiration and turns off when Sensor reset is performed.
- 18.10** AREA NO: - **Area Number**  
 Enter the number of the area to program. After entering the area number, press COMMAND to enter the area name. Only Area systems allow the area name to be changed.  
**Note:** When All/Perimeter or Home/Sleep/Away is selected as the system type, the Area Number does not display.
- 18.10.1** INT                  PERIM **All/Perimeter Programming**  
 When All/Perimeter is selected as the system type, program the Interior and Perimeter areas as needed.

# AREA INFORMATION

18.10.2

INT BDRM PERIM

## Home/Sleep/Away Programming

When Home/Sleep/Away is selected as the system type, program the Interior, Bedroom, and Perimeter areas as needed.

18.11

\* UNUSED \*

## Area Name

The area name can be up to 32 alphanumeric characters. To add an area name to the system, press any Select key and then enter up to 32 characters for the new area name. Press COMMAND to continue. For instructions on entering alphanumeric characters see section 1.7 Entering Alpha Characters. Inactive areas are marked \* UNUSED \*. Only systems programmed for Area arming have the option available to change the area name. To mark an active area unused, press any top row Select key to delete the old name, then press the COMMAND key. The programmer automatically programs the name as \*UNUSED\*. If you have already cleared Area Information during Initialization, all areas are marked \* UNUSED \*. See Initialization section.

Home/Sleep/Away with Guest systems display the area name, but the names cannot be changed. The following are the display names that appear on the keypad:

Area	Display	Area	Display	Area	Display
1	Perimeter	4	Guest1 Perimeter	7	Guest2 Perimeter
2	Interior	5	Guest1 Interior	8	Guest2 Interior
3	Bedrooms	6	Guest1 Bedrooms	9	Guest2 Bedrooms

18.12

ACCOUNT NO: 12345

## Account Number

Enter the account number to be sent to the receiver for this area. Choose an account number compatible with the Communication Type selected in Communications. The default Account Number is the one previously entered in Communications. This account number is used when sending area messages and events to the central station. See the Area Account Number Messages in the Appendix.

18.13

AUTO ARM NO YES

## Automatic Arming

Select YES to allow this area to arm automatically according to permanent, temporary, or extended schedules. If no schedules are programmed, the area auto arms every hour. If closing check is selected as YES, the automatic arming function does not take place until the expiration of a ten minute Closing Check delay. See Closing Check. If the area has been disarmed outside of any permanent or temporary schedule, the closing check sequence occurs one hour after the area is disarmed.

At arming, bad zones are handled according to the option selected in section Bad Zones. If a closing report is sent, the user number is indicated as SCH on the SCS-1R Receiver. NO disables automatic arming for this area.

18.14

BAD ZONES: BYP

## Bad Zones

At the time of automatic arming, some zones in the area may not be in a normal condition. This option allows you to program the panel response to these bad zones. This option does not display if AUTO ARM is NO.

BYP FORC REF

**BYP** - All bad zones are bypassed. A report of the bypass is sent to the receiver if Bypass Reports is YES. The report indicates SCH as the user number.

**FORC** - All bad zones are force armed. Zones force armed in a bad condition are capable of restoring and reporting an alarm if tripped. A forced zone report is transmitted if Bypass Reports is YES. The report indicates SCH as the user number.

**REF** - The automatic arming is refused and no arming takes place. A No Closing report is sent to the receiver regardless of the Closing Check selection.

18.15

AUTO DIS NO YES

## Automatic Disarming

NO disables automatic disarming by schedule for this area. When YES is selected, the area automatically disarms according to permanent or temporary schedules. If an opening report is sent to the receiver, the user number is indicated as SCH.



- 18.16** ARMED OUTPUT: 0 **Armed Output Number**  
 Enter the output to turn on when this area is armed. If an exit delay is used for this area, the Armed Output turns on at the start of the exit delay. The output is turned off when this area is disarmed. The output cannot be turned on from the User Menu Outputs On/Off option.
- 18.17** LATE OUTPUT: 0 **Late Output Number**  
 Enter the output to turn on when this area is not armed by its scheduled time and Area Late or Closing Time displays at a keypad and the keypad buzzer is on. The output is turned off when the keypad buzzer is silenced by pressing any key. Default is 0 (zero).
- 18.18** LATE/ARM DLY: 60 **Late Arm Delay**  
 Enter 4 to 250 minutes to delay before automatic re-arming occurs after the area becomes disarmed outside of schedules. See Closing Check. Default is 60 minutes.  
**Note:** The Late Arm Delay can be superseded by the Re Arm Delay setting of the User Profile assigned to the user who disarmed the area. Refer to the Re Arm Delay section in the XR500 Series Canadian User's Guide (LT-0683CAN).
- 18.19** BANK/SAF NO YES **Bank Safe & Vault (XR500N/XR500E only)**  
**NO** disables the Bank Safe & Vault feature for this area. When selected as **YES**, schedules set for this area and the time of day cannot be changed while the area is armed.  
*Program schedules before arming:* A Bank Safe & Vault area can only be disarmed during scheduled times. If the area becomes armed before programming a schedule, the panel must be reset before the area can be disarmed from a keypad or the **Bank Safe & Vault** option in **Area Information** must be set to **NO**.  
 Zones assigned to Bank Safe & Vault areas cannot be bypassed or force armed. Do not assign Bank Safe & Vault area to an Arming zone. Arming zones can disarm Bank Safe & Vault areas outside of a schedule.
- 18.20** COMMON NO YES **Common Area**  
 Select **YES** to enable this area to operate as a common area. This area is armed when the last area in the system is armed and is disarmed when the first area in the system is disarmed. You can have multiple common areas in each system. For the common area to work properly, do not assign the common area to any user code. When a user code can arm and disarm the common area from a keypad at any time, the common area does not function as a common area.
- 18.21** ARM FIRST NO YES **Arm First Area**  
 Select **YES** to enable this area to operate as an Arm First area. This area is automatically armed when any non-Arm First area assigned to the same keypad is armed but does not disarm when other areas become disarmed. Assign areas to keypads using the Display Areas option in Device Setup programming. You can have multiple Arm First areas in a system and divide them among keypads if needed. If an Arm First area has faulted zones that cannot be bypassed, arming stops and the areas are not armed. Correct the problem with the Arm First area and then begin the arming process again. Default value is **NO**.  
**Note:** The Arm First automatic arming only occurs when arming from a keypad. Arming from a zone, schedule, or remotely is not affected and Arm First areas do not automatically arm.
- 18.22** TWO MAN NO YES **Two Man Rule (XR500N/XR500E only)**  
 Select **YES** to require two user code entries to disarm and/or allow door access to this area. When a user presents a code to a keypad or reader requesting a door access or disarm, 2ND CODE displays and requires the entry of a different user code with at least the same authority. The second user code must be entered within 30 seconds.  
**NO** disables the Two Man Rule for this area.

# ZONE INFORMATION

## Zone Information

### 19.1 ZONE INFORMATION Zone Information

Zone Information allows you to define the operation of each protection zone used in the system. All protection zones, whether located on a command processor panel, Security Command keypad, or zone expander are programmed the same way.

### 19.2 ZONE NO: - Zone Number

Enter the number of the zone you intend to program. Available zone numbers are shown in the table below. The keypad zone numbers begin with the keypad address and are followed by the particular zone from that keypad. For example, a 7073 at keypad address 7 would provide zones 71, 72, 73, and 74. Press COMMAND to enter a zone name.

Address	Programming Zone Number
Panel	1-10
1	11-14
2	21-24
3	31-34
4	41-44
5	51-54
6	61-64
7	71-74
8	81-84
9	91-94
10	101-104
11	111-114
12	121-124
13	131-134
14	141-144
15	151-154
16	161-164
1100 Series Key Fob	400-449
LX-Bus 1 (A)	500-599
LX-Bus 2 (B)	600-699
LX-Bus 3 (C)	700-799
LX-Bus 4 (D)	800-899
LX-Bus 5 (E)	900-999

**Note:** For 1100 Series Key Fob zones (400-449), programming continues at the 1100 Series Key Fobs Section.

### 19.3 \* UNUSED \* Zone Name

Zone names can have up to 32 alphanumeric characters. A name must be given to each zone in the system. The name can display at the keypads during arming and disarming so the user does not have to memorize zone numbers. Users can associate a zone name with a particular protection point. A zone that is not part of the system must be marked unused.

To add a zone name to the system, press any Select key and then enter up to 32 characters for the new zone name. Press COMMAND to continue.

To mark a zone unused, delete the old name by pressing a top row Select key, then press the COMMAND key. The programmer automatically programs the name as \* UNUSED \*. If you have already cleared Zone Information during Initialization, the zones is marked \* UNUSED \*.

## 19.4

**ZONE TYPE:** BLANK

### Zone Type

The Zone Type defines the panel response to the zone being opened or shorted. This is called the Alarm Action. There are up to 13 possible alarm action responses depending on the zone type and any restrictions it may have. See the Zone Type chart in the Appendix.

When you assign a Zone Type to a zone, automatic zone responses are made. There are 12 Zone Types to choose from. Application descriptions for each zone type can be found in the Appendix of this manual.

To enter a new Zone Type, press any Select key. The display lists all of the available Zone Types four at a time.

-- NT DY EX

Blank, Night, Day, or Exit. Press COMMAND for additional zone types.

FI PN EM SV

Fire, Panic, Emergency, or Supervisory. Press COMMAND for additional zone types.

A1 A2 FV AR

Auxiliary 1, Auxiliary 2, Fire Verify, or Arming (keyswitch). Press COMMAND for additional zone types.

If you select Blank, Night, Day, Exit, Auxiliary 1, Auxiliary 2, or Arming as the Zone Type, the zone must be assigned to an active area. If you select Fire, Fire Verify, Panic, Emergency, or Supervisory as the Zone Type, it is a 24-hour zone that is always armed and no area assignment is needed.

#### Zone Type Specifications

The panel contains 12 default zone types for use in configuring the system. These zone types provide the most commonly selected functions for their applications. All zone types except the Arming zone type can be customized by changing the options listed below. Arming zone type programming continues at Arming Zone Area Assignment.

Refer to the Appendix for complete zone type descriptions.

## 19.5

AREA NO: -

### Area Assignment

Enter the area number where the Night, Day, Exit, Auxiliary 1, or Auxiliary 2 zone is being assigned. For an Area system, area numbers 1-32 can be assigned. For a Home/Sleep/Away with Guest system, area numbers 1-9 can be assigned.

AREA: PERIMETER

In an All/Perimeter or Home/Sleep/Away system, the currently selected area, Perimeter, Interior, Bedroom displays.

INT PERIM

On an All/Perimeter system, select INT to program zones for the interior area and select PERIM to program zones for the perimeter area.

INT BDRM PERIM

On a Home/Sleep/Away system, select INT to program zones for the interior area, select BDRM to program zones for the bedroom area, and select PERIM to program zones for the perimeter area.

## 19.6

FIRE BELL OUT: 0

### Fire Bell Output

This output (1 to 6, 500 to 999, G1 to G20, or D1 to D16) is turned on any time a Fire, Fire Verify, or Supervisory zone is placed in alarm. The output is turned off by any the following actions:

- When the User Menu Alarm Silence function is performed.
- When a valid user code is entered to silence the bell.
- When the Silence key is pressed on the 630F Remote Fire Command Center.
- Using the Outputs On/Off function in the User Menu.
- The expiration of the Bell Cutoff time.

This output can be connected to a lamp, LED, or buzzer using the DMP Model 716 Output Expansion Module.

## 19.7

ARM/DIS AREAS

### Arming Zone Area Assignment

In an Area or Home/Sleep/Away with Guest system, if the zone has been programmed as an Arming Type (AR), enter the areas that the zone controls.

When the zone changes from normal to shorted, the programmed areas toggle between the armed or disarmed condition using the Style programming below. When restored to normal, no action occurs. When the zone is opened from a normal (disarmed) state, a trouble is reported. When opened from a shorted (armed) state, an alarm is reported and the zone is disabled until you disarm the area(s) from either a keypad or Remote Link™ computer.

To visually indicate the armed state of the area(s), you can assign an Armed Output to individual areas and use remote LEDs at the keyswitch. The LED turns on or off to indicate to the user the armed state of the area(s).

ARM AREAS: PERIM

In an All/Perimeter or Home/Sleep/Away system, this option specifies the areas to be armed by the Arming Type zone. For All/Perimeter systems, choose PERIM or ALL, for Home/Sleep/Away or Home/Away systems, choose HOME, SLEEP, or AWAY.

PERIM ALL

Perimeter/All - Specify whether the arming zone arms just the Perimeter (PERIM) or the Perimeter and Interior areas (ALL) for All/Perimeter systems. When disarming, all areas are disarmed.

HOME SLEEP AWAY

Home/Sleep/Away - Specify whether the arming zone arms the Perimeter (HOME), the Perimeter and Interior (SLEEP), or all three areas (AWAY). When disarming, all areas are disarmed.

### Arming Zone Operation

If any bad zones are present when the Arming zone is shorted, the LED delays lighting for 5 seconds. If during the 5-second delay the Arming zone is shorted again no arming takes place. If 5 seconds expire without the zone shorting again or restoring to normal, the areas arm and bad zones are force armed. To allow bad zones to be force armed, the Any Bypass option must be set to YES. If Any Bypass option is set to NO, arming does not occur. See the Area Information - Any Bypass section. A priority zone cannot be force armed.

## 19.8

STYLE:

### Style

This option specifies the style for the arming/disarming operation. The default style is TGL (toggle). Press any Select key to display the STYLE options. To view more style options press the COMMAND key.

TGL ARM DIS STEP

**TGL (Toggle)** - When the zone changes from normal to shorted, the programmed areas toggle between the armed or disarmed condition. When restored to normal, no action occurs. When the zone opens from a normal (disarmed) state, a trouble is reported. When opened from a shorted (armed) state, an alarm is reported and the zone is disabled until you disarm the area(s) from either a keypad or Remote Link.

**ARM** - When the zone is shorted, the programmed areas are armed. When restored to normal, no action occurs. When the zone is opened from a normal (disarmed) state, a trouble is reported. When opened from a shorted (armed) state, an alarm is reported.

**DIS (Disarm)** - When programmed, a short disarms the programmed areas. When restored to normal, no action occurs. When the zone is opened from a normal (disarmed) state, a trouble is reported.

**STEP** - A short arms the areas and beeps the keypads once. A normal condition causes no action. An open condition disarms the programmed areas and beep the keypads for one second.

**Note:** This arming style is designed for wireless arming pendants. When using an arming/disarming keyswitch locate the keyswitch within the protected area.

MNT

**MNT (Maintain)** - When the zone is shorted, the programmed areas are armed. When restored to normal, the programmed areas are disarmed and any alarm bells are silenced. When the zone is opened from a normal (disarmed) state, a trouble is reported. If opened from a shorted (armed) state, an alarm is reported and the zone is disabled until you disarm the area(s) from either a keypad or Remote Link.

## 19.9 NEXT ZN? NO YES **Next Zone**

Select YES to terminate zone programming. The display returns to Zone Number, allowing you to enter a new zone number. Select NO to make alterations to the Alarm Action for a zone. Alarm Action is defined beginning with section 16.12.

To program zones for wireless operation, select NO at the NEXT ZONE - NO YES option. The WIRELESS NO YES option displays. If the zone you are programming is intended for wireless devices, select YES. Select NO to continue programming non-wireless zones in the 500 to 999 range.

- Zones 400 to 449 can be programmed for 1100 Series Key Fobs.
- Zones 500 to 699 can be programmed for FA Series Wireless.
- Zones 500 through 999 can be programmed for DMP 1100 Series Wireless.

## DMP Wireless

For a DMP 1100X Wireless Receiver set the House Code from 1 to 50. See House Code programming in System Options. Zones 500 through 999 can be programmed as Wireless zones. Set the XR500 Series Canadian panel J23 jumper to X to enable on-board DMP Wireless operation. Briefly reset the panel using the J16 jumper to activate Wireless operation. Refer to the XR500 Series Canadian Installation Guide (LT-0681).

For an 1100 Series Key Fob see section 19.11.

For an FA Series Remote Wireless Receiver see section 19.12.

**NOTE:** All wireless programming is stored in the XR500 Series Canadian panel. The 1100X Wireless Receiver obtains the necessary programming information from the panel each time the receiver powers up, when the programmer STOP routine is selected or the panel is reset. The receiver memory refresh takes up to 10 seconds to complete depending on the number of wireless zones programmed and the Red LED remains on during this time. Normal receiver operation is inhibited during the memory refresh period.

## 19.10 ZONE INFORMATION WIRELESS? NO YES **Wireless**

Select YES to program this zone as a DMP wireless zone. You must program the wireless House Code prior to adding DMP wireless zones to the system. See House Code programming in System Options. Default is NO.

### 19.10.1 TRANSMITTER SERIAL#: XXXXXXXX **Serial Number Entry**

Enter the eight-digit serial number found on the wireless device.

ALREADY IN USE  
ZONE NUMBER: XXX

This message displays when the serial number is already programmed for another zone. The programmed zone number displays.

### 19.10.2 TRANSMITTER CONTACT:XXXXXXXX **Contact**

This option displays if the serial number entered is for an 1101 or 1103 Universal Transmitter or 1114 Wireless Four-Zone Expander. Press any top row key to select the contact.

TRANSMTR CONTACT  
INT EXT

This option displays when programming an 1101 or 1103 Transmitter. Select INT to use the internal reed switch contacts. Select EXT to connect an external device to the 1101 or 1103 terminal block. Default is INTERNAL.

By allowing both of the Model 1101 or 1103 transmitter contacts (INT and EXT) to be used at the same time, two zones may be programmed from one transmitter. When using both contacts, you must use consecutive zone numbers. Zones 531 and 532 or zones 890 and 891 are acceptable zone assignments.

For example, program transmitter serial number 01345678 as Zone 521 with an INT contact type and Zone 522 with an EXT contact type. The same serial number is used for both zones.

# ZONE INFORMATION

TRANSMTR CONTACT  
1 2 3 4

This option displays when programming the 1114 Wireless Four-Zone Expander with four input contacts. The same serial number is used for all four contacts. Select the contact number to program. When using the contacts, you must use consecutive zone numbers. Default is Contact 1.

For example, use serial number 08345678 to program Contact 1 for Zone 561, Contact 2 for Zone 562, Contact 3 for zone 563, and Contact 4 for zone 564. A tamper on the 1114 is transmitted as the zone number assigned to Contact 1.

ALREADY IN USE  
ZONE NUMBER: XXX

This message displays when the Contact is already programmed for another zone. The programmed zone number displays.

ZONE INFORMATION  
NORM OPN NO YES

This option only displays when EXT is selected as the Contact type. For external devices connected to the 1101 or 1103 terminal block, select NO to use normally closed (N/C) contacts. Select YES to use normally open (N/O) contacts. Default is NO.

## 19.10.3

TRANSMITTER  
SUPRVSN TIME: 240

### Supervision Time

Press any top row key to select the supervision time required for the wireless zone. Press COMMAND to accept the default time. Default is 240 minutes.

**Note:** Refer to the Wireless Check-in and Supervision Time Definitions section of the Appendix for supervision information.

SELECT MINUTES:  
0 3 60 240

Press the Select key under the required number of minutes. The transmitter must check in at least once during this time or a missing condition is indicated for that zone. 1100 Series transmitters automatically checkin based on the supervision time selected for the wireless zone, no additional programming is needed. If two zones share the same transmitter, the last programmed supervision time is stored as the supervision time for both zones. Zero (0) indicates an unsupervised transmitter.

**Note:** When the panel is reset or a receiver is installed or powered down and powered up, the supervision timer restarts for all wireless zones.

## 19.10.4

LED OPERATION  
NO YES

### LED Operation

Select YES to turn on an 1142 Hold-up transmitter LED during Panic or Emergency operation. Select NO to turn the LED off during Panic or Emergency operation. The LED always operates when the transmitter case is open and the tamper is faulted. Default is YES.

## 19.10.5

DISARM DISABLE  
NO YES

### Disarm/Disable

Select YES to disable the zone tripped message (short) to the 1100X Series Receiver from the 1126 PIR transmitter during the disarmed period. When disabled, the 1126 only sends supervision, tamper and low battery messages during the disarmed period to extend transmitter battery life. Select NO to always send zone tripped messages in addition to supervision, tamper and low battery. Default is YES.

## 19.10.6

WIRELESS PIR  
PULSE COUNT: 4

### PIR Pulse Count

Select the number of infrared pulses (2 or 4) the 1126 PIR should sense before sending a short message to the 1100X Series Receiver. Default is 4.

## 19.10.7

WIRELESS PIR  
SENSITIVITY:LOW

### PIR Sensitivity

Select the sensitivity setting for the 1126 PIR. Selecting LOW sets the 1126 to operate at 75% sensitivity for installations in harsh environments. Selecting HIGH sets the PIR to maximum sensitivity. Default is LOW.

## 19.10.8

NEXT ZONE NO YES

### Next Zone

Select YES to return to the ZONE NO: - prompt to program a new zone. Select NO to display the Alarm Action option.



## 1100 Series Key Fobs

For an 1100 Series Key Fob set the House Code from 1 to 50. See House Code programming in System Options. Only zones 400 to 449 can be programmed as 1100 Series Key Fob zones. Refer to the 1100 Series Key Fob Programming Sheet (LT-0706) supplied with the 1100X Wireless Receiver and the 1100 Series Key Fob Install Guide (LT-0703) as needed.

To operate arming and disarming properly, the Key Fob should be assigned to a User Number with appropriate area assignments, however, the User Number does not have to exist at the time the Key Fob is programmed. The Key Fob User Number can be added later by the User.

The following programming continues from the Zone Number section when zone 400-449 is selected.

### 19.11.1

KEY FOB USER NUMBER: XXXX
------------------------------

#### Key Fob User Number

Enter the User Number (1-9999) used to identify the key fob user and their arming and disarming authority. Default is blank.

USER XXXX NOT IN USE
-------------------------

Displays when the User Number entered does not exist in User Code programming. The key fob can be added, but the user must eventually be added to cause the key fob to operate.

### 19.11.2

TRANSMITTER SERIAL#: XXXXXXXX
----------------------------------

#### Key Fob Serial Number

Enter the eight-digit serial number found on the wireless device.

### 19.11.3

TRANSMITTER SUPRVSN TIME: 0
--------------------------------

#### Key Fob Supervision Time

Press any top row key to select the supervision time required for the key fob zone. Press COMMAND to accept the default time. Default is 0 for key fobs.

SELECT MINUTES: 0 3 60 240
-------------------------------

Press the Select key under the required number of minutes. The key fob must check in at least once during this time or a missing condition is indicated for that zone. 1100 Series key fobs automatically checkin based on the supervision time selected for the wireless zone, no additional programming is needed. Zero (0) indicates an unsupervised transmitter.

**Note:** When the panel is reset or a receiver is installed or powered down and powered up, the supervision timer restarts for all wireless zones.

### 19.11.4

NO. OF KEY FOB BUTTONS: X
------------------------------

#### Number of Key Fob Buttons

Enter the number of buttons (1, 2, or 4) on the key fob being programmed.

**Note:** If the key fob is a one-button model, programming continues at the Button Action section. Default button assignment for one-button key fobs is a Panic Alarm (PN) with no output assigned.

### 19.11.5

BUTTON: TOP BTM LFT RGT
----------------------------

#### Key Fob Button Selection (Four Buttons)

This prompt only displays if the key fob being programmed is a four-button model. Press the Select key under the key fob button to program. The following list identifies the default button assignments:

- TOP Arming with no areas assigned
- BTM Disarming with no areas assigned
- LFT Panic Alarm (PN) with no output assigned
- RGT Arming with Area 1 assigned

### 19.11.6

BUTTON: TOP BTM
--------------------

#### Key Fob Button Selection (Two Buttons)

This prompt only displays if the key fob being programmed is a two-button model. Press the Select key under the key fob button to program. The following list identifies the default button assignments:

- TOP Arming with no areas assigned
- BTM Disarming with no areas assigned

# ZONE INFORMATION

## 19.11.7

BUTTON ACTION  
yyy: XXXXXXXX

### Button Action

This option specifies the Button Action for an individual key fob button. The default action for the button selected is displayed. Press any Select key to display the Button Action options. To view more options press COMMAND. yyy = the name of the button being programmed (TOP, BTM, LFT, RGT).

BUTTON ACTION  
ARM DIS TGL STA

**ARM (Arm)** - Arms selected areas and force arms bad zones.

**DIS (Disarm)** - Disarms selected areas.

**TGL (Toggle Arm)** - Toggles arm/disarm for selected areas and force arms bad zones when arming.

**STA (Status)** - Causes the key fob LED to indicate the arm/disarm status of the system.

BUTTON ACTION  
PN PN2 EM EM2

**PN (Panic)** - Triggers a Panic zone type alarm with no restoral.

**PN2 (Panic 2)** - Triggers a Panic zone type alarm with no restoral when pressed simultaneously with any other Panic 2 button. No action occurs when pressed alone.

**EM (Emerg)** - Triggers an Emergency zone type alarm with no restoral.

**EM2 (Emerg 2)** - Triggers an Emergency zone type alarm with no restoral when pressed simultaneously with any other Emergency 2 button. No action occurs when pressed alone.

BUTTON ACTION  
OUT RST UN

**OUT (Output)** - Causes an output to turn on steady, pulse, momentary, toggle or off.

**RST (Sensor Reset)** - Causes the panel to perform a standard Sensor Reset.

**UN (Unused)** - The button is not used and performs no action.

## 19.11.8

BUTTON  
PRESS TIME: XXXXX

### Button Press Time

This option specifies the amount of time (SHORT or LONG) the user must press the button before the key fob sends a message to the wireless receiver. The default press time displays. Press any Select key to set the Button Press Time for Arm, Disarm, Toggle, Status, Output, and Sensor Reset.

**Note:** The Button Press Time is not programmable on Panic (PN or PN2), Emergency (EM or EM2) or Unused (UN) zones. For those zones the button press time is always two (2) seconds.

PRESS TIME:  
SHORT LONG

**SHORT** - Press the button for one-half (1/2) second to send the message to the wireless receiver.

**LONG** - Press the button for two (2) seconds to send the message to the wireless receiver.

## 19.11.9

ARM/DIS AREAS:

### Arm/Disarm Area Selection

In an Area system or Home/Sleep/Away with Guest system, this specifies the areas to be armed/disarmed by the Key Fob button being programmed. To select an area between 1 and 32, enter the area number using the keypad digit keys. Default is no areas enabled.

In order to arm or disarm selected areas, the Profile assigned to the User Number needs to have the same area numbers selected. Any area may be selected at Arm/Disarm Areas but only matching area numbers are armed or disarmed when the specific button is pressed. For example, in Areas selection, areas 1, 3, and 7 are selected. In the User Profile Arm and Disarm Areas, areas 1, 2, 4, and 7 are selected. When the user presses the button to Arm or Disarm area(s), only matching areas 1 and 7 Arm/Disarm.

**Note:** When more areas are selected at Arm/Disarm Areas than are authorized in the User Profile, in the future the user can be given access authority to additional areas through the User Profile without requiring additional panel programming to select Arm/Disarm Areas. See User Profiles in the Appendix or refer to the XR500 Series Canadian User's Guide (LT-0683CAN).

ARM AREAS: PERIM

In an All/Perimeter or Home/Sleep/Away system, this specifies the area to be armed by the Key Fob button being programmed. For All/Perimeter systems, choose PERIM or ALL, for Home/Sleep/Away or Home/Away systems, choose HOME, SLEEP, or AWAY.

**Note:** Areas 3 and higher in an All/Perimeter system, and areas 4 and higher in a Home/Sleep/Away system are not available for use.

After selecting the areas, for one-button key fobs the Zone No.: prompt displays. For two-button or four-button key fobs, the Key Fob Button Selection option displays to program additional buttons.

## 19.11.10 OUTPUT NO: XXX

### Output Number

You can specify a relay output to operate when OUT (Output), PN (Panic), PN2 (Panic 2), EM (Emergency), or EM2 (Emergency 2) is selected for a key fob Button Action and the button is pressed. Valid range is 1 to 6, 500 to 999, D1 to D16, or G1 to G20. For an output turned on by a PN, PN2, EM, or EM2 button action, the output turns off when any area is disarmed.

To enter an output number, press a top row Select key followed by the output number. Press the COMMAND key.

## 19.11.11 OUTPUT ACTION: yyy: XXXXXXXX

### Output Action

This option allows you to define the output action (STD, PLS, MOM, TGL, OFF) for the selected output number. The default is Steady.

yyy = the name of the button being programmed (TOP, BTM, LFT, RGT).  
xxxxxxx = the currently defined output action.

OUTPUT ACTION?  
STD PLS MOM TGL

**STD (Steady)** - The output is turned on and remains on.

**PLS (Pulse)** - The output alternates one second on and one second off. The pulsing rate for a Model 716 relay attached to the LX-Bus is 1.6 seconds.

**Note:** Pulse is not available for key fob button output programmed D1 to D16 or G1 to G20.

**MOM (Momentary)** - The output is turned on only once for one second.

**TGL (Toggle)** - The output alternates between the on state and off state. Each button press toggles the output state.

**Note:** Toggle is not available for key fob button output programmed G1 to G20.

OUTPUT ACTION?  
OFF

**OFF (Off)** - The output is turned off. If programmed, the output was turned on by some other means such as another button press, a zone action, or a schedule.

**Note:** When the output is assigned to PN/PN2 or EM/EM2 button action and is turned on, the output turns off when any area is disarmed.

When the output action is steady, pulse or toggle and the output is turned on, the output remains on until:

- the output cutoff time expires
- the output is reset from the keypad menu
- toggled off

## 19.11.12 NEXT ZONE NO YES

### Next Zone

Select YES to return to the ZONE NO: - prompt to program a new zone. Select NO to display the Alarm Action option.

**Note:** All wireless programming is stored in the XR500 Series Canadian panel. The 1100X Wireless Receiver obtains the necessary programming information from the panel each time the receiver powers up, when the programmer STOP routine is selected or the panel is reset. The receiver memory refresh takes up to 10 seconds to complete depending on the number of wireless zones programmed and the Red LED remains on during this time. Normal receiver operation is inhibited during the memory refresh period.

# ZONE INFORMATION

## FA Series Wireless

For an FA Series Remote Wireless Receiver set the House Code to 99. See House Code programming in System Options. Only zones 500 to 699 can be programmed as FA Series Wireless zones for maximum of 200 Wireless Zones.

For a DMP 1100X Wireless Receiver see section 16.10.

### 19.12 ZONE INFORMATION WIRELESS? NO YES **Wireless**

Select YES to program a wireless zone connected to an FA Series FA400-DMP Remote Wireless Receiver. Press the COMMAND key to continue with wireless programming.

#### 19.12.1 CHECK IN TM: 60 **Check-in Time**

You can set wireless transmitters to check in automatically every 10, 30, or 60 seconds or not at all. To change the 60 second default, press any top row Select key to display NONE 10 30 60. Select the check-in time you want for this zone.

**Note:** Refer to the Wireless Check-in and Supervision Time Definitions section of the Appendix for supervision information.

#### 19.12.2 INT CONT NO YES **Internal Contact**

Select YES to use an internal contact on the wireless transmitter. Select NO to use an external contact. When you select NO, the following two prompts display.

#### 19.12.3 EOL NO YES **End-of-Line**

Select YES to supervise an external contact connected to the wireless transmitter. At the contact, install a 2.2k Ohm End-of-Line resistor in parallel for Normally Open contacts and in series for Normally Closed contacts.

#### 19.12.4 NRM OPEN NO YES **Normally Open**

Select NO if the contact connected to the wireless transmitter is Normally Closed.

#### 19.12.5 NEXT ZONE NO YES **Next Zone**

Select YES to return to the ZONE NO: - prompt to program a new zone. Select NO to display the Alarm Action option.

### 19.13 ALARM ACTION . . . **Alarm Action**

This option allows you to change any Zone Type standard definitions. When the Zone Type is specified, the Alarm Action for that zone is stored in memory.

If the Zone Type is Blank, Night, Day, Exit, Auxiliary 1, or Auxiliary 2 it is a non-24-hour zone and the Alarm Action programming begins with Disarmed Open.

If the Zone Type is Fire, Panic, Emergency, or Supervisory it is a 24-hour zone that is always armed and the Alarm Action programming begins with Armed Open.

The Fire Verify Zone Type functions the same as Fire Type, with the following exceptions: When a Fire Verify zone initiates an alarm, the panel performs a Sensor Reset. If any Fire Verify zone initiates an alarm within 120 seconds after the reset, an alarm is indicated. If an alarm is initiated after 120 seconds, the cycle is repeated and a zone fault report is sent to the receiver.

Do NOT program Fire Verify Zone Types for Zone Retard.

### 19.14 DISARMED OPEN **Disarmed Open**

Defines the action taken by the panel when the zone is opened while the area is disarmed. There are three actions to define: Report to transmit, Relay Output to activate, and Relay Output action.

You must also make these selections for the Disarmed Short, Armed Open, and Armed Short zone conditions. Press COMMAND to continue.

## 19.15 MSG: TROUBLE Report to Transmit

Press any Select key to display the following report options: A, T, L, S, C, and - (dash).

A T L -

**ALARM** - Select A to send an alarm report to the receiver and activate the bell output according to zone type. The zone name appears in the panel alarmed zones and status lists.

**TROUBLE** - Select T to send a trouble report to the receiver. The zone name appears in the panel alarmed zones and status lists.

**LOCAL** - When you select L, an alarm report is NOT sent to the receiver. The bell output activates and the zone name appears in the panel alarmed zones and status lists.

**- (Dash)** - When you select a - (dash), reports are NOT sent to the receiver. The bell output does not activate and there is no display in the panel alarmed zones or status list. Only the relay output selected in the next section operates.

D S C

**DOOR PROPPED** - Selecting **D** allows the following operation: The time programmed into ENTRY DLY 4 in the **System Option** section begins to count without displaying on keypad. If the time expires and the zone has not returned to normal, the keypad trouble buzzer starts and CLOSE THE DOOR appears on the keypads programmed into the PREWARN ADDRESS section. The time programmed into ENTRY DLY 4 begins to count down again internally. If the time expires a second time and the zone has not returned to normal, a fault report is sent to the receiver and the zone name - OPEN message displays on the keypads until a code is entered. The bell output does not activate for the Door Propped operation.

**SILENCE/RESET** - Select S when the zone (not FI, SV, or FV) is connected to a DMP Model 303 Silence/Reset switch, the zone can be used to silence the alarm bell and perform a sensor reset without using a keypad. A report is NOT sent to the receiver except for the bell silence report.

**CANCEL AMBUSH** - Select C for the zone to cancel the Early Morning Ambush timer and stop an Ambush message from being sent to the receiver. Faulting the zone takes the place of a second user code being entered at the keypad and is only available for non-fire type zones. Area assignment for the zone does not affect this option. See Early Morning Ambush in Area Information programming.

## 19.16 OUTPUT NO: 0 Output Number

You can specify any of the Relay Outputs on the XR500 Series panel to be activated by a zone condition (1 to 6, 500 to 999 if Model 716 used, D1 to D16, G1 to G20). The output can be activated regardless of the report to transmit or whether or not the zone is programmed as local. An output activated by an armed zone is turned off when the zone area is disarmed by a user.

To enter an output number, press a top row Select key followed by the output number. Press the COMMAND key.

## 19.17 OUTPUT: NONE Output Action

Entering an Output Number displays this prompt. This prompt allows you to assign an output action to the relay: Steady, Pulse, Momentary, or Follow.

**Note:** Some wireless devices whether powered using an AC adaptor or a battery, ignore some output action programming.

STD PLS MOM FOLW

**STEADY** - The output is turned on and remains on until the area is disarmed, an output cutoff time expires, or the output is reset from the keypad menu.

**PULSE** - The output alternates one second on and one second off.

**Note:** The pulsing rate for a Model 716 relay attached to the LX-Bus is 1.6 seconds.

**MOMENTARY** - The output is turned on only once for one second.

**FOLLOW** - The output is turned on and remains on while the zone is in an off normal, or bad condition. When the zone restores, the output is turned off.

After you make the three selections in the sections above, the display prompts you for the same three selections for Disarmed Short, Armed Open, and Armed Short conditions. If the zone is a 24-hour type, only the Armed Open and Armed Short conditions display. When you have programmed all of the zone conditions, the Swinger Bypass selection then displays.



# ZONE INFORMATION

- 19.18**  SWGR BYP  NO  YES **Swinger Bypass**  
Selecting YES allows the zone to be swinger bypassed by the panel according to the specifications programmed in Swinger Bypass Trips and Reset Swinger Bypass. The Bypass condition displays in the keypad Status List. Selecting NO disables swinger bypassing for this zone.  
**How it works**  
If within one hour, a zone trips the total number of times as specified in Swinger Bypass Trips, the panel bypasses it until the following conditions occur; the area in which the zone is assigned is disarmed, the zone is manually reset through the Bypass Zones? keypad User Menu function, the zone remains normal for one hour and the Reset Swinger Bypass is YES.  
If the zone trips fewer than the specified times within one hour, the bypass trip counter returns to 0 (zero) and the process must be repeated.  
A report of the swinger bypass is sent to the receiver if Bypass Reports is YES.
- 19.19**  PREWARN KEYPADS: **Prewarn Keypad Addresses**  
At the entry delay start, all keypad addresses selected here display ENTER CODE:-. If you want the prewarn to sound at all 16 addresses, leave the default setting. To delete an address, press the matching number on the keypad. To disable prewarning at all keypads, press a top row Select key to clear the addresses shown. Press the COMMAND key when the address selection is complete.  
The prewarn tone stops at the keypad where the first user code digit is entered. If no keys are pressed for five seconds or an invalid user code is entered, the prewarn tone resumes at that keypad.
- 19.20**  ENTRY DELAY:  **Entry Delay**  
Select the entry timer for this zone. Entry timers 1 to 4 are programmed in System Options.
- 19.21**  RETARD  NO  YES **Zone Retard Delay**  
When you select YES, the zone operates with the zone retard delay. The retard functions only in zone short conditions.  
The zone must remain shorted for the full length of the retard delay before the panel recognizes its condition. If you select NO, the zone operates without a retard delay.
- 19.22**  PRESIGNL KEYPADS: **Presignal Keypad Addresses**  
You can enable any combination of keypad addresses to sound a presignal tone during the time a zone is in retard delay. The presignal tone silences when the zone restores or the retard delay expires.  
To enable a presignal address, press any top row Select key followed by the number of the keypad address. You can enable the presignal for all 16 keypad addresses. To disable a presignal address press the matching number digit again. Press the COMMAND key when the address selection is complete. The Presignal prompt is only displayed when Retard is selected as YES.
- 19.23**  FAST RSP  NO  YES **Fast Response**  
Select YES to provide a zone response time of 167ms. Select NO to provide a normal zone response time of 500ms. Zones 500 to 999 have a fixed response time and do not display this prompt.
- 19.24**  CRS ZONE  NO  YES **Cross Zone**  
Select YES to enable cross zoning for this zone. Cross zoning requires one or more armed zones to fault within a programmed time before an alarm report is sent to the receiver. When the first cross zoned zone trips, the cross zone time specified in System Options begins to count down. When a second cross zoned zone trips or the first zone trips a second time before the end of the count down, the bell action assigned to the zone activates and the panel sends an alarm report for both zones.  
If no other cross zoned zone trips before the cross zone time expires, the panel sends only a zone fault report to the receiver.  
Cross zoning is not compatible with all zone types: You can not enable cross zoning for Fire verify zones or for any Fire zones that have Retard Delay enabled.



- 19.25** PRIORITY **NO** YES **Priority**  
 Select YES to provide additional protection for the premises by requiring this zone to be in a normal condition before its assigned area can be armed.
- 19.26** FIRE PANEL SLAVE INPUT: **NO** YES **Fire Panel Slave Input**  
 This option is available on Fire Zones (FI) only and allows a fire zone the ability to provide slave communication operation for a separate fire alarm control panel. If YES, this zone will transmit a restoral immediately when restored by the fire panel being monitored. A sensor reset is not required to generate the restoral message. If NO, this zone will operate as a standard fire type zone and a sensor reset is required before the zone will return to normal. Default is NO.
- 19.27** FOLLOW AREA: **0** **Area Follower**  
 Allows Night, Day, Aux 1, or Aux 2 burglary zones to be delayed by following any exit or entry delay that is currently running in the area that is specified. Default is 0.
- 19.28** ZONE REAL-TIME STATUS **NO** YES **Zone Real-Time Status**  
 Selecting YES allows Real-Time Status reports, such as Door Open or Closed with zone number, to be sent using PC Log reporting. Selecting NO disables Real-Time Status for this zone. Default is NO.
- 19.28.1** DOOR NUMBER: **0** **Door Number**  
 If ZONE REAL-TIME STATUS is selected as YES, enter a door number (keypad bus address) of 1-16. When a door number is selected, the door number is included in the status report instead of the zone number. Enter 0 (zero) to disable this feature and report the zone number. Default is 0 (no door).
- 19.29** ZONE AUDIT DAYS: 0 **Zone Audit Days**  
 Enter the number of days (0 to 365) allowed to elapse without the zone being tripped before a fault message is sent. The message is sent to the receiver(s) programmed to receive Supervisory/Trouble Reports at 10:00 am following the expiration of the timer. Each time the zone is tripped, the Zone Audit Days timer restarts and begins to countdown the number of days programmed. After the countdown expires, a fault message is sent and the Zone Audit Days timer restarts and begins to countdown the number of days programmed. Available for all zone types except fire and fire verify. Enter 0 (zero) to disable this function. Default is 0 (zero).
- 19.30** REPORT WITH ACCT NO. FOR AREA: **0** **Report with Account Number for Area**  
 This option is only available for 24-hour zone types (Fire, Fire Verify, Panic, Emergency, or Supervisory).  
 Enter the area number (1-32) to assign as a 24-hour zone type. This option sends the account number of the programmed area with messages. If the entered area number does not exist or is not valid, the account number programmed in the Communication section is sent. Select 0 (zero) to have the report sent with the account number programmed in Communication. Default is 0

## Stop

### 20.1

STOP
------

#### Stop

Save Programming

**WHEN ANY PANEL PROGRAMMING IS CHANGED, THE STOP ROUTINE MUST BE RUN AND 'SAVING PROGRAM' MUST DISPLAY ON THE KEYPAD IN ORDER TO SAVE THE PROGRAMMING CHANGES.**

At the STOP prompt, pressing any Select key allows you to exit the Programmer function of the panel. When selected, the panel performs an internal reset and exits the programmer.

The STOP routine causes the following conditions to occur:

- All 1100 Series DMP Wireless transmitters are reset to NORMAL
- The panel Status List is cleared

During the reset, all keypad displays are momentarily blank for two seconds. After the reset, the programming function terminates and the keypads return to the status list display.

The STOP prompt does not disarm the system. Any new areas or zones that were added during programming are not armed until the system is disarmed and armed again.

#### Missing LX-Bus™ Modules Displayed

The Programmer includes a feature following the STOP routine that displays the name of any programmed LX-Bus module not currently connected to the panel. For example, if you had enabled any LX-Bus options and not yet installed a 481 LX-Bus Expansion Card, after the STOP routine the panel displays NO LXBUS CARD. This is a helpful reminder to install the card. This feature can also be a troubleshooting tool to indicate a problem if you installed the card and this message still displays. The following list shows the different messages and their associated LX-Bus cards.

Keypad Display	Missing Card
NO LXBUS CARD	481 LX-Bus™ Expansion Card
NO PRINTER CARD	462P Printer Interface Card
NO HOST CARD	462N Network Interface Card (with NETWORK communication selected)

The above messages clear automatically from the keypad after a few moments.

#### Power Up

When the XR500 Series Canadian panel is powered up after an AC power failure, any zone transitions are not recognized for 120 seconds. Normal zone processing resumes at the end of the 120 seconds.

## SET LOCKOUT CODE

## Set Lockout Code

### 21.1

SET LOCKOUT CODE
------------------

#### Set Lockout Code

Pressing COMMAND at the STOP prompt displays SET LOCKOUT CODE. This allows you to program a code that is then required to gain access to the panel internal Programmer through the keypad. You can change this code at any time to any combination of numbers from three to five digits long. You do not need to enter leading zeros when using the lockout code. Initializing the panel does not clear a Lockout Code. Lockout Codes can be changed through Remote Link.

Once you have changed the code, it is important to write it down somewhere and store it in a safe place. Lost Lockout Codes require the panel to be sent back to DMP for repair. You may cancel a Lockout Code by entering 00000 at the Set Lockout Code command.

#### Lockout Code restriction

Do not set a Lockout Code higher than 65535.

**Feature Upgrade**

**22.1** FEATURE UPGRADE **Feature Upgrade**

In the Programming Menu, pressing COMMAND at the SET LOCKOUT CODE prompt displays FEATURE UPGRADE. This allows you to enable additional features in the panel. Press any top row Select key to display the first available feature. ENABLED or DISABLED displays indicating whether this feature is currently used in this panel. Press the COMMAND key to display additional feature(s).

ENTER KEY  
-

To enable a feature, press any top row Select key anywhere in the features list to display the ENTER KEY prompt.

Enter the factory-supplied feature key for the specific panel and press the COMMAND key. The feature specific to the key displays as ENABLED.

**Note:** XR500 Series version 106 or higher panels require a six (6) character feature key. Version 105 panels require a 16-character feature key.

If the feature key entered is not accepted, the ENTER KEY prompt displays again. Re-enter the feature key and press the COMMAND key.

**22.1.1** ENCRYPTION **Encryption**

DISABLED

Enable this feature to provide 128 bit AES data encryption. This feature upgrade can only be enabled on an XR500N panel version 105 or higher. For installations where an XR500 panel is installed, it is recommended the XR500 be replaced with an XR500E panel.

To complete encryption installation, access System Status in the User Menu to verify the encryption status (ON or OFF). If the status displays OFF, it indicates that the Passphrase has not been entered and data transmissions are not encrypted. See Network Options to set up a Passphrase.

**22.1.2** ALL NO YES OPTN **All No Yes Option**

DISABLED

This feature offers the ability to disable the ALL NO YES option at arming or disarming. When this feature is enabled, the ALL NO YES option does not display at any system keypad during arming or disarming. Each area assigned to the user profile is chosen to be armed or disarmed independently.

**22.1.3** SVC USER AUTH **Service User Authentication**

DISABLED

This feature offers the ability to authenticate service personnel before allowing access to panel programming or performing any user operations. When this feature is enabled and a valid Service User code is entered for system operation or 6653 is entered for programming, the Service Code entry option displays.

When the service person enters the Service Code, the panel authenticates the code with the Service Code preprogrammed in the SCS-1R receiver, and access to panel programming or the User Menu is granted. The Service Code can be used for system operation for 30 minutes before authenticating again. If the code entered is not validated, access to programming or the User Menu using the Service User code is denied.

**Note:** The Service User code is user number zero (0) and can only be created in the panel remotely. The SCS-1R receiver must have firmware version 902 or higher to authenticate service personnel.

**Purchasing Feature Upgrades**

To purchase a feature upgrade, you may contact DMP Customer Service with the feature you would like to enable and the panel serial number. The serial number(s) should be sent in writing via e-mail or fax. A separate feature key is issued for each panel. The feature key only enables the requested feature on the specified panel. The panel serial number can be located several different ways:

- Printed on a label located on the right side of the XR500 PCB.
- Using panel diagnostics. See the Appendix.
- Using Remote Link™ (version 1.18 or greater). See the Remote Link User's Guide (LT-0565).
  - Initial Panel Connection screen
  - System Information screen.

## Appendix

### 23.1 False Alarm Reduction

#### System Recently Armed report

The System Recently Armed report (S78) is sent to the receiver when a burglary zone goes into alarm within two minutes of the system being armed.

### 23.2 Diagnostics function

The XR500 Series Canadian panel contains a Diagnostics function that allows you to test the communication integrity of the LX-Bus™, identify individual zones, and also display the present electrical state of any zone. The Diagnostics function also allows you to test the integrity of the cellular communication, cellular signal, and email communication. To use Diagnostics, reset the panel, enter the Diagnostics code 2313 (DIAG), and press COMMAND.

#### Test LX-Bus

The first Diagnostic function you displayed is: **TEST LX-BUS**. This function allows you to test the ability of the 481, 462N, 462P, 462FM, and 472 Interface Cards to communicate with zone and output expander modules connected to their LX-Bus circuits.

To continue, press any top row Select key. The keypad displays **LX-BUS:**. Using the digit keys, enter the LX-Bus number, 1 to 5, to test that LX-Bus circuit. The keypad now displays **ADDRESS: -**. Enter a 2-digit LX-Bus device address and press COMMAND. When testing LX-Bus devices, enter only the addresses to which the modules have been set.

**Important Note:** A device address is not the same as a zone number. If you are testing 714 or 715 Zone Expander Modules, which each contain four zones, the device address is the first zone number. When the panel polls a 714 on the LX-Bus, it recognizes it as a four zone device and does not poll the remaining three zones. The 714 module internally polls the remaining zones and transmits any status changes to the panel. This greatly reduces the amount of time it takes the panel to poll all LX-Bus devices.

The keypad next displays **TESTING . . . STOP** during the device testing. At any time, you can Select **STOP** to end polling. The panel records the number of no responses from the device. If all polls are received back by the panel correctly, the keypad displays **00000/65535 FAIL**.

If one or more polling attempts fail, the keypad displays **\* \* \* \*/65535 FAIL** with the \* representing the number of failed polling attempts. A display of **65535/65535 FAIL** indicates a problem with the interface card or its LX-Bus wiring such as a bad or broken wire, harness not properly connected, or excessive noise or distance. It can also mean that a zone number was entered that did not match a device address. Press the Back Arrow key to enter a new device address or press COMMAND to exit the **TEST LX-BUS**.

#### Zone Finder

The second Diagnostic function is the Zone Finder. Press COMMAND to display **ZONE FINDER**. This function allows you to identify individual zones on devices connected to the LX-Bus of an interface card, the panel, or any zones on the keypad data bus. To use **ZONE FINDER**, press any top row Select key. The display changes to **FAULT ZONE**. The next zone on the system that changes from a normal to an open or shorted state is displayed as **ZONE NO: \* \* \***. To continue, press the Back Arrow key.

#### Zone State

Press the COMMAND to display the third Diagnostic function: **ZONE STATE**. This function allows you to enter any zone number and check its current electrical state (Normal, Open, or Shorted). Press any Select key. The display changes to **ZONE NUMBER: \_**. Enter in the zone number you want to check and press COMMAND. The panel displays the current state of the zone as **NRML** (normal), **OPEN**, or **SHORT**.

#### LX-Bus Status

The fourth Diagnostic function is the **LX-BUS STATUS**. This function allows the panel to poll all devices connected to the LX-Bus of an interface card and check for any Overlapped, Missing, or Extra addresses. Below is a description of each status item:

**Overlap** - An overlap occurs when one device address is the same as any of the last three zones on another 714 or 715. The overlap feature cannot determine when two devices have the same address.

**Example:** Model 714 Address 00 = Zones 500 501 502 503, and the Model 711 Address 02 = Zone 502. Zone 502 would report as an Overlap because both the 714 and 711 have devices set to 502.

**Missing** - A missing occurs when a zone between 500 and 999 has been programmed in **ZONE INFORMATION** and no device with that zone address has been installed on the LX-Bus. To correct the problem, check your zone programming and zone expansion module addressing.

**Extra** - A device is installed on the LX-Bus but none of its zones are programmed into the system.

**MAC Address**

Short for Media Access Control address. This hardware address uniquely identifies each network node. Not to be confused with an IP address, which is assignable. In the Diagnostics function, the MAC address is the panel on-board network hardware address. Press any top row Select key to display the panel MAC address. Press the COMMAND key to view the next prompt.

**Serial Number**

This number is the network communicator serial number. Reference this number for communicator date-of-manufacture, hardware version, etc. Press any top row Select key to display the Serial Number. Press the COMMAND key to view the next prompt.

**Current Flash**

This option displays Flash 1 or Flash 2 indicating which physical flash chip the panel is currently using. Press any top row Select key to display the current flash information. Press the COMMAND key to view the next prompt.

**Communication Status**

This option tests the individual components of cellular or network communication. The displayed results are shown below.

**Cellular Results:**

Successful Display	Failure Display
MODEM OPERATING	NO MODEM FOUND
TOWER DETECTED	NO TOWER
SIM REGISTERED	NOT REGISTERED
APN ACCEPTED	APN ERROR
CELL COMM GOOD	NO ACK RECEIVED

**Network Results:**

Successful Display	Failure Display
LINK OK	LINK ERROR
DHCP OK	DHCP ERROR
GATEWAY FOUND	NO GATEWAY
DEST FOUND	NO DESTINATION
COMM PATH GOOD	NOT CONNECTED NO ACK RECEIVED

**Cellular Signal**

This option provides a way to test the cellular signal strength. Press any top row Select key to test the cell signal. The display shows: SIGNAL: XXXXXXX. The x's represent the signal strength 0-7.

**Email Status**

The Email Status menu, located in Diagnostics, tests each component of the panel's e-mail communication. The test proceeds until the first component failure or until all components have been tested with positive results. The test screen displays after each component and displays for two seconds or until the CMD key has been pressed. The displayed results are shown below.

**Email Results:**

Successful Display	Failure Display
EMAIL ENABLED	EMAIL DISABLED
LINK OK	LINK ERROR
SMTP SERVER OK	INVALID SERVER
DEST ADDRESS OK	DEST ADDR FAILED
CONNECTING	CANNOT CONNECT
AUTH MODE SENT	AUTH MODE FAILED
PASSWORD SENT	BAD PASSWORD (or USERNAME)

Successful Display	Failure Display
FROM ADDR SENT	FROM ADDR FAILED
DEST ADDR SENT	DEST ADDR FAILED
DATA MODE SENT	DATA MODE FAILED
MESSAGE SENT	MSG SEND FAILED
DISCONNECTED	DISCONNECT FAIL
EMAIL SUCCESS	

**Exiting the Diagnostics program**

To exit the Diagnostics function, press the COMMAND key until STOP displays. Press any Select key to exit the diagnostics function. The keypad returns to the Status List display.



### 23.3 Using the 984 Command Function

This feature allows you to connect to a service receiver, is used primarily to bring a new account on-line and upload panel programming completed in Remote Link™.

Note: When not in the Programming Menu, the function 984 + COMMAND can be entered at the keypad, and a remote options menu appears. This menu contains the following options:

**NUMBER:** The panel allows you to enter into the keypad a phone number you want the panel to dial. Enter any required prefixes and area codes. After completing panel programming in Remote Link, set a trap to seize the panel when it calls. Traps are set by selecting Panel > Trap. Refer to the Remote Link User's Guide (LT-0565), or the Remote Link Help File.

Then, from the panel, enter 984 and press the COMMAND key, while the panel is in the Status List. The keypad display changes to **NBR TEST PICKUP**. Press the Select key under **NBR**. Enter the phone number for the service receiver connected to the Remote Link computer. Press each number key slowly and deliberately. The panel dials each number as it is pressed. If you make a mistake, press the Back Arrow key. The panel stops dialing and return to the Status List.

You can enter up to 32 characters for the phone number. Once you have entered 16 characters the LCD display is full: Press the COMMAND key to enter the final 16 characters. To enter a # (pound sign) press the '0' then the fourth (far right) Select key, and to enter an \* (asterisk) press the third Select key. Program a pause by entering the letter P. Program CID message communication by entering the letter T in the first position. Cancel call waiting by entering \*70P as the first characters. These characters are counted as part of the allowable 32 characters. Press COMMAND after you enter the phone number.

The panel calls the receiver connected to Remote Link to download the new programming. Remote Link then traps the panel.

Note: The panel makes ten attempts to reach the receiver. While attempting to contact the receiver, if the panel needs to send an alarm report, the panel stops dialing and uses the phone line to send its report.

**TEST:** The panel allows you to perform a Communication Status Test on each component of the panel's cellular or network communication paths. While the Status List displays, enter 984 and press the COMMAND key. The keypad display changes to **NBR TEST PICKUP**. Press the Select key under **TEST** to allow the panel to perform a Communication Status Test. The display prompts the user for a user code to be entered. The user code must have the authority to perform a System Test.

Upon entry of a Cell or Network path when prompted, the test runs and the results display on the keypad. See Diagnostic Functions section for a description of the Communication Status results.

**PICKUP:** The panel picks up the phone line when Remote Link™ calls in. The phone must be ringing before selecting PICKUP. After completing panel programming in Remote Link, connect to the panel by selecting Panel > Connect. Refer to the Remote Link User's Guide (LT-0565), or Help File for complete information about connecting to panels.

While the panel displays in the status list and the telephone line at the panel rings, enter 984 and press the COMMAND key. The keypad display changes to **NBR TEST PICKUP**. Press the Select key under **PICKUP** to allow the panel to seize the line. The panel immediately seizes the phone line and sends a carrier tone to the receiver. A verification process occurs and, if successful, the panel grants remote access to its programming and Event Buffer.

After the panel has seized the line, send the file from Remote Link by selecting Panel > Send. Remote Link then uploads the new programming into the panel. You may also Request Events by selecting Panel > Request Events in Remote Link. The panel begins sending the first event or access that occurred on or after the start date specified by Remote Link and finishes by sending the last event or access that occurred on or before the end date specified by Remote Link. If necessary, a Request Events upload in progress can be cancelled.

#### Keypad Displays

When the **PICKUP** option is used, the keypad displays **LINE SEIZED**. This indicates that the panel has seized the line and is executing its program. If the line cannot be accessed, or if the **PICKUP** option is used before all connect attempts are made, the keypad displays **SYSTEM BUSY**.



## 23.4 Using the Walk Test

The XR500 Series Canadian panel provides a walk test feature that allows a single technician to test the protection devices connected to zones on the system. Conduct the Walk Test within 30 minutes of resetting the panel. The Walk Test automatically ends if no zones are tripped for 20 minutes. TEST IN PROGRESS displays at all keypads programmed with the same Area Display features. When five minutes remain, TEST END WARNING displays. The Walk Test only tests zones assigned to the areas programmed into the keypad in Area Display. If any areas are armed the Walk Test does not start and SYSTEM ARMED displays.

WALK TEST

### Walk Test

To conduct the Walk Test, reset the control panel by momentarily placing a jumper on J16. From the keypad, enter the code 8144. The keypad displays WALK TEST for four seconds. If the system is monitored and the communication type is DD or NET, the system sends a System Test Begin report to the central station. After four seconds, the keypad displays the zone type choices for testing.

Note: If **ENHANCED ZONE TEST** in System Options is set to YES, the Walk Test can be limited to only operate during the Area 32, Shift 4 schedule if programmed. If no schedule is entered, the walk test always operates.

BG FI PN SV

### Zone Types

Select the zone type you want to test. An asterisk next to the zone type indicates the zone type chosen for testing. Press the Select key again to deselect the zone type. When you have selected all the zone types you want for testing, press the COMMAND key to display the next Walk Test option. Pressing the Back Arrow key exits the Walk Test.

**Note:** For the Wireless Check-in Test, make sure no zone types are selected and press the COMMAND key. Pressing the Back Arrow key exits the Walk Test.

**BG** (Burglary zones) - Select **BG** to test burglary zones. Includes all NT, DY, EX, A1, and A2 zones.

**FI** (Fire zones) - Select **FI** to test fire zones. Includes all FI and FV zones.

**PN** (Panic zones) - Select **PN** to test panic zones. Includes all PN and EM zones.

**SV** (Supervisory zones) - Select **SV** to test supervisory zones. Includes all SV zones.

**Note:** During the Walk Test, trip each zone device or button on the system for 1 to 2 seconds. You do **NOT** have to hold the zones for 2 seconds in normal mode for PN type zones. You are only required to hold the panic during the Walk Test because the zone takes additional time to report when the system is in test mode.

WLS PIR

**WLS** (Wireless Check-in Test) - Select WLS to automatically test wireless transmitter communications. Includes all wireless devices except key fobs and transmitters programmed for a supervision time of 0 (zero).

**PIR** (Wireless PIR Walk Test) - The PIR Walk Test allows the installer to verify the 1126 operation. When enabled, the 1126 LED flashes each time motion is detected for up to 30 minutes. This is a local test only and no messages are sent to the Central Station.

BELL NO YES PULS

### Bell Action

This option selects the bell output action when a zone under test faults. This option allows the panel bell, and/or burglary bell, and/or fire bell to turn ON and then OFF each time a zone is tripped (opened or shorted).

**NO** - Select NO for no bell output action during Walk Test.

**YES** - Select YES to turn on any bell output for 2 seconds during Walk Test.

**PULS** - Select PULS to turn on any bell output for 1/4 second during Walk Test. Any LX-Bus device output turns on for 1.6 seconds due to the polling cycle.

TRIPS: XXX END

### Trip Counter For Walk Test

Once in the Walk Test, walk around and trip each protective device. Continue tripping devices until the entire system is tested.

With each zone trip during the Walk Test:

- Keypad display increments each time a selected zone is opened or shorted
- The keypad buzzes for two seconds
- The panel sounds the alarm bells as programmed in Bell Action
- Each time a FI, FV, or SV zone trips, a Sensor Reset occurs.

If **ENHANCED ZONE TEST** is selected as YES:

A Verify message is sent at the time the zone trip occurs instead of at the end of the Walk Test. For FI, FV or SV zone types, the Verify message is sent at the initial trip. For all other zone types, the Verify message is sent when the zone restores. This allows the Central Station to count the number of devices per zone.

**END** - Select END to stop the Walk Test. When the Walk Test ends or a 20-minute time-out expires, a final Sensor Reset occurs. The System Test End message is sent to the receiver along with Verify and Fail messages for each zone under test. Faulted zones then display on the keypad.

**CKIN:XXX/ZZZ END**

### **Trip Counter For DMP Wireless Check-in Test (WLS)**

Displays the number of wireless zones that automatically communicate a supervision check-in message.

- The number of zones that check in. (XXX in the example).
- The total number of wireless zones programmed for supervision that should check in. (ZZZ in the example).

**END** - Select END to stop the Wireless Check-in Test. When the test ends or a 20-minute time-out expires, normal wireless zone processing returns. If all transmitters check-in, both numbers match within three (3) minutes. If a transmitter has multiple zones (1101, 1114, etc.), all zones are included in the counts. Failed wireless zones display on the keypad.

**TEST END WARNING**

### **Test End Warning**

When five minutes remain on the 20 minute Walk Test timer, the keypad displays TEST END WARNING. If no additional test zone trips occur, the test ends and a final Sensor Reset automatically occurs. The System Test End message is sent to the receiver along with Verify and Fail messages for each zone under Walk test. Faulted zones then display on the keypad.

**SOUTH LOBBY**

### **Failed Zones Display**

**ZONE: 10 -FAIL**

For each zone that did not trip (failed) at least once during the Walk Test, all keypads with matching Area Display programming display the zone name and number and buzz for one second. Any selected (\*FI \*PN \*SV) 24-hour zone that is faulted at the end of the Walk Test displays a trouble condition for that zone regardless of the message programmed for the open or short condition of the zone and a zone trouble is sent to the receiver. Press the COMMAND key to display the next failed zone.

**Note:** For the Wireless Check-in Test, failed wireless zones display only on the keypad. Zone Verify/Fail reports are not sent to the central station receiver for the wireless check-in test.

### **Local Printer for Walk Test**

When the Walk Test is completed, a Verify or Fail message for each zone tested prints to the local printer. The Walk Test messages printing is enabled through Printer Reports programming.

**Note:** If ENHANCED ZONE TEST is selected as YES, the Verify messages are printed at the time the zone trip occurs and not printed at the test end.

## **23.5 Keypad Speaker Operation**

When using LCD Keypads, the panel provides distinct speaker tones from the keypad for Fire, Burglary, Zone Monitor, and Prewarn events. The list below details the conditions under which the speaker is turned on and off for each event.

<b>Fire</b>	<b>On</b> - Fire zone alarm and Bell Output or Fire Bell Output is ON. <b>Off</b> - Alarm Silence.
<b>Burglary</b>	<b>On</b> - Burglary zone alarm and Bell Output or Burglary Bell Output is ON. <b>Off</b> - Alarm Silence.
<b>Zone Monitor</b>	<b>On</b> - One time only when a monitored zone is tripped. <b>Off</b> - After one tone.
<b>Prewarn</b>	<b>On</b> - During Entry Delay. <b>Off</b> - When Entry Delay expires.

**23.6 Cross Zoning**

Caution must be taken when cross zoning devices to ensure that the Cross Zone Time is long enough to allow an intruder to trip both devices before it expires. A Cross Zone Time that is too short may allow an intruder to trip the devices and allow only a zone fault report be sent to the central station.

When a Cross Zoned zone trips a FAULT report is sent to the SCS-1R Receiver. When two Cross Zoned zones trip within the Cross Zone Time, both zones send ALARM signals to the receiver. For example, if zones 1 and 2 are Cross Zoned zones, and only zone 1 trips, a FAULT report is sent to the receiver for zone 1. If zone 1 trips and zone 2 trips within the Cross Zone Time, an ALARM report is sent to the receiver for zone 1 and zone 2.

**23.7 Events Manager**

The Events Manager allows you to delay sending certain reports to the central station receiver. Reports can be kept in the panel memory until overwritten by new activity or held until the memory buffer reaches 50 events or 50 door access granted events. When the buffer is full, the panel automatically sends the stored reports to the central station receiver. The table lists the panel reports you can delay using the Events Manager option.

Report Type	Immediately	Delayed
Alarm	Y	
Trouble	Y	
Restore	Y	
Opening		Y
Closing		Y
Bypass	Y	
Reset	Y	
Supervisory	Y	
Add Codes		Y
Delete Codes		Y
Change Codes		Y
Permanent Schedule Change		Y
Temporary Schedule Change		Y
Door Access		Y
Door Access Denied	Y	
Late to Close	Y	
Force Armed Zone	Y	

**23.8 User Profiles**

A profile defines the authority of each user code in the system. Profiles are programmed in the Keypad User Menu. Several characteristics associated with each User Profile define its authority within the system. To effectively program an XR500 Series system, you must understand the interrelationship between profiles, devices, output groups, and areas. Below is a brief explanation of the User Profile elements. For more information about user profiles, refer to the User Profiles Record and the XR100/XR500 User’s Guide (LT-0683).

**Note:** Profiles cannot be changed via keypad in an All/Perimeter or Home/Sleep/Away system. Use the default profiles 1 through 10.

**Profile Number** - Each profile may be assigned a unique number from 1 to 99.

**Profile Name** - Each profile may be assigned a 32-character name. The Profile Number is the default name.

**Area Number** - Each profile may be assigned specific areas of the system for arming and disarming.

When creating profiles 1 to 98, NO areas are assigned by default. The default for profile 99 is ALL areas assigned. Profile 99 is preprogrammed in the system at the factory.

**Access Area Number** - Each profile may be assigned door access area assignments. Default for profile 1 to 98 is NO areas assigned. Default for profile 99 is ALL areas assigned. Profile 99 is preprogrammed at the factory.

**Output Group Assignment** - Each profile may be assigned an output group number from 1 to 10. Default for profile 1 to 98 is NO output group assigned. Default for profile 99 is output group 10. Your system may be programmed to turn on an output group at certain keypads when door access occurs.

**User Menu Assignments** - Each user profile may have any of the menus assigned to it as shown in the following User Profile Record. The User Profile Record lists the user menu profile assignments and the system functions users are allowed to access based on the profile numbers assigned to their codes.

Always make sure that at least one administrator in your system has a profile with **all** authorities and areas.

**23.9 User Profiles Record**

This User Profiles Record can be used as a tool when programming Devices, Profiles, Areas, and Output Groups. Because these programming options are interrelated, use this sheet to plan the system before you begin the installation and programming process.



### 23.10.1 Wireless Check-in and Supervision Definitions

#### FA Series Check-in Time Explained

The check-in time programmed for FA Series wireless transmitters is the number of seconds between each message sent from the transmitter to the FA Series receiver for supervision purposes. This time is programmable for each transmitter from 10, 30, or 60 seconds. Selecting 0 (zero) disables check-in. If no messages are received from a transmitter in any four-hour period, a transmitter missing is generated by the FA Series receiver and communicated to the panel.

#### DMP 1100 Series Supervision Time Explained

The supervision time programmed for DMP 1100 Series wireless is the number of minutes that must elapse before a transmitter missing message is generated for a transmitter that is not sending its automatically generated supervision message. The supervision time is programmable to 3, 60, 240 minutes. Selecting 0 (zero) disables supervision time.

### 23.11 Keypad Bus and LX-Bus Zone Type Descriptions

This section describes applications for the default Keypad and LX-Bus zone types in Zone Information programming.

#### -- (Blank Zone)

Customizable zone type. By default, no actions are programmed to occur with Blank Zone. A zone name must be entered to use this zone type: This zone type is not the same as an \*UNUSED\* zone.

#### NT (Night Zone)

Controlled instant zone used for perimeter doors and windows and interior devices such as PIRs and Glassbreak detectors.

#### DY (Day zone)

Used for emergency doors or fire doors to sound the keypad buzzer and display the zone name when the zone is faulted. Day zones also send alarm reports to the receiver during the system armed periods.

#### EX (Exit zone)

Initiates the entry delay timer when its assigned area is fully armed. Also, can initiate an exit delay timer to allow a user to exit an area after the arming process starts.

#### PN (Panic zone)

Used for connecting to mechanical devices that allow a user to signal an emergency alarm. Panic zones can provide either a silent or audible alarm with or without reporting to a central station receiver.

#### EM (Emergency zone)

These are used for reporting medical or other non-panic emergencies to the central station receiver.

#### SV (Supervisory zone)

Used to provide 24-hour zone supervision to devices associated with fire systems. Typical applications are tamper switches on Post Indicator Valves (PIVs), gate valves, and low and high temperature gauges.

#### FI (Fire zone)

Used for any type of powered or mechanical fire detection device. Typical applications are for smoke detectors, sprinkler flowswitches, manual pull stations, and beam detectors. Retard, cross zoning, and presignal options are available for the Fire zone type.

#### FV (Fire Verify zone)

Used primarily for smoke detector circuits to verify the existence of an actual fire condition. When a Fire Verify zone initiates an alarm, the panel performs a Fire Reset. If any Fire Verify zone initiates an alarm within 120 seconds after the reset, an alarm is indicated. If an alarm is initiated after 120 seconds, the cycle repeats.

#### A1 and A2 (Auxiliary 1 and Auxiliary 2)

These zones are similar to a Night zone and are typically used to protect restricted areas within a protected premises.

#### AR (Arming zone)

This zone allows you to connect a keyswitch to a zone and use it to arm and disarm one or more areas.

### 23.12 Zone Type Specifications

The XR500 Series Canadian panel contains multiple default zone types for use in configuring the system. These zone types provide the most commonly selected functions for their applications. All zone types can be customized by changing the variable options listed below. The Keypad Bus Zone Information table below reflects the zone types for Keypad Bus Zones. The XR500 Series LX-Bus Zone Information table on the next page reflects the zone types for LX-Bus Zones.



Keypad Bus Zone Information Assign Disarm condition of NT, DY, EX, A1, and A2 only Assign Prewarn and Entry Delay for EX only Assign Retard and Presignal for FI, SV, A1, and A2 only Zone Type Defaults	Type	Area	Fire Bell	Disarmed Open			Disarmed Short			Armed Open			Armed Short			Swinger	Prewarn	Entry Delay	Retard Delay	Presignal	Fast Response	Cross Zone	Priority	Follow Area	Real-Time Rprts	Door Number	Style	
	Output *	Message	Output *	Action	Message	Output *	Action	Message	Output *	Action	Message	Output *	Action	Message	Output *	Action	Swinger	Prewarn	Entry Delay	Retard Delay	Presignal	Fast Response	Cross Zone	Priority	Follow Area	Real-Time Rprts	Door Number	Style
	-- NT DY EX FI PN EM SV A1 A2 FV AR	INT PERIM BDRM or 1 to 32		A T L D S C	- 0 S	S P M F	A T L D S C	- 0 S	S P M F	A T L D S C	0 S	A T L D S C	0 S	A T L D S C	0 S	Y	1 to 16	1 to 4	N or Y	1 to 16	N or Y	N or Y	N or Y	N or Y	0 to 16	N or Y	0 to 16	TGL ARM DIS STEP MNT
Night	NT			-	0	S	-	0	S	A	0	S	A	0	S	Y					N	N	N	0	N	0		
Day	DY			T	0	S	T	0	S	A	0	S	A	0	S	Y					N	N	N	0	N	0		
Exit	EX			-	0	S	-	0	S	A	0	S	A	0	S	Y	1-16	1			N	N	N	0	N	0		
Fire	FI		0							T	0	S	A	0	S	N			N	+	N	N	N					
Panic	PN									T	0	S	A	0	S	N					N	N	N					
Emergency	EM									T	0	S	A	0	S	N					N	N	N					
Supervisory	SV		0							T	0	S	A	0	S	N			N	+	N	N	N					
Auxiliary 1	A1			T	0	S	A	0	S	T	0	S	A	0	S	N			N	+	N	N	N	0	N	0		
Auxiliary 2	A2			T	0	S	A	0	S	T	0	S	A	0	S	N			N	+	N	N	N	0	N	0		
Fire Verify	FV		0							T	0	S	A	0	S	N					N	N						
Arming	AR																										TGL	

\*Output Options: 1 to 6, 450 to 474, 480 to 499, 500 to 999, D1 to D16, G1 to G20. + = Set retard to YES before selecting presignal.  = Zone functions not available.

## 23.12.1 Keypad Bus Zone Type Defaults

These are complete spellings of the abbreviations used for the zone types, such as Night and Exit.

**Type** - These are the abbreviations used for the zone types, such as NT and EX.

**Area** - For an Area or Home/Sleep/Away with Guest system this is 1 to 32. For an All/Perimeter or Home/Sleep/Away system, this is the Interior, Bedroom, or Perimeter. Select the area for NT, DY, EX, A1, A2, and AR types.

**Fire Bell Out** - Only available for FI, FV, and SV zones. Use any output zone number listed.

**Message** - A = alarm report, T = trouble report, L = local, no report, - (dash) = no report, D = door propped (When SV zone is connected to 303 Silence/Reset Switch), S = sensor reset/alarm silence, C = early morning ambush cancel.

**Output** - These are 1 to 6 on-board and 500 to 999 off-board relay outputs, 450 to 474 and 480 to 499 wireless outputs, D1 to D16, and G1 to G20.

**Action** - This selects the action of the output: S = steady, P = pulse, M = momentary, and F = follow

**Swinger** - The zone can be automatically shunted after a programmed number of trips.

**Prewarn** - This selects the keypad address that sounds the entry prewarn for this zone.

**Entry Delay** - This is the entry delay timer selected as the default for this zone.

**Retard Delay** - Provides a programmed retard time before an alarm initiates from a shorted zone. When used on an arming zone, the retard delay occurs when the zone is shorted before the armed state has changed. If the arming zone has Maintain as the Style, the retard delay also occurs when the zone returns to a normal state.

**Presignal** - Provides a keypad tone for zones in retard delay. Retard must be YES before Presignal can be selected.

**Fast Response** - Provides a 167ms zone response instead of the normal 500ms response.

**Cross Zone** - Provides cross zoning with any of the 574 zones.

**Priority** - Requires this zone to be in a normal condition before the area can be armed.

**Style** - The abbreviations for arming zone style:

TGL = Toggle, ARM = Arm only, DIS = Disarm only, STEP = Wireless arming, MNT = Maintain



XR500 Series LX-Bus Zone Information	Type	Area	Fire Bell	FA Series Wireless		DMP Wireless				Disarmed Open		Disarmed Short		Armed Open		Armed Short		Swinger	Entry Delay	Retard Delay	Presignal	Fast Response	Cross Zone	Priority	Follow Area	Real-Time Reports	Door Number	TGL Style
				1101 Contact	1101 EXT Contact N/O?	1114 Contact	Supervision Time	1142 LED Operation	1126 Disarm/Disable	1126 Pulse Count	1126 Sensitivity	Check-in Time	INT Contact	End-of-Line	Normally Open	Message	Output *											
Assign Disarm condition for NT, DY, EX, A1, and A2 only.	NT	INT		N	INT	1	0	N	2	Low	None	N	N	N	N	N	N	N	1	N	N	N	N	N	N	0	TGL	
Assign Prewarn and Entry Delay for EX only.	DY	PERIM		or	INT	2	3	or	3	or	10	N	N	N	N	N	N	N	2	N	N	N	N	N	N	0	ARM	
Assign Retard and Presignal for FI, SV, A1, A2, and PN only.	FI	BDRM		Y	EXT	3	60	Y	4	High	30	Y	Y	Y	Y	Y	Y	3	N	N	N	N	N	N	N	0	DIS	
	EM	or		Y	EXT	4	240	Y	4	4	60	Y	Y	Y	Y	Y	Y	4	N	N	N	N	N	N	N	0	STEP	
	A1	1		N	INT	1	240	Y	4	Low	60	N	N	N	N	N	N	0	1	N	N	N	N	N	N	0	MNT	
	A2	to		N	INT	1	240	Y	4	Low	60	N	N	N	N	N	N	0	2	N	N	N	N	N	N	0		
	FV	32		Y	EXT	4	240	Y	4	4	60	N	N	N	N	N	N	0	3	N	N	N	N	N	N	0		
	AR			N	INT	1	240	Y	4	Low	60	N	N	N	N	N	N	0	4	N	N	N	N	N	N	0		
	NIGHT			N	INT	1	240	Y	4	Low	60	N	N	N	N	N	N	0		N	N	N	N	N	N	0		
	DAY			N	INT	1	240	Y	4	Low	60	N	N	N	N	N	N	0		N	N	N	N	N	N	0		
	EXIT			N	INT	1	240	Y	4	Low	60	N	N	N	N	N	N	0		N	N	N	N	N	N	0		
	FIRE		0	N	INT	1	240	Y	4	Low	60	N	N	N	N	N	N	0		N	N	N	N	N	N	0		
	PANIC			N	INT	1	240	Y	4	Low	60	N	N	N	N	N	N	0		N	N	N	N	N	N	0		
	EMERGENCY			N	INT	1	240	Y	4	Low	60	N	N	N	N	N	N	0		N	N	N	N	N	N	0		
	EMERGENCY			N	INT	1	240	Y	4	Low	60	N	N	N	N	N	N	0		N	N	N	N	N	N	0		
	SUPERVISORY		0	N	INT	1	240	Y	4	Low	60	N	N	N	N	N	N	0		N	N	N	N	N	N	0		
	AUXILIARY 1			N	INT	1	240	Y	4	Low	60	N	N	N	N	N	N	0		N	N	N	N	N	N	0		
	AUXILIARY 2			N	INT	1	240	Y	4	Low	60	N	N	N	N	N	N	0		N	N	N	N	N	N	0		
	FIRE VERIFY		0	N	INT	1	240	Y	4	Low	60	N	N	N	N	N	N	0		N	N	N	N	N	N	0		
	ARMING			N	INT	1	240	Y	4	Low	60	N	N	N	N	N	N	0		N	N	N	N	N	N	0		

\*Output Options: 1 to 6, 450 to 474, 480 to 499, 500 to 999, D1 to D16, G1 to G20. +=Set retard to YES before selecting presignal. - Zone functions not available.

### 23.12.2 LX-Bus Zone Type Defaults

These are complete spellings of the abbreviations used for the zone types, such as Night and Exit.

**Type** - These are the abbreviations used for the zone types, such as NT and EX.

**Area** - For an Area or Home/Sleep/Away with Guest system this is 1 to 32. For an All/Perimeter or Home/Sleep/Away system, this is the Interior, Bedroom, or Perimeter. Select the area for NT, DY, EX, A1, A2, and AR types.

**Fire Bell Out** - Only available for FI, FV, and SV zones. Use any output zone number listed.

**Wireless** - This indicates wireless equipment is being used.

**DMP Wireless** - These options are for use with the DMP 1100X Wireless Receiver.

**FA Series Wireless** - These options are for use with the FA400-DMP Remote Wireless Receiver.

**Message** - A = alarm report, T = trouble report, L = local, no report, - (dash) = no report, D = door propped (When SV zone is connected to 303 Silence/Reset Switch), S = sensor reset/alarm silence, C = early morning ambush cancel.

**Output** - These are 1 to 6 on-board and 500 to 999 off-board relay outputs, 450 to 474 and 480 to 499 wireless outputs, D1 to D16, and G1 to G20.

**Action** - This selects the action of the output: S = steady, P = pulse, M = momentary, and F = follow

**Swinger** - The zone can be automatically shunted after a programmed number of trips.

**Prewarn** - This selects the keypad address that sounds the entry prewarn for this zone.

**Entry Delay** - This is the entry delay timer selected as the default for this zone.

**Retard Delay** - Provides a programmed retard time before an alarm initiates from a shorted zone. When used on an arming zone, the retard delay occurs when the zone is shorted before the armed state has changed. If the arming zone has Maintain as the Style, the retard delay also occurs when the zone returns to a normal state.

**Presignal** - Provides a keypad tone for zones in retard delay. Retard must be YES before Presignal can be selected.

**Fast Response** - Provides a 167ms zone response instead of the normal 500ms response.

**Cross Zone** - Provides cross zoning with any of the 574 zones.

**Priority** - Requires this zone to be in a normal condition before the area can be armed.

**Style** - The abbreviations for arming zone style: TGL = Toggle, ARM = Arm only, DIS = Disarm only, STEP = Wireless arming, MNT = Maint

## 23.13 Common Keypad Messages

There are several common keypad messages that the keypad displays to inform the technician and end-user. The common messages are described below. Possible solutions are also provided.

Message	Meaning	Possible Solutions
INVALID AREA	The user has attempted a door access for an area they are not assigned.	Change the user access areas if access to the area is needed. If access is not needed, the user cannot enter the area.
INVALID CODE	The user code you entered is not recognized by the system.	Check the user code and try again.
INVALID PROFILE	A user attempted a function that is outside of the assigned profile.	Check the user profile settings.
INVALID TIME	A user code assigned to a specific schedule has entered outside of the valid schedule.	See Schedules and User Codes.
ENTER 2ND CODE	The area you are attempting to disarm or access is a Two Man Area.	A second and different user code must be entered.
CLOSING TIME	The scheduled has expired but the area is not armed.	Users still on the premise should arm the system or extend the schedule to a later time.
LATE TO CLOSE	The system was not armed at its scheduled closing time.	Users still on the premise should arm the system or extend the schedule to a later time.
FAILED TO EXIT	A user assigned the anti-passback option has attempted to re-enter an area from which they did not exit properly.	The user must exit the area through the proper door. If not possible, your system administrator should select the Forgive option in the User Codes menu.
AC TROUBLE	The system is not getting proper power.	Check that all AC connections are good.
BATTERY TROUBLE	The battery is either low or missing.	Check that the battery connections are good and the battery is still good.
PHONE LINE 1 TROUBLE	There is trouble with the phone line supervision.	Plug in the phone line.
SYSTEM TROUBLE or SERVICE REQUIRED	There is a problem with one or more components in the system.	Make sure the J16 jumper is removed from the panel. Make sure there is not a short or open condition on the green data wire to the keypad. You may also need to check that all of the keypads and expansion modules on the bus are good.
SYSTEM BUSY	The system is performing another task with a higher priority.	Wait a few moments for the system to complete the task. Make sure the J16 jumper is not on the panel. If the message displays for a long period of time, the processor could be locked up.
4-WIRE BUS TROUBLE	There is not a supervised device on the bus.	Program a device to be supervised.
	There is low voltage or an open yellow wire.	Make sure all wires are connected.
	Two devices share the same address.	Program one of the devices to a unique address.
TRANSMIT FAIL	The panel has attempted to communicate with the central station 10 times and has not succeeded.	Verify your communication type, account number, and phone number. Make sure the telephone line is connected and working properly.
NON-POLLED ADDRESS	The device is not set to DOOR, KEYPAD or FIRE in Device Setup during programming.	Program the device as DOOR, KEYPAD or FIRE in Device Setup.
ENTER CODE (to enter Programming)	A lockout code has been programmed for the panel.	Enter the lockout code.
WIRELESS TROUBLE	The panel is unable to communicate with the wireless receiver.	Verify the receiver is properly connected to the panel. Verify the correct House Code is programmed in System Options.
	The wireless receiver is missing.	

### 23.14 Area Account Number Messages

XR500 systems send an area account number instead of the system account number with the following panel messages/events based on the area assigned to the zone that initiated the alarm:

- WARNING: Alarm Bell Silenced (S34)
- Abort Signal Received (S45)
- Cancel Signal Received (S49)
- ALERT: System Recently Armed (S78)
- ALERT: Exit Error (S80)
- ALARM: Verify Signal Received (S96) (not currently sent on area arming systems)

The XR500 has always sent the area account number for the following messages:

- Zone event messages for all non-24 hour zones assigned to an area
- Arming
- Disarming

The XR500 sends the following messages using the area account number based on the lowest area number in Display Areas programming from the keypad being used:

- User Code Add/Change/Delete
- Door Access/Denied
- User 1 Ambush and Early Morning Ambush
- System Test Begin/End
- Unauthorized Entry
- Service Code and Service Request

The XR500 sends the following messages using the area account number based on the area number:

- Late to Arm for area schedules

## Revisions to This Document

This section explains the changes made to this document during this revision. It lists the version, identifies the change(s) made, the related section number and heading, and a summary of the change.

### Guide

Version	Section Number and Heading	Quick Explanation of Changes	
1.08	6.4 Access Areas	Added statement about door locking	
	6.7 Strike Time	Added device type information	
	6.8 Strike Delay	Added device type information	
	6.13 Door Real-Time Status	Added Door Real-Time Status prompt	
	6.14 Send Door Forced Message	Added Send Door Forced Message prompt	
	6.15 Program 734 Options	Added Program 734 Options prompts	
	7 Remote Options	Complete restructure and reorganization	
	7.2 Remote Key	Allow up to 16 characters	
	7.4 Allow Dialer Remote	Added Allow Dialer Remote prompt	
	7.5 Allow Network Remote	Added Allow Network remote prompts	
	7.6 Allow Cellular Remote	Added Allow Cell Remote prompts	
	7.7 Allow RS-232 Remote	Added Allow RS-232 Remote prompt	
	7.8 Entré Connection	Added Entré Connection prompts	
	19.30 Report with Acct Number for Area	Added Report with Account Number for Area prompt	
	1.07	3.34 Send Path Information	Added Send Path Information section
		5.4 Destination 1	Added TLS Encryption note
		5.5 Destination 1 User Number	Added Destination 1 User Number section
5.7 Destination 2 User Number		Added Destination 2 User Number section	
5.9 Destination 3 User Number		Added Destination 3 User Number section	
5.13 Monthly Limit		Added Monthly Limit option	
6.2 Device Number		Added new Device Types	
6.3 Door Name		Added option of entering up to 32 characters	
7.14 First/Second GPRS APN		Added First/Second GPRS APN section	
9.23 Send 16 Character Names		Added Send 16 Character Names option	
12.3 Output Name		Added option of entering up to 32 characters	
13.3 Group Name		Added option of entering up to 32 characters	
18.2 Exit Delay		Changed exit delay minimum from 45 to 30 seconds	
18.11 Area Name		Added option of entering up to 32 characters	
19.3 Zone Name		Added option of entering up to 32 characters	
19.26 Fire Panel Slave Input	Added Fire Panel Slave Input option		
19.29 Zone Audit Days	Added Zone Audit Days section		
23.3 Using the 984 Command Function	Changed Keypad to Test		
23.8 User Profiles	Added option of entering up to 32 characters		

## Listings and Approvals

This Class A digital apparatus complies with Canadian ICES-003

NIST Validated XR500E Encrypted Command Processor Panel Certificate #130

ANSI/SIA CP-01-2000 False Alarm Reduction

Underwriters Laboratories Canada (ULC) Listed

ULC S545	Household Fire
ULC Subject-C1023	Household Burglar
ULC/ORD-C1076	Proprietary Burglar
ULC S304-06	Central Station Burglar



800-641-4282

[www.dmp.com](http://www.dmp.com)

Made in the USA

INTRUSION • FIRE • ACCESS • NETWORKS

2500 North Partnership Boulevard

Springfield, Missouri 65803-8877

MADE IN U.S.A. 10392  
LT-0679CAN 1.08 © 2010 Digital Monitoring Products, Inc.

## Free Manuals Download Website

<http://myh66.com>

<http://usermanuals.us>

<http://www.somanuals.com>

<http://www.4manuals.cc>

<http://www.manual-lib.com>

<http://www.404manual.com>

<http://www.luxmanual.com>

<http://aubethermostatmanual.com>

Golf course search by state

<http://golfingnear.com>

Email search by domain

<http://emailbydomain.com>

Auto manuals search

<http://auto.somanuals.com>

TV manuals search

<http://tv.somanuals.com>