

# **DXG-569V HD**

---

## **User's Manual**

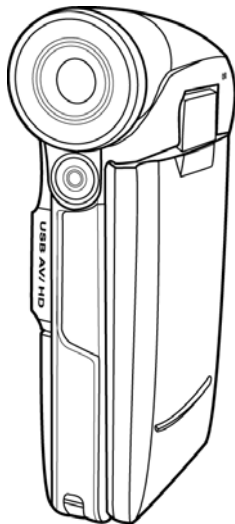

**DXG USA**

---



# Table of Contents

<i>Preface</i> .....	v
<i>About this manual</i> .....	v
<i>Copyright</i> .....	v
<i>Precautions</i> .....	vi
<i>Before You Start</i> .....	viii
<b>1 Introducing the camera</b> .....	<b>1</b>
<b>1.1 System requirements</b> .....	<b>1</b>
<b>1.2 Features</b> .....	<b>1</b>
<b>1.3 Unpacking the video camera</b> .....	<b>2</b>
<b>1.4 About the camera</b> .....	<b>3</b>
1.4.1 Front view .....	3
1.4.2 Top view .....	3
1.4.3 Bottom view .....	4
1.4.4 Right view .....	4
1.4.5 Left view .....	5
1.4.6 Back view .....	5
1.4.7 Adjusting the LCD display .....	6
About the LED .....	10
<b>2 Getting started</b> .....	<b>11</b>
<b>2.1 Inserting an SD card</b> .....	<b>11</b>
<b>2.2 Inserting the batteries</b> .....	<b>13</b>
<b>2.3 Charging the battery</b> .....	<b>14</b>
<b>2.4 Turning on the video camera</b> .....	<b>16</b>

<b>2.5</b>	<b><i>Changing modes</i></b> .....	<b>16</b>
<b>2.6</b>	<b><i>Before you start</i></b> .....	<b>17</b>
2.6.1	Setting the date and time .....	17
2.6.2	Setting the language .....	18
2.6.3	Setting the beep.....	19
<b>2.7</b>	<b><i>Shoot/Playback video</i></b> .....	<b>20</b>
2.7.1	Shooting a video clip .....	20
2.7.2	Playing the video clip.....	22
<b>2.8</b>	<b><i>Taking/ viewing pictures</i></b> .....	<b>23</b>
2.8.1	Taking a still picture.....	23
2.8.2	Viewing images.....	24
<b>2.9</b>	<b><i>Connecting to a computer</i></b> .....	<b>25</b>
<b>2.10</b>	<b><i>Connecting to a standard TV</i></b> .....	<b>25</b>
<b>2.11</b>	<b><i>Connecting to a HDTV</i></b> .....	<b>26</b>
<b>3</b>	<b>Using the camera</b> .....	<b>27</b>
<b>3.1</b>	<b><i>Movie and voice recorder mode</i></b> .....	<b>27</b>
3.1.1	Movie and voice recorder mode .....	27
3.1.2	Using the macro function .....	29
3.1.3	Using the zoom function.....	29
3.1.4	Using the LED flashlight.....	29
3.1.5	Quick access controls .....	29
<b>3.2</b>	<b><i>Photo mode</i></b> .....	<b>30</b>
3.2.1	Photo mode icons.....	30
3.2.2	Using the macro function .....	31
3.2.3	Using the zoom function.....	31

3.2.4	Using the LED flashlight.....	31
3.2.5	Quick access controls .....	31
<b>3.3</b>	<b><i>Movie Playback mode</i></b> .....	<b>32</b>
3.3.1	Movie Playback mode icons.....	32
<b>3.4</b>	<b><i>Photo Playback mode</i></b> .....	<b>35</b>
3.4.1	Photo Playback mode icons.....	35
<b>3.5</b>	<b><i>Thumbnail mode</i></b> .....	<b>37</b>
<b>3.6</b>	<b><i>USB mode</i></b> .....	<b>37</b>
<b>4</b>	<b>Using the menus .....</b>	<b>38</b>
<b>4.1</b>	<b><i>Movie menu</i></b> .....	<b>38</b>
4.1.1.	White balance .....	38
4.1.2.	Video resolution.....	39
4.1.3.	Color effect .....	40
4.1.4.	Night mode.....	41
4.1.5.	Capture mode.....	42
<b>4.2</b>	<b><i>Movie playback menu</i></b> .....	<b>43</b>
4.2.1	Delete.....	43
4.2.2	Protect .....	45
<b>4.3</b>	<b><i>Photo menu</i></b> .....	<b>46</b>
4.3.1	White balance .....	46
4.3.2	Resolution .....	47
4.3.3	Color effect .....	48
4.3.4	Night mode.....	49
4.3.5	Self-timer.....	50
<b>4.4</b>	<b><i>Photo playback menu</i></b> .....	<b>51</b>

4.4.1	Delete.....	51
4.4.2	Protect .....	53
4.4.3	Slide show .....	54
4.4.4	DPOF .....	55
<b>4.5</b>	<b><i>System menu</i>.....</b>	<b>56</b>
4.5.1	Setting the beep.....	56
4.5.2	Histogram Mode.....	56
4.5.3	Auto power off.....	57
4.5.4	TV standard.....	58
4.5.5	Format .....	59
4.5.6	Default.....	60
4.5.7	Language .....	60
4.5.8	Frequency .....	61
4.5.9	Date/time .....	61
<b>5</b>	<b>Installing the software .....</b>	<b>62</b>
5.1	<i>Presto! VideoWorks</i> .....	62
5.2	<i>Presto! Mr. Photo</i> .....	63
5.3	<i>QuickTime</i> .....	64
<b>Appendix</b> .....		<b>65</b>
	<i>Specifications</i> .....	65
	<i>Troubleshooting</i> .....	68

# Preface

---

Congratulations on your purchase of this advanced video camera. Ensure that you read this manual carefully and keep it in a safe place for future reference.

## About this manual

Every effort has been made to ensure that the contents of this manual are correct and up to date. However, no guarantee is made regarding the accuracy of the contents. If the contents of this manual do not tally with the camera, please take the camera as a criterion. We reserve the right to change the contents of this manual and specifications of the product without prior notice.

If the accessories do not tally with the actual package, please take the actual package as the criterion.

## Copyright

© Copyright 2008.

All rights reserved. No part of this publication may be reproduced, transmitted, transcribed, stored in a retrieval system or translated into any language or computer language, in any form or by any means, electronic, mechanical, magnetic, optical, manual or otherwise, without the prior written permission of the manufacturer.

# Precautions

## General precautions

- Do not use or store the product in dusty, dirty, or sandy areas, as its components may be damaged.
- Do not store the product in a hot environment. High temperatures can shorten the life of electronic devices, damage batteries and warp or melt certain plastics.
- Do not store the product in cold areas. When the product warms up to its normal temperature, moisture can form inside that may damage the electronic circuits.
- Do not attempt to open the casing or attempt your own repairs. High-voltage internal components create the risk of electric shock when exposed.
- Do not drop or knock the product. Rough handling may damage the internal components.
- Do not use harsh chemicals, cleaning solvents or strong detergents to clean the product. Wipe the product with a slightly damp soft cloth.
- Do not fire the flash while it is too close to the subject's eyes. Intense light from the flash can cause eye damage if it is fired too close to the eyes. When using the flash, the camera should be at least one meter from the eyes of the subject.
- Do not open the battery cover while an image is being recorded. Doing so will not only make storage of the current image impossible, it can also corrupt other image data already stored in file.
- If the product or any of its accessories are not working properly, take them to your nearest qualified service center. The personnel there will assist you and if necessary, arrange for the product to be repaired.



- Test for proper operation before using the camera.

## Notes on the LCD Screen

Caution must be observed when dealing with the fluid contained in the LCD. Ensure that fluid does not leak if the screen becomes cracked or damaged. If this occurs, follow these steps:

- If the fluids make contact with skin, wipe it with a clean cloth then rinse with a large amount of water.
- If the fluid makes contact with eyes, wash eyes with clean water for at least 15 minutes and seek immediate medical attention.
- If the fluid is swallowed, first rinse mouth with water, then drink a large amount of water and induce vomiting. Seek immediately medical attention

## Operation conditions

- This camera is designed for use in temperatures ranging from 0°C to 40°C (32°F to 104°F).
- Do not use or keep the camera in the following areas:
  - In areas subject to direct sunlight
  - In areas subject to high humidity or dust
  - Near air conditioners, heaters, or other areas subject to temperature extremes
  - Inside of a closed vehicle, especially one parked in the sun.
  - In areas subject to strong vibration

## Power supply

- Use only the type of battery that came with your camera. Using any other type of battery may damage the equipment and invalidate the warranty.

- Ensure the battery is inserted correctly. Inserting the battery incorrectly can cause damage to the product and possibly start a fire.
- Remove the battery to avoid the fluid leakage if the camera is not going to be used for a long time.
- If the battery is crushed or damaged, remove it immediately to avoid the battery fluid leakage and abnormal expansion.

## **Before You Start**

Take some test shots before performing a formal recording.

Before taking pictures with this DV camera in any important occasion (such as a wedding ceremony or an overseas trip), do test the DV camera beforehand to ensure that it functions properly. Any additional loss caused by the malfunction of this product (such as costs of photography or any loss of benefit generated by the photography) is not the responsibility of the manufacturer and no compensation will be given for it.

### **Copyright information**

Take care to observe "No Photography" notices in certain locations. In these cases, you cannot record any live performance, improvisation or exhibits, even for personal purposes. Any transfer of pictures or memory card data must be conducted under the constraints of copyright law.

# 1 Introducing the camera

---

Read this section to learn about the features and functions of the video camera. This chapter also covers system requirements, package contents, and descriptions of the hardware components.

## 1.1 System requirements

The video camera requires a PC with the following specifications:

- Windows® Vista / XP / 2000 operating system
- Intel® Pentium 4 2.8GHz CPU or higher
- At least 512 MB of RAM or higher
- Standard USB 1.1 port or higher
- At least 64MB or greater video card

**Note:** A USB 1.1 port will enable you to transfer files to and from your host PC, but transfer speeds will be much faster with a USB 2.0 port.

## 1.2 Features

The video camera offers a variety of features and functions including:

- High-Definition Digital camcorder
- Digital Camera (max. 8 Megapixel)

Additionally, the camera also features 2X digital zoom, and voice recorder function.

## 1.3 Unpacking the video camera

The following items should be present in the package. If any item is missing or appears damaged, contact your dealer immediately.



**Video camera**



**User manual**



**CD-ROM  
(Application software)**



**USB cable**



**AV cable**



**Component  
Video cable**



**Battery charger**

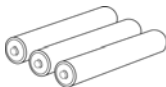

**AAA batteries**

## 1.4 About the camera

Refer to the following illustrations to familiarize yourself with the buttons and controls of this video camera.

### 1.4.1 Front view

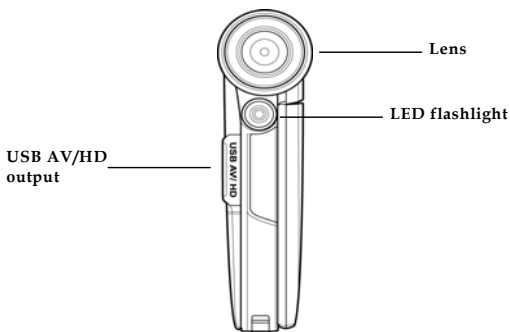

### 1.4.2 Top view

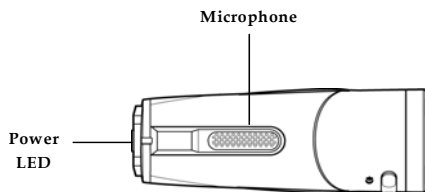

### 1.4.3 Bottom view

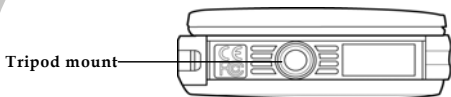

### 1.4.4 Right view

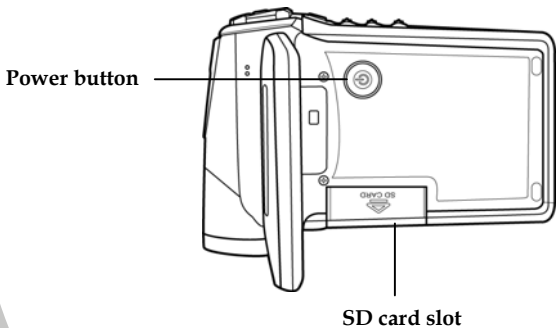

## 1.4.5 Left view

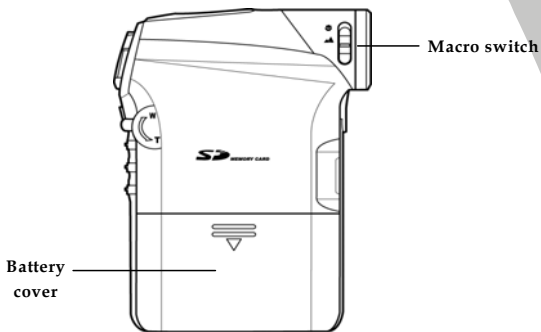

## 1.4.6 Back view

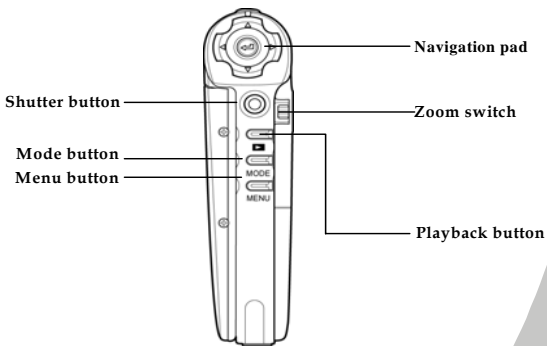

## 1.4.7 Adjusting the LCD display



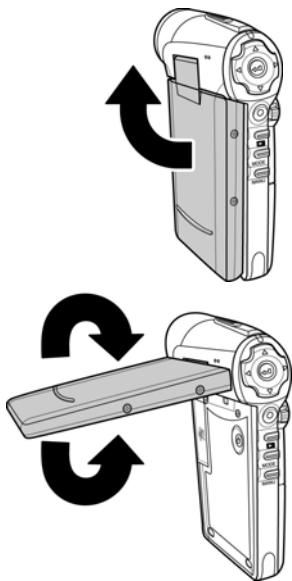

Flip and twist the LCD screen as shown while capturing a still image or recording a video clip.

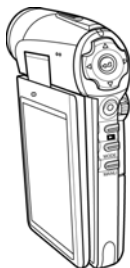
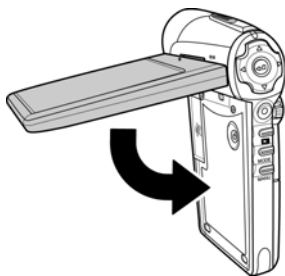
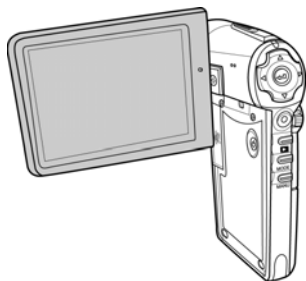









See the table below for a description of each button's function.

Button	Name	Function
	Power button	Press and hold to turn power on/ off.
 MENU	Menu button	Press to display main OSD menus.
 MODE	Mode button	Press to select <b>Movie</b> , <b>Photo</b> , and <b>Setup</b> modes.
	Navigation pad	<ul style="list-style-type: none"> <li>● In <b>Movie</b> and <b>Photo</b> modes, press up/ down on the Navigation pad to adjust the exposure setting, and press the center key of the Navigation pad to turn on LED flashlight.</li> <li>● In <b>Movie Playback</b> mode, press the center key of the Navigation pad to play the stored video files, and press again to stop.</li> <li>● In <b>Photo Playback</b> mode, press up/ down/ left/ right on the Navigation pad to view an image.</li> <li>● In <b>Setup</b> mode, press up/ down on the Navigation pad to highlight menu items, and press the center key of the Navigation pad to select.</li> </ul>
	Shutter button	<ul style="list-style-type: none"> <li>● In <b>Movie</b> mode, press to start recording a video clip.</li> </ul>

		<ul style="list-style-type: none"> <li>● In <b>Movie Playback</b> mode, press to pause playing, and press again to continue playing.</li> <li>● In <b>Photo</b> mode, press to take a picture.</li> </ul>
	Macro switch	Move the switch up to the  position to enable <b>Macro</b> mode.
	Playback button	In <b>Photo</b> and <b>Movie</b> mode, press to playback recorded files.
	Zoom switch	<ul style="list-style-type: none"> <li>● In <b>Movie</b> and <b>Photo</b> modes, slide the switch up/ down to zoom in/ out while shooting a video or taking a picture.</li> <li>● In <b>Movie Playback</b> mode: <ol style="list-style-type: none"> <li>1. Slide up/ down to adjust volume when playing a video.</li> <li>2. Press the switch to bottom to show all stored files in a 3x2 matrix thumbnail view.</li> </ol> </li> <li>● In <b>Photo Playback</b> mode: <ol style="list-style-type: none"> <li>1. Slide up to enlarge image size.</li> <li>2. Slide down to display all stored files in a 3x2 matrix thumbnail view.</li> </ol> </li> </ul>

## About the LED

The following table describes the camera LED:

LED	Color	Definition
Power	Green	Power-on
	Green Blinking	Recording
	Red	Camera busy
	Red Blinking	Self-timer is activated
	Red Blinking Rapidly	2 seconds self-timer remaining.
Self-timer	Red Blinking	Self-timer is activated.
	Red Blinking Rapidly	2 seconds self-timer remaining.

## 2 Getting started

---

Read this section to learn how to start using the video camera. This section covers basic functions such as switching on, inserting the battery and memory cards, and configuring preliminary settings. See later chapters for advanced functions.

### 2.1 Inserting an SD card

An SD card can be installed in the video camera to provide additional storage space for still images, video clips, or other files. *(SD card sold separately)*

1. Press down on the SD card slot cover and slide out to open.

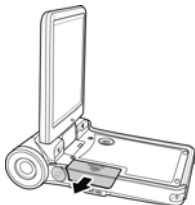

2. Insert an SD card, making sure the contacts are facing downwards.

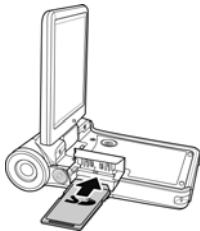

3. Lower and press the SD card slot cover into place.

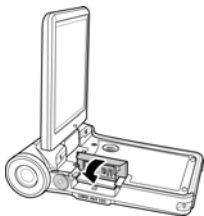

## 2.2 Inserting the batteries

**Note:** Install the battery exactly as described here. Ensure that the polarity of the batteries is correct. Installing the batteries incorrectly could cause damage to the video camera and possibly start a fire.

1. Slide off the battery cover.



2. Insert the three AAA-type batteries as shown.



3. Slide back the battery cover.



## 2.3 Charging the battery

You can charge batteries with the charging unit provided. The battery charger can charge AA/AAA batteries at a time.

1. Insert your batteries into the battery charger unit, making sure the polarity of the battery is correct.

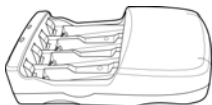

2. Insert the three AAA-type batteries as shown.

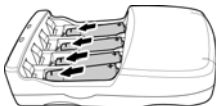

3. Pull the plug up and plug into a wall outlet.

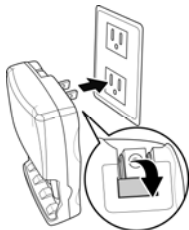



**Note:**

1. Insert 2 or 4 AA/AAA rechargeable Ni-Cd/Ni-MH batteries into the battery compartment; battery must be charged in pairs.
2. The LEDs green during standby and red while charging. When charging finished, the LEDs turn green.
3. Do not charge longer, overcharging may cause damage to the charger and battery.

## 2.4 Turning on the video camera

Press and hold the power button to turn the video camera on/off.

## 2.5 Changing modes

The video camera can operate in three modes, **Movie**, **Photo**, and **Setup**. Press the **Mode** button to select different modes.

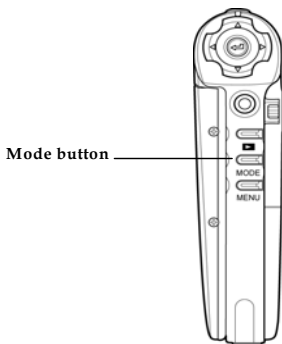

## 2.6 Before you start

Before you start using the video camera, some basic settings such as date and time, languages and beep function need to be configured.

### 2.6.1 Setting the date and time



4. Turn on the video camera, and press the mode button to **Setup**. Press up/ down on the Navigation pad to highlight **Date / Time**. Press the **center key** of the Navigation pad to confirm.

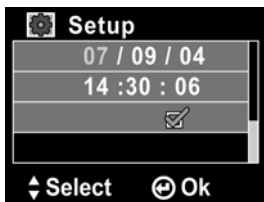

5. Press up/ down on the Navigation pad to highlight each field and press the **center key** of the Navigation pad to select a field.
6. Adjust each value by pressing up or down on the Navigation pad. Press the **center key** of the Navigation pad to save your changes.

7. Press down on the Navigation pad to highlight the  $\surd$  to leave the date/ time menu.

## 2.6.2 Setting the language

1. Turn on the video camera, and press the **Mode** button to **Setup**. Press up/ down on the Navigation pad to highlight **Language**. Press the **center key** of the Navigation pad to select.

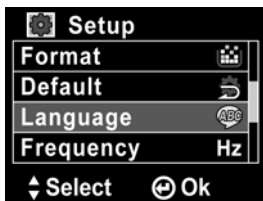

2. Press up/ down on the Navigation pad to select the following languages: **English, Traditional Chinese, Simplified Chinese, German, Italian, Spanish, French, Turkish, Portuguese, Dutch, Japanese, Russian, Korean, and Arabic**. After the language is selected, press the **center key** of the Navigation pad to confirm.

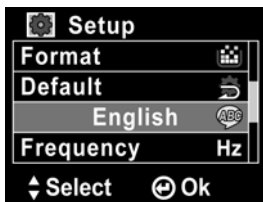

### 2.6.3 Setting the beep

1. Turn on the video camera, and Press the Navigation pad to **Setup**. Press up/ down on the Navigation pad to highlight **Beep**. Press the **center key** of the Navigation pad to confirm.



2. Press up/ down on the Navigation pad to select the ✓, and press the **center key** of the Navigation pad to exit.



## 2.7 Shoot/Playback video

### 2.7.1 Shooting a video clip



1. Turn on the video camera and press the **mode** button to **Movie** mode.



2. Use the LCD screen to frame the video.
3. Press the **Shutter** button to start recording.
4. Press the **Shutter** button again to stop recording.
5. The video clip is automatically saved with a unique file name.

**Notes:**

1. The maximum length of each video recording file is 2GB.
2. The high-resolution settings result in larger files.
3. The LCD preview ratio will vary depending on the different video resolution settings. See the following table:

<i>Video resolution</i>	Preview
HD (1280 x 720)	<i>16:9 ratio</i> 
D1 (720 x 480)	<i>4:3 ratio</i> 
CIF (352 x 240)	

## 2.7.2 Playing the video clip

1. In **Movie** mode, press the **Playback** button and the most recent file displays on the LCD screen.

Movie playback  
mode indicator



2. Press up or down on the **Navigation pad** to scroll through the video clips. Press the **center key** of the Navigation pad to play back the video clip.
3. When viewing the video clip, slide the **Zoom** switch **up** or **down** to adjust the volume.
4. Press the **Shutter** button to pause playing, and press again to continue playing.
5. Press the **center key** of the Navigation pad to stop playing.
6. Press the **Playback** button again to return to **Movie** mode.



## 2.8 Taking/ viewing pictures

### 2.8.1 Taking a still picture

1. Turn on the camera and press the mode button to **Photo** mode.
2. Use the LCD screen to frame the picture.
3. Press the **Shutter** button to capture the image.



4. The picture is automatically saved with a unique file name.

## 2.8.2 Viewing images

1. In **Photo** mode, press the **Playback** button and the most recent image displays on the LCD screen.

Playback mode



2. Press **up** or **down** on the **Navigation pad** to scroll through the images.
3. Slide the **Zoom** switch **up** to zoom in the picture. Then you can move the image up/down or left/right by the **Navigation pad**.
4. Slide the **Zoom** switch **down** fully to view thumbnails of all stored files and then press the **Navigation pad** to select the thumbnail images.
5. Press the **center key** of the **Navigation pad** to view the image in full screen mode.
6. Press the **Playback** button again to return to **Photo** mode.

## 2.9 Connecting to a computer

Read this section to learn how to transfer files to a PC, show the video clips or photos on TV/DVD.

Connect the video camera to a computer with the USB cable provided.

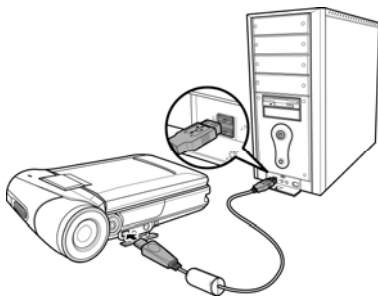

## 2.10 Connecting to a standard TV

Connect the video camera to a standard TV as shown with the AV cable provided.

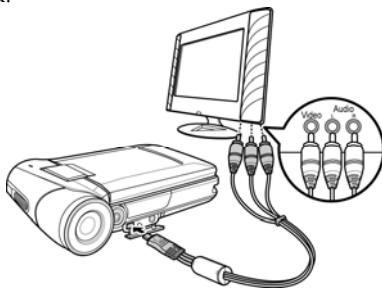

## 2.11 Connecting to a HDTV

Read this section to learn how to show the video clips or photos on a HDTV. Connecting to a HDTV offers the high resolution for displaying the video clips or photos.

Connect the video camera to a HD TV as shown with the component video cable and AV cable provided.

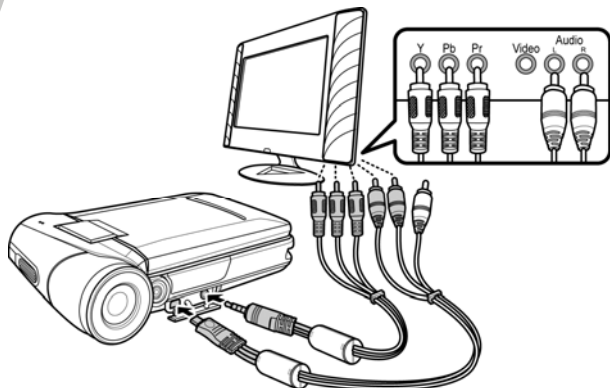

## 3 Using the camera

Read this section to learn how to use the camera.

### 3.1 Movie and voice recorder mode

Use this mode to capture video clips or record voice and store them in an internal memory or on an SD card.

#### 3.1.1 Movie and voice recorder mode



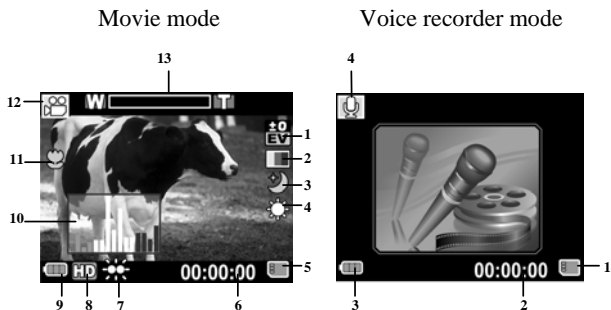









Use the following picture to familiarize yourself with the **Movie and voice recorder mode** icons and symbols.



#### Movie mode:





See the table below for a description of each icon and symbol.

1		EV compensation indicator
2		Effect indicator

3		Night mode indicator
4		White balance indicator
5		Memory status indicator  : SD card indicator  : Internal memory indicator
6	00:00:00	Remaining recording time indicator
7		LED flashlight indicator
8		Resolution indicator
9		Battery indicator
10		Histogram indicator
11		Macro indicator
12		Movie mode indicator
13		Zoom indicator

### Voice recorder mode:

See the table below for a description of each icon and symbol.

1		Memory status indicator  : SD card indicator  : Internal memory indicator
2	00:00:00	Remaining recording time indicator
3		Battery indicator



### 3.1.2 Using the macro function

This function can capture subjects close to the lens. In macro mode, subjects can be as close as 15-16 cm.

While in **Photo** or **Movie and voice recorder** modes, move the **Macro** switch **up** to activate macro function, and an icon  displays on the LCD screen.

Move the macro button **down** to return to normal mode.

### 3.1.3 Using the zoom function

The camera is equipped with 2x digital zoom.

Slide the zoom switch **up** to get closer to a subject.

Slide the zoom switch **down** to move away from a subject.

### 3.1.4 Using the LED flashlight

Use the LED flashlight to illuminate subjects in dark environments.

In **Movie** and **Photo** modes, press the center key of the Navigation pad to turn the LED flashlight on. An icon displays on the screen when activated.

### 3.1.5 Quick access controls

You can also make adjustments to exposure and lighting settings by pressing up or down on the Navigation pad.

In **Movie and voice recorder** and **Photo** modes, move up or down on the Navigation pad to adjust the EV compensation setting.

## 3.2 Photo mode

Use **Photo** mode to capture still pictures and store them in the internal memory or on an SD card.

### 3.2.1 Photo mode icons











Use the following picture to familiarize yourself with the **Photo** mode icons and symbols.



See the table below for a description of each icon and symbol.

1	<b>0003</b>	Remaining number of photos
2	<b>±0 EV</b>	EV compensation indicator
3		Effect indicator
4		Night mode indicator
5		White balance indicator



6		Memory status indicator  : SD card indicator  : Internal memory indicator
7		LED flashlight indicator
8		File size indicator
9		Battery indicator
10		Histogram indicator
11		Macro indicator
12		Self timer indicator
13		Photo mode indicator
14		Zoom indicator

### 3.2.2 Using the macro function

See section 3.1.2 “Using the macro function”.

### 3.2.3 Using the zoom function

See section 3.1.3 “Using the zoom function”.

### 3.2.4 Using the LED flashlight

See section 3.1.4 “Using the LED flashlight”.

### 3.2.5 Quick access controls

See section 3.1.5 “Quick access controls”.

## 3.3 Movie Playback mode

Use **Movie Playback** mode to review all the movie files stored in the video camera.

### 3.3.1 Movie Playback mode icons



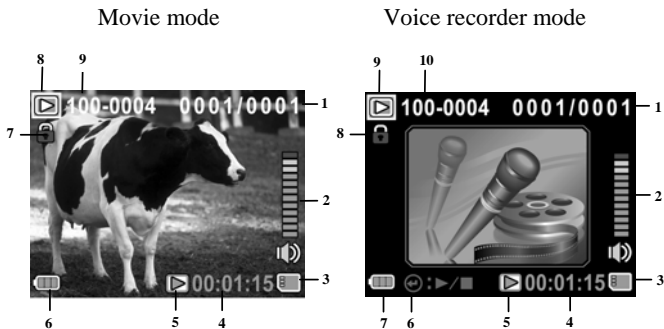



Refer to the following picture to familiarize yourself with the **Movie Playback** mode icons and symbols.



#### Movie mode:







See the table below for a description of each icon and symbol.



1	<b>0001/0001</b>	Displays the number of current movie / total number of recorded video clips
2		Volume level

3		Memory status indicator  : SD card indicator  : Internal memory indicator
4	00:00:00	The length of every video clip
5		Play/ Pause indicator
6		Battery status indicator
7		File protect indicator
8		Movie playback mode icon
9	100-0001	Displays the file number of the video clip

### Voice Recorder mode:

See the table below for a description of each icon and symbol.

1	0001/0001	Displays the number of current audio/ total number of recorded audio clips
2		Volume level
3		Memory status indicator  : SD card indicator  : Internal memory indicator
4	00:00:00	The length of every audio clip
5		Play/Pause indicator
6		Indicates: press to Play/ Stop

7		Battery status indicator
8		File protect indicator
9		Voice playback mode
10	<b>100-0001</b>	Displays the file number of the audio clip

## 3.4 Photo Playback mode



Use **Photo Playback** mode to review all the image files stored in the video camera.





### 3.4.1 Photo Playback mode icons

Refer to the following picture to familiarize yourself with the **Photo Playback** mode icons and symbols.



See the table below for a description of each icon and symbol.

1	0001/0001	Displays the number of current image / the total number of saved images
2		Memory status indicator  : SD card indicator  : Internal memory indicator
3	100-0001	Displays the file number of the photo

4		Battery status indicator
5		File protect indicator
6		Playback mode icon
7		DPOF (Digital Print Order Format) indicator

## 3.5 Thumbnail mode

When in **Movie Playback** or **Photo Playback** modes, press the zoom switch **down** to show images as thumbnails.

1. Turn on the video camera and make sure it is in **Movie Playback** or **Photo Playback** mode.
2. The most recent video clip/ image displays on the screen. Slide the zoom switch **down** to view **six** thumbnail video clips/ images on the LCD screen.

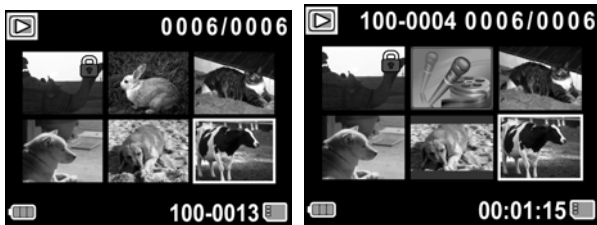

3. Press the Navigation pad **up** and **down** to highlight a video clip, or an image, and press the **center key** of the Navigation pad to playback the video clip or voice file or view the image in full screen.
4. Slide the zoom switch down to return to thumbnail mode.

## 3.6 USB mode

You can use USB mode to connect to a host PC.

When connect to a host PC, the video camera displays as a removable drive in Windows Explorer.

## 4 Using the menus

---

Read this section to learn how to configure the camera settings and use the advanced features.

### 4.1 Movie menu

When in **Movie** mode, press the **MENU** button to show the Movie options menu.

#### 4.1.1. White balance

Use this option to correct color difference for different lighting conditions. When white balance is set to **Auto**, the video camera automatically compensates for different lighting conditions.

1. Turn the video camera on and ensure it is in **Movie** mode.
2. Press the **MENU** button and use the Navigation pad to highlight the **White Balance** option. Press the center key of the Navigation pad to display the submenu.



3. Press the Navigation pad to select **Auto**, **Sunny**, **Cloudy**, **Tungsten**, or **Fluorescent**. Press the center key of the Navigation pad to confirm.
4. Press the **MENU** button again to exit the menu.



### 4.1.2. Video resolution

Use the resolution option to determine the resolution of the captured video. The larger screen size requires more memory storage space.

1. Turn the video camera on and ensure it is in **Movie** mode.
2. Press the **MENU** button and use the Navigation pad to highlight the **Resolution** option. Press the center key of the Navigation pad to display the submenu.

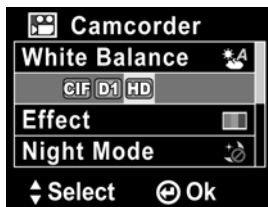
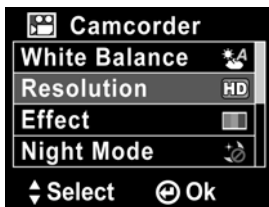

3. Press the Navigation pad to select **CIF**, **D1** or **HD**. Press the center key of the Navigation pad to confirm.
4. Press the **MENU** button again to exit the menu.

#### Notes:

1. The LCD displays the 16:9 ratio while setting as HD video resolution.
2. The LCD displays the 4:3 ratio while setting as D1 or CIF video resolution.

### 4.1.3. Color effect

The camera can capture standard color images, black and white images, or sepia tone to give an old-fashioned look.

1. Turn the video camera on and ensure it is in **Movie** mode.
2. Press the **MENU** button and use the Navigation pad to highlight the **Effect** option. Press the center key of the Navigation pad to display the submenu.

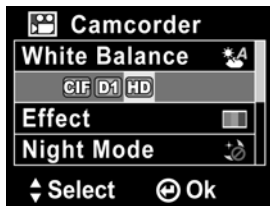
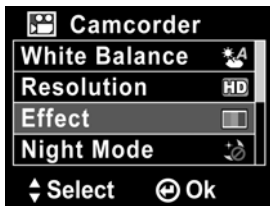

3. Press the Navigation pad to select **Color**, **B&W** or **Sepia**. Press the center key of the Navigation pad to confirm.
4. Press the **MENU** button again to exit the menu.

### 4.1.4. Night mode

Use this function to shoot a better video clip quality in dark environments.

1. Turn the video camera on and ensure it is in **Movie** mode.
2. Press the **MENU** button and use the Navigation pad to highlight the **Night Mode** option. Press the center key of the Navigation pad to display the submenu.

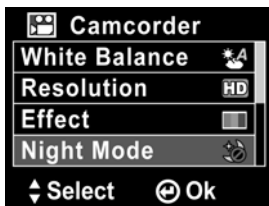

3. Press the Navigation pad to select **Off** or **Night mode** option. Press the center key of the Navigation pad to confirm.
4. Press the **MENU** button again to exit the menu.

## 4.1.5. Capture mode

Use this function to record sound or image.

1. Turn the video camera on and ensure it is in **Movie** mode.
2. Press the **MENU** button and use the Navigation pad to highlight the **Capture Mode** option. Press the center key of the Navigation pad to display the submenu.

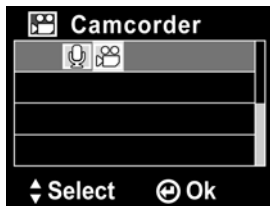
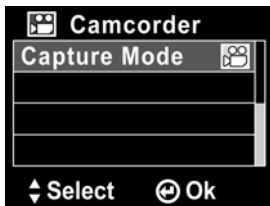

3. Press the Navigation pad to select **Voice recorder** or **Video** options. Press the center key of the Navigation pad to confirm.
4. Press the **MENU** button again to exit the menu.

## 4.2 Movie playback menu

Use the playback menu to manage the files stored in the internal memory or on the SD card.

### 4.2.1 Delete

Use this function to delete files.

1. Turn the video camera on and ensure it is in **Movie** mode. Press the **Playback** button and then press the **MENU** button to display the **Movie Playback** menu.
2. Press the Navigation pad to select **Delete One** or **Delete All** options.

If you select **Delete One**, the playback screen appears again. Press the Navigation pad to locate the file you want to delete and press the center key of the Navigation pad to delete.



If you select **Delete All**, press the center key of the Navigation pad to display the submenu.



3. Press the Navigation pad to select ✓ and press the center key of the Navigation pad to delete.



4. Press the **MENU** button again to exit the menu.

**Note:** Once deleted, files cannot be recovered so make sure you have a backup before you delete. Files that have been protected will not be deleted. You have to unlock the files first before deleting them.

## 4.2.2 Protect

Use this function to lock files to prevent accidental deletion.

1. Turn the video camera on and ensure it is in **Movie** mode. Press the **Playback** button and then press the **MENU** button to display the **Movie Playback** menu.
2. Press the Navigation pad to select the **PROTECT** option. Then playback screen appears again. Press the Navigation pad to locate the file you want to protect and press the center key of the Navigation pad to confirm. A lock  icon is displayed to show that the file is protected.



**Note:** To unlock a file, repeat the above steps. The lock icon  disappears when the file is unlocked.

3. Press the **MENU** button again to exit the menu.

## 4.3 Photo menu

In **Photo** mode, press the **MENU** button to show the Photo Options menu.

### 4.3.1 White balance

Use this option to correct color difference due to lighting conditions.

1. Turn the video camera on and ensure it is in **Photo** mode.
2. Press the **MENU** button and use the Navigation pad to highlight the **White Balance** option. Press the center key of the Navigation pad to display the submenu.
3. Press the Navigation pad to select **Auto**, **Sunny**, **Cloudy**, **Tungsten**, or **Fluorescent**. Press the center key of the Navigation pad to confirm.

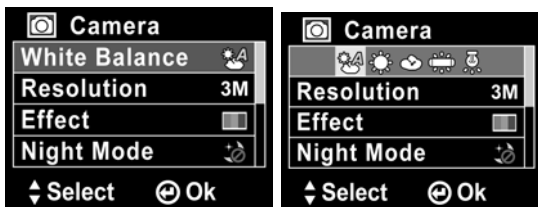

4. Press the **MENU** button again to exit the menu.



## 4.3.2 Resolution

Use this option to set the size of the captured image. Larger images contain more detail and therefore use more memory space.

1. Turn the video camera on and ensure it is in **Photo** mode.
2. Press the **MENU** button and use the Navigation pad to highlight the **Resolution** option. Press the center key of the Navigation pad to display the submenu.
3. Press the Navigation pad to select from **3M**, **5M** or **8M**. Press the center key of the Navigation pad to confirm.



4. Press the **MENU** button again to exit the menu.

### 4.3.3 Color effect

The camera can capture standard color images, black and white images, or sepia tone to give an old-fashioned look.

1. Turn the video camera on and ensure it is in **Photo** mode.
2. Press the **MENU** button and use the Navigation pad to highlight the **Effect** option. Press the center key of the Navigation pad to display the submenu.
3. Press the Navigation pad to select **Color**, **B & W**, or **Sepia**. Press the center key of the Navigation pad to confirm.



4. Press the **MENU** button again to exit the menu.

### 4.3.4 Night mode

Use this function to shoot a better video clip quality in dark environments.

1. Turn the video camera on and ensure it is in **Photo** mode.
2. Press the **MENU** button and use the Navigation pad to highlight the **Night Mode** option. Press the center key of the Navigation pad to display the submenu.
3. Press the Navigation pad to select **Off** or **Night mode** option. Press the center key of the Navigation pad to confirm.



4. Press the **MENU** button again to exit the menu.

### 4.3.5 Self-timer

Use the self-timer function to take a photo of yourself.

1. Turn the video camera on and ensure it is in **Photo** mode.
2. Press the **MENU** button and use the Navigation pad to highlight the **Selftimer** option. Press the center key of the Navigation pad to display the submenu.
3. Press the Navigation pad to select **Off**, **5 seconds**, or **10 seconds** options. Press the center key of the Navigation pad to confirm.



4. Press the **MENU** button again to exit the menu.

## 4.4 Photo playback menu

Use the playback menu to manage the files stored in the internal memory or on the SD card.

### 4.4.1 Delete

Use this function to delete files.

1. Turn the video camera on and ensure it is in **Photo** mode. Press the **Playback** button and then press the **MENU** button to display the **Photo Playback** menu.
2. Press the Navigation pad to select the **Delete One** or **Delete All** options.

If you select **Delete One**, the playback screen appears again. Press the Navigation pad to locate the file you want to delete and press the center key of the Navigation pad to delete.



If you select **Delete All**, press the center key of the Navigation pad to display the submenu.



3. Press the Navigation pad to select  $\sqrt{\phantom{x}}$  and then press the center key of the Navigation pad to delete.



4. Press the **MENU** button again to exit the menu.

**Note:** Once deleted, files cannot be recovered so make sure you have a backup before you delete. Files that have been protected will not be deleted. You have to unlock the files first before deleting them.

## 4.4.2 Protect

Use this function to protect files from accidental deletion.

1. Turn the video camera on and ensure it is in **Photo** mode. Press the **Playback** button and then press the **MENU** button to display the **Photo Playback** menu.
2. Press the Navigation pad to select the **PROTECT** option. Then playback screen appears again. Press the Navigation pad to locate the file you want to protect and press the center key of the Navigation pad to confirm. A lock  icon is displayed to show that the file is protected.



**Note:** To unlock a file, repeat the above steps. The lock icon  disappears when the file is unlocked.

3. Press the **MENU** button again to exit the menu.

### 4.4.3 Slide show

The camera includes a slide show function, which displays each image in turn with a regular interval between pictures.

1. Turn the video camera on and ensure it is in **Photo** mode. Press the **Playback** button and then press the **MENU** button to display the **Photo Playback** menu.
2. Press the Navigation pad to select the **AUTOPLAY** option and press the center key of the Navigation pad. The images will be displayed automatically.



3. Press the **Menu** button to stop the slide show.



#### 4.4.4 DPOF

Use the DPOF (Digital Print Order Format) function to tag pictures stored in the memory card with print information.

1. Turn the video camera on and ensure it is in **Photo** mode. Press the **Playback** button and then press the **MENU** button to display the **Photo Playback** menu.
2. Press the Navigation pad to highlight **DPOF** option, and press the center key to display the submenu.



3. Press the Navigation pad to select  $\surd$  and press the center key of the Navigation pad to confirm. Press the **MENU** button to return. A **DPOF**  icon displayed to show the file is ordered to print.



4. Press the **Playback** button again to exit the image.

- Notes:** 1. A memory card is required for DPOF function.  
2. If DPOF is set, all photos are ordered to print.

## 4.5 System menu

The system menu is used to configure miscellaneous camera functions.

### 4.5.1 Setting the beep

See section 2.6.3 "Setting the Beep".

### 4.5.2 Histogram Mode

Use this function to display a histogram graph on LCD screen. This function can help you to capture a better photo/video clip.

1. Turn on the video camera and switch to **Setup** mode.
2. Press the Navigation pad to highlight the **Histogram** option. Press the center key of the Navigation pad to display the submenu.
3. Press the Navigation pad to select **Histogram** or **Off** options. Press the center key of the Navigation pad to confirm.



### 4.5.3 Auto power off

Use this function to switch the camera off automatically after a period of inactivity for power saving.

1. Turn on the video camera and switch to **Setup** mode.
2. Press the Navigation pad to highlight the **Auto Power Off** option. Press the center key of the Navigation pad to display the submenu.
3. Press the Navigation pad to select **Off**, **1 minute**, or **5 minutes**. Press the center key of the Navigation pad to confirm.



#### 4.5.4 TV standard

Use the TV option to set the TV system for the area.

1. Turn on the video camera and switch to **Setup** mode.
2. Press the Navigation pad to highlight the **TV standard** option. Press the center key of the Navigation pad to display the submenu.
3. Press the Navigation pad to select **NTSC** or **PAL**, and press the center key of the Navigation pad to confirm.



## 4.5.5 Format

Use this function to format the current storage media. This format action will delete everything on the media.

1. Turn on the video camera and switch to **Setup** mode.
2. Press the Navigation pad to highlight the **Format** option. Press the center key of the Navigation pad to display the submenu.
3. Press the Navigation pad to select **X** or **√**, and press the center key of the Navigation pad to confirm.

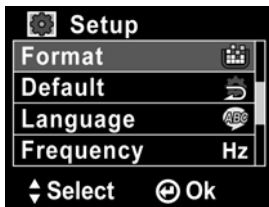

4. The current media (internal memory or memory card) is formatted.

## 4.5.6 Default

Use this option to reset all settings to the default settings.

1. Turn on the video camera and switch to **Setup** mode.
2. Press the Navigation pad to highlight the **Default** option. Press the center key of the Navigation pad to display the submenu.
3. Press the Navigation pad to select **X** or **√**, and press the center key of the Navigation pad to confirm.

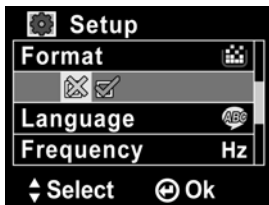
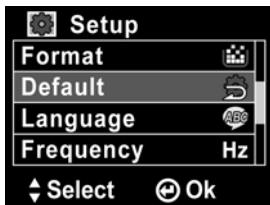

## 4.5.7 Language

See section 2.6.2 "Setting the language".

## 4.5.8 Frequency

Use the Frequency option to set the frequency system for your area.

To set the frequency:

4. Turn on the video camera and switch to **Setup** mode.
5. Press the Navigation pad to highlight the **Frequency** option. Press the center key of the Navigation pad to display the submenu.
6. Press the Navigation pad to select **50 Hz or 60 Hz**. Press the center key of the Navigation pad to confirm.

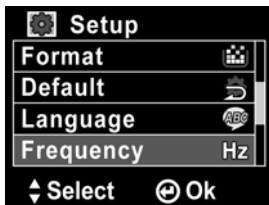

## 4.5.9 Date/time

See section 2.6.1 "Setting the date and time".

## 5 Installing the software

---

Read this section to learn how to install the software for the camera.

### 5.1 Presto! VideoWorks

Presto! VideoWorks is an advanced software application for editing video.

To install Presto! VideoWorks:

1. Insert the supplied CD into the CD-ROM drive.
2. If the CD-ROM does not automatically boot, use Windows Explorer to execute the **InstallMgr.exe** file in the root directory.

The following screen is displayed.



Install button

3. Click the **Install** button to begin the installation process and follow the instructions on-screen.

More information about Presto! VideoWorks can be found in the help files when the application is started.



## 5.2 Presto! Mr. Photo

Presto! Mr. Photo is an advanced photo editing software application.

To install Presto! Mr. Photo:

1. Insert the supplied CD into the CD-ROM drive.
2. If the CD-ROM does not automatically boot, use Windows Explorer to execute the **InstallMgr.exe** file in the root directory.

The following screen is displayed.



3. Click the **Install** button to begin the installation process and follow the instructions on-screen.

More information about Presto! Mr. Photo can be found in the help files when the application is started.

## 5.3 QuickTime

QuickTime is an easy-to-use application for playing the video clips stored in the camera or on the SD/MMC card.

To install the QuickTime:

1. Insert the supplied CD into the CD-ROM drive.
2. If the CD-Rom doesn't automatically boot, use Window Explore to execute the InstalMgr.exe file in the root directory.

The following screen is displayed:



3. Click the **Install** button to begin the installation process and follow the instructions on-screen.

More information about QuickTime can be found in the help files when the application is started.

# Appendix

---

## Specifications

General	
Imaging sensor	1/2.5" CMOS 5.1 Megapixel sensor
Active pixels	5.1 Megapixel
Storage media	Built-in 32 MB flash memory (19 MB for storage) SD Card, SDHC compatible
Sensor sensitivity	Auto
Color effects	Color/B&W/Sepia
Lens	Fixed lens Wide: F/3.2, f=7.5mm
Focus range	Normal: 1.5m~infinity Macro: 15~16cm
Still image	Formats: JPEG (DPOF, EXIF) Resolution: 3MP, 5MP, 8MP (Firmware interpolation) Quality: Auto

## General

Movie clips	Format: H.264 (MOV) Resolution: CIF, D1, HD (1280 x 720 / 30 fps.) Quality: Auto
Zoom	Movie: Digital Zoom 2X Camera: Digital Zoom 2X Still Image Playback: Digital Zoom 8X (max.)
Audio Video	Yes
TFT Monitor	3.0" TFT (960 x 240 pixels)
LED Light	< 1.0m range Movie: On / Off Camera: On / Off
White balance	Auto/Sunny/Cloudy/Tungsten/ Fluorescent
EV compensation	-2.0 EV~+2.0 EV
Self-timer	Off, 5, 10 seconds
PC interface	Camera: USB 2.0 (high speed) MSDC: USB 2.0 (high speed)
TV out format	NTSC/PAL

## General

Shutter	Electronic shutter 1~1/8000 second
Auto power off	Off, 1 min., 5 min.
Power supply	AAA-type rechargeable batteries
Dimension	29mm(thickness) X110mm (height) X73mm (length)
Weight	Approx. 135g (without batteries)

## Troubleshooting

Problem	Possible Cause	Solution
Cannot turn on the video camera.	The batteries are not inserted correctly.  The batteries have no power.	<ul style="list-style-type: none"><li>• Insert the batteries correctly. (See 2.2 Inserting the batteries)</li><li>• Replace the batteries</li></ul>
The camera suddenly turns off.	The auto power off function was enabled.  The camera is running out of battery power.	<ul style="list-style-type: none"><li>• Turn the power on again.</li><li>• Replace the batteries.</li></ul>
The captured image is not stored in memory.	Before the image is saved the power has been cut off.	When the battery indicator turns red, replace the batteries immediately.

<p>The camera turns off when capturing image using self-timer.</p>	<p>The camera is running out of battery power.</p>	<ul style="list-style-type: none"> <li>• Replace the batteries.</li> </ul>
<p>The image is out of focus.</p>	<p>The subject is beyond focus range.</p>	<ul style="list-style-type: none"> <li>• Please take a picture within the available focus range and choose normal or macro mode. (See 3.2.2 Using the macro function).</li> </ul>
<p>Memory card cannot be used.</p>	<p>The memory card is protected.</p> <p>The memory card contains non-DCF images taken by other cameras.</p>	<ul style="list-style-type: none"> <li>• Unlock the memory card.</li> <li>• Format the memory card. (See 4.5.5 Format) Before formatting the card, ensure you back up the files.</li> </ul>

<p>All buttons are inactive.</p>	<p>Short circuit occurred when connecting the camera with other devices.</p>	<ul style="list-style-type: none"><li>• Remove the batteries from the camera and insert again.</li></ul>
----------------------------------	--	--





Website:

Please visit our website at [www.dxgusa.com](http://www.dxgusa.com) for any product updates or special announcements.

You can also check out our online support desk where you can register your product, send emails to our technical support, and find a list of frequently asked questions (FAQs).



**DXG USA**

## Free Manuals Download Website

<http://myh66.com>

<http://usermanuals.us>

<http://www.somanuals.com>

<http://www.4manuals.cc>

<http://www.manual-lib.com>

<http://www.404manual.com>

<http://www.luxmanual.com>

<http://aubethermostatmanual.com>

Golf course search by state

<http://golfingnear.com>

Email search by domain

<http://emailbydomain.com>

Auto manuals search

<http://auto.somanuals.com>

TV manuals search

<http://tv.somanuals.com>