

another innovation from
SONIC | **blue™**
www.sonicblue.com



Rio HT2030 User's Guide



Safety Precautions



CAUTION
RISK OF ELECTRIC SHOCK
DO NOT OPEN



CAUTION: TO REDUCE THE RISK OF ELECTRIC SHOCK DO NOT REMOVE COVER (OR BACK). NO USER-SERVICEABLE PARTS INSIDE. REFER SERVICING TO QUALIFIED SERVICE PERSONNEL.



This lightning flash with arrowhead symbol within an equilateral triangle is intended to alert the user to the presence of uninsulated dangerous voltage within the product's enclosure that may be of sufficient magnitude to constitute a risk of electric shock to persons.



The exclamation point within an equilateral triangle is intended to alert the user to the presence of important operating and maintenance (servicing) instructions in the literature accompanying the product.

WARNING: TO REDUCE THE RISK OF FIRE OR ELECTRIC SHOCK, DO NOT EXPOSE THIS APPARATUS TO RAIN OR MOISTURE.

CAUTION: TO PREVENT ELECTRIC SHOCK, MATCH WIDE BLADE OF PLUG TO WIDE SLOT, FULLY INSERT.

ATTENTION: POUR ÉVITER LES CHOC ÉLECTRIQUES, INTRODUIRE LA LAME LA PLUS LARGE DE LA FICHE DANS LA BORNE CORRESPONDANTE DE LA PRISE ET POUSSER JUSQU'AU FOND.

WARNING: Do not install this equipment in a confined space such as a bookcase or similar unit.

NOTE TO CABLE/TV INSTALLER: This reminder is provided to call the cable TV system installer's attention to Article 820-40 of the National Electric Code (U.S.A.). The code provides guidelines for proper grounding and, in particular, specifies that the cable ground shall be connected to the grounding system of the building, as close to the point of the cable entry as practical.

CAUTION:

This DVD+VCR employs a Laser System.

To ensure proper use of this product, please read this owner's manual carefully and retain for future reference. Should the unit require maintenance, contact an authorized service location.

Use of controls, adjustments, or the performance of procedures other than those specified herein may result in hazardous radiation exposure.

To prevent direct exposure to laser beam, do not try to open the enclosure. Visible laser radiation when open. DO NOT STARE INTO BEAM.

© Copyright 2002, SONICblue, Inc.

CAUTION: The apparatus should not be exposed to water (dripping or splashing) and no objects filled with liquids, such as vases, should be placed on the apparatus.

FCC WARNING: This equipment may generate or use radio frequency energy. Changes or modifications to this equipment may cause harmful interference unless the modifications are expressly approved in the instruction manual. The user could lose the authority to operate this equipment if an unauthorized change or modification is made.

REGULATORY INFORMATION: FCC Part 15

This product has been tested and found to comply with the limits for a Class B digital device, pursuant to Part 15 of the FCC Rules. These limits are designed to provide reasonable protection against harmful interference when the product is operated in a residential installation. This product generates, uses, and can radiate radio frequency energy and, if not installed and used in accordance with the instruction manual, may cause harmful interference to radio communications. However, there is no guarantee that interference will not occur in a particular installation. If this product does cause harmful interference to radio or television reception, which can be determined by turning the product off and on, the user is encouraged to try to correct the interference by one or more of the following measures:

- Reorient or relocate the receiving antenna.
- Increase the separation between the product and receiver.
- Connect the product into an outlet on a circuit different from that to which the receiver is connected.
- Consult the dealer or an experienced radio/TV technician for help.



NOTES ON COPYRIGHTS:

It is forbidden by law to copy, broadcast, show, broadcast via cable, play in public, or rent copyrighted material without permission.

This product features the copy protection function developed by Macrovision. Copy protection signals are recorded on some discs. When recording and playing these discs on a VCR, picture noise will appear.

This product incorporates copyright protection technology that is protected by method claims of certain U.S. patents and other intellectual property rights owned by Macrovision Corporation and other rights owners. Use of this copyright protection technology must be authorized by Macrovision Corporation, and is intended for home and other limited viewing uses only unless otherwise authorized by Macrovision Corporation. Reverse engineering or disassembly is prohibited.

SERIAL NUMBER: The serial number is found on the back of this unit. This number is unique to this unit and not available to others. Enter your model number and serial number here and retain this guide as a permanent record of your purchase.

Model No. _____

Serial No. _____

IMPORTANT SAFETY INSTRUCTIONS

CAUTION: PLEASE READ AND OBSERVE ALL WARNINGS AND INSTRUCTIONS IN THIS OWNER'S MANUAL. AND THOSE MARKED ON THE PRODUCT. RETAIN THIS BOOKLET FOR FUTURE REFERENCE.

This product has been designed and manufactured to assure personal safety. Improper use can result in electric shock or fire hazard. The safeguards incorporated in this product will protect you if you observe the following procedures for installation, use, and servicing. This product does not contain any parts that can be repaired by the user.

DO NOT REMOVE THE CABINET COVER, OR YOU MAY BE EXPOSED TO DANGEROUS VOLTAGE. REFER SERVICING TO QUALIFIED SERVICE PERSONNEL ONLY.

- 1. Read these instructions.** - All these safety and operating instructions should be read before the product is operated.
- 2. Keep these instructions.** - The safety, operating and use instructions should be retained for future reference.
- 3. Heed all warnings.** - All warnings on the product and in the operating instructions should be adhered to.
- 4. Follow all instructions.** - All operating and use instructions should be followed.
- 5. Do not use this product near water.** - For example: near a bath tub, wash bowl, kitchen sink, laundry tub, in a wet basement; or near a swimming pool; and other areas located near water.
- 6. Clean only with dry cloth.** - Unplug this product from the wall outlet before cleaning. Do not use liquid cleaners.
- 7. Do not block any ventilation openings. Install in accordance with the manufacturer's instructions.** - Slots and openings in the cabinet are provided for ventilation and to ensure reliable operation of the product and to protect it from over-heating. The openings should never be blocked by placing the product on a bed, sofa, rug or other similar surface. This product should not be placed in a built-in installation such as a bookcase or rack unless proper ventilation is provided or the manufacturer's instructions have been adhered to.
- 8. Do not install near any heat sources such as radiators, heat registers, stoves, or other apparatus (including amplifiers) that produce heat.**
- 9. Do not defeat the safety purpose of the polarized or grounding-type plug.** A polarized plug has two blades with one wider than the other. A grounding type plug has two blades and a third grounding prong. The wide blade or the third prong are provided for your safety. If the provided plug does not fit into your outlet, consult an electrician for replacement of the obsolete outlet.
- 10. Protect the power cord from being walked on or pinched particularly at plugs, convenience receptacles, and the point where it exits from the product.**
- 11. Only use attachments/accessories specified by the manufacturer.**
- 12. Use only with the cart, stand, tripod, bracket, or table specified by the manufacturer, or sold with apparatus. When a cart is used, use caution when moving the cart/product combination to avoid injury from tip-over.**
- 13. Unplug this product during lightning storms or when unused for long periods of time.**
- 14. Refer all servicing to qualified service personnel. Servicing is required when the product has been damaged in any way, such as power-supply cord or plug is damaged, liquid has been spilled or objects have fallen into the product, the product has been exposed to rain or moisture, does not operate normally, or has been dropped.**



Table of Contents

Introduction

Getting Started	5-6
Playable Discs	5
Precautions	6
Notes on Discs	6
About Symbols	6
Front Panel	7
Front Panel Display	8
Remote Control	9
Rear Panel	10

System Setup

Connections	11-14
Connecting Antenna/Cable TV to DVD+VCR	11
Basic TV Connections	12
Optional TV Connections	12
Speaker System Connections	13
Speaker Positioning	13
Radio Antenna Connections	14
Other Audio/Video (A/V) Connections	14
Digital Device Connections	14
Setting the Output Source	15
Amplifier Setup	16-18
Mini Glossary for Sound Mode	16
Sound Mode	17
Sound Level	17
Test Tone	17
Setting Delays	18
VCR Setup	19-21
On-Screen Display	19
On-Screen Menu System	19
The VCR Setup Menu	20
Channel Selection	20
Setting the Clock	21
DVD Setup	22-24
General Explanation	22
On-Screen Display	22
Initial Settings	23-24
• <i>Initial Settings Overview</i>	23
• <i>Language</i>	23
• <i>Picture</i>	23
• <i>Parental Control</i>	24

Operation

VCR Operation	25-30
Normal Playback	25
Special Playback Effects	25
• <i>Search</i>	25
• <i>Still Picture and Frame-by-Frame Playback</i>	25
• <i>Slow Motion</i>	25
• <i>Commercial Skip</i>	25
Normal Recording	26
Timer Recording	26-27
One-Touch Recording	28
Dubbing and Editing	28
Copying from DVD to VCR	28
VHS Hi-Fi Stereo System/MTS Broadcast	29
Tape Counter Memory Feature	30
Additional VCR Information	30



DVD Operation 31-36

Playing a DVD	31
General Features	31
• <i>Moving to another TITLE</i>	31
• <i>Moving to another CHAPTER/TRACK</i>	31
• <i>Slow Motion</i>	31
• <i>Still Picture and Frame-by-Frame Playback</i>	32
• <i>Search</i>	32
• <i>Random</i>	32
• <i>Repeat</i>	32
• <i>Repeat A-B</i>	32
• <i>Time Search</i>	32
• <i>Zoom</i>	33
• <i>Marker Search</i>	33
Special DVD Features	33
• <i>Checking DVD contents</i>	33
• <i>Title Menu</i>	33
• <i>Disc Menu</i>	33
• <i>Camera Angle</i>	33
• <i>Changing the Audio Language</i>	33
• <i>Subtitle</i>	33
Audio CD and MP3 Operation	34
Playing Audio CD and MP3 Discs	34
• <i>Pause</i>	34
• <i>Moving to another Track</i>	34
• <i>Repeat Track/ All/ Off</i>	34
• <i>Search</i>	34
• <i>Random</i>	34
• <i>Repeat A-B</i>	34
• <i>Changing the Audio Channel</i>	34
Programmed Playback	35
Programmed Playback with Audio CD and MP3 Discs	35
• <i>Repeat Programmed Tracks</i>	35
• <i>Erasing a Track from Program List</i>	35
• <i>Erasing the Complete Program List</i>	35
Additional DVD Information	36
Screen Saver	36
Video Mode Setting	36
Notes on MP3 Discs	36
Radio Operation	37
Presetting Radio Stations	37
Listening to the Radio	37

Reference



Troubleshooting	38-40
Language Code List	41
Country Code List	42
Specifications	43-44
Warranty	Rear Cover

About the symbols for instructions

-  Indicates hazards likely to cause harm to the unit itself or other material damage.
-  Indicates special operating features of the unit.
-  Indicates tips and hints for making the task easier.

Getting Started

Playable Discs

	DVD (8 cm/12 cm disc)
	Audio CD (8 cm/12 cm disc)

In addition, this unit can play a CD-R or CD-RW that contains audio titles or MP3 files.

Notes

- Depending on the conditions of the recording equipment or the CD-R/RW disc itself, some CD-R/RW discs cannot be played on this unit.
- This unit cannot play discs that contain data other than MP3 or Audio CD.
- Do not attach any seal or label to either side of a disc.
- Do not use irregularly shaped CDs (e.g., heart-shaped or octagonal).

Notes on DVDs

Some DVD playback operations may be intentionally fixed by the disc manufacturer. As a result, some playback features may not be available or other functions may be added.

Refer to the instructions supplied with the DVD. Some DVDs made for business purposes may not be played on this unit.

About Regional Codes

This DVD+VCR is designed and manufactured for playback of Region 1 encoded DVD software. The region code on the labels of some DVD discs indicates which type of DVD+VCR can play those discs. This unit can play only DVD discs labeled 1 or ALL. If you try to play any other discs, the message "Check Regional Code" will appear on the TV screen. Some DVD discs may not have a region code label even though their playback is prohibited by area limits.



Disc-Related Terms

Title (DVD only)

The main film, accompanying features or music album. Each title is assigned a title reference number enabling you to locate it easily.

Chapter (DVD only)

Sections of a picture or a musical piece that are smaller than titles. A title is composed of one or several chapters. Each chapter is assigned a chapter number to enable you to locate the chapter you want. Depending on the disc, chapters may not be labeled.

Track (audio CD only)

Sections of a musical piece on an audio CD. Each track is assigned a track number, enabling you to locate the track you want.

Remote Control Battery Installation

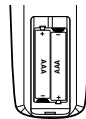

Detach the battery cover on the rear of the remote control, and insert two AAA batteries with the \oplus and \ominus symbols aligned correctly.

Caution

Do not mix old and new batteries. Never mix different types of batteries (standard, alkaline, etc.).

Remote Control Operating Range

Point the remote control at the remote sensor and press the buttons.

- **Distance:** About 23 ft (7 m) from the front of the remote sensor
- **Angle:** About 30° in each direction of the front of the remote sensor

IMPORTANT NOTE:

DEPLETED OR DISCHARGED BATTERIES MUST BE RECYCLED OR DISPOSED OF IN A SAFE MANNER IN COMPLIANCE WITH ALL APPLICABLE LAWS. FOR DETAILED INFORMATION, CONTACT YOUR LOCAL COUNTY SOLID WASTE AUTHORITY.

Getting Started (Continued)

Precautions

Handling the Unit

When shipping the unit

The original shipping carton and packing materials come in handy. For maximum protection, re-pack the unit as it was originally packaged at the factory.

When setting up the unit

The picture and sound of a nearby TV, VCR, or radio may be distorted during playback. In this case, position the unit away from the TV, VCR, or radio, or turn off the unit after removing the disc.

To keep the surface clean

Do not use volatile liquids, such as insecticide spray, near the unit. Do not leave rubber or plastic products in contact with the unit for a long period of time. They will leave marks on the surface.

Cleaning the Unit

To clean the cabinet

Use a soft, dry cloth. If the surfaces are extremely dirty, use a soft cloth lightly moistened with a mild detergent solution. Do not use strong solvents such as alcohol, benzene, or thinner, as these might damage the surface of the unit.

To obtain a clear picture

The DVD+VCR is a high-tech, precision device. If the optical pick-up lens and disc drive parts are dirty or worn, the picture quality will be poor.

Regular inspection and maintenance are recommended after every 1,000 hours of use (depending on the operating environment). For details, please contact your nearest dealer.

Notes on Discs

Handling Discs

Do not touch the playback side of the disc. Hold the disc by the edges so that fingerprints will not get on the surface. Do not stick paper or tape on the disc.

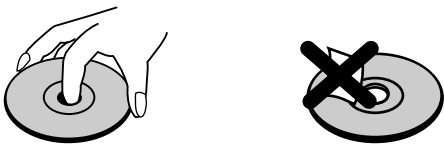

Storing Discs

After playing, store the disc in its case.

Do not expose the disc to direct sunlight or other heat sources. Do not leave the disc in a parked car exposed to direct sunlight, as there may be a considerable temperature increase inside the car.

Cleaning Discs

Fingerprints and dust on the disc can cause poor picture quality and sound distortion. Before playing, clean the disc with a clean cloth. Wipe the disc from the center outward.

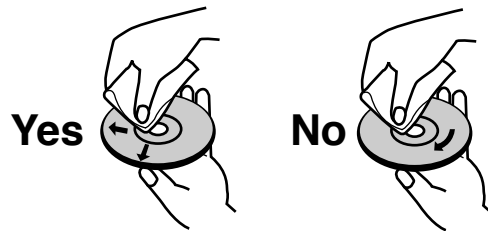

Do not use strong solvents such as alcohol, benzene, thinner, commercially available cleaners, or anti-static spray intended for older vinyl records.

About Symbols

About the Symbol

The “” symbol may appear on the TV screen during operation. If so, the function is not available on that specific disc.

About the Disc Symbols

The following symbols appear throughout this manual to indicate which disc types each feature applies to.

-  DVD
-  Audio CDs.
-  MP3 Discs.

Front Panel

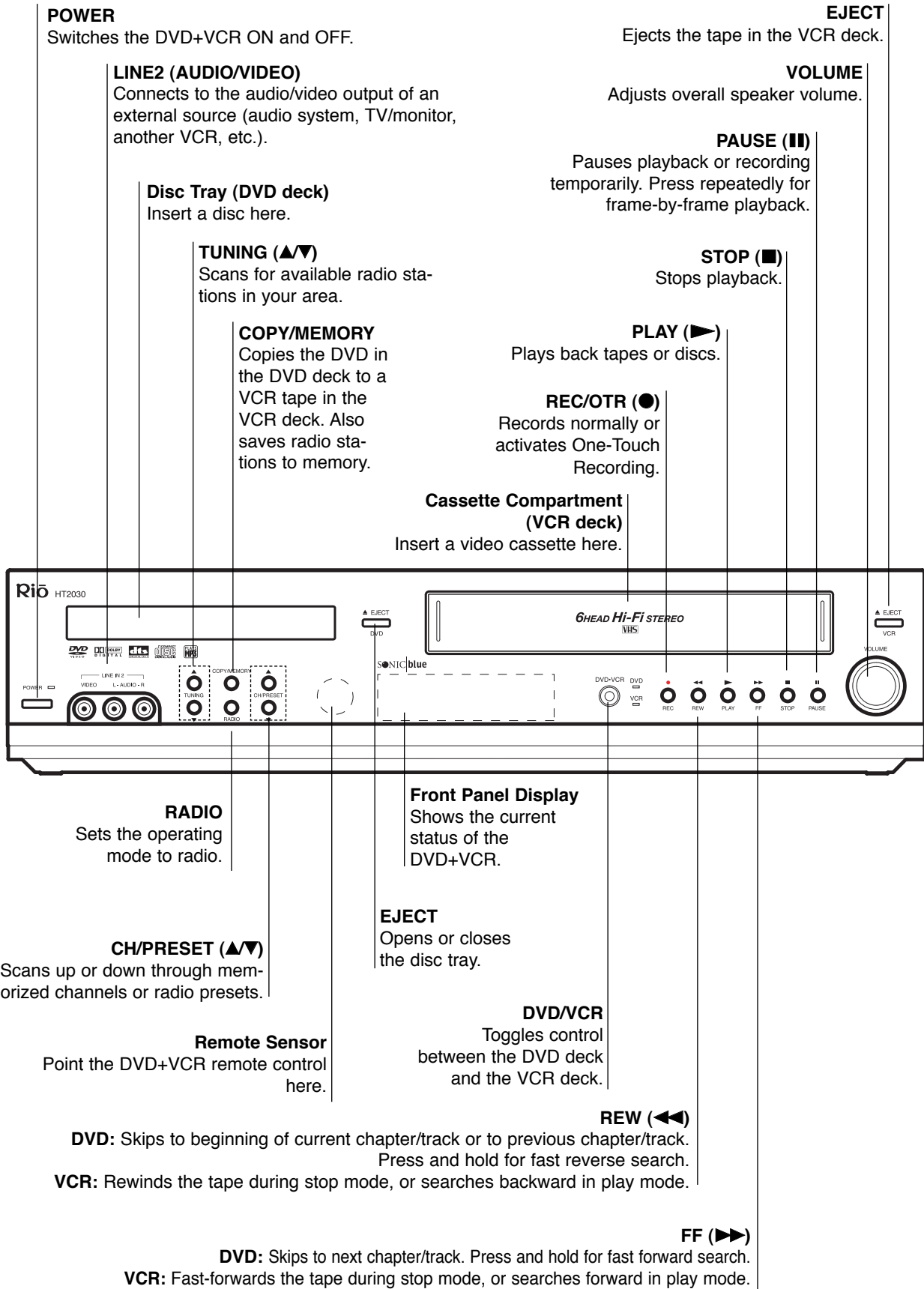

Front Panel Display

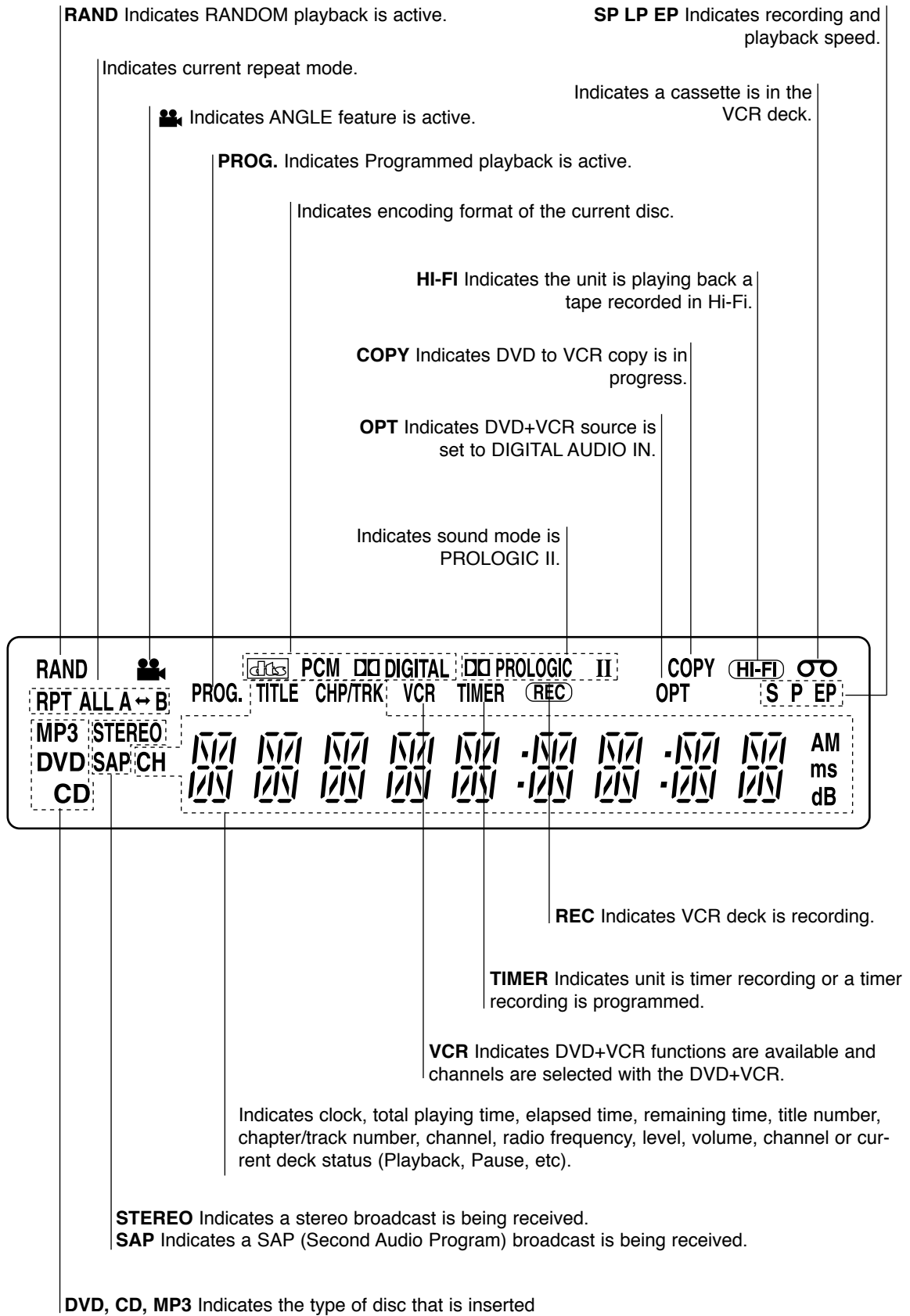

Remote Control

- EJECT (▲)**
 - Opens and closes the disc tray.
 - Ejects the tape in the VCR deck.
- MODE (AUX/DVD/VCR/RADIO)**
 - Sets the output source (AUX, DVD, VCR or RADIO) to view on the TV screen.
- LEVEL**
 - Sets the sound level of each speaker.
- DELAY**
 - Sets the delay time of each speaker.
- TEST TONE**
 - Sends a test tone to each speaker to fine tune levels.
- MUTE**
 - Turns off sound from speakers.
- 0-9 buttons**
 - Selects numbered options in menus.
- PROGRAM**
 - Opens or exits the Program menu.
- MARKER**
 - Places bookmarks during playback.
- SEARCH**
 - Displays MARKER SEARCH menu.
- INPUT**
 - Selects the VCR deck's source (Tuner, LINE 1, or LINE 2).
- OUTPUT**
 - Cycles through the 3 main output views: DVD, Tuner and VCR.
- VOLUME (+/-)**
 - Adjusts speaker volume.
- RETURN**
 - Exits the setup menu.
- STOP (■)**
 - Stops playback.
- PAUSE/STEP (II)**
 - Pauses playback or recording temporarily. Press repeatedly for frame-by-frame playback.
- PLAY (▶)**
 - Starts playback.
- REC/OTR (●)**
 - Records normally or activates One-Touch Recording (OTR).
- A-B, SP/EP**
 - Repeats sequence between two points. Also, selects recording speed.
- REPEAT**
 - Repeats chapter, track, title or all.
- RANDOM, SKIP**
 - Plays tracks in random order. Automatically searches ahead 30 seconds to skip commercials.

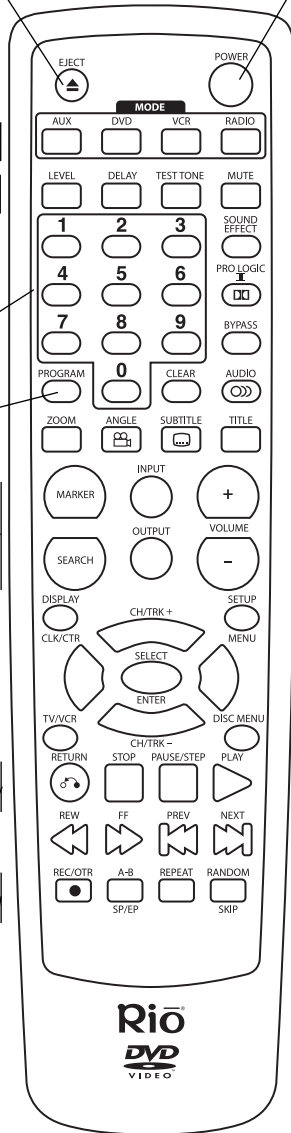

- POWER**
 - Switches DVD+VCR ON and OFF.
- SOUND EFFECT**
 - Selects sound mode.
- PROLOGIC II**
 - Selects PROLOGIC II sound mode.
- BY PASS**
 - Sets PRO LOGIC II mode to Off.
- CLEAR**
 - Removes a track number on the Program menu or a mark on the MARKER SEARCH menu.
- AUDIO**
 - Selects an audio language (DVD) or an audio channel (CD).
- ZOOM**
 - Enlarges the DVD video image.
- ANGLE**
 - Selects an alternate DVD camera angle if available.
- SUBTITLE**
 - Selects a subtitle language.
- TITLE**
 - Displays the disc's Title menu, if available.
- DISPLAY, CLK/CTR**
 - Brings up the on-screen display. Also switches among the clock, tape counter and time remaining.
- SETUP, MENU**
 - Opens or exits the DVD setup menu and VCR menu.
- ◀ ▶ ▲ ▼ (left/right/up/down)**
 - Selects options in the menu system.
 - **CH/TRK (+/-)**: Selects channels in VCR mode. Also manually adjusts tracking.
- DISC MENU**
 - Accesses DVD disc menus.
- TV/VCR**
 - Views channels selected by the VCR tuner or by the TV tuner.
- SELECT/ENTER**
 - Acknowledges menu selections.
 - Displays functions on the TV screen.
- REW (◀◀)**
 - VCR: Rewinds the tape during stop mode, or searches backward in play mode.
- FF (▶▶)**
 - VCR: Fast-forwards the tape during stop mode, or searches forward in play mode.
- PREV (◀◀◀)**
 - DVD: Skips to beginning of current chapter/track or to previous chapter/track. Press and hold for fast reverse search.
- NEXT (▶▶▶)**
 - DVD: Skips to next chapter/track. Press and hold for fast forward search.

Note
 This remote control uses one set of controls for both the VCR and DVD decks. When using the VCR, first press the VCR button. When using the DVD, first press the DVD button.

Rear Panel

VCR IN LINE 1 (AUDIO/VIDEO)

Connect to the audio/video output of an external source (audio system, TV/monitor, another VCR, etc.).

RF OUT (DVD/VCR OUT)

Connect to a TV with an RF coaxial input.

ANT.IN

Connect the VHF/UHF/CATV antenna to this terminal.

DVD/VCR OUT (AUDIO/VIDEO (Left/Right))

Connect to a TV with video and audio inputs.

COMPONENT VIDEO OUT/PROGRESSIVE SCAN (Y Pb Pr) (DVD OUT)

Connect to a TV with Y Pb Pr inputs. FOR DVD VIEWING ONLY.

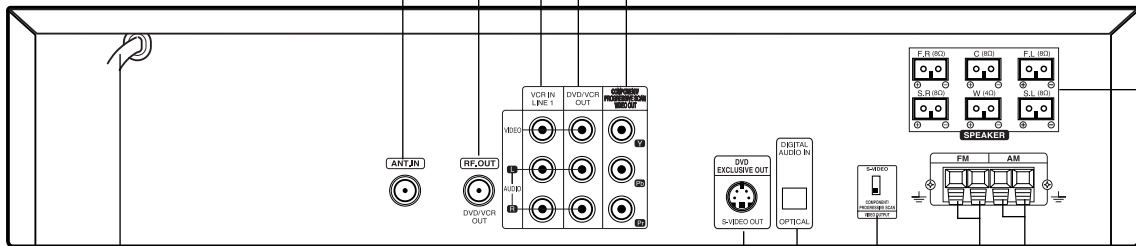

AC Power Cord

Plug into a standard wall outlet.

S-VIDEO OUT (DVD OUT)

Connect to a TV with an S-Video Input. FOR DVD VIEWING ONLY.

DIGITAL AUDIO IN (OPTICAL)

Connect to the digital audio output of an external digital device (see "Dust Protection Cap" below).

VIDEO OUTPUT Switch

Select either S-VIDEO OUT or COMPONENT VIDEO OUT/PROGRESSIVE SCAN, depending on how you connected the DVD+VCR to your TV.

FM Antenna Connectors

Connect the FM antenna to this terminal.

AM Antenna Connectors

Connect the AM antenna to this terminal.

Dust Protection Cap

Remove the dust protection cap from the DIGITAL AUDIO IN jack and connect the optical digital cable (not supplied) securely so that the configurations of both the cable and the connector match. Keep the dust protection cap and always reattach the cap when not using the connector to protect against dust intrusion.

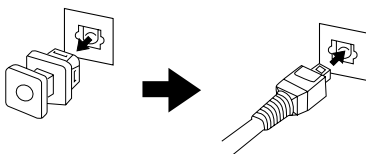

SPEAKER Connectors

Connect the six supplied speakers to these terminals.



Do not touch the inner pins of the jacks on the rear panel. Electrostatic discharge may cause permanent damage to the unit.

Connections

Tips

- Depending on the capabilities of your TV and other equipment, there are a variety of ways to connect the DVD+VCR. Choose from the connections described on pages 11-14.
- Please refer to the manuals of your TV, VCR, Stereo System or other devices as necessary to make the best connections for your specific equipment.

Caution

- Make sure the DVD+VCR is connected directly to your TV, and that your TV is tuned to the correct video input channel.
- Do not connect the DVD+VCR's DVD/VCR AUDIO OUT jack to the phono in jack (record deck) of your audio system.
- Do not connect your DVD+VCR via your VCR. The DVD image could be distorted by the copy protection system.

Connecting Antenna/Cable TV to DVD+VCR

- 1 Disconnect the antenna from the rear of your TV.
- 2 Identify the type of cable from your antenna. If it is a round cable as illustrated, it is a 75 ohm coaxial antenna cable. This cable will connect directly to the jack marked ANT.IN on your DVD+VCR.

Tip

If your antenna lead wire is a flat type antenna cable, connect it to an Antenna Adapter (300-ohm to 75-ohm, not supplied) and slip the Adapter onto the ANT.IN jack. The Adapter does not screw on to the DVD+VCR, it just slips over the jack.

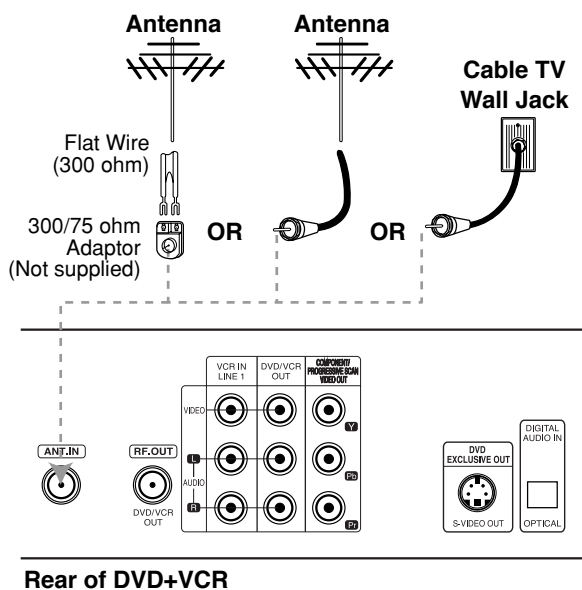

Without Cable Box

If your cable wire is connected to your TV without a converter or descrambler box, unscrew the wire from your TV and attach it to the ANT.IN jack on the DVD+VCR. Use the supplied round coaxial cable to connect between the DVD+VCR's RF.OUT jack and the 75 ohm antenna input jack on your TV. With this connection, you can receive all midband, super band, and hyperband channels.

With Cable Box

If a converter box is required with your cable system, refer to the notes and illustration below. The cable hookup shown permits both TV and DVD+VCR operation.

To view or record CATV channels:

- 1 Tune the TV to the DVD+VCR output channel (CH 3 or 4).
- 2 Set the DVD+VCR channel selector to the output channel of the cable converter box by pressing the CH/TRK (▲/▼) or number (0-9) buttons on your DVD+VCR (e.g., CH3).
- 3 Select the channel you wish to view on the cable converter box.

Notes

- With this connection, you CANNOT record one program while viewing another.
- If you are using a cable box to tune channels, it is not necessary to run Auto Channel Search as indicated on page 20.

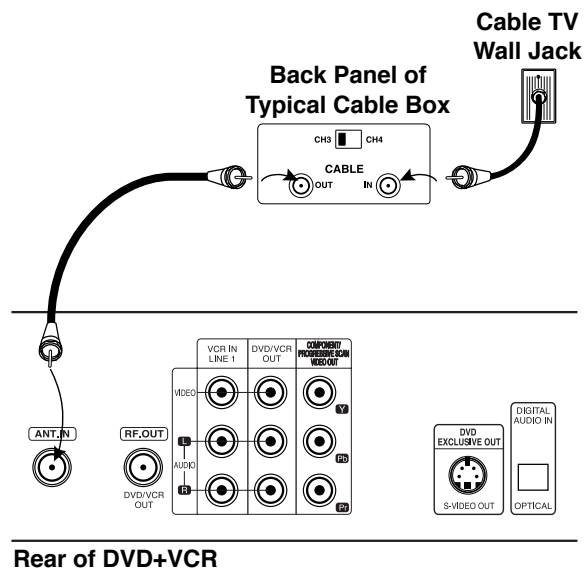

Connections (Continued)

Basic TV Connections

- Use one of the following connections, depending on the capabilities of your TV.

RF coaxial connection

Connect the RF.OUT jack on the DVD+VCR to the antenna in jack on your TV using the supplied 75-ohm Coaxial Cable (R).

Note

If you use this connection, tune the TV to the DVD+VCR's RF output channel (CH 3 or 4).

How to set the DVD+VCR's RF output channel

While the DVD+VCR is turned off, press and hold CHANNEL (▲/▼) on the front panel for about five seconds to change the RF output channel to CH 03 or CH 04. "RF 03" or "RF 04" will appear on the front panel display.

Audio/Video connection

- 1 Connect the DVD/VCR VIDEO OUT jack on the DVD+VCR to the video in jack on your TV using the supplied video cable (V).
- 2 Connect the Left and Right DVD/VCR AUDIO OUT jacks on the DVD+VCR to the audio left/right in jacks on your TV (A) using the supplied audio cables.

Note

If you use this connection, set your TV's source selector to VIDEO.

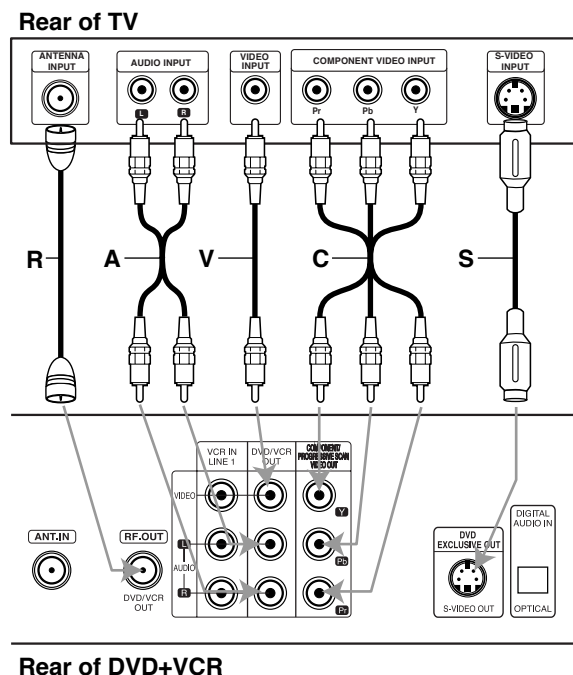

Optional TV Connections

Note

- The S-VIDEO OUT and COMPONENT VIDEO OUT/PROGRESSIVE SCAN connections are for DVD playback only! The tuner and VCR will still be output through the RF.OUT (R) or DVD/VCR OUT (A, V) jack.
- When using the COMPONENT VIDEO OUT/PROGRESSIVE SCAN jacks, set the VIDEO OUTPUT switch to COMPONENT/PROGRESSIVE. When using the S-VIDEO OUT jack, set the VIDEO OUTPUT switch to S-VIDEO.

S-Video connection

- 1 Connect the S-VIDEO OUT jack on the DVD+VCR to the S-Video in jack on your TV using the supplied S-Video cable (S).
- 2 Connect the Left and Right AUDIO OUT jacks on the DVD+VCR to the audio left/right in jacks on your TV using the supplied audio cables (A).

Component Video (Color Stream®) connection

- 1 Connect the COMPONENT VIDEO OUT jacks on the DVD+VCR to the corresponding in jacks on your TV using optional Y/Pb/Pr cables (C).
- 2 Connect the Left and Right AUDIO OUT jacks of the DVD+VCR to the audio left/right in jacks on the TV (A) using the supplied audio cables.

Progressive Scan (ColorStream® pro) connection

- If your television is a high-definition or "digital ready" television, you may take advantage of the DVD+VCR's progressive scan output for the highest possible video resolution.
- If your TV does not accept the Progressive Scan format, the picture will appear scrambled if you try Progressive Scan on the DVD+VCR.

- 1 Connect the COMPONENT VIDEO OUT/PROGRESSIVE SCAN jacks on the DVD+VCR to the corresponding in jacks on your TV using optional Y/Pb/Pr cables (C).
- 2 Connect the Left and Right AUDIO OUT jacks of the DVD+VCR to the audio left/right in jacks on your TV (A) using the supplied audio cables.

Note

- Set "Progressive" to "On" on the DVD setup menu when using the progressive signal (see page 23).
- Progressive scan does not work with the analog video connections (yellow VIDEO OUT jack).

Connections (Continued)

Speaker System Connections

Connect the speakers using the supplied speaker cables by matching the colors of the terminals to those of the cables. To obtain the best possible surround sound, fine tune your system by adjusting the various speaker settings (levels, delays, etc.).

Note

- Be sure to match the speaker cables to the appropriate terminals: + to + and - to -. If the cables are reversed, the sound will be distorted and lack bass.
- If you use front speakers with low maximum input ratings, adjust the volume carefully to avoid excessive volume output to the speakers.
- Do not disassemble the front covers of the supplied speakers.

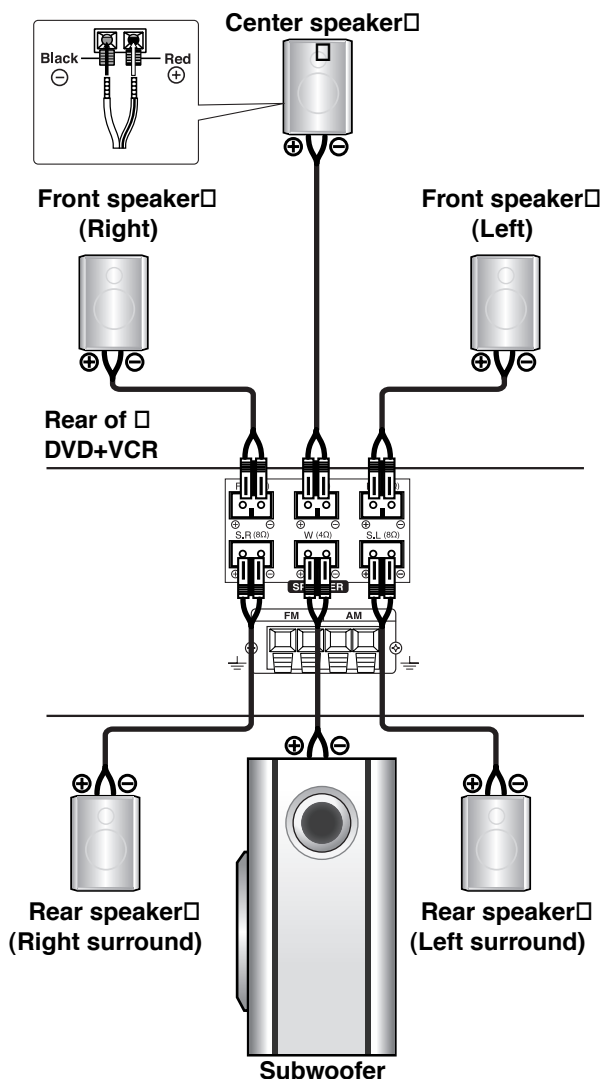

Speaker Positioning

Follow these guidelines to position the six supplied speakers (two front speakers, center speaker, two rear speakers and subwoofer).

If you want to hear deeper bass, DTS digital surround and/or Dolby Digital surround, consider adding an active subwoofer with built-in amplifier.

• Front speakers

The front speakers should be placed at equal distances from your primary listening position. The speakers should be placed 45 degrees apart relative to the listening position.

• Center speaker

Ideally the center speaker should be placed at the same height as the front speakers and at the same distance from your primary listening area.

• Rear speakers

Place the rear surround speakers to the left and right behind the primary listening area. For best results, do not position the rear speakers too far behind the listening position. Place them at or above ear level. It is also effective to direct the rear speakers towards a wall or ceiling to further disperse the sound.

If the listening area is in a small room against a rear wall, set the rear speakers opposite each other 2-3 feet above the listener's ears.

• Subwoofer

This can be placed in any front position.

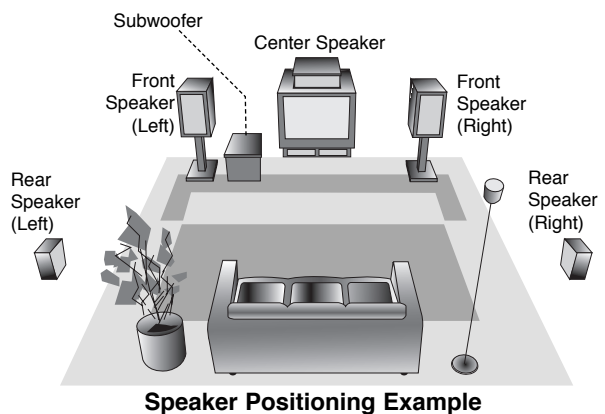

Connections (Continued)

Radio Antenna Connections

Connect the supplied FM/AM antennas for listening to the radio.

- 1 Connect the AM loop antenna to the AM antenna connectors.
- 2 Connector the FM wire antenna to the FM antenna connectors.

Note

- To prevent noise pickup, keep the AM loop antenna away from the DVD+VCR and other components.
- Be sure to fully extend the FM wire antenna.
- After connecting the FM wire antenna, keep it as horizontal as possible.

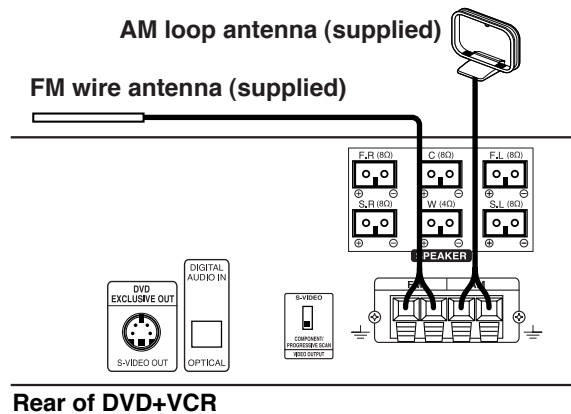

Other Audio/Video (A/V) Connections

Connect the VCR IN LINE1 or LINE2 jacks on the DVD+VCR to the audio/video out jacks on your accessory component(s), using optional audio/video cables.

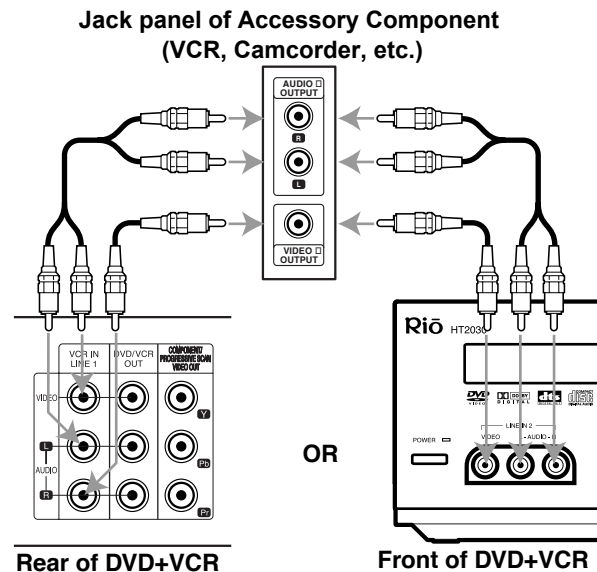

Digital Device Connections

Connect the DIGITAL AUDIO IN (OPTICAL) jack on the DVD+VCR to the digital audio out (optical) jack on your digital device (DVD Player, Game device, etc.), using an optional optical audio cable.

To select the source connected to DIGITAL AUDIO IN, press AUX on the remote control.

Note

- If the audio format of the digital output does not match the capabilities of your DVD+VCR, the DVD+VCR will produce a strong, distorted sound or no sound at all.
- The Optical input function is available only when the external unit's sampling frequency is 32-48kHz.

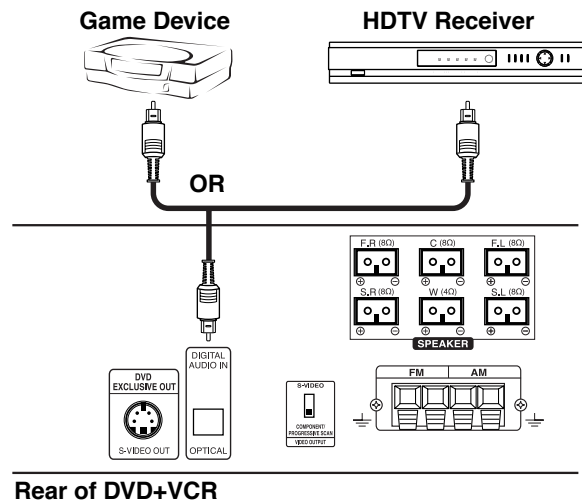

Setting the Output Source

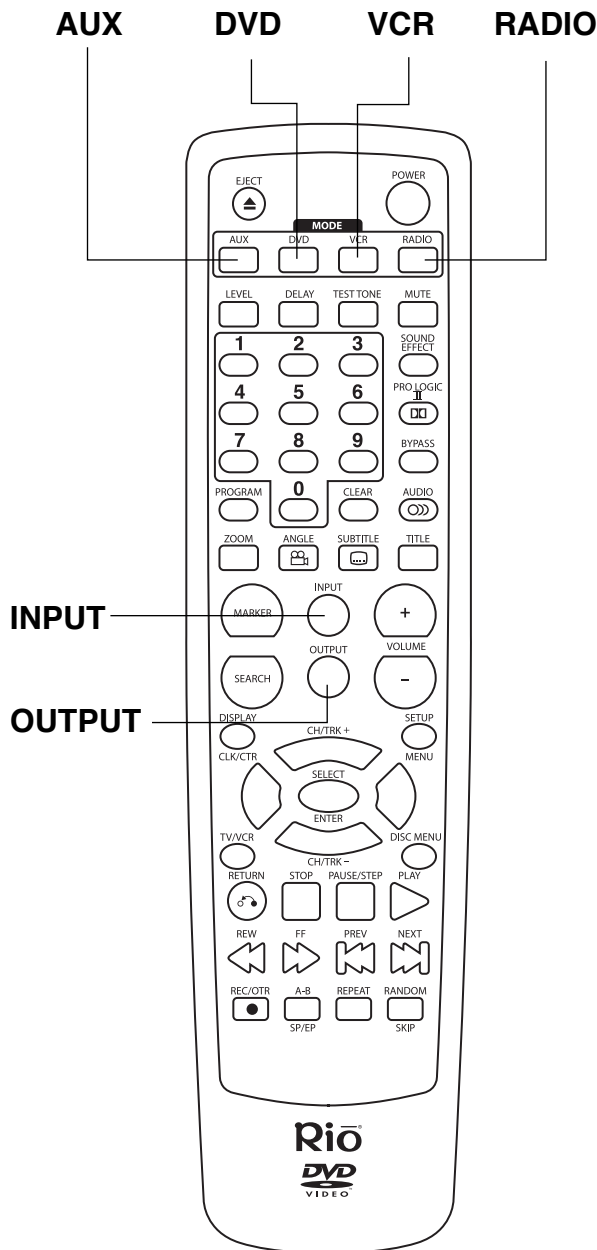

Follow these guidelines to select and switch among the various DVD+VCR input and output sources:

- **DVD**

- To view output from the DVD deck:**

- Press DVD on the remote or DVD/VCR on the front panel until the DVD indicator on the front panel lights and output from the DVD deck is viewed on the TV screen.

- **VCR**

- To view output from the VCR deck:**

- Press VCR on the remote or DVD/VCR on the front panel until the VCR indicator on the front panel lights and output from the VCR deck is viewed on the TV screen.

- **RADIO**

- To listen to AM/FM radio broadcasts:**

- Press RADIO on the remote to toggle between AM and FM radio. The selected frequency appears on the front panel display.

- **AUX**

- To view a source connected to the DIGITAL AUDIO IN (OPTICAL):**

- Press AUX on the remote and the OPTICAL indicator on the front panel lights, allowing you to hear digital sound from a DIGITAL AUDIO IN (OPTICAL) source.

- **INPUT**

- To view a source connected to the front or rear LINE inputs:**

- First, press VCR to select the VCR deck, and then press INPUT to select LINE1 (for rear panel) or LINE2 (for front panel).

- **OUTPUT**

- To quickly select DVD, VCR or Tuner:**

- Cycles through the 3 main output views: DVD, Tuner and VCR.

- DVD:** To view the current DVD deck status (disc playback, DVD menu, setup menu, etc.).

- Tuner:** To view TV programs through the TV tuner.

- VCR:** To view the current VCR deck status (tape playback, VCR programming, viewing TV programs through the VCR tuner, etc.).

Amplifier Setup

Mini Glossary for Sound Mode

dts

Allows you to enjoy 5.1 (or 6) discrete channels of high quality digital audio from DTS program sources, such as DVDs and CDs, bearing the DTS trademark. DTS Digital Surround delivers up to 6 channels of transparent audio (i.e., identical to the original masters) and results in exceptional clarity throughout a true 360 degree sound field. The term DTS is a trademark of DTS Technology, LLC. Manufactured under license from DTS Technology, LLC.

DIGITAL

The Dolby Digital surround format lets you enjoy up to 5.1 channels of digital surround sound from Dolby Digital program sources. If you play DVDs with the “” mark, you can enjoy even better sound quality, greater spatial accuracy, and improved dynamic range.

HALL 1

When playing recordings of live or classical music, this mode provides a feeling similar to actually being in a small concert hall.

HALL 2

When playing recordings of live or classical music, this mode provides a feeling similar to actually being in a large concert hall.

THEATER

This mode provides a three dimensional effect similar to that of a movie theater.

PRO LOGIC II

Dolby Pro Logic II creates five full-bandwidth output channels from two-channel sources. This is done using an advanced, high-purity matrix surround decoder that extracts the spatial properties of the original recording without adding any new sounds or tonal colorations. Pro Logic II offers the following five modes:

PROLOGIC Emulation mode:

The Pro Logic Emulation mode offers users the same robust surround processing as original Pro Logic, in case the source content is not of optimum quality, or if there is a desire to hear the program more “as it used to be.” When this mode is used, it is called Pro Logic, as before. There is no “Pro Logic I” mode. The Pro Logic emulation mode is optional.

MOVIE mode:

The Movie mode is for use with stereo television shows and all programs encoded in Dolby Surround. The result is enhanced sound field directionality that approaches the quality of discrete 5.1-channel sound.

MUSIC mode:

The Music mode is for use with any stereo music recordings, and provides a wide and deep sound space. The Music mode includes controls that allow the sound to be tailored to individual listening tastes.

VIRTUAL mode:

The Virtual mode is usually used when Pro Logic II is connected to a virtual process for speaker use. However, there might be some virtualizers for which this mode does not produce the intended result. For those virtualizers, Movie mode may give the best surround effect. Virtual mode is designed to be used with the virtual process developed by Dolby Laboratories. The Pro Logic II mode should be called only “Pro Logic II” so the Virtual name can be reserved to describe the speaker virtualization process itself.

MATRIX mode:

The Matrix mode is the same as the Music mode except that the directional enhancement logic is turned off. It may be used to enhance mono signals by making them seem “larger.” The Matrix mode may also find use in auto systems, where the fluctuations from poor FM stereo reception can otherwise cause disturbing surround signals from a logic decoder. The ultimate “cure” for poor FM stereo reception may be simply to force the audio to mono.

SURROUND OFF (2CH STEREO)

Outputs the sound from the front left and right speakers and subwoofer. Standard two channel (stereo) sources completely bypass the sound field processing. This allows you to play any source using only the front left and right speakers and subwoofer. **You can select SURROUND OFF by pressing BY PASS on the remote control.**

Amplifier Setup (Continued)

Sound Mode

You can enjoy surround sound simply by selecting one of the pre-programmed sound fields according to the program you want to listen to.

Each time you press the SOUND EFFECT button, the sound mode is changed in the following order:

PROLOGIC → HALL 1 → HALL 2 → THEATER



Note

For DVDs, you can only select sound modes when the PCM indicator is shown on the front panel display.

Each time you press the DDP/II button, the Pro Logic II sound mode is changed in the following order:

PROLOGIC → MOVIE → MUSIC → VIRTUAL → MATRIX



Tip

You can quickly select SURROUND OFF (2CH STEREO) mode by pressing the BY PASS button.

When DVD is inserted:

You can change the sound mode of a DVD (Dolby Digital, DTS, PRO LOGIC, etc) by pressing the AUDIO button on the remote during playback.

Although DVD contents differ from disc to disc, the following explains the basic operation when this feature is used.

Each time you press the AUDIO button, the sound mode of DVD is changed in the following order:

dts → DIGITAL → DIGITAL and PRO LOGIC



When a DVD is inserted and the PROLOGIC II indicator lights:

Each time you press the DDP/II button, the Pro Logic II sound mode is changed in the following order:



PROLOGIC → MOVIE → MUSIC → VIRTUAL → MATRIX



Tip

You can set PRO LOGIC II mode to Off (2CH STEREO) by pressing the BY PASS button (the PROLOGIC II indicator disappears).

For your reference:

- The DVD+VCR memorizes the last mode settings for each source individually.
- The encoding format of discs is usually printed on the packaging.
 - Dolby Digital discs are labeled with the  logo.
 - Dolby Surround encoded programs are labeled with the  logo.
 - DTS Digital Surround discs are marked with DTS.

Note

When you play sound tracks with a 96kHz sampling frequency, the output signals will be converted to 48kHz.

Sound Level

You can set the sound level for each channel independently.

1 Press LEVEL.

The level indicator appears on the front panel display.

2 Press ◀▶ to select the desired speaker.

Press the ◀▶ buttons to select each speaker in the following order:

FL (Front Left) → C (Center) → FR (Front Right) →

SR (Surround Right) → SL (Surround Left) →

SW (Subwoofer) → FL (Front Left)

- In 2-channel stereo mode, you can only select the SW (Subwoofer).

3 Press ▲▼ to adjust the sound level of the selected channel (-6dB - +6dB).

4 Repeat steps 2-3 and adjust the sound level for the other channels.

5 When settings are complete, press LEVEL.

Test Tone

This function allows you to adjust the sound balance of the speakers relative to the listening position.

1 Select test tone mode by pressing the TEST TONE button.

- A hissing noise is output for 2 seconds from each speaker in the following order:

FL (Front Left) → C (Center) → FR (Front Right) →

SR (Surround Right) → SL (Surround Left) →

SW (Subwoofer) → FL (Front Left)

2 Press LEVEL then press the ▲▼ buttons to adjust sound levels for each speaker.

- The sound levels should be balanced while seated in the primary listening position.
- If you adjust sound levels during test tone mode, the test tone will be paused in the active speaker channel.

3 When setting is complete, press TEST TONE.

Amplifier Setup (Continued)

Setting Delays

In Dolby Digital and Dolby Pro Logic mode, it is assumed that the distance from the listener to each of the five speakers is equal. If your center and rear speakers are closer than the front speakers, you can set delays so that sound from these speakers will be heard simultaneously at your primary listening position.

In Dolby Digital mode

Center delay time : 0ms

Rear delay time: 5ms

In Dolby Pro Logic mode

Center delay time : cannot be set

Rear delay time : 0-15ms

If the rear delay time is set in Dolby Digital mode, the delay time will be automatically set in Dolby Pro Logic mode .

The delay time is approximately 1 msec per foot.

If the center and rear speakers are further than the front speakers from the listener, the delay time should be set to the minimum.

Surround delay time setting

If the distance from your rear speakers to the listener is the same or greater than your front speakers, set the Surround Delay Time to 0ms. Otherwise, change the setting according to the calculation below.

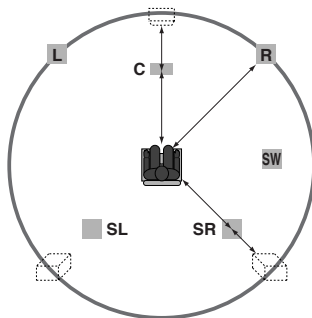

For example, if the distance from the front speakers to the listener is 10 feet and from the rear speakers to the listener is 5 feet, the rear delay time would be 5 msec. $10 \text{ feet} - 5 \text{ feet} = 5 \text{ feet}$, or 5msec

In Dolby Pro Logic II (Surround delay time):

- PROLOGIC: 10 - 25msec
- MOVIE: 10 - 25msec
- MUSIC: 0 - 15msec
- VIRTUAL: cannot be set
- MATRIX: 0 - 15msec

Center delay time setting (Dolby Digital mode only)

If the distance from your center speaker to the listener is the same or greater than your front speakers, set the Center Delay Time to 0ms. Otherwise, change the setting according to the calculation below.

For example, if the distance from the front speakers to the listener is 10 feet and from the center speaker to the listener is 8 feet, the center delay time is 2msec. $10 \text{ feet} - 8 \text{ feet} = 2 \text{ feet}$, or 2msec

Setting the delay time in the Dolby Digital and Dolby Pro Logic II mode

1 Press DELAY.

The current surround delay time appears on the front panel display.

You can select center delay time by pressing ◀▶ in the Dolby Digital mode only.

2 Press ▲▼ to change the delay time.

3 If setting is complete, press DELAY.

Notes

You can adjust the center delay time only in the Dolby Digital mode when its delay time appears.

Center Width (MUSIC mode of Dolby Pro Logic II only)

This control allows center-channel sounds to be positioned between the center speaker and the left/right speakers over a range of eight steps. Step "3" uses a combination of all three front speakers to give the best vocal imaging and most seamless soundstage presentation, and is recommended for most recordings. Step "0" places all center sound in the center speaker. Step "7" places all center sound equally in the left/right speakers, just as in conventional stereo.

DIMENSE (MUSIC mode of Dolby Pro Logic II only)

This control allows the user to gradually adjust the sound field either towards the front or the rear. This can be useful to help achieve the desired balance from all the speakers with certain recordings that may contain either too much or too little spatial effect. Step "0" is the recommended setting, which has no effect on the sound. Steps 1, 2, and 3 gradually move the sound forward, and steps -1, -2, and -3 move the sound towards the surrounds.

PANORAMA (MUSIC mode of Dolby Pro Logic II only)

This control extends the front stereo image to include the surround speakers for an exciting "wraparound" effect with side-wall imaging. It is particularly effective for recordings which have strong left- or right-channel elements in the mix, as these are detected and accentuated by the Panorama process.

VCR Setup

On-Screen Display (OSD)

Some of these functions will be displayed every time the VCR is operated.

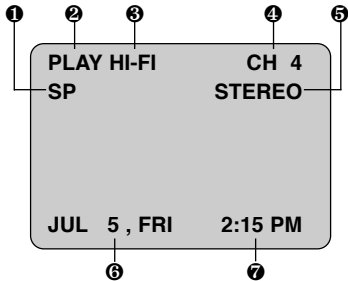

1 TAPE SPEED DISPLAY

Shows the current tape speed.

2 FUNCTION DISPLAY

Indicates the function in progress.

3 HI-FI DISPLAY

Indicates when the unit is playing back tape recorded in Hi-Fi stereo sound.

4 CHANNEL DISPLAY

Indicates the selected channel (or LINE1/LINE2).

5 STEREO/SAP DISPLAY (MONO is not displayed)

Shows the type of audio signal received by the VCR tuner.

6 DATE DISPLAY

Shows the current date (month/date/day of the week).

7 CLOCK/COUNTER/REMAIN DISPLAY

Shows the current time, the tape counter position and remaining time on the tape.

Each press of the **SELECT/ENTER** button changes the TV screen in the following order:

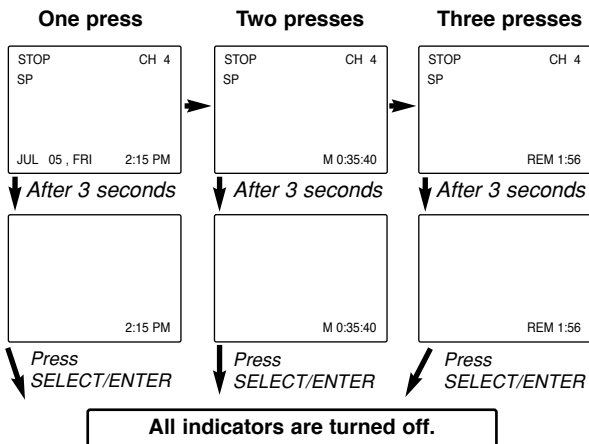

Notes

- Function displays remain on screen for 3 seconds.
- The CLOCK/COUNTER/REMAIN display will continue until you press **SELECT/ENTER**.
- The tape counter and the remaining tape length indicator appear only when a cassette is inserted. Also, the remaining tape length indicator appears after any tape operation.

On-Screen Menu System

Convenient on-screen menus allow you to set the clock, timer recordings and other setup preferences. The following pages describe the on-screen menu system.

Menu Selection

Your VCR allows remote control adjustment of several features.

1 Press **MENU** to display the **MAIN** menu.

2 Select the desired menu with the **▲/▼** buttons and then press **SELECT/ENTER**.

Note

Menus remain on-screen for 3 minutes.

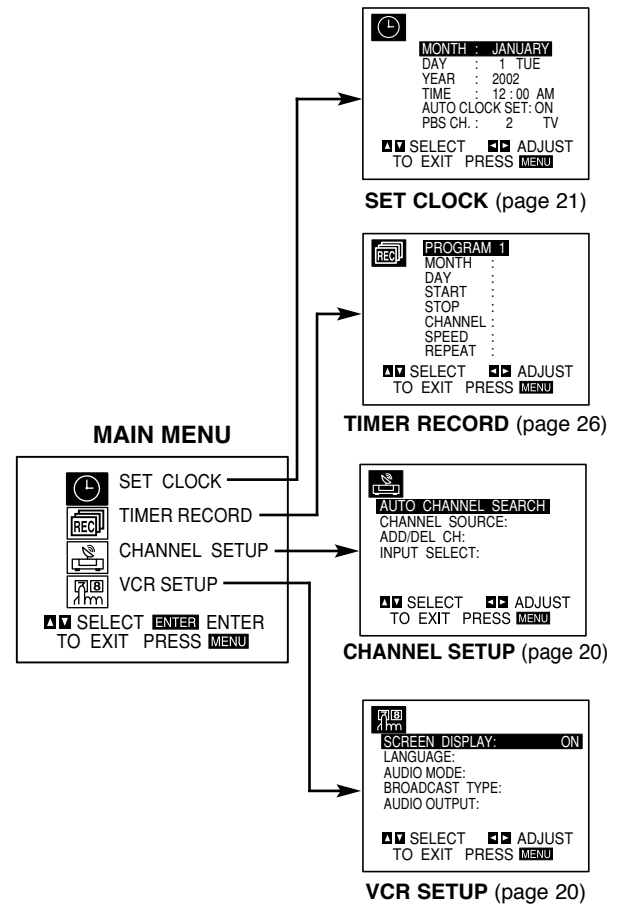

VCR Setup (Continued)

The VCR Setup Menu

- 1 Press **MENU** to display the **MAIN** menu.
- 2 Press **▲/▼** to display the **VCR SETUP** menu, then press **SELECT/ENTER**.
The **VCR SETUP** menu will appear.

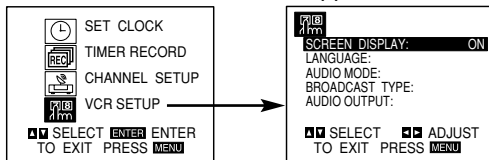

- 3 Press **▲/▼** to choose the desired option on the **VCR SETUP** menu. Then press **◀/▶** to choose the desired setting.

SCREEN DISPLAY

The DVD+VCR on-screen displays can be turned on or off.

- Press **◀/▶** to switch **SCREEN DISPLAY** between **ON** and **OFF**.

LANGUAGE

The DVD+VCR on-screen menus can be displayed in English, Spanish, or French.

- Press **◀/▶** to switch **LANGUAGE** among **ENGLISH**, **SPANISH** and **FRENCH**.

AUDIO MODE

The DVD+VCR has two separate audio playback systems: 1) High-quality VHS Hi-Fi system; and 2) Standard **NORMAL** mono system. The same audio is generally recorded on both systems. The VHS Hi-Fi system plays on separate (left and right) channels, and the **NORMAL** system plays monaural sound. The normal track is always played so the cassette can be played on a DVD+VCR that does not have VHS Hi-Fi.

- Press **◀/▶** to switch **AUDIO MODE** between **HI-FI** and **NORMAL**.

BROADCAST TYPE (STEREO/SAP/MONO)

Multi-channel Television Sound (MTS) carries stereo and/or Second Audio Program (SAP) audio signals. You only need to set **BROADCAST TYPE** when both MTS stereo and SAP signals are received. When only one of these MTS signals is received, the DVD+VCR will automatically select the corresponding receiving mode (Stereo or SAP) regardless of the selected position. For normal operation, the display should be in the **STEREO** position. The DVD+VCR will then record a **STEREO** program when available, and only record a **MONO** program if the program is not in stereo. For weak **STEREO** and/or **SAP** broadcasts, changing the display to **MONO** may give clearer sound.

- Press **◀/▶** to switch **BROADCAST TYPE** among **STEREO**, **SAP**, and **MONO**.

AUDIO OUTPUT (STEREO/LEFT/RIGHT)

Used during playback [when **AUDIO MODE** (**HI-FI**/**NORMAL**) is in **HI-FI** position] for selecting the audio output signals from the **AUDIO OUT** terminals (L ch and R ch), and **RF. OUT**.

This display setting should normally be left in the stereo position, so that when a stereo tape is played, the stereo sound will be heard through the left and right channels. If a mono tape is played and the audio output is set to stereo, the same mono sound will be heard from both left and right channels.

- Press **◀/▶** to switch **AUDIO OUTPUT** among **STEREO**, **LEFT**, and **RIGHT**.

Channel Selection

The DVD+VCR is equipped with a frequency synthesized tuner capable of receiving up to 181 channels. These include VHF channels 2-13, UHF channels 14-69 and CATV channels 1-125.

Before you begin:

- Connect the DVD+VCR to the desired type of antenna or cable TV system, as shown on page 11.

AUTO CHANNEL PROGRAMMING

- 1 Press **MENU** to display the **MAIN** menu.
- 2 Press **▲/▼** to select the **CHANNEL SETUP** menu, then press **SELECT/ENTER**.
The **CHANNEL SETUP** menu will appear.

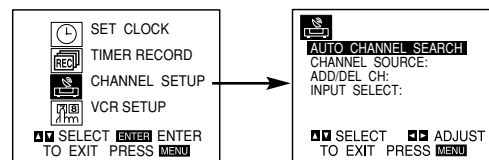

- 3 Press **▼** to choose the **INPUT SELECT** option, then press **◀/▶** to select **TUNER**.

Press **◀/▶** repeatedly to switch among **TUNER**, **LINE1** and **LINE2**.

- 4 Press **▲/▼** to choose the **AUTO CHANNEL SEARCH** option, then press **◀/▶** to find channels.

The tuner will automatically cycle through all available channels in the area and place them in the tuner's memory.

- 5 After **AUTO CHANNEL SEARCH** is complete, make sure the **CHANNEL SOURCE** is set appropriately in the **CHANNEL SETUP** menu. Press **▲/▼** to choose **CHANNEL SOURCE**, then press **◀/▶** to select **TV** or **CATV**.

Remember, **TV** is for the over-the-air antenna reception, and **CATV** is for cable or wireless cable connection.

- 6 Press **MENU** to return to the **TV** screen.

- 7 Use **CH/TRK (▲/▼)** or **CHANNEL (▲/▼)** on the front panel to cycle the DVD+VCR through the channels in memory.

TO ADD OR ERASE CHANNELS FROM MEMORY

This feature allows you to add or erase channels from memory manually.

- 1 Press **▼** to choose the **ADD/DEL CH** option on the **CHANNEL SETUP** menu. Press **◀/▶** to select a channel to add or erase.
- 2 Press **SELECT/ENTER** to add or erase the channel. Repeat steps 1 and 2 to add or erase channels.
- 3 Press **MENU** to return to the **TV** screen.

VCR Setup (Continued)

Setting the Clock

The DVD+VCR gives you two ways to set the time and date: Auto Clock Set or Manual Clock Set. Auto Clock Set enables the DVD+VCR to set the clock when the DVD+VCR is turned off.

Things to know before starting

- The clock uses the 12-hour system. Be sure to set AM and PM correctly.
- The initial clock setting is **JANUARY 1, 2002, 12:00 AM**.

Auto Clock Set

The Auto Clock Set feature is set to ON at the factory. In the ON setting, the DVD+VCR looks for a channel carrying XDS (Extended Data Services) information. XDS updates the clock using the Coordinated Universal Time.

Auto Clock Set enables the DVD+VCR to set the clock when the DVD+VCR is turned off.

- 1 Press **MENU** to display the MAIN menu.
- 2 Press **▲/▼** to choose the **SET CLOCK** menu, then press **SELECT/ENTER**. The **SET CLOCK** menu will appear.

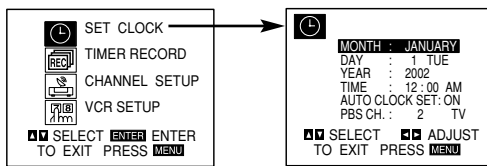

- 3 Press **▼** to choose the **AUTO CLOCK SET** option.

Press **◀/▶** to choose **ON**.

The Auto Clock Set feature is set to ON at the factory. In the ON setting, the DVD+VCR looks for a channel carrying XDS (Extended Data Services) information. XDS updates the clock using the Coordinated Universal Time.

- 4 Press **▼** to choose the **PBS CH.** option.
- 4 Press **◀/▶** to choose your local PBS channel.
- 5 Press **MENU** when finished.

Note

If Auto Clock Set sets the incorrect time (e.g., if your local TV station does not send the time, or sends the wrong date/time), you must set the clock manually.

Manual Clock Set

Example: July 5, 2002 - 2:15 AM

- 1 Press **MENU** to display the MAIN menu.
- 2 Press **▲/▼** to choose the **SET CLOCK** menu, then press **SELECT/ENTER**. The **SET CLOCK** menu will appear.

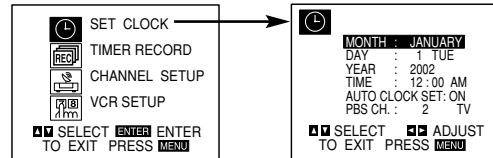

- 3 Press **◀/▶** to set the month.
- 4 Press **▼** to choose the **DAY** option. Use **◀/▶** to set the day. The day of the week will display automatically.
- 5 Press **▼** to choose the **YEAR** option. Use **◀/▶** to set the year.
- 6 Press **▼** to choose the **TIME** option. Use **◀/▶** to set the time.
- 7 Press **MENU** when finished.

Note

In order to set the clock manually, "AUTO CLOCK SET" must be set to "OFF".

If it is set to "ON", an incorrect date and/or time will be entered again when the DVD+VCR is turned off.

DVD Setup



Caution:

Before attempting DVD setup, press DVD to set the unit to DVD mode.

General Explanation

This section gives basic instructions for setting up DVD features and preferences. Some DVDs require special operations or allow only limited operation during playback. When this occurs, the  symbol appears on the TV screen, indicating that the operation is not permitted by the DVD+VCR or is not available on the disc.

On-Screen Display

General DVD playback status can be displayed on your TV screen by pressing the DISPLAY button.

On-screen display operation

1 Press DISPLAY during playback.

2 Press ▲ or ▼ to select an item.
The selected item will be highlighted.



Press ◀ or ▶ to change the setting of an item.

The number buttons can also be used for setting numeric entries (e.g., title numbers). For some functions, press SELECT/ENTER to execute the setting.

Temporary Feedback Icons



Repeat Title



Repeat Chapter



Repeat A-B



Repeat Off



Resume play from this point









Action prohibited or not available



Notes

- Some discs may not provide all of the features on the on-screen display example shown below.
- If no button is pressed for 10 seconds, the on-screen display disappears.

DVD

Items		Function (Press ▲/▼ to select the desired item)	Selection Method
Title Number	 1/3	Shows the current title number and total number of titles, and skips to the desired title number.	◀▶, or Numbers, SELECT/ENTER
Chapter Number	 1/12	Shows the current chapter number and total number of chapters, and skips to the desired chapter number.	◀▶, or Numbers, SELECT/ENTER
Time Search	 0:16:57	Shows the elapsed playing time, and allows direct time searches.	Numbers, SELECT/ENTER
Audio Language and Digital Audio Output mode	 1 ENG D D D 5.1 CH	Shows the current audio soundtrack language, encoding method, and channel number, and changes the setting.	◀▶
Subtitle Language	 OFF	Shows the current subtitles language, and changes the setting.	◀▶
Angle	 1/1	Shows the current angle number and total number of angles, and changes the angle number.	◀▶

DVD Setup (Continued)

Initial Settings

Follow these guidelines to set your personal preferences for DVD operation.

Initial Settings Overview

- 1 Press SETUP.**
The Setup menu appears.
- 2 Press ▲/▼ to select the desired item.**
The screen will show the current setting for the selected item, as well as alternate setting(s).
- 3 While the desired item is selected, press ►, then ▲/▼ to select the desired setting.**
- 4 Press SELECT/ENTER to confirm your selection.**
Some items require additional steps.
- 5 Press SETUP, RETURN, or PLAY (▷) to exit the Setup menu.**

Language

Disc Language **DVD**

Set your desired Disc Menu, Audio, and Subtitle languages.

Original : Selects the disc's default language.

Other : To select another language, use the number keys to enter the corresponding 4-digit number according to the language code list on page 41. If you enter the wrong language code, press CLEAR.



Menu Language

Select a language for the Setup menu. This is the menu you see when you press SETUP.



Picture

TV Aspect **DVD**

4:3 Letterbox: Select when a standard 4:3 TV is connected. Displays movies with masking bars above and below the picture.

4:3 Panscan: Select when a standard 4:3 TV is connected. Crops movies to fill your TV screen.

16:9 Wide: Select when a 16:9 widescreen TV is connected.

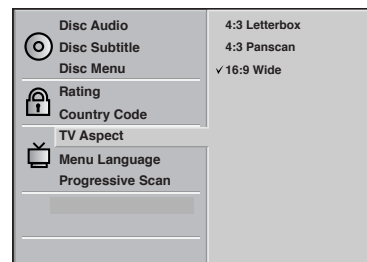

Progressive Scan **DVD**

Progressive Scan Video provides the highest quality pictures with less flickering.

If you are using the COMPONENT VIDEO OUT/PROGRESSIVE SCAN jacks, but are connecting the DVD Player to a standard (analog) television, set Progressive Scan to Off.

If you are using the COMPONENT VIDEO OUT/PROGRESSIVE SCAN jacks for connection to a TV or monitor that is compatible with a progressive scan signal, set Progressive Scan to On.



Notes

- Progressive Scan only works when the VIDEO OUTPUT switch on the rear panel is set to COMPONENT/PROGRESSIVE SCAN.

Caution

If Progressive Scan is set to On, an image will only be visible on a progressive scan compatible TV or monitor. If you set Progressive Scan to On in error, you must reset the unit. Press STOP (■) to stop any disc that is playing. Next, press STOP (■) again and hold it for five seconds before releasing it. The video output will be restored to the standard setting, and a picture will once again be visible on a conventional analog TV or monitor.

DVD Setup (Continued)

Parental Control

Rating **DVD**

Movies on DVDs may contain scenes not suitable for children. Therefore, discs may contain Parental Control information that applies to the complete disc or to certain scenes on the disc. These scenes are rated from 1 to 8, and alternatively, more suitable scenes are available for selection on some discs. Ratings are country-dependent. The Parental Control feature allows you to prevent discs from being played by your children or to have certain discs played with alternative scenes.

Disc Audio	8
Disc Subtitle	7
Disc Menu	6
Rating	5
Country Code	4
TV Aspect	3
Menu Language	2
Progressive Scan	1
	✓Unlock
	Change

- 1 Select "Rating" on the Setup menu using the ▲ and ▼ buttons.
- 2 While "Rating" is selected, press ►.
- 3 When you have not entered a password yet:
Enter a 4-digit password using the number buttons to create a personal 4-digit security password, then press SELECT/ENTER. Enter the 4-digit password again and press SELECT/ENTER to verify.
When you have already entered a password:
Enter a 4-digit password using the number buttons to confirm the personal 4-digit security password, then press SELECT/ENTER.

If you make a mistake before pressing SELECT/ENTER, press CLEAR and enter the 4-digit security password again.
- 4 Select a rating from 1 to 8 using the ▲/▼ buttons. One (1) has the least playback restrictions. Eight (8) has the most playback restrictions. If you select Unlock, Parental Control is not active. The disc will play in full. Some discs contain scenes not suitable for children. If you set a rating for the player, all disc scenes with the same rating or lower will be played. Higher rated scenes will not be played unless an alternative scene is available on the disc. The alternative must have the same rating or a lower one. If no suitable alternative is found, playback will stop. You must enter the 4-digit password or change the rating level in order to play the disc.
- 5 Press SELECT/ENTER to confirm your rating selection, then press SETUP to exit the menu.

Country Code **DVD**

Enter the code of a country/area whose standards were used to rate the DVD video disc, referring to the "Country Code List" on page 42.

Disc Audio	Code Set
Disc Subtitle	U S
Disc Menu	
Rating	
Country Code	
TV Aspect	
Menu Language	
Progressive Scan	

- 1 Select "Country Code" on the Setup menu using the ▲/▼ buttons.
- 2 While "Country Code" is selected, press ►.
- 3 Follow step 3 under "Rating" at left.
- 4 Select the first character using the ▲/▼ buttons.
- 5 Shift the cursor using ◀▶ buttons and select the second character using ▲/▼ buttons.
- 6 Press SELECT/ENTER to confirm your country code selection, then press SETUP to exit the menu.

Note

Confirmation of the 4-digit password is necessary when the code is changed (see "Changing the 4-digit code" below).

Changing the 4-digit code

- 1 Follow Steps 1-2 as shown under "Rating" at left.
- 2 Enter the old code, then press SELECT/ENTER.
- 3 Select Change using the ▲/▼ buttons then press SELECT/ENTER.
- 4 Enter the new 4-digit code, then press SELECT/ENTER.
- 5 Enter exactly the same code a second time and verify by pressing SELECT/ENTER.
- 6 Press SETUP to exit the menu.

If you forget your 4-digit code

To clear the current password, follow the procedure below:

- 1 Press SETUP to display the Setup menu.
- 2 Use the number buttons to enter the 6-digit number "210499".
The 4-digit password is cleared. "P CLR" appears on the display. The message will appear if the disc tray is closed. It will be on the display until you try another feature.
- 3 Enter a new code as shown under "Rating" at left.

VCR Operation

Normal Playback

Before you begin:

- Turn on the TV.
- Tune the TV to the DVD+VCR output channel (CH 3 or 4) or set the TV's source selector to VIDEO.
- If a direct AUDIO/VIDEO connection is made between the DVD+VCR and your TV, set the TV's source selector to VIDEO.
- Press VCR to set the Output Source to VCR as shown in "Setting the Output Source" on page 15.

1 Insert a prerecorded video cassette.

The  indicator will light and the DVD+VCR will power on automatically.

- Make sure that the TIMER indicator on the front panel display is not lit. If it is, press **POWER** once.
- If a tape without a record safety tab is inserted, the unit will start playback automatically.

2 Press **PLAY** () once.

PLAY appears on the TV screen.

- It is not necessary to select the tape speed for playback. It will be set automatically by the DVD+VCR.
- During playback, the **TV/VCR** selector switches to VCR mode automatically.

3 Press **STOP** () to stop playback.

STOP appears on the TV screen.

- If the tape reaches the end before **STOP** () is pressed, the DVD+VCR will automatically stop, rewind, eject, and turn itself off.

Tracking Control

Auto Tracking

The automatic tracking function adjusts the picture to remove snow or streaks. The AUTO TRACKING function works in the following cases:

- When a tape is played back for the first time.
- When the tape speed (SP, LP, EP) changes.
- When streaks or snow appear because of scratches on the tape.

Manual Tracking

If noise appears on the screen during playback, press either **CH/TRK** (+/-) on the remote control or **CHANNEL** () on the front panel until the noise on the screen is reduced.

- In case of vertical jitter, adjust these controls very carefully.
- Tracking is automatically reset to normal when the tape is ejected or the power cord is unplugged for more than 3 seconds.



Special Playback Effects

Notes on Special Playback Effects





- Horizontal lines (noise bars) will appear on the TV screen. This is normal.
- The audio is automatically muted during special effect modes, so there is no sound during search.
- During the high-speed picture search modes, a short period is needed to stabilize tape speed when re-entering the PLAY mode. Slight interference may be observed during this period.

Search



This function allows you to visually search forward or backward for a desired tape section.

- 1 Press **REW** () or **FF** () during playback. Visual search backward or forward will be activated.
 - If the DVD+VCR is left in search mode for more than 3 minutes, the DVD+VCR will automatically enter play mode, to protect the tape and video heads.
- 2 To return to normal playback, press **PLAY** ()

Still Picture and Frame-by-Frame Playback

- 1 Press **PAUSE/STEP** () during playback. The player will go into still mode.
 - If a still picture vibrates vertically, stabilize it by pressing **CH/TRK** () on the remote control.
 - If the DVD+VCR is left in still mode for more than 5 minutes, the DVD+VCR will automatically enter stop mode to protect the tape and video heads.
- 2 Press **PAUSE/STEP** () repeatedly to advance the video picture one frame at a time.
- 3 To return to normal playback, press **PLAY** ()

Slow Motion

- 1 While in still mode, press **FORWARD** ()
The tape will be played back at a speed 1/19 times slower than the normal speed.
 - During slow playback, use **CH/TRK** () on the Remote Control to minimize noise bands.
 - If slow motion mode continues for more than 30 seconds, the DVD+VCR will automatically change to playback mode.
- 2 To return to normal playback, press **PLAY** ()

Commercial Skip

This feature allows you to skip commercials or short program segments in 30 second increments.

- 1 Press **SKIP** during playback mode.
The tape will fast forward picture search through 30 seconds of recording.
 - The skipping time can be extended by pressing **SKIP** repeatedly.
 - Subsequent presses will advance the search time in 30-second increments up to 2 minutes.
- 2 When the search is complete, the DVD+VCR will return to normal playback mode automatically.

VCR Operation (Continued)

Normal Recording

Before you begin:

- Power on the DVD+VCR and TV.
- Tune the TV to the DVD+VCR output channel (CH 3 or 4) or set the TV's source selector to VIDEO.
- If a direct AUDIO/VIDEO connection is made between the DVD+VCR and the TV, set the TV's source selector to VIDEO.

1 Insert a video cassette with the record safety tab intact.

2 Select the desired channel by using CH/TRK (▲/▼) or the number keys (0-9).

- If you are recording from an external source via the audio/video input jacks, select LINE1 (rear jacks) or LINE2 (front jacks) by pressing INPUT.

3 Set the desired recording speed (SP or EP) by pressing SP/EP.

- The DVD+VCR is not designed to record in LP mode.

4 Set the MTS mode as desired (See pages 20, 29).

5 Press REC/OTR (●) once.

Recording will start. (The REC indicator will light on the front panel display.)

- If a cassette with no record safety tab is loaded, the cassette will be ejected automatically.

6 Press STOP (■) to stop recording.

If the tape reaches the end before STOP (■) is pressed, the DVD+VCR will automatically stop, rewind, eject, and turn itself off.

To pause the recording

1 Press PAUSE/STEP (||) to pause the tape during recording.

The REC indicator will flash on the front panel display.

2 When you want to continue recording, press PAUSE/STEP (||) or press REC/OTR (●).

- After 5 minutes in pause mode, the tape will be stopped automatically to protect the tape and the video heads.

To record one TV program while watching another

- 1 Press TV/VCR to select TV mode during recording. The VCR indicator disappears.
- 2 Using your TV's remote control, select the channel to be viewed.

Tips

For best results, always use PAUSE/STEP (||) when making changes during recording. For example, to change channels during recording, first press PAUSE/STEP (||) to put the unit in pause mode. Next, select the desired channel on the DVD+VCR, and then press PAUSE/STEP (||) again to resume recording.

Timer Recording

The DVD+VCR can be programmed to record up to 8 programs within a period of 1 year. Simply enter the channel to be recorded and the starting and ending time for each recording.

Things to know before starting

- If you try to set a timer recording before setting the clock, PLEASE SET THE CLOCK appears for a moment and then the SET CLOCK menu appears on the TV screen. Set the time and date before proceeding.
- Make sure a tape is in the DVD+VCR and the record safety tab is in place or the tape will be automatically ejected.

Before you begin:

- Power on the DVD+VCR and the TV.
- Be sure the TV is set to the DVD+VCR output channel (3 or 4).
- Make sure the CHANNEL SOURCE in the CHANNEL SETUP menu is set appropriately (TV or CATV).

1 Press MENU to display the MAIN menu.

2 Use ▲/▼ to choose the TIMER RECORD menu.

3 Press SELECT/ENTER to go to the TIMER RECORD menu.

The TIMER RECORD menu will appear.

- If all programs have already been entered, MAX NUMBER OF EVENTS SCHEDULED will appear for a moment and then PROGRAM 1 will appear on the TV screen.

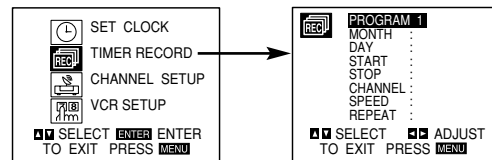

4 Use ◀/▶ to choose the PROGRAM No. (1-8).

5 Use ▼ to choose the MONTH option.

Use ◀/▶ to set the desired month.

6 Use ▼ to choose the DAY option.

Use ◀/▶ to set the desired day.

7 Use ▼ to choose the START option.

Use ◀/▶ to set the desired start time.

8 Use ▼ to choose the STOP option.

Use ◀/▶ to set the desired stop time.

9 Use ▼ to choose the CHANNEL option.

Use ◀/▶ to set the desired channel (Channel, LINE1 or LINE2).

Cable Users: If you have CABLE TV and are using a cable box converter, you must set the channel in this step to match the cable box output channel (usually CH 3 or 4). Change channels on the cable box instead of with the DVD+VCR.

VCR Operation (Continued)

- 10** Use **▼** to choose the **SPEED** option. Use **◀▶** to choose the desired recording speed (**AUTO**, **SP** or **EP**).
- **AUTO** mode determines how much tape is left and switches the recording speed from **SP** to **EP**, if necessary, to complete recording the program. There will be some picture and sound distortion at the point of the speed change.

- 11** Use **▼** to choose the **REPEAT** option. Use **◀▶** to choose the desired repeat setting (**ONCE**, **WEEKLY**, or **DAILY**).
- ONCE:** For recording a single event.
WEEKLY: For recording an event once a week on a certain day.
DAILY: For recording an event at the same time Monday through Friday.

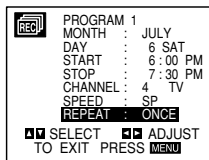

Tip

If the input data is wrong, use **▲** to select the data and correct it using **◀▶**.

- 12** Press **MENU** to store the program in memory.

- If the program start time is past, the **EVENT SCHEDULED IN THE PAST** message will appear on the TV screen. Return to the incorrect program and program it with the correct time.
- If you enter a past date, the timer recording will be performed on that date the following year.
- Additional programs may be entered by repeating steps 1-12.

Cable Users: If your cable hookup is via a TV converter box, you can program multiple recordings only on the converter box output channel. This is because the converter determines what channel you view through your DVD+VCR.

- 13** Turn the **DVD+VCR** off for timer recording to take place.

Tip

If you are finished programming and you want to set the DVD+VCR to record the programs you have entered:

A) MAKE SURE YOU HAVE INSERTED A TAPE INTO THE DVD+VCR. B) YOU MUST TURN OFF THE DVD+VCR BEFORE IT WILL RECORD ANY TIMER PROGRAMS. (the TIMER indicator will light). The DVD+VCR is now set to record the preset programs.

Note

If the power fails or the DVD+VCR is unplugged from the AC outlet, the correct clock time and timer settings are kept in memory for approximately 3 seconds. After 3 seconds, the clock and program timer must be reset when power is restored. Reset the clock according to the instructions on page 21.

Checking (Erasing) the Timer Program

Programming can be checked whenever the DVD+VCR is turned on.

- 1 Press **MENU** to display the **MAIN** menu.
- 2 Use **▲/▼** to choose the **TIMER RECORD** menu. Press **SELECT/ENTER** and the **TIMER RECORD** menu will appear.

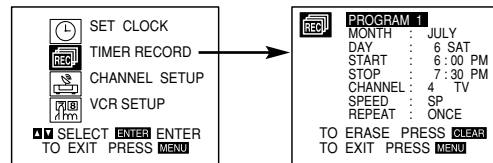

- 3 Use **◀▶** to select a program you want to check or erase. If you want to erase the program, press **CLEAR**.
- 4 Press **MENU** to return to the TV screen.

Program Priority

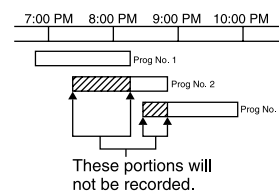

These portions will not be recorded.

If the recording start and end times of preset programs overlap on the same day (see the example and diagram left), program number 2 will not be recorded until program number 1 is finished.

The first part of program number 2 will not be recorded. The same thing will happen to program number 3.

VCR Operation (Continued)

One-Touch Recording

One-Touch Recording allows you to quickly make a recording of a preset length without using the program timer.

Before you begin:

- Power on the DVD+VCR and the TV.
- Be sure the TV is tuned to the DVD+VCR output channel (3 or 4).
- If a direct AUDIO/VIDEO connection is made between the DVD+VCR and the TV, set the TV's source selector to VIDEO.

1 Insert a video cassette with the record safety tab intact.

2 Select the desired channel by using CH/TRK (▲▼) or number (0-9).

The channel number appears on the TV screen.

- If you are recording from an external source via the audio/video input jacks, select LINE1 (rear jacks) or LINE2 (front jacks) by pressing INPUT.

3 Set the desired recording speed (SP or EP) by pressing SP/EP.

The tape speed will appear on the TV screen.

4 Press REC/OTR (●) twice.

The One-Touch Record menu will appear on the TV screen.

- Recording will start and the TIMER indicator will light.

5 Press REC/OTR (●) repeatedly to select the recording time length.

At the end of the recording, the DVD+VCR will stop recording and shut off.

- During One-Touch Recording, changing the channel on the DVD+VCR will not be possible.
- You can stop the recording by pressing STOP (■).

ONE-TOUCH RECORD	
CHANNEL	2
SPEED	SP
START LENGTH	NOW 0H30M

0H30M 9H00M → 0H00M
↑
Length Display
(each additional press of
REC/OTR (●) increases recording
time 30 minutes)

Checking the Recording Time

Press REC/OTR (●) once to check the recording time. The recalled setting will be displayed for 6 seconds and then return to the TV automatically.

Extending the Recording Time

The recording time can be extended anytime by pressing REC/OTR (●).

Subsequent presses will increase the recording time in 30-minute increments.

Notes

- If you press PAUSE/STEP (||) during One-Touch Recording, the DVD+VCR will enter record pause mode. One-Touch Recording will be cancelled.
- If the DVD+VCR is set to "0H00M", the DVD+VCR goes to normal recording mode.

Dubbing and Editing

If you wish to edit or dub recordings from your camcorder (or another VCR) to this DVD+VCR, connect your device to the line inputs on the front or rear panels. These direct A/V jacks will provide better picture results than using the RF jack on the rear panel.

1 Connect the camcorder's (or another VCR's) A/V outputs to the DVD+VCR as illustrated on page 14.

2 Press INPUT to select LINE 1 (rear) or LINE2 (front).

3 Play the tape in the camcorder (or another VCR). If you have a TV attached to your DVD+VCR, you can see the video playing.

4 When you are ready to begin recording, press the DVD+VCR's REC/OTR (●) button once to start.

Note

Before recording, please confirm the recording start position.

Copying from DVD to VCR

The DVD+VCR allows you to copy the contents of a DVD to a VHS tape with a press of the COPY button.

Note

- If the DVD you are attempting to copy is copy protected, you will not be able to copy the disc ("LOCK" is displayed on the front panel display). It is not permitted to copy Macrovision encoded DVDs.

1 Insert Disc

Insert the disc you wish to copy in the DVD deck and close the disc tray.

2 Insert VHS Tape

Insert a blank VHS video tape into the VCR deck.

3 Press the COPY button on the front panel.

The DVD will go into play mode and the VCR will go into record mode.

- If the DVD disc menu appears, you may need to press PLAY (▶) manually to begin copying.

4 Stop the Copy Process

When the DVD is finished playing, press VCR on the remote control and then press STOP (■) to end the copy.

You must stop the Copy process manually when the DVD movie ends, or the unit may replay and record over and over again.

Note

When you stop the DVD playback during copying, the recording on VCR is stopped automatically.

VCR Operation (Continued)

VHS Hi-Fi Stereo System/ MTS Broadcast

The DVD+VCR is equipped with the VHS Hi-Fi audio sound system for recording and playback. The information below gives a brief description of Hi-Fi audio and how to record and play a tape in Hi-Fi audio mode.

Playback with Hi-Fi Stereo Audio Sound

A stereo TV with AUDIO/VIDEO input jacks or a stereo audio system is required for true stereo playback. To experience the full and rich stereo sound available with Hi-Fi recorded tapes, we recommend the connection of this unit to a home stereo audio system.

1 Set the AUDIO MODE option to HI-FI in the VCR SETUP menu.

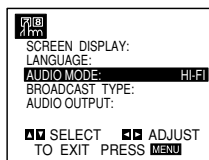

2 Set the AUDIO OUTPUT option to STEREO.

STEREO: The left channel sound (L) is heard from the left speaker and the right channel sound (R) is heard from the right speaker.

LEFT: The left channel sound (L) is heard from both speakers.

RIGHT: The right channel sound (R) is heard from both speakers.

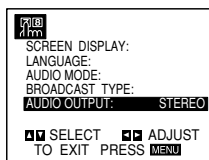

3 Insert a cassette and press PLAY (▶). Adjust the volume on your stereo system.

Multi-Channel TV Sound (MTS)

The DVD+VCR will decode MTS stereo and bilingual (SAP) off-the-air broadcast sound signals. It also decodes stereo TV sound from local cable companies, as long as they operate on assigned cable frequencies and use the EIA-recommended MTS stereo/bilingual TV sound system.

MTS Indicator

Shows on-screen as illustrated below when **SELECT/ENTER** is pressed.

- One or both of the indicators will light, depending on the MTS broadcast.

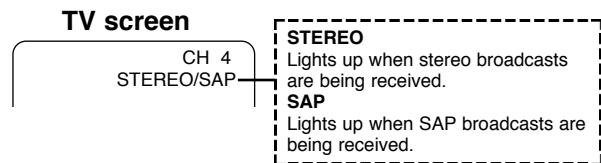

If only STEREO appears on the TV screen:

The DVD+VCR can record in stereo onto the VHS Hi-Fi audio tracks if the BROADCAST TYPE option is set to STEREO in the VCR Setup menu. The DVD+VCR will also record mono audio onto the mono audio track.

If only SAP appears on the TV screen:

Set the BROADCAST TYPE option to SAP.

If STEREO/SAP appears on the TV screen:

Use the BROADCAST TYPE option to select the desired recording mode (STEREO or SAP).

SAP (Second Audio Program) Recording

Some stations transmit a Second Audio Program, which is used for a second language or additional information. When the station broadcasts a Second Audio Program, follow the procedure below to record the SAP.

1 Insert a video cassette with the record safety tab intact.

2 Set BROADCAST TYPE to SAP in the VCR SETUP menu.

Do this only if SAP appears on the TV screen or you know the program will use SAP.

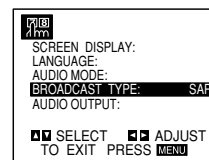

3 Set the desired recording speed (SP or EP) by pressing SP/EP.

4 Select the desired channel. SAP should appear on the TV screen.

5 Press REC/OTR (●) once

You are now recording the program you see and hear on the TV.

6 Press STOP (■) to stop recording.

VCR Operation (Continued)

Tape Counter Memory Feature

Real-Time Counter

Press **CLK/CTR** to select the real-time counter display, which shows the length of the tape in hours, minutes, and seconds.

Every press of **CLK/CTR** changes the TV screen as illustrated below.



- The counter changes to "M 0:00:00" when the cassette is ejected.
- The real-time counter does not operate if nothing is recorded on the tape.
- The real-time counter will not work unless a tape is inserted.

Counter Memory Function

This is useful if there is a section of tape you want to view immediately after recording or if you want to return to the same point several times.

- 1** Begin recording or playing a tape.
- 2** Press **CLK/CTR** repeatedly to display the real-time counter on the TV screen.
- 3** At the point that you want to locate later, reset the real-time counter to "M 0:00:00" by pressing **CLEAR**.
- 4** Continue to play or record.
- 5** Press **STOP** (■) when recording or playback finishes.
- 6** Press **REW** (◀◀).
The tape automatically stops when the tape counter returns to about "M 0:00:00".

Tape Remaining

This function displays the time remaining on the tape during recording or playback.
Press **CLK/CTR** until the REM indicator displays on the TV screen during recording or playback.

Note

The remaining tape length indicator may not be displayed correctly depending on the condition of the tape and the kind of the tape (T-140, T-160, T-210, etc.).

Additional VCR Information

- During manual recording, Timer recording, One-Touch Recording, playback, or fast forward modes, the DVD+VCR automatically starts rewinding the tape at the end of the tape. The cassette will stop at the beginning of the tape and be ejected, and the DVD+VCR will turn itself off.
- After you have finished using the DVD+VCR, rewind, eject, and remove the cassette. Place the cassette in its protective sleeve to protect it from dust. It is not necessary to rewind the cassette before removing it, but if you do, it will be ready to play or record the next time you use it.
- Be sure the DVD+VCR Channel Selector is on the correct channel you wish to record. The channel that is being recorded can always be checked by setting the television on the DVD+VCR channel (3 or 4) and pressing the **TV/VCR** selector to turn the DVD+VCR's VCR indicator on.
- Do not attempt to hook up more than one television set to the DVD+VCR for either recording or playback.

Auto Play System

The DVD+VCR features automatic playback when you load a cassette with the record safety tab removed (such as with most pre-recorded or rented movies).

- The power turns on automatically and playback begins.
- At the end of the tape, the DVD+VCR stops, then rewinds.
- The cassette is ejected after rewinding and the unit turns itself off automatically.



DVD Operation

Playing a DVD

Playback Setup **DVD**

- Turn on the TV and select the video input source connected to the DVD player.
- Audio system: Turn on the audio system and select the input source connected to the DVD player.
- Press DVD to set the Output Source to DVD as shown in "Setting the Output Source" on page 15.

1 Press EJECT to open the disc tray.

2 Load the disc in the tray with the label facing up.

When a double-sided DVD is inserted, make sure the side you want to play is facing up.

3 Press EJECT to close the tray.

READING appears on the TV screen, and playback starts automatically. If playback does not start, press PLAY.

In some cases, the disc menu might appear instead.

If a menu screen is displayed

The menu screen may be displayed first after loading a DVD which contains a menu.

DVD

Use the ◀ ▶ ▲ ▼ buttons to select the title/chapter you want to view, then press SELECT/ENTER to start playback.

Press TITLE or MENU to return to the menu screen.

Notes

- If Parental Control is set and the disc is not within the Rating settings (not authorized), the 4-digit code must be entered and/or the disc must be authorized (see "Parental Control", on page 24).
- Many DVDs have specific region codes. Your player will not play discs that have a region code different from your player. The region code for this player is 1 (one).

General DVD Features

Note

Unless stated otherwise, all instructions in this section refer to remote control operation. Some features may also be available in the Setup menu.

Moving to another TITLE **DVD**



When a disc has more than one title, you can move to another title as follows:

- Press DISPLAY when playback is stopped, then press the appropriate number button (0-9) to select a title number.

Moving to another CHAPTER/TRACK



When a title on a disc has more than one chapter, you can move to another chapter/track as follows:

- Press ◀◀ or ▶▶ briefly during playback to select the next chapter or to return to the beginning of the current chapter/track.
- Press ◀◀ twice briefly to step back to the previous chapter/track.
- To go directly to any chapter during DVD playback, press DISPLAY. Then, press ▲/▼ to select C (chapter). Then, enter the chapter/track number using the number buttons (0-9).

Note

For two-digit numbers, press the buttons in rapid succession.

Slow Motion **DVD**

- 1 Press SLOW ◀◀ or ▶▶ during playback. The player will enter slow motion mode.
- 2 Use the SLOW ◀◀ or ▶▶ buttons to select the desired playback speed: ◀◀ 1/16, ◀◀ 1/8, ◀◀ 1/4 or ◀◀ 1/2 (backward), or ▶▶ 1/16, ▶▶ 1/8, ▶▶ 1/4 or ▶▶ 1/2 (forward).
- 3 To exit slow motion mode, press PLAY.

DVD Operation (Continued)

General Features (continued)

Still Picture and Frame-by-Frame Playback

DVD

- 1 Press PAUSE/STEP (II) during playback.
The player will go into pause mode.
- 2 You can advance the picture frame-by-frame by pressing PAUSE/STEP (II) repeatedly on the remote control.

Search

DVD

- 1 Press and hold PREV (I<<<) or NEXT (I>>>) for about two seconds during playback.
The player will go into search mode.
- 2 Press and hold PREV (I<<<) or NEXT (I>>>) to select the desired speed: I<<<X2, I<<<X4, I<<<X16, I<<<X100 (backward) or I>>>X2, I>>>X4, I>>>X16, I>>>X100 (forward).
- 3 To exit search mode, press PLAY (I>).

Random

DVD

- 1 Press RANDOM during playback or in stop mode.
The unit automatically begins Random Playback and "RAND." appears on the front panel display.
- 2 To return to normal playback, press RANDOM until "RAND." disappears from the front panel display.

Tips

If you press PREV (I<<<) or NEXT (I>>>) during Random playback, the unit selects another track and resumes Random playback.

Repeat

DVD



DVD Video Discs - Repeat Chapter/Title/Off

- 1 To repeat the currently playing chapter, press REPEAT.
The Repeat Chapter icon appears on the TV screen.
- 2 To repeat the title currently playing, press REPEAT a second time.
The Repeat Title icon appears on the TV screen.
- 3 To exit repeat mode, press REPEAT a third time.
The Repeat Off icon appears on the TV screen.

Repeat A-B

DVD



To repeat a sequence in a title:

- 1 Press A-B at the desired starting point.
A- appears briefly on the TV screen.
- 2 Press A-B again at the desired ending point.
A-B appears briefly on the TV screen, and the repeat sequence begins ("A-B" also appears on the front panel display).
- 3 To cancel the sequence, press A-B.

Time Search

DVD

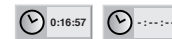

The Time Search function allows you to start playback at any specified time on the disc.

- 1 Press DISPLAY during playback. The on-screen display appears on the screen.
The Time Search box shows the elapsed playing time of the current disc.
- 2 Within 10 seconds, press I▲/I▼ to select the Time Search icon in the on-screen display.
The "I-:-:-:-" appears in the Time Search box.
- 3 Within 10 seconds, use the number buttons to enter the required start time. Enter hours, minutes, and seconds from left to right in the box.
If you enter the wrong numbers, press CLEAR to remove the numbers you entered. Then enter the correct numbers.
- 4 Within 10 seconds, press SELECT/ENTER to confirm the start time.
Playback starts from the selected time on the disc. If you enter an invalid time, playback will continue from the current point.

DVD Operation (Continued)

General DVD Features (cont.)

Zoom **DVD**

The Zoom function allows you to enlarge the video image and move around the enlarged image.

- 1 Press ZOOM during playback or still playback to activate the Zoom function.
Press ZOOM repeatedly to increase the magnification level up to six times.
- 2 Use the ◀▶ ▲▼ buttons to move around the zoomed picture.
- 3 Press CLEAR to resume normal playback or return to the paused image.

Note

- The Zoom function may not work on some DVDs.
- The Zoom function may not work on multi-angle scenes.

Marker Search **DVD**



You can start playback from a memorized point. Up to nine points can be memorized. To enter a mark, follow these steps.

- 1 During disc playback, press MARKER when playback reaches the spot you want to memorize.
The Marker icon will appear on the TV screen briefly.
- 2 Repeat step 1 to enter up to nine Marker points on a disc.

To Recall a Marked Scene

- 1 During disc playback, press SEARCH.
The MARKER SEARCH menu will appear on the screen.
- 2 Within 10 seconds, press ◀▶ to select the Marker number you want to recall.
- 3 Press SELECT/ENTER.
Playback will start from the Marked scene.
- 4 To remove the MARKER SEARCH menu, press SEARCH.

To clear a Marked Scene

- 1 During disc playback, press SEARCH.
The MARKER SEARCH menu will appear on the screen.
- 2 Press ◀▶ to select the Marker number you want to erase.
- 3 Press CLEAR.
The Marker number will be erased from the list.
- 4 Repeat steps 2 and 3 to erase additional Marker numbers.
- 5 To remove the MARKER SEARCH menu, press SEARCH.

Special DVD Features **DVD**

Checking DVD contents

DVDs may contain disc menus that allow you to access special features. To view a disc's menu, press MENU. To make selections, press the appropriate number button or use the ◀▶ ▲▼ buttons to highlight your selection, then press SELECT/ENTER.

Title Menu **DVD**

- 1 Press TITLE.
If the current title has a menu, the menu will appear on the screen. Otherwise, the disc menu may appear.
- 2 The menu may list available camera angles, audio/subtitle languages, and/or chapters.
- 3 To remove the title menu, press TITLE again.

Disc Menu **DVD**

- 1 Press MENU.
The disc menu is displayed.
- 2 To remove the disc menu, press MENU again.

Camera Angle **DVD**

If the disc contains scenes recorded at different camera angles, you can change to a different camera angle during playback.

- Press ANGLE repeatedly during playback to select a desired angle.
The number of the current angle appears on the display.

Changing the Audio Language **DVD**



Press AUDIO repeatedly during playback to listen to a different audio language or audio track.

Subtitles **DVD**

Press SUBTITLE repeatedly during playback to see the different subtitle languages.

Note

If Ⓞ appears, the feature is not available on the disc.

Audio CD and MP3 Operation

Playing Audio CD and MP3 discs

The DVD+VCR can play MP3 files on CD-ROM, CD-R, or CD-RW discs.

Before playing MP3 files, please read "Notes on MP3 Discs" on page 36.

- 1 Insert the CD or MP3 disc and close the tray.**
The CD or MP3 menu is displayed on the TV screen.

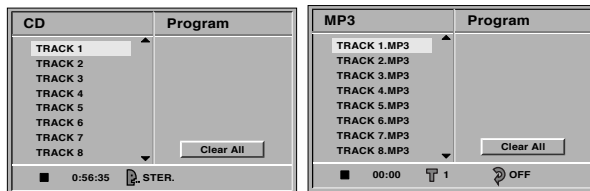

Audio CD menu

MP3 menu

- 2 Press ▲/▼ to select the desired track, then press PLAY (▶).**
Playback starts.
During playback, the current track's elapsed playing time will appear on the display.
Playback will stop at the end of the disc.
- 3 To stop playback at any other time, press STOP (■).**

Pause **CD** **MP3**

- 1 Press PAUSE/STEP (⏸) during playback.
- 2 To return to playback, press PLAY (▶) or press PAUSE/STEP (⏸) again.

Moving to another Track **CD** **MP3**

- Press PREV (⏮) or NEXT (⏭) during playback to go to the next track or to return to the beginning of the current track.
- Press PREV (⏮) twice to step back to the previous track.
- To go directly to any track on an audio CD, enter the track number using the number buttons (0-9) during playback.

Repeat Track/All/Off **CD** **MP3**

- 1 To repeat the track currently playing, press REPEAT.
The Repeat Track icon appears on the menu screen.
- 2 To repeat all tracks on a disc, press REPEAT a second time.
The Repeat All icon appears on the menu screen.
- 3 To cancel repeat mode, press REPEAT a third time.
The Repeat Off icon appears on the menu screen.

Search **CD**

- 1 Press and hold PREV (⏮) or NEXT (⏭) for about two seconds during playback.
The player will go into search mode.
- 2 Press and hold PREV (⏮) or NEXT (⏭) continuously to select the desired speed: ⏮X2, ⏮X4, ⏮X8 (backward) or ⏭X2, ⏭X4, ⏭X8 (forward).
- 3 Search speed and direction are indicated on the menu screen.
- 4 To exit search mode, press PLAY (▶).

Random **CD**

- 1 Press RANDOM during playback or when playback is stopped.
The unit automatically begins Random Playback and RANDOM or "RAND." appears on the front panel display and menu screen.
- 2 To return to normal playback, press RANDOM repeatedly until RANDOM or "RAND." disappears from the front panel display and menu screen.

Repeat A-B **CD**

To repeat a sequence.

- 1 During disc playback, press A-B at the desired starting point.
The Repeat icon and "A -" appear on the menu screen.
- 2 Press A-B again at the desired ending point.
The Repeat icon and "A-B" appear on the menu screen, and the sequence begins to play repeatedly.
- 3 To exit the sequence and return to normal play, press A-B again.
The Repeat icon and "OFF" appear on the menu screen.

Changing the Audio Channel **CD**

Press AUDIO repeatedly during playback to hear a different audio channel (STEREO, LEFT, or RIGHT).

Programmed Playback **CD** **MP3**

Programmed Playback with Audio CD and MP3 Discs

The program playback feature allows you to store your favorite tracks for a particular disc in the player's memory. Each custom program can contain up to 32 tracks (Audio CD) or 60 tracks (MP3 disc).

1 Insert the CD or MP3 disc and close the tray.
The CD or MP3 menu is displayed on the TV screen.

2 Press **PROGRAM** during playback or in stop mode to enter Program Edit mode.

The  icon will appear next to Program on the menu screen.

Note

Press **PROGRAM** to exit Program Edit mode (the  icon will disappear).

3 Press **▲/▼** to select a track, then press **SELECT/ENTER** to place the selected track in the Program list.

4 Repeat step 3 to place additional tracks in the Program list.

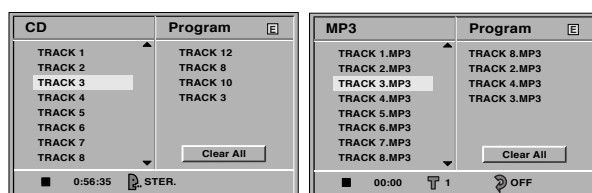

Audio CD menu

MP3 menu

5 Press **▶**.
The programmed track you selected last is highlighted on the program list.

6 Press **▲/▼** to select the track you want to start playing.

Press **TITLE** to move to the next page.
Press **MENU** to move to the previous page.

7 Press **PLAY (▶)** to start.

Playback begins in the order in which you programmed the tracks and "PROG." appears on the menu screen. Playback stops after playing the last programmed track on the program list.

Repeat Programmed Tracks

- To repeat the track currently playing, press **REPEAT**. The Repeat Track icon appears on the menu screen.
- To repeat all tracks on the program list, press **REPEAT** a second time. The Repeat All icon appears on the menu screen.
- To cancel repeat mode, press **REPEAT** a third time. The Repeat Off icon appears on the menu screen.

Erasing a Track from the Program List

1 Press **PROGRAM** during playback or in stop mode to enter Program Edit mode.

The  icon will appear.

2 Press **▶** to move to the Program list.

3 Use **▲/▼** to select the track you wish to erase from the Program list.

4 Press **CLEAR**.

The track will be erased from the Program list.

Erasing the Program List

1 Follow steps 1-2 of "Erasing a Track from the Program List" as above.

2 Use **▲/▼** to select "Clear All", then press **SELECT/ENTER**.

The entire program for the disc will be erased.

The program list is also cleared when the disc is removed.

To resume normal playback from programmed playback

Press and hold **PROGRAM** for 3 seconds until the "PROG." indicator disappears from the front panel display.

Additional DVD Information

Screen Saver

A screen saver appears when you leave the DVD+VCR in stop mode for about five minutes. After the screen saver has been active for about five minutes, the DVD+VCR will power off automatically.

Video Mode Setting **DVD**

- With certain discs, the picture may flicker or you may see "dot crawl" along straight lines. This usually means that the unit's vertical interpolation and/or de-interlace are not perfectly matched with the disc. If so, you may be able to improve picture quality by changing the video mode.
- To change the video mode, press and hold DISPLAY for about 3 seconds during disc playback. The new video mode number is displayed on the TV screen. Check whether the video quality has improved. If not, repeat the above procedure until picture quality is improved.
- Video mode change sequence:
MODE1 → MODE2 → MODE3 → MODE4 →
MODE5 → MODE1
- If you turn off the power, the video mode will revert to its initial state (MODE1).

Notes on MP3 Discs

About MP3

- MP3 files are audio data files compressed using MPEG1, the standard audio layer-3 file encoding scheme that compresses audio files up to 1/12 of their original size. Files with the ".mp3" file extension are referred to as "MP3 files".
- The player can only read MP3 files with the ".mp3" file extension. However, it cannot read fake MP3 files that have the ".mp3" file extension.

MP3 disc compatibility with this player is limited as follows:

1. Sampling Frequency: 44.1kHz only
2. Bit rate: from 32 - 320kbps
3. CD-R physical format: "ISO 9660"
4. If you record MP3 files using encoding software that cannot create a file system (for example "Direct-CD"), the disc cannot be played. "Easy-CD Creator" is recommended, as it creates an ISO9660 file system.
5. A single session disc requires MP3 files in the first track. If there are no MP3 files in the first track, the disc cannot be played. If you wish to playback MP3 files, format all the data in the disc or use a new one.
6. CD-RW discs are not recommended. Please use finished CD-R discs only.
7. File names must be 8 letters or less and must incorporate the ".mp3" extension; e.g., "song.mp3".
8. Do not use special characters, such as "_?!\<>+*}{[@]:,;V.," etc.
9. The total number of files on the disc should be less than 200.
10. Use 74-minute CD-R discs (650M). Do not use 80-minute CD-R discs (700M).

This DVD+VCR requires discs/recordings to meet certain technical standards in order to achieve optimal playback quality. Pre-recorded DVDs are automatically set to these standards. There are many different types of recordable disc formats (including CD-R containing MP3 files).

Customers should also note that permission is required in order to download MP3 files and music from the Internet. Our company has no right to grant such permission. Permission should always be sought from the copyright owner.

Radio Operation

Presetting Radio Stations

You can preset up to 30 FM and AM stations. Before tuning, make sure you have turned down the volume to the minimum level.

- 1 Press RADIO.**
FM or AM appears on the front panel display and radio information appears on the TV screen.
- 2 Press RADIO repeatedly to toggle between AM and FM.**
- 3 Press and hold TUNING (▲▼) on the front panel until the frequency indication starts to change, then release.**
Scanning stops when the DVD Receiver tunes in a station. "STEREO" (for stereo program) appears on the front panel display.
- 4 Press MEMORY.**
A preset number will flash on the front panel display.
- 5 Press TUNING (▲▼) on the front panel to select the desired preset number.**
- 6 Press MEMORY again.**
The station is stored.
- 7 Repeat steps 3-6 to store other stations.**

To tune in a station with a weak signal

Press TUNING (▲▼) repeatedly in step 3 to tune in the station manually.

To clear all memorized stations

Press and hold MEMORY until "MEM CLEAR" appears on the front panel display. Then press MEMORY again to clear all stations.

Note

If all 30 stations have already been entered, MEM FULL will appear on the front panel display for a moment and then a preset number will flash. To change the preset number, follow steps 5-6 as above.

Listening to the Radio

Before you begin, be sure to preset your favorite radio stations in the DVD+VCR's memory (see "Presetting radio stations" at left).

- 1 Press RADIO.**
FM or AM appears on the front panel display and radio information appears on the TV screen. The last received station is tuned in.

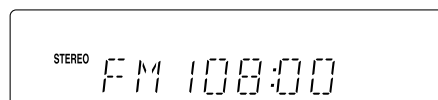

- 2 Press PRESET (▲▼) repeatedly to select the desired preset station.**
- 3 Adjust the volume by rotating the VOLUME knob on the front panel or by pressing VOLUME +/- on the remote control repeatedly.**

To turn off the radio:

Press POWER to turn the DVD+VCR off or select another function mode (DVD, VCR, or AUX).

To listen to non-preset radio stations:

- For manual tuning, press TUNING (▲▼) on the front panel repeatedly.
- For automatic tuning, press and hold TUNING (▲▼) for about two seconds on the front panel.

For your reference

- **If an FM program is noisy**
Press AUDIO so that "STEREO" disappears from the front panel display. There will be no stereo effect, but the reception will improve. Press the AUDIO button again to restore the stereo effect.
- **To improve reception**
Realign the antenna.

Troubleshooting

Please refer to the following troubleshooting tips before contacting service.

Symptom	Cause	Correction
No power.	<ul style="list-style-type: none"> The power cord is disconnected. 	<ul style="list-style-type: none"> Plug the power cord into the wall outlet securely.
The power is on, but the DVD+VCR does not work.	<ul style="list-style-type: none"> No disc is inserted. No tape is inserted. 	<ul style="list-style-type: none"> Insert a disc or tape. (Check that the disc or tape indicator on the front panel display is lit.)
No picture.	<ul style="list-style-type: none"> The TV is not set to receive DVD+VCR signal output. 	<ul style="list-style-type: none"> Select the appropriate video input mode on the TV so the picture from the DVD+VCR appears on the TV screen.
	<ul style="list-style-type: none"> TV/VCR mode for DVD+VCR is set to TV. 	<ul style="list-style-type: none"> Press the TV/VCR button on the remote control repeatedly to choose VCR mode. VCR indicator light appears on the front panel display.
	<ul style="list-style-type: none"> The video cable is not connected securely. 	<ul style="list-style-type: none"> Connect the video cable securely.
	<ul style="list-style-type: none"> The TV power is turned off. 	<ul style="list-style-type: none"> Turn on the TV.
No sound.	<ul style="list-style-type: none"> The equipment connected with the audio cable is not set to receive DVD+VCR signal output. 	<ul style="list-style-type: none"> Select the correct input mode of the audio receiver so you can listen to the sound from the DVD+VCR.
	<ul style="list-style-type: none"> The audio cables are not connected securely. 	<ul style="list-style-type: none"> Connect the audio cables securely.
	<ul style="list-style-type: none"> The power of the equipment connected with the audio cable is turned off. 	<ul style="list-style-type: none"> Turn on the equipment connected with the audio cable.
	<ul style="list-style-type: none"> The audio cables are damaged. 	<ul style="list-style-type: none"> Replace them with new ones.
The playback picture is poor.	<ul style="list-style-type: none"> The disc is dirty. 	<ul style="list-style-type: none"> Clean the disc.
	<ul style="list-style-type: none"> Tape heads are dirty. 	<ul style="list-style-type: none"> Clean the video heads.
	<ul style="list-style-type: none"> Tape is a rental or was recorded on another VCR. 	<ul style="list-style-type: none"> Use CH/TRK (▲/▼) for manual tracking adjustment while tape is playing.
The DVD+VCR does not start playback.	<ul style="list-style-type: none"> No disc is inserted. No tape is inserted. 	<ul style="list-style-type: none"> Insert a disc or tape. (Check that the disc or tape indicator on the front panel display is lit.)
	<ul style="list-style-type: none"> An unplayable disc is inserted. 	<ul style="list-style-type: none"> Insert a playable disc. (Check the disc type, color system, and Regional code.)
	<ul style="list-style-type: none"> The disc is placed upside down. 	<ul style="list-style-type: none"> Place the disc with the playback side down.
	<ul style="list-style-type: none"> The disc is not placed within the guide. 	<ul style="list-style-type: none"> Place the disc on the disc tray correctly inside the guide.
	<ul style="list-style-type: none"> The disc is dirty. 	<ul style="list-style-type: none"> Clean the disc.
	<ul style="list-style-type: none"> The Rating level is set. 	<ul style="list-style-type: none"> Cancel the Rating function or change the rating level.

Troubleshooting (Continued)

Symptom	Cause	Correction
Some channels are skipped over when using CH/TRK (▲/▼)	<ul style="list-style-type: none"> The skipped channels were deleted with the ADD/DEL CH. option. 	<ul style="list-style-type: none"> Use ADD/DEL CH. to restore channels. See "Channel Selection" on page 20.
Picture and sound of broadcasting channel are weak or missing.	<ul style="list-style-type: none"> Antenna or cables are loose. 	<ul style="list-style-type: none"> Tighten connections or replace cable.
	<ul style="list-style-type: none"> Wrong CHANNEL SOURCE option is being used (e.g., TV or CATV). 	<ul style="list-style-type: none"> Try all CHANNEL SOURCE options. See "Channel Selection" on page 20 for details.
Camcorder image is not shown.	<ul style="list-style-type: none"> Camcorder is off. 	<ul style="list-style-type: none"> Turn camcorder on and operate properly.
Camcorder image via A/V input to DVD+VCR is not shown on TV screen.	<ul style="list-style-type: none"> DVD+VCR INPUT SELECT is not set to LINE1 or LINE2. 	<ul style="list-style-type: none"> Press INPUT to select LINE input channel (LINE1 or LINE2).
Timer recording is not possible.	<ul style="list-style-type: none"> Clock in DVD+VCR is not set to the correct time. 	<ul style="list-style-type: none"> Set clock to correct time. See "Setting the Clock" on page 21.
	<ul style="list-style-type: none"> DVD+VCR is on which disables timer. 	<ul style="list-style-type: none"> Turn DVD+VCR off to enable timer. TIMER indicator light appears on the front panel display.
	<ul style="list-style-type: none"> Timer has been programmed incorrectly. 	<ul style="list-style-type: none"> Reprogram Timer. See "Timer Recording" on pages 26 and 27.
	<ul style="list-style-type: none"> TIMER indicator light does not appear after programming timer. 	<ul style="list-style-type: none"> Reprogram Timer and turn DVD+VCR off to enable timer.
TIMER indicator light appears after DVD+VCR is turned off.	<ul style="list-style-type: none"> DVD+VCR is in Timer Recording mode. 	<ul style="list-style-type: none"> This is the normal indication that the DVD+VCR is in TIMER mode.
Stereo Audio Record and/or Playback is not present.	<ul style="list-style-type: none"> TV is not Stereo-compatible. 	<ul style="list-style-type: none"> No action is possible.
	<ul style="list-style-type: none"> Broadcast program is not in stereo format. 	<ul style="list-style-type: none"> No action is possible.
	<ul style="list-style-type: none"> DVD+VCR A/V Out jacks are not connected to TV A/V In jacks. 	<ul style="list-style-type: none"> Make A/V connections. Stereo is available only via A/V output from DVD+VCR.
	<ul style="list-style-type: none"> DVD+VCR Audio/Video Out is not selected for viewing at the TV. 	<ul style="list-style-type: none"> Select AUX or A/V source as TV input.
	<ul style="list-style-type: none"> DVD+VCR BROADCAST TYPE mode is set to SAP or MONO. 	<ul style="list-style-type: none"> Set BROADCAST TYPE mode to STEREO. See "The VCR Setup Menu" on page 20.

Troubleshooting (Continued)

Symptom	Cause	Correction
Severe hum or noise is heard.	• The plugs and jacks are dirty.	• Wipe them with a cloth slightly moistened with alcohol.
	• The disc is dirty.	• Clean the disc.
	• The speakers and components are not securely connected.	• Connect the speakers and components securely.
	• The DVD+VCR is located too close to the TV.	• Move your TV away from the audio components.
Radio stations cannot be tuned in.	• The antennas are poorly positioned or not securely connected.	• Connect the antennas securely. • Adjust the antennas and connect an external antenna if necessary.
	• The signal strength of the stations is too weak (when tuning in with automatic tuning).	• Tune in the station manually.
	• No stations have been preset or preset stations have been cleared (when tuning by scanning preset stations).	• Preset the stations (page 37).
No sound from DIGITAL AUDIO IN (OPTICAL).	• DVD+VCR source is not set to DIGITAL AUDIO IN (OPTICAL).	• Select OPTICAL by pressing AUX.
The remote control does not work properly.	• The remote control is not pointed at the remote sensor of the DVD+VCR.	• Point the remote control at the remote sensor of the DVD+VCR.
	• The remote control is too far from the DVD+VCR.	• Operate the remote control within 23 ft (7 m).
	• There is an obstacle in the path of the remote control and the DVD+VCR.	• Remove the obstacle.
	• The batteries in the remote control are depleted.	• Replace the batteries with new ones.
	• The remote uses one set of controls for VCR and DVD operation (e.g., PLAY).	• When using the VCR, first press the VCR button. When using the DVD, first press the DVD button.

Moisture Condensation

Moisture condensation can occur:	Correction:
<ul style="list-style-type: none"> • When the DVD+VCR is moved from a cold place to a warm place. • Under extremely humid conditions. 	<ul style="list-style-type: none"> • Keep the DVD+VCR plugged into an AC power outlet with the POWER on to help prevent condensation. • When condensation has occurred, wait a few hours for the DVD+VCR to dry before using it.

Language Code List

Enter the appropriate code number for the desired "Disc Audio", "Disc Subtitle" and/or "Disc Menu" language (see page 23).

Code	Language	Code	Language	Code	Language	Code	Language
6566	Abkhazian	7074	Fiji	7678	Lingala	8373	Singhalese
6565	Afar	7073	Finnish	7684	Lithuanian	8375	Slovak
6570	Afrikaans	7082	French	7775	Macedonian	8376	Slovenian
8381	Albanian	7089	Frisian	7771	Malagasy	8379	Somali
6577	Amharic	7176	Galician	7783	Malay	6983	Spanish
6582	Arabic	7565	Georgian	7776	Malayalam	8385	Sudanese
7289	Armenian	6869	German	7784	Maltese	8387	Swahili
6583	Assamese	6976	Greek	7773	Maori	8386	Swedish
6588	Aymara	7576	Greenlandic	7782	Marathi	8476	Tagalog
6590	Azerbaijani	7178	Guarani	7779	Moldavian	8471	Tajik
6665	Bashkir	7185	Gujarati	7778	Mongolian	8465	Tamil
6985	Basque	7265	Hausa	7865	Nauru	8484	Tatar
6678	Bengali; Bangla	7387	Hebrew	7869	Nepali	8469	Telugu
6890	Bhutani	7273	Hindi	7879	Norwegian	8472	Thai
6672	Bihari	7285	Hungarian	7982	Oriya	6679	Tibetan
6682	Breton	7383	Icelandic	8065	Panjabi	8473	Tigrinya
6671	Bulgarian	7378	Indonesian	8083	Pashto, Pushto	8479	Tonga
7789	Burmese	7365	Interlingua	7065	Persian	8482	Turkish
6669	Byelorussian	7165	Irish	8076	Polish	8475	Turkmen
7577	Cambodian	7384	Italian	8084	Portuguese	8487	Twi
6765	Catalan	7465	Japanese	8185	Quechua	8575	Ukrainian
9072	Chinese	7487	Javanese	8277	Rhaeto-Romance	8582	Urdu
6779	Corsican	7578	Kannada	8279	Romanian	8590	Uzbek
7282	Croatian	7583	Kashmiri	8285	Russian	8673	Vietnamese
6783	Czech	7575	Kazakh	8377	Samoan	8679	Volapük
6865	Danish	7589	Kirghiz	8365	Sanskrit	6789	Welsh
7876	Dutch	7579	Korean	7168	Scots Gaelic	8779	Wolof
6978	English	7585	Kurdish	8382	Serbian	8872	Xhosa
6979	Esperanto	7679	Laothian	8372	Serbo-Croatian	7473	Yiddish
6984	Estonian	7665	Latin	8378	Shona	8979	Yoruba
7079	Faeroese	7686	Latvian, Lettish	8368	Sindhi	9085	Zulu

Country Code List

Enter the appropriate code number for the "Country Code" setting (see page 24).

Code	Country	Code	Country	Code	Country	Code	Country
AD	Andorra	ER	Eritrea	LC	Saint Lucia	SC	Seychelles
AE	United Arab Emirates	ES	Spain	LI	Liechtenstein	SD	Sudan
AF	Afghanistan	ET	Ethiopia	LK	Sri Lanka	SE	Sweden
AG	Antigua and Barbuda	FI	Finland	LR	Liberia	SG	Singapore
AI	Anguilla	FJ	Fiji	LS	Lesotho	SH	Saint Helena
AL	Albania	FK	Falkland Islands	LT	Lithuania	SI	Slovenia
AM	Armenia	FM	Micronesia	LU	Luxembourg	SJ	Svalbard and Jan Mayen Islands
AN	Netherlands Antilles	FO	Faroe Islands	LV	Latvia	SK	Slovak Republic
AO	Angola	FR	France	LY	Libya	SL	Sierra Leone
AQ	Antarctica	FX	France (European Territory)	MA	Morocco	SM	San Marino
AR	Argentina	GA	Gabon	MC	Monaco	SN	Senegal
AS	American Samoa	GB	Great Britain	MD	Moldavia	SO	Somalia
AT	Austria	GD	Grenada	MG	Madagascar	SR	Suriname
AU	Australia	GE	Georgia	MH	Marshall Islands	ST	Saint Tome and Principe
AW	Aruba	GF	French Guyana	MK	Macedonia	SU	Former USSR
AZ	Azerbaijan	GH	Ghana	ML	Mali	SV	El Salvador
BA	Bosnia-Herzegovina	GI	Gibraltar	MM	Myanmar	SY	Syria
BB	Barbados	GL	Greenland	MN	Mongolia	SZ	Swaziland
BD	Bangladesh	GM	Gambia	MO	Macau	TC	Turks and Caicos Islands
BE	Belgium	GN	Guinea	MP	Northern Mariana Islands	TD	Chad
BF	Burkina Faso	GP	Guadeloupe (French)	MQ	Martinique (French)	TF	French Southern Territories
BG	Bulgaria	GQ	Equatorial Guinea	MR	Mauritania	TG	Togo
BH	Bahrain	GR	Greece	MS	Montserrat	TH	Thailand
BI	Burundi	GS	S. Georgia & S. Sandwich Isls.	MT	Malta	TJ	Tadjikistan
BJ	Benin	GT	Guatemala	MU	Mauritius	TK	Tokelau
BM	Bermuda	GU	Guam (USA)	MV	Maldives	TM	Turkmenistan
BN	Brunei Darussalam	GW	Guinea Bissau	MW	Malawi	TN	Tunisia
BO	Bolivia	GY	Guyana	MX	Mexico	TO	Tonga
BR	Brazil	HK	Hong Kong	MY	Malaysia	TP	East Timor
BS	Bahamas	HM	Heard and McDonald Islands	MZ	Mozambique	TR	Turkey
BT	Bhutan	HN	Honduras	NA	Namibia	TT	Trinidad and Tobago
BV	Bouvet Island	HR	Croatia	NC	New Caledonia (French)	TV	Tuvalu
BW	Botswana	HT	Haiti	NE	Niger	TW	Taiwan
BY	Belarus	HU	Hungary	NF	Norfolk Island	TZ	Tanzania
BZ	Belize	ID	Indonesia	NG	Nigeria	UA	Ukraine
CA	Canada	IE	Ireland	NI	Nicaragua	UG	Uganda
CC	Cocos (Keeling) Islands	IL	Israel	NL	Netherlands	UK	United Kingdom
CF	Central African Republic	IN	India	NO	Norway	UM	USA Minor Outlying Islands
CG	Congo	IO	British Indian Ocean Territory	NP	Nepal	US	United States
CH	Switzerland	IQ	Iraq	NR	Nauru	UY	Uruguay
CI	Ivory Coast	IR	Iran	NU	Niue	UZ	Uzbekistan
CK	Cook Islands	IS	Iceland	NZ	New Zealand	VA	Vatican City State
CL	Chile	IT	Italy	OM	Oman	VC	Saint Vincent & Grenadines
CM	Cameroon	JM	Jamaica	PA	Panama	VE	Venezuela
CN	China	JO	Jordan	PE	Peru	VG	Virgin Islands (British)
CO	Colombia	JP	Japan	PF	Polynesia (French)	VI	Virgin Islands (USA)
CR	Costa Rica	KE	Kenya	PG	Papua New Guinea	VN	Vietnam
CS	Former Czechoslovakia	KG	Kyrgyzstan	PH	Philippines	VU	Vanuatu
CU	Cuba	KH	Cambodia	PK	Pakistan	WF	Wallis and Futuna Islands
CV	Cape Verde	KI	Kiribati	PL	Poland	WS	Samoa
CX	Christmas Island	KM	Comoros	PM	Saint Pierre and Miquelon	YE	Yemen
CY	Cyprus	KN	Saint Kitts & Nevis Anguilla	PN	Pitcairn Island	YT	Mayotte
CZ	Czech Republic	KP	North Korea	PR	Puerto Rico	YU	Yugoslavia
DE	Germany	KR	South Korea	PT	Portugal	ZA	South Africa
DJ	Djibouti	KW	Kuwait	PW	Palau	ZM	Zambia
DK	Denmark	KY	Cayman Islands	PY	Paraguay	ZR	Zaire
DM	Dominica	KZ	Kazakhstan	QA	Qatar	ZW	Zimbabwe
DO	Dominican Republic	LA	Laos	RE	Reunion (French)		
DZ	Algeria	LB	Lebanon	RO	Romania		
EC	Ecuador			RU	Russian Federation		
EE	Estonia			RW	Rwanda		
EG	Egypt			SA	Saudi Arabia		
EH	Western Sahara			SB	Solomon Islands		

Specifications

General

Power requirements	AC 120V, 60 Hz
Power consumption	80W
Dimensions (approx.)	430 X 97.5 X 360 mm (16.9 x 3.9 x 14.2 inches) (w x h x d)
Mass (approx.)	8 kg (17.6 lbs)
Operating temperature	5°C to 40°C (41°F to 104°F)
Operating humidity	5% to 90%
Signal system	NTSC

Inputs

ANTENNA IN	Antenna or CATV input, 75Ω
VCR VIDEO IN	1 Vp-p 75Ω, sync negative, RCA jack x 1
VCR AUDIO IN	-6.0 dBm more than 47 kΩ, RCA jack (L, R) x 1
FM ANTENNA IN	FM antenna input, 300Ω
AM ANTENNA IN	AM antenna input, 300Ω
DIGITAL AUDIO IN	5 V (p-p), 75Ω, Optical connector x 1

Outputs

VIDEO OUT	1 Vp-p 75Ω, sync negative
S-VIDEO OUT	(Y) 1.0 V (p-p), 75Ω, negative sync, Mini DIN 4-pin x 1 (C) 0.3 V (p-p) 75Ω
COMPONENT VIDEO OUT (PROGRESSIVE SCAN)	(Y) 1.0 V (p-p), 75Ω, negative sync, RCA jack x 1 (Pb)/(Pr) 0.7 V (p-p), 75Ω, RCA jack x 2
Audio output (analog audio)	2.0 Vrms (1 KHz, 0 dB), 330Ω, RCA jack (L, R) x 1
RF OUT	Channel 3 or 4 (Switchable)

VCR Specifications

Head system	Four head helical scan azimuth system
Timer	12-hour display type with AM, FM
Tape speed	SP: 33.35 mm/sec, LP: 16.67 mm/sec, EP: 11.12 mm/sec
Tape width	12.7 mm
Maximum recording time	SP: 2 HOURS (T-120), EP: 6 HOURS (T-120)/8 HOURS (T-160)
Rewind time	About 3 minutes (T-120)
Antenna	75 ohms (VHF/UHF)
Channel coverage	VHF: 2-13, UHF: 14-69, CATV: 1-125 (4A, A-W, W+1 - W+84, A-5 - A-1)
Frequency range	20Hz to 20kHz
Signal-to-noise ratio	More than 43dB
Dynamic range	More than 83dB
Channel separation	More than 55dB

DVD Specifications

Laser system	Semiconductor laser, wavelength 650 nm
Frequency response	DVD (PCM 48 kHz): 8 Hz to 22 kHz, CD: 8 Hz to 20 kHz
Signal-to-noise ratio	More than 100dB (ANALOG OUT jacks only)
Harmonic distortion	Less than 0.008%
Dynamic range	More than 95dB

Specifications (Continued)

Radio Tuner

Tuning Range	87.5 - 108 MHz
Intermediate Frequency	10.7 MHz
Signal-to-Noise Ratio	60 dB
Frequency Response	150 - 10,000 Hz
Tuning Range	530 - 1,720 kHz
Intermediate Frequency	450 kHz

Amplifier

Stereo mode	50W + 50W (8Ω at 1 kHz, THD 10%)
Surround mode	Front: 50W + 50W (THD 10%) Center*: 50W Surround*: 50W + 50W (8Ω at 1 kHz, THD 10%) Subwoofer*: 80W (4Ω at 30 Hz, THD 10%)
	*Depending on the sound mode settings and the source, there may be no sound output.
Inputs	LINE 1, LINE 2, OPTICAL AUDIO

Speakers

	Satellite Speaker	Passive Subwoofer
Type	2 Way 2 Speaker	1 Way 1 Speaker
Impedance	8Ω	4Ω
Frequency Response	110 - 40,000 Hz	40 - 1,500 Hz
Sound Pressure Level	83 dB/W (1m)	82 dB/W (1m)
Rated Input Power	50W	100W
Max. Input Power	100W	200W
Net Dimensions (W x H x D)	100 x 147 x 127.5 mm (3.9" x 5.8" x 5")	200 x 425 x 381 mm (7.9" x 16.7" x 15")
Net Weight	0.92 kg (2 lbs.)	7.06kg (15.5 lbs.)

Accessory:

S-Video cable	1
Video cable	1
Audio cable	1
RF 75-ohm Coaxial Cable	1
Speakers	6
Speaker cables	5
AM loop antenna	1
FM antenna	1
Remote control	1
Batteries	2

- Design and specifications are subject to change without notice.

Manufactured under license from Dolby Laboratories. Dolby, Pro Logic, and the double-D symbol are trademarks of Dolby Laboratories. Confidential unpublished works. Copyright 1992-1997 Dolby Laboratories. All rights reserved.

DTS and DTS Digital Surround are registered trademarks of Digital Theater Systems, Inc.

Warranty

DVD+VCR Limited Warranty

Who Provides the Limited Warranty

During the warranty period, the Rio Warranty Administrator will honor DVD+VCR service for 90 days labor, 1 year parts from the original date of consumer purchase. See below for Commercial, Industrial or Educational use coverage. The DVD+VCR remote control is warranted for 90 days from the date of purchase.



Who is Protected

This warranty protects the original consumer owner of this Rio product.

What is Covered and How Long

This warranty covers internal operating parts and service/labor to repair or replace covered parts in this Rio product for 90 days labor, 1 year parts, from the date of purchase, defined as follows: (1) Original Consumer Retail Purchase; (2) First Rental Purchase Agreement; or (3) First Lease Purchase Agreement (the "Warranty Period"). Labor and replacement parts supplied during the Warranty Period are covered only for the remaining portion of the original Warranty Period. The Rio Warranty Administrator shall have no liability for service under this warranty if non-OEM (Original Equipment Manufacturer) replacement parts are used in the repair of your Rio product.

What the Owner Must Do If Service is Required

If service under this warranty is required, log onto "www.sonicblue.com" to determine the nearest authorized Rio service center.

Other Warranty Coverage

Commercial, Industrial or Educational use has the same warranty coverage as stated in this warranty.

What are the Exceptions

This warranty does not cover: (1) Normal maintenance service, such as video head cleaning. (2) Damage from misuse, abuse, neglect or accident, natural disasters or Acts of God. (3) Cabinetry, decorative parts, A/C adapters, knobs or buttons. (4) The foreign country use of this product. (5) Rio product which has been electronically or mechanically modified in any way or incorporated into other products. (6) Installation and setup service adjustments. (7) Owner instruction. Your Owner's Guide provides information regarding operating instructions and user controls. For additional information, contact your authorized Rio dealer.

Rio is not responsible for any shipping, handling or insurance charges.

This Exclusive Limited Warranty excludes all incidental and consequential damages. Some states do not allow the exclusion of incidental and consequential damages, so the above exclusion may not apply to you.

ALL IMPLIED WARRANTIES, INCLUDING IMPLIED WARRANTIES OF MERCHANTABILITY AND FITNESS FOR A PARTICULAR PURPOSE ARE LIMITED IN DURATION TO THE DURATION OF THIS WARRANTY PERIOD. Some states do not allow limitations on how long an implied warranty lasts, so the above limitation may not apply to you.

This Exclusive Limited Warranty gives you specific legal rights and you may also have other rights which vary from state to state.

RIO WARRANTY ADMINISTRATOR

SONICblue, Inc. • 7835 East McClain Drive • Scottsdale, Arizona 85260-1732
customerservice@sonicblue.com

Free Manuals Download Website

<http://myh66.com>

<http://usermanuals.us>

<http://www.somanuals.com>

<http://www.4manuals.cc>

<http://www.manual-lib.com>

<http://www.404manual.com>

<http://www.luxmanual.com>

<http://aubethermostatmanual.com>

Golf course search by state

<http://golfingnear.com>

Email search by domain

<http://emailbydomain.com>

Auto manuals search

<http://auto.somanuals.com>

TV manuals search

<http://tv.somanuals.com>