

**CREATIVE®**

## ***User's Guide***



**DIGITAL  
MP3 PLAYER *FX200***

Download from [Www.Somanuals.com](http://www.Somanuals.com). All Manuals Search And Download.



# *User's Guide*

## Creative DMPFX200

Information in this document is subject to change without notice and does not represent a commitment on the part of Creative Technology Ltd. No part of this manual may be reproduced or transmitted in any form or by any means, electronic or mechanical, including photocopying and recording, for any purpose without the written permission of Creative Technology Ltd. The software described in this document is furnished under a license agreement and may be used or copied only in accordance with the terms of the license agreement. It is against the law to copy the software on any other medium except as specifically allowed in the license agreement. The licensee may make one copy of the software for backup purposes.

The Software License Agreement is found in a separate folder on the installation CD.

Copyright © 2005 Creative Technology Ltd. All rights reserved.

Version 1.0

June 2005

Creative MediaSource, EAX and the Creative logo are trademarks or registered trademarks of Creative Technology Ltd. in the United States and/or other countries.

Microsoft, MS-DOS, and Windows are registered trademarks of Microsoft Corporation. All rights reserved.

Intel and Pentium are trademarks of Intel Corporation in the U.S. and other countries.

CDDB is a trademark of CDDB, Inc.

All other products are trademarks or registered trademarks of their respective owners.

CREATIVE®

DIGITAL  
MP3 PLAYER

*FX200*

## Contents

# Contents

## 1 Before You Begin

Introduction..... 1-1  
 Minimum System Requirements ..... 1-1

## 2 A Tour of Your Player

Your Player at a Glance..... 2-1  
 Using the Scroller ..... 2-4  
     Scroll Select..... 2-4  
     Selecting menu options ..... 2-4

## 3 Getting Started

Setting Up Your Player ..... 3-1  
 Inserting Battery..... 3-2  
     Power Source and Level Indicators ..... 3-3  
 Transferring Files..... 3-4  
     Downloading from the Internet..... 3-5  
     Ripping from a CD ..... 3-6

## 4 Using Your Player

Turning On/Off Your Player ..... 4-1  
 Enabling a Mode ..... 4-2  
 Playing Music Tracks ..... 4-2  
 Skipping Folders..... 4-3

Changing Play Modes..... 4-4

    Repeating music..... 4-4

    Playing a track once..... 4-6

    Shuffling music..... 4-7

    Playing all tracks..... 4-8

Listening to FM Radio..... 4-9

Recording Audio..... 4-13

    Recording Voice..... 4-14

    Recording FM Radio..... 4-15

Playing Recordings..... 4-16

EQ Settings ..... 4-17

    Enhancing Your Music ..... 4-17

Deleting Audio Files..... 4-19

User Preferences ..... 4-20

Locking and Unlocking Your Player..... 4-22

Formatting Your Player..... 4-22

**5 Software Applications**

About Creative MediaSource..... 5-1

**Appendixes**

**A Technical Specifications**

Player ..... A-1

## **B On Screen Diagram and Icon Guide**

Information Diagrams.....	B-1
Playback Icons.....	B-4
Play Mode Icons.....	B-5

## **C Frequently Asked Questions**

General.....	C-1
Usage.....	C-2



# 1

## Before You Begin

# Before Your Begin

---

## Introduction

Thank you for purchasing Creative's new multi-format player, Creative DMPFX200! Your player can store songs in its music library, and comes equipped with a USB 2.0 connector, so you can transfer audio tracks and data quickly and easily. With your player's built-in FM radio, you can listen to your favorite radio stations. You can also record FM radio in stereo and voice in mono!

## Minimum System Requirements



---

**The software applications on the Creative DMPFX200 CD may have higher requirements for basic functionality. Refer to each application's documentation for details.**

---

- Microsoft® Windows® XP, Windows Millennium Edition (Me), Windows 2000, or Windows 98 Second Edition (SE)
- Intel® Pentium® II 350 MHz, AMD® K6-2® 450 MHz or better processor (Pentium III 450 MHz or higher recommended for MP3 encoding)
- CD-ROM drive with digital audio extraction support
- USB 1.1™ port (USB 2.0 port recommended)
- 64 MB RAM (128 MB recommended)
- 30 MB free hard disk space (more needed for storing audio)
- SVGA graphics adapter (256 colors, 800 x 600 resolution or better)





# 2

## A Tour of Your Player

# A Tour of Your Player

---

## Your Player at a Glance

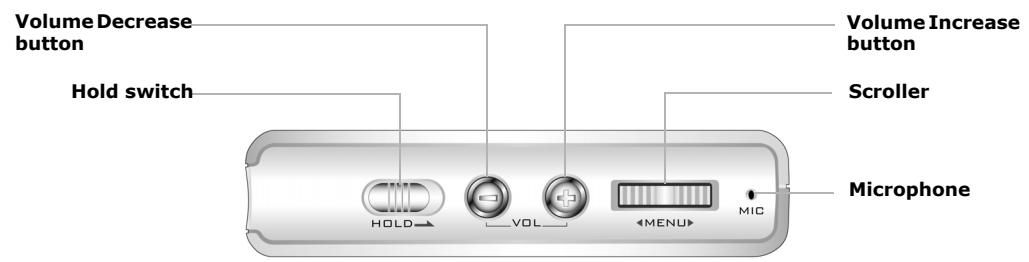

**Top View**







**Front View**

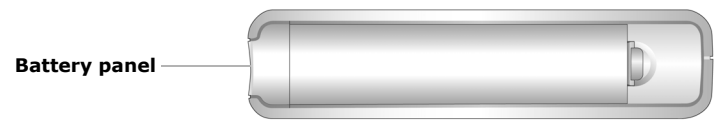

**Side Views**

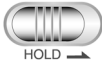

**Bottom View**

Button/Switch	What It Does	Usage Tips
<p><b>PLAY/PAUSE</b></p> 	<ul style="list-style-type: none"> <li>○ Turns the player on and off.</li> <li>○ Starts, pauses or continues playback.</li> <li>○ Changes Scroller mode in FM Radio mode.</li> </ul>	<ul style="list-style-type: none"> <li>○ Press and hold until player turns on or off.</li> </ul>
<p><b>HOLD</b></p> 	<ul style="list-style-type: none"> <li>○ Locks and disables all buttons on your player.</li> </ul>	<ul style="list-style-type: none"> <li>○ Slide the switch to the right to lock the player.</li> </ul>
<p><b>VOLUME DECREASE</b></p> 	<ul style="list-style-type: none"> <li>○ Decreases the volume.</li> </ul>	<ul style="list-style-type: none"> <li>○ Press and hold to decrease the volume quickly.</li> </ul>
<p><b>VOLUME INCREASE</b></p> 	<ul style="list-style-type: none"> <li>○ Increases the volume.</li> </ul>	<ul style="list-style-type: none"> <li>○ Press and hold to increase the volume quickly.</li> </ul>
<p><b>SCROLLER</b></p> 	<ul style="list-style-type: none"> <li>○ Goes to the previous or next track.</li> <li>○ Moves ahead or moves back within a track.</li> <li>○ Scrolls through menu options.</li> <li>○ Selects menu options.</li> <li>○ Selects or scans FM radio channels.</li> </ul>	<ul style="list-style-type: none"> <li>○ During playback, turn and release the Scroller to go to the previous or next track.</li> <li>○ During playback, turn and hold the Scroller to move ahead or move back within a track.</li> <li>○ Turn the Scroller to scroll through menu options and press the Scroller to select them. This action is also referred to as "Scroll Select".</li> </ul>

# Using the Scroller

## Scroll Select



**To "Scroll Select", use the Scroller to scroll to the option you want, and select the option by pressing the Scroller.**

The Scroller is one of the most important features of your player. In this document, we will use a new term, "Scroll Select", to indicate that you should use the Scroller to scroll through options and then select the option by pressing the Scroller.



The Scroller (top view)



Use the Scroller to scroll through options



Press the Scroller to select an option

Depending on the screen you are in, you can have different menu options.

## Selecting menu options

You can use the Scroller to make selections in menus. For example, if you are looking at the Menu screen:



From the **Menu** screen to the **Play Mode** screen

1. Use the Scroller to scroll through the menu options.
2. Press the Scroller to select the menu item.



# 3

## Getting Started

# Getting Started

---

## Setting Up Your Player



---

**To install the software, Windows XP and Windows 2000 users must log in as the System Administrator or a user with System Administrator privileges. For more information, refer to your operating system's online Help.**

---

Your Creative DMPFX200 includes software so that you can create audio tracks, manage your music library, and use your player in all supported Windows operating systems. Your installation CD also includes the drivers necessary for Windows 98 SE.

1. Make sure that your player is **NOT** connected to your computer.
2. Insert the Creative DMPFX200 CD into your CD-ROM drive. Your CD should start automatically. If it does not, follow the steps below:
  - i. Double-click the **My Computer** icon.
  - ii. Right-click the CD-ROM/DVD-ROM drive icon, and then click **AutoPlay**.
3. Follow the instructions on the screen to complete the installation. For Windows 98 SE users, make sure the player's **Driver** option is selected on the **Install Software** screen.
4. If prompted, restart your computer.

## Inserting Battery



**When opening or closing the battery compartment, handle with care.**

*Insert the supplied battery into your player as shown below.*

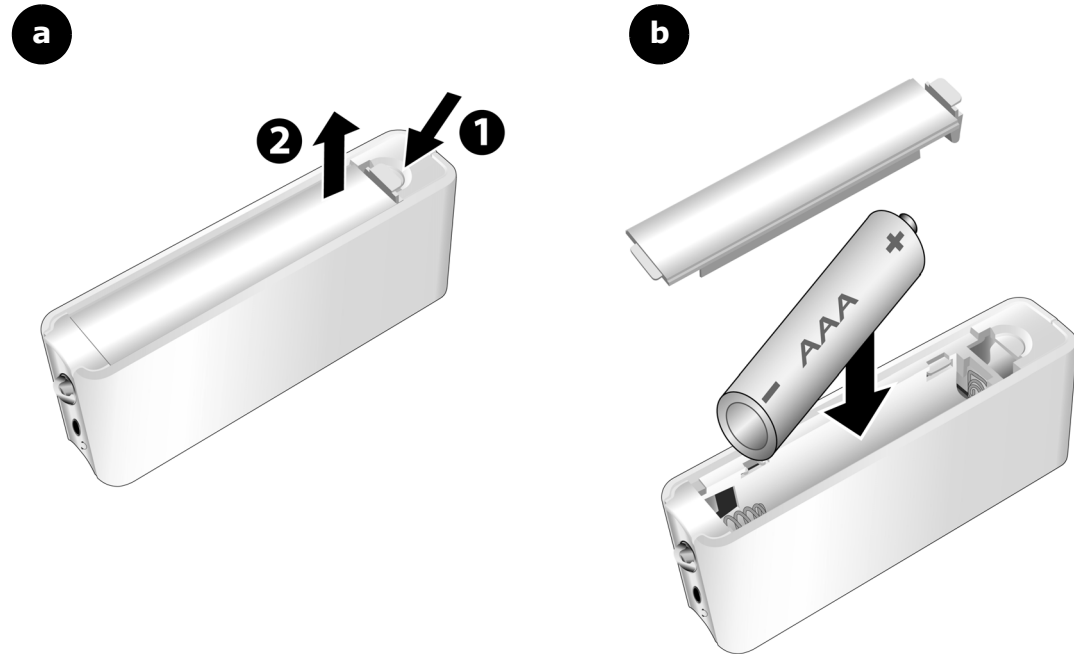

*Figure 3-3: Inserting the supplied battery into your player.*



# Power Source and Level Indicators



**The amount of playback time available depends on various factors (for example, volume level). For more information, see "Usage" on page C-2.**

After inserting the battery, your player displays one of the following icons, depending on the battery's status.

Icon	What the icon means	Notes
	○ your player's battery is full	○ this battery state icon shows that the battery is full
	○ your player's battery is 60% full	○ this battery state icon shows that the battery power level is high
	○ your player's battery is 30% full	<ul style="list-style-type: none"> <li>○ this battery state icon shows that the battery power level is low</li> <li>○ change the battery at the earliest opportunity</li> </ul>

# Transferring Files



**WMA files with Digital Rights Management technology cannot be copied to your player using Windows Explorer. You can only do so with applications like Windows Media Player or Creative MediaSource.**

Audio selections have been preloaded to your player to get you started quickly. If you wish to listen to music immediately, simply press the

**Play/Pause** button .

### To transfer files

1. Connect your player to your computer's USB port using the supplied USB cable.

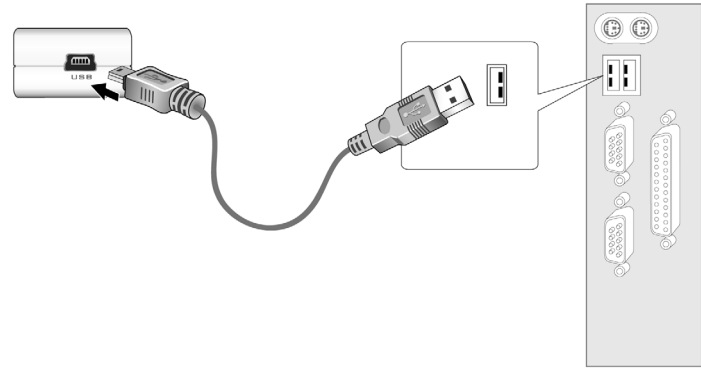

2. On your desktop, right-click the **My Computer** icon, and then click **Explore**.
3. Copy files into your player using a drag-and-drop operation.

If you wish to download additional music tracks to your player, you can either download music tracks from Internet music sites (see "Downloading from the Internet" on page 3-5) or rip them from your audio CDs to create digital files on your computer. For more information, see "Ripping from a CD" on page 3-6.

# Downloading from the Internet



---

**It may be illegal to encode music files for trade or sale unless you have the express or explicit permission of the copyright holder(s).**

---

To get music files from the Internet, use a search engine to locate sites with music content. You can also try out these sites (web sites listed here are correct at the time of this document's release):

- Soundbuzz.com  
<http://www.soundbuzz.com>
- Epitonic.com  
<http://www.epitonic.com>
- AMP3.com  
<http://www.amp3.com>
- ArtistOne.com  
<http://www.artistone.com>
- SoundClick.com  
<http://www.soundclick.com>

Follow the instructions on the site and download the music files to your computer.

## Ripping from a CD

The first phase in making an MP3 file is extracting audio data from an audio CD. To extract audio data, you will need a CD-ROM drive that can extract digital audio data, and a program known as a ripper. With Creative MediaSource Organizer, you can rip tracks from most audio CDs. This program uses the CD-ROM drive to read the audio tracks from the audio CD and stores it on your hard disk.

The time needed for a successful audio extraction depends on:

- CD-ROM drive speed
- defects, like scratches on the audio CD
- error-checking features on the CD-ROM drive

Encoding is the second phase of making an MP3 file. Encoders are used to convert the stored audio tracks, usually WAV files, into MP3 files. MP3 encoding is a lossy compression methodology where some data is considered inaudible and is removed before encoding. Using the standard sampling rate and bitrates will ensure that your MP3 files retain much of their audio quality. The standard bitrate of most MP3 files is 128 Kbps, although some are set higher, at 160 or 192 Kbps. Higher bitrates will result in larger MP3 file sizes, with better audio quality. Use Creative MediaSource Organizer to extract audio tracks and encode MP3s.

**See the Creative MediaSource Organizer online Help for more information.**



# 4

## Using Your Player

# Using Your Player

---

Your player can function in **Music**, **Recorded Tracks**, **Microphone** or **FM Radio** mode. In **Music** mode, only MP3 or WMA files are played back and in **Recorded Tracks** mode, only voice and FM radio recordings that are recorded by the player, are played back. To switch modes, see "Enabling a Mode" on page 4-2.

Your player also has play modes that allow you to change how your audio tracks are played back. For more information, see "Changing Play Modes" on page 4-4.

## Turning On/Off Your Player



---

Audio tracks are played back in alphanumeric order.

---

### To turn on your player

Press and hold the **Play/Pause** button  until your player turns on.

The **CREATIVE** logo appears on the screen. Your player will enter the last mode you were in before you turned if off.

### To turn off your player

Press and hold the **Play/Pause** button for a few seconds until after the **Power off** message disappears.

## Enabling a Mode





1. Press the Scroller.  
The Main Menu similar to Figure 4-1 appears.
2. Scroll Select the **Music** icon , **Recorded Tracks** icon , **Microphone** icon  or **FM Radio** icon .



Figure 4-1

## Playing Music Tracks



If there are no audio tracks in your player, the "No music" message will appear on the screen.

### To play a track

1. Press the Scroller.  
The Main Menu similar to Figure 4-2 appears.
2. Scroll Select the **Music** icon (Figure 4-3).
3. Scroll Select a song you want to play. The track is played back automatically. See Figure 4-4 for normal playback view.



Figure 4-2



Figure 4-3



To transfer audio tracks to your player, see "Transferring Files" on page 3-4.

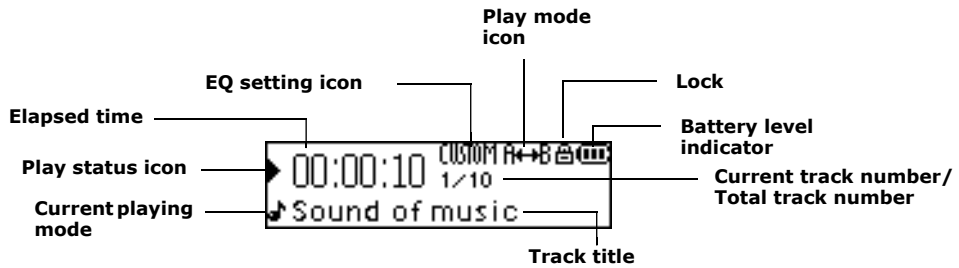

Figure 4-4

### To pause a track

Press the **Play/Pause** button.

**To go to the previous track**

Turn the Scroller towards the left ◀ and release it.

**To go to the next track**

Turn the Scroller towards the right ▶ and release it.

**To stop a track**

1. Press the **Play/Pause** button to pause the track.
2. Turn the Scroller and release it.  
The **Stop** icon ■ appears on the screen.

## Skipping Folders



---

**Skip Folder mode is only available in Music mode.**

---



---

**Your player can only recognize up to one sub folder level in the root directory.**

---

When you have audio files grouped in different folders, and you want to listen to those in a particular folder immediately, use this feature. After the last audio file in that folder has been played back, those from the next folder will be played next.

**To select a folder**

1. Press the Scroller.  
The Main Menu similar to Figure 4-5 appears.



Figure 4-5

2. Scroll Select the **Skip Folder** icon (Figure 4-6). The **Skip Folder** icon 📁➡ appears on the screen.
3. Scroll Select the folder that you want.



Figure 4-6



# Changing Play Modes



**Only one play mode can be enabled at a time.**



**Play modes are available in Music and Recorded Tracks mode, and during music, voice or FM radio playback.**

Your player has play modes that allow you to change how your tracks are played back. You can select the play modes during music, voice or FM radio playback, or when you are in **Music** or **Recorded Tracks** modes.

The following play modes are available:

- A-B
- Repeat Track
- Repeat All
- Repeat Folder (available in Music mode only)
- Track Once
- Shuffle Repeat
- Shuffle Once
- Shuffle Folder (available in Music mode only)
- Normal

## Repeating music

*You can choose to repeat a track, folder, all tracks or a portion of a track.*

1. Press the Scroller.



Figure 4-7

2. Scroll Select the **Play Mode** icon (Figure 4-7). A list appears (Figure 4-8).

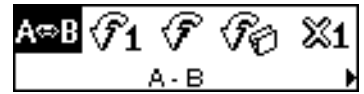

Figure 4-8

Using Your Player 4-4



**A portion of a track can only be repeated once; marking a new portion will automatically remove any markers in the track.**

Depending on which mode you want, follow the corresponding step:

### To repeat a portion of a track

1. Scroll Select the **A-B** icon (Figure 4-9).

The icon  appears on the screen.



Figure 4-9

2. Press the Scroller to mark the beginning of

the portion you wish to repeat. The icon  appears on the screen.

3. Press the Scroller again to mark the end of the portion. The icon  appears on the screen. The marked portion is played back repeatedly.

4. To resume normal playback, enable "Normal" mode as described in "Playing all tracks" on page 4-8.

### To repeat a track

Scroll Select the **Repeat Track** icon (Figure 4-10).

The **Repeat Track** icon  appears on the screen and the track is repeated continuously until you stop it or skip to another folder.



Figure 4-10

### To repeat all tracks

Scroll Select the **Repeat All** icon (Figure 4-11).

The **Repeat All** icon  appears on the screen and all tracks are repeated continuously until you stop them.



Figure 4-11



**Repeat Folder mode is only available in Music mode.**

**To repeat a folder**

Scroll Select the **Repeat Folder** icon (Figure 4-12).

The **Repeat Folder** icon  appears on the screen and tracks in the current folder are repeated continuously until you stop them or skip to another folder.



Figure 4-12

**Playing a track once**

*When the Track Once play mode is enabled, playback stops once the current track ends.*

1. Press the Scroller.



Figure 4-13

2. Scroll Select the **Play Mode** icon (Figure 4-13).

A list appears (Figure 4-14).

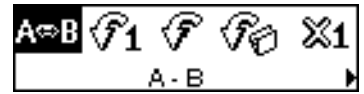

Figure 4-14

3. Scroll Select the **Track Once** icon (Figure 4-15).

The **Track Once** icon  appears on the screen. Playback stops once the track ends.



Figure 4-15

## Shuffling music

You can choose to randomly play tracks.

1. Press the Scroller.
2. Scroll Select the **Play Mode** icon (Figure 4-16).  
A list appears (Figure 4-17).



Figure 4-16

Depending on the mode you want, follow the corresponding step:

### To randomly repeat all tracks continuously

Scroll Select the **Shuffle Repeat** icon (Figure 4-18).

The **Shuffle Repeat** icon  appears on the screen and tracks are selected at random and played back continuously until you stop playback.

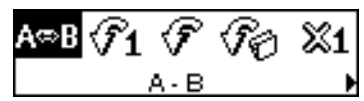

Figure 4-17



Figure 4-18

### To randomly play all tracks once

Scroll Select the **Shuffle Once** icon (Figure 4-19).

The **Shuffle Once** icon  appears on the screen and tracks are selected at random and played back. Playback stops once all the tracks in your player are played back once.



Figure 4-19

**To randomly play all tracks in a folder once**

Scroll Select the **Shuffle Folder** icon (Figure 4-20).

The **Shuffle Folder** icon appears on the screen and all tracks in the folder are selected at random and played back. Playback stops once all the tracks in the folder are played back once.



Figure 4-20

**Playing all tracks**

*When the Normal mode is enabled, all tracks are played back once, in the order that they appear in the play list.*

1. Press the Scroller.



Figure 4-21

2. Scroll Select the **Play Mode** icon (Figure 4-21).

A list appears (Figure 4-22).

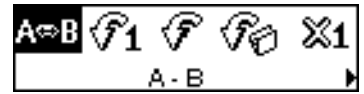

Figure 4-22

3. Scroll Select the **Normal** icon (Figure 4-23).

All tracks play back normally.



Figure 4-23

# Listening to FM Radio



If there are no saved preset channels in your player, the "No preset found" message will appear on the screen.

With your player, you can listen to your favorite radio station. Your player can automatically scan for stations available in your region, and store the stations as presets for you. In FM Radio mode, your player will display the current radio channel and its preset number.

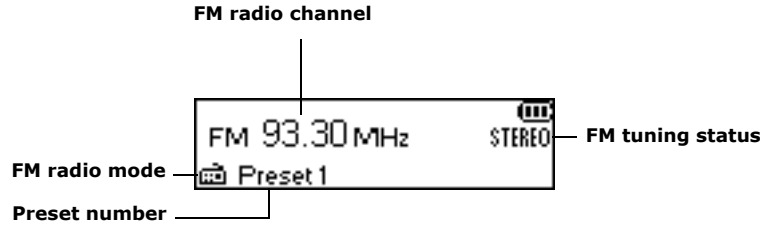

Figure 4-24

## To perform an autoscans and autosave

1. Press the Scroller.  
 The Main Menu similar to Figure 4-25 appears.
2. Scroll Select the **FM Radio** icon (Figure 4-26).  
 A radio frequency appears on the LCD screen (Figure 4-27).
3. Press the Scroller.



Figure 4-25



Figure 4-26

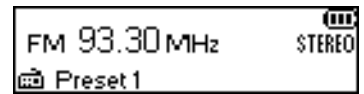

Figure 4-27

4. Scroll Select the **Autoscan** icon (Figure 4-28). The player will scan and store channels it detects. At the end of the autoscan, it will play the first channel.



Figure 4-28

**To select a channel**

1. Press the Scroller.  
The Main Menu similar to Figure 4-29 appears.



Figure 4-29

2. Scroll Select the **FM Radio** icon (Figure 4-30). A radio frequency appears on the LCD screen (Figure 4-31).



Figure 4-30

3. Turn the Scroller to select the preset channel you want.

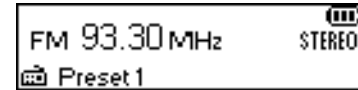

Figure 4-31

**To manually scan an FM radio channel**

1. Press the Scroller.  
The Main Menu similar to Figure 4-32 appears.



Figure 4-32

2. Scroll Select the **FM Radio** icon (Figure 4-33). A radio frequency appears on the LCD screen (Figure 4-34).



Figure 4-33



**If you do not see a preset channel, press the Play/Pause button.**

3. If you see a preset channel, press the **Play/Pause** button to switch to Manual Scan view. The preset channel disappears.
4. Turn the Scroller towards the right ► to increase the frequency or towards the left ◀ to decrease the frequency.
5. To scan for a channel, move the Scroller towards the right or left, and hold for one second.
6. Press the Scroller.
7. Scroll Select the **Save Preset** icon (Figure 4-35).
8. Turn the Scroller to select the preset number you want. Your channel is stored and appears at the bottom-left corner of your screen.
9. Repeat steps 2 to 6 to store another channel.

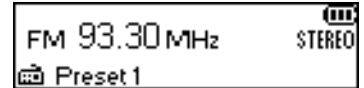

Figure 4-34



Figure 4-35

**To delete a channel**

1. Press the Scroller. The Main Menu similar to Figure 4-36 appears.
2. Scroll Select the **FM Radio** icon (Figure 4-37). A radio frequency appears on the LCD screen (Figure 4-38).



Figure 4-36



Figure 4-37



**If you do not see a preset channel, press the Play/Pause button.**



3. Turn the Scroller to select the preset channel you want.
4. Press the Scroller.
5. Scroll Select the **Delete Preset** icon (Figure 4-39).
6. Scroll Select the **Delete Preset <number>** icon (Figure 4-40). The preset channel is deleted and your player plays the next available preset channel.

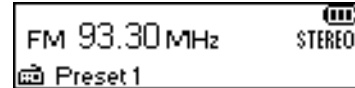

Figure 4-38



Figure 4-39



Figure 4-40

**To switch to FM Preset view or Manual Scan view**

In FM Preset view, you can see the preset channels and scroll from one preset channel to another. If you need to fine-tune the radio channel, switch to Manual Scan view. The preset channel disappears in this view.

1. Press the Scroller.  
 The Main Menu similar to Figure 4-41 appears.
2. Scroll Select the **FM Radio** icon (Figure 4-42).  
 A radio frequency appears on the LCD screen (Figure 4-43).

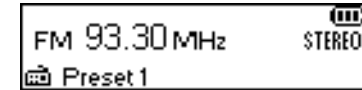

Figure 4-41



Figure 4-42

3. Press the Scroller.



*Figure 4-43*

4. Scroll Select the **Scroller mode** icon (Figure 4-44) to switch to the different views. Alternatively, you can press the **Play/Pause** button to switch to the different views while playing a station.



*Figure 4-44*

## Recording Audio

Another great Creative DMPFX200 feature is its ability to record voice and FM radio. Recorded voice is encoded directly into IMA ADPCM (at 8 kHz, 4-bit, Mono) file format and recorded FM radio is encoded directly into IMA ADPCM WAV (at 16 kHz, 4-bit, Stereo) file format.

When recording, note that the available recording time is determined by:

- available memory space in your player
- battery power remaining in your player

## Recording Voice

When recording voice, you will see the status bar showing you the time available for recording, and another showing you the elapsed recording time. Also, the microphone icon appears in the bottom-left corner of the LCD screen.

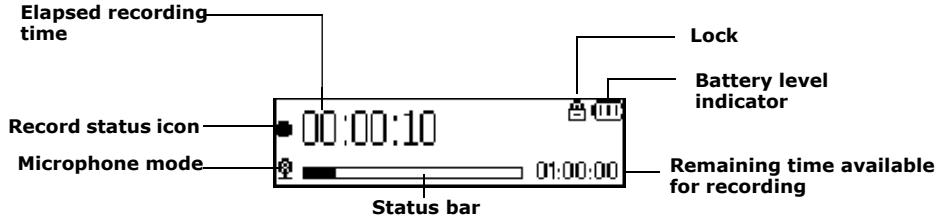

Figure 4-45



**You cannot pause a voice recording.**

### To make a voice recording

1. Press the Scroller.  
 The Main Menu similar to Figure 4-46 appears.
2. Scroll Select the **Microphone** icon (Figure 4-47).  
 The recording bar appears on the screen.
3. Press the **Play/Pause** button to start the recording.
4. Press the **Play/Pause** button again to end the recording. A name is automatically assigned to your recording and the file is saved in your player. The naming convention typically used is: **VOC [Current File Number]**.



Figure 4-46



Figure 4-47

# Recording FM Radio

When recording an FM radio program, you will see the status bar showing you the time available for recording, and another showing you the elapsed recording time. Also, the FM Radio icon appears in the bottom-left corner of the LCD screen.

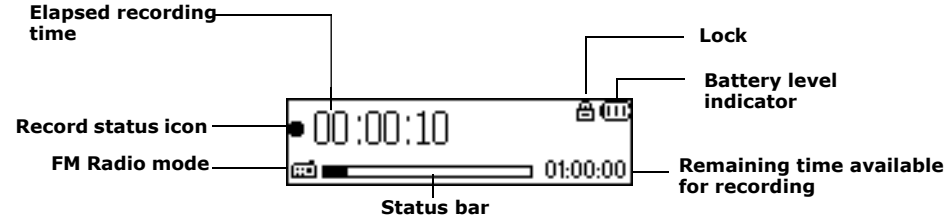

Figure 4-48

## To make an FM radio recording

1. Press the Scroller.  
The Main Menu similar to Figure 4-49 appears.
2. Scroll Select the **FM Radio** icon (Figure 4-50).  
A radio frequency appears on the LCD screen (Figure 4-51).
3. Turn the Scroller to select the preset channel you want.
4. Press the Scroller.



Figure 4-49



Figure 4-50

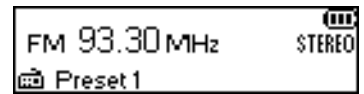

Figure 4-51



**You cannot pause an FM radio recording.**



**If you do not see a preset channel, press the Play/Pause button.**

5. Scroll Select the **FM Recording** icon (Figure 4-52).  
 A recording bar appears on the LCD screen and recording starts.



Figure 4-52

6. Press the **Play/Pause** button to end the recording. A name is automatically assigned to your FM radio recording and the file is saved in your player. The naming convention typically used is: **FM [Current File Number]**.

To play voice and FM Radio tracks that you have recorded on your player, see "To play a recording" on page 4-17.

## Playing Recordings

It is simple to play back the voice and FM Radio tracks you have recorded. In **Recorded Tracks** mode, your player will display the elapsed time, track number and file name of the recorded track.

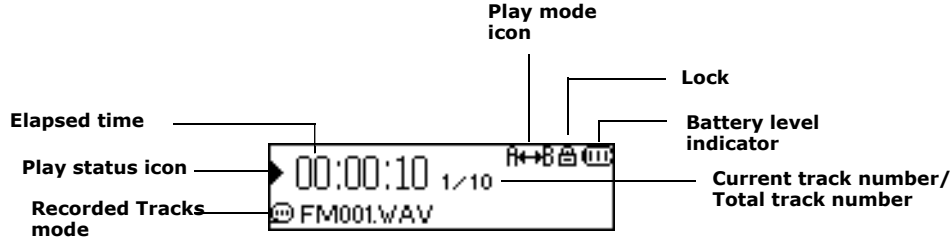

Figure 4-53



---

**A recorded voice file starts with "VOC" and an FM radio file starts with "FM".**

---

### To play a recording

1. Press the Scroller.  
The Main Menu similar to Figure 4-54 appears.
2. Scroll Select the **Recorded Tracks** icon (Figure 4-55).
3. Scroll Select a recording you want to listen to. The track is played back automatically.



Figure 4-54



Figure 4-55

To delete a recording, see "Deleting Audio Files" on page 4-19.

## EQ Settings

### Enhancing Your Music



---

**EQ settings are only available in Music mode.**

---

Your player allows you to enhance your listening experience with EQ settings. The EQ settings available in your player include:

- Rock
- Pop
- Classical
- Jazz
- Custom EQ
- Normal

You can use EQ settings with your currently playing audio. This simple process is described in the following instructions.

1. Press the Scroller.  
 The Main Menu (Figure 4-56) appears.



Figure 4-56

2. Scroll Select the **EQ** icon (Figure 4-57).  
 Depending on which EQ setting you want, follow the corresponding step:



Figure 4-57

**To select Rock, Pop, Classical, Jazz or Normal**

Scroll Select the EQ setting you want.  
 The selected **EQ** icon appears on the screen.

**To define your own EQ settings**

1. Scroll Select the **Custom EQ** icon (Figure 4-58).  
 The **Custom EQ** screen (Figure 4-59) appears.
2. Five vertical control levers will appear in the display. Each lever represents successively higher frequencies that can be controlled. 62 Hz controls bass frequency, 250 Hz adjusts the low mid-range frequency, 1 kHz adjusts the mid-range frequency, 4 kHz adjusts the upper mid-range frequency and 16 kHz adjusts the treble frequency.



Figure 4-58

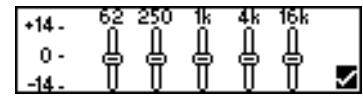

Figure 4-59

3. Scroll Select each vertical control level. Use the Scroller to move the control knob up or down to vary the amount of boost or reduction in the selected frequency range.
4. Scroll Select the check mark to exit the **Custom EQ** screen.

## Deleting Audio Files

This action permanently deletes tracks or recordings from your player.

### To delete an audio file

1. Press the Scroller.  
The Main Menu similar to Figure 4-60 appears.



Figure 4-60



2. Scroll Select the **Music** icon  or **Recorded Tracks** icon .
3. Scroll Select the track or FM file that you want to delete.
4. Press the Scroller.
5. Scroll Select the **Delete** icon (Figure 4-61). A list appears.



Figure 4-61

6. Scroll Select the **Confirm Delete** icon (Figure 4-62). The track or FM file is permanently deleted from your player.

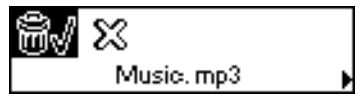

Figure 4-62



# User Preferences

Your player offers many configuration options. You can

- specify contrast settings
- change the LCD screen's backlight duration
- select the default language
- select the FM region
- specify how long the player remains inactive before it automatically shuts down
- access the information screen

1. Press the Scroller.  
The Main Menu similar to Figure 4-63 appears.



Figure 4-63

2. Scroll Select the **Settings** icon (Figure 4-64).  
A list appears (Figure 4-65).



Figure 4-64

Depending on which configuration option you want, follow the corresponding step:

### To set the contrast level for your player's screen

1. Scroll Select the **Contrast** icon (Figure 4-65).  
The **Contrast** screen (Figure 4-66) appears.



Figure 4-65

2. Use the Scroller to increase or decrease the LCD contrast. The lower the number, the lower the LCD contrast.

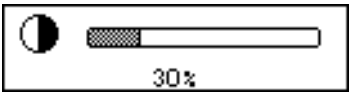

Figure 4-66

**To adjust the screen backlight duration**

1. Scroll Select the **Backlight** icon (Figure 4-67).
2. Scroll Select to select the backlight duration, or to disable the backlight entirely. A lower number setting conserves battery power for longer playback time.



Figure 4-67

**To change the default language**

1. Scroll Select the **Language** icon (Figure 4-68).
2. Scroll Select the language that you want.



Figure 4-68

**To specify how long the player remains inactive before it automatically shuts down**

1. Scroll Select the **Idle Shutdown** icon (Figure 4-69).
2. Scroll Select the duration you want the player to wait for before automatically shutting down.



Figure 4-69

**To view the player's firmware version, the total amount of space and the amount of free space in your player for storing music or data, and the number of tracks**

1. Scroll Select the **Information** icon (Figure 4-70).
2. Scroll Select the information you want to see.



Figure 4-70

## Locking and Unlocking Your Player

Locking your player will disable all buttons on the player. This feature is useful when you do not want any buttons (for example, **Play/Pause**) pressed accidentally.

### **To lock your player**

Slide the **Hold** switch to the right.

The player is locked. The **Lock** icon  appears at the top of the LCD screen.

### **To unlock your player**

Slide the **Hold** switch to the left.

The player is unlocked.

## Formatting Your Player

You may at times need to clear your player's memory during normal use. Use Windows Explorer to easily clear your player's memory for the efficient transfer, storage and playback of music files.

### **To clear your player's memory**

1. Connect your player to your computer.
2. In Windows Explorer, select the drive your player is assigned to, for example, **Removable Disk (F:)** (replace **F:** with the drive letter of your player).

3. Right-click and select **Format**.  
The dialog box similar to Figure 4-71 appears.
4. Click the **Start** button.

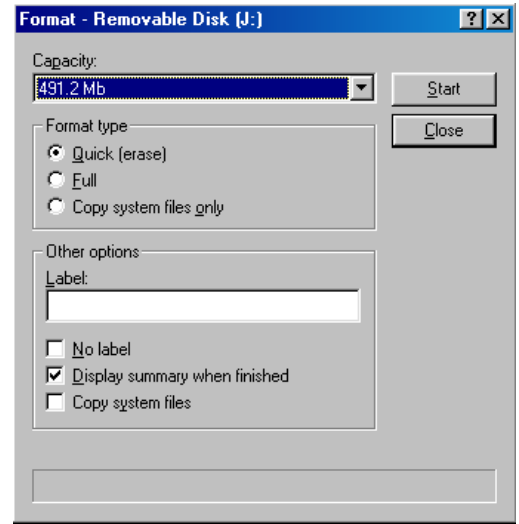

Figure 4-71



# 5

## Software Applications

# Software Applications

---

## About Creative MediaSource



---

**To listen to transferred audio tracks, your player must be in Music mode. For more information, refer to "Playing Music Tracks" on page 4-2.**

---



---

**You may use also Windows Explorer to transfer audio and data files. For more information, see "Transferring Files" on page 3-4.**

---

Creative MediaSource is included on your installation CD (see "Setting Up Your Player" on page 3-1).

Basic instructions on how to use Creative MediaSource are provided in the Creative MediaSource Help.

If you wish to download additional music tracks to your player, you can either download music tracks from Internet music sites (see "Downloading from the Internet" on page 3-5) or "rip" them from audio CDs to your computer (see "Ripping from a CD" on page 3-6).



# A

## Technical Specifications

# Technical Specifications

---

## Player

- Size (W x L x D)**       28.7 mm (1.1") x 71.3 mm (2.8") x 16.5 mm (0.6")
- Weight**                       26.5 g (without battery) or 39 g (with AAA-sized battery)
- Capacity**                     128 MB/256 MB/512 MB/1 GB built-in flash memory (depending on model)
- Battery Type**                 AAA-sized battery (alkaline recommended)
- Battery Life**                 MP3 (128 kbps), up to 17 hours of continuous playback.  
 WMA (64 kbps), up to 15 hours of continuous playback.  
The following may reduce the playback time:
- turning the scroller to move within a track or to select tracks during playback
  - using passive speakers or high-power headphones
  - setting long backlight timeout (more than 10 secs)
  - playing back .WMA files with a high bitrate and/or heavy bass
- FM Radio, up to 18 hours of continuous reception.
- Interface**                     USB 2.0 (USB 1.1 compatible)
- Playback Formats**         MP3 (at 8, 11.025, 12, 16, 22.05, 24, 32 and 44.1 kHz)  
 WMA (at 16, 22.05, 24, 32 and 44.1 kHz)  
 WMA with Digital Rights Management (at 16, 22.05, 24, 32 and 44.1 kHz)



FM Receiver	<input type="checkbox"/> Stereo and mono <input type="checkbox"/> 32 preset stations
Recording Formats	<input type="checkbox"/> Voice: IMA ADPCM (at 8 kHz, 4-bit, Mono) <input type="checkbox"/> FM Radio: IMA ADPCM (at 16 kHz, 4-bit, Stereo)
Signal to Noise Ratio	<input type="checkbox"/> >90 dB (Headphones)
Channel Separation	<input type="checkbox"/> >60 dB (Headphones)
Frequency Response	<input type="checkbox"/> 24 Hz~20000 Hz
Harmonic Distortion	<input type="checkbox"/> <0.05%
Operating Temperature	<input type="checkbox"/> 0 to 45°C
Storage Temperature	<input type="checkbox"/> -20 to 60°C
Firmware*	<input type="checkbox"/> Upgradeable via Internet
Headphone Out	<input type="checkbox"/> 3.5 mm (1/8") stereo minijack, 5~7 mW

---

\* Firmware upgrades are available from **[www.creative.com](http://www.creative.com)**

## LCD

- Monochrome
- Large 132 x 32 pixel
- Blue EL backlit display



# B

## On Screen Diagram and Icon Guide

# On Screen Diagram and Icon Guide

---

## Information Diagrams

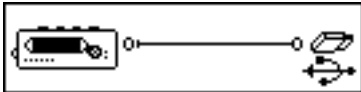
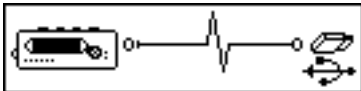
Diagram	Action/Meaning
	<ul style="list-style-type: none"> <li>○ your player is connected to your computer. To use your player, disconnect it from your computer (see "Usage" on page C-2).</li> </ul>
	<ul style="list-style-type: none"> <li>○ files are being transferred to your player.</li> </ul>

Should you see any of the following diagrams, take the appropriate recommended step below.







Diagram	Likely Causes	Suggested Action
 Hardware error	<ul style="list-style-type: none"> <li>○ physical defects</li> <li>○ numerous high-impact shocks</li> </ul>	<ul style="list-style-type: none"> <li>○ call Customer Support Services</li> </ul>
 Firmware error	<ul style="list-style-type: none"> <li>○ unexpected power loss while saving settings</li> </ul>	<ul style="list-style-type: none"> <li>○ download a newer firmware version</li> <li>○ reload firmware</li> <li>○ call Customer Support Services</li> </ul>
 Unrecoverable error	<ul style="list-style-type: none"> <li>○ player is unable to perform the selected task (for example, deleting a file)</li> </ul>	<ul style="list-style-type: none"> <li>○ clear your player's memory</li> <li>○ call Customer Support Services</li> </ul>

Diagram	Likely Causes	Suggested Action
 <span data-bbox="621 370 808 397">File system error</span>	<ul style="list-style-type: none"> <li>○ corrupted audio file</li> </ul>	<ul style="list-style-type: none"> <li>○ check that your recorded audio file is not corrupted</li> <li>○ clear your player's memory</li> </ul>
 <span data-bbox="626 657 786 684">No free space</span>	<ul style="list-style-type: none"> <li>○ unsupported file system</li> </ul>	<ul style="list-style-type: none"> <li>○ check that the file system you have selected during formatting is FAT only</li> </ul>
	<ul style="list-style-type: none"> <li>○ battery is low</li> </ul>	<ul style="list-style-type: none"> <li>○ you may need to change the battery</li> </ul>
	<ul style="list-style-type: none"> <li>○ battery is too depleted, player cannot start up</li> </ul>	<ul style="list-style-type: none"> <li>○ change the battery</li> </ul>

# Playback Icons









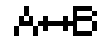

---

**The following icons appear on the screen when the associated playback action is used.**

---

Icon	Action/Meaning
	<input type="radio"/> Play
	<input type="radio"/> Pause
	<input type="radio"/> Go to previous track
	<input type="radio"/> Go to next track
	<input type="radio"/> Move back
	<input type="radio"/> Move ahead
	<input type="radio"/> Record
	<input type="radio"/> Stop

# Play Mode Icons

Icon	Action/Meaning
	○ A-B (Segment repeat)
	○ Repeat Track
	○ Repeat All
	○ Repeat Folder
	○ Play Track Once
	○ Shuffle Repeat
	○ Shuffle Once
	○ Shuffle Folder





**C**

## Frequently Asked Questions

# Frequently Asked Questions

---

This section covers questions you might have while using your player. It has been divided into a few categories for your easy reference. For further assistance, you may wish to consult our self-help tool “Knowledge Base”. Go to [www.creative.com](http://www.creative.com) and select your region.

## General

### **Where can I get official information on MP3 player products?**

Visit Creative’s web site at [www.creative.com](http://www.creative.com) for updates and downloads relating to all Creative’s MP3 players and accessories.

**Windows XP tells me that the software for the player is not certified.  
What do I do?**

At the time of this product's release, Microsoft strongly encouraged companies to submit their hardware solutions for certification. If a hardware device driver is not submitted, or does not qualify, for Microsoft certification, a warning message similar to the one below appears.

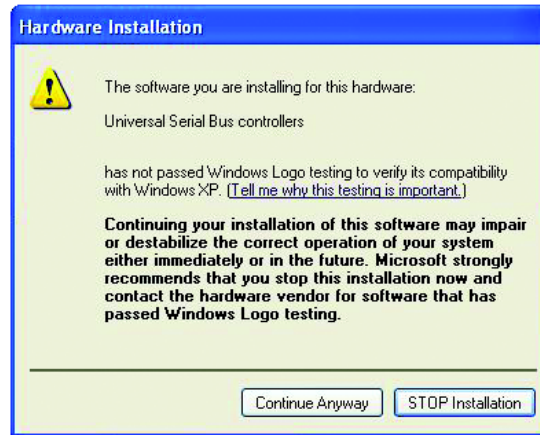

You may see this message when installing this driver or update. If you do, you may choose to click the **Continue Anyway** button. Creative has tested this driver or update on Windows XP, and it does not impair or destabilize your computer.

## Usage

**After playing a sequence of tracks, the player skips a track.**

The player will only play valid formats (MP3, WMA, or WAV FM recordings created on the player). Other types of files will be skipped.

**Files or tracks are corrupted when transferred to the player.**

Transfer may have been interrupted. Before disconnecting your player from your computer, stop your player first.

**To stop your player in Windows XP, Windows Me or Windows 2000**

- ▶ Click the **Safely Remove Hardware** icon  on the Taskbar, click **Safely remove USB Mass Storage Device**, and disconnect your player when you are prompted to do so.



**To stop your player in Windows 98 SE**

- ▶ In Windows Explorer, right-click the **Removable Disk** icon, click the **Eject** option, and disconnect your player when you are prompted to do so.

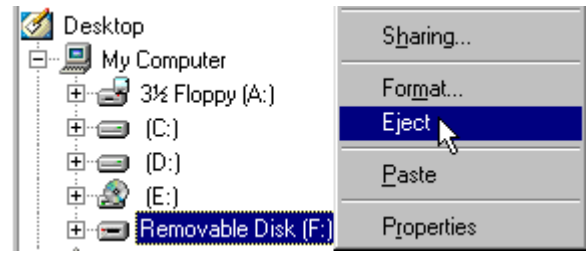

**File transfers to the player are very slow (less than 100 kb/sec).**

Try clearing your player's memory. For more information, refer to "Formatting Your Player" on page 4-22.

## **Can I use the player for portable data storage?**

Yes, you can.

## **I have to change the battery quite often. Is there anything I can do to make it last longer?**

Some operations consume more battery power:

- A long backlight timeout setting. A shorter timeout conserves battery power.
- A high contrast setting. Position the player so that you can read the display without using a high contrast setting.
- Too much use of the Scroller to move within a track or to select tracks during playback.
- Turning the player on or off too many times.
- Use of passive speakers or high-powered headphones.
- Playback of WMA files.

**CREATIVE®**

Download from [Www.Somanuals.com](http://www.Somanuals.com). All Manuals Search And Download.

## Free Manuals Download Website

<http://myh66.com>

<http://usermanuals.us>

<http://www.somanuals.com>

<http://www.4manuals.cc>

<http://www.manual-lib.com>

<http://www.404manual.com>

<http://www.luxmanual.com>

<http://aubethermostatmanual.com>

Golf course search by state

<http://golfingnear.com>

Email search by domain

<http://emailbydomain.com>

Auto manuals search

<http://auto.somanuals.com>

TV manuals search

<http://tv.somanuals.com>