

Crestron **TPS-12G/15G/17G-QM**
Isys[®] G-Series Touchpanels with
QuickMedia[®] Transport Technology

Operations Guide



This document was prepared and written by the Technical Documentation department at:



Crestron Electronics, Inc.

15 Volvo Drive

Rockleigh, NJ 07647

1-888-CRESTRON

All brand names, product names and trademarks are the property of their respective owners.

©2009 Crestron Electronics, Inc.

Contents

Isys[®] G-Series Touchpanels: TPS-12G/15G/17G-QM	1
Introduction	1
Features and Functions	2
Applications.....	5
Internal Block Diagram	6
Specifications	7
Physical Description	10
Industry Compliance	19
Setup.....	20
Network Wiring.....	20
QuickMedia Wiring.....	20
Identity Code	23
Configuring the Touchpanel.....	23
Hardware Hookup	45
Cable Management.....	47
Tilt Angle Tension Adjustment.....	48
Recommended Cleaning.....	48
Programming Software.....	49
Earliest Version Software Requirements for the PC	49
Programming with Crestron SystemBuilder.....	49
Programming with SIMPL Windows	49
Programming with VisionTools Pro-e.....	52
Example Program	55
Uploading and Upgrading.....	56
Establishing Communication.....	56
Programs, Projects and Firmware.....	57
Program Checks	58
Problem Solving	59
Troubleshooting.....	59
Check Network Wiring.....	60
Reference Documents.....	61
Further Inquiries	62
Future Updates	62
Software License Agreement.....	63
Return and Warranty Policies	65
Merchandise Returns / Repair Service	65
CRESTRON Limited Warranty.....	65

Isys[®] G-Series Touchpanels: TPS-12G/15G/17G-QM

Introduction

For simplicity within this guide, the Crestron[®] Isys[®] G-Series touchpanels are referred to as TPS-12G/15G/17G-QM, except where noted.

Crestron Isys G-Series touchpanels deliver a higher level of performance with dual window video, RGB and HDTV display to meet the demands of today's sophisticated control and automation applications. Incorporating modern styling in a versatile tiltcase design, the Isys TPS-12G/15G/17G-QM features a spectacular display offering exceptional brightness and contrast for stunning control graphics, high-resolution images and full motion HD video.

Crestron touchpanels offer an ideal user interface for multimedia presentation, video conferencing, home automation and much more, providing a wide open canvas for the creation of custom control screens tailored to the needs of the end user. Touchpanels do away with piles of remote controls, cryptic control panels and cluttered wall switches, simultaneously expanding and simplifying control over a broad range of complex devices and systems.

Features and Functions

- 12, 15 and 17 inch active matrix touchscreen displays
- 24-bit Isys graphics
- Screen resolutions: TPS-12G-QM 800 x 600, TPS-15G-QM 1024 x 768, TPS-17G-QM: 1280 x 768
- Synapse™ image rendering algorithm
- Windows® SideShow™ enabled
- DNav dynamic menu objects
- Dual-window full-motion video, HDTV and RGB display*
- Interactive annotation capability
- Built-in biamplified speaker system and microphone*
- QuickMedia® AV connectivity with audience presentation output*
- High speed Ethernet and Cresnet® communications
- Backlit “hard key” pushbuttons
- Tiltcase housing with integral rear cover and cable strain relief
- Power supply included (with TPS-17G-QM only)

* One or more QuickMedia devices are required to facilitate the input and output of audio, video and RGB signals.

Isys®

Isys power and beauty are infused throughout the entire Crestron touchpanel lineup. Under the hood, the TPS-12G/15G/17G-QM offers vibrant 24-bit color depth with 8-bit alpha channel transparency to produce incredible 3D graphics using DNav dynamic menu objects, dynamic graphics and text, animations, multimode objects and PGN translucency, all with astonishing speed.

Synapse™

The Crestron exclusive Synapse Image Rendering Algorithm enables system programmers to produce amazing graphics – faster and easier. Advanced antialiasing delivers crisper, sharper objects and text. Enhanced 3D effects add new depth and style. Since Synapse is native to the touchpanel, memory requirements and upload time are substantially reduced.

Windows® SideShow™ Enabled

New support for Windows Sideshow gives the TPS-12G/15G/17G-QM access to all kinds of PC and Web-based content such as news feeds, sports scores, stock tickers, weather alerts, media guides, email messages and appointment notifications, all through a simple network connection to a Windows Vista™ computer.

Dual-Window HD Video and RGB

The TPS-12G/15G/17G-QM can simultaneously display two fully scalable, full-motion video windows, each supporting standard video, HDTV and high-resolution RGB signals from external AV and computer sources. Discrete video scalers with motion adaptive deinterlacing bring out the highest detail, minimizing visible scan lines and motion artifacts for a truly remarkable picture. Advanced gamma correction and built-in time base correction ensure accurate color reproduction and a jitter-free image.

NOTE: One or more QuickMedia devices are required to facilitate the input and output of audio, video and RGB signals.

Touch-the-PC

Crestron exclusive “Touch-the-PC” technology allows real-time touchpanel navigation of any Windows PC through a direct high-speed serial connection.

Interactive Annotation

Built-in annotation capability allows presenters to write or draw over computer and video images right on the touchscreen using a finger, stylus or mouse. Moving images can also be frozen onscreen to allow annotation over a still picture. Brush sizes and colors are selectable on the fly. Remote annotation capability allows multiple touchpanel users to draw over the same image, supporting interactive annotation between several participants in a courtroom, classroom or similar environment. The image can also be output to a video display for live audience presentation.

High Quality Audio

The high-powered biamplified speaker system provides amplification for external AV sources and supports intercom functionality in combination with the integrated microphone. Customized WAV files can be loaded on the touchpanel to add dimension to the touchscreen graphics with personalized sounds, button feedback and voice prompts.

NOTE: One or more QuickMedia devices are required to facilitate the input and output of audio, video and RGB signals.

QuickMedia[®]

All audio and video connections are facilitated using our revolutionary QuickMedia transport, providing a flexible yet remarkably simple wiring solution. Through QuickMedia (QM), the TPS-12G/15G/17G-QM interfaces directly with other QM-based products using inexpensive CAT5e type cable.

The two QM input ports each support non-interlaced RGB up to 1600 x 1200 pixels, as well as composite, S-video and component video signals. QM input #1 includes software-adjustable compensation for cables runs up to 450 feet (137 meters); input #2 allows up to 450 feet (137 meters) for video and HDTV and shorter distances for RGB computer signals. Both QM inputs receive audio signals from the external microphone and stereo line level sources.

The QM output port allows RGB output of the touchpanel screen image to feed a display device for audience presentation. A 24-bit digital audio signal is also present for distribution of the internal microphone signal.

NOTE: One or more QuickMedia devices are required to facilitate the input and output of audio, video and RGB signals.

High-Speed Connectivity

Both Cresnet and high-speed Ethernet are standard on the TPS-12G/15G/17G-QM, providing for easy network integration and seamless communications with Crestron control systems. USB connectivity is also included for connection of an external mouse, touchscreen or similar pointing device.

Functional Tiltcase Design

The stylish tiltcase housing allows smooth tilt adjustment from 45 to 90 degrees and features an integral cable strain relief system and rear cover to secure and hide the connections at the back of the touchpanel. Five backlit pushbuttons are also provided, allowing for quick access to commonly used functions.

Applications

The following diagram shows a TPS-12G/15G/17G-QM in a lecture hall application.

TPS-12G/15G/17G-QM in a Lecture Hall Application (TPS-15G-QM Shown)

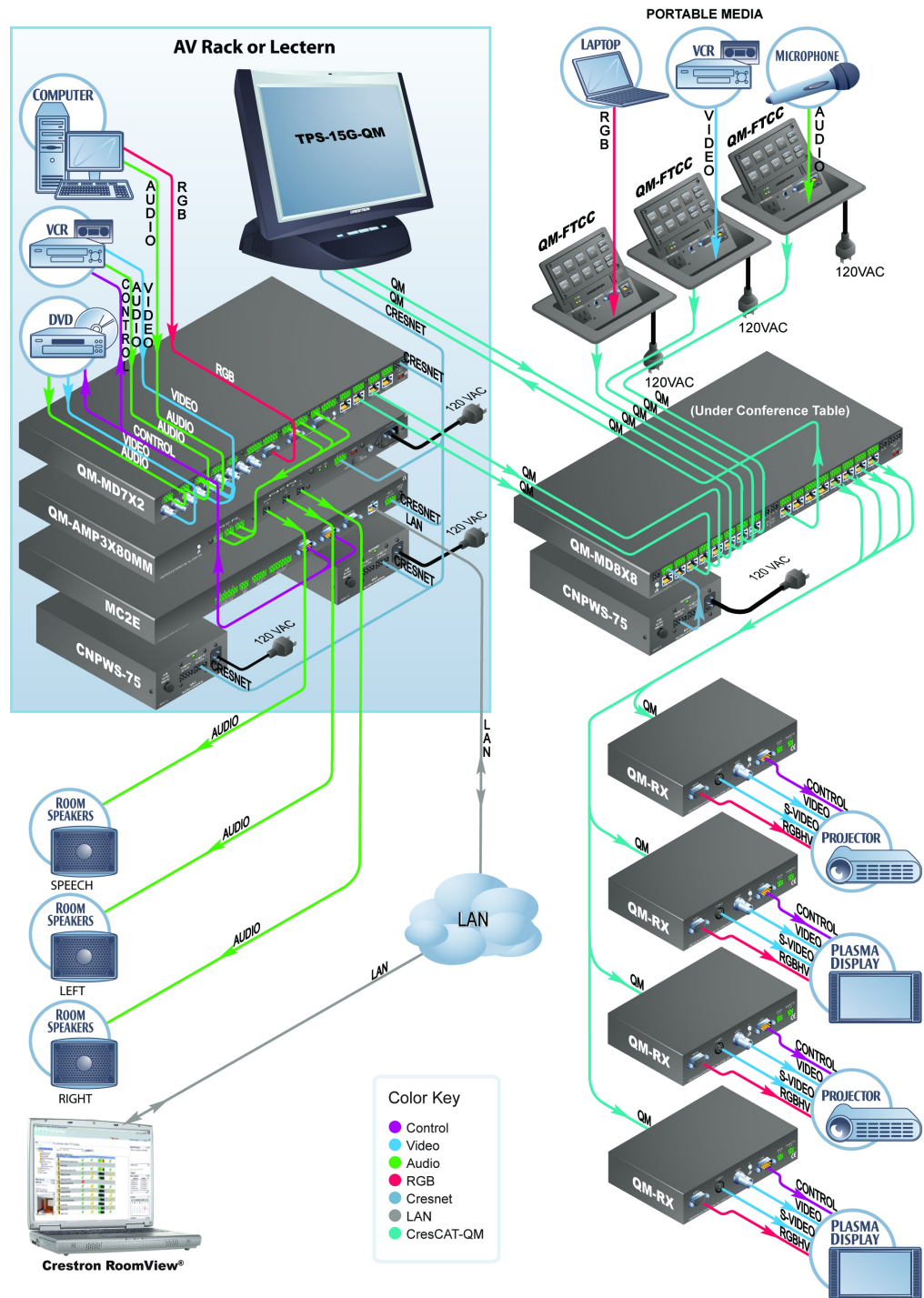

For more information on this and other QM applications, refer to the latest revision of the Crestron MediaManager Applications Guide (Doc. 6244), which is available from the Crestron website (www.crestron.com/manuals).

Internal Block Diagram

The following diagram represents the switching abilities of the TPS-12G/15G/17G-QM. The diagram depicts the video, audio and connectivity paths available.

Internal Block Diagram of the TPS-12G/15G/17G-QM

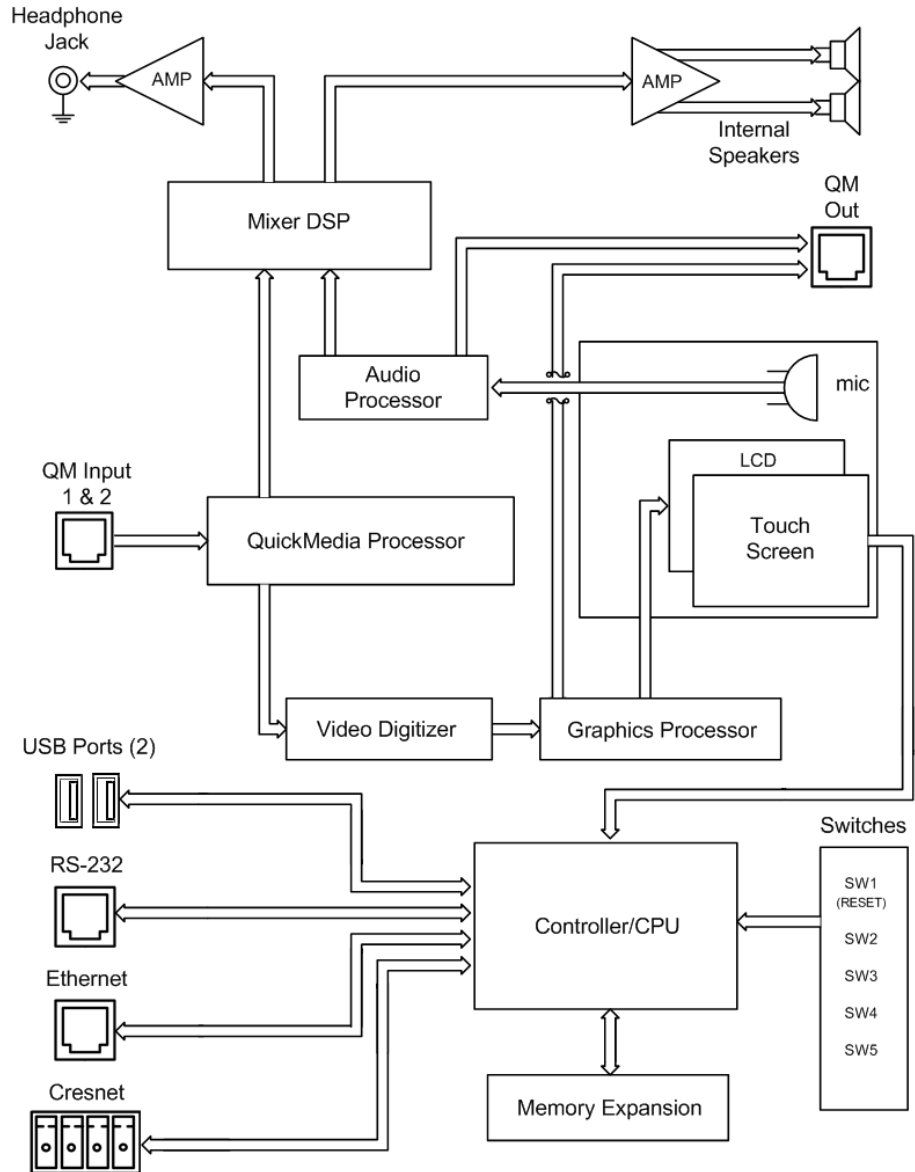

Specifications

Specifications for the TPS-12G/15G/17G-QM are listed in the following table.

TPS-12G/15G/17G-QM Specifications

SPECIFICATION	DETAILS
Touchscreen Display	
Display Type	TFT active matrix color LCD
Size	TPS-12G-QM: 12 inch (30.5 cm) diagonal TPS-15G-QM: 15 inch (38.1 cm) diagonal TPS-17G-QM: 17 inch (43.2 cm) diagonal
Aspect Ratio	TPS-12G-QM: 4:3 SVGA TPS-15G-QM: 4:3 XGA TPS-17G-QM: 15:9 WXGA
Resolution	TPS-12G-QM: 800 x 600 TPS-15G-QM: 1024 x 768 TPS-17G-QM: 1280 x 768
Brightness	TPS-12G-QM: 400 nits TPS-15G-QM: 400 nits TPS-15G-QM: 350 nits ¹ TPS-17G-QM: 450 nits
Contrast	TPS-12G-QM: 300:1 TPS-15G-QM: 300:1 TPS-15G-QM: 700:1 ¹ TPS-17G-QM: 400:1
Color Depth	TPS-12G-QM: 18-bit, 256k colors TPS-15G-QM: 24-bit, 16.7M colors TPS-17G-QM: 24-bit, 16.7M colors
Illumination	Backlit fluorescent
Viewing Angle	TPS-12G-QM: ±70° horizontal, +45/-55° vertical TPS-15G-QM: ±85° horizontal and vertical TPS-17G-QM: ±88° horizontal and vertical
Touchscreen	Resistive membrane
Processor	
CPU	32-bit Freescale Coldfire® Microprocessor
Memory	
DDR RAM	128 MB
Flash	64 MB
Compact Flash	Accepts up to 4 GB Type II CF (not included)
Maximum Project Size	160 MB
Graphic Engine	
	Isys engine, 24-bit non-palette graphics + 8-bit alpha channel transparency, 16.7 million colors, Synapse image rendering algorithm, multi-mode objects, DNav dynamic menu objects, dynamic graphics, Windows® SideShow™ enabled, PNG transparency, full-motion (60 fps) animation, transition effects, color key video windowing, remote annotation
Ethernet	10BASE-T/100BASE-TX, auto-switching, auto-negotiating, auto-discover, full/half duplex, TCP/IP, UDP/IP, CIP, DHCP, IEEE 802.3U compliant

(Continued on following page)

TPS-12G/15G/17G-QM Specifications (Continued)

SPECIFICATION	DETAILS
Video/RGB ² Signal Types Formats Color Depth Features	RGB and auto-detecting composite, S-video or component video SDTV 480i (NTSC) & 576i (PAL), EDTV 480p & 576p, HDTV 720p & 1080i; RGB (VGA) up to UXGA 1600 x 1200 24-bit, 16.7M colors Dual-window each scalable to full-screen, time base correction, gamma correction, line doubling, motion adaptive deinterlacing, reverse 3:2/2:2 pulldown
Audio ² Hardware Features Audio Feedback (WAV) D-A Conversion (via QM only) Amplification	Built-in microphone and biamplified speakers, stereo headphone output, internal volume control and audio mixer 8-bit PCM, mono, 8 kHz sampling rate 24-bit, 48 kHz Bi-amplified, mono, 5 Watts for high frequency, 5 Watts for low frequency
Power Requirements Cresnet Power Usage Power Supply	TPS-12G-QM: 50 Watts (2.08 Amps @ 24 Volts DC) TPS-15G-QM: 75 Watts (3.13 Amps @ 24 Volts DC) TPS-17G-QM: 84 Watts ³ (3.5 Amps @ 24 Volts DC) TPS-12G-QM: PW-2420RU (sold separately) TPS-15G-QM: must use Cresnet power supply TPS-17G-QM: PW-2435RU (included)
Default NET ID	03
Minimum 2-Series Control System Update File ^{4, 5, 6}	Version 3.137 or later
Environmental Temperature Humidity Heat Dissipation	41° to 113°F (5° to 45°C) 10% to 90% RH (non-condensing) TPS-12G-QM: 171 BTU/Hr TPS-15G-QM: 256 BTU/Hr TPS-17G-QM: 287 BTU/Hr
Enclosure Construction Screen Tilt	High impact black/silver injection-molded case, tilt screen with adjustable tension, integral rear cover and cable strain relief in base Adjustable 45 to 90 degrees

(Continued on following page)

TPS-12G/15G/17G-QM Specifications (Continued)

SPECIFICATION	DETAILS
Dimensions	
Height	TPS-12G-QM: 12.45 in (31.62 cm) TPS-15G-QM: 14.17 in (36.00 cm) TPS-17G-QM: 14.17 in (36.00 cm)
Width	TPS-12G-QM: 12.85 in (32.64 cm) TPS-15G-QM: 14.94 in (37.95 cm) TPS-17G-QM: 17.64 in (44.79 cm)
Depth	13.75 in (34.91 cm)
Weight	TPS-12G-QM: 13.8 lbs (6.2 kg) TPS-15G-QM: 15.2 lbs (6.9 kg) TPS-17G-QM: 19.4 lbs (8.8 kg)
Available Models	
TPS-12G-QM-B	Isys G-Series 12" Tilt Touchpanel, Black
TPS-15G-QM-B	Isys G-Series 15" Tilt Touchpanel, Black
TPS-17G-QM-B	Isys G-Series 17" Tilt Touchpanel, Black
Included Accessories (TPS-17G-QM only)	
PW-2435RU	24 Volt Power Pack
TPS-17G-QM/-L-IMC	Power Interface Module
Available Accessories	
CresCAT [®] IM	iMedia Cable
CresCAT [®] QM	QuickMedia Cable
PW-2420RU	Power Supply (for TPS-12G-QM only)
QM-TX	QuickMedia Transmitter
TPS/TPMC-CBL-T	Triamese Interface Cables
SMK-12/15/17	Swivel Mount Kit
ST-PK	Programming Cable Kit

1. Applies to part number 6500247 only.
2. One or more QuickMedia devices are required to facilitate the input and output of audio, video and RGB signals.
3. The TPS-17G-QM should be powered by the supply included with the touchpanel.
4. The latest software versions can be obtained from the Creston website. Refer to the NOTE following these footnotes.
5. Creston 2-Series control systems include the AV2 and PRO2. Consult the latest Creston Product Catalog for a complete list of 2-Series control systems.
6. When loading VisionTools Pro-e files or firmware through the RS-232 port of the control system, be sure that the baud rate is at 38400 (Cresnet speed) or lower. Otherwise, Toolbox may post the "Transfer Failed" message.

NOTE: Creston software and any files on the website are for authorized Creston dealers and Creston Authorized Independent Programmers (CAIP) only. New users may be required to register to obtain access to certain areas of the site (including the FTP site).

Physical Description

This section provides information on the connections, controls and indicators available on your TPS-12G/15G/17G-QM.

TPS-12G-QM Physical View



TPS-15G-QM Physical View



TPS-17G-QM Physical View



NOTE: In the following illustrations, numbers separated by a diagonal or horizontal line represent differing dimensions between the TPS-12G-QM and TPS-15G-QM (or TPS-12G-QM, TPS-15G-QM and TPS-17G-QM) units.

TPS-12G/15G-QM Overall Dimensions (Front View)

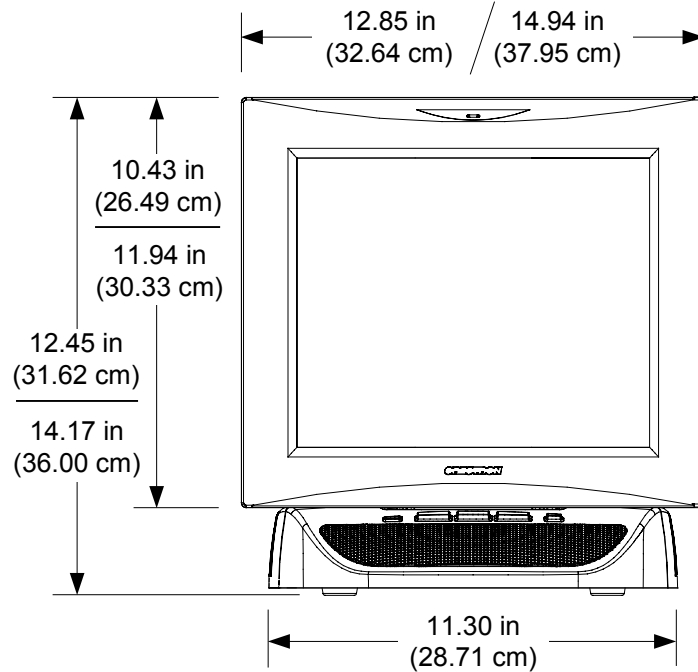

TPS-17G-QM Overall Dimensions (Front View)

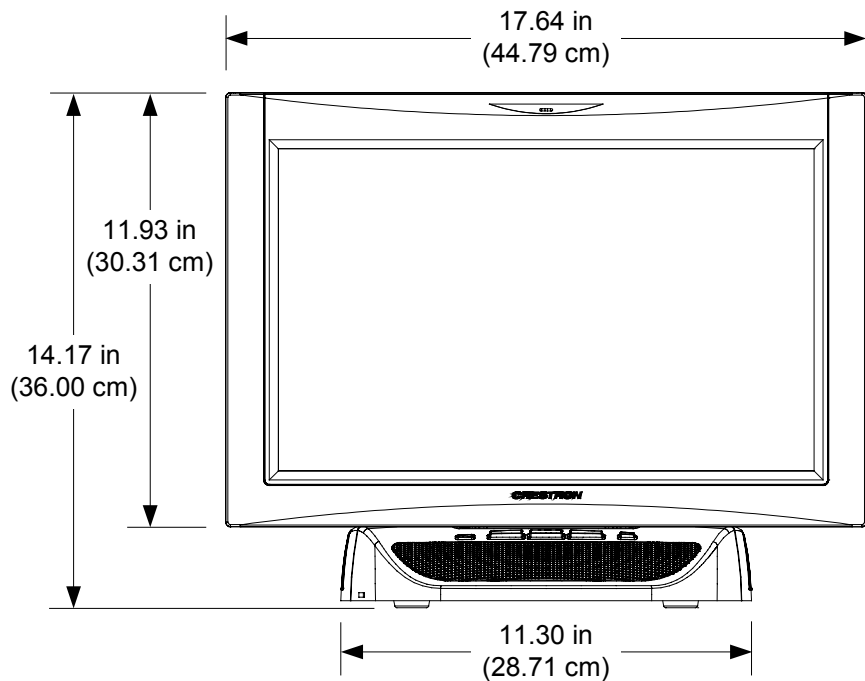

TPS-12G/15G/17G-QM Overall Dimensions (Side View)

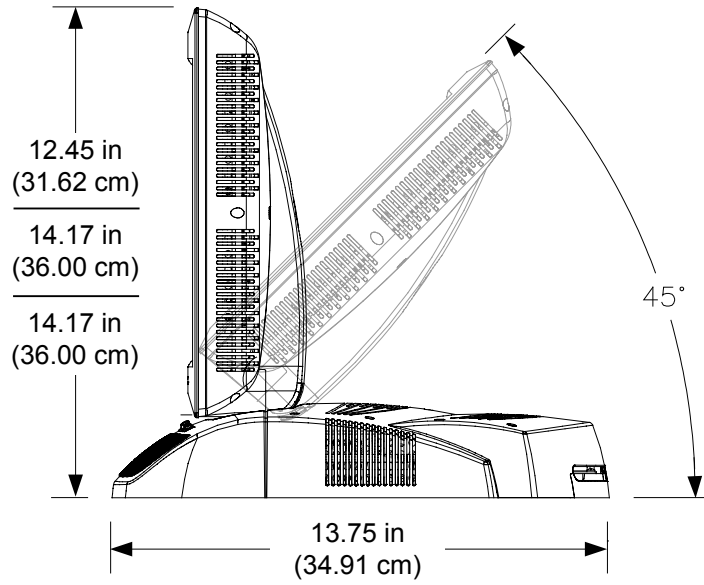

NOTE: The TPS-12G/15G/17G touchpanels share an identical base unit.

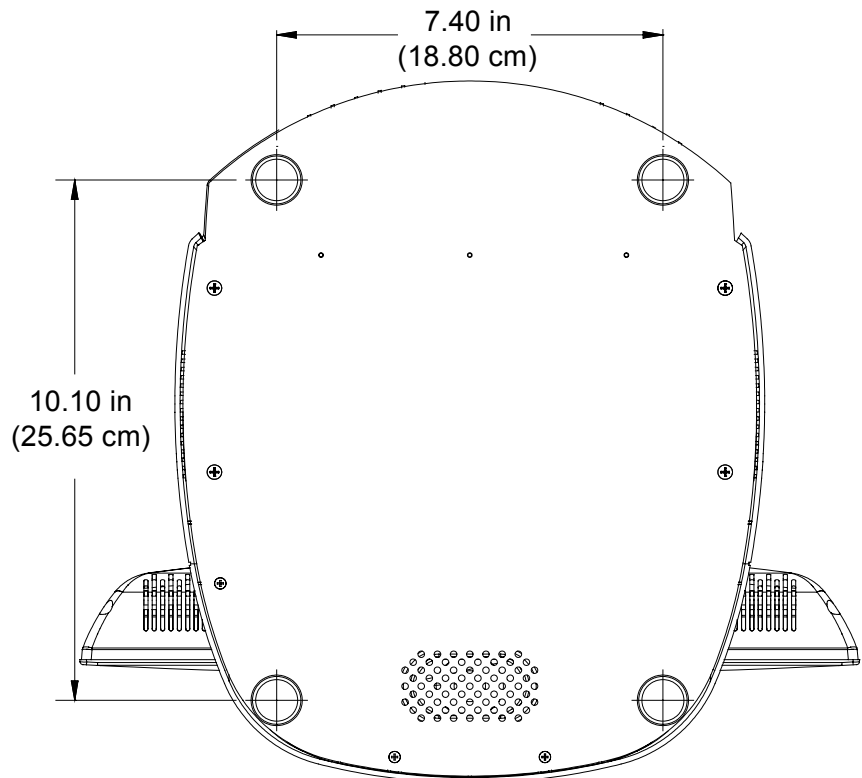

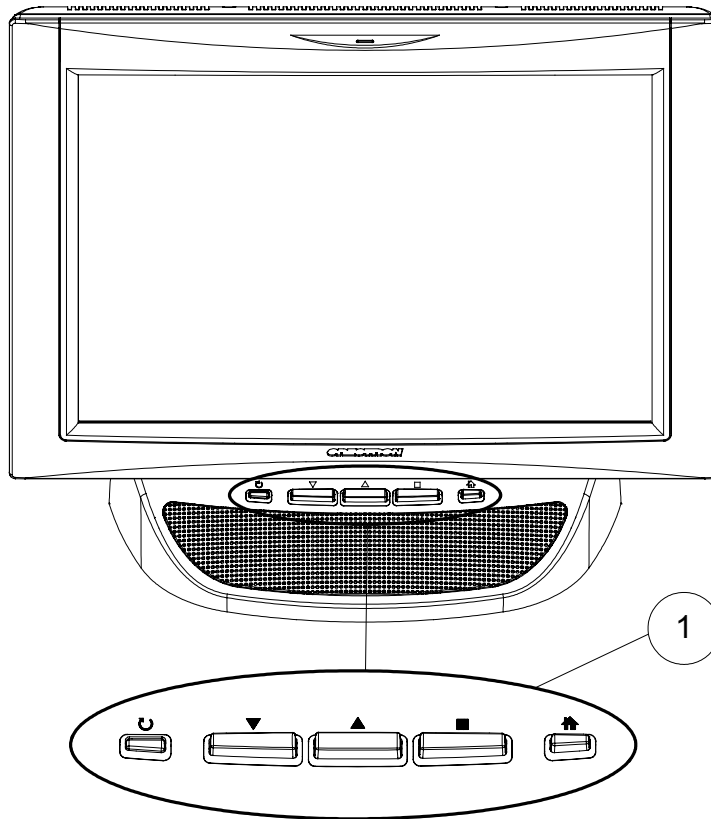

TPS-12G/15G/17G-QM Buttons

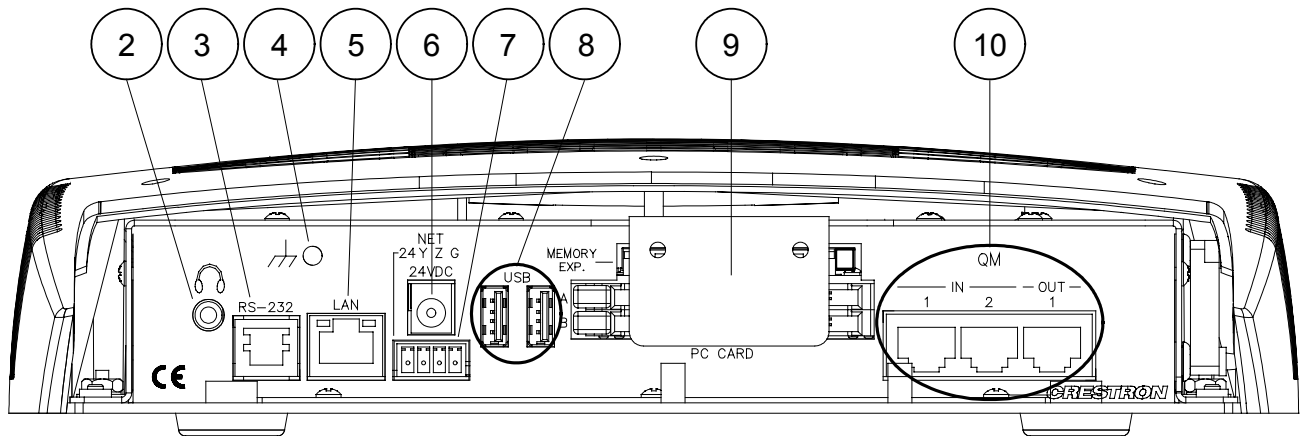

TPS-12G/15G/17G-QM Connectors



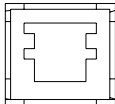
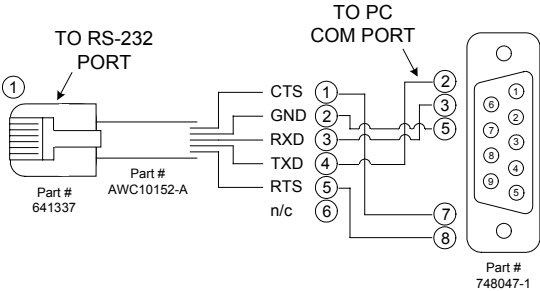

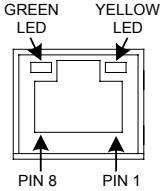
Connectors, Controls & Indicators

#	CONNECTORS ¹ , CONTROLS & INDICATORS	DESCRIPTION																				
1	BUTTONS ²	(4) Backlit “hard key” buttons, programmable (1) Backlit hard reset button, reboots the touchpanel																				
2	HEADPHONES ³ 	(1) 3.5 mm TRS mini phone jack; Output power: 12 mW per channel; Minimum impedance: 32 Ω																				
3	RS-232 	(1) 6-pin RJ-11 female; Computer console, touch output or mouse/touch input port; Bidirectional RS-232 up to 115.2k baud; Hardware and software handshaking support <table border="1" data-bbox="922 688 1263 947"> <thead> <tr> <th>PIN #</th> <th>DESCRIPTION</th> </tr> </thead> <tbody> <tr> <td>1</td> <td>CTS</td> </tr> <tr> <td>2</td> <td>GND</td> </tr> <tr> <td>3</td> <td>RXD</td> </tr> <tr> <td>4</td> <td>TXD</td> </tr> <tr> <td>5</td> <td>RTS</td> </tr> <tr> <td>6</td> <td>N/C (Not connected)</td> </tr> </tbody> </table> <p>In the event that modular cables or an RJ-11 to DB9F adapter is not available, the following diagram provides information so that the cable can be fabricated on site. (Alternatively, Crestron cable number STCP-502PC is sold separately.)</p> 	PIN #	DESCRIPTION	1	CTS	2	GND	3	RXD	4	TXD	5	RTS	6	N/C (Not connected)						
PIN #	DESCRIPTION																					
1	CTS																					
2	GND																					
3	RXD																					
4	TXD																					
5	RTS																					
6	N/C (Not connected)																					
4	G 	(1) 6-32 screw, chassis ground lug																				
5	LAN  PIN 8 PIN 1	(1) 8-wire RJ-45 with two LED indicators; 10BASE-T/100BASE-TX Ethernet port; Green LED indicates link status; Yellow LED indicates Ethernet activity <table border="1" data-bbox="922 1633 1157 1787"> <thead> <tr> <th>PIN</th> <th>SIGNAL</th> </tr> </thead> <tbody> <tr> <td>1</td> <td>TX +</td> </tr> <tr> <td>2</td> <td>TX -</td> </tr> <tr> <td>3</td> <td>RC+</td> </tr> <tr> <td>4</td> <td>N/C</td> </tr> </tbody> </table> <table border="1" data-bbox="1192 1633 1419 1787"> <thead> <tr> <th>PIN</th> <th>SIGNAL</th> </tr> </thead> <tbody> <tr> <td>5</td> <td>N/C</td> </tr> <tr> <td>6</td> <td>RC -</td> </tr> <tr> <td>7</td> <td>N/C</td> </tr> <tr> <td>8</td> <td>N/C</td> </tr> </tbody> </table>	PIN	SIGNAL	1	TX +	2	TX -	3	RC+	4	N/C	PIN	SIGNAL	5	N/C	6	RC -	7	N/C	8	N/C
PIN	SIGNAL																					
1	TX +																					
2	TX -																					
3	RC+																					
4	N/C																					
PIN	SIGNAL																					
5	N/C																					
6	RC -																					
7	N/C																					
8	N/C																					

(Continued on following page)

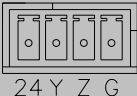
Connectors, Controls & Indicators (Continued)

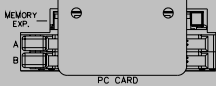
#	CONNECTORS ¹ , CONTROLS & INDICATORS	DESCRIPTION										
6	24 VDC ^{4, 5} 24VDC 	(1) 2.1 mm barrel DC power jack, 24 Volt DC power input										
7	NET ⁴  24 Y Z G	Four-position terminal block connector, Cresnet slave port; Connects to Cresnet control network. 24: Power (24 Volts DC) Y: Data Z: Data G: Ground										
8	USB USB 	(2) USB Type A female, USB 1.1 ports for mouse or touchscreen input <table border="1" data-bbox="922 764 1263 940"> <thead> <tr> <th>PIN</th> <th>DESCRIPTION</th> </tr> </thead> <tbody> <tr> <td>1</td> <td>+5 VDC</td> </tr> <tr> <td>2</td> <td>Data -</td> </tr> <tr> <td>3</td> <td>Data +</td> </tr> <tr> <td>4</td> <td>Ground</td> </tr> </tbody> </table>	PIN	DESCRIPTION	1	+5 VDC	2	Data -	3	Data +	4	Ground
PIN	DESCRIPTION											
1	+5 VDC											
2	Data -											
3	Data +											
4	Ground											
9	MEMORY EXP./ PC CARD (A – B) 	(1) Type II Compact Flash card slot for memory expansion (2) Type II PC Card slots (reserved for future applications)										

(Continued on following page)

Connectors, Controls & Indicators (Continued)

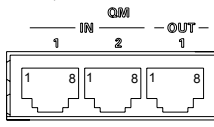
#	CONNECTORS ¹ , CONTROLS & INDICATORS	DESCRIPTION
10	<p>QM IN 1 & 2⁶</p>  <p>QM OUT 1</p>	<p>(1 each) 8-wire RJ-45 female, QuickMedia input port; Signal types: Dynamically configurable under system control as:</p> <ul style="list-style-type: none"> • (1) RGB input with stereo program audio and (2) mic channels or • (1) Auto-detecting component (YPbPr), S-video (Y/C) or composite video input with stereo program audio and (2) mic channels <p>RGB format: RGBHV; RGB input resolution, non-interlaced: 640 x 480 minimum to 1600 x 1200 maximum (60 Hz limit at 1600 x 1200); Video/HDTV formats: 480i (NTSC), 576i (PAL), 480p, 576p, 720p and 1080i; Horizontal frequency: 15 - 100 kHz; Vertical frequency: 50 - 85 Hz; Delay skew compensation: 0 - 22 ns (QM IN 1 only, none on QM IN 2); Connects to QM output port of a QM-TX or other QuickMedia device (sold separately) via CresCAT™-QM or CresCAT-IM cable; Maximum cable length: QM IN 1: 450 feet (137 meters) (aggregate distance from QM origination); QM IN 2: (Video/HDTV) 450/300 feet (137/91 meters) (aggregate distance from QM origination); (RGB @ 60 Hz) 216 feet (66 meters) for 640 x 480, 140 feet (43 meters) for 800 x 600, 84 feet (26 meters) for 1024 x 768, 70 feet (21 meters) for 1280 x 768, 30 feet (9 meters) for 1600 x 1200 (using CresCAT-QM or CresCAT-IM cable)</p> <p>(1) 8-wire RJ-45 female, QuickMedia output port containing RGB (same as touchscreen), WAV file audio and internal microphone signals; RGB format: RGBHV; RGB output resolution, non-interlaced (@ 60 Hz): TPS-12G-QM: 800 x 600 pixels; TPS-15G-QM: 1024 x 768 pixels; TPS-17G-QM: 1280 x 768 pixels; Connects to QM input port of any QuickMedia device via CresCAT-QM or CresCAT-IM cable</p>

1. An interface connector for the **NET** port is provided with the unit.
2. Refer to “Pushbutton Programming” on page 55 for details. For reset, press and hold button for 10 seconds.
3. Plugging in headphones will mute the built-in speakers.

4. The TPS-12G-QM can be powered via the **24 VDC** jack or the **NET** port. Be sure to use a Crestron approved power supply as another may cause damage. The TPS-17G-QM connects to the Cresnet control network and remote power supply via the TPS-17G-QM/-L-IMC Power Interface Module (included with the TPS-17G-QM).
CAUTION: Do not connect the TPS-17G-QM directly to the Cresnet network bus.
5. This port not used by the TPS-15G-QM, which instead, must be powered via Cresnet connector only, using CNPWS-75 or C2N-SPWS300 power supply (sold separately). The TPS-17G-QM may be powered via this port or via the TPS-17G-QM/-L-IMC Power Interface Module (included) using the power supply provided.
6. The eight-pin RJ-45 QuickMedia transport port accepts CAT5E/CAT6 carrying audio, video and microphone signals. The QM input port conforms to the 568B wiring standard. Refer to the following table for connector pinouts.

RJ-45 PIN NUMBER	WIRE COLORS (EIA 568B)	QM ASSIGNMENT: RGB	QM ASSIGNMENT: COMPOSITE, S-VIDEO, COMPONENT AND AUDIO
1	WHITE/ORANGE	- RGB RED	- CHROMINANCE (- P _r)
2	ORANGE	+ RGB RED	+ CHROMINANCE (+ P _r)
3	WHITE/GREEN	- RGB GREEN	- LUMINANCE (- Y)
4	BLUE	+ DIGITAL AUDIO	+ AUDIO
5	WHITE/BLUE	- DIGITAL AUDIO	- AUDIO
6	GREEN	+ RGB GREEN	+ LUMINANCE (+ Y)
7	WHITE/BROWN	- RGB BLUE	- COMPOSITE (- P _b)
8	BROWN	+ RGB BLUE	+ COMPOSITE (+ P _b)

Industry Compliance

As of the date of manufacture the TPS-12G/15G/17G-QM has been tested and found to comply with specifications for CE marking and standards per EMC and Radiocommunications Compliance Labelling.



Federal Communications Commission (FCC) Compliance Statement

This device complies with part 15 of the FCC rules. Operation is subject to the following two conditions: (1) this device may not cause harmful interference and (2) this device must accept any interference received, including interference that may cause undesired operation.

CAUTION: Changes or modifications not expressly approved by the manufacturer responsible for compliance could void the user's authority to operate the equipment.

NOTE: This equipment has been tested and found to comply with the limits for a Class B digital device, pursuant to part 15 of the FCC Rules. These limits are designed to provide reasonable protection against harmful interference in a residential installation. This equipment generates, uses and can radiate radio frequency energy and if not installed and used in accordance with the instructions, may cause harmful interference to radio communications. However, there is no guarantee that interference will not occur in a particular installation. If this equipment does cause harmful interference to radio or television reception, which can be determined by turning the equipment off and on, the user is encouraged to try to correct the interference by one or more of the following measures:

- Reorient or relocate the receiving antenna.
 - Increase the separation between the equipment and receiver.
 - Connect the equipment into an outlet on a circuit different from that to which the receiver is connected.
 - Consult the dealer or an experienced radio/TV technician for help.
-

Setup

Network Wiring

When wiring the network, consider the following:

- Use Crestron Certified Wire.
- Use Crestron power supplies for Crestron equipment.
- Provide sufficient power to the system.

CAUTION: Insufficient power can lead to unpredictable results or damage to the equipment. Please use the Crestron Power Calculator to help calculate how much power is needed for the system (www.crestron.com/calculators).

Cresnet

For networks with 20 or more devices, use a Cresnet Hub/Repeater (CNXHUB) to maintain signal quality.

For more details, refer to “Check Network Wiring” which starts on page 60.

Ethernet

The TPS-12G/15G/17G-QM can also use high-speed Ethernet for communications between the device and a control system, computer, digital media server and other IP-based devices.

For information on connecting Ethernet devices in a Crestron system, refer to the latest version of the Crestron e-Control® Reference Guide (Doc. 6052), which is available for download from the Crestron website.

QuickMedia Wiring

The Crestron QuickMedia cable (sold under the name “CresCAT-QM”) contains one CAT5E cable and one Cresnet cable in Siamese jackets. Installation of any QM device is as simple as installing CresCAT-QM wires from the output of one device to the input of another. Installations are flexible, affordable and fast. For more information, refer to the latest revision of the Crestron MediaManager Applications Guide (Doc. 6244).

CresCAT-QM Cable

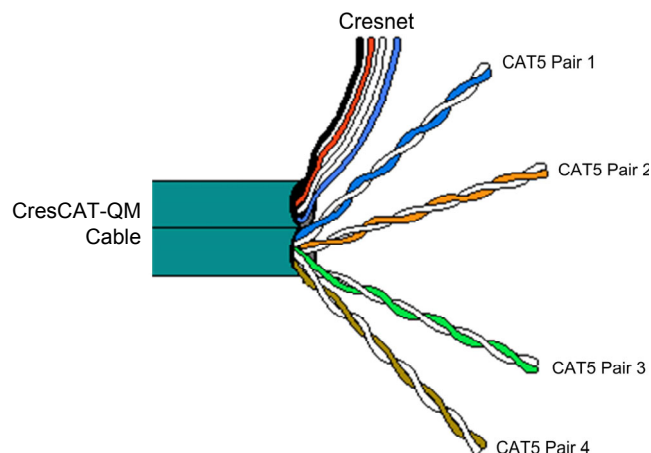

NOTE: Do not untwist the two wires in a single pair for more than 1/3-1/2" (0.84-1.27 cm) when making a connection. The twists are critical to canceling out interference between the wires.

The aggregate cable length of a signal path originating at a QM transmitter and terminating at the TPS-12G/15G/17G-QM must not exceed 450 feet (137 meters). Video signals may experience a loss of quality over very long lengths of cable. This phenomenon is due to the added resistance and capacitance of longer cable lengths and is not peculiar to either Crestron and/or QuickMedia systems. To ensure sufficient bandwidth, the maximum aggregate cable length should not exceed 450 feet. The use of lower-resolution signals may allow increased cable length but must be tested by the installer with the sources to be used. The QM pin assignment is based on the EIA/TIA 568B RJ-45 Jack standard.

NOTE: **QM IN 2** does not have delay skew compensation (as does **QM IN 1**), so the maximum cable length varies based upon resolution and should not exceed 450 feet (137 meters) for standard definition video. Refer to the QM Input #2 Maximum Cable Length table on that follows.

QM Input # 2 Maximum Cable Length

SIGNAL TYPE	RESOLUTION	MAXIMUM CABLE LENGTH* (FEET)
Video/S-video	480i/576i	450
Component	480p/576p	300
Component	720p	300
Component	1080i	300
RGB	1024 x 768 @ 75 Hz	69
RGB	1280 x 1024 @ 75 Hz	40
RGB	1600 x 1200 @ 60 Hz	30
RGB	640 x 480 @ 60 Hz	216
RGB	800 x 600 @ 60Hz	140
RGB	1024 x 768 @ 60Hz	84
RGB	1280 x 768 @ 60Hz	70

* With CresCAT-QM cable, available from Crestron. Using other may adversely affect performance and is not recommended.

NOTE: When transmitting S-video, luminance uses the green video pathway and chrominance uses the red video pathway. When transmitting composite video, the signal is carried on the blue video pathway.

NOTE: When using CresCAT-QM wiring, four additional wires are included for making Cresnet connections.

When connecting multiple QM devices, the route between a QM origination point (transmitter) and a QM endpoint (receiver) cannot have more than two midpoints (e.g. QM-MD7x2 or other QM switchers). Refer to the following illustration when configuring a QM network.

NOTE: The aggregate length from transmitter to receiver cannot have a delay skew of more than 22 ns.

QM Network Topology

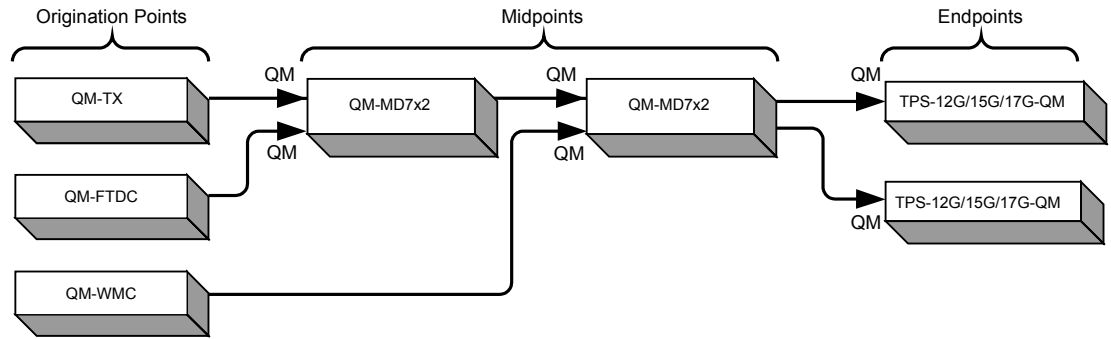

The TPS-12G/15G/17G-QM is not a switcher, but a transmitter/endpoint. Therefore, even when designated as the endpoint from two midpoint switchers, the QM output of the TPS-12G/15G/17G-QM can become another transmitter sending RGB video at the touchpanel’s native resolution and aspect ratio. Refer to the following illustration.

QM Network Topology with TPS-12G/15G/17G-QM Acting as an Endpoint and a Transmitter

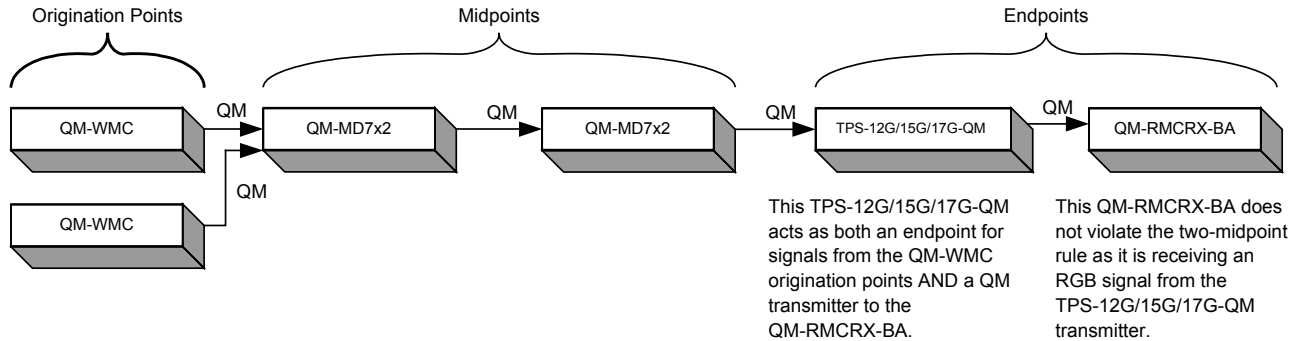

Identity Code

Net ID

The Net ID of the TPS-12G/15G/17G-QM has been factory set to **03**. The Net IDs of multiple TPS-12G/15G/17G-QM devices in the same system must be unique. The NET ID is set using the internal setup menu (refer to “Interface Menu” on page 28). Net ID may also be set from a personal computer (PC) via the Crestron Toolbox™ (refer to “Establishing Communication” which starts on page 56).

When setting the Net ID, consider the following:

- The Net ID of each unit must match an ID code specified in the SIMPL Windows program.
- Each network device must have a unique Net ID.

For more details, refer to the Crestron Toolbox help file.

IP ID

The IP ID is set within the TPS-12G/15G/17G-QM’s table using Crestron Toolbox. For information on setting an IP table, refer to the Crestron Toolbox help file. The IP IDs of multiple TPS-12G/15G/17G-QM devices in the same system must be unique.

When setting the IP ID, consider the following:

- The IP ID of each unit must match an IP ID specified in the SIMPL Windows program.
- Each device using IP to communicate with a control system must have a unique IP ID.

Configuring the Touchpanel

NOTE: The only connection required to configure the touchpanel is power (supplied via Cresnet). Refer to “Hardware Hookup” which starts on page 45 for details.

To configure the unit it may be necessary to access a series of setup screens prior to viewing run-time screens that are loaded into the touchpanel for normal operation. The MAIN MENU for configuring the touchpanel appears when a finger is held to the touchscreen as power is applied or after the hardware reset button is pressed and released. Remove your finger when the message “SETUP MODE” briefly appears on the touchscreen.

Upon entering SETUP MODE the MAIN MENU, as shown in the following illustration, displays four buttons: **Touch Screen Calibration, Exit and Run Program, Setup and Diagnostics.**

The **Exit and Run Program** button verifies that all of the setup information has been saved to the EEPROM and displays the main page that has been programmed into your system. The remaining buttons on the MAIN MENU open other menus which are discussed in subsequent paragraphs.

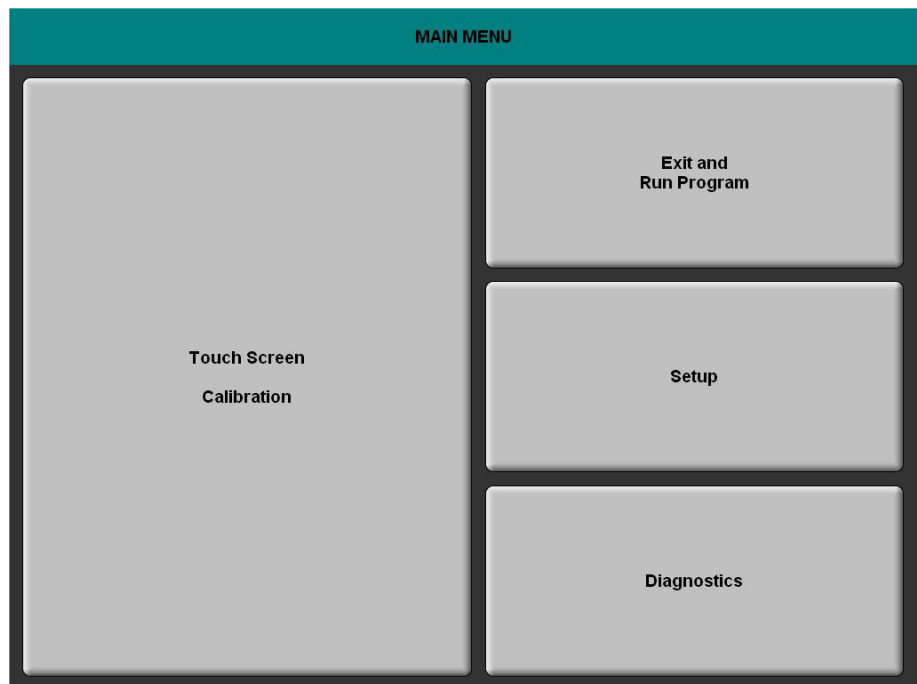
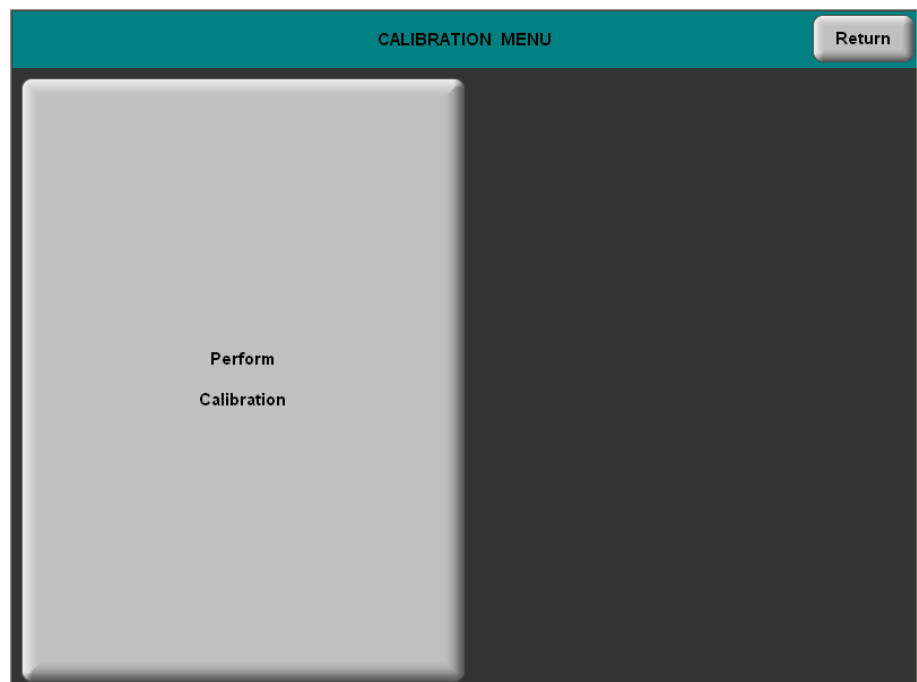
MAIN MENU**Calibration Menu***CALIBRATION MENU*

Touch **Perform Calibration**. The message "Touch Upper Left" appears centered on the panel with a cross hair in the upper left corner. Touch the center of the cross hair in the corner of the screen to initiate calibration. Another message, "Touch Upper Right", appears with a cross hair in the correct corner. Touch the center of the cross

hair in the corner of the screen. A final message, “Touch Lower Right”, appears with a cross hair in the correct corner. Touch the center of the cross hair in the corner of the screen to conclude calibration and return to the CALIBRATION MENU.

NOTE: When touching the screen during calibration, be as accurate as possible. Use the tip of a capped pen or the eraser end of a pencil. To cancel calibration and return to the CALIBRATION MENU without saving calibration data, create a calibration error by touching the screen in the same spot three times.

Setup Menu

To enter the SETUP MENU touch **Setup** on the MAIN MENU. The SETUP MENU offers a series of buttons which open additional menus and displays and are detailed in subsequent paragraphs. The SETUP MENU also provides **Down/Up** buttons to control *Screen Brightness*, *Key Backlight Brightness* and *Standby Timeout*. The *Hardkey Test Results* indicators will light when each respective button is pushed on the touchpanel. After setup parameters have been selected, touch **Return** to go back to the MAIN MENU.

NOTE: For convenience the current CRESNET ID setting is displayed in the upper left corner.

NOTE: All touchpanel settings are automatically saved in non-volatile memory.

SETUP MENU

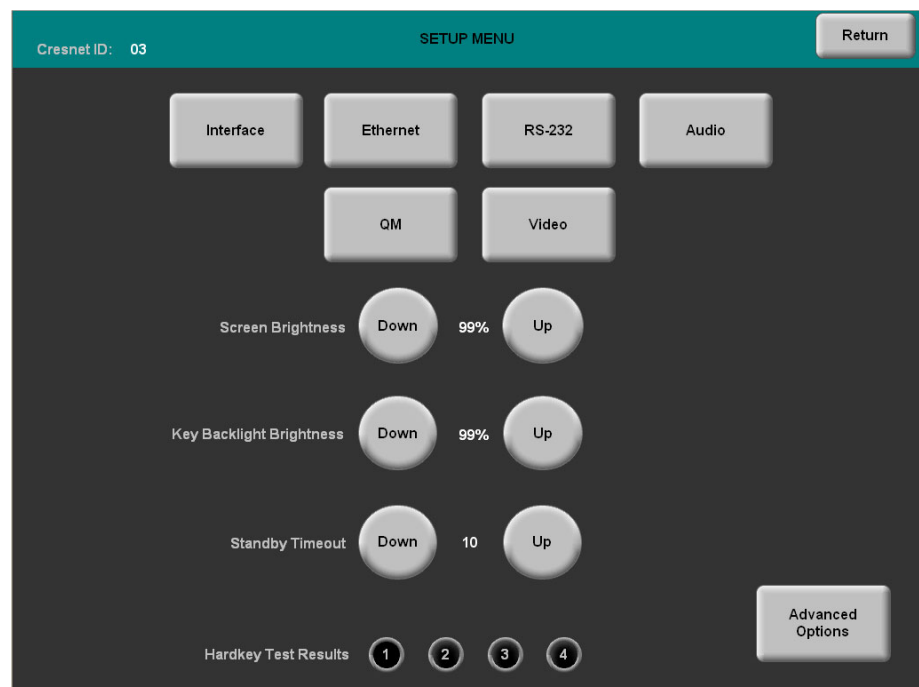

Advanced Options Menu

Touch **Advanced Options** to access the ADVANCED OPTIONS MENU. This menu allows adjustments for *Graphics Options*, *LCD Level Settings*, *Key Backlight Level Settings* and *Auto Control Transition Rate*. The *Auto Control Transition Rate*

controls allow you to select the speed at which screen and backlight levels change when you select a different screen or backlight brightness.

Touch **Return** to go back to the SETUP MENU.

ADVANCED OPTIONS MENU

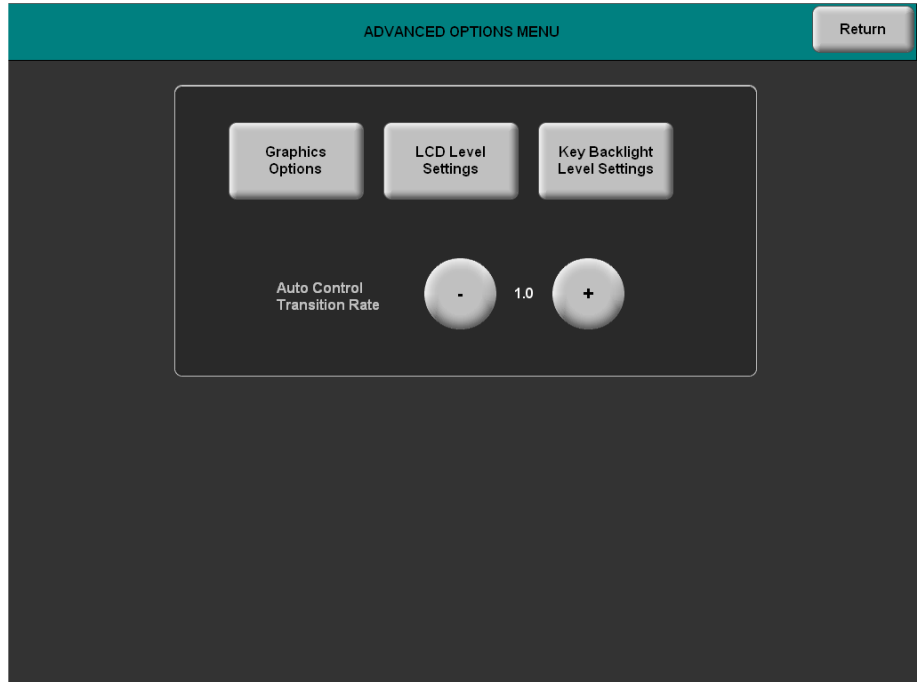

Touch **Graphics Options** to enter the GRAPHICS MENU.

GRAPHICS MENU

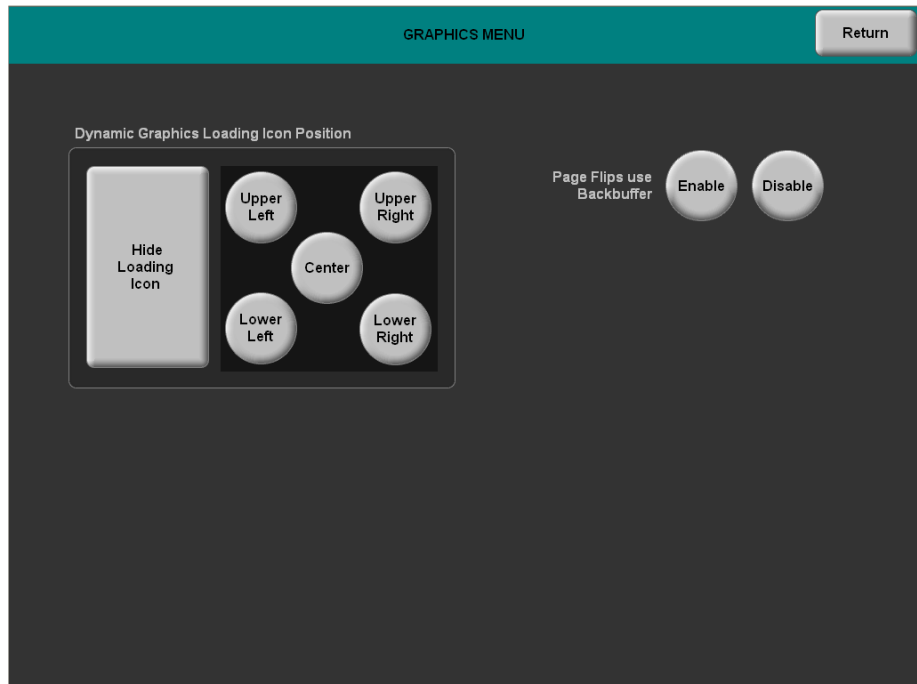

The GRAPHICS MENU provides controls for *Dynamic Graphics Loading Icon Position* and for hiding the loading icon. There are also *Page Flips use Backbuffer* **Enable** and **Disable** buttons. When enabled, new pages are drawn in the backbuffer and displayed when fully drawn. When disabled, new pages will be drawn on the screen from top to bottom.

Touch **Return** to go back to the ADVANCED OPTIONS MENU.

From the ADVANCED OPTIONS MENU, touch **LCD Level Settings** to enter the Screen Brightness Settings menu.

Screen Brightness Settings

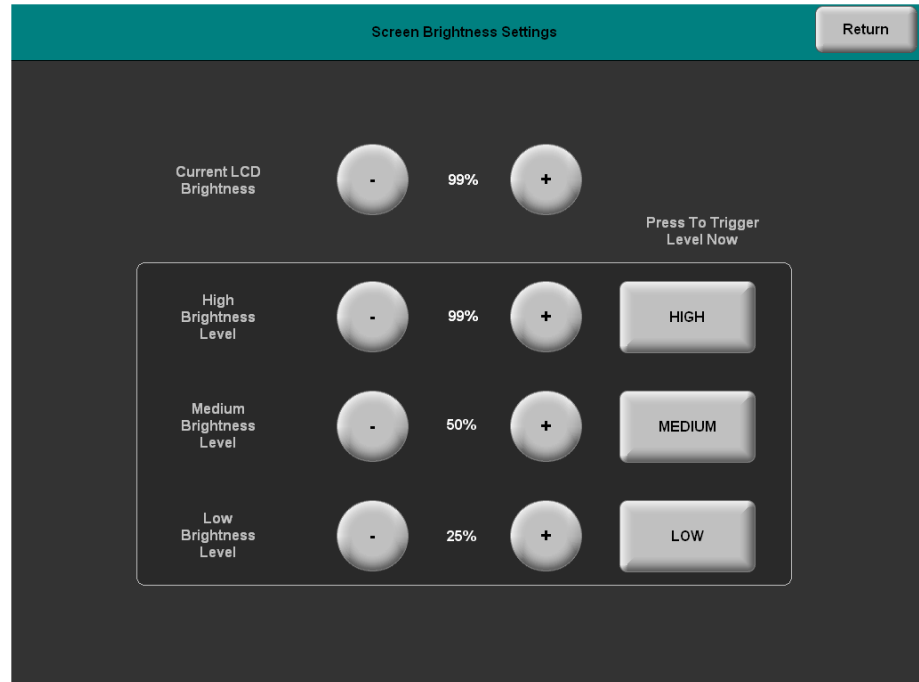

The Screen Brightness Settings menu provides – and + controls to adjust *Current LCD Brightness*, *High Brightness Level*, *Medium Brightness Level* and *Low Brightness Level*.

The *Press To Trigger Level Now* buttons allow for immediate setting of screen brightness level to **HIGH**, **MEDIUM** or **LOW**.

Touch **Return** to go back to the ADVANCED OPTIONS MENU.

From the ADVANCED OPTIONS MENU, touch **Key Backlight Level Settings** to enter the Key Backlight Settings menu.

Key Backlight Settings

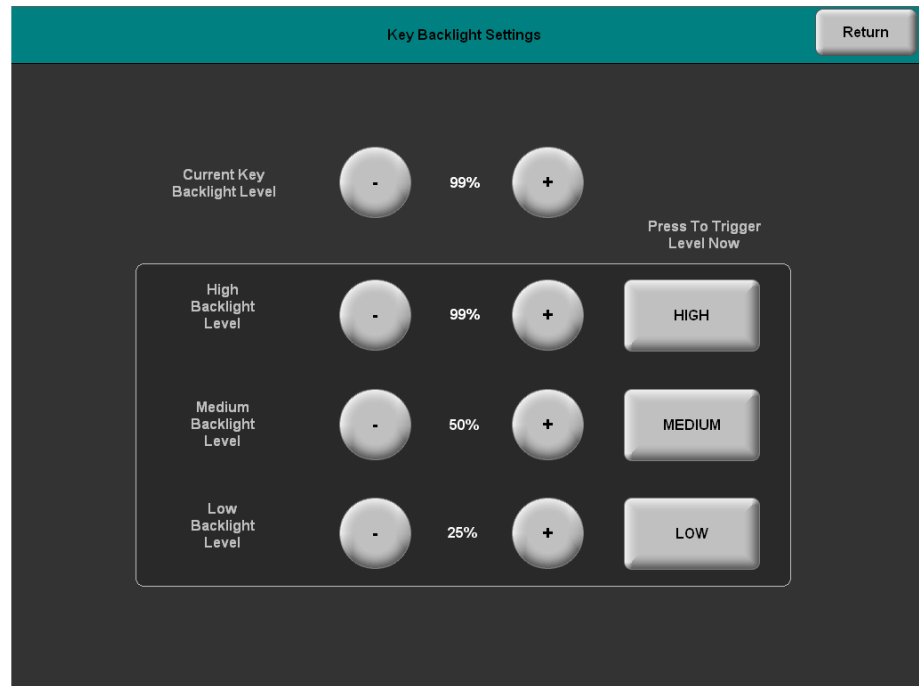

The Key Backlight Settings menu provides – and + controls to adjust *Current Key Backlight Level*, *High Brightness Level*, *Medium Brightness Level* and *Low Brightness Level*.

The *Press To Trigger Level Now* buttons allow for immediate setting of key brightness level to **HIGH**, **MEDIUM** or **LOW**.

Touch **Return** to go back to the ADVANCED OPTIONS MENU.

Interface Menu

The touchpanel communicates with a control system to activate commands or to display feedback from components within the system. The communication interface must be correctly specified or communication will not occur. To set communication parameters touch the **Interface** button located on the SETUP MENU and display the INTERFACE MENU, shown on the following page.

The Cresnet network identity number (CRESNET ID also known as the Net ID) is displayed on the INTERFACE MENU. Net ID is the two-digit hexadecimal number. The hexadecimal number can range from 03 to FE and must correspond to the Net ID set in the SIMPL Windows program of the Cresnet system. Matching IDs between touchpanel and SIMPL Windows program is required if data is to be successfully transferred. Net ID for the TPS-12G/15G/17G-QM is factory set to 03. No two devices in the same system can have the same Net ID.

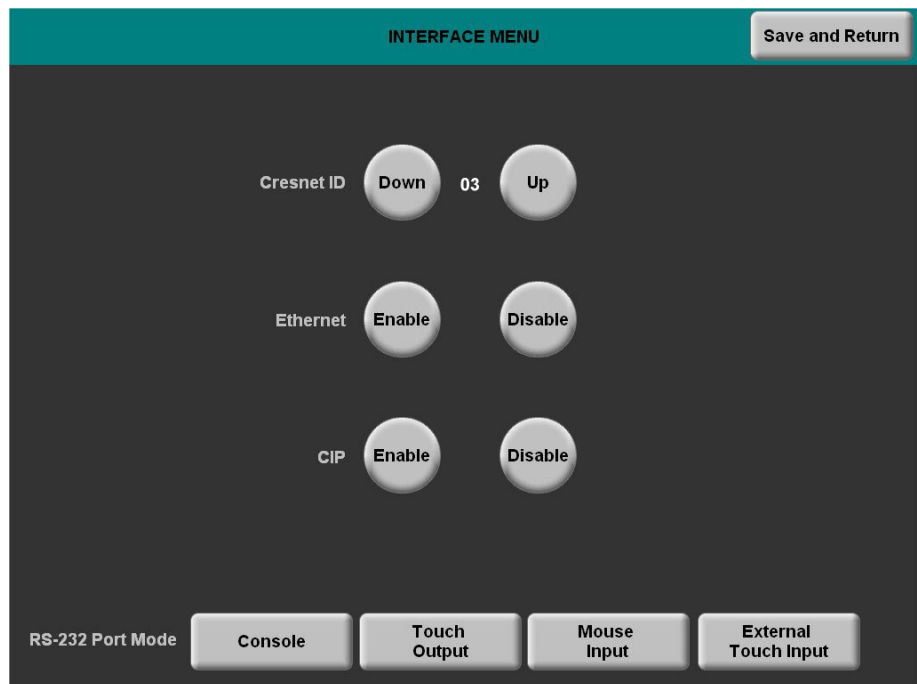
INTERFACE MENU

Two buttons adjacent to the hexadecimal display, **DOWN** and **UP**, decrease and increase the Net ID by one, respectively.

The four buttons at the bottom define how the RS-232 port can be used; as a console port (i.e. loading touchpanel projects and firmware), a touch output port (communication of touch coordinates to an external device), a mouse input port (allows a mouse to control the touchpanel) and an external touch input (allows another device to control the touchpanel).

The Ethernet **Enable** and **Disable** buttons determine the status of the touchpanel's Ethernet communications.

NOTE: The TPS-12G/15G/17G-QM does not support a wireless Ethernet connection.

There may be Ethernet devices (i.e. a control system) on the network that communicate with the touchpanel via CIP (Cresnet Internet Protocol). Two buttons located on the INTERFACE MENU determine if the touchpanel is capable of this type of communication. Touch **Enable** to permit this protocol recognition and **Disable** to prohibit any CIP connection. CIP must be enabled for the touchpanel to communicate with other Crestron Ethernet devices.

Touch the **Save and Return** button located on the INTERFACE MENU to save changes and return to the SETUP MENU.

Ethernet Setup Menu

Touching the **Ethernet** button on the SETUP MENU displays the ETHERNET SETUP MENU. This menu provides information on the Current IP Address and Ethernet link status, along with buttons for **DHCP Enable** and **Disable** and, when DHCP is disabled, *Static IP Options*.

The enable/disable Ethernet feature is provided on the INTERFACE MENU. Ethernet settings are made through Crestron Toolbox. Refer to the TCP/IP Communications section of “Establishing Communication”, which starts on page 56 for additional Ethernet setup details.

Touch **Ethernet Status Test** for details such as the IP Address, Subnet Mask, Default Router, IP Table, etc.

The ETHERNET SETUP MENU also provides – and + controls to set the *CTP Port*. Touch **Set Default Port** to return the CTP Port setting to its factory default.

Touch **Return** to go back to the SETUP MENU.

ETHERNET SETUP MENU (DHCP Enabled)

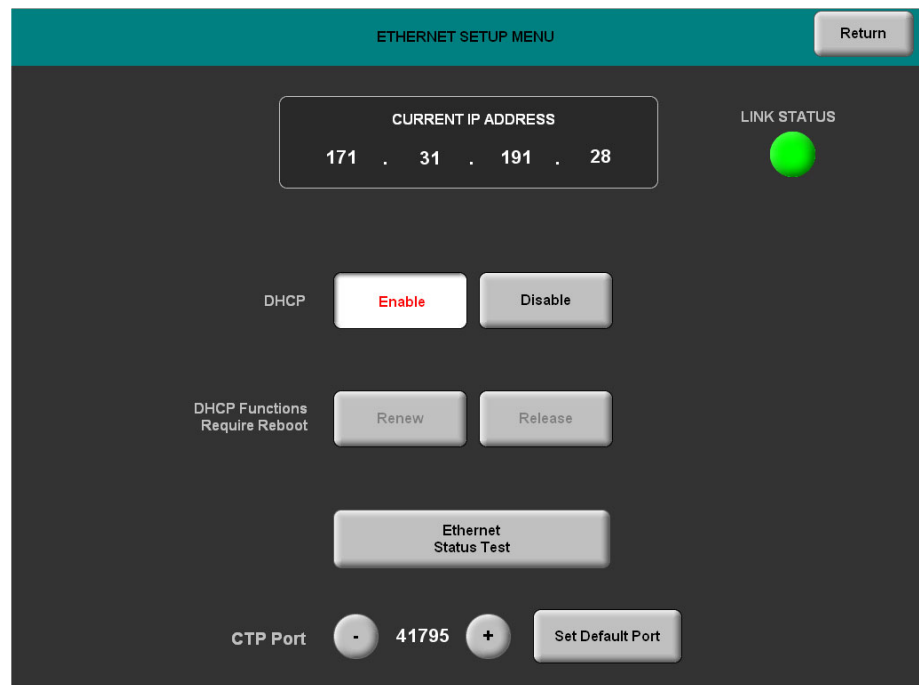

To use a static IP address, touch **DHCP Disable**. The ETHERNET SETUP MENU will change to show the *Static IP Options*.

ETHERNET SETUP MENU (DHCP Disabled)

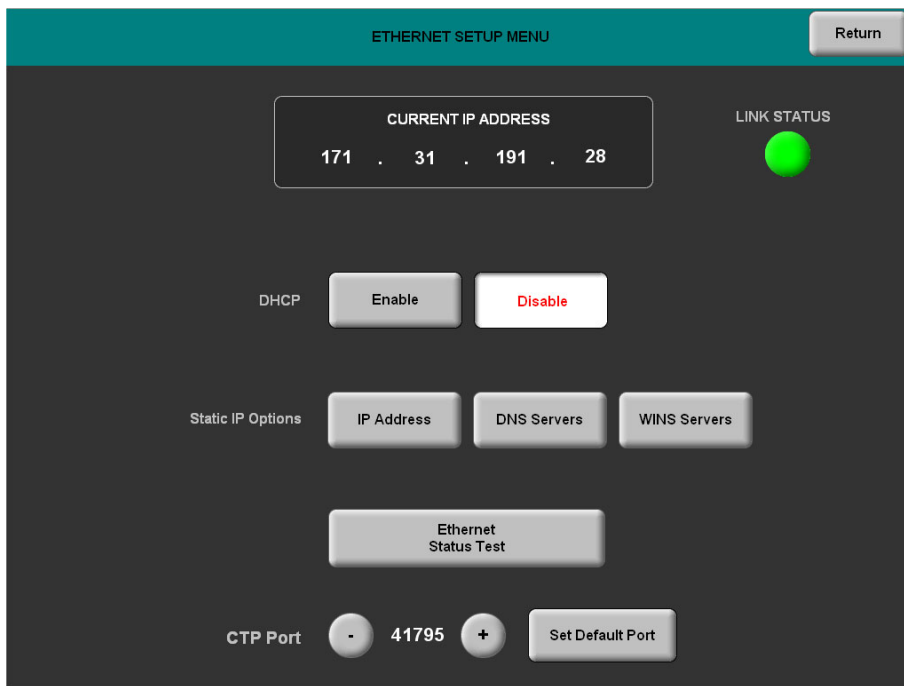

Each of the *Static IP Options* has its own menu, as shown in the illustrations below and on the following page.

ETHERNET STATIC IP SETTINGS

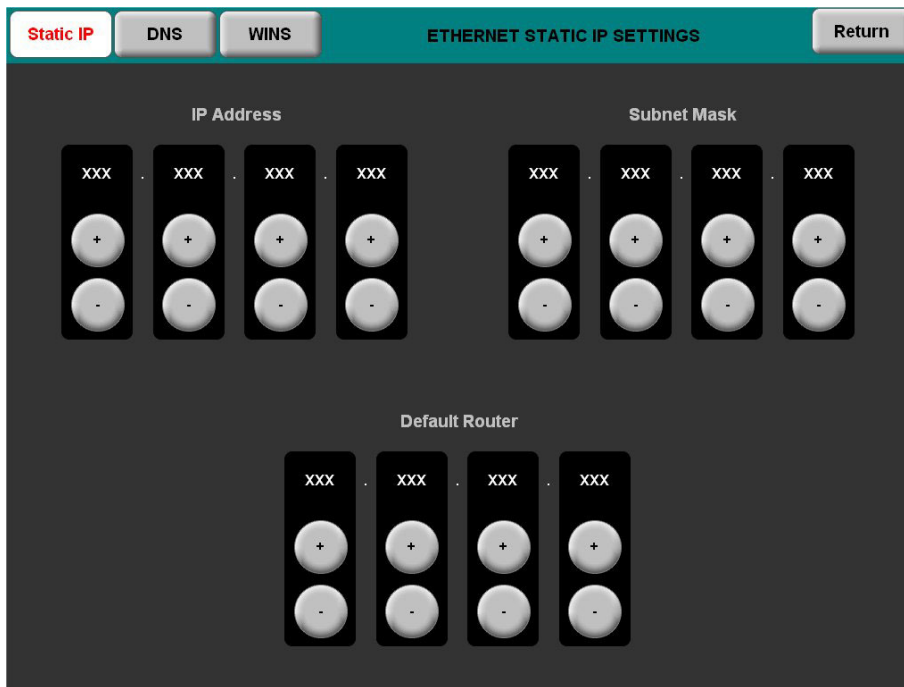

ETHERNET DNS SETTINGS

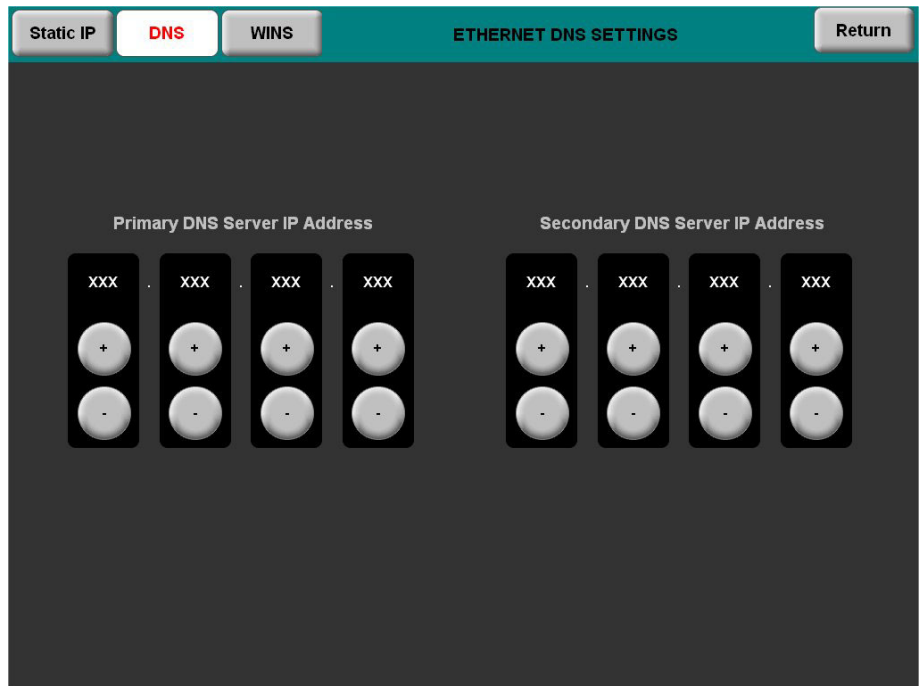

ETHERNET WINS SETTINGS

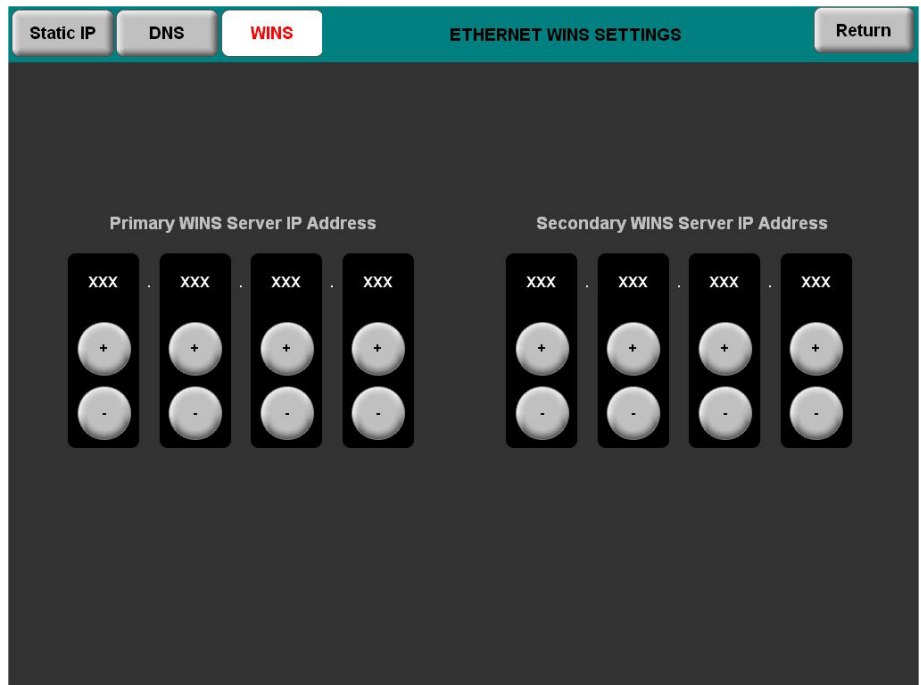

RS-232 Menu

The touchpanel allows for one of four RS-232 communication modes:

- **Console** (i.e. loading projects and firmware)
- **Touch Output** (communication of touch coordinates to an external device)
- **Mouse Input** (allows a mouse to control the touchpanel)
- **External Touch Input** (allows another device to control the touchpanel)

For convenience the RS-232 MENU also permits the selection of the RS-232 communication options Baud Rate, Data Bits, Stop Bits, Parity, RTS On/Off and XON-XOFF On/Off.

Touch the communication option to select communication parameters and then touch **Save and Return** to save the RS-232 settings and go back to the SETUP MENU.

Default settings: Console mode, Baud Rate: 115200, data bits: 8, stop bits: 1, parity: none, RTS off and XON/XOFF off.

RS-232 MENU

The screenshot displays the RS-232 MENU interface. At the top right is a 'Save and Return' button. The menu is organized into several sections:

- Baud Rate:** A 3x3 grid of buttons with values: 300, 1200, 2400 (top row); 4800, 9600, 19200 (middle row); 38400, 57600, 115200 (bottom row).
- Data Bits:** Buttons for 7 and 8.
- Stop Bits:** Buttons for 1 and 2.
- Parity:** Buttons for None, Odd, and Even.
- RTS:** Buttons for Off and On.
- XON - XOFF:** Buttons for Off and On.
- RS-232 Port Mode:** Four buttons: Console, Touch Output, Mouse Input, and External Touch Input.

General Audio Setup

To open the GENERAL AUDIO SETUP menu touch **Audio** on the SETUP MENU. The GENERAL AUDIO SETUP menu offers a series of buttons that adjust the volume level as indicated by the gauges. *Speaker Volume, Key Click Volume, WAV Volume* and *Headphone Volume* are independently adjustable. Controls for *Bass, Treble* and *Headphone Balance* are also provided.

The **Play Test WAV File** button plays a short audio file. The **Restore Default Audio Settings** button returns all audio parameters to their default settings. Touching **QM Input** on the GENERAL AUDIO SETUP menu displays the QM AUDIO INPUT SETUP menu. This menu allows adjustment of volume levels for QM audio inputs. After audio parameters have been set, touch **Return** to go back to the SETUP MENU.

GENERAL AUDIO SETUP

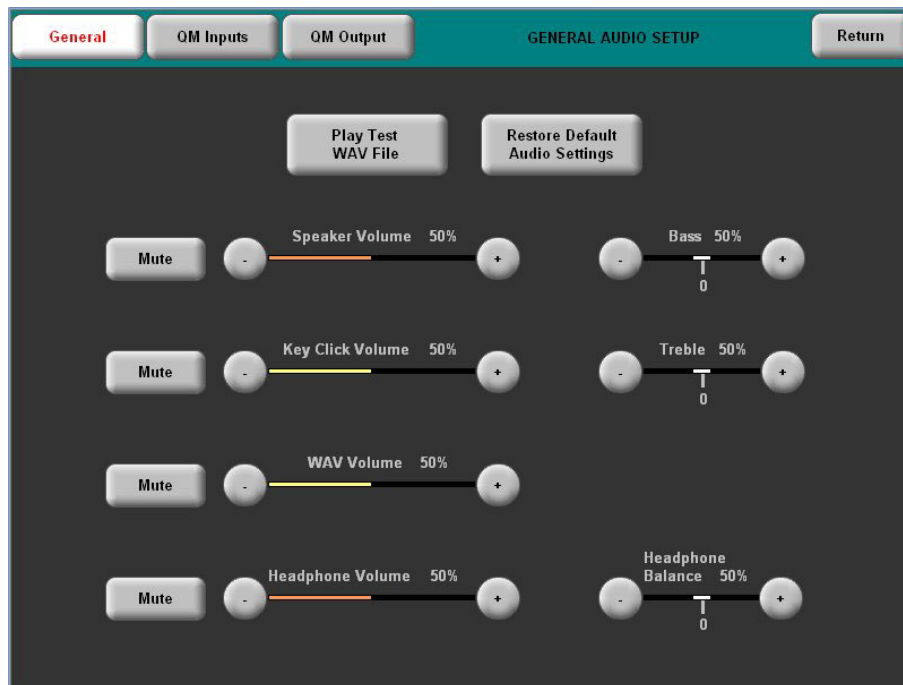

Refer to the following table for additional GENERAL AUDIO SETUP menu details.

General Audio Setup Details

GENERAL AUDIO SETUP SCREEN CONTROL	DESCRIPTION
QM Inputs	Selects QM AUDIO INPUT SETUP menu.
QM Output	Selects QM AUDIO OUTPUT SETUP menu.
Play Test WAV File	Plays a short WAV audio file.
Restore Default Audio Settings	Returns audio settings to their factory defaults.
Mute	A separate Mute button is provided for each of the volume controls.

(Continued on following page)

General Audio Setup Details (Continued)

GENERAL AUDIO SETUP SCREEN CONTROL	DESCRIPTION
Speaker Volume	The volume of both audio inputs (key click and WAV) is affected by the Speaker Volume control. If the Speaker Volume control is set to 100% the volume for any audio input is at maximum. If the Speaker Volume is set to 0% the value of all audio inputs is overridden and the touchpanel is silent. If the Speaker Volume is a percentage (say 50%), then all audio inputs can only achieve half their value.
Key Click Volume	Adjusts the level of the key click sound with the – and + buttons.
WAV Volume	Adjusts the volume of the WAV file with the – and + buttons. Click Play Test WAV File button to sample and adjust the volume as a pre-loaded WAV file plays.
Headphone Volume	Adjusts the level of the headphone output with the – and + buttons. (This control is visible only when headphones are connected.)
Bass	Adjusts the overall bass output with the – and + buttons.
Treble	Adjusts the overall treble output with the – and + buttons.
Headphone Balance	Adjusts the left/right balance of the headphone output with the – and + buttons. (This control is visible only when headphones are connected.)

To open the QM AUDIO INPUT SETUP menu, touch **QM Inputs** on the GENERAL AUDIO SETUP menu. The QM AUDIO INPUT SETUP menu offers controls for *Prog Volume*, *Mic1 Volume* and *Mic2 Volume* for both **QM Audio 1** and **QM Audio 2** inputs.

The **Restore Default Audio Settings** button returns all audio parameters for the QM inputs to their default settings. After QM AUDIO INPUT SETUP parameters have been set, touch **Return** to go back to the SETUP MENU.

QM AUDIO INPUT SETUP

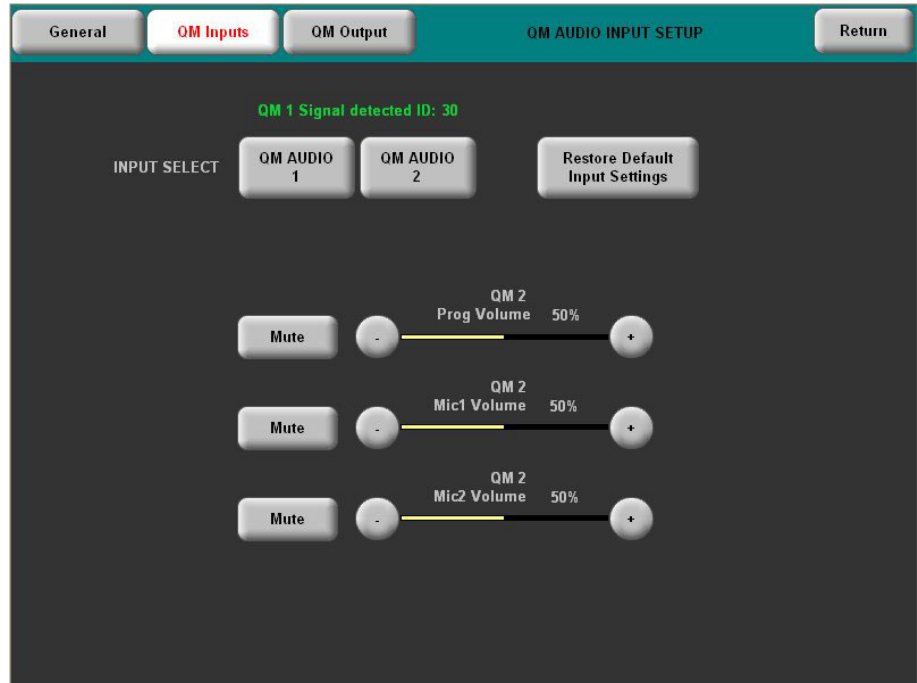

Refer to the following table for additional QM AUDIO INPUT SETUP menu details.

QM Audio Input Setup Details

QM AUDIO INPUT SETUP SCREEN CONTROL	DESCRIPTION
INPUT SELECT QM AUDIO 1 QM AUDIO 2	Selects QM audio source. This selection determines whether QM 1 or QM 2 inputs are displayed.
Restore Default Audio Settings	Returns audio settings to their factory defaults.
Mute	A separate Mute button is provided for each of the volume controls.
QM 1 / QM 2 Prog Volume	Adjusts the level of the respective QM input with the – and + buttons.
QM 1 / QM 2 Mic1 Volume	Adjusts the level of <i>Mic1</i> on the respective QM input with the – and + buttons.
QM 1 / QM 2 Mic2 Volume	Adjusts the level of <i>Mic2</i> on the respective QM input with the – and + buttons.

To open the QM AUDIO OUTPUT SETUP menu, touch **QM Output** on the GENERAL AUDIO SETUP menu. The QM AUDIO OUTPUT SETUP menu offers controls for *Program Gain*, *Transmit QM ID* and a four-band *Speech EQ Trims* equalizer.

The **Restore Default Audio Settings** button returns all audio parameters for the QM output to their default settings. After QM AUDIO OUTPUT SETUP parameters have been set, touch **Return** to go back to the SETUP MENU.

QM AUDIO OUTPUT SETUP

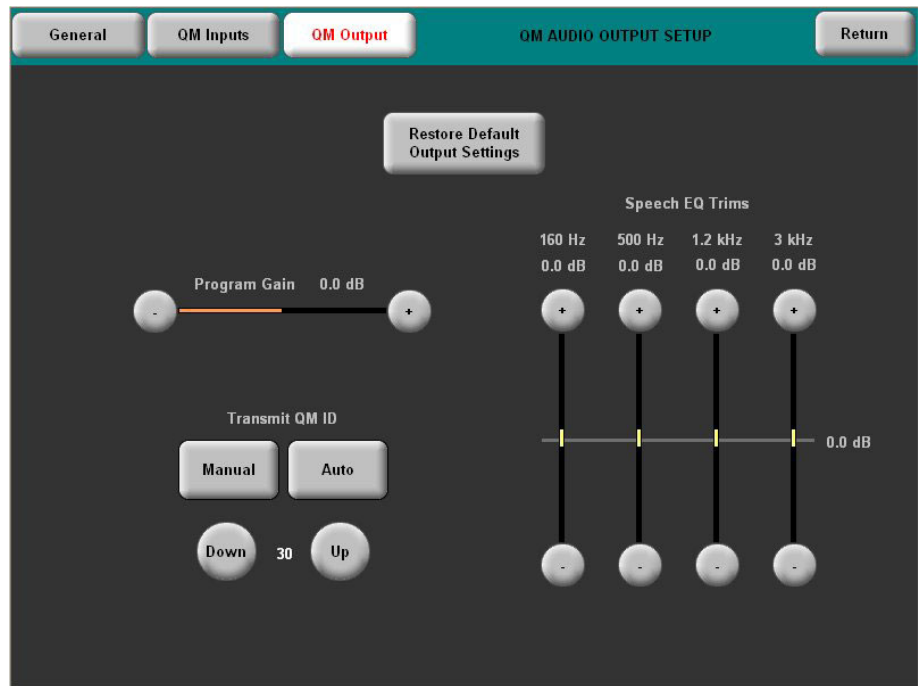

Refer to the following table for additional QM AUDIO OUTPUT SETUP menu details.

QM Audio Output Setup Details

QM AUDIO OUTPUT SETUP SCREEN CONTROL	DESCRIPTION
Program Gain	Adjusts the level of the QM output with the – and + buttons.
Transmit QM ID	Allows transmission of touchpanel’s QM ID for use in QM systems utilizing auto compensation*. Manual will transmit a specific QM ID, adjustable with the Down and Up Buttons. Auto , the default setting, will transmit the Cresnet ID as the QM ID.
Speech EQ Trims	Adjust relative level of the QM output at four speech related frequencies with the – and + buttons. These will alter the tonality of the QM audio output.

* Auto compensation automatically recalls microphone EQ settings, source compensation settings and peak and boost preset values of multiple QM origination points when acting as an endpoint.

QM Setup

To open the QM SETUP menu, touch **QM** on the SETUP MENU. The QM SETUP menu offers controls for selecting QM Audio Input, QM Setup channels and video type for each QM Setup channel.

After these parameters have been set, touch **Return** to go back to the SETUP MENU.

QM SETUP

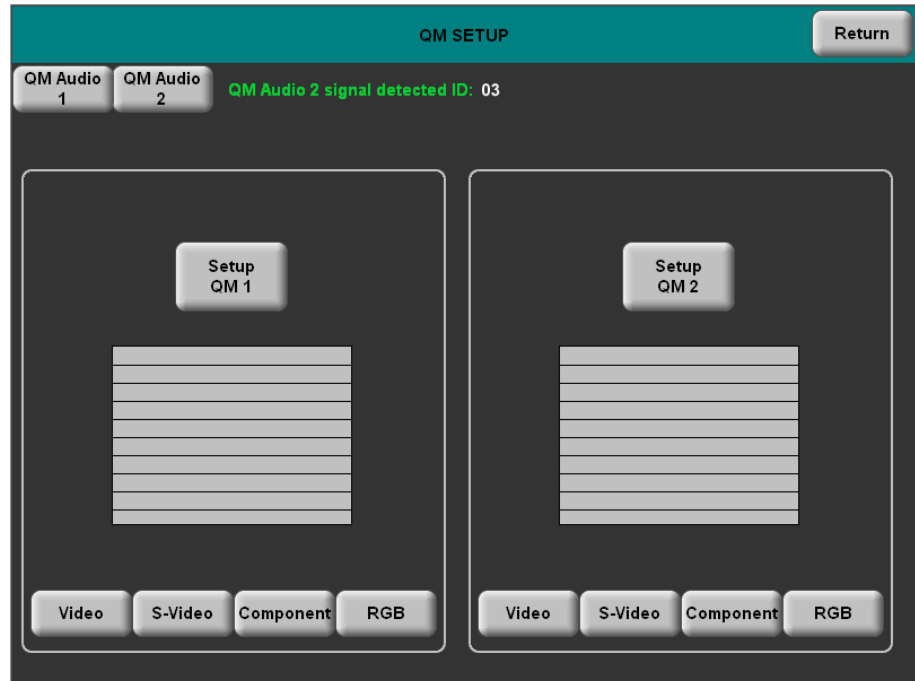

Refer to the following table for additional QM SETUP menu details.

QM Setup Details

QM SETUP SCREEN CONTROL	DESCRIPTION
QM Audio 1	Detects the presence of QM Audio on channel 1.
QM Audio 2	Detects the presence of QM Audio on channel 2.
Setup QM 1	Displays the QM 1 SETUP menu. By default the QM 1 SETUP menu displays video controls: Peak, Boost, Skew Red, Skew Green and Skew Blue in the lower right quadrant of the menu.
Video	Pressing this before pressing the Setup QM 1 button will open the QM 1 SETUP menu in <i>Video</i> mode.
S-Video	Pressing this before pressing the Setup QM 1 button will open the QM 1 SETUP menu in <i>S-Video</i> mode.
Component	Pressing this before pressing the Setup QM 1 button will open the QM 1 SETUP menu in <i>Component</i> mode.
RGB	Pressing this before pressing the Setup QM 1 button will open the QM 1 SETUP menu in <i>RGB</i> mode.

(Continued on following page)

QM Setup Details (Continued)

QM SETUP SCREEN CONTROL	DESCRIPTION
Setup QM 2	Displays the QM 2 SETUP menu. By default the QM 2 SETUP menu displays video controls Peak and Boost in the lower right quadrant of the menu.
Video	Pressing this before pressing the Setup QM 2 button will open the QM 2 SETUP menu in <i>Video</i> mode.
S-Video	Pressing this before pressing the Setup QM 2 button will open the QM 2 SETUP menu in <i>S-Video</i> mode.
Component	Pressing this before pressing the Setup QM 2 button will open the QM 2 SETUP menu in <i>Component</i> mode.
RGB	Pressing this before pressing the Setup QM 2 button will open the QM 2 SETUP menu in <i>RGB</i> mode.

To open the QM 1 SETUP menu, touch **Setup QM 1** on the QM SETUP menu. The QM 1 SETUP menu offers controls for *Peak*, *Boost*, *Skew Red*, *Skew Green* and *Skew Blue* in *Video*, *S-Video*, *Component* and *RGB* modes.

After QM 1 parameters have been set, touch **Return** to go back to the QM SETUP menu.

QM 1 SETUP

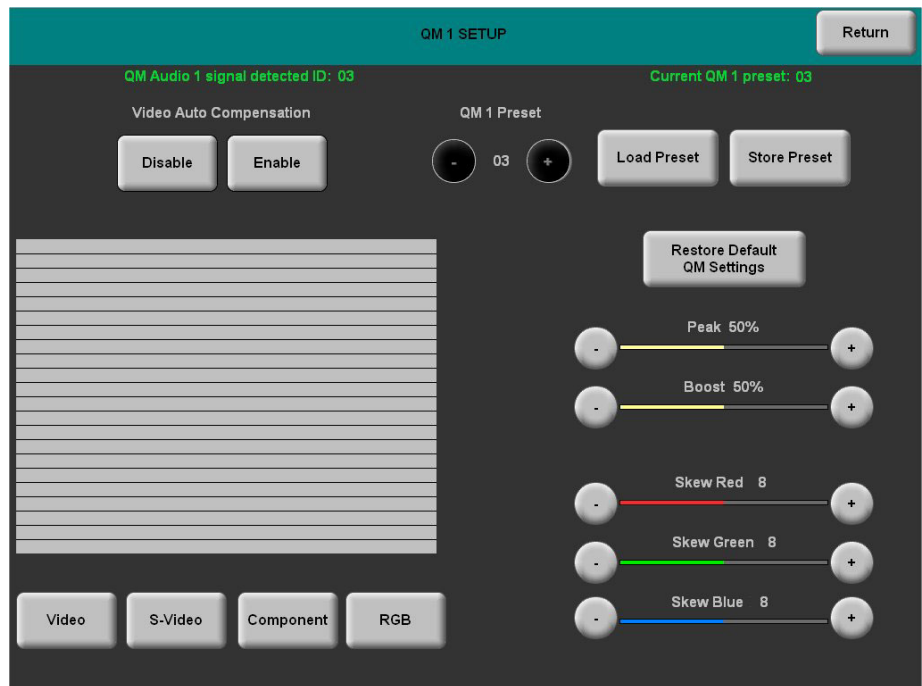

NOTE: The QM 1 SETUP menu and the QM 2 SETUP menu are identical except that QM input #2 does not have adjustments for skew compensation.

Refer to the following table for additional QM 1 SETUP menu details.

QM 1 Setup Details

QM 1 SETUP SCREEN CONTROL	DESCRIPTION
Auto Compensation* Disable	Turns off auto compensation.
Auto Compensation* Enable	Turns on auto compensation. When auto compensation is on, the QM receiving device uses the auto compensation data received from the QM transmitter.
Video	Puts the menu in <i>Video</i> mode so that you can adjust the Peak, Boost, Skew Red, Skew Green and Skew Blue signals for video.
S-Video	Puts the menu in <i>S-Video</i> mode so that you can adjust the Peak, Boost, Skew Red, Skew Green and Skew Blue signals for S-video.
Component	Puts the menu in <i>Component</i> mode so that you can adjust the Peak, Boost, Skew Red, Skew Green and Skew Blue signals for component video.
RGB	Puts the menu in <i>RGB</i> mode so that you can adjust the Peak, Boost, Skew Red, Skew Green and Skew Blue signals for RGB video.
QM 1 Preset	Displays the current QM 1 Preset number. Saved presets can also be called up using this control. The - and + buttons decrement and increment the displayed value.
Load Preset	Will load the selected QM 1 Preset.
Store Preset	Will store any changes you have made to the QM 1 setup at the displayed preset number.
Restore Default QM Settings	Returns the QM settings to their factory defaults.
Peak	Peak adjusts for high frequency attenuation that can occur over long cable lengths.
Boost	Boost compensates for overall signal loss that can occur over long cable lengths.
Skew Red	Adjusts the timing position of the red signal on the skew test pattern to compensate for any losses caused by long cable runs.
Skew Green	Adjusts the timing position of the green signal on the skew test pattern to compensate for any losses caused by long cable runs.
Skew Blue	Adjusts the timing position of the blue signal on the skew test pattern to compensate for any losses caused by long cable runs.

* Up to 255 preset locations are available to store settings for peak, boost and skew. In QM systems using auto compensation, the touchpanel can be set to automatically recall preset values upon receipt of a QM ID by selecting Video Auto Compensation **Enable**.

Video Setup

These touchpanels can display two fully scalable and movable, full motion video windows, each supporting standard video, HDTV and high-resolution RGB signals from external AV and computer sources. These units use auto-detect for composite, S-video or component RGBHV. They support SDTV (NTSC and PAL), EDTV, HDTV and RGB (VGA) up to UXGA (1600 x 1200). Two video inputs provide for connectivity to QuickMedia. You can perform Auto Detect by touching **QM Audio 1** or **QM Audio 2** or manually choose **Video**, **S-Video**, **Component** or **RGB** as an input source. Black and white can also be enabled for either video channel.

A table describing the video menu controls follows the illustrations. Touching **Video** on the SETUP MENU will open the screen shown below. From here you can enter the setup screens for both Video 1 and Video 2 by touching their respective buttons.

VIDEO SETUP

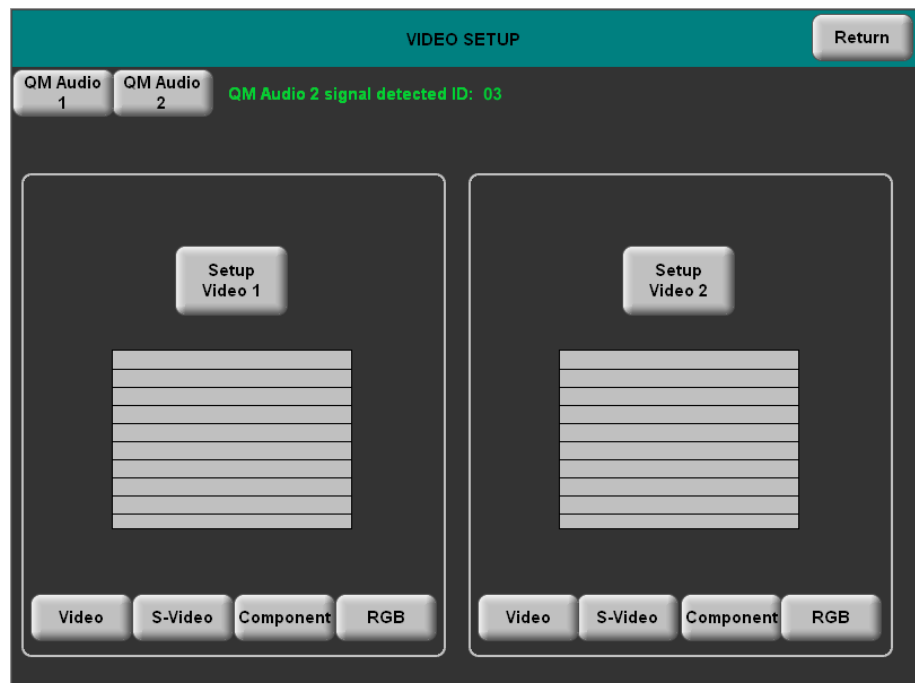

Refer to the following table for additional VIDEO SETUP menu details.

Video Setup Details

VIDEO SETUP SCREEN CONTROL	DESCRIPTION
QM Audio 1	Detects the presence of QM Audio on channel 1.
QM Audio 2	Detects the presence of QM Audio on channel 2.
Setup Video 1	Displays the VIDEO 1 SETUP menu. By default, the VIDEO 1 SETUP menu displays video controls: Brightness, Contrast, Saturation and Hue on the right side of the menu.
Video	Pressing this before pressing the Setup Video 1 button will open the VIDEO 1 SETUP menu in <i>Video</i> mode.

(Continued on following page)

Video Setup Details (Continued)

VIDEO SETUP SCREEN CONTROL	DESCRIPTION
Setup Video 1 (Continued)	
S-Video	Pressing this before pressing the Setup Video 1 button will open the VIDEO 1 SETUP menu in <i>S-Video</i> mode.
Component	Pressing this before pressing the Setup Video 1 button will open the VIDEO 1 SETUP menu in <i>Component</i> mode.
RGB	Pressing this before pressing the Setup Video 1 button will open the VIDEO 1 SETUP menu in <i>RGB</i> mode.
Setup Video 2	Displays the VIDEO 2 SETUP menu. By default, the VIDEO 2 SETUP menu displays video controls: Brightness, Contrast, Saturation and Hue on the right side of the menu.
Video	Pressing this before pressing the Setup Video 2 button will open the VIDEO 2 SETUP menu in <i>Video</i> mode.
S-Video	Pressing this before pressing the Setup Video 2 button will open the VIDEO 2 SETUP menu in <i>S-Video</i> mode.
Component	Pressing this before pressing the Setup Video 2 button will open the VIDEO 2 SETUP menu in <i>Component</i> mode.
RGB	Pressing this before pressing the Setup Video 2 button will open the VIDEO 2 SETUP menu in <i>RGB</i> mode.

The following screen is displayed when **Video**, **S-Video** or **Component** are selected.

VIDEO 1 SETUP (Video, S-Video and Component)



The video menu for RGB controls consists of size and position (shown) and color controls for Brightness, Contrast, Saturation and Hue when **RGB Color** is touched.

VIDEO 1 SETUP (RGB Size & Position shown)

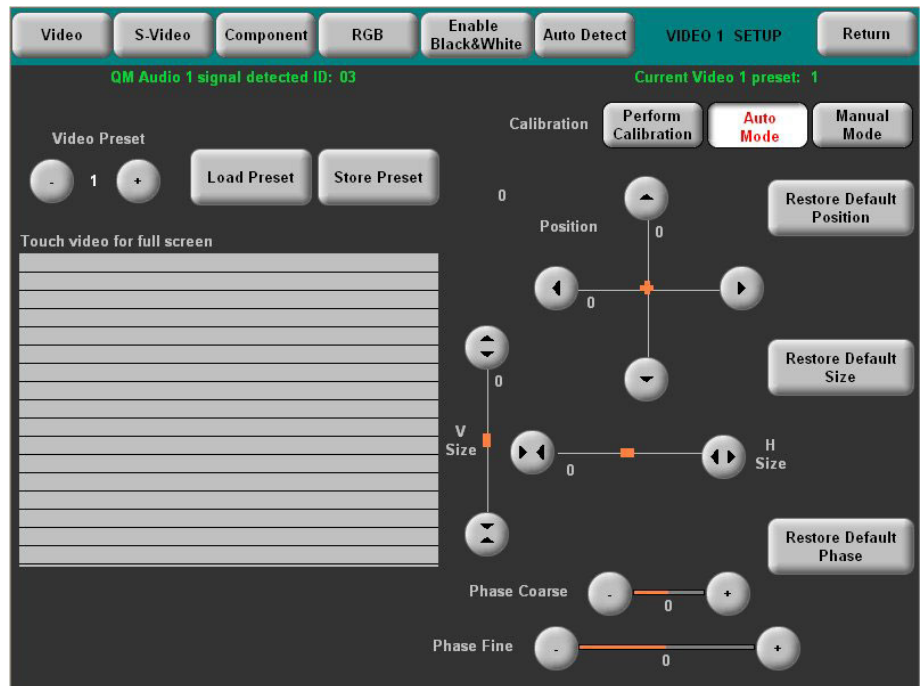

Refer to the following table for additional VIDEO 1 SETUP details.

Video 1 Setup Details – Video, S-Video, Component and RGB

VIDEO 1 SETUP SCREEN CONTROLS	DESCRIPTION
QM Signal	Indicates the presence of a QM signal.
Video Preset	Displays the current Video Preset number. Saved presets can also be called up using this control. The – and + buttons decrement and increment the displayed value.
Load Preset	Will load the selected Video Preset.
Store Preset	Will store any changes you have made to the video setup at the displayed preset number.
Restore Default Color Settings	Returns the video settings to their factory defaults.
Color Control	When Video, S-Video or Component is selected as the video type, these controls are available. The Restore Default Color Settings button places the controls at their midpoint.
Brightness ^{1,2}	Adjusts video image brightness with the – and + buttons.
Contrast ^{1,2}	Adjusts video image contrast with the – and + buttons.
Saturation ³	Adjusts video image saturation with the – and + buttons.
Hue ³	Adjusts video image hue with the – and + buttons.
Red ^{1,2}	Adjusts the amount of red in the video signal. Available when the RGB Color button is selected.
Green ^{1,2}	Adjusts the amount of green in the video signal. Available when the RGB Color button is selected.

(Continued on following page)

Video 1 Setup Details – Video, S-Video, Component and RGB (Continued)

VIDEO 1 SETUP SCREEN CONTROLS	DESCRIPTION
Color Control (Continued) Blue ^{1,2}	Adjusts the amount of blue in the video signal. Available when the RGB Color button is selected.
Overscan ³ None ³ Normal ³ Max ³	These controls adjust the amount of video information at the edges of the image. This part of the video picture is usually beyond the display capabilities of the screen. Sets the video screen so there is no overscan. The amount of used screen area is smallest in this configuration. Sets the video screen for normal overscan. This results in more area of the screen being used. This sets the video screen area to the maximum. The screen area is largest in this configuration. All video information at the edges is visible.
Size and Position Calibration Position Restore Default Position Size Restore Default Size Phase Restore Default Phase	When RGB is selected as the video source, these controls are available when the RGB Size and Position button has been pressed. Calibrates the incoming RGB signal for optimal position, size and phase when Perform Calibration button is pressed. In Auto Mode , the panel will attempt to find a matching preset based on the RGB signal's characteristics. If it cannot find one, it automatically performs a calibration. In Manual Mode , the panel will not attempt to find a matching preset nor will it automatically perform a calibration. In either mode, you can always adjust the settings (<i>Position, Size, Phase Coarse, Phase Fine</i>) manually. Settings are not saved to a preset unless the user presses the Store Preset button. This control allows you to set the position of the video screen on the touchpanel. The arrow buttons move the screen along the X and Y axis. Returns the video screen to its original position on the touchpanel. Allows you to set the size of the video screen in both the vertical and horizontal directions. Returns the video screen to its original size on the touchpanel. These controls adjust the phase of the RGB signal. Controls are shown for both coarse and fine adjustments. Returns the video signal to its original default phase.

1. Video default is zero (0) for each of the video parameters (brightness, contrast, red, green and blue).
2. Adjustment applies to the currently selected video source only.
3. These controls are available only in *Video, S-Video* and *Component* modes. In *RGB* mode they are analogous to the *Position, V Size* and *H Size* controls.

Diagnostics Menu

Touch **Diagnostics** on the MAIN MENU to access the DIAGNOSTICS MENU, which contains controls for diagnostic tools. The diagnostic tools should only be used under supervision from a Crestron customer service representative during telephone support. The options available from the DIAGNOSTICS MENU are numeric in nature and their interpretation is beyond the scope of this manual.

DIAGNOSTICS MENU

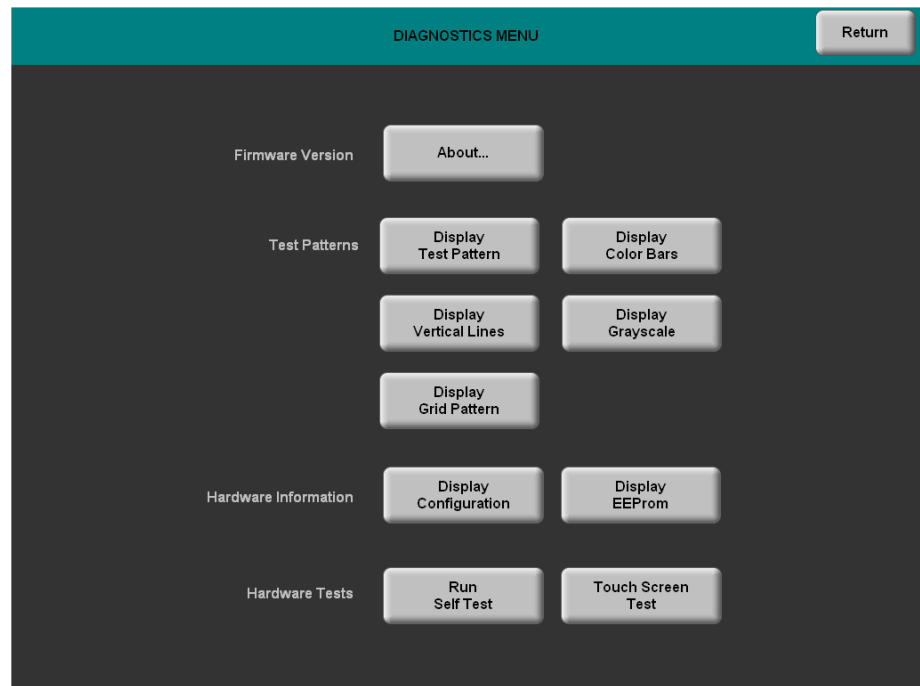

Hardware Hookup

Ventilation

The TPS-12G/15G/17G-QM should be used in a well-ventilated area. The venting holes should not be obstructed under any circumstances.

To prevent overheating, do not operate this product in an area that exceeds the environmental temperature range listed in the table of specifications. Consider using forced air ventilation to reduce overheating.

Connect the Device

Make the necessary connections as called out in the illustration on the following page. Refer to "Network Wiring" on page 20 before attaching the 4-position terminal block connector. Apply power after all connections have been made.

When making connections to the TPS-12G/15G/17G-QM, consider the following:

- Use Crestron power supplies for Crestron equipment.
- The included cable cannot be extended.

Hardware Connections for the TPS-12G/15G/17G-QM

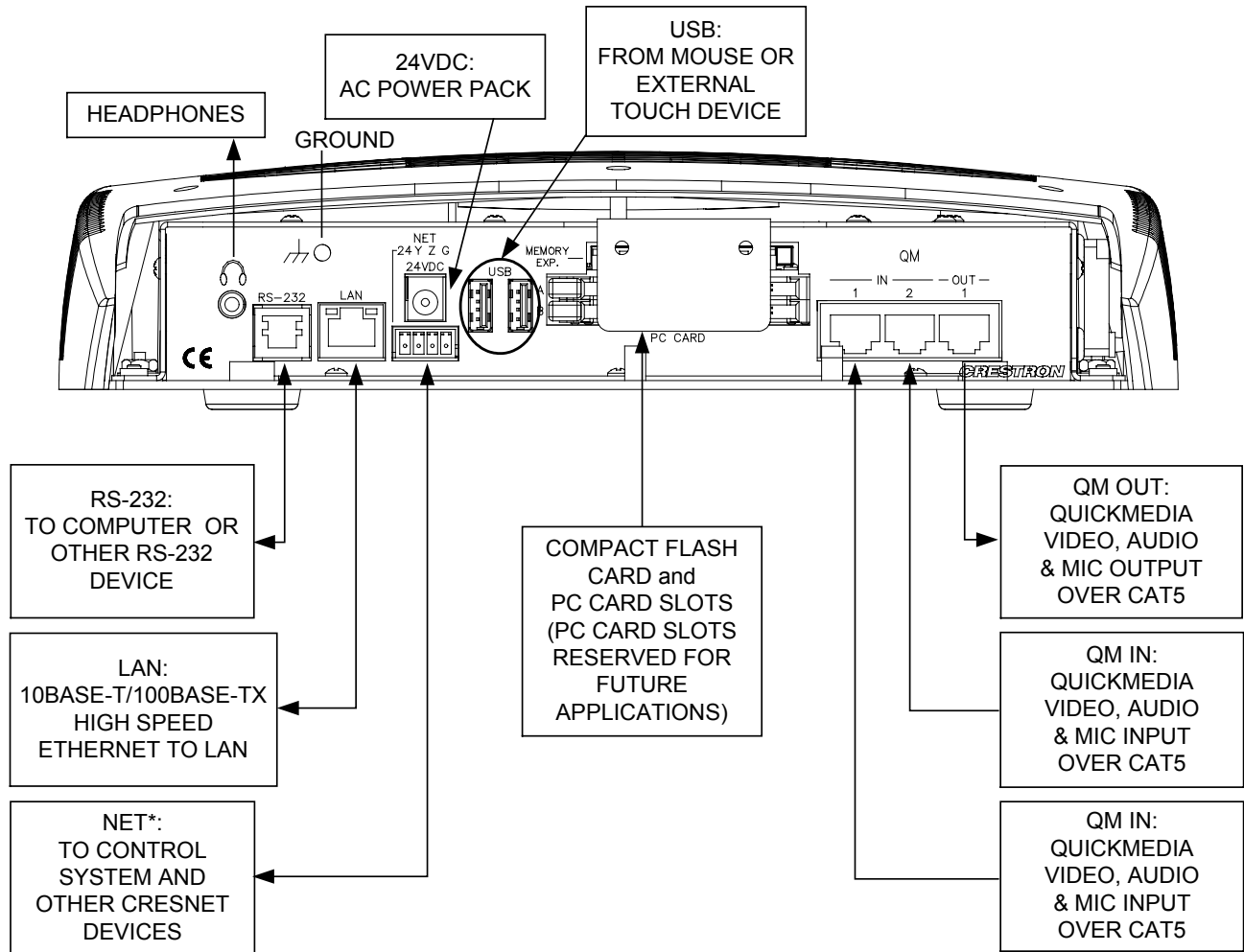

* For the TPS-17G-QM only, an interface module (TPS-17G-QM/-L-IMC) is included. Refer to the latest revision of the TPS-17G-QM/-L-IMC Power Interface Module guide (Doc. 6783) for details.

CAUTION: Do not connect the TPS-17G-QM directly to the Cresnet network bus.

NOTE: Ensure the unit is properly grounded.

CAUTION: Do not apply excessive pressure to the touchscreen display during handling. Doing so can crack the screen and damage the touchpanel.

NOTE: The maximum continuous current from equipment under any external load conditions shall not exceed a current limit that is suitable for the minimum wire gauge used in interconnecting cables. The ratings on the connecting unit's supply input should be considered to prevent overloading the wiring.

NOTE: The headphone output includes WAV data, QM and Mic Input.

NOTE: Audio, video and QuickMedia connections must use Crestron Certified Wire (CresCAT-QM, CresCAT-IM) to ensure optimum performance.

NOTE: Crestron recommends an independent power supply for the touchpanel.

QM-TX QuickMedia Transmitter

The QM-TX QuickMedia Transmitter can be used to connect a video or audio source to a QuickMedia network without a locally available QM transmitter (such as the QM-WMC).

The QM-TX accepts composite video, S-video, component video, RGBHV and audio signals. These signals are encoded and converted to the QuickMedia standard and fed over a CAT5E or CAT6 cable to a QM receiver (such as the TPS-12G/15G/17G-QM). All signal routing occurs automatically under the command of the control system.

For more information, refer to the latest version of the QM-TX Operations Guide (Doc. 6334).

Cable Management

The TPS-12G/15G/17G-QM uses a built-in strain relief to prevent the accidental disconnection of vital cables and provides strain-relief for connectors on the cables and the touchpanel. Refer to the following illustration to use the built-in strain relief mechanism to secure cables to the touchpanel.

TPS-12G/15G/17G-QM Cable Management

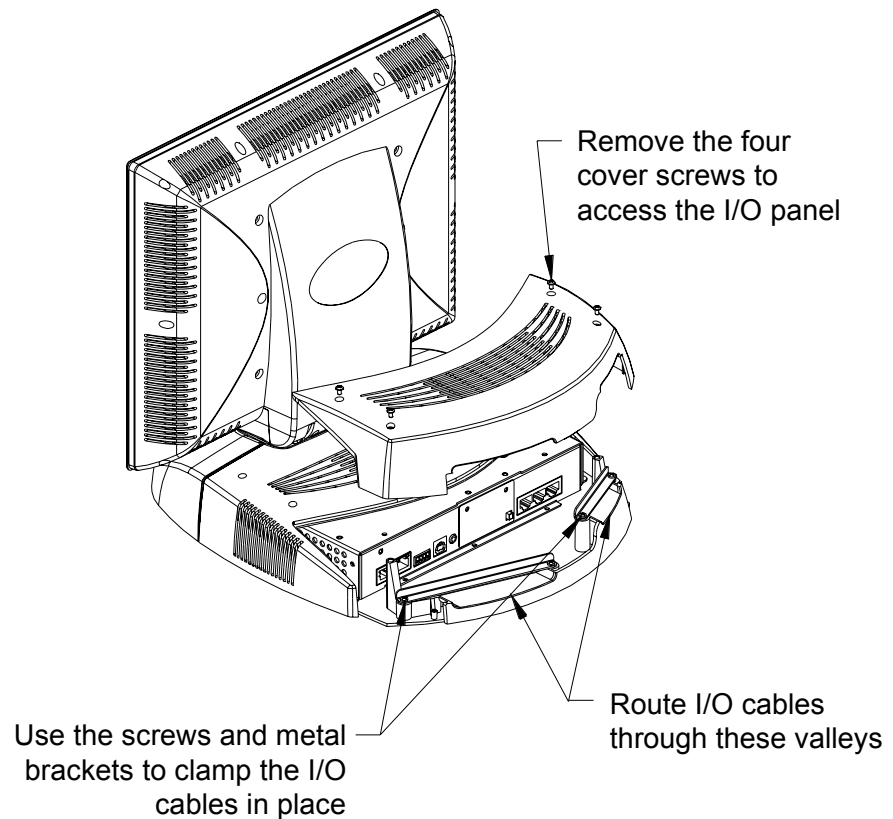

Tilt Angle Tension Adjustment

Use a 5/32 inch socket (not included) with a hex drive key (Allen wrench) to increase or decrease pivot tension at the base of the touchscreen. Turning the key clockwise increases tension, counterclockwise decreases tension.

Tension Adjustment Screw

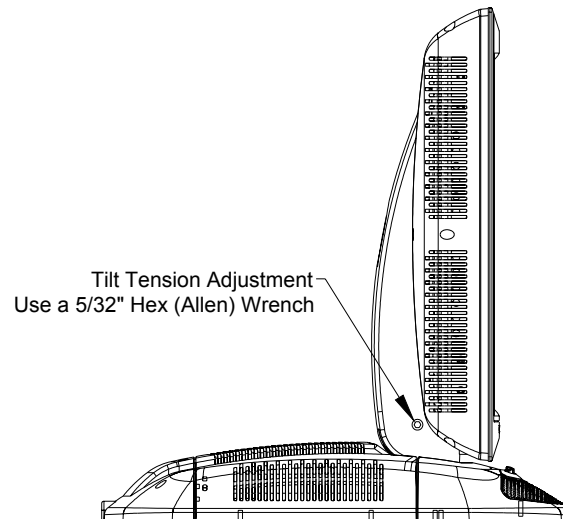

Recommended Cleaning

Keep the surface of the touchscreen free of dirt, dust or other materials that could degrade optical properties. Long-term contact with abrasive materials can scratch the surface, which may detrimentally affect image quality.

For best cleaning results use a clean, damp, non-abrasive cloth with any commercially available non-ammonia glass cleaner. Bezels may not provide a complete watertight seal. Therefore, apply cleaning solution to the cloth rather than the surface of the touchscreen. Wipe touchscreen clean and avoid getting moisture beneath the bezels.

Programming Software

Have a question or comment about Crestron software?

Answers to frequently asked questions (FAQs) can be viewed in the Online Help section of the Crestron website. To post a question or view questions you have submitted to Crestron's True Blue Support, log in at <http://support.crestron.com>. First-time users will need to establish a user account.

Earliest Version Software Requirements for the PC

NOTE: Crestron recommends that you use the latest software to take advantage of the most recently released features. The latest software is available from the Crestron website.

Crestron has developed an assortment of Windows®-based software tools to develop a Cresnet system. For the minimum recommended software versions, visit the Version Tracker page of the Crestron website (www.crestron.com/versiontracker).

Programming with Crestron SystemBuilder

Crestron SystemBuilder is the easiest method of programming but does not offer as much flexibility as SIMPL Windows. For additional details, download SystemBuilder from the Crestron website and examine the extensive help file.

Programming with SIMPL Windows

NOTE: While SIMPL Windows can be used to program the TPS-12G/15G/17G-QM, it is recommended to use SystemBuilder for configuring a QuickMedia system.

SIMPL Windows is Crestron's premier software for programming Crestron control systems. It is organized into two separate but equally important "Managers".

Configuration Manager

Configuration Manager is the view where programmers "build" a Crestron control system by selecting hardware from the *Device Library*.

- To incorporate the TPS-12G/15G/17G-QM (Cresnet) into the system, drag the TPS-12G/15G/17G-QM from the Touchpanels | Touchpanels (Cresnet) folder of the *Device Library* and drop it in the *System Views*.

Locating the TPS-12G/15G/17G-QM(Cresnet) in the Device Library

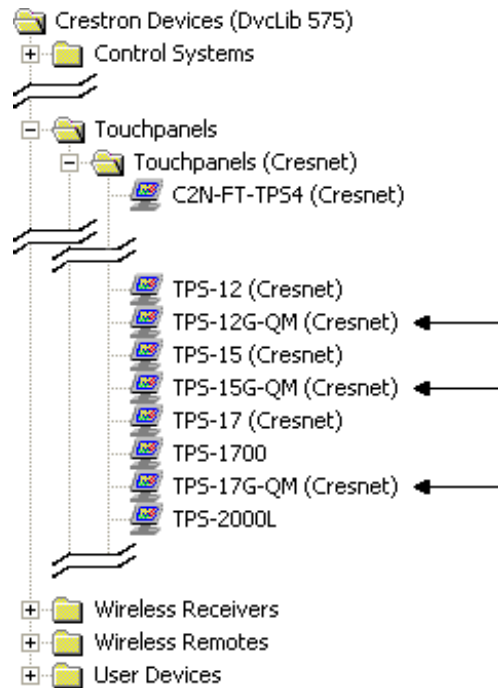

- To incorporate the TPS-12G/15G/17G-QM (Ethernet) into the system, drag the TPS-12G/15G/17G-QM from the Touchpanels | Touchpanels (Ethernet) folder of the *Device Library* and drop it in the *System Views*.

Locating the TPS-12G/15G/17G-QM(Ethernet) in the Device Library

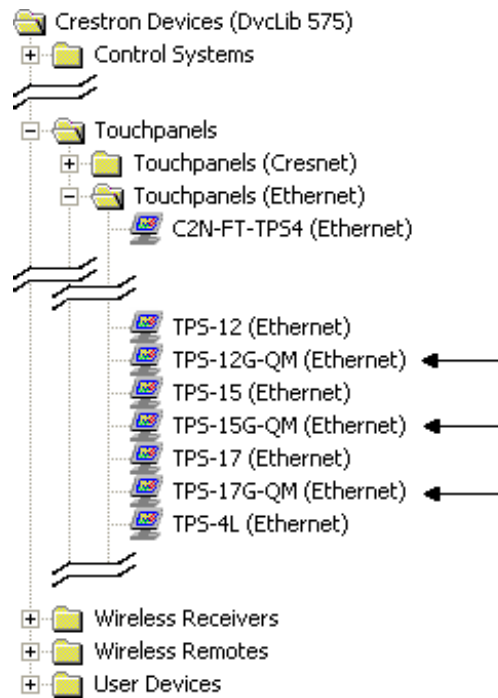

- The system tree of the control system displays the device in the appropriate slot with a default Net ID or IP ID as shown in the following illustration.

NOTE: There is both an Ethernet device in Slot 8 and a Cresnet device in Slot 9 of the following illustration. It is possible to have both types of device attached to a control system so long as the control system has either a built-in or expansion Ethernet interface.

C2Net Device, Slot 8 and 9

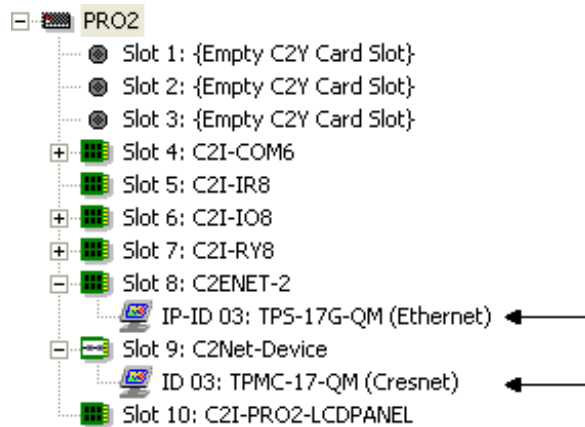

- Additional TPS-12G/15G/17G-QM devices are assigned different Net ID (for Cresnet devices) or IP ID (for Ethernet devices) numbers as they are added.
- If necessary, double click a device to open the “Device Settings” window and change the Net ID or IP ID), as shown in the following figure.

*“TPS-17G-QM (Cresnet) Device Settings” Window
(Same as window for TPS-12G-QM and TPS-15G-QM)*

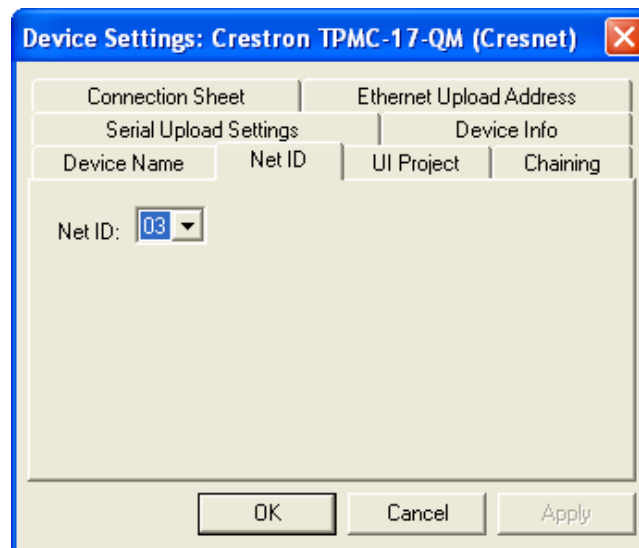

*“TPS-17G-QM (Ethernet) Device Settings” Window
(Same as window for TPS-12G-QM and TPS-15G-QM)*

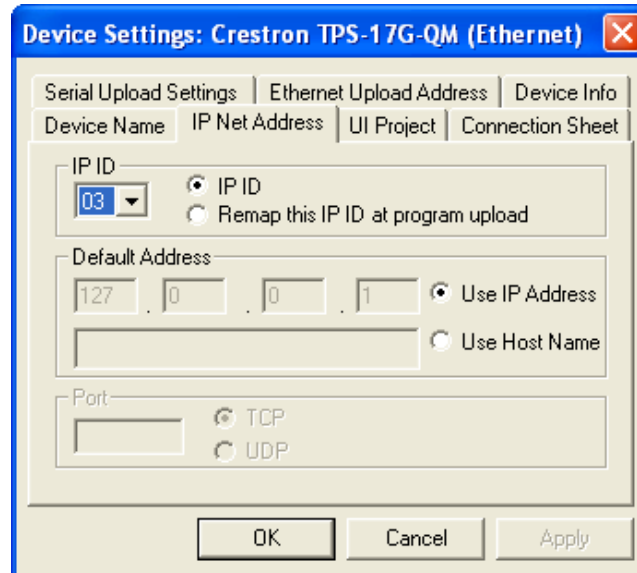

- The ID code specified in the SIMPL Windows program must match the Net ID or IP ID of each unit.

Program Manager

Program Manager is the view where programmers “program” a Crestron control system by assigning signals to symbols. The symbol can be viewed by double clicking on the icon or dragging it into *Detail View*. Each signal in the symbol is described in the SIMPL Windows help file (F1).

Programming with VisionTools Pro-e

Touchpanel screens should be created in VisionTools® Pro-e (VT Pro-e) to allow switching of source signals to desired outputs as well as selection of the system mode. There are no special programming requirements to use the functions of the TPS-12G/15G/17G-QM in a room-control system.

Multi-Mode Objects

Multi-mode objects offer high-performance programming!

The single most-advanced VisionTools Pro-e high-performance programming technique involving the TPS-12G/15G/17G-QM is the concept of multi-mode objects. A multi-mode object (i.e. button, legend, etc.) is an object drawn on a VT Pro-e page that can have one or more active and inactive visible settings (*modes*).

For examples, refer to www.crestron.com/exampleprograms and search for multi-mode object examples. This file contains the VT Pro-e touchpanel files and SIMPL Windows files that illustrate the high-performance capabilities of multi-mode objects.

WAV File Audio Messages

The TPS-12G/15G/17G-QM touchpanels are capable of playing audio messages as system prompts and responses. These files are recorded as WAV files on a PC using an audio utility such as Sound Recorder that is packaged with Microsoft Windows 95/98/Me/XP/NT/ 2000/Vista™. Files from other sources may also be converted to an acceptable format by using this or a similar utility. Many other audio utilities are available commercially or as shareware. The TPS-12G/15G/17G-QM touchpanels

only accept the following WAV file format: **PCM, 8-bit, 8 kHz, mono**. For more information about how to use Sound Recorder, refer to its User's Guide and extensive help information provided with the software. Also refer to the help file in VT Pro-e to learn how to use its audio tool, Sound Manager, to attach WAV files to a touchpanel project.

Pre-recorded WAV files for voice prompts and responses are available from Crestron. These files can be stored into and programmed for use in the touchpanel directly or may be edited with the Sound Recorder. For example, the individual files can be combined to create custom messages.

NOTE: Touchpanel WAV files can be obtained from the Wave LC Library of the Crestron FTP site.

Bit Depth and File Size

A balance of performance and quality can be achieved by using VT Pro-e to configure the size of graphics in a project. Read this section to learn about bit depth and how to maximize the quality and performance of a TPS-12G/15G/17G-QM project.

Bit depth refers to the number of memory bits used to store color data for each pixel in a raster image. A touchpanel raster image consists of a rectangular grid of picture elements (pixels). Each pixel uses the same amount of memory to store its color data. The amount of memory is called the bit depth of the image.

Greater bit depths are required to represent finer gradations of color. Increasing bit depth necessarily increases file size. A black and white drawing requires only one bit per pixel to store all the available color information. Using a 32-bit per pixel bit depth for a black and white image increases the file size 32 times without adding anything to the black and white image quality.

In an 8-bit per pixel system, the associated 8-bits of video memory for every screen pixel contain a value referring to a location in an 8-bit color table. In this way any one of the specific 256 color table locations is assigned to a pixel.

A 16-bit highcolor system is considered sufficient to provide life-like colors. It is encoded using 5-bits to represent red, 5-bits to represent blue and (since the human eye is more sensitive to the color green) 6-bits to represent 64 levels of green. These can therefore be combined to provide 65,536 mixed colors ($32 \times 32 \times 64 = 65,536$).

In a 24-bit graphics display, the video memory allocates 24 bits for each pixel on the screen enabling each pixel to take on any one of a possible 16.7 million colors. Each 24-bit value is composed of 8-bits for red, 8-bits for green and 8-bits for blue. These triplets of 8-bit values are also referred to as the red, green and blue color planes. A 24-bit image is actually composed of three component images which combine to create the truecolor picture. The reason this is called truecolor is that this is near the maximum number of colors the human eye is able to detect.

Truecolor images are sometimes represented by a 32-bit value. The extra 8-bits do not enhance the precision of the color representation but act as an alpha channel that represents pixel translucence. The 32-bit truecolor has become popular on the computer desktop to provide effects such as translucent windows, fading menus and shadows.

In graphics intensive applications such as touchpanels, raising or lowering the color depth of the displayed graphics can achieve a balance of performance and quality. Lower color depths do not require as much frame buffer memory or display bandwidth, allowing them to be generated and displayed more quickly. Increasing color depth results in higher color quality at the expense of display speed and responsiveness. By using mostly 8-bit or 16-bit graphics and holding the

32-bit graphics to a minimum (e.g. for a family photo, etc.), you can create a sophisticated project that will fit in the memory space provided and have the touchpanel remain very responsive.

Relationship of Bits to Colors

NUMBER OF BITS	NUMBER OF COLORS
1 bit	Black and White
2 bits	4 Colors
4 bits	16 Colors
8 bits	256 Colors
16 bits	65,536 Colors (Highcolor)
24 bits	16.7 million Colors (Truecolor)
32 bits	16.7 million Colors plus Transparency

When creating a VisionTools Pro-e project you can elect to compress and reduce the image size in the “Page Properties” window for the entire page and/or perform the same function of reducing the image size using the “Image Properties” window. A reduction in image size will save a considerable amount of memory space for your project.

In VisionTools Pro-e, the **Compress** checkbox permits the image to be compressed when compiling. The **16 Bits** checkbox converts a 24-bit or 32-bit image to 16 bits. This conversion to a 16-bit image may cause the loss of some subtle shading. To compensate for this, use the dithering to simulate the original shading. Check your image with each of the available dithering types to determine which will deliver the best quality image.

Dithering type selection can be accessed from the “Page Properties” or “Image Properties” windows in VT-Pro-e. Refer to the following illustrations.

VT Pro-e “Page Properties” Window – Bit Depth Selection

VT Pro-e “Image Properties” Window – Bit Depth Selection

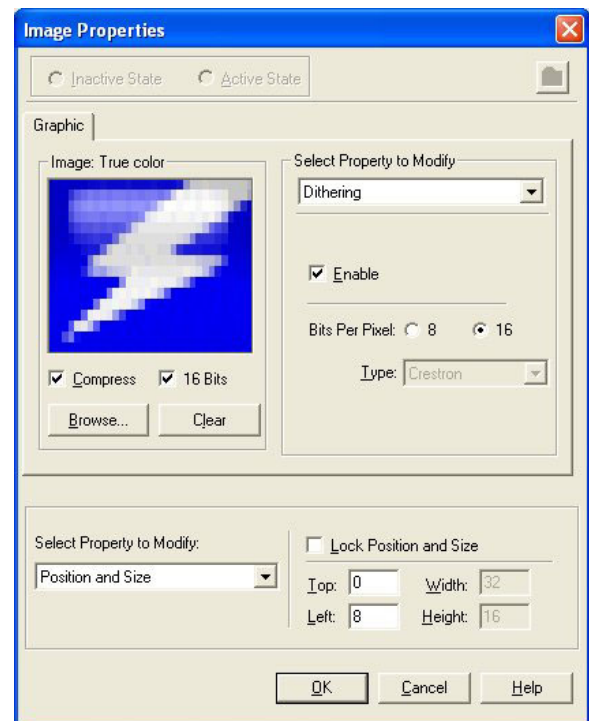
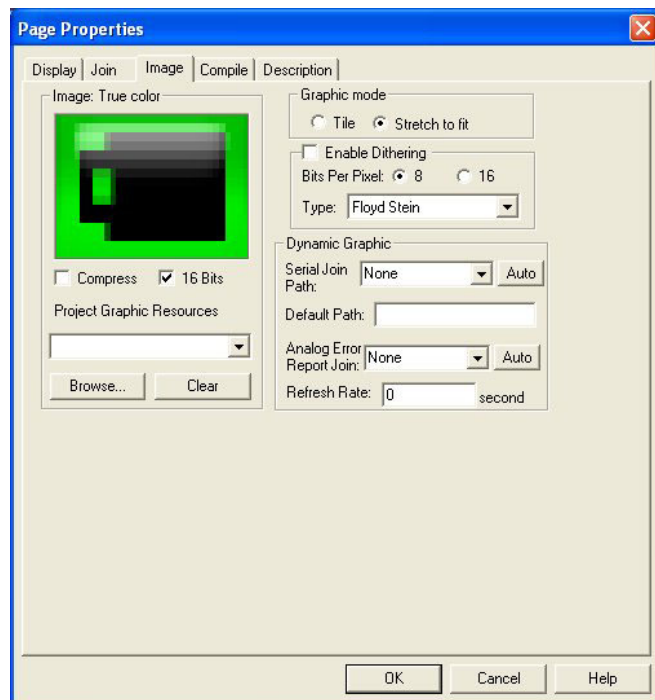

Pushbutton Programming

Four of the buttons can be programmed to access any frequently used command. Each button has a permanently fixed digital join number. The sequence of digital join numbers is (left to right) 1 through 4. Refer to the following illustration for their assigned join numbers. A description for each button signal is described in the SIMPL Windows help file (F1).

Pushbutton Layout and Join Number Assignment

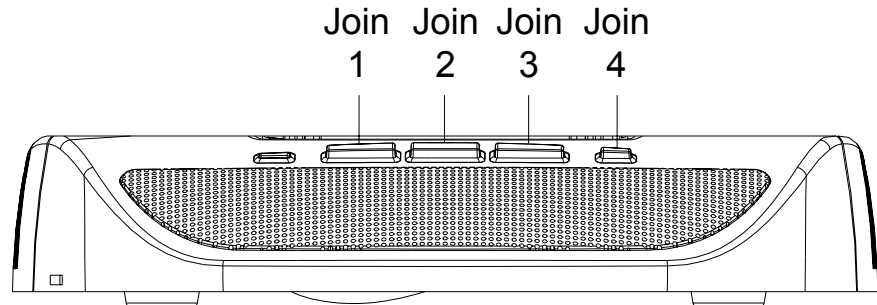

MultiByte International Characters

Most languages use a single byte of eight bits to represent a character, e.g. English, French, German, Hebrew, Russian, Thai, etc.

Multibyte character fonts require more than the usual eight bits to specify a character. This occurs when a language has more than 256 characters (2^8) in a font. For example, Chinese fonts contain several thousand characters. Other multibyte languages include Japanese and Korean.

There are two separate applications with multibyte characters – static text on buttons and indirect text on buttons. No Isys touchpanel firmware changes are required in either case.

Indirect text on a button is entered in VT Pro-e and the actual string to be displayed is entered in SIMPL Windows. As of this publication date only completely single byte or completely multibyte strings may be entered or they will not be compiled correctly in SIMPL Windows. In other words, you cannot enter Chinese characters interspersed with numbers. You can enter Chinese characters or numbers in separate strings or you can pad each number with “\x00” to make it multibyte and then combine it with Chinese characters in the same string.

Of course you can always use the workaround of showing a graphic that displays the string but it is not dynamic. To compile and use multibyte characters it is essential that the operating system understand the language. Windows XP and Vista are available in many international languages and add-on software is available for other versions of Windows.

Example Program

An example program for the TPS-12G/15G/17G-QM is available from the Crestron website (www.crestron.com/exampleprograms).

Uploading and Upgrading

Crestron recommends using the latest programming software and that each device contains the latest firmware to take advantage of the most recently released features. However, before attempting to upload or upgrade it is necessary to establish communication. Once communication has been established, files (for example, programs, projects or firmware) can be transferred to the control system (and/or device). Finally, program checks can be performed (such as changing the device ID or creating an IP table) to ensure proper functioning.

Establishing Communication

Use Crestron Toolbox for communicating with the TPS-12G/15G/17G-QM; refer to the Crestron Toolbox help file for details. There are three methods of communication.

Direct Serial

NOTE: Required for initial setup of Ethernet parameters.

Direct Serial Communication

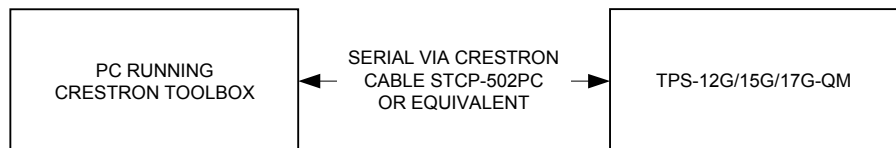

- The **RS-232** port on the TPS-12G/15G/17G-QM connects to the serial port on the PC via a serial cable (Crestron STCP-502PC or equivalent).
- Use the Address Book in Crestron Toolbox to create an entry using the expected serial communication protocol (RS-232, auto-detect baud rate, no parity, 8 data bits, 1 stop bit, XON/XOFF disabled, RTS/CTS disabled).
- Display the TPS-12G/15G/17G-QM's "System Info" window (click the  icon); communications are confirmed when the device information is displayed.

Indirect

Indirect Communication

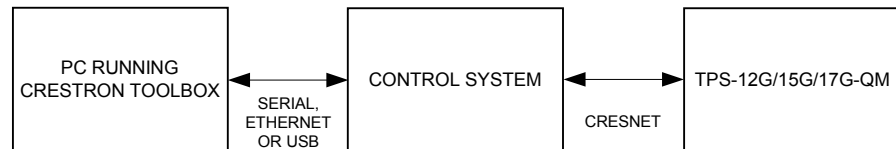

- TPS-12G/15G/17G-QM connects to control system via Cresnet.
- Establish communications between the PC and the control system as described in the latest version of the 2-Series Control Systems Reference Guide (Doc. 6256).
- Use the Address Book in Crestron Toolbox to create an entry for the TPS-12G/15G/17G-QM using the expected communication protocol (Indirect). Select the Cresnet ID of the TPS-12G/15G/17G-QM and the

address book entry of the control system that is connected to the TPS-12G/15G/17G-QM.

- Display the TPS-12G/15G/17G-QM's "System Info" window (click the  icon); communications are confirmed when the device information is displayed.

TCP/IP

NOTE: Required for operation with a Crestron control system.

Ethernet Communication



- Establish serial communication between TPS-12G/15G/17G-QM and PC.
- Enter the IP address, IP mask and default router of the TPS-12G/15G/17G-QM via the Crestron Toolbox (**Functions | Ethernet Addressing**); otherwise enable DHCP.
- Confirm Ethernet connections between TPS-12G/15G/17G-QM and PC. If connecting through a hub or router, use CAT5 straight through cables with 8-pin RJ-45 connectors. Alternatively, use a CAT5 crossover cable to connect the two LAN ports directly without using a hub or router.
- Use the Address Book in the Crestron Toolbox to create an entry for the TPS-12G/15G/17G-QM with the TPS-12G/15G/17G-QM's TCP/IP communication parameters.
- Display the "System Info" window (click the  icon) and select the TPS-12G/15G/17G-QM entry.

Programs, Projects and Firmware

Program, project or firmware files may be distributed from programmers to installers or from Crestron to dealers. Firmware upgrades are available from the Crestron website as new features are developed after product releases. One has the option to upload programs and projects via the programming software or to upload and upgrade via the Crestron Toolbox. For details on uploading and upgrading, refer to the SIMPL Windows help file, VT Pro-e help file or the Crestron Toolbox help file.

SIMPL Windows

If a SIMPL Windows program is provided, it can be uploaded to the control system using SIMPL Windows or Crestron Toolbox.

VisionTools Pro-e

Upload the VT Pro-e file to the touchpanel using VT Pro-e or Crestron Toolbox. If loading a project to a touchpanel that has an external compact flash slot, please use Crestron Toolbox.

Firmware

Check the Crestron website to find the latest firmware. (New users may be required to register to obtain access to certain areas of the site, including the FTP site.)

- Upgrade TPS-12G/15G/17G-QM firmware via Crestron Toolbox.
- Establish serial or TCP/IP communications with the TPS-12G/15G/17G-QM and display the "System Info" window.

- Select **Functions | Firmware...** to upgrade the TPS-12G/15G/17G-QM firmware.

Program Checks

Actions that can be performed on the TPS-12G/15G/17G-QM vary depending on whether it is connected via Cresnet or Ethernet.

Cresnet Connections

For Cresnet connections, display the network device tree (**Tools | Network Device Tree**) to show all network devices connected to the control system. Right-click on the TPS-12G/15G/17G-QM to display actions that can be performed on the TPS-12G/15G/17G-QM.

Ethernet Connections

For Ethernet connections, display the “System Info window (click the  icon) and select the **Functions** menu to display actions that can be performed on the TPS-12G/15G/17G-QM.

Be sure to use the Crestron Toolbox to create the TPS-12G/15G/17G-QM IP table.

- Select **Functions | IP Table Setup**.
- Add, modify or delete entries in the IP table. The TPS-12G/15G/17G-QM can have only one IP table entry.
- A defined IP table can be saved to a file or sent to the device.

Edit the control system’s IP table to include an entry for the TPS-12G/15G/17G-QM. The entry should list the TPS-12G/15G/17G-QM’s IP ID (specified on the TPS-12G/15G/17G-QM’s IP table) and the internal gateway IP address 127.0.0.1.

Problem Solving

Troubleshooting

The following table provides corrective action for possible trouble situations. If further assistance is required, please contact a Crestron customer service representative.

TPS-12G/15G/17G-QM Troubleshooting

TROUBLE	POSSIBLE CAUSE(S)	CORRECTIVE ACTION
TPS-12G/15G/17G-QM does not function.	TPS-12G/15G/17G-QM is not receiving power.	Verify power to unit. Use only Crestron power supplies for Crestron equipment.
	Incorrect cable connections.	Follow connection procedures in this guide and inspect connector pins.
	Incorrect firmware/software.	Update firmware/software versions as per those listed in the "Specifications" section.
	Touchpanel is incorrectly calibrated.	Enter "SETUP MODE" and recalibrate.
	Touchpanel is not communicating with the network.	Use Toolbox to poll the network. Verify network connection to the touchpanel.
	Brightness is set too low.	Adjust touchpanel brightness. Refer to "Setup Menu" which starts on page 25.
Touchpanel is not responding.	Incorrect network wiring.	Touch the screen to remove the message and verify correct wiring to all connectors.
	Touchpanel Cresnet ID is not set to match the Net ID in the SIMPL program.	Use Crestron Toolbox to poll the network. Verify the Cresnet ID for the touchpanel is properly set to match the Net ID in the SIMPL program.
	Touchpanel Cresnet ID is not unique; two or more units share the same ID.	Use Crestron Toolbox to poll the network and verify that each ID is used only once.
	ICMP is disabled.	Enable ICMP by typing ICMP ON at the command prompt in the Toolbox Text Console.

(Continued on following page)

TPS-12G/15G/17G-QM Troubleshooting (Continued)

TROUBLE	POSSIBLE CAUSE(S)	CORRECTIVE ACTION
No video displayed.	Wrong VisionTools Pro-e or SIMPL Windows programs.	Verify correct programs. Verify proper video set up.
	Incorrect input connection.	Verify video input and QM connections.
TPS-12G/15G/17G-QM does not respond to ping command.	IP address not correct (LAN green and amber LEDs are off).	Assign correct IP address to TPS-12G/15G/17G-QM.
	IP mask not correct (LAN green and amber LEDs are on).	Assign correct IP mask.
	The PC and the TPS-12G/15G/17G-QM are not on same subnet.	Ensure that the PC and the TPS-12G/15G/17G-QM are on the same subnet.
Mouse or touchpanel does not work.	Incorrect Touch settings.	Check Touch settings on INTERFACE MENU.
Touchpanel does not communicate with RS-232 devices.	Incorrect RS-232 settings.	Match communication settings of touchpanel to peripheral device.
Touchpanel display is dark.	Standby timeout has elapsed.	Touch the screen to reactivate.
Unexpected response from the touchpanel.	Touchpanel is incorrectly calibrated.	Enter "SETUP MODE" and recalibrate.
Communications via the LAN port not functioning.	Improper Ethernet connection (IEC).	Verify proper connection at touchpanel LAN port.
	Another device set to the same IP address.	Obtain new touchpanel static IP address.

Check Network Wiring

Use the Right Wire

In order to ensure optimum performance over the full range of your installation topology, Crestron Certified Wire and only Crestron Certified Wire may be used. Failure to do so may incur additional charges if support is required to identify performance deficiencies because of using improper wire.

Calculate Power

CAUTION: Use only Crestron power supplies for Crestron equipment. Failure to do so could cause equipment damage or void the Crestron warranty.

CAUTION: Provide sufficient power to the system. Insufficient power can lead to unpredictable results or damage to the equipment. Please use the Crestron Power Calculator to help calculate how much power is needed for the system (www.crestron.com/calculators).

When calculating the length of wire for a particular Cresnet run, the wire gauge and the Cresnet power usage of each network unit to be connected must be taken into consideration. Use Crestron Certified Wire only. If Cresnet units are to be daisy-chained on the run, the Cresnet power usage of each network unit to be daisy-chained must be added together to determine the Cresnet power usage of the entire

chain. If the unit is home-run from a Crestron system power supply network port, the Cresnet power usage of that unit is the Cresnet power usage of the entire run. The wire gauge and the Cresnet power usage of the run should be used in the following equation to calculate the cable length value on the equation's left side.

Cable Length Equation

$$L < \frac{40,000}{R \times P}$$

Where: L = Length of run (or chain) in feet
 R = 6 Ohms (Crestron Certified Wire: 18 AWG (0.75 MM²))
 or 1.6 Ohms (Cresnet HP: 12 AWG (4 MM²))
 P = Cresnet power usage of entire run (or chain)

Make sure the cable length value is less than the value calculated on the right side of the equation. For example, a Cresnet run using 18 AWG Crestron Certified Wire and drawing 20 watts should not have a length of run more than 333 feet (101 meters). If Cresnet HP is used for the same run, its length could extend to 1250 feet (381 meters).

NOTE: All Crestron certified Cresnet wiring must consist of two twisted pairs. One twisted pair is the +24V conductor and the GND conductor and the other twisted pair is the Y conductor and the Z conductor.

Strip and Tin Wire

When daisy-chaining Cresnet units, strip the ends of the wires carefully to avoid nicking the conductors. Twist together the ends of the wires that share a pin on the network connector and tin the twisted connection. Apply solder only to the ends of the twisted wires. Avoid tinning too far up the wires or the end becomes brittle. Insert the tinned connection into the Cresnet connector and tighten the retaining screw. Repeat the procedure for the other three conductors.

Add Hubs

For larger networks (i.e., greater than 28 network devices), it may become necessary to add a Cresnet Hub/Repeater (CNXHUB) to maintain signal quality throughout the network. Also, for networks with lengthy cable runs it may be necessary to add a Hub/Repeater after only 20 devices.

Reference Documents

The latest version of all documents mentioned within the guide can be obtained from the Crestron website (www.crestron.com/manuals). This link will provide a list of product manuals arranged in alphabetical order by model number.

List of Related Reference Documents

DOCUMENT TITLE
2-Series Control Systems Reference Guide
Crestron e-Control Reference Guide
MediaManager Applications Guide
QM-TX QuickMedia Transmitter
TPS-17G-QM/-L-IMC Power Interface Module

Further Inquiries

If you cannot locate specific information or have questions after reviewing this guide, please take advantage of Crestron's award winning customer service team by calling Crestron at 1-888-CRESTRON [1-888-273-7876].

You can also log onto the online help section of the Crestron website (www.crestron.com/onlinehelp) to ask questions about Crestron products. First-time users will need to establish a user account to fully benefit from all available features.

Future Updates

As Crestron improves functions, adds new features and extends the capabilities of the TPS-12G/15G/17G-QM, additional information may be made available as manual updates. These updates are solely electronic and serve as intermediary supplements prior to the release of a complete technical documentation revision.

Check the Crestron website periodically for manual update availability and its relevance. Updates are identified as an “Addendum” in the Download column.

Software License Agreement

This License Agreement (“Agreement”) is a legal contract between you (either an individual or a single business entity) and Crestron Electronics, Inc. (“Crestron”) for software referenced in this guide, which includes computer software and as applicable, associated media, printed materials and “online” or electronic documentation (the “Software”).

BY INSTALLING, COPYING OR OTHERWISE USING THE SOFTWARE, YOU REPRESENT THAT YOU ARE AN AUTHORIZED DEALER OF CRESTRON PRODUCTS OR A CRESTRON AUTHORIZED INDEPENDENT PROGRAMMER AND YOU AGREE TO BE BOUND BY THE TERMS OF THIS AGREEMENT. IF YOU DO NOT AGREE TO THE TERMS OF THIS AGREEMENT, DO NOT INSTALL OR USE THE SOFTWARE.

IF YOU HAVE PAID A FEE FOR THIS LICENSE AND DO NOT ACCEPT THE TERMS OF THIS AGREEMENT, CRESTRON WILL REFUND THE FEE TO YOU PROVIDED YOU (1) CLICK THE DO NOT ACCEPT BUTTON, (2) DO NOT INSTALL THE SOFTWARE AND (3) RETURN ALL SOFTWARE, MEDIA AND OTHER DOCUMENTATION AND MATERIALS PROVIDED WITH THE SOFTWARE TO CRESTRON AT: CRESTRON ELECTRONICS, INC., 15 VOLVO DRIVE, ROCKLEIGH, NEW JERSEY 07647, WITHIN 30 DAYS OF PAYMENT.

LICENSE TERMS

Crestron hereby grants You and You accept a nonexclusive, nontransferable license to use the Software (a) in machine readable object code together with the related explanatory written materials provided by Crestron (b) on a central processing unit (“CPU”) owned or leased or otherwise controlled exclusively by You and (c) only as authorized in this Agreement and the related explanatory files and written materials provided by Crestron.

If this software requires payment for a license, you may make one backup copy of the Software, provided Your backup copy is not installed or used on any CPU. You may not transfer the rights of this Agreement to a backup copy unless the installed copy of the Software is destroyed or otherwise inoperable and You transfer all rights in the Software.

You may not transfer the license granted pursuant to this Agreement or assign this Agreement without the express written consent of Crestron.

If this software requires payment for a license, the total number of CPU’s on which all versions of the Software are installed may not exceed one per license fee (1) and no concurrent, server or network use of the Software (including any permitted back-up copies) is permitted, including but not limited to using the Software (a) either directly or through commands, data or instructions from or to another computer (b) for local, campus or wide area network, internet or web hosting services or (c) pursuant to any rental, sharing or “service bureau” arrangement.

The Software is designed as a software development and customization tool. As such Crestron cannot and does not guarantee any results of use of the Software or that the Software will operate error free and You acknowledge that any development that You perform using the Software or Host Application is done entirely at Your own risk.

The Software is licensed and not sold. Crestron retains ownership of the Software and all copies of the Software and reserves all rights not expressly granted in writing.

OTHER LIMITATIONS

You must be an Authorized Dealer of Crestron products or a Crestron Authorized Independent Programmer to install or use the Software. If Your status as a Crestron Authorized Dealer or Crestron Authorized Independent Programmer is terminated, Your license is also terminated.

You may not rent, lease, lend, sublicense, distribute or otherwise transfer or assign any interest in or to the Software.

You may not reverse engineer, decompile or disassemble the Software.

You agree that the Software will not be shipped, transferred or exported into any country or used in any manner prohibited by the United States Export Administration Act or any other export laws, restrictions or regulations (“Export Laws”). By downloading or installing the Software You (a) are certifying that You are not a national of Cuba, Iran, Iraq, Libya, North Korea, Sudan, Syria or any country to which the United States embargoes goods (b) are certifying that You are not otherwise prohibited from receiving the Software and (c) You agree to comply with the Export Laws.

If any part of this Agreement is found void and unenforceable, it will not affect the validity of the balance of the Agreement, which shall remain valid and enforceable according to its terms. This Agreement may only be modified by a writing signed by an authorized officer of Crestron. Updates may be licensed to You by Crestron with additional or different terms. This is the entire agreement between Crestron and You relating to the Software and it supersedes any prior representations, discussions, undertakings, communications or advertising relating to the Software. The failure of either party to enforce any right or take any action in the event of a breach hereunder shall constitute a waiver unless expressly acknowledged and set forth in writing by the party alleged to have provided such waiver.

If You are a business or organization, You agree that upon request from Crestron or its authorized agent, You will within thirty (30) days fully document and certify that use of any and all Software at the time of the request is in conformity with Your valid licenses from Crestron or its authorized agent.

Without prejudice to any other rights, Crestron may terminate this Agreement immediately upon notice if you fail to comply with the terms and conditions of this Agreement. In such event, you must destroy all copies of the Software and all of its component parts.

PROPRIETARY RIGHTS

Copyright. All title and copyrights in and to the Software (including, without limitation, any images, photographs, animations, video, audio, music, text and “applets” incorporated into the Software), the accompanying media and printed materials and any copies of the Software are owned by Crestron or its suppliers. The Software is protected by copyright laws and international treaty provisions. Therefore, you must treat the Software like any other copyrighted material, subject to the provisions of this Agreement.

Submissions. Should you decide to transmit to Crestron’s website by any means or by any media any materials or other information (including, without limitation, ideas, concepts or techniques for new or improved services and products), whether as information, feedback, data, questions, comments, suggestions or the like, you agree such submissions are unrestricted and shall be deemed non-confidential and you automatically grant Crestron and its assigns a non-exclusive, royalty-free, worldwide, perpetual, irrevocable license, with the right to sublicense, to use, copy, transmit, distribute, create derivative works of, display and perform the same.

Trademarks. CRESTRON and the Swirl Logo are registered trademarks of Crestron Electronics, Inc. You shall not remove or conceal any trademark or proprietary notice of Crestron from the Software including any back-up copy.

GOVERNING LAW

This Agreement shall be governed by the laws of the State of New Jersey, without regard to conflicts of laws principles. Any disputes between the parties to the Agreement shall be brought in the state courts in Bergen County, New Jersey or the federal courts located in the District of New Jersey. The United Nations Convention on Contracts for the International Sale of Goods shall not apply to this Agreement.

CRESTRON LIMITED WARRANTY

CRESTRON warrants that: (a) the Software will perform substantially in accordance with the published specifications for a period of ninety (90) days from the date of receipt and (b) that any hardware accompanying the Software will be subject to its own limited warranty as stated in its accompanying written material. Crestron shall, at its option, repair or replace or refund the license fee for any Software found defective by Crestron if notified by you within the warranty period. The foregoing remedy shall be your exclusive remedy for any claim or loss arising from the Software.

CRESTRON shall not be liable to honor warranty terms if the product has been used in any application other than that for which it was intended or if it as been subjected to misuse, accidental damage, modification or improper installation procedures. Furthermore, this warranty does not cover any product that has had the serial number or license code altered, defaced, improperly obtained or removed.

Notwithstanding any agreement to maintain or correct errors or defects, Crestron shall have no obligation to service or correct any error or defect that is not reproducible by Crestron or is deemed in Crestron’s reasonable discretion to have resulted from (1) accident; unusual stress; neglect; misuse; failure of electric power, operation of the Software with other media not meeting or not maintained in accordance with the manufacturer’s specifications or causes other than ordinary use; (2) improper installation by anyone other than Crestron or its authorized agents of the Software that deviates from any operating procedures established by Crestron in the material and files provided to You by Crestron or its authorized agent; (3) use of the Software on unauthorized hardware or (4) modification of, alteration of or additions to the Software undertaken by persons other than Crestron or Crestron’s authorized agents.

ANY LIABILITY OF CRESTRON FOR A DEFECTIVE COPY OF THE SOFTWARE WILL BE LIMITED EXCLUSIVELY TO REPAIR OR REPLACEMENT OF YOUR COPY OF THE SOFTWARE WITH ANOTHER COPY OR REFUND OF THE INITIAL LICENSE FEE CRESTRON RECEIVED FROM YOU FOR THE DEFECTIVE COPY OF THE PRODUCT. THIS WARRANTY SHALL BE THE SOLE AND EXCLUSIVE REMEDY TO YOU. IN NO EVENT SHALL CRESTRON BE LIABLE FOR INCIDENTAL, CONSEQUENTIAL, SPECIAL OR PUNITIVE DAMAGES OF ANY KIND (PROPERTY OR ECONOMIC DAMAGES INCLUSIVE), EVEN IF A CRESTRON REPRESENTATIVE HAS BEEN ADVISED OF THE POSSIBILITY OF SUCH DAMAGES OR OF ANY CLAIM BY ANY THIRD PARTY. CRESTRON MAKES NO WARRANTIES, EXPRESS OR IMPLIED, AS TO TITLE OR INFRINGEMENT OF THIRD-PARTY RIGHTS, MERCHANTABILITY OR FITNESS FOR ANY PARTICULAR PURPOSE, OR ANY OTHER WARRANTIES, NOR AUTHORIZES ANY OTHER PARTY TO OFFER ANY WARRANTIES, INCLUDING WARRANTIES OF MERCHANTABILITY FOR THIS PRODUCT. THIS WARRANTY STATEMENT SUPERSEDES ALL PREVIOUS WARRANTIES.

Return and Warranty Policies

Merchandise Returns / Repair Service

1. No merchandise may be returned for credit, exchange or service without prior authorization from CRESTRON. To obtain warranty service for CRESTRON products, contact an authorized CRESTRON dealer. Only authorized CRESTRON dealers may contact the factory and request an RMA (Return Merchandise Authorization) number. Enclose a note specifying the nature of the problem, name and phone number of contact person, RMA number and return address.
2. Products may be returned for credit, exchange or service with a CRESTRON Return Merchandise Authorization (RMA) number. Authorized returns must be shipped freight prepaid to CRESTRON, 6 Volvo Drive, Rockleigh, N.J. or its authorized subsidiaries, with RMA number clearly marked on the outside of all cartons. Shipments arriving freight collect or without an RMA number shall be subject to refusal. CRESTRON reserves the right in its sole and absolute discretion to charge a 15% restocking fee plus shipping costs on any products returned with an RMA.
3. Return freight charges following repair of items under warranty shall be paid by CRESTRON, shipping by standard ground carrier. In the event repairs are found to be non-warranty, return freight costs shall be paid by the purchaser.

CRESTRON Limited Warranty

CRESTRON ELECTRONICS, Inc. warrants its products to be free from manufacturing defects in materials and workmanship under normal use for a period of three (3) years from the date of purchase from CRESTRON, with the following exceptions: disk drives and any other moving or rotating mechanical parts, pan/tilt heads and power supplies are covered for a period of one (1) year; touchscreen display and overlay components are covered for 90 days; batteries and incandescent lamps are not covered.

This warranty extends to products purchased directly from CRESTRON or an authorized CRESTRON dealer. Purchasers should inquire of the dealer regarding the nature and extent of the dealer's warranty, if any.

CRESTRON shall not be liable to honor the terms of this warranty if the product has been used in any application other than that for which it was intended or if it has been subjected to misuse, accidental damage, modification or improper installation procedures. Furthermore, this warranty does not cover any product that has had the serial number altered, defaced or removed.

This warranty shall be the sole and exclusive remedy to the original purchaser. In no event shall CRESTRON be liable for incidental or consequential damages of any kind (property or economic damages inclusive) arising from the sale or use of this equipment. CRESTRON is not liable for any claim made by a third party or made by the purchaser for a third party.

CRESTRON shall, at its option, repair or replace any product found defective, without charge for parts or labor. Repaired or replaced equipment and parts supplied under this warranty shall be covered only by the unexpired portion of the warranty.

Except as expressly set forth in this warranty, CRESTRON makes no other warranties, expressed or implied, nor authorizes any other party to offer any warranty, including any implied warranties of merchantability or fitness for a particular purpose. Any implied warranties that may be imposed by law are limited to the terms of this limited warranty. This warranty statement supersedes all previous warranties.

Trademark Information

All brand names, product names and trademarks are the sole property of their respective owners. Windows is a registered trademark of Microsoft Corporation. Windows95/98/Me/XP/Vista and WindowsNT/2000 are trademarks of Microsoft Corporation.



Crestron Electronics, Inc.
15 Volvo Drive Rockleigh, NJ 07647
Tel: 888.CRESTRON
Fax: 201.767.7576
www.crestron.com

Operations Guide – DOC. 6415B
(2013896)
01.09
Specifications subject to
change without notice.

Free Manuals Download Website

<http://myh66.com>

<http://usermanuals.us>

<http://www.somanuals.com>

<http://www.4manuals.cc>

<http://www.manual-lib.com>

<http://www.404manual.com>

<http://www.luxmanual.com>

<http://aubethermostatmanual.com>

Golf course search by state

<http://golfingnear.com>

Email search by domain

<http://emailbydomain.com>

Auto manuals search

<http://auto.somanuals.com>

TV manuals search

<http://tv.somanuals.com>