

Crestron Green Light® Commercial Lighting Design Guide



 **CRESTRON**®



© 2009

Crestron Electronics Inc.
15 Volvo Drive
Rockleigh, NJ 07647

800.237.2041
www.crestron.com

For Residential Lighting Solutions, refer to Doc. 5999



All brand names, product names, and trademarks are the sole property of their respective owners.

Contents

INTRODUCTION	1	TILT TOUCHPANELS	59
CRESTRON CONTROL TECHNOLOGY	2	TPMC SERIES ISYS I/O WIFI TOUCHPANELS	60
THE SINGLE SOLUTION CONTROL SYSTEM	2	WIRELESS TOUCHPANELS AND HANDHELDS	61
SYSTEM DESIGN	3	KEYPADS.....	62
LIGHTING SYSTEM DESIGN TYPES	4	C2N-DB SERIES DECORATOR KEYPADS	62
SPECIFYING A LIGHTING SYSTEM.....	8	CNX DESIGNER SERIES KEYPADS	63
REQUIRED LOAD SCHEDULE ITEMS.....	8	CAMEO™	64
EXAMPLE LOAD SCHEDULE WITH PANEL TERMINATIONS.....	9	iLUX INTEGRATED LIGHTING CONTROL SYSTEM	66
COMMERCIAL LIGHTING WIRING PLAN.....	10	iLUX FEATURES	67
EQUIPMENT LIST SPECIFICATION.....	10	WIRELESS iLUX REMOTE	67
ORDERING A CRESTRON COMMERCIAL LIGHTING SYSTEM... ..	10	MULTI-UNIT EXPANSION.....	68
GREEN LIGHT POWER SWITCHING	11	CONTROL SYSTEM INTEGRATION	69
SYSTEM FEATURES.....	11	iLUX EXPANSION MODULES.....	70
GLPS-HSW	14	WALL BOX DIMMERS AND SWITCHES	72
GLPS-SW.....	17	CRESNET WALL BOX DIMMERS.....	73
GLPS-HSW-FT	20	CRESNET WALL BOX SWITCHES	74
GLPS-SW-FT	22	INFINET™ WIRELESS TECHNOLOGY	75
GLPS-HDSW-FT.....	24	CONTROL PROCESSORS.....	78
IPAC-GL1	26	PAC2 LIGHTING CONTROL PROCESSOR	78
GLA-PWS50.....	28	PAC2M PROFESSIONAL AUTOMATION MINI CONTROL SYSTEM.....	80
DIMENSIONS	30	OCCUPANCY AND PHOTOCCELL SENSORS	83
GREEN LIGHT OPTIONS.....	36	GLS-ODT & GLS-OIR	83
CAEN- SERIES ENCLOSURES	36	GLS-LOL & GLS-LCL	83
CAEN INSTALLATION.....	38	INTEGRATED SHADE AND DRAPE CONTROLLERS	84
CAEN ENCLOSURE FRAMING.....	38	C2N-SDC.....	84
CAEN WIRING	39	C2N-SDC-DC.....	84
UNIVERSAL MOUNTING PLATES	40	C2N-SSC-2	84
COVER EXTENSION KITS	41	INTEGRATED PARTNER MODULES.....	85
CLX LIGHTING CONTROL MODULES	42	APPENDIX A:.....	86
TERMINAL BLOCKS AND MODULES.....	44	ROOMVIEW® REMOTE ASSET MANAGEMENT.....	86
CRESNET® TERMINAL BLOCK FOR CAEN AUTOMATION		ROOMVIEW SERVER EDITION	86
ENCLOSURES	46	ROOMVIEW EXPRESS	89
CRESTRON DIN RAIL PRODUCTS	48	APPENDIX B.....	90
DIN-AP2	50	GREEN LIGHT DESIGNER SOFTWARE™:.....	90
DIN-1DIMU4.....	51	APPENDIX C: TOUCHPANEL COMPARISON CHARTS.....	92
DIN-8SW8	52	TILT TOUCHPANELS	92
DIN-4DIMFLV4.....	52	WALL MOUNT TOUCHPANELS	93
DIN-2MC2	52	WIRELESS TOUCHPANELS & HANDHELD REMOTES.....	94
DIN-A08.....	53	APPENDIX D: GENERAL LIGHTING DESIGN CONSIDERATIONS....	95
DIN-I08	53		
DIN-BLOCK.....	54		
DIN-PWS50	54		
DIN-HUB.....	55		
INTERFACE EQUIPMENT	56		
WALL MOUNT TOUCHPANELS	57		

Introduction

Crestron is the world's leading manufacturer of advanced control technologies. Our developments in combining touchpanel technology with lighting control applications were the very first of their kind.

Only Crestron brings the most comprehensive line of user-interfaces to lighting and dimming control, plus the ability to remotely monitor, manage and control over standard IP networks.

Cresnet® low-voltage wiring and/or RF control can be used throughout a wide range of system design possibilities, including traditional wiring with local intelligence or distributed, high-voltage wiring with centralized and/or distributed intelligence systems.

The wide range of Crestron multi-function user interfaces replaces large banks of traditional switches, dimmers, and timers. In addition to lighting, these user interfaces can also control security, HVAC, and audio/video systems. Only Crestron provides a single control wiring bus to all of its components, simplifying installation and connection.

Each unique lighting control system reflects the needs and desires of the inhabitants. Designing and constructing a lighting and automation system to fill the requirements of your client is a challenging task, and Crestron offers the equipment and flexibility of design required for every one-of-a-kind solution.

Crestron interfaces provide manual and automatic controls; turning on exterior lights based on an astronomical clock, providing a single button press to turn all lights on, illuminating safe exits in case of emergency, and many other lighting possibilities.

Crestron products allow the designer to continually expand and change any lighting system. Crestron infiNET™ wireless devices provide a simple retrofit solution to expand an existing system. Every Crestron lighting system is completely modular and scalable, allowing virtually unlimited configuration and expansion flexibility.

Crestron eliminates the need to walk from room to room to adjust drapes, lights, temperature, and audio/video components—total control is always at your fingertips.

Crestron Green Light™

Crestron Green Light is a complete line of lighting, HVAC, and shade/drape control for both commercial and residential applications, designed to maximize energy conservation and cost savings.

Crestron Green Light solutions underscore the company's ongoing commitment to environmental safety and energy conservation. Only Crestron offers a fully integrated global systems approach with the unique ability to monitor and manage all environmental and AV systems on a single platform that maximizes efficiencies and cost savings.

Crestron Green Light technology delivers total environmental control throughout a home or commercial facility to conserve energy and lower costs without sacrificing comfort and convenience. Crestron systems provide users the flexibility of both precise manual control of all systems and devices, and customized levels of automation to achieve advanced features such as daylight harvesting and load shedding. Only Crestron can schedule, monitor and manage all technology centrally and globally from touchpanels and PCs.

Crestron Green Light products meet ASHRAE standards and are fully CEC Title 24 compliant. Crestron is a member of the U.S. Green Building Council (USGBC), the organization responsible for creating the LEED Green Building Rating System™. Crestron Green Light solutions take a whole-building approach to sustainability, and facilitate the efficient operation of high performance green buildings. Additionally, all Crestron Green Light products conform to the European Union (EU) Directive 2002/95/EC Restriction of Hazardous Substances (RoHS).

Crestron **Roomview**™ software (appendix A) monitors controls, schedules and tracks assets. Facility managers can perform remote system diagnostics and automate tasks through event scheduling.

Crestron Green Light™ Designer software (appendix B) allows you to design and document a complete, energy-efficient commercial lighting solution that combines facility-wide lighting, shade/drape control with audio/video integration and network management—all without requiring extensive knowledge of Crestron products, or any other Crestron software.

Crestron Control Technology

View precise lighting levels, temperature and shade positions in any room throughout the installation, graphically and quantitatively, from any touchpanel or PC.

Monitor and track current and historical device usage and intelligently manage resources.

Ethernet connectivity enables LAN or web-based system control and management, and sends email advisories about pre-determined events such as devices going off-line or automatic load shedding.

Crestron control processors provide the total integration of Crestron devices, non-Crestron devices, and subsystems in any environment, for any purpose, anywhere. Crestron control processors can connect to any digital, serial, or analog system, and control by RF, IR, or hardwiring, making them the most flexible, powerful control systems ever devised.

Underlying the hardware are powerful, graphical programming tools, specifically designed to establish total control over any technology and make the user experience uncomplicated, intuitive, and easy to use.

Crestron also provides true feedback for essential control monitoring, function response to controls, and user inputs.

Crestron offers design solutions for every situation. Selecting the proper equipment often depends on the kind of installation. New construction, major renovation, or minor renovation each present different design challenges.

Single Solution Control System- Crestron Exclusive

Crestron connects people with technology. As products and systems become more complex, our solutions streamline and simplify technology so people can enjoy its benefits.

We understand that our touchpanels, keypads, and handhelds are how people interact with and experience the systems in their homes, offices, schools and churches. We allow individuals to create a comfortable environment, set a mood, and enjoy technology.

With our wide range of interface products, slim profile wall mount keypads and decorative faceplates, our products enhance a décor, complement a lifestyle, or personalize a room. Crestron offers the most brilliant graphics and intuitive, customized interfaces. We integrate more of the technology that people want and use everyday into our touchpanels; and provide ergonomically designed and easy-to-use wireless controllers, and flush-mount touchpanels of every size.

Tying all this technology together seamlessly is our exclusive Cresnet® cable, connecting the user to a powerful and flexible control system.

System Design

The applied lighting control strategy determines the basic methods used to control the environment. When formulating an overall strategy, there are some basic considerations:

- **New construction** and major renovations provide the opportunity to easily run control cables from user interfaces to the control processor when the walls are open.
- **Existing construction** or minor renovations often make the task of running cables more difficult, time consuming, expensive, or even impossible (in historic landmarks, etc.). In this case, you may choose to install a partial or completely wireless system
- **Light level control** is achieved through dimming controls and daylight management, where applicable, to adjust the lighting to the appropriate level for different occupant activities
- **Occupancy sensing** is used to switch the lighting on and off, independent of time intervals or scheduled periods. This allows the space to be responsive to individual use, and conserves energy
- **Scheduled lighting** is determined by time of day, day of week, vacation, outdoor lighting, and safety lighting requirements. An astronomical clock (programmed with sunrise and sunset information) is often used to provide natural lighting transitions
- **HVAC control** should be part of the overall control strategy, permitting additional economic and convenience benefits

Lighting System Design Types

There are many ways in which a Crestron lighting control system can be organized. Construction type, client requirements, architectural restrictions, and many other factors determine the best solution. In general, retaining Crestron control design flexibility produces the most reliable results.

Wireless Systems

The groundbreaking Crestron infiNET wireless technology provides reliable 2-way communications throughout a home or commercial structure without the need for physical control wiring. Crestron infiNET products offer a unique solution for retrofit projects. By replacing existing controls with infiNET switches and dimmers, provisions for automatic shutoff and overall control can be implemented with minimal changes to the existing wiring.

Employing a 2.4 GHz mesh network topology, every infiNET device functions as an RF repeater, increasing effective range and reinforcing the complete network by providing multiple redundant signal paths within the mesh network. Adding more infiNET devices or repeaters to the network effectively increases the range, strength, and reliability of the network.

Advantages of RF wireless control start with reduced capital and operating expenses. Wireless control can save as much as 30 to 40 percent on installation and material costs compared to a wired control system, making this option attractive for retrofit as well as new construction. Installation costs are reduced because RF devices can be replaced one to one without involving control wiring.

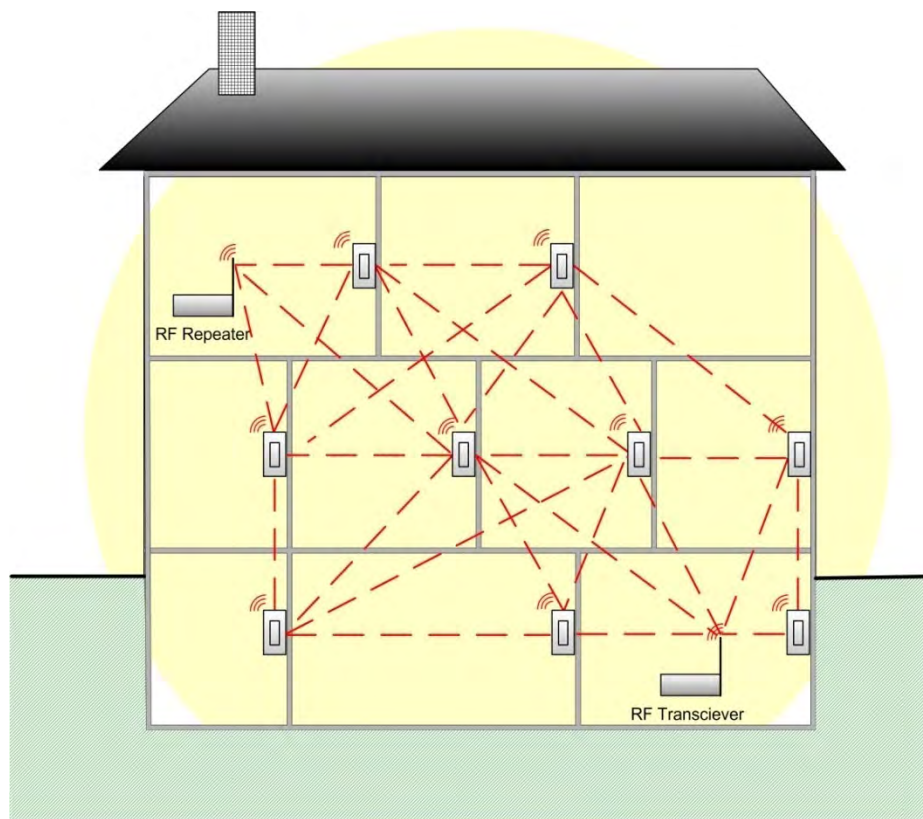

Crestron infiNET Wireless System

Centralized Wired Systems

A centralized system is one in which all the high-voltage circuits are terminated within a Crestron automation enclosure and operate under a central control system. In a centralized design, the high voltage lighting, fans, motors and switch circuits are individually wired directly to the control modules in the Crestron automation enclosure. The modules are controlled by low voltage or RF user interfaces in the living area. This greatly simplifies the high voltage wiring while creating a flexible and efficient design using keypad and touchpanel interfaces.

A central processor, connected via a local area network to the lighting modules and the user interfaces, is dedicated to lighting, fans, motors, HVAC, and security. Processors that are dedicated to other control systems can communicate via Ethernet, RS-232 or RS-422 to the central controller. This eliminates the need for additional control that separate safety and environmental systems and is a flexible, fully integrated design solution.

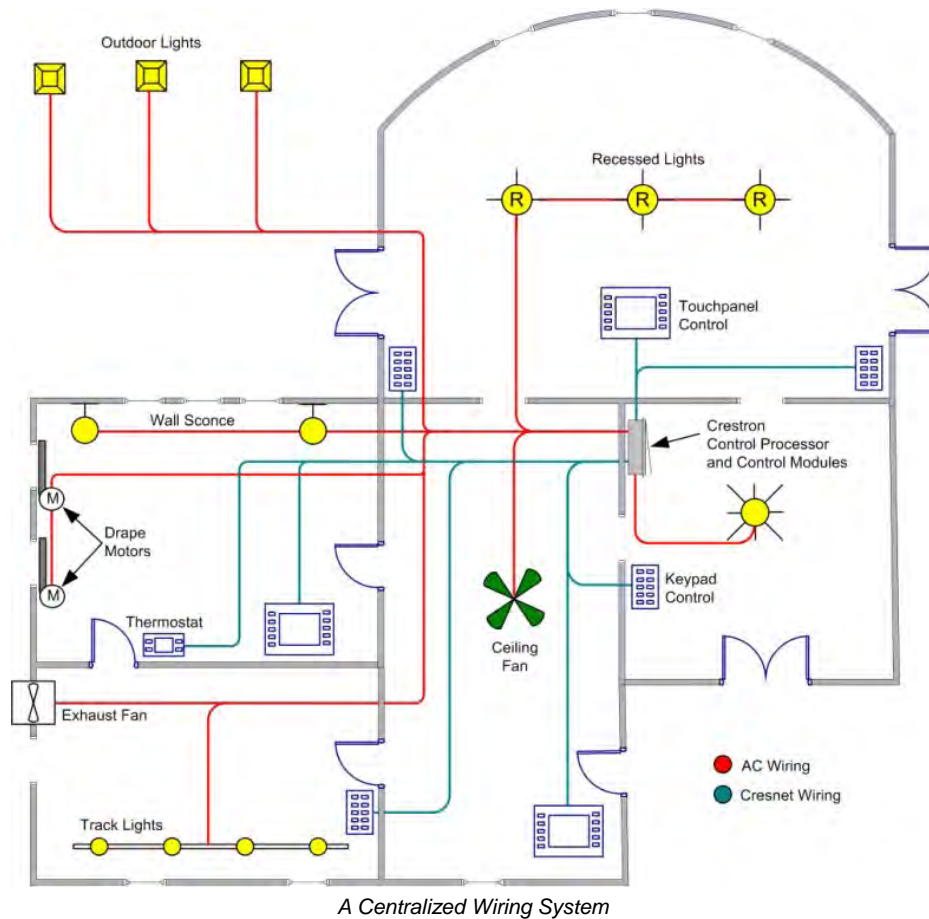

Decentralized Wired Systems

A decentralized system is the traditional wiring system of individual lighting circuits with local control. In the traditional distributed design wiring method, Crestron wall box dimmers can be retrofitted into a project after routine high voltage wiring is completed.

In addition to the traditional high voltage wiring, a low voltage communication wire can be run from the dimmer to the nearest Cresnet® connection (or an RF wireless control can be used). This design offers the end user the familiarity of a traditional control coupled with the power and flexibility of automation. In a distributed design, the user has the ability to operate the lighting in the event of a temporary control system interruption.

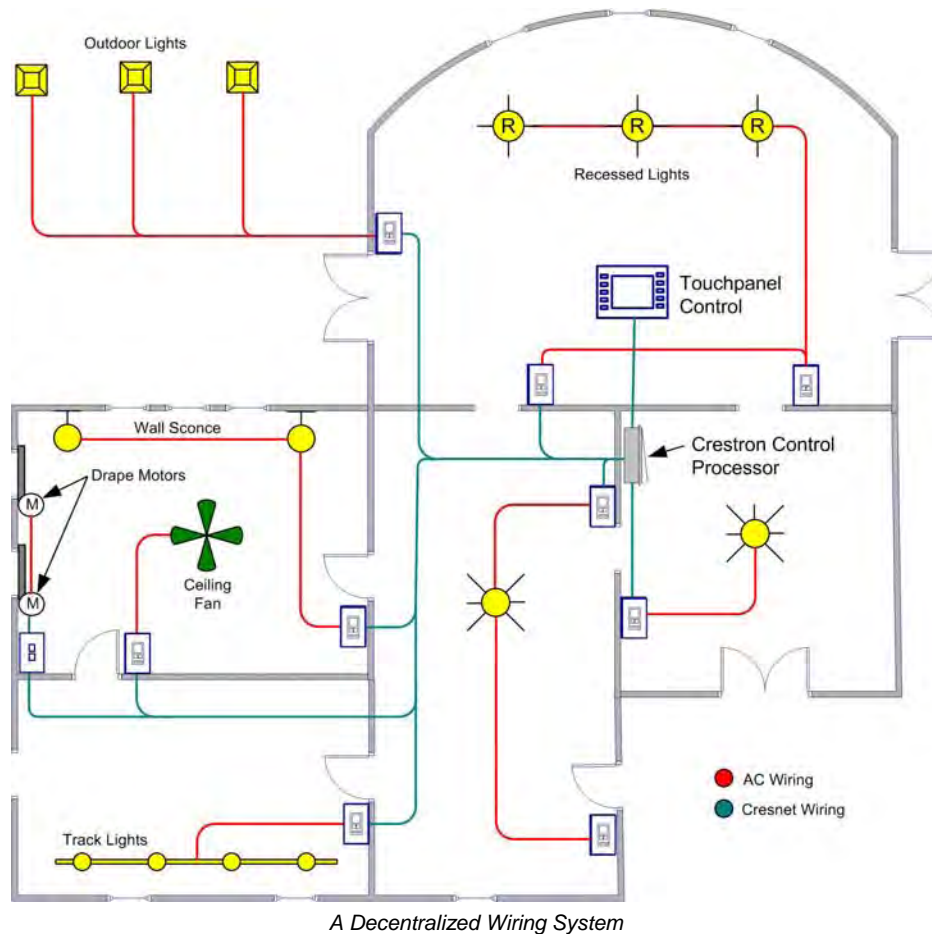

Hybrid Systems

The most efficient and attractive lighting system designs are a hybrid of centralized processing and distributed dimmers. This provides the reliability of local control along with sophisticated centralized control, and limits the amount of wall clutter

A complete Crestron design is a blend of wireless and wired, distributed and centralized design in which central control intelligence and distributed local dimmers form a reliable whole house lighting control solution.

Large rooms, stairways, and frequently used rooms are often remotely controlled using the astronomical time clock or whole house presets. This level of control requires connection to a central dimming controller. Each room is equipped with a low voltage or wireless keypad for lighting preset selection and/or audio/video integration. All of the dimmers in the system (grouped into the central controller for wiring convenience) communicate with each other through the Crestron control system, providing a complete, integrated solution

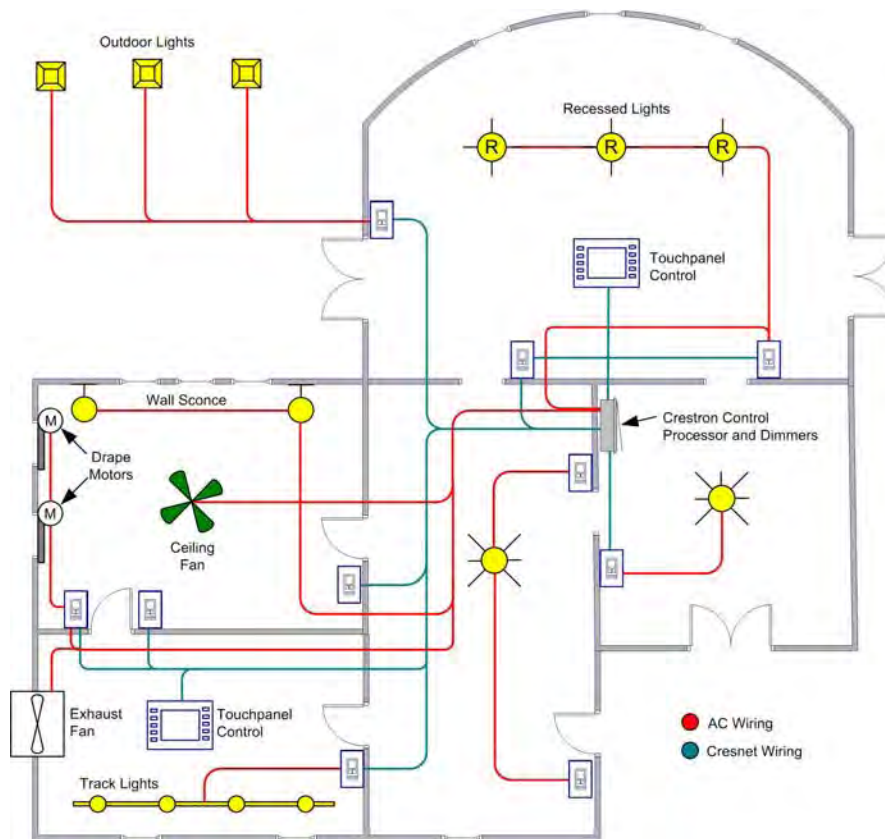

A Hybrid Wiring System

Specifying a Lighting System

The Load Schedule

A lighting system design begins with a collection of complete information. This includes a detailed floor plan identifying all of the required elements. The first element of design, the load schedule, is developed from the floor plan. The load schedule lists the information on each electrical load connected to every circuit in an electrical panel. This primary source of information determines all of the overall requirements:

- Lighting types, required voltage and current, dimmed or switched, fluorescent ballast types, circuit number, normal or emergency, and locations
- The location and types of user interfaces used (i.e., dimmers, switches, keypads, iLux™, infiNET™, and touchpanels)
- The control processor details (larger systems should use a dedicated lighting control processor)
- The window treatment details, which include shade/blind motors and relay control (consult the window treatment manufacturer for control details).

Required Load Schedule Items

1. Control zone: Controlled circuits that do not need to be physically wired together, but always operate in tandem. For example, perimeter lights, sconce lights and overhead lights all operating together
2. Location of controlled lighting zone, relevant to building site/drawings, floor designation, and room name
3. Fixture and/or lamp type of controlled lighting zone, including any information describing custom fixtures, undetermined fixtures, dimmable transformers or fluorescent ballasts, and circuit breaker numbers. This information can also contain the number assigned to the controlled circuit
4. Load type of the controlled lighting zone: load types include incandescent, magnetic low voltage, electronic low voltage, neon/cold cathode, HID, dimmable/non-dimmable fluorescent ballast, ceiling fans, and switched 3-wire motor circuits. This

information is especially important for selecting the correct Crestron module power rating and type

5. Dimming requirement for the controlled lighting zone (i.e. whether the lighting level of the loads/fixtures needs to be ramped up/down or simply switched on/off). Indicate: "Yes" for Dimming, and "No" for Non-Dim
6. Emergency designation for the controlled lighting zone (yes/no; i.e. when a load needs to be assigned to a separate emergency power feed). These items are assigned to their own separate dimmer, so they can be fed with emergency power
7. Voltage rating for the controlled lighting zone tells the designer the voltage of the electrical feeds required for that zone, and hence the required rating for the associated Crestron module.
8. Fixture wattage (watts or power rating per fixture) with regard to the controlled lighting zone: this is used to determine the number of fixtures that can be powered per each Crestron Dimmer Module channel, in order not to overload the dimmer beyond its power rating
9. Quantity of fixtures for the controlled lighting zone: this is useful, along with item #6, in calculating the total power rating (watts) for that particular controlled circuit (item #9)
10. Total wattage, or power rating, of the controlled lighting zone: This is required in order to determine the total number of Crestron Lighting Module channels required for that particular zone, especially if the load of the total number of fixtures exceeds the rating of a single module channel

A riser diagram is required for commercial lighting projects. The single line or tier diagram indicates system components connected to individual circuits in the system. Components connected to a common circuit are shown as being connected to a single line, regardless of the number of conductors actually used. The number of conductors in each wiring segment is usually indicated by right angle marks across the single line at that point or by other appropriate means

NOTE: National and local electrical codes and the functionality of each user interface must be taken into consideration. Always install electrical devices according to the national Electrical Code (NEC), local codes, and with safety in mind.

Example Load Schedule with Panel Terminations

Area	Room	Controlled Ckt Name	Controlled Ckt No.	Fixture	Load Type	Dim	Emergency	Fixture Watts	Fixture Qty	Total Watts	Enclosure	Slot	Module	Output
Main Floor	Bathroom 1	Downlights	009	Downlights	Incandescent	yes	no	100	1	100	Enclosure 1	2	CLX-1DIM8	1
Main Floor	Bathroom 1	Downlights 2	008	Downlights	Incandescent	yes	no	100	2	200	Enclosure 1	2	CLX-1DIM8	2
Main Floor	Bathroom 1	Downlights 3	006	Downlights	Incandescent	yes	no	100	2	200	Enclosure 1	2	CLX-1DIM8	3
Main Floor	Bathroom 1	Drapes	019	Drapes	3-Wire Motor	no	no	200	1	200	Enclosure 1	4	CLX-1MC4	1
Main Floor	Bathroom 1	Exhaust Fan	007	Exhaust Fan	Switched	no	no	200	1	200	N / A	N / A	Interface 2	1
Main Floor	Bathroom 2	Downlights	011	Downlights	Incandescent	yes	no	100	1	100	Enclosure 1	2	CLX-1DIM8	4
Main Floor	Bathroom 2	Downlights 2	010	Downlights	Incandescent	yes	no	100	3	300	Enclosure 1	2	CLX-1DIM8	5
Main Floor	Bathroom 2	Drapes	021	Drapes	3-Wire Motor	no	no	200	1	200	Enclosure 1	4	CLX-1MC4	2
Main Floor	Bathroom 2	Exhaust Fan	012	Exhaust Fan	Switched	no	no	200	1	200	N / A	N / A	Interface 4	1
Main Floor	Bedroom	Ceiling Fan	022	Ceiling Fan	Ceiling Fan	no	no	100	1	100	Enclosure 1	6	CLX-1FAN4	1
Main Floor	Bedroom	Downlights	005	Downlights	Incandescent	yes	no	250	2	500	Enclosure 1	2	CLX-1DIM8	7
Main Floor	Bedroom	Downlights 2	004	Downlights	Incandescent	yes	no	100	4	400	Enclosure 1	3	CLX-1DIM4	1
Main Floor	Bedroom	Downlights 3	003	Downlights	Incandescent	yes	no	100	1	100	N / A	N / A	Interface 6	1
Main Floor	Bedroom	Downlights 4	002	Downlights	Incandescent	yes	no	100	1	100	N / A	N / A	Interface 5	1
Main Floor	Bedroom	Downlights 5	001	Downlights	Incandescent	yes	no	100	2	200	Enclosure 1	3	CLX-1DIM4	2
Main Floor	Bedroom	Drapes	018	Drapes	3-Wire Motor	no	no	200	1	200	Enclosure 1	4	CLX-1MC4	3
Main Floor	Bedroom	Drapes 2	017	Drapes	3-Wire Motor	no	no	200	1	200	Enclosure 1	4	CLX-1MC4	4
Main Floor	Bedroom	Drapes 3	016	Drapes	3-Wire Motor	no	no	200	1	200	Enclosure 1	5	CLX-1MC4	1
Main Floor	Foyer	Downlights	013	Downlights	Incandescent	yes	no	100	4	400	Enclosure 1	2	CLX-1DIM8	6
Main Floor	Sauna	Drapes	020	Drapes	3-Wire Motor	no	no	200	1	200	Enclosure 1	5	CLX-1MC4	2

*Calculation of load wattage includes transformer loss.

The complete diagram is available on line at:

http://www.crestron.com/dealer-tech_resources/application_diagrams.asp.

Commercial Lighting Wiring Plan

The wiring plan includes all enclosures and the interconnecting wiring. The designer determines the location of the enclosure(s), the route of keypad and touchpanel connections to the enclosure(s), the route of the interconnecting cable from the processor to the other enclosure(s), and the high voltage load routes to the enclosure or dimmer.

Ensure there are enough connectors and power (PAC2 offers 50W) in the main enclosure for all user interfaces. Each enclosure filled with dimmers is connected to the main enclosure and processor using low voltage wire. Dimmer enclosures are distributed as needed.

Equipment List Specification

The equipment list is based on the requirements collected for the lighting system in the load schedule. This is a sequential process. The information gathered in previous steps is required to complete the next. Once all the steps are done, a complete Bill of Material for the system is created.

- Module selection – based on the number and type of loads
- Automation enclosure selection – based on the number of modules and the available space in the enclosure
- User interface selection – based on the user control requirements
- Wiring plan – based on the previous steps and the layout of the environment
- Control processor – based on the size of the system (large systems should have a dedicated processor)
- Network block selection – based on the layout and distribution of the loads and user interfaces
- Accessories selection – based on the required accessories (telephone and alarm systems, HVAC control, intercom systems, occupancy sensors, etc.)

Ordering a Crestron Commercial Lighting System

These are the steps for ordering a Crestron commercial lighting control system, regardless of the size.

Each system and module contains the appropriate installation literature and operation guide.

Steps to order a lighting system:

STEP 1: Survey all controlled lights and loads. In hybrid systems determine which loads are under local control and which are to be wired to centralized modules

STEP 2: Determine the number and types of control modules and terminal blocks needed to control lights and loads based on the load schedule and wiring plan

STEP 3: Determine the number and type of automation enclosures required

STEP 4: Determine the number of control processors and related accessories required

STEP 5: Determine the number and types of keypads, wall panels, iLux™ devices, infiNET™ wireless devices, shade/drape controllers, and touchpanels

STEP 6: Determine the wiring accessories, cabling and power supplies required

STEP 7: Place an order for identified Crestron items

Nearly all required documentation, such as load schedules and wiring, equipment lists, engraving files and more can be generated by using the Crestron D3 Pro Lighting and Automation System Software.

Crestron ships all items to the job site for assembly and wiring.

Note: Crestron Green Light Panels are shipped assembled and are to be commissioned by Crestron.

Green Light Power Switching

Crestron Green Light Power Switching is a family of switching systems designed for control of lighting in office buildings, warehouses, parking garages, sports facilities, public spaces, and anywhere centralized switching is required. With a range of panel sizes and configurations available, every system is fully scalable to fit each installation perfectly. An extensive selection of Crestron keypads, touchpanels, occupancy sensors, photocells, shade controllers, and numerous other peripheral options afford astounding design flexibility with unparalleled capability for integration

Green Light Power Switching is simple to install and easy to program. Native features include an astronomical time clock to allow scheduling of events to occur around the rise and fall of the sun. Other powerful, energy saving capabilities include occupancy sensing to turn off lights when they are not needed, daylight harvesting to harness natural light from windows and skylights, and emergency override to assure safe and reliable lighting of critical areas in the event of a power outage or emergency condition.

- > Scalable and field-serviceable modular design
- > Switching control for all types of lighting loads and motors up to 2 HP
- > All outputs rated at 16A @ 120V and 277V (347V also available)
- > Local front panel relay controls
- > 3 high-performance relay types available
- > UL 508 Section 61C rated for electronic ballast
- > Available 0-10V fluorescent dimming control
- > Positive air gap at each output
- > Feed-through, main lug only, main circuit breaker options
- > CEC Title 24 listed
- > Astronomical time clock
- > Occupancy sensing and daylight harvesting
- > Emergency override capability
- > Easy programming via the IPAC-GL1 lighting processor
- > Extensively programmable via PC software
- > Wide selection of interface and computer control options
- > Optional shade and drupe controllers
- > Crestron RoomView® remote management
- > Integration into building management systems
- > System design by Crestron
- > Factory assembled and tested

SYSTEM FEATURES

High-Performance Power Switching—Crestron GLEP Series power switching panels feature field-replaceable switching modules with a choice of relay technologies to address a wider range of applications and budgets.

Our top of the line GLPS-HSW panels employ robust 50 Amp mechanically-latching relays in combination with advanced zero-cross arcless technology to achieve a relay lifetime of one million cycles. For a higher density switching solution, our GLPS-SW panels utilize the same rugged 50 amp relays while putting more controlled circuits in less space. Either panel supports both 120 and 277 voltages, and includes main lugs and integrated branch circuit breakers.



GLPS-HSW Panel

For installations using a separate circuit breaker panel, Crestron offers the Green Light Express series of "feed-through" panels. Like their "main lug" panel counterparts above, the GLPS-HSW-FT and GLPS-SW-FT panels feature zero-cross arcless switching and standard high-inrush switching respectively. Green Light Express also offers one more relay option in the GLPS-HDSW-FT, utilizing heavy duty

modular relays for an extra level of flexibility switching 120, 277, and 347 volt loads.

In addition to switching, some Green Light Power Switching panels also allow the option to add dimming control for 0-10V dimmable fluorescent ballasts.

The IPAC-GL1 Control Processor—Crestron has been manufacturing and innovating microprocessor-based control systems for lighting and automation longer than anybody, and all of that know-how has gone directly into the IPAC-GL1. Right from its front panel, an entire system of lighting loads, keypads, touchpanels, sensors, and scheduled events can be programmed without ever having to connect a computer.

Featuring the same 2-Series control engine as other Crestron processors, the IPAC-GL1 allows advanced programming to support all kinds of control options and interfaces, custom functionality and extensive integration with third-party systems. Crestron processors also deliver the most comprehensive capabilities available for remote control and management over an IP network.

Local Controls—Crestron Green Light simplifies installation by providing local controls right on the front of each switching module. Even before the lighting processor gets installed, these simple controls can be used to switch each load on and off for testing and operation during construction.

Emergency Override—Remote emergency override capability allows a power loss sensor (GLS-PLS-120/277) or any external contact closure to override the lighting system program and set each circuit to its override preset state. In a power failure situation using a backup power source, this allows designated emergency lighting circuits to be turned on immediately. Override settings can be made easily using the local controls on the front of each switching module.

Cresnet®—Each Green Light Power Switching panel communicates with the IPAC-GL1, or other Crestron 2-Series processor, via the Cresnet control network. This simple 4-wire bus affords proven reliable digital control and flexible system configuration, carrying data communications and 24 volt DC power to support a complete system of lighting panels, keypads, touchpanels, sensors, and numerous other Cresnet devices while connected to an IPAC-GL1 Integrated Professional Automation Computer.

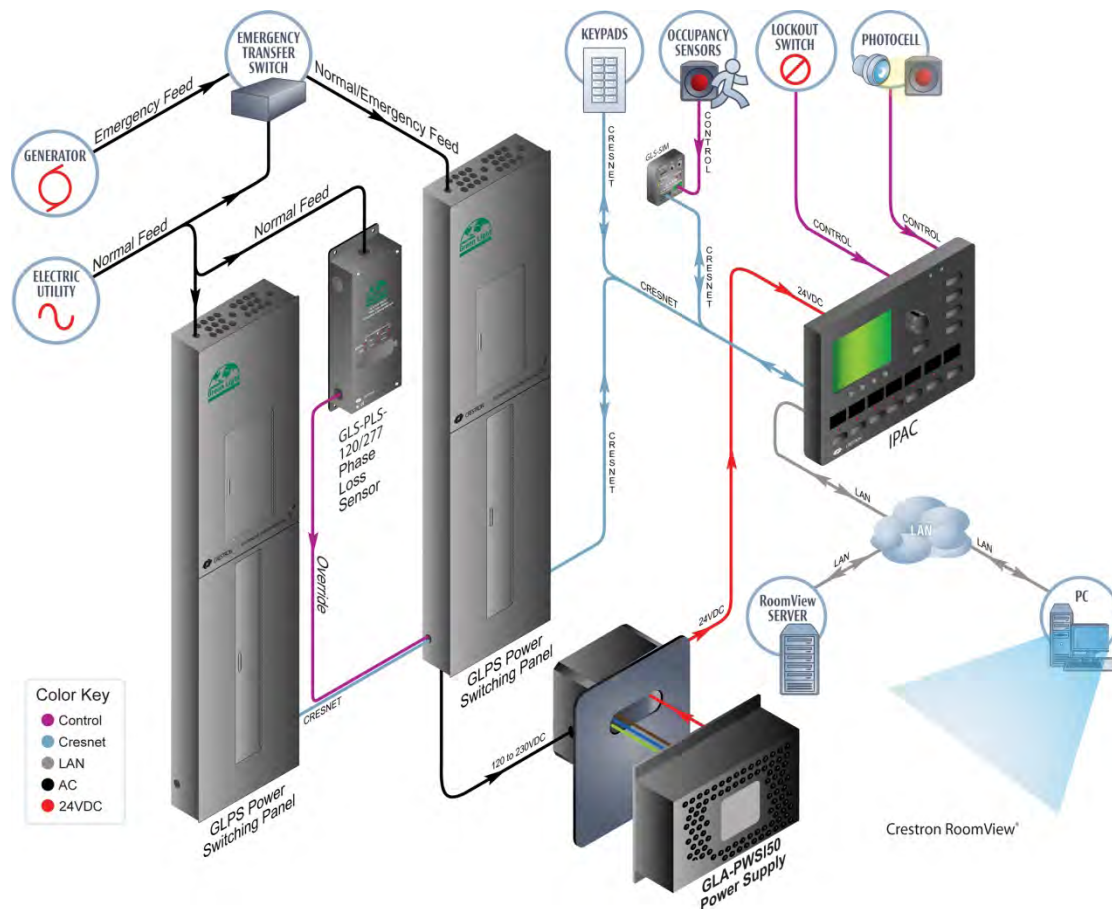

Crestron Green Light Power Switching Panels are available in five basic configurations. Use the following cross-reference table to begin specifying the configuration that fits your application.

This table represents the full line of Crestron Green Light and Green Light Express Power Switching panels, as well as Green Light and Green Light Express Architectural Dimming panels. All are shown side-by-side for easy comparison. The Power Switching panels are each fully detailed under their respective specifications pages within this document. For details about Architectural Dimming panels, please refer to the Crestron Green Light™ Architectural Dimming Specification Guide, Doc. 4785 (future).

	GREEN LIGHT			GREEN LIGHT EXPRESS				
	Power Switching		Architectural Dimming	Power Switching			Architectural Dimming	
	GLPS-HSW	GLPS-SW	GLPD-DIM	GLPS-HSW-FT	GLPS-SW-FT	GLPS-HDSW-FT	GLPD-DIM-FT	GLPD-DIMX-FT
Switching Relay Types								
Arcless high-inrush	●		●	●			●	
Standard high-inrush		●			●			
Modular high-inrush						●		
2-pole available						●		
Dimming Load Types								
Incandescent, MLV			●				●	●
ELV			●				●	●
2-wire fluorescent			●				●	●
3-wire fluorescent			●				●	●
0-10V fluorescent	●	●	●				●	●
Ratings								
Voltages	120/230/277	120/230/277	120/230/277	120/230/277	120/230/277	120/230/277/347	120/230/277	120/230/277
Output capacity lighting loads	16A	16A	16A ⁴	16A	16A	20A	16A ⁴	8A
Output capacity, motor loads@ 120/230/277 volts	0.5/1/1 hp	1/2/2 hp	0.5/1/1 hp	0.5/1/1 hp	1/2/2 hp	0.5/1.5/1.5 hp	0.5/1/1 hp	
Rated relay lifetime ⁵	1,000,000	10,000	1,000,000	1,000,000	10,000	30,000	1,000,000	
Circuit Breakers								
Integrated branch breakers	●	●	●					
Available main breaker	●	●	●					
Additional Features								
Load state indicators	●	●	●	●	●	●	●	●
Local override	●	●	●	●	●	●	●	●
Emergency override	●	●	●	●	●	●	●	●
Mechanical override						●		
Local control access door option	●	●						
Backup power supply capable	●	●	●	●			●	

Notes:

1. Please see Crestron Green Light™ Architectural Dimming Specification Guide, Doc. 4785 (future) for full description and specifications.
2. Supported via use of appropriate CLS-EXP expansion module.
3. 3-wire fluorescent loads require 2 control outputs per load.
4. Consult detailed specifications for ratings for ELV loads.
5. Relay lifetime based on number of cycles (on/off) with full electronic ballast load.

GLPS-HSW Green Light Power Switching Panels (MLO) Main Lug Only and (MCB) Main Circuit Breaker Zero-Cross Arcless Relays



The GLPS-HSW Power Switching Panels come standard with 20A branch circuit breakers, and accept 208Y/120 or 480Y/277 volt feeds terminating to main lugs provided. An optional back-fed main circuit breaker may also be specified.

Four panel sizes are available, dubbed "Small," "Medium," "Large," and "Extra Large." The panel size is ordinarily determined according to the number of control circuits specified, ranging from 8 to 42 circuits per panel. Each control circuit is rated for 16A at 100-277V.

The GLPS-HSW panels utilize Crestron zero-cross arcless relay technology, achieving a relay lifetime of one million cycles. A high-current triac is employed to handle the high-inrush current turn on, especially with certain load types such as HID and electronic ballasts. Within milliseconds, the continuous load is transferred to a robust 50A mechanically-latching relay. All switching occurs at the zero-cross point of the AC waveform under microprocessor control. This is a complete solution eliminating arcing at the physical relay contacts during turn on and turn off, and supports switching of all types of lighting loads up to 16A at 100V to 277V, as well as motors up to 1 HP.

As an option, GLPS-HSW panels may be equipped with 0-10V fluorescent dimming control substituted in place of some or all switching circuits. Consult Crestron Sales Support Services to specify this option.

The GLPS-HSW panels employ field-replaceable lighting control modules, with 8 or 12 control circuits per module, for excellent configurability and serviceability. Each module includes local relay controls and load state indicators for each circuit, plus additional controls and indicators for use during system commissioning.

Individual hinged doors are provided on the front of each GLPS-HSW panel for access to the circuit breaker panelboard and the local controls on each module. As an option, the local control access door may be omitted.

As part of a complete Green Light system, GLPS-HSW panels connect to an IPAC-GL1 lighting control processor (or other 2-Series control system) via the Cresnet® control network. An optional GLA-PWS50 (or equivalent) power supply is also recommended for each panel to provide backup power to the lighting modules.

Remote emergency override mode allows the lighting system program to be overridden while each circuit is set to an override preset state. The override preset for each circuit is set using the local controls on the front of each lighting module. Remote override mode is activated by an external contact closure from a Crestron GLS-PLS-120/277 power loss sensor or other device.

All low-voltage connections to a GLPS-HSW panel are made via a connector block located near the bottom of the panel. Connections are provided for Cresnet communications, backup power supply, and emergency override.

Crestron Green Light Power Switching panels are configured to order, factory assembled and tested prior to shipping. Each panel is engineered to provide a clean and manageable installation with provisions for wire termination and conduit knockouts. On-site installation is fast and easy with all termination points clearly labeled and accessible from the front.

MODEL NUMBERS

Specifying and ordering a Crestron Green Light Power Switching panel is facilitated using the following model number system. Simply fill in the appropriate entry in each position according to the steps that follow:

GLPS-HSW-MLO-30-120-10K-ND
GLPS-Relay Type-Feed Type-Number of Ckts-Voltage-AIC Rating-Door Option

The above example is for a "Main Lug Only" panel with 30 "HSW" zero-cross arcless relays, 120V / 10kAIC circuit breakers, and no local control access door.

Relay Type: Enter "HSW" to specify zero-cross arcless switching relays.

Notes: For other relay types, refer to the Selection Guide

0-10V fluorescent dimming is also available. Consult Crestron Sales Support Services to specify this option.

Feed Type: Choose one of the following to specify the type of feed:

- MLO Main lug only
- MCB60 60A back-fed main circuit breaker
- MCB80 80A back-fed main circuit breaker
- MCB100 100A back-fed main circuit breaker
- MCB125 125A back-fed main circuit breaker
(available for 277V only)

Note: Main feeds are 3-phase, 4-wire; rated 225A @ 120/208V or 250A @ 277/480V. Consult Crestron Sales Support Services for 400A feed and other main circuit breaker options.

Number of Circuits: choose one of the following numeric values from the appropriate column to specify the number of controlled circuits in the panel:

	GLPS-HSW-MLO	GLPS-HSW-MCB
Small:	8, 12	8, 12
Medium:	16, 20, 24, 28, 30	16, 20, 24, 27, 30
Large:	32	32
Extra Large:	36, 40, 42	36, 39

Note: "Small," "Medium," "Large" and "Extra Large" refer to the default panel size per number of circuits. Consult Crestron Sales Support Services for alternate configurations.

Voltage: To specify the circuit breaker voltage, enter "120" for 120/208V or "277" for 277/480V.

AIC Rating: Choose one of the following values from the appropriate column to specify the Ampere Interrupting Capacity of the circuit breakers:

120 Volt	277 Volt
10K	18K
22K	35K
65K	65K

Note: Consult Crestron Sales Support MCB options.

Door Option—Enter "ND" to omit the local control access door. (The circuit breaker door cannot be omitted).

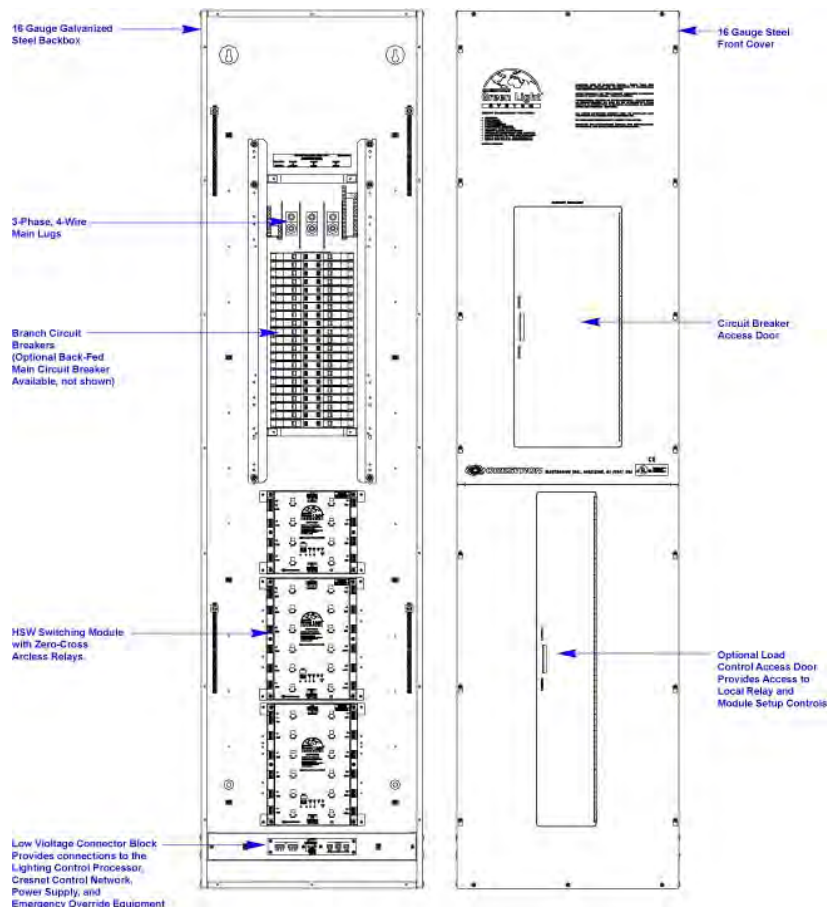

GLPS-HSW (Continued)

SPECIFICATIONSLoad Ratings

Switch Channels: 8 to 42 depending upon panel size and options, each channel phase-independent
 Maximum per Channel: 16 Amps @ 100 to 277 Volts AC, 50/60 Hz; 1/2 HP @ 120 Volts, 1 HP @ 277 Volts
 Switched Load Types: Incandescent, Magnetic Low-Voltage, Electronic Low-Voltage, Neon/Cold Cathode, Fluorescent Lamp Ballast, High-Intensity Discharge, Motors
 Dimmed Load Types (special order): 0-10 Volt 4-Wire Dimmable Fluorescent Ballast
 Rated Relay Lifetime: 1,000,000 cycles at full rated electronic ballast load

Input Power

Line Power: 120/208 VAC, 225 Amps maximum, 50/60 Hz phase-to-neutral, or 277/480 VAC, 250 Amps maximum, 50/60 Hz phase-to-neutral
 Cresnet Power Usage (optional): 50 Watts (2.08 Amps @ 24 Volts DC) per panel, use Crestron GLA-PWS50 or equivalent power supply

Circuit Breakers

Branch, 120V: 20A Square D® QOB Bolt-on type; 10k, 22k, or 65k AIC rated as required
 Branch, 277V: 20A Square D® EDB, EGB, EJB E-Frame type; 18k, 35k, or 65k AIC rated as required
 Main, 120/208V (optional): 120/208V: 60A, 80A, or 100A Square D® QOB Bolt-on type; 10k AIC rated (consult Crestron for additional options)
 Main, 277/480V (optional): 60A, 80A, 100A, or 125A Square D® EDB, EGB, EJB E-Frame type; 18k, 35k, or 65k AIC rated

Lightning Protection

Can withstand 6 kV / 3 kA surge, as per IEC 61000-4-5 and ANSI/IEEE C62.41-1991

Enclosure

NEMA Type 1, IP20 rated protection, for indoor use only
 Back Box: 16 Gauge galvanized steel, surface wall mount
 Front Cover: 16 Gauge steel, grey powder coat finish

Environmental

Temperature: 32° to 104°F (0° to 40°C)
 Humidity: 10% to 90% RH (non-condensing)

Small: 37-1/2 x 20-1/4 x 6-5/8 in (95.25 x 51.4 x 16.8 cm) HWD
 Medium: 70 x 20-1/4 x 6-5/8 in (177.8 x 51.4 x 16.8 cm) HWD
 Large: 78-15/16 x 20-1/4 x 6-5/8 in (200.5 x 51.4 x 16.8 cm) HWD
 Extra Large: 90 x 20-1/4 x 6-5/8 in (228.6 x 51.4 x 16.8 cm) HWD

Weight

Fully loaded with modules, 277V circuit breakers, and wiring:
 Small: 70 lb (31.8 kg) maximum
 Medium: 140 lb (63.5 kg) maximum
 Large: 165 lb (74.9 kg) maximum
 Extra Large: 181 lb (82.1 kg) maximum

Testing & Compliance

UL Listed, FCC Part 15

Feed Wiring – 120/208V

Neutral and Main Lugs:
 10-2/0 AWG (CU)
 6-2/0 AWG (AL)
 6-300 kcmil (CU or AL)

Neutral Bus:

14-4 AWG (CU)
 12-4 AWG (AL)

Feed Wiring – 277/480V

Neutral and Main Lugs:
 6-350 kcmil (CU or AL)
 1/0-750 kcmil (CU or AL)

Neutral Bus:

14-6 AWG (CU or AL)
 14-2/0 AWG (CU or AL)

Load Wiring

Load Outputs: 14-10 AWG
 0-10V Dim Outputs: 28-12 AWG
 Ground Bar: 14-10 AWG
 Ground Lug: 14-4 AWG

Notes:

- For Feed wiring, use copper or aluminum conductors only.
- For Load wiring, use copper conductors only.
- All wiring rated 75 °C

GLPS-SW Green Light Power Switching Panels (MLO) Main Lug Only and (MCB) Main Circuit Breaker w/Standard High-Inrush Relays



The GLPS-SW Power Switching Panels come standard with 20A branch circuit breakers, and accept 208Y/120 or 480Y/277 volt feeds terminating to main lugs provided. An optional back-fed main circuit breaker may also be specified.

Three panel sizes are available, "Small," "Medium," and "Large." The panel size is ordinarily determined according to the number of control circuits specified, ranging from 8 to 42 circuits per panel. Each control circuit is rated for 16A at 100-277V.

The GLPS-SW panels utilize robust 50A relays to handle all types of lighting loads including electronic ballasts, as well as motors up to 2 HP.

As an option, GLPS-SW panels may be equipped with 0-10V fluorescent dimming control substituted in place of some or all switching circuits. Consult Crestron Sales Support Services to specify this option.

The GLPS-SW panels employ field-replaceable lighting control modules, with 10 or 16 control circuits per module, for excellent configurability and service-ability. Each module includes local relay controls and load state indicators for each circuit, plus additional controls and indicators for use during system commissioning.

Individual hinged doors are provided on the front of each GLPS-SW panel for access to the circuit breaker panelboard and the local controls on each module. As an option, the local control access door may be omitted.

As part of a complete Green Light system, GLPS-SW panels connect to an IPAC-GL1 lighting control processor (or other 2-Series control system) via the Cresnet control network. An optional GLA-PWS50 (or equivalent) power supply is also recommended for each panel to provide backup power to the lighting modules.

Remote emergency override mode allows the lighting system program to be overridden while each circuit is set to an override preset state. The override preset for each circuit is set using the local controls on the front of each lighting module. Remote override mode is activated by an external contact closure from a Crestron GLS-PLS-120/277 power loss sensor or other devices.

All low-voltage connections to a GLPS-SW panel are made via a connector block located near the bottom of the panel. Connections are provided for Cresnet communications, backup power supply, and emergency override. Crestron Green Light Power Switching panels are configured to order, and factory assembled and tested prior to shipping. Each panel is engineered to provide a clean and manageable installation with abundant provisions for wire termination and conduit knockouts. On-site installation is fast and easy with all termination points clearly labeled and accessible from the front.

MODEL NUMBERS

Specifying and ordering a Crestron Green Light Power Switching panel is facilitated using the following model number system. Simply fill in the appropriate entry in each position according to the steps that follow:

GLPS - SW - MLO - 30 - 120 - 10K - ND
 GLPS-Relay Type-Feed Type-Number of Ckts-Voltage-AIC Rating-Door Option

The above example is for a "Main Lug Only" panel with 30 "SW" standard high-inrush relays, 120V / 10kAIC circuit breakers, and no local control access door.

Relay Type: Enter "SW" to specify standard high-inrush switching relays.

Note: For other relay types, refer to the Selection Guide

0-10V fluorescent dimming is also available. Consult Crestron Sales Support Services to specify this option.

Feed Type: Choose one of the following to specify the type of feed:

MLO		Main lug only
MCB60		60A back-fed main circuit breaker
MCB80		80A back-fed main circuit breaker
MCB	100	100A back-fed main circuit breaker
MCB	125	125A back-fed main circuit breaker
		(available for 277V only)

Note: Main feeds are 3-phase, 4-wire; rated 225A @ 120/208V or 250A @ 277/480V. Consult Crestron Sales

Support Services for 400A feed and other main circuit breaker options.

Number of Circuits: Choose one of the following numeric values from the appropriate column to specify the number of controlled circuits in the panel:

	GLPS-SW-MLO	GLPS-SW-MCB
Small:	10, 16	10, 15
Medium:	20, 26, 30	20, 26, 27
Large:	32, 36, 40, 42	32, 36, 39

Note: "Small," "Medium," and "Large" refer to the default panel size per number of circuits. Consult Crestron Sales Support Services for alternate configurations.

Voltage: To specify the circuit breaker voltage, enter "120" for 120/208V or "277" for 277/480V.

AIC Rating: Choose one of the following values from the appropriate column to specify the Ampere Interrupting Capacity of the circuit breakers:

120 Volt	277 Volt (
10K	18K
22K	35K
65K	65K

Note: Consult Crestron Sales Support Services MCB options.

Door Option—Enter "ND" to omit the local control access door. (The circuit breaker door cannot be omitted.)

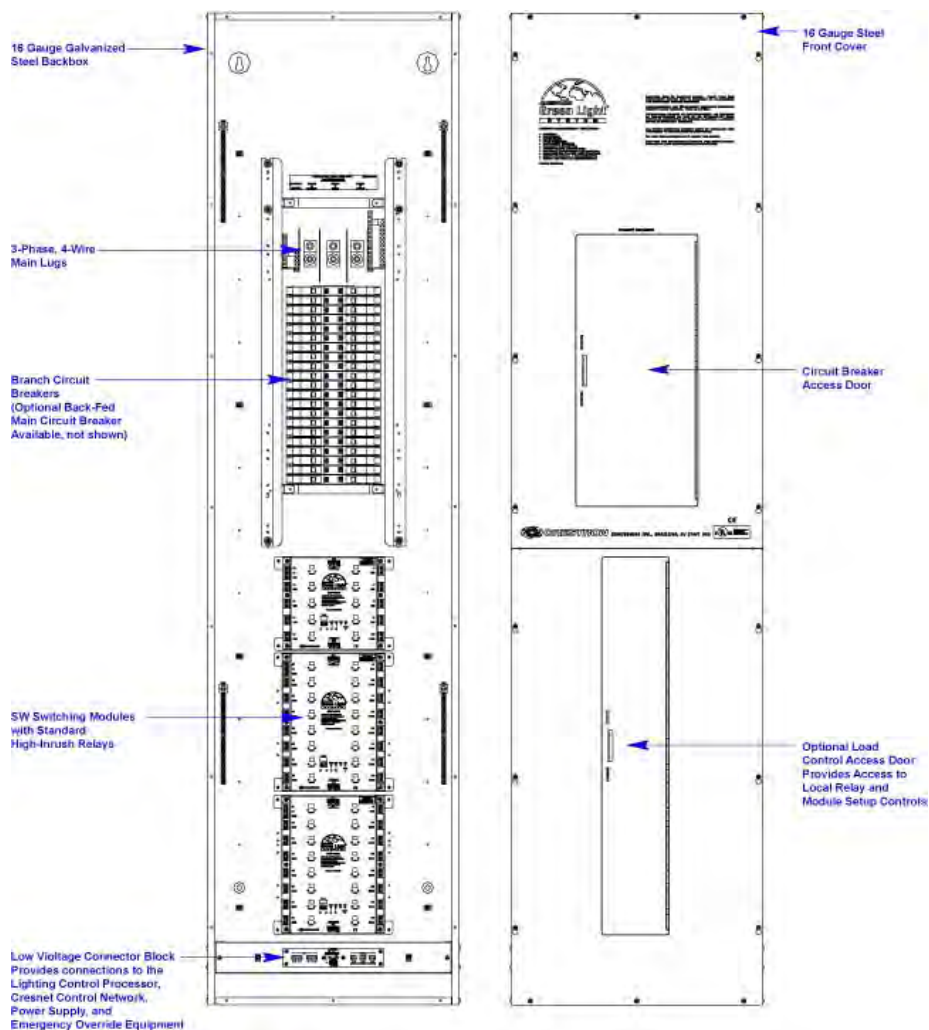

GLPS-SW (CONTINUED)

SPECIFICATIONS**Load Ratings**

Switch Channels: 10 to 42 depending upon panel size and options, each channel

phase-independent

Maximum per Channel: 16 Amps @ 100 to 277 Volts AC, 50/60 Hz; 1 HP @ 120 Volts, 2 HP @ 277 Volts

Switched Load Types: Incandescent, Magnetic Low-Voltage, Electronic Low-Voltage, Neon/Cold Cathode, Fluorescent Lamp Ballast, High-Intensity Discharge, Motors

Dimmed Load Types (special order): 0-10 Volt 4-Wire

Dimmable Fluorescent Ballast

Rated Relay Lifetime: 10,000 cycles at full rated electronic ballast load

Input Power

Line Power: 120/208 VAC, 225 Amps maximum, 50/60 Hz phase-to-neutral, or 277/480 VAC, 250 Amps maximum, 50/60 Hz phase-to-neutral

Cresnet Power Usage (optional): 50 Watts (2.08 Amps @ 24 Volts DC) per panel, use Crestron GLA-PWS50 or equivalent power supply

Circuit Breakers

Branch, 120V: 20A Square D® QOB Bolt-on type; 10k, 22k, or 65k AIC rated as required

Branch, 277V: 20A Square D® EDB, EGB, EJB E-Frame type; 18k, 35k, or 65k AIC rated as required

Main, 120/208V (optional): 120/208V: 60A, 80A, or 100A Square D® QOB Bolt-on type; 10k AIC rated (consult Crestron for additional options)

Main, 277/480V (optional): 60A, 80A, 100A, or 125A Square D® EDB, EGB,

EJB E-Frame type; 18k, 35k, or 65k AIC rated

Lightning Protection

Can withstand 6 kV / 3 kA surge, as per IEC 61000-4-5 and ANSI/IEEE C62.41-1991

Enclosure

NEMA Type 1, IP20 rated protection, for indoor use only

Back Box: 16 Gauge galvanized steel, surface wall mount

Front Cover: 16 Gauge steel, grey powder coat finish

Environmental

Temperature: 32° to 104°F (0° to 40°C)

Humidity: 10% to 90% RH (non-condensing)

Dimensions

Small: 37-1/2 x 20-1/4 x 6-5/8 in (95.25 x 51.4 x 16.8 cm)

HWD

Medium: 70 x 20-1/4 x 6-5/8 in (177.8 x 51.4 x 16.8 cm)

HWD

Large: 78-15/16 x 20-1/4 x 6-5/8 in (200.5 x 51.4 x 16.8 cm)

HWD

Weight

Fully loaded with modules, 277V circuit breakers, and wiring:

Small: 70 lb (31.8 kg) maximum

Medium: 140 lb (63.5 kg) maximum

Large: 165 lb (74.9 kg) maximum

Testing & Compliance

UL Listed, FCC Part 15

GLPS-HSW-FT Green Light Express Feed-Through Power Switching Panels w/Zero-Cross Arcless Relays

The GLPS-HSW-FT panels utilize Crestron zero-cross arcless relay technology, achieving a relay lifetime of one million cycles. A high-current triac is employed to handle the high inrush current turn on, especially with certain load types such as HID and electronic ballasts. Within milliseconds, the continuous load is transferred to a robust 50A mechanically-latching relay. All switching occurs at the zero-cross point of the AC waveform under microprocessor control. This is a complete solution, eliminating arcing at the physical relay contacts during turn on and turn off, and supports switching of all types of lighting loads up to 16A at 100V to 277V, as well as motors up to 1 HP.

As an option, GLPS-HSW-FT panels may be equipped with 0-10V fluorescent dimming control substituted in place of some or all switching circuits. Consult Crestron Sales Support Services to specify this option.

The GLPS-HSW-FT panels employ field-replaceable lighting control modules, with 8 or 12 control circuits per module, for excellent configurability and serviceability. Each module includes local relay controls and load state indicators for each circuit, plus additional controls and indicators for use during system commissioning.

As part of a complete Green Light system, GLPS-HSW-FT panels connect to an IPAC-GL1 lighting control processor (or other 2-Series Control System) via the Cresnet control network. An optional GLA-PWS50 (or equivalent) power supply is also recommended for each panel to provide backup power to the lighting modules.

Remote emergency override mode allows the lighting system program to be overridden while each circuit is set to an override preset state. The override preset for each circuit is set using the local controls on the front of each lighting module. Remote override mode is activated by an external contact closure from a Crestron GLS-PLS-120/277 power loss sensor or other devices

All low-voltage connections to a GLPS-HSW-FT panel are made via a connector block located near the bottom of the panel. Connections are provided for Cresnet communications, backup power supply, and emergency override.

Crestron Green Light Express Power Switching panels are configured to order, and factory assembled and tested prior to shipping. Each panel is engineered to provide a clean and

manageable installation with abundant provisions for wire termination and conduit knockouts. On-site installation is fast and easy with all termination points clearly labeled and accessible from the front.

MODEL NUMBERS

Specifying and ordering a Crestron Green Light Express Power Switching panel is facilitated using the following model number system. Simply fill in the appropriate entry in each position according to the steps that follow:

GLPS - HSW - FT - 32

GLPS – Relay Type – Feed Type – Number of Ckts.

The above example is for a “Feed-Through” panel with 32 “HSW” zero-cross arcless relays.

Relay Type: Enter “HSW” to specify zero-cross arcless switching relays.

Notes: For other relay types, refer to the Selection Guide

0-10V fluorescent dimming is also available. Consult Crestron Sales Support Services to specify this option.

Feed Type: Enter “FT” to specify “Feed-Through.”

Note: For other feed types, refer to the Selection Guide

Number of Circuits: Choose one of the following numeric values to specify the number of controlled circuits in the Panel:

Small: 8, 12, 16

Large: 20, 24, 28, 32

Note: “Small” and “Large” refer to the default panel size per number of circuits. Consult Crestron Sales Support Services for alternate configurations.

GLPS-HSW-FT (Continued)

SPECIFICATIONS**Load Ratings**

Switch Channels: 8 to 32 depending upon panel size and options, each channel phase-independent

Maximum per Channel: 16 Amps @ 100 to 277 Volts AC, 50/60 Hz; 1/2 HP @ 120 Volts, 1 HP @ 277 Volts

Switched Load Types: Incandescent, Magnetic Low-Voltage, Electronic Low-Voltage, Neon/Cold Cathode, Fluorescent Lamp Ballast, High-Intensity Discharge, Motors

Dimmed Load Types (special order): 0-10 Volt 4-Wire

Dimmable Fluorescent Ballast

Rated Relay Lifetime: 1,000,000 cycles at full rated electronic ballast load

Input Power

Line Power: 120 or 277 VAC, 20 Amps maximum per circuit, 50/60 Hz

Cresnet Power Usage (optional): 50 Watts (2.08 Amps @ 24 Volts DC) per panel, use Crestron GLA-PWS50 or equivalent power supply

Lightning Protection

Can withstand 6 kV / 3 kA surge, as per IEC 61000-4-5 and ANSI/IEEE C62.41-1991

Enclosure

NEMA Type 1, IP20 rated protection, for indoor use only

Back Box: 16 Gauge galvanized steel, flush or surface wall mount

Front Cover: 16 Gauge steel, grey powder coat finish

Environmental

Temperature: 32° to 104°F (0° to 40°C)

Humidity: 10% to 90% RH (non-condensing)

Dimensions

Small: 23-1/2 x 14-3/8 x 4 in (59.7 x 36.5 x 10.2 cm) HWD

Large: 38-1/4 x 14-3/8 x 4 in (97.2 x 36.5 x 10.2 cm) HWD

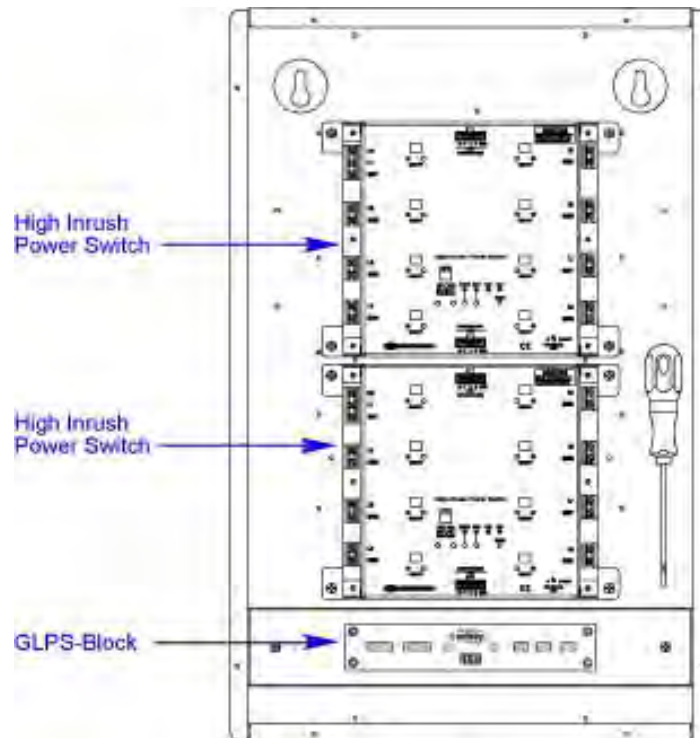

GLPS-SW-FT Green Light Express Feed-Through Power Switching Panels w/Standard High-Inrush Relays

The GLPS-SW-FT Power Switching Panels are designed for use with a separate circuit breaker panel. Two "feed-through" panel sizes are available, configurable with as few as 8, or as many as 56 control circuits per panel. Each control circuit is rated for 16A at 100-277V. Panels may be deployed with a mix of 120V and 277V circuits within a single cabinet.

The GLPS-SW-FT panels utilize robust 50A relays to handle all types of lighting loads including electronic ballasts, as well as motors up to 2 HP.

The GLPS-SW-FT panels employ field-replaceable lighting control modules, with 8 control circuits per module, for excellent configurability and serviceability. Each module includes local relay controls and load state indicators for each circuit.

As part of a complete Green Light system, GLPS-SW-FT panels connect to an IPAC-GL1 lighting control processor (or other 2-Series control system) via the Cresnet control network. A GLA-PWS50 (or equivalent) power supply is also required for each panel to provide operating power to the lighting modules.

Remote emergency override mode allows the lighting system program to be overridden while each circuit is set to an override preset state. The override preset for each circuit is set using the local controls on the front of each lighting module. Remote override mode is activated by an external contact closure from a Crestron GLS-PLS-120/277 power loss sensor or other devices.

All low-voltage connections to a GLPS-SW-FT panel are made via a connector block located near the bottom of the panel. Connections are provided for Cresnet communications, power supply, and emergency override.

Crestron Green Light Express Power Switching panels are configured to order, and factory assembled and tested prior to shipping. Each panel is engineered to provide a clean and manageable installation with abundant provisions for wire termination and conduit knockouts. On-site installation is fast and easy with all termination points clearly labeled and accessible from the front.

MODEL NUMBERS

Specifying and ordering a Crestron Green Light Express Power Switching panel is facilitated using the following model number system. Simply fill in the appropriate entry in each position according to the steps that follow:

GLPS - SW - FT - 56

GLPS – Relay Type – Feed Type – Number of Ckts.

The above example is for a "Feed-Through" panel with 56 "SW" standard high-inrush relays.

Relay Type: Enter "SW" to specify standard high-inrush switching relays.

Note: For other relay types, refer to the Selection Guide on Page 3.

Feed Type: Enter "FT" to specify "Feed-Through."

Note: For other feed types, refer to the Selection Guide on Page 3.

Number of Circuits: Choose one of the following numeric values to specify the number of controlled circuits in the panel:

Small: 8, 16, 24

Large: 32, 40, 48, 56

Note: "Small" and "Large" refer to the default panel size per number of circuits. Consult Crestron Sales Support Services for alternate configurations.

GLPS-SW-FT (Continued)

SPECIFICATIONS**Load Ratings**

Switch Channels: 8 to 56 depending upon panel size and options, each channel phase-independent
 Maximum per Channel: 16 Amps @ 100 to 277 Volts AC, 50/60 Hz; 1 HP @ 120 Volts, 2 HP @ 277 Volts
 Switched Load Types: Incandescent, Magnetic Low-Voltage, Electronic Low-Voltage, Neon/Cold Cathode, Fluorescent Lamp Ballast, High-Intensity Discharge, Motors
 Dimmed Load Types (special order): 0-10 Volt 4-Wire Dimmable Fluorescent Ballast
 Rated Relay Lifetime: ,10,000 cycles at full rated electronic ballast load

Input Power

Line Power: 120 or 277 VAC, 20 Amps maximum per circuit, 50/60 Hz
 Cresnet Power Usage: 50 Watts (2.08 Amps @ 24 Volts DC) per panel, use Crestron GLA-PWS50 or equivalent power supply

Lightning Protection

Can withstand 6 kV / 3 kA surge, as per IEC 61000-4-5 and ANSI/IEEE C62.41-1991

Enclosure

NEMA Type 1, IP20 rated protection, for indoor use only
 Back Box: 16 Gauge galvanized steel, flush or surface wall mount
 Front Cover: 16 Gauge steel, grey powder coat finish

Environmental

Temperature: 32° to 104°F (0° to 40°C)
 Humidity: 10% to 90% RH (non-condensing)

Dimensions

Small: 23-1/2 x 14-3/8 x 4 in (59.7 x 36.5 x 10.2 cm) HWD
 Large: 38-1/4 x 14-3/8 x 4 in (97.2 x 36.5 x 10.2 cm) HWD

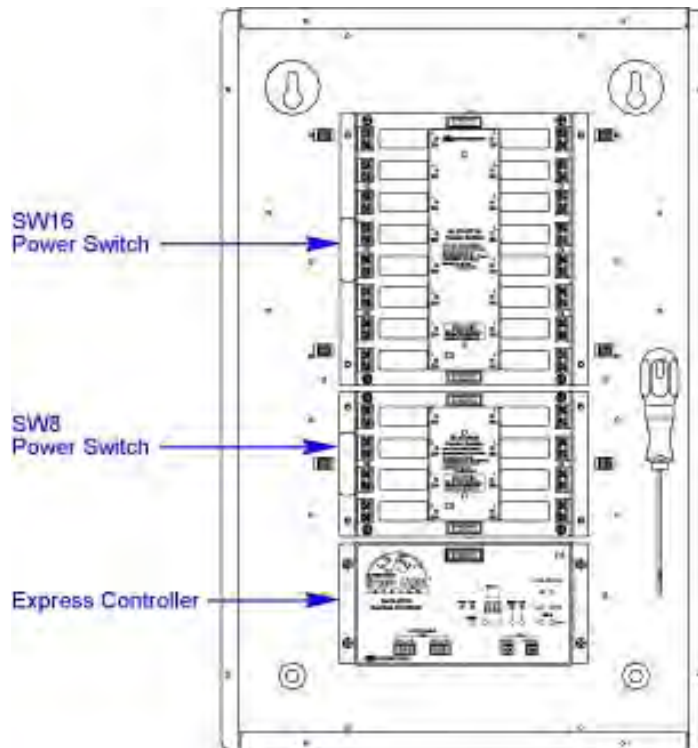

GLPS-HDSW-FT

Green Light Express Feed-Through Power Switching Panels w/Modular High-Inrush Relays

The GLPS-HDSW-FT Power Switching Panels are designed for use with a separate circuit breaker panel. Two "feed-through" panel sizes are available, configurable with as few as 8, or as many as 56 control circuits per panel.

The GLPS-HDSW-FT panels utilize individual, field-installable modular relays. Panels are specified according to the number of relay spaces. The relays are ordered separately. Each space accommodates one single-pole relay (Model# GLR-HD-1P). Allow 2 spaces for each double-pole relay (Model# GLR-HD-2P).

Each control circuit is rated for 20A, supporting 120V, 277V, and 347V lighting loads, as well as motors up to 2 HP. Panels may be deployed with a mix of different voltages within a single cabinet.

The GLPS-HDSW-FT panels include local relay controls and load state indicators for each circuit.

As part of a complete Green Light system, GLPS-HDSW-FT panels connect to an IPAC-GL1 lighting control processor (or other 2-Series control system) via the Cresnet control network. A GLA-PWS50 (or equivalent) power supply is also required for each panel to provide operating power.

Remote emergency override mode allows the lighting system program to be overridden while each circuit is set to an override preset state. The override preset for each circuit is set using the local relay controls. Remote override mode is activated by an external contact closure from a Crestron GLS-PLS-120/277 power loss sensor or other devices.

All low-voltage connections to a GLPS-HDSW-FT panel are made via a connector block located near the bottom of the panel. Connections are provided for Cresnet communications, power supply, and emergency override.

Crestron Green Light Express Power Switching panels are configured to order, and factory assembled and tested prior to shipping. Each panel is engineered to provide a clean and manageable installation with abundant provisions for wire termination and conduit knockouts. On-site installation is fast and easy with all termination points clearly labeled and accessible from the front.

MODEL NUMBERS

Specifying and ordering a Crestron Green Light Express Power Switching panel is facilitated using the following model number system. Simply fill in the appropriate entry in each position according to the steps that follow:

GLPS - HDSW - FT - 56

GLPS – Relay Type – Feed Type – Number of Ckts.

The above example is for a "Feed-Through" panel with 56 "HDSW" modular high-inrush relays.

Relay Type: Enter "HDSW" to specify modular high-inrush switching relays.

Note: For other relay types, refer to the Selection Guide

Feed Type: Enter "FT" to specify "Feed-Through."

Note: For other feed types, refer to the Selection Guide

Number of Circuits: Choose one of the following numeric values to specify the number of controlled circuits in the panel:

Small: 8, 16, 24

Large: 32, 40, 48, 56

Note: "Small" and "Large" refer to the default panel size per number of circuits. Consult Crestron Sales Support Services for alternate configurations.

"HDSW" relays must be ordered separately. Quantities shown indicate the number of available relay spaces. Each space accommodates one single-pole relay (Model# GLR-HD-1P). Allow 2 spaces for each double-pole relay (Model# GLR-HD-2P).

GLPS-HDSW-FT (Continued)

SPECIFICATIONS**Load Ratings**

Switch Channels: 8 to 56 single-pole, 4-28 double-pole, depending upon panel size and relay combinations, each channel phase-independent

Maximum per Channel: 20 Amps @ 100 to 347 Volts AC, 50/60 Hz; 1/2 HP @ 120 Volts, 1-1/2 HP @ 277 Volts

Switched Load Types: Incandescent, Magnetic Low-Voltage, Electronic Low-Voltage, Neon/Cold Cathode, Fluorescent Lamp Ballast, High-Intensity Discharge, Motors

Dimmed Load Types (special order): 0-10 Volt 4-Wire

Dimmable Fluorescent Ballast

Rated Relay Lifetime: 30,000 cycles at full rated electronic ballast load

Input Power

Line Power: 120, 277, or 347 VAC, 20 Amps maximum per circuit, 50/60 Hz

Cresnet Power Usage: 50 Watts (2.08 Amps @ 24 Volts DC) per panel, use Crestron GLA-PWS50 or equivalent power supply

Lightning Protection

Can withstand 6 kV / 3 kA surge, as per IEC 61000-4-5 and ANSI/IEEE C62.41-1991

Enclosure

NEMA Type 1, IP20 rated protection, for indoor use only

Back Box: 16 Gauge galvanized steel, flush or surface wall mount

Front Cover: 16 Gauge steel, grey powder coat finish

Environmental

Temperature: 32° to 104°F (0° to 40°C)

Humidity: 10% to 90% RH (non-condensing)

Dimensions

Small: 23-1/2 x 14-3/8 x 4 in (59.7 x 36.5 x 10.2 cm) HWD

Large: 38-1/4 x 14-3/8 x 4 in (97.2 x 36.5 x 10.2 cm) HWD

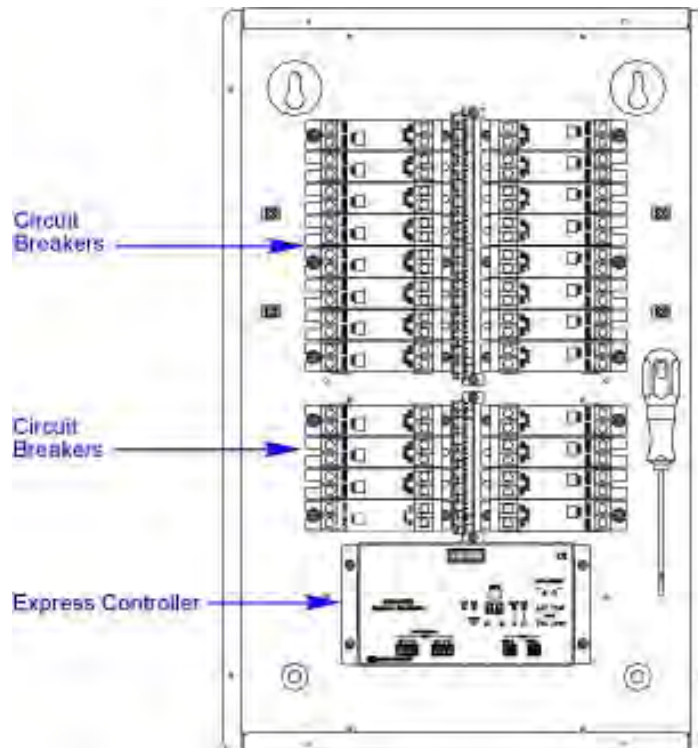

IPAC-GL1 Integrated Professional Automation Computer for Green Light Power Switching



- > Wall mount lighting control processor
- > Crestron 2-Series control engine
- > Easy system programming via LCD front panel
- > 7 programmable buttons with LED feedback
- > Customizable backlit button labels
- > CEC Title 24 listed
- > Astronomical time clock
- > Occupancy sensing and daylight harvesting
- > 2 RS-232, 4 digital/analog input, & 4 relay control ports
- > Cresnet and 10/100 Ethernet communications
- > Onboard e-Control® Web server
- > RoomView® and SNMP remote management
- > SSL (Secure Sockets Layer) network protection
- > Extensively programmable via PC software
- > 3-gang wall-mountable
- > Available in white or black

The Crestron IPAC is a 2-Series control processor designed for wall mount installation. Its front panel controls and LCD display deliver a user-friendly interface for out-of-the-box system setup. Built-in Ethernet, Cresnet, RS-232, relay, and sensor inputs provide direct connectivity for interfacing with all kinds of devices, controls, and networks. The onboard e-Control® Web server allows for complete integration as part of a facility-wide managed control network.

Out-of-the-Box Lighting Control—The GL1 version of IPAC comes preconfigured for use as the central control processor for a Green Light Power Switching system. Right out of the box, the IPAC-GL1 affords easy setup and programming for a complete switching system consisting of:

- Up to 210 switched circuits
- 16 keypads and 2 touchpanels
- 30 occupancy sensors and photocells
- 500 time clock events

Keypads with as many as 12 buttons each can be programmed easily to control lighting loads and zones. As well, the seven function buttons on the front panel of the IPAC-GL1 may also be programmed for lighting control or a variety of other common functions. Custom backlit labeling of these buttons is facilitated using an assortment of pre-printed labels or Crestron Engraver software.

Lights can be programmed to turn on and off automatically using the built-in astronomical time clock feature. Lighting events may be programmed to occur at specific times or at an offset from sunrise or sunset. Occupancy sensors and photocells may also be implemented to enable automatic on/off lighting control based on room occupancy and ambient light levels.

Custom programmability—with additional custom programming, the IPAC-GL1 can support virtually any functionality imaginable. It works seamlessly with the entire line of Crestron touchpanels, wireless remotes, lighting dimmers, shade controllers, thermostats, and more. It can also interface with third-party devices and systems such as security and access controls, surveillance cameras, and HVAC for a fully integrated solution. Contact Crestron Sales Support Services for more information.

The IPAC-GL1 is designed to be mounted in a standard 3-gang electrical box independent of the lighting panels, allowing it to be installed wherever it is most advantageous for the project.

IPAC-GL1 (Continued)

SPECIFICATIONS

Processor

CPU: 32-bit Freescale ColdFire® Microprocessor

Memory

SDRAM: 32 MB

NVRAM: 1 MB

Flash: 8 MB

Power Failure Memory: 10 years

Time Clock

Accuracy: ±1 minute per year

Operating System

Real-time, preemptive multi-threaded/multitasking kernel; FAT32 file system with long names; includes default program for Green Light Power Switching systems

Ethernet

10/100BaseT, auto-negotiating, full/half duplex, static IP or DHCP, DNS, SSL, TCP/IP, UDP/IP, CIP, SMTP, SNMP, built-in Web server and e-mail client; supports Crestron e-Control®2 XPanel and RoomView® applications

Control Ports

Cresnet: Cresnet port and 24 Volt DC power input with parallel pass-thru

LAN: 10/100BaseT Ethernet port w/link status and activity LED indicators

RS-232: (2) Bidirectional RS-232 ports

Up to 115.2k baud; software handshaking support

Hardware handshaking on COM 1 only

Relays: (4) normally open, isolated relays (every two share a common) Rated 1 Amp, 30 Volts AC/DC, MOV arc suppression across contacts

Inputs: (4) digital or analog input ports (referenced to GND)
 Digital Input: Rated for 0-24 Volts DC, input impedance 20k ohms, logic threshold 1.25 Volts DC;
 Analog Input: Rated for 0-10 Volts DC, protected to 24 Volts DC maximum, input impedance 20k ohms;
 Programmable 5 Volts, 2k ohms pull-up resistor per input

Computer: (1) USB 1.1 computer console port (behind front cover)

LCD Display

Green LCD dot matrix, 128 x 64 resolution, adjustable LED backlight

Power Requirements

Cresnet Power Usage: 5 Watts (0.21 Amps @ 24 Volts DC), use Crestron GLA-PWS50 or equivalent power supply

Environmental

Temperature: 32° to 104°F (0° to 40°C)

Humidity: 10% to 90% RH (non-condensing)

Enclosure

Faceplate: High-impact plastic, black or white, with polycarbonate label overlay

Chassis: Injection-molded plastic with steel mounting plate

Mounting: Requires 3-gang plaster ring or electrical box (2.5 inch deep recommended)

Testing & Compliance

UL Listed, FCC Part 15, CEC Title 24

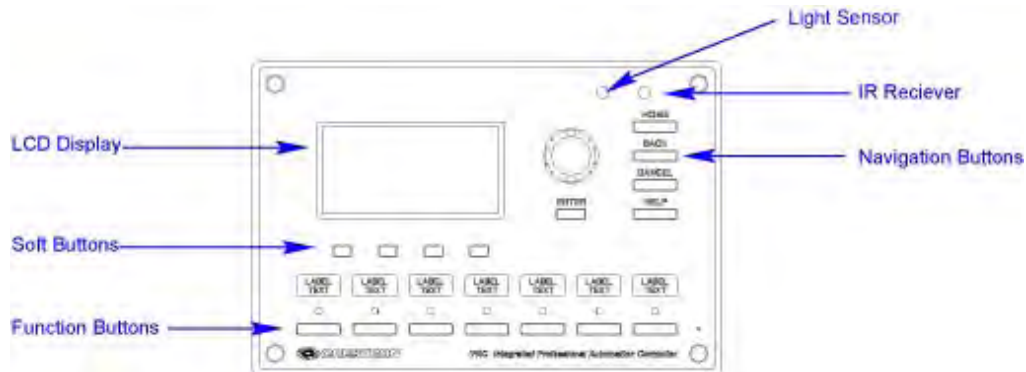

GLA-PWS50

Wall Mount 50 Watt Cresnet Power Supply



The GLA-PWS50 is a 50 watt Cresnet power supply designed for use with a Crestron Green Light system, or anywhere a wall-mountable Cresnet power supply is needed. The GLA-PWS50 mounts conveniently over a 4" square or 2-gang electrical box. All connections are made inside the electrical box via flying leads using wire nuts. A partition is included to isolate Class 1 from Class 2 wiring within the box.

- > 50 watt Cresnet power supply
- > Powers the IPAC and other Cresnet devices
- > Provides power for Crestron Green Light panels
- > Mounts to a 4" square or 2-gang electrical box

SPECIFICATIONS

Output Power

Output Power: 50 Watts (2.08 Amps) @ 24 Volts DC, regulated, limited power source
Ripple/Noise: <1%

Power Requirements

Line Power: 60 Watts @ 100-240 Volts AC, 50/60 Hz

Environmental

Temperature: 32° to 104°F (0° to 40°C)
Humidity: 10% to 90% RH (non-condensing)
Heat Dissipation: 26 BTU/hr

Enclosure

Metal construction, mounts to a 4-inch square or 2-gang electrical box, includes low-voltage partition

Testing & Compliance

UL Listed, FCC Part 15

GLS-PLS-

120/277 Power Loss Sensor



The GLS-PLS-120/277 is a 3-Phase Power Loss Sensor designed for use with Crestron Green Light™ systems to activate Override mode during a power failure. In response to a signal from the GLS-PLS-120/277, the lighting system program can be temporarily overridden while designated emergency lighting circuits are changed to their override preset levels and unnecessary lighting and other devices are shut down to minimize the demand on emergency power equipment.

The GLS-PLS-120/277 senses each leg of a 120 or 277 volt 3-phase feed, providing LED indication of the status of each phase on its front panel. When power is lost on any phase, the corresponding status LED turns off and a contact closure is activated on each of two control outputs. Two isolated control outputs are provided to allow for interfacing with third-party equipment in addition to the Crestron lighting system. Each contact closure output is rated for 1A @ 24VDC.

Testing the GLS-PLS-120/277 is facilitated using three test switches located behind a small cover plate on the front of the unit. Setting any switch to the TEST position simulates a loss of power on the corresponding phase leg, providing a test of the units' internal circuitry and any connected equipment.

The steel enclosure is designed for mounting to a vertical surface. Conduit knockouts are provided on the bottom, top, and both sides. All electrical connections are made via screw terminals accessed by removing the front panel.

- > Senses loss of power on each leg of a 3-phase feed
- > Used to satisfy UL 924 (Emergency Power Equipment) requirements
- > Works with 120 or 277 Volt feeds
- > Designed to activate the Override mode on Crestron lighting modules
- > Provides two isolated contact closure outputs
- > Each output rated 1A @ 24VDC
- > Includes built-in test function for each phase input
- > Surface mount enclosure includes conduit knockouts

SPECIFICATIONSInput Voltages

277V Voltage Range: 235 to 305 Volts AC, 50/60 Hz

120V Voltage Range: 102 to 132 Volts AC, 50/60 Hz

Connections

PHASE A, B, C: (3) Main feed sensing inputs, 277 or 120 Volts

OUTPUTS: (2) Form 'A' contact closures, electrically isolated. Both outputs close when main feed power is removed from any phase sensing input. Rated 1 Amp @ 24 Volts DC

Indicators & Controls

NORMAL A, B, C: (3) Green LEDs, each illuminates when corresponding test switch is

set to NORMAL and power is present at corresponding phase sensing input
TEST A, B, C: (3) Red LEDs, each illuminates when corresponding test switch is set to TEST and power is present at corresponding phase sensing input

Test Switches: (3) Slide switches behind cover plate, used to set each corresponding phase sensing input to TEST mode

Enclosure

Galvanized steel with polycarbonate label overlay; surface mount with integral mounting flanges top and bottom; 3/4" & 1/2" conduit knockouts top, bottom, and both sides

Environmental

Temperature: 32° to 104°F (0° to 40°C)

Humidity: 10% to 90% RH (non-condensing)

Heat Dissipation: 51 BTU/Hr

Dimensions

Height: 12.69 x 5.19 x 2.82 in (32.23 x 12.75 x 7.14 cm) HWD

Weight

3.7 lb (1.7 kg)

Dimensions

GLEP-HSW & GLEP-SW Small Panel

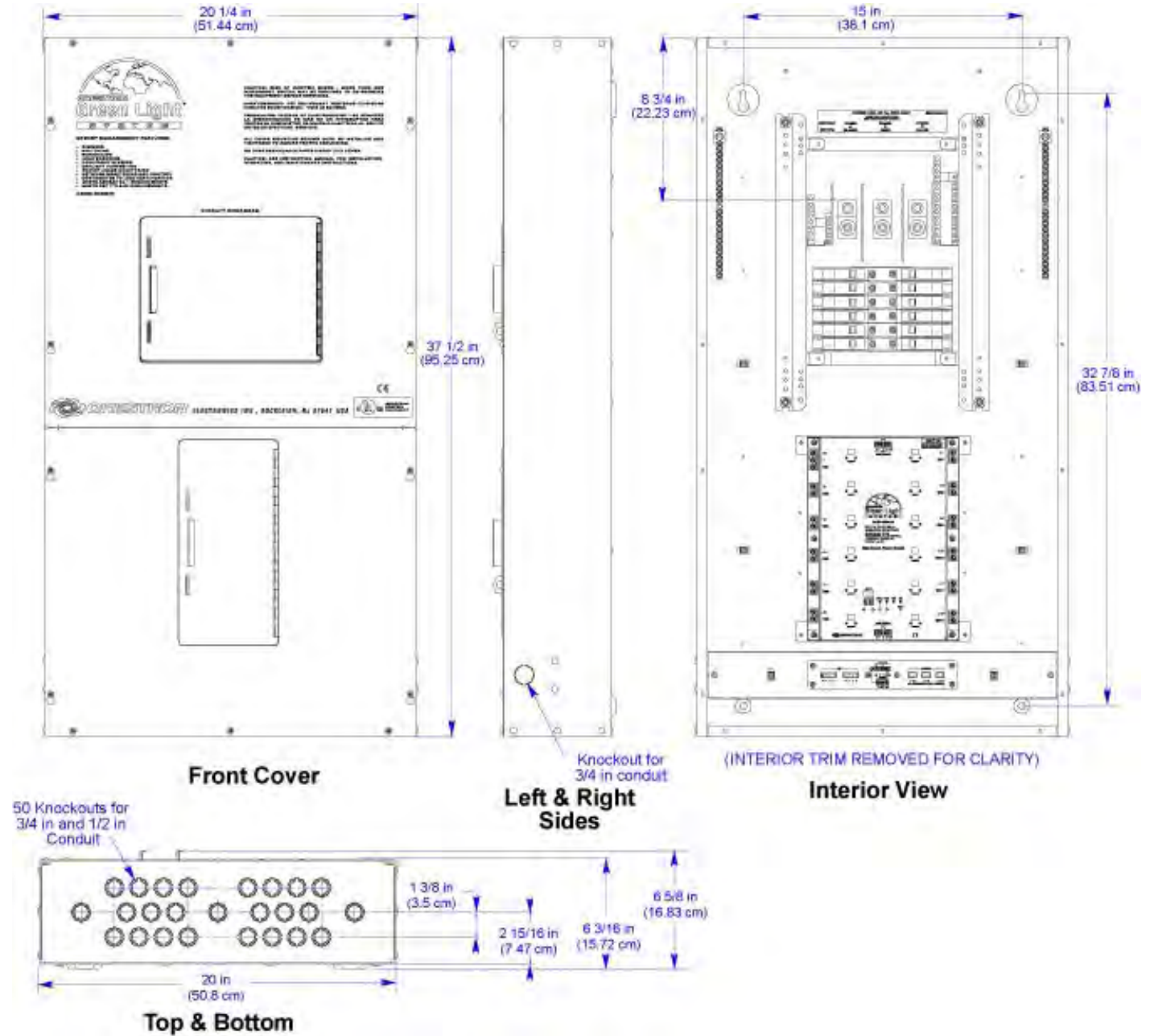

DIMENSIONS (continued)

GLEP-HSW & GLEP-SW Medium Panel

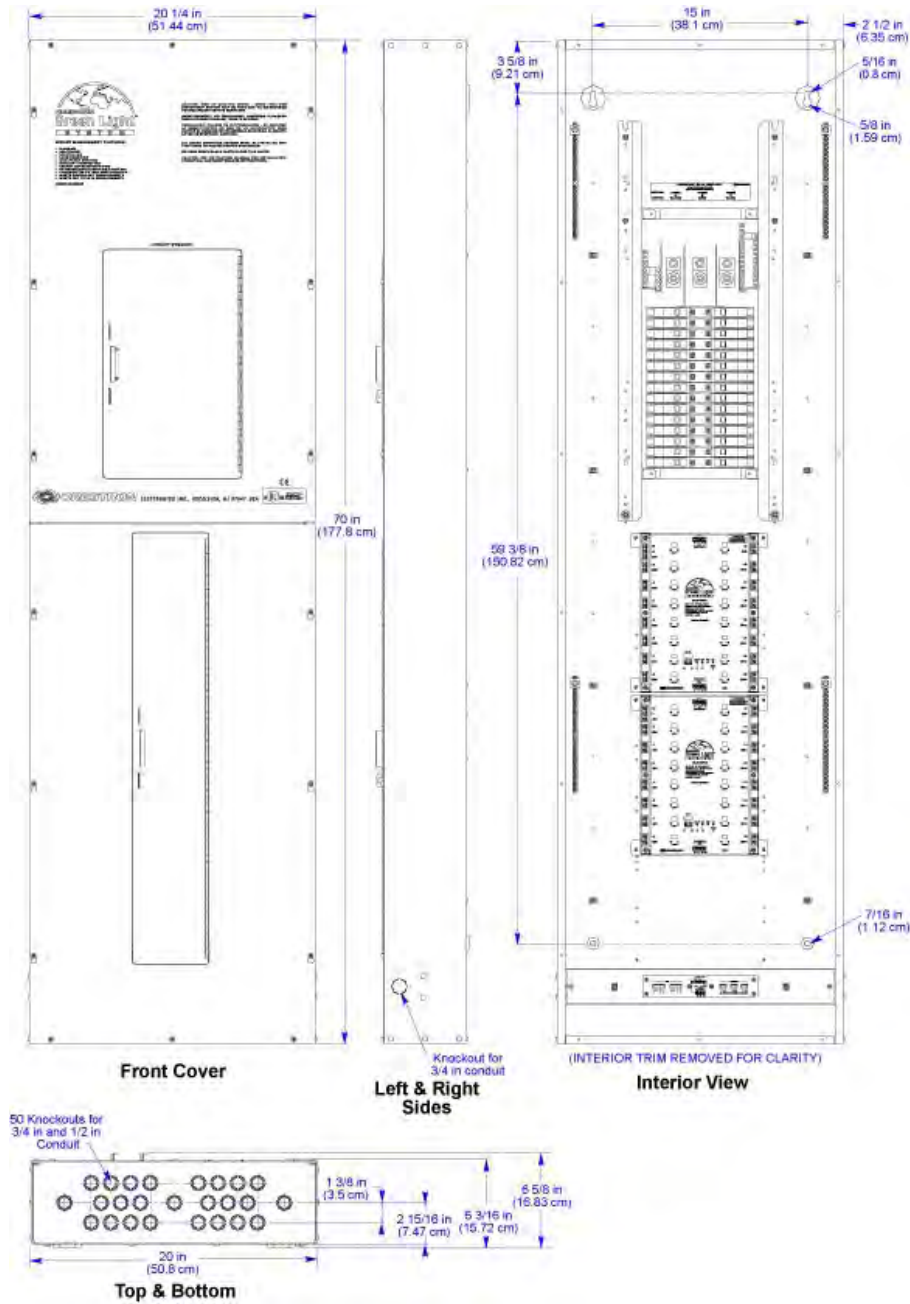

DIMENSIONS (continued)

GLEP-HSW & GLEP-SW Large Panel

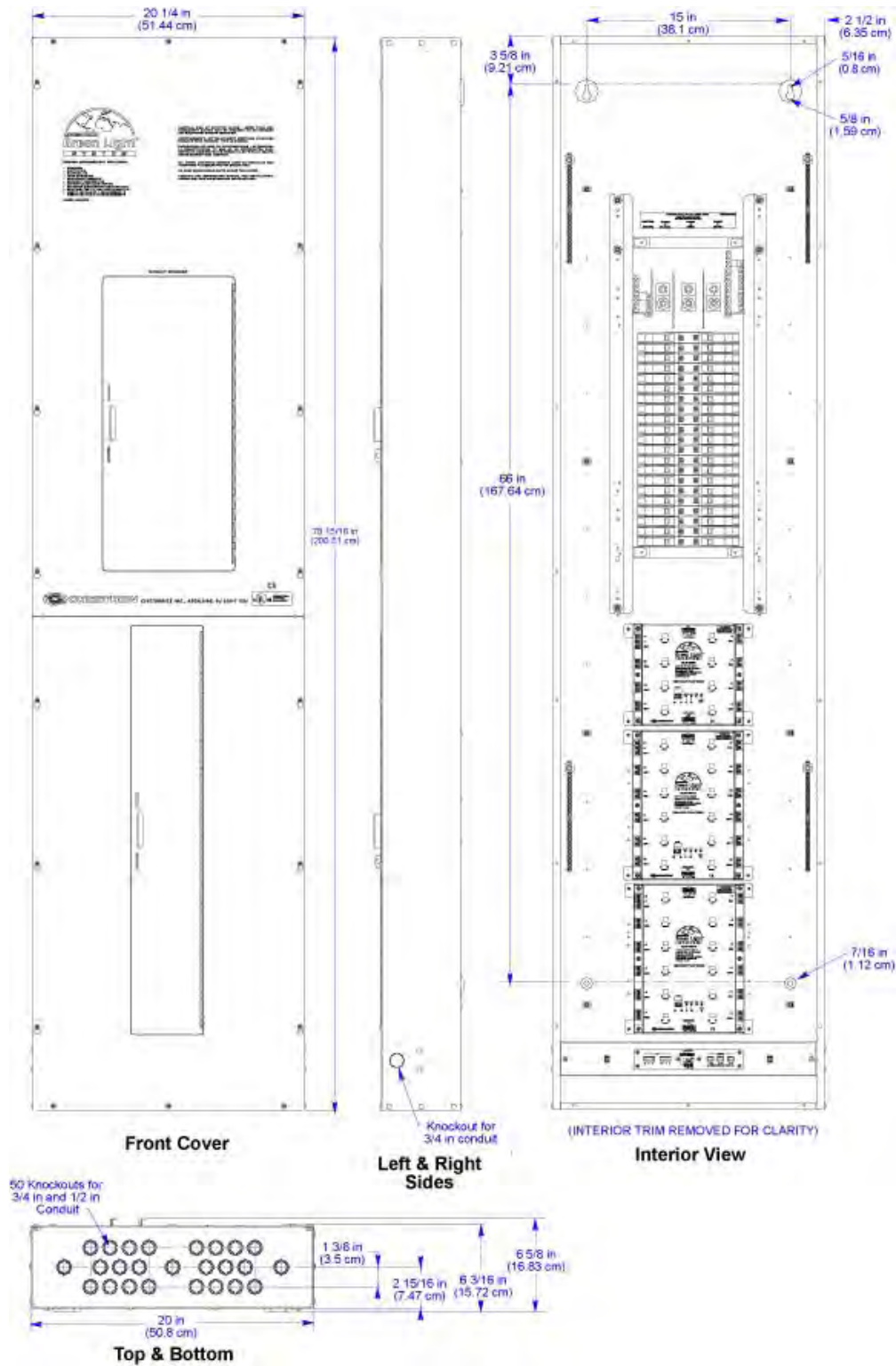

DIMENSIONS (continued)

GLEP-HSW & GLEP-SW Extra Large Panel

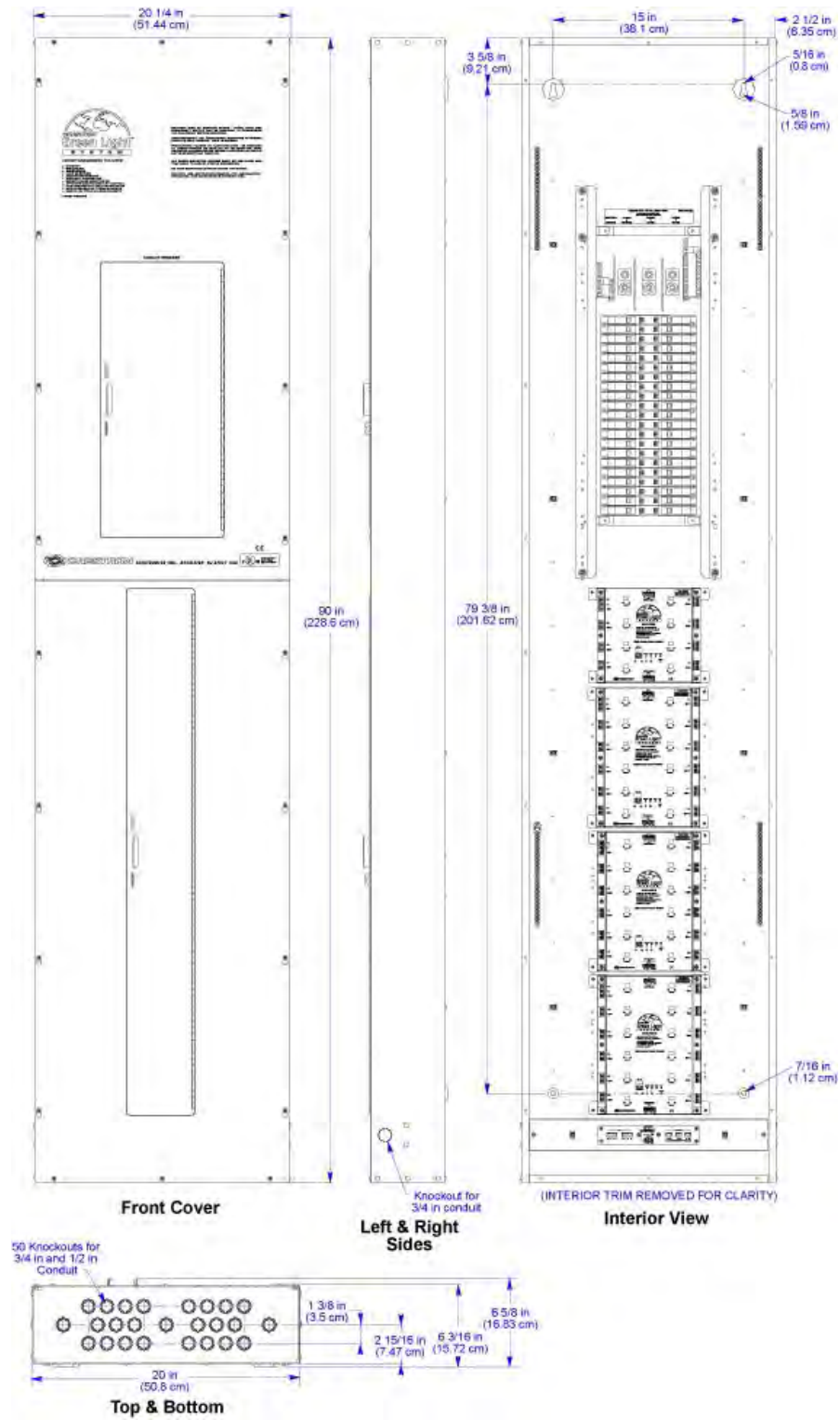

DIMENSIONS (continued)

GLEP-HSW-FT, GLEP-SW-FT, & GLEP-HDSW-FT Panels

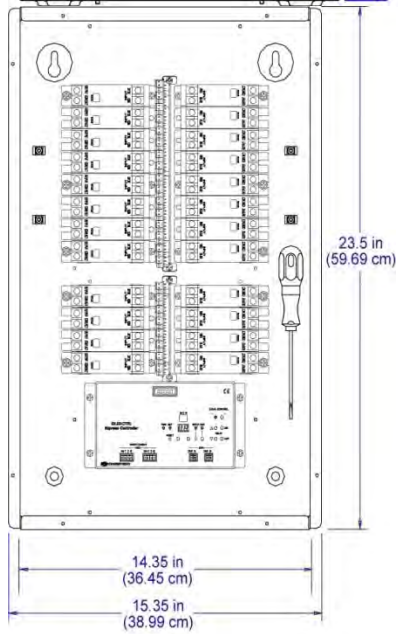
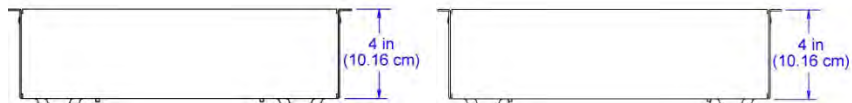
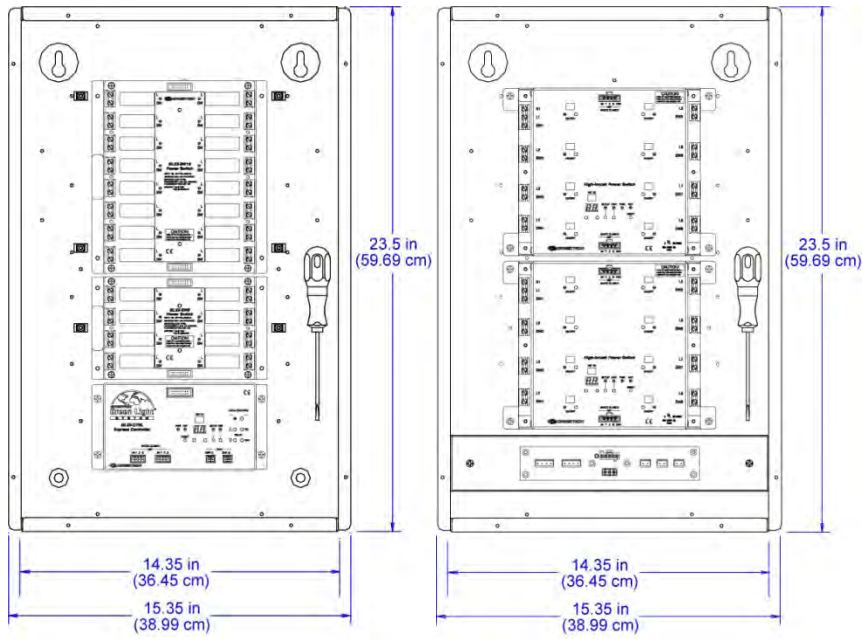

Dimensions (CONTINUED)
IPAC-GL1

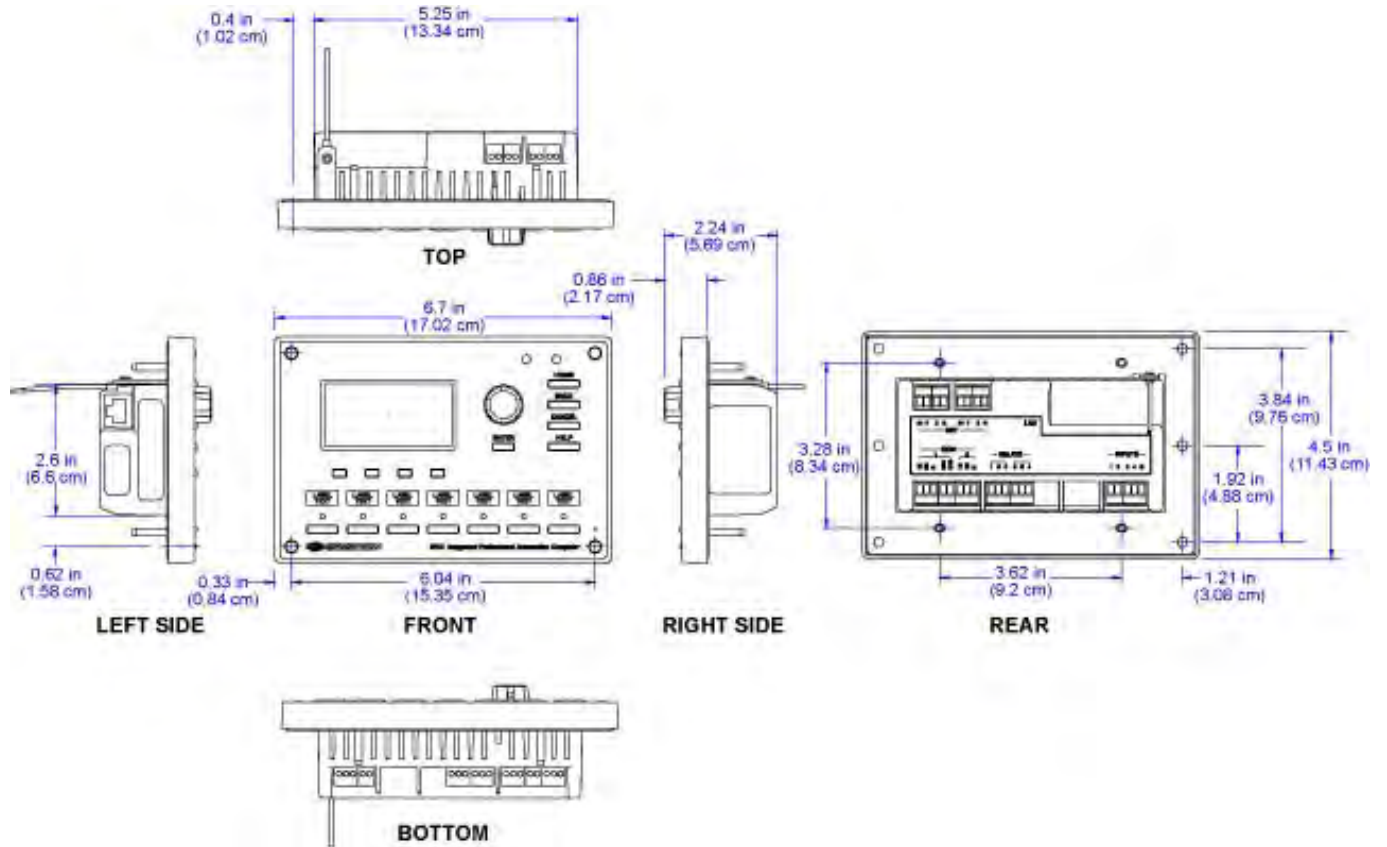

Green Light Options

CAEN- Series Enclosures

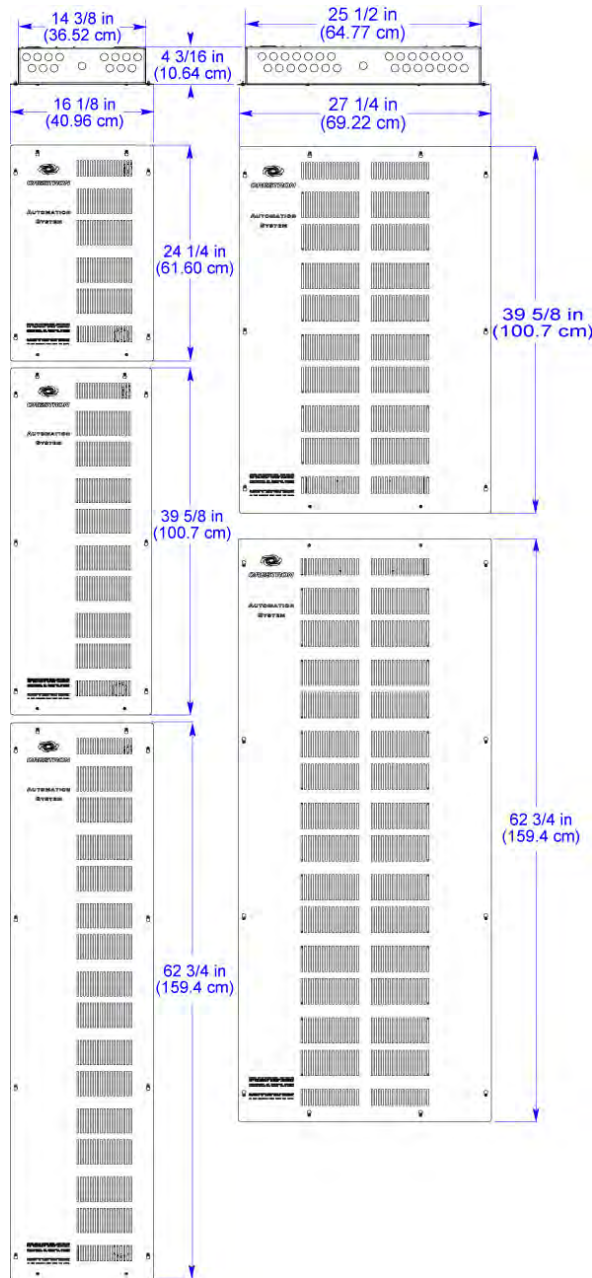

The CAEN Series automation enclosures are designed to house the Crestron CLX-series of lighting and motor control modules and [PAC2](#) or [PAC2M](#) control systems. CAEN enclosures are available in an assortment of sizes, suitable for surface or flush wall mount installation. Each model has been engineered to provide a clean and manageable installation with abundant provisions for wire termination and electrical knockouts.

CAEN automation enclosures are designed to use space efficiently by supporting over a hundred possible circuits in the largest model. Both centralized and distributed configurations are possible. A single PAC2 control system installed in a central enclosure can support numerous satellite extension enclosures distributed throughout a residence or commercial facility. Interconnection of the complete network of enclosures requires just one circulating Cresnet® cable. Dozens of keypads, touchpanels, wall box dimmers, shade controllers, and other peripherals can also be terminated within an enclosure, with separate compartments provided for high and low voltage wiring.

Crestron lighting and automation systems are completely convection cooled for silent and reliable operation. A vented front cover is included with every enclosure.

All models are constructed of 16-gauge galvanized steel and are pre-drilled for mounting of the PAC2, PAC2M, terminal blocks, CLX modules, CLT power supplies, and CAEN-BLOCK terminal block.

Additional non-CLX lighting modules and third-party contactors may be installed using CAEN-UMP Crestron universal mounting plates. Grounding blocks and low voltage partitions included.

CAEN enclosures are also well suited for all types of Class 2 and Class 3 applications including voice and data structured wiring, security, and RF signal distribution (as permitted by applicable codes).

CAEN enclosures are UL and C-UL listed. If you require a complete UL listed panel, Crestron offers this service through its UL508 listed panel shop, providing complete in-factory system configuration and assembly.

NOTE: The PAC2 occupies two module spaces in a double-wide enclosure and one module space in a single-wide.

NOTE: Four keyholes are located within the enclosure and should be used if surface mounting.

CAEN-Series Enclosure Specifications	CAEN Model				
	7X2*	7X1	4X2*	4X1	2X1
Module Capacity	14	7	8	4	2
Required Flush Mount Opening (Width) x (Height)	25 1/2" x 62"	14 3/8" x 62"	25 1/2" x 38 7/8"	14 3/8" x 38 7/8"	14 3/8" x 23 1/2"
Construction	16 gauge galvanized sheet metal Cover is painted metal with ventilation holes				
Regulatory Approvals	UL and C-UL listed				
Mounting	Surface or flush mounted *Double-width enclosures are either surface mounted or framed accordingly				

CAEN-Series Dimensions (Front and Side Views)

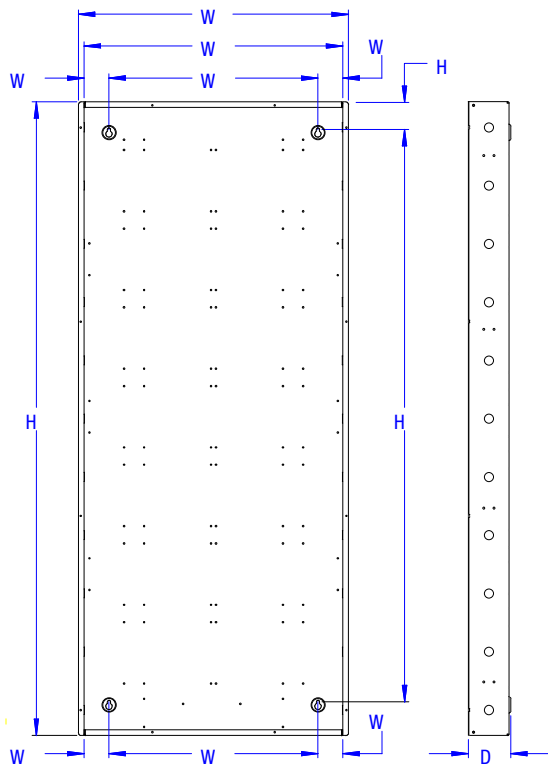

CAEN Dimensions ¹	7X2	7X1	4X2	4X1	2X1
H1	62		38 7/8		23 1/2
H2	2 11/16			2 1/8	
H3	56		32 7/8	34	18 5/8
W1	26 1/2	15 3/8	26 1/2	15 3/8	
W2	25 1/2	14 3/8	25 1/2	14 3/8	
W3	2 1/2	1 3/4	2 1/2	1 3/4	
W4	20 1/2	10 7/8	20 1/2	10 7/8	
W5 ⁵	20 1/2	9 7/8	20 1/2	9 7/8	
W6	2 1/2	2 3/4	2 1/2	2 3/4	
D1	4 1/8				
Cover Thickness	1/16				
Cover Height	62 3/4		39 5/8		24 1/4
Cover Width	27 1/4	16 1/8	27 1/4	16 1/8	
Weight ² Empty ³	65	42	43	28	19
Weight Full ⁴	155	88	95	55	31

1. Dimensions are in inches.
2. Weight is in pounds.
3. Weight Empty includes the cover.
4. Weight Full is with the maximum number of modules installed.
5. The lower keyholes are not symmetrically spaced in single-width enclosures.

CAEN Installation

In accordance with all national and local codes a licensed electrician must mount the enclosure. Special attention must be made to NEC Article 110.26(A)(2) concerning minimum work space requirements.

When choosing components to place in CAEN enclosures, refer to the table on the previous page to ensure that the maximum weight capacity is not exceeded. The weight of each module is listed on the product page on the Crestron website.

CAUTION: These enclosures house equipment that requires air cooling. Therefore, mount in a well-ventilated area. The ambient temperature range should be 32°F to 104°F (0°C to 40°C). The relative humidity should range from 0% to 90% (non-condensing). Furthermore,

CAEN Enclosure Framing

CAEN enclosures 2X1, 4X1, and 7X1 fit between standard wall stud spacing (16 inches on center).

CAEN 2X1, 4X1, and 7X1 Framing

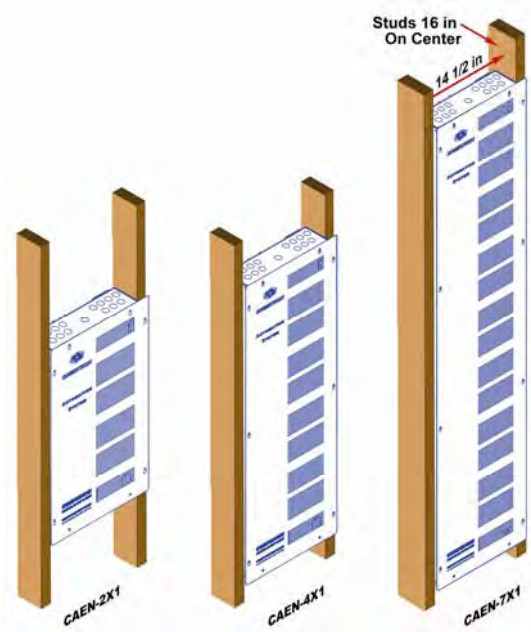

allow adequate clearance in front of the vented cover for servicing and ventilation.

NOTES: Unless otherwise indicated, the lighting system specified in this guide is modular, requiring assembly in the field by a licensed electrician in accordance with all national and local codes. If you require a UL listed panel, Crestron offers this service through its UL listed panel shop. This includes complete in-factory system configuration and assembly by Crestron for an additional fee. All commercial lighting systems include factory assembled, UL listed panels.

Install modules into the lowest available spaces and continue toward the top of the enclosure.

Enclosures are intended for indoor use only.

When flush mounting, 5/8" drywall is preferred.

CAEN enclosures 4X2 and 7x2 require framing modification. The weight of the enclosure rests on a sill plate, and does not distort the surrounding wallboard.

CAEN 4X2 Framing

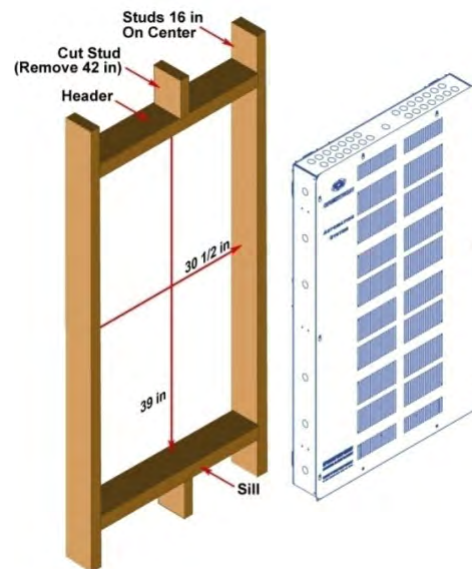

CAEN Wiring

CAUTION: All power feeds must be protected by 15 or 20 amp circuit breakers (supplied by others).

NOTES: Use copper conductors only – rated 75°C

All wiring must be installed in accordance with all local and national electrical codes.

Two snap bushings are supplied. If required, insert into knockouts at the bottom of the enclosure to prevent damage to low voltage wiring.

Class 2 field wires must be kept separate. Refer to the illustration showing singlewide and doublewide wiring details. Areas for high voltage (Class 1) wiring are shown along the top and side(s) of the unit. The lower area is reserved for low voltage (Class 2) wiring.

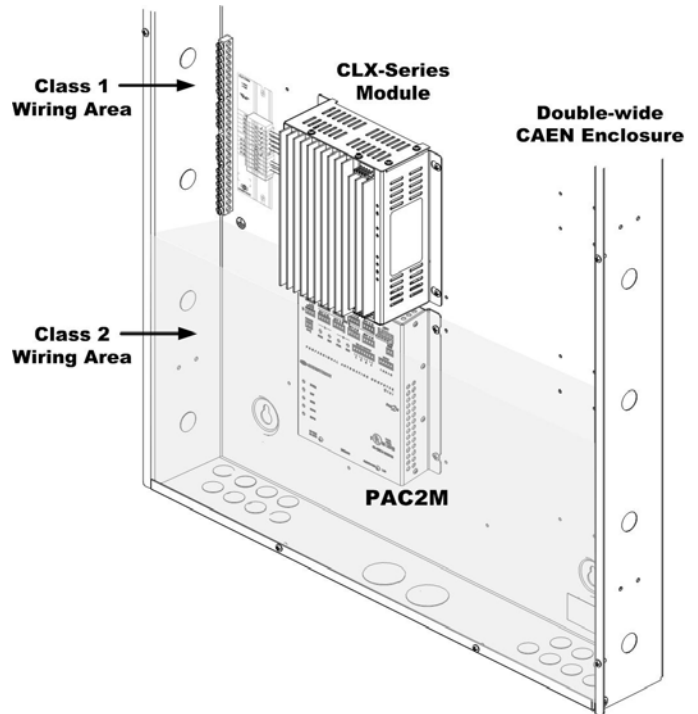

Tighten all CLT-Series terminal block screws and grounding terminal block screws to the torque specified in the Torque Data table.

CAUTION: Failure to properly tighten the screws may result in poor electrical connection and overheating of the terminals.

Wire Range & Torque Data	CLT Terminal Blocks	Grounding Terminal Blocks		
		14 - 10	8	6 - 4
Wire Range	22 - 10	35	40	45
Torque (In-Lbs)	9			

Universal Mounting Plates

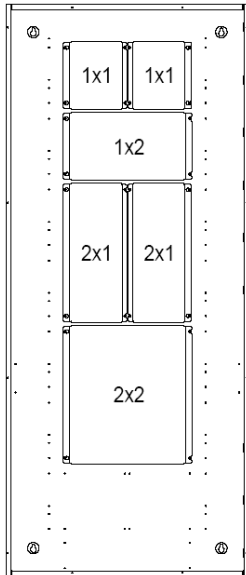

Crestron Universal Mounting Plates (CAEN-UMP Series) are a complete line of accessory plates, which allow mounting of non-Crestron equipment to any Crestron Automation Enclosure (CAEN Series). Third-party products such as phone and alarm systems can be mounted to these plates. The advantage to using the CAEN-UMP is that a variety of sizes are available and each plate occupies the same area as one, two or four Crestron lighting modules (CLX-series).

The size corresponds to the number of module spaces and their arrangement within the enclosure. For example, CAEN-UMP2X2 occupies four module positions and CAEN-UMP1x1 occupies one module position. The others (CAEN-UMP2X1 and 1X2) occupy two module positions. Refer to the illustration for an example of plate location and orientation within a double-wide enclosure. The table below lists the dimensions and weight for each CAEN-UMP model. The CAEN-UMP must be mounted in accordance with all national and local codes.

Use the four supplied (8x1/4") screws to attach a CAEN-UMP to an enclosure. Crestron recommends that the keyholes on the plates be located toward the outer edge of the enclosure, as shown in the illustration. As a result, the flanges of the plates do not overlap each other when positioning any combination of CAEN-UMP2X1s, CAEN-UMP1X1s, or lighting modules side-by-side in an enclosure.

NOTES: Adhere to Class 1 versus Class 2 wiring requirements when considering the equipment attached to the CAEN-UMP in an enclosure.

Third-party equipment attached to a CAEN-UMP within a Crestron Automated Enclosure should not be considered part of the Crestron system.

CAEN Universal Mounting Plate	2X2	2X1	1X2	1X1
Weight	22.6	12.0	12.4	6.6
Height	15 1/8	15 1/8	7 7/16	7 7/16
Width	14	6 15/16	14	6 15/16
Depth	5/8			

Dimensions are provided in inches, edge to edge.

Weight is provided in ounces.

Cover Extension Kits

The Cover Extension Kits are designed to increase the overall depth of the automation enclosures by 1.5 inches. Adding depth to these enclosures accommodates excess wiring and third-party devices that may not normally fit in the standard enclosure.

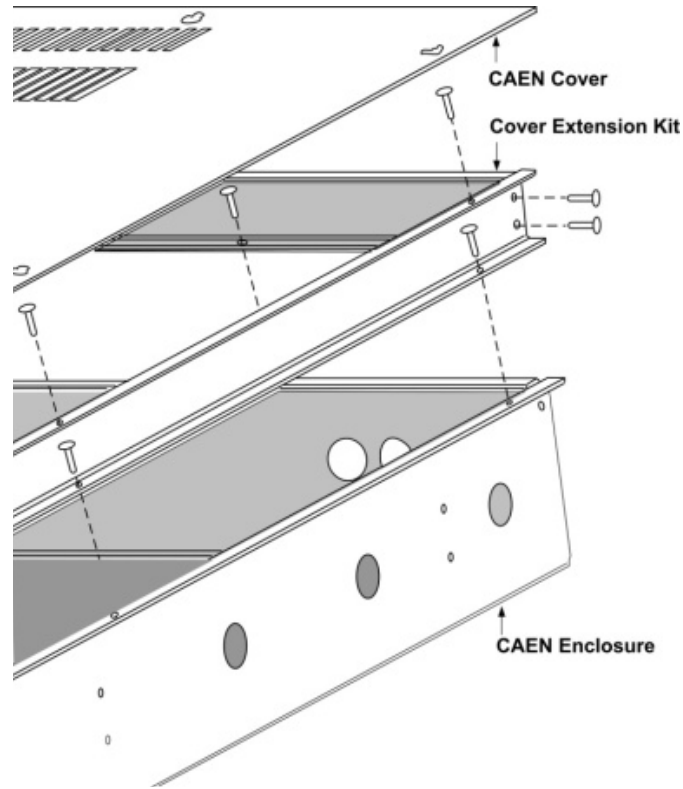

CAEN Cover Extension Kit	CAEN-CK-2X1	CAEN-CK-4X1	CAEN-CK-4X2	CAEN-CK-7X1	CAEN-CK-7X2
Height	23.5	38.9	38.9	62	62
Width	15.35	15.35	26.5	15.35	26.5
Depth	1.5				

Dimensions are provided in inches.

CLX Lighting Control Modules

Concealed in Crestron automation cabinets, the CLX-series devices are rigorously built using oversized heat sinks for ultimate reliability.

- Split-bobbin transformers and ground-referenced electronics deliver superior performance
- Lamp flicker is minimized through the innovative Crestron zero-crossing detection technique, backed by proprietary firmware
- Low-maintenance convection cooling assures quiet and trouble-free operation
- Noise suppression inductors and international 230V versions are available
- LEDs on the modules indicate communication to a Cresnet® network, input power to the module, and output power to the load
- A five-pin ribbon cable interconnects modules and the processor

NOTE: CLX modules and their associated CLT terminal blocks must be installed into the lowest available spaces and continue toward the top of the enclosure.

CAUTION: A bypass jumper is provided to allow testing and to protect the module during installation. When properly secured by nine screws, the jumper on the black and red section of the terminal block shorts the LINE in to DIM out so that the circuit is energized. Do not remove the bypass jumper until all feed and load wiring has been completed, the circuit has been tested for electrical faults, and the module has been installed. Furthermore, the jumper on the white section of the terminal block ties the neutral in to the neutral outs. This jumper should never be removed.

CLX-Series Lighting Control Modules

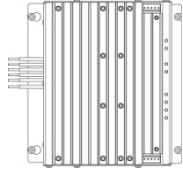
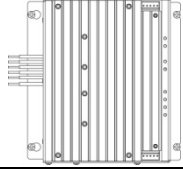
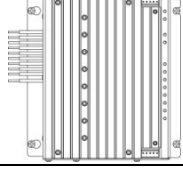
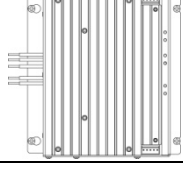
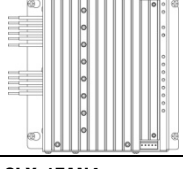
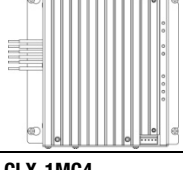
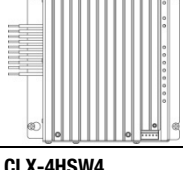
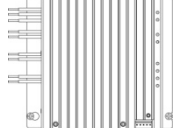
Model	Load	Rating
CLX-1DELV4 	Four channels of dimming for electronic low voltage and incandescent loads	Each channel is rated for 1200 watts, with a total module rating of 1920 watts when fed from a 20A breaker. A total module rating of 1440 watts when fed from a 15A breaker <hr/> NOTE: CLW series dimmers are not compatible with CLX-1DELV4
CLX-1DIM4 	Four channels of dimming for incandescent, magnetic low voltage, neon/cold cathode, and dimmable 2-wire fluorescent loads	Each channel is rated for 1920 watts, with a total module rating of 1920 watts when fed from a 20A breaker. A total module rating of 1440 watts when fed from a 15A breaker
CLX-1DIM8 	Eight channels of dimming for incandescent, magnetic low voltage, neon/cold cathode, and dimmable 2-wire fluorescent loads	Each channel is rated for 1920 watts, with a total module rating of 1920 watts when fed from a 20A breaker. A total module rating of 1440 watts when fed from a 15A breaker
CLX-2DIM2 	Two independent channels of dimming for incandescent, magnetic low voltage, neon/cold cathode, and dimmable 2-wire fluorescent loads.	Each channel is rated for 1920 watts; with a total module rating of 3840 watts when fed from two separate 20 A feeds, and a total module rating of 2880 watts when fed from two 15A breakers.
CLX-2DIM8 	Eight channels of dimming for incandescent, magnetic low voltage, neon/cold cathode, and dimmable 2-wire fluorescent loads, actually composed of two independent four-channel dimmers in a single module	Each channel is rated for 1920 watts; with a total module rating of 1920 watts when fed from a 20A breaker. A total module rating of 1440 watts when fed from a 15A breaker
CLX-1FAN4 	Capacitive-type speed control for up to four ceiling fan motors	Each channel provides four preset speed settings plus off and is rated for 2 amps, with a total module rating of 8 amps
CLX-1MC4 	Control of up to four bidirectional motors for drapes, blinds, projection screens, lifts, etc.	Each channel is rated for 10 amps or 1/2 HP, with a total module rating of 16 amps.
CLX-4HSW4 	Four independent channels of switching for high-inrush loads such as motors, HID lighting, and fluorescent ballasts, as well as incandescent, low voltage, and neon/cold cathode lighting	Each channel is rated for 16 amps or 1/2 HP; with a total module rating of 64 amps when fed from four separate 20 amp feeds.

Terminal Blocks and Modules

The Crestron CLT terminal blocks and modules are considered a single entity and must be used together. In field-assembled panels, they ship separately to permit termination of the field wiring to the terminal block prior to the installation of the module, and are mounted in any Crestron Automation Enclosure (CAEN-series enclosures). The terminal block is designed to terminate the circuit feed (HOT and NEUTRAL) and distribute the controlled circuit (LOAD) to the fixture(s).

The module connects to the terminal block and performs dimming or switching control of the loads, limited to 16A total per module. The unit requires 120VAC 60 Hz, single phase input voltage.

An oversize heat sink dissipates heat efficiently. The LEDs on the module indicate communication to a Cresnet® network, input power to the module, and output power to the load.

Terminal Blocks, Rails, and Labels (Inverted, right side units shown)

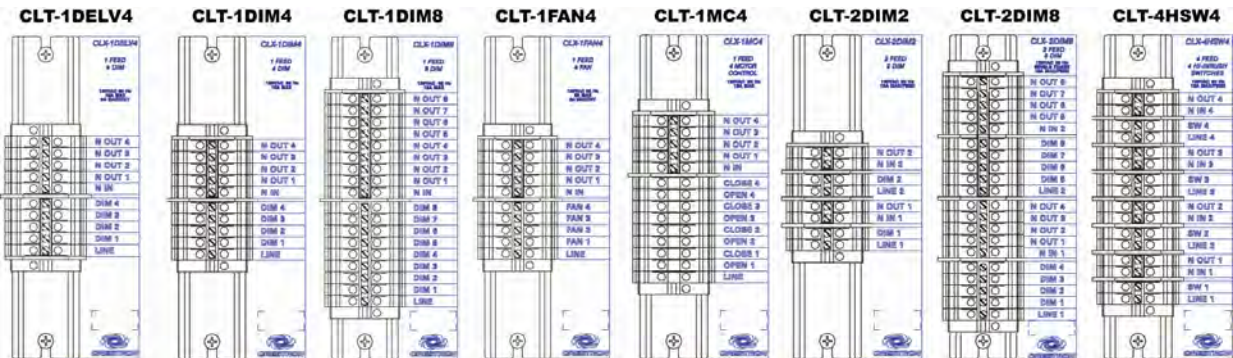

NOTES: When connecting dimming loads to an arc fault breaker, the load should not exceed 1000 watts per breaker.

Each terminal block includes a **terminal rail** for mounting the terminal block in the enclosure. Terminal rails and blocks do not occupy a module space within an enclosure.

Terminal blocks are installed along the left side of single-wide enclosures and along the outside edges (left and right sides) of enclosures. Modules are installed along the right side of single-wide enclosures and side-by-side in the center of enclosures. When installing modules and terminal blocks in a double-wide enclosure, be sure to invert units on the right side so that they can be properly wired.

Module Installation

In accordance with all national and local codes a licensed electrician, , must mount the terminal blocks and modules in field-assembled Crestron Automation Enclosures.

Terminal blocks are installed along the left side of single-wide enclosures and along the outside edges (left and right sides) of doublewide enclosures. Modules are installed along the right side of singlewide enclosures and side-by-side in the center of doublewide enclosures.

Refer to the illustrations when considering the location of terminal blocks and modules within an enclosure.

CAUTIONS: This equipment is for indoor use only and requires air cooling. Mount in a well-ventilated area. The ambient temperature must be 32°F to 104°F (0°C to 40°C). The relative humidity must be 0% to 90% (non-condensing).

Modules contains electrostatic sensitive devices (ESDs) and units must be handled from metal chassis – do not touch PC board or components.

NOTES: Modules and terminal blocks must be installed into the lowest available spaces and continue toward the top of the enclosure.

Modules are installed after the enclosure has been completely wired.

Single Width Enclosure Mounting

Module and associated terminal block installed in single width enclosure are shown below. The PAC2 processor occupies the lowest module position

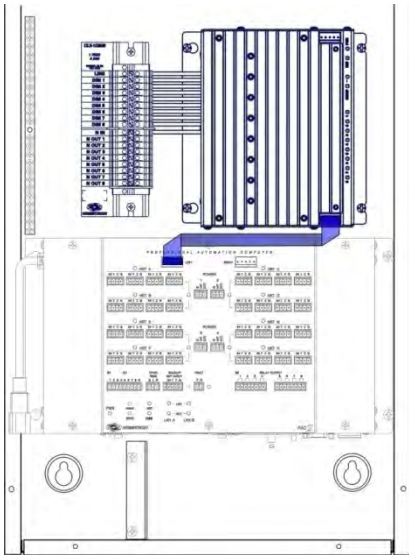

Double Width Enclosure Mounting

Module and associated terminal block installed in double width enclosure are shown below. The PAC2 processor occupies the lowest module position.

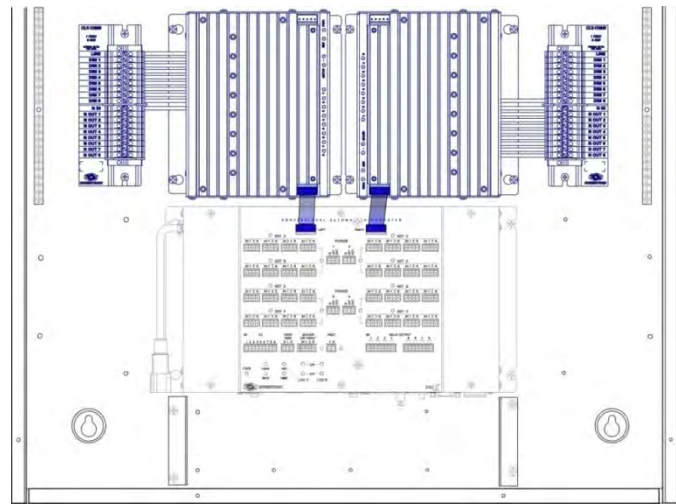

Terminal Rail Bypass Jumpers

CAUTION: A bypass jumper is provided on the terminal rail to allow testing and to protect the module during installation. When properly secured by nine screws, the jumper on the black and red section of the terminal block shorts the LINE in to DIM out so that the circuit is energized. Do not remove the bypass jumper until all feed and load wiring has been completed, the circuit has been tested for electrical faults, and the module has been installed. Furthermore, the jumper on the white section of the terminal block ties the neutral in to the neutral outs. This jumper should never be removed.

NOTE: Use copper conductors only – rated 75°C.

Cresnet® Terminal Block for CAEN Automation Enclosures

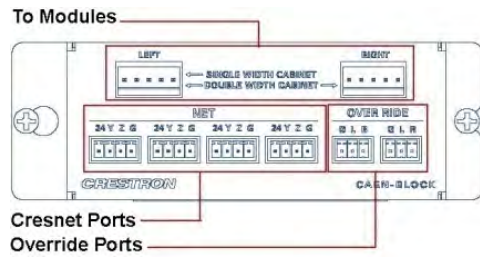

The CAEN-BLOCK is a Cresnet terminal block designed specifically for Crestron lighting and automation systems to link remote enclosures to the central PAC2 or PAC2M control system. The CAEN-BLOCK mounts at the bottom of each CAEN enclosure that does not contain a control system to provide Cresnet and override signal connectivity for CLX-series lighting control modules. The CAEN-BLOCK serves as a parallel distribution block for multiple Cresnet cables, and especially provides for connection of the Cresnet and override signal cables from the central control system.

Crestron Network Block (CAEN-BLOCK) provides four termination ports for Cresnet wiring. The unit has two 5-pin connections that provide communication to the modules. Contact closure signals that produce an emergency override of the modules are also sent through these connections.

When a switch contact closure is received between the “G” connections and the “L” or “R” connection (R is used in a double-wide enclosure only) on the CAEN BLOCK, the respective left or right column of modules will set the lights to the programmed emergency override state.

The CAEN-BLOCK unit is a pass-through device with a Cresnet power factor of zero.

Network Block Dimensions and Weight

Height	Width	Depth	Weight
2 in	6 in	1 ¾ in	3.4 oz

NOTES: A module terminal block (CLT-series device) must be ordered for each module. The corresponding CLT terminal block is installed in the enclosure for high voltage wire termination. Each terminal block includes a terminal rail for mounting the block in the enclosure. Terminal rails and blocks do not occupy a module space within an enclosure.

CAEN-series enclosures are required to install CLX-series lighting modules.

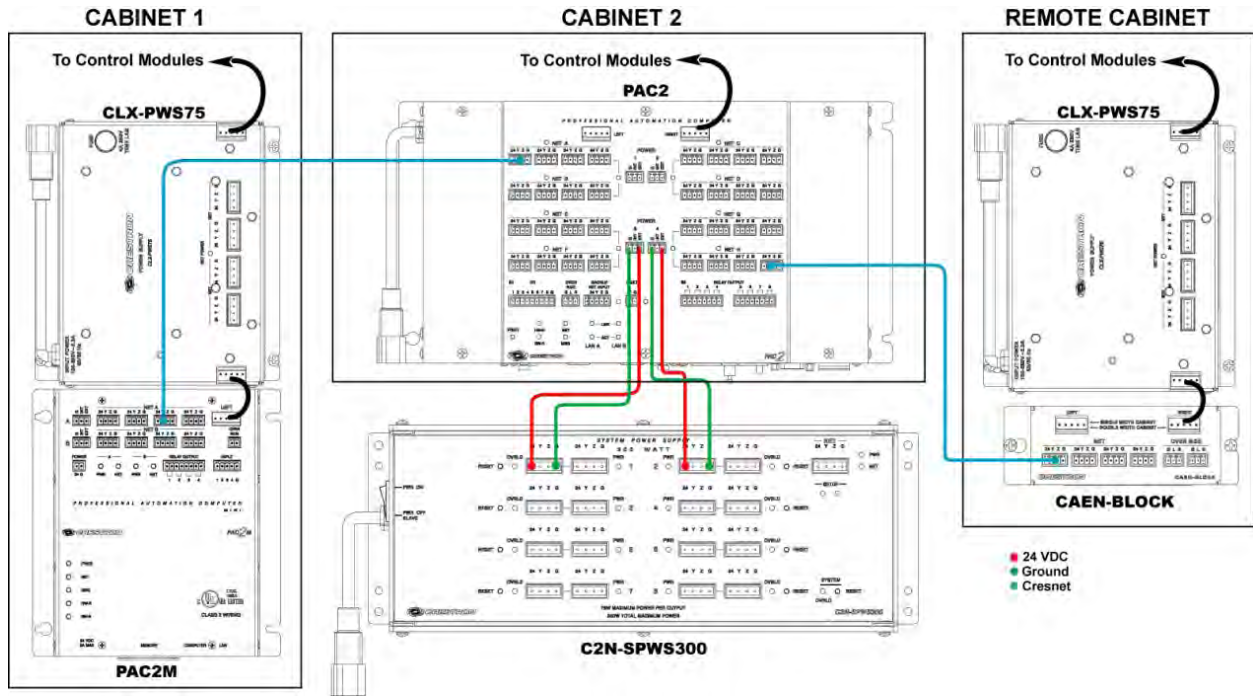

NOTE: If more than 50 watts of power is drawn by connected devices, supplemental power supplies are required.

Crestron DIN Rail Products

Features

- Popular in Europe and ideal for MDU applications
- High voltage units rated for use up to 240VAC, 50/60Hz
- Integrated Emergency Override Mode
- Mix and match Crestron and 3rd party products in one enclosure

DIN Rail Installation

The Crestron DIN Rail products are designed to snap onto a standard DIN Rail for installation in a wall mount enclosure. Wiring connections are made using screw terminals positioned along the bottom and/or top, clearly accessible from the front for easy installation and servicing. All setup controls and

indicators are positioned on the center front panel. When installed in an enclosure utilizing 45 mm cutouts, the front panel remains accessible while the connections are concealed. DIN modules may be mounted in CAEN enclosures or in DIN Rail cabinets available from a number of 3rd party vendors. Cabinets are available in many sizes.

DIN Rail devices may also be used with Crestron CAEN Cabinets.



Example DIN Rail System

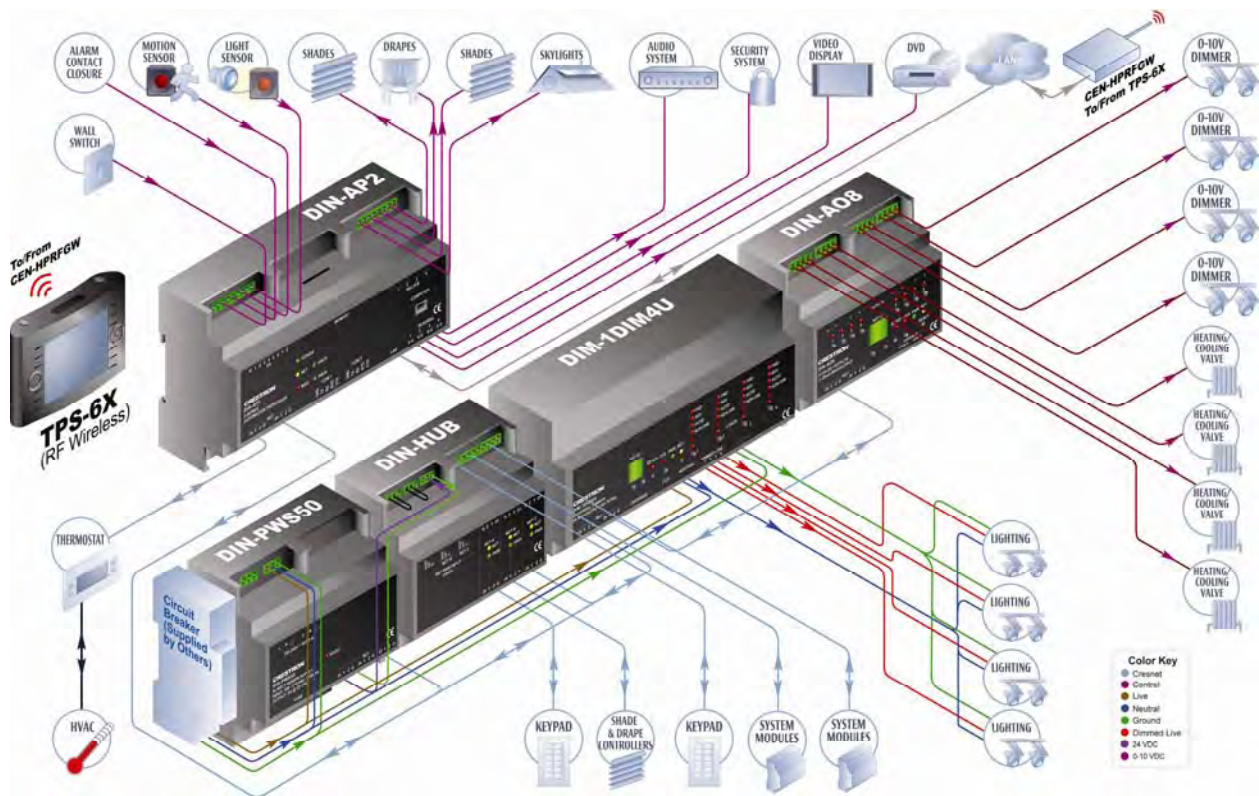

DIN-AP2

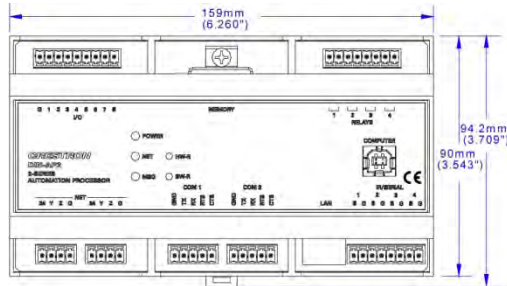

The DIN-AP2 is a 2-Series control processor designed for small to medium-sized lighting and automation applications. DIN Rail mounting enables modular installation alongside Crestron DIN Rail lighting and automation control modules and other third-party DIN Rail mountable devices.

Features

- 2-Series control engine
- MMC memory expansion card slot
- Cresnet port - master/slave selectable
- 10/100 Ethernet | SSL encryption
- e-Control 2, SNMP and RoomView support
- 2 bidirectional RS-232 COM ports
- 4 IR/serial ports
- 8 Versiport I/O ports
- 4 Low-voltage relay ports
- Configurable via Crestron D3 Pro software

2-Series Processor

Built upon the reliable Crestron 2-Series control engine, the DIN-AP2 is extensively programmable using the suite of powerful Crestron development software and vast database of drivers and software modules. The DIN-AP2 works seamlessly with the entire line of Crestron lighting dimmers and shade controls, keypads and touchpanels, thermostats, wireless gateways, and expansion modules.

System Integration

The DIN-AP2 provides for the integration of non-Crestron devices and subsystems through a host of control interfaces. Four isolated relays and eight Versiport I/O ports are built in to accommodate all kinds of sensors, contactors, door strikes, and other low voltage controls. Two bidirectional RS-232 COM ports and four IR/serial ports allow for the integration of everything from simple shade controllers to advanced security systems.

Cresnet®

Cresnet is the communications backbone for Crestron lighting modules, wall box dimmers and shade controllers. The DIN-AP2 includes a pair of Cresnet master ports (paralleled) capable of supporting approximately 20 typical devices. Larger systems with more than 20 devices can be handled by adding the DIN-HUB Cresnet Distribution Hub. Connectivity for multiple homeruns can be facilitated using one or more DIN-BLOCK Cresnet Distribution Blocks. Additionally, at least one DIN-PWS50 Cresnet Power Supply is required to power the DIN-AP2 and any connected Cresnet devices.

Memory Expansion

A memory card slot allows for easy expansion of the DIN-AP2 internal memory using an MMC-compatible memory card up to 2 GB.

Ethernet and e-Control®2

Built-in 10/100 Ethernet facilitates secure high speed network connectivity, enabling extensive capabilities for remote system maintenance and control, and providing an interface to other Crestron control systems. Native features include a built-in email client to report system troubles and other functions to the owner or service company via instant email notification. An onboard Web server provides the foundation for the exclusive Crestron e-Control 2 XPanel technology, providing secure IP-based remote control.

RoomView® and SNMP

For large facilities utilizing multiple DIN-AP2s and other control systems, exclusive Crestron RoomView Help Desk software delivers a comprehensive solution for remote monitoring and asset management. Also, built-in SNMP support enables similar capability using third-party network management software, allowing full control and monitoring from the IT Help Desk or NOC in a format that's familiar to IT personnel.

D3 Pro™ Software

Crestron D3 Pro software eliminates the need for custom programming, providing a complete design, development, and documentation solution for the lighting professional.

DIN-1DIMU4

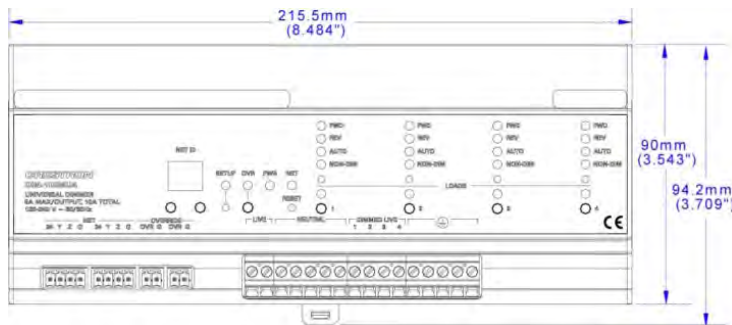

The DIN-1DIMU4 is a 4-channel universal lighting control module designed to support dimming of both forward and reverse phase type loads. A single model supports 120 and 220-240 volt electronic and magnetic low voltage, incandescent, neon/cold cathode, 2-wire dimmable fluorescent, and non-dimmable lighting loads up to 5 amps per channel, 10 amps total.

Features

- 4 channels of forward or reverse phase dimming
- Auto load detection
- 120 to 240 Volt 50/60 Hz operation (Not for 277 VAC operation)
- Selectable non-dim mode
- Extreme stability in noisy environments
- Short circuit and overload protection
- Master air-gap relay
- Setup via front panel or software
- Programmable functionality via DIN-AP2

Auto Load Detection

Each channel of the DIN-1DIMU4 is capable of auto-detecting the dimmable load type connected to it and selecting the appropriate operating mode to control that load. Reverse phase (trailing edge) mode supports incandescent and electronic low-voltage load types, while forward phase (leading edge) mode handles magnetic low voltage, neon, and other inductive load types. A non-dim mode is also selectable for switching of non-dimmable lighting fixtures. Any channel may be set for any mode, allowing one dimmer module to handle any combination of lighting types on four separately controlled circuits.

Phase-Synchronous Detection Circuitry

Proprietary Crestron zero-cross filter technology provides

superior immunity to noise on the power line, reducing lamp flicker and compensating for fluctuations in line voltage and frequency.

Short Circuit Protection

Built-in OCP (over current protection) prevents failure of the DIN-1DIMU4 caused by excessive loading or improper wiring of the outputs.

Master Air-Gap Relay

When all four channels are turned fully off, the internal master relay automatically opens, providing air-gap isolation that allows safe servicing and changing of light bulbs on all four controlled circuits.

DIN-8SW8

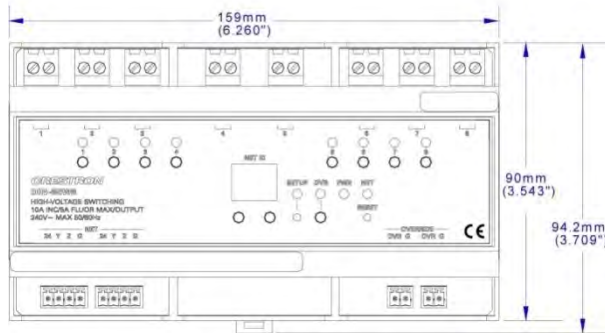

The DIN-8SW8 is an 8-channel high voltage lighting control module designed to support switching of non-dimmable lighting and fans. A single model supports both 120 and 220-240 volt applications. Each channel handles incandescent loads up to 10 amps, fluorescent loads up to 5 amps, and also 1/2 HP motors.

Features

- 8 channels of power switching
- Supports 120 to 240 volt 50/60 Hz (Not for 277 VAC operation)
- Override input
- Cresnet® communications
- Setup via front panel or software
- Programmable functionality via DIN-AP2

DIN-4DIMFLV4

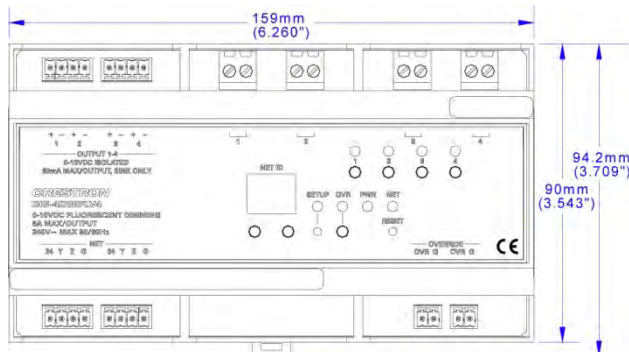

The DIN-4DIMFLV4 is a 4-channel lighting control module designed to support dimming of 4-wire 0-10 volt fluorescent dimming ballasts. A single model supports both 120 and 220-240 volt applications. Each channel handles up to 30 dimmable ballasts, and may also be used for switching of non-dimmable lighting loads up to 5 amps, as well as 1/2 HP motors.

Features

- 4 channels of 4-wire 0-10 volt fluorescent dimming
- Supports 120 to 240 Volt 50/60 Hz (Not for 277 VAC operation)
- Also allows switching of lighting and exhaust fans
- Setup via front panel or software
- Programmable functionality via DIN-AP2

DIN-2MC2

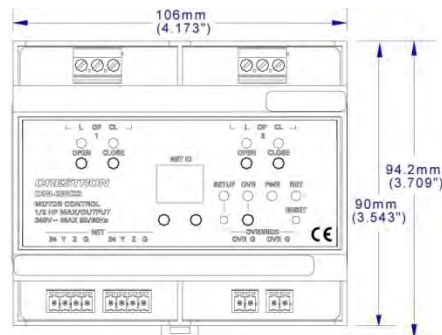

The DIN-2MC2 is a 2-channel motor control module designed to provide control of bidirectional motors for drapes, shades, projection screens, lifts, skylights, and gates. Each channel supports up/down or open/close control of a conventional 3-wire bidirectional type motor up to 1/2 HP at voltages up to 240 volts. Built-in timing and interlock logic make it easy to program the DIN-2MC2 for failsafe operation.

Features

- Dual-channel bidirectional motor control
- Supports 120 to 240 volt 50/60 Hz
- Setup via front panel or software
- Programmable functionality via DIN-AP2

DIN-A08

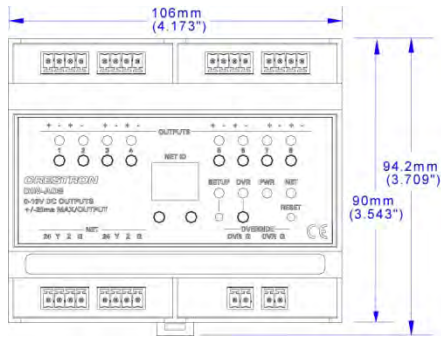

The DIN-A08 is a DIN Rail-mounted automation control module that provides eight analog output ports for interfacing with third-party lighting and heating/cooling systems.

Analog Outputs

Each analog output port provides a 0 to 10 volt DC control signal ideally suited for controlling 0-10V lighting dimmers and heating/cooling valves. 10-bit resolution ensures precise recall of lighting and climate control settings and smooth ramping between levels.

Features

- Eight 0-10V analog output control ports (Maximum sink current 20mA per channel)
- Interface for 3rd-party lighting and heating/cooling
- Fully programmable functionality via DIN-AP2 Setup via front panel or software

DIN-I08

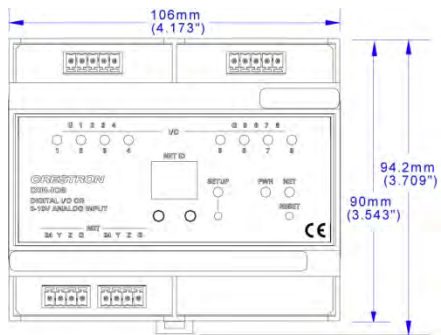

The DIN-I08 is a DIN Rail-mounted automation control module that provides eight Versiport I/O ports for interfacing with a wide range of third-party devices and systems. Each Versiport can be configured via software to function as a digital or analog sensing input or as a digital trigger output.

Features

- 8 Versiport I/O ports
- Interface for 3rd-party sensors, detectors, contact closures, and alarms
- Fully programmable functionality via DIN-AP2

Versiports

Configured as a digital input, the Versiport senses a contact closure or logic level signal from devices such as motion detectors, partition sensors, alarm panels, 12V triggers, and all types of switches and relays. As an analog input, the Versiport can sense changes in a resistance or DC voltage level, working with everything from temperature and light sensors to water level meters to volume control potentiometers. As a digital output, the Versiport provides a logic level closure signal to trigger control and alarm inputs on a variety of external devices.

DIN-BLOCK

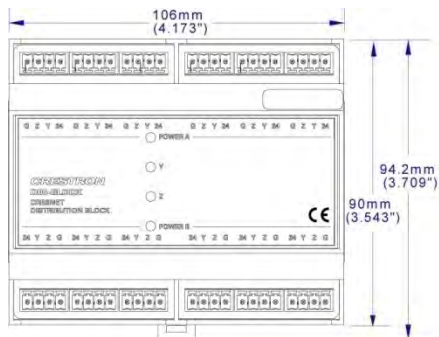

The DIN-BLOCK is a DIN Rail-mounted Cresnet® distribution block designed to facilitate the termination of Cresnet wiring at a head end or distribution point. DIN Rail mounting enables modular installation alongside Crestron DIN Rail lighting and automation control modules and other third-party DIN Rail mountable devices.

Features

- 12 port Cresnet distribution block
- Detachable screw terminal blocks for easy termination and troubleshooting
- Split power bus for flexible 24V power distribution
- Diagnostic LEDs for network power and data
- Passive device — no programming required

Cresnet Distribution

Cresnet is the communications backbone for Crestron lighting modules, wall box dimmers, shade controllers, thermostats, keypads, touchpanels, and many other devices. This flexible 4-wire bus allows for combinations of homerun and daisy-chain wiring, and the DIN-BLOCK provides a simple means for connecting up to 12 separate Cresnet cables as part of any sized network.

Cresnet Power Distribution

In addition to data, Cresnet carries 24 volts DC for powering the devices connected to it. The Cresnet ports on the DIN-BLOCK are arranged into two separate power groups, providing an easy way to manage the distribution of power for a complete Cresnet network. A separate power supply may be dedicated to each group, or a single supply can be connected to both groups as needed. Each group supports up to 75 watts.

DIN-PWS50

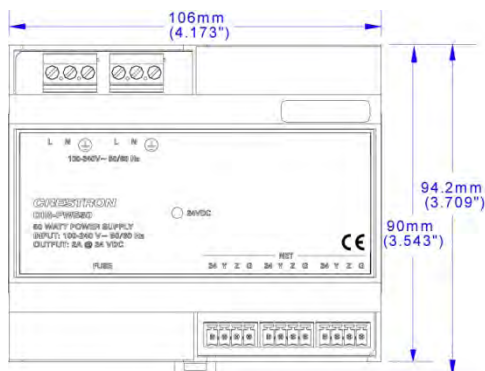

The DIN-PWS50 is a 50 watt Cresnet power supply module designed to snap onto a standard DIN Rail installation. DIN Rail mounting enables modular installation alongside Crestron DIN Rail lighting and automation control modules and other third-party DIN Rail mountable devices. All wiring connections are made using screw terminals positioned along the top and bottom, clearly accessible from the front for easy installation and servicing. Three Cresnet power ports are provided.

Features

- 50 watt Cresnet power supply module
- Powers the DIN-AP2 Automation Processor and other Cresnet devices
- Includes 3 Cresnet power ports
- Cresnet data passes through unaffected
- Dual line power input terminals for easy daisy-chaining

DIN-HUB

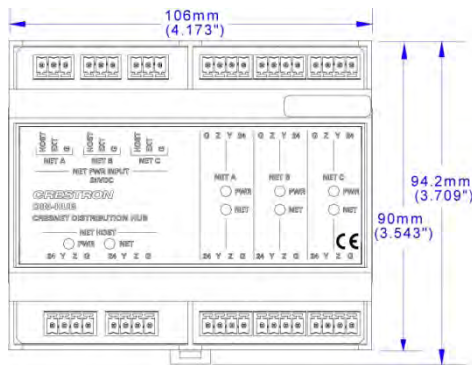

The DIN-HUB is a DIN Rail-mounted Cresnet® hub designed to facilitate the configuration of large Cresnet networks. DIN Rail mounting enables modular installation alongside Crestron DIN Rail lighting and automation control modules and other third-party DIN Rail mountable devices.

Features

- 3-segment Cresnet hub
- 32 Cresnet devices per segment

3-Segment Cresnet Hub

Cresnet is the communications backbone for Crestron lighting modules, wall box dimmers, shade controllers, thermostats, keypads, touchpanels, and many other devices. This flexible 4-wire bus normally supports approximately 20 Cresnet devices without requiring a hub. Larger systems are easily enabled by adding the DIN-HUB. The DIN-HUB features three isolated Cresnet segments, each supporting an additional 20 devices, allowing for systems of approximately 80 devices total (including the "host" segment). More hubs may be added to allow up to a maximum potential of 252 devices.

Cresnet Power Distribution

In addition to data, Cresnet carries 24 volts DC for powering the devices connected to it. The DIN-HUB provides an easy way to manage the distribution of power for a complete Cresnet network. Each segment can be configured to receive its power from the "host" power source or from another power supply. Separate power supplies may be dedicated to each segment, or a single supply can be shared amongst multiple segments as needed. Each segment supports up to 75 watts.

Interface Equipment

Integrating your lighting with A/V controls, shade control, security systems, and HVAC through a single system have never been easier. Crestron provides the ultimate, fully integrated lighting control solution for any application.

- Dimming control
- Switched control
- Sensor activated control
- Security
- Astronomical clock control
- Remote monitoring of any location

Crestron eliminates all system integration problems by providing the single point control solution coupled with the widest selection of control devices. Crestron products are designed to operate efficiently, replacing several products and drawing less power.

Crestron products and automation solutions help designers meet ASHRAE (American Society of Heating, Refrigeration, and Air-Conditioning Engineers) and LEED (Leadership in Energy and Environmental Design) standards. Crestron products are also in compliance with the European Union (EU) Directive 202/95/EC Restriction of Hazardous Substances (RoHS).

Additional Crestron product information and specifications are available from the Crestron web site:
www.crestron.com

Crestron User Interfaces

Crestron offers a wide variety of types and styles to suit the needs and tastes of your client.

User interfaces are prominently and strategically located throughout a lighting design, providing the physical link between the user and the controlled devices.

Touchpanels

Crestron touchpanels are the most elegant, efficient and practical control solution, simplifying the most demanding design and providing intuitive one-touch control of lighting, AV, HVAC, and security.

With distinctive features for every application, the broad range of Crestron touchpanels delivers maximum value. There is a Crestron touchpanel for every room and every budget.

Keypads

C2N-DB Decorator Series Keypads bring a contemporary design to traditionally flat faceplates. They

are available in a wide selection of finishes and offer extra large, backlit buttons for custom engraving. They also play door chimes, voice prompts, button clicks and other audible feedback, depending on programming. These keypads use readily available Decora® style faceplates.

CNX Designer Series Keypads are an elegant option for any décor. Extra large backlit buttons offer room for custom engraving. They can also play door chimes, voice prompts, button clicks and other audible feedback.

C2N-CBD and C2N-CBF Series Cameo™ Keypads answer the need for a diverse selection of designer colors, and dramatically reducing the standard keypad wall plate size without comprising button size. Mounting options include a choice of standard installation in a Decora® style faceplate or using the Crestron exclusive flush-mounting system. Cameo is offered in 10 designer colors, plus three standard colors.. The installer can customize and configure up to six buttons for 12 functions in total.

Wall Box Dimmers and Switches

These devices are functional as a stand-alone dimmers or switches, and deliver greatly enhanced functionality as part of a complete Crestron Control solution. Designed to replace any standard in-wall dimmer or light switch, when connected to a 2-Series control system via the Cresnet network, extensive automation and control capability is enabled.

CLW-Series components are available in white, black, and almond and are designed for use with Decora® style faceplates (not included). A dual purpose LED is included to verify preset storage. and serve as a beacon to make the dimmer easy to locate in the dark. Its connection to the control system allows the functions of the CLW-DIM to be controlled from touchpanels, keypads, wireless remotes, and computers to support unlimited flexibility for remote control and integration with other devices and system

infiNET™ Wireless

A wide variety of wireless dimmers and switches are available, making infiNET a perfect choice for locations where physical wiring is difficult or expensive. Connection to a control system allows the functions of the wireless dimmers and switches to be controlled and support unlimited flexibility for remote control and integration with other devices and systems.

Wall Mount Touchpanels

TPS Series Isys®

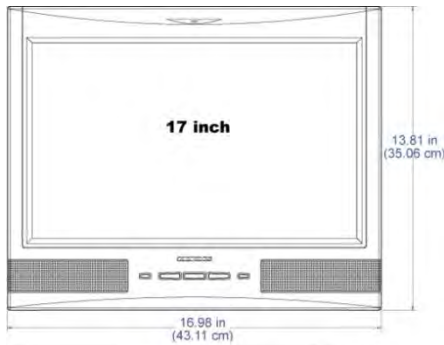

- Available in 12”(TPS-12L), 15”(TPS-15L) and 17”(TPS-17L) widescreen
- 24-Bit Isys graphics | 1280 x 768 resolution
- DNav dynamic menu objects
- Full-motion video with gamma correction
- Interactive annotation capability
- Built-in biamplified speaker system and microphone
- Backlit hard key pushbuttons
- QuickMedia® and Crestron Home CAT5 AV connectivity
- High-speed Ethernet and Cresnet® communications
- Available in black or white

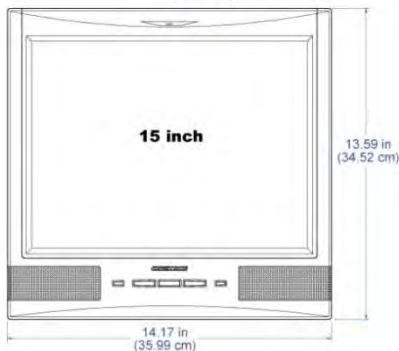

TPS Isys® G-Series with Crestron Home or QuickMedia®

- Available in 15”(TPS-15G-(QM or CH)-L) and 17”(TPS-17G-(QM or CH)-L) widescreen
- 24-Bit Isys graphics | 1024 x 768 resolution
- DNav dynamic menu objects
- Dual-window full-motion video, HDTV and RGB display
- Interactive annotation capability
- Built-in biamplified speaker system and microphone
- QuickMedia AV connectivity | audience presentation output
- High-speed Ethernet and Cresnet communications
- Backlit hard key pushbuttons
- Available in black or white

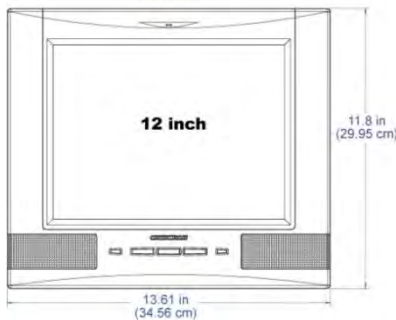

TPMC Isys I/O with Crestron Home or QuickMedia®

- 12" active matrix touchscreen display
- 24-bit Isys graphics | 800 x 600 resolution
- DNav dynamic menu objects
- Full-motion video with gamma correction
- Interactive annotation capability
- Windows XP Embedded operating system
- Onboard PC applications for Web browsing, streaming media, and remote access
- Multi-format streaming video and audio
- Direct panel-to-panel intercom over IP
- Built-in amplified speakers and microphone
- QuickMedia and Crestron Home CAT5 AV connectivity
- High speed Ethernet and Cresnet communications
- Available in black or white

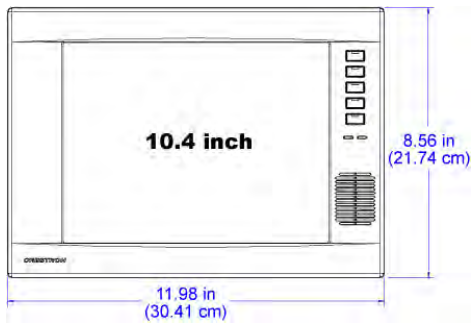

TPS-4000L

- 10.4" active matrix touchscreen display
- Isys® graphics engine with 640 x 480 resolution
- High performance video with gamma correction
- Built-in amplified speakers and microphone
- 5 engravable hardbuttons | Built-in light sensor
- Stylish flush mount design | Optional rack mount
- Cresnet® communications

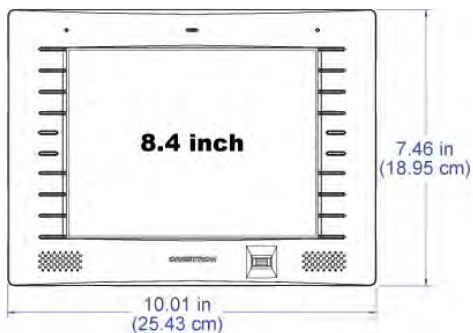

TPMC-8L

- 8.4" active matrix touchscreen display
- 16-bit Isys i/O graphics with 800 x 600 resolution
- DNav dynamic menu objects
- Windows XP Embedded operating system
- Onboard PC applications for Web browsing, streaming media, conferencing, VoIP, remote computer access
- Multi-format streaming video and audio | WAV file audio feedback
- Built-in stereo speakers and dual microphones
- Includes faceplate with 16 hard key pushbuttons
- Button engraving available as solid or backlit text No-button blank faceplate also provided
- Built-in biometric fingerprint scanner and light sensor
- 10/100 fast Ethernet communications | Rear panel USB ports
- Available in almond, black, white, or stainless steel

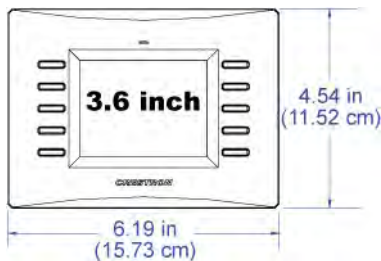

TPS-4L

- 3.6" active matrix color touchscreen display
- 16-bit Isys graphics | 320 x 240 resolution
- Synapse Image Rendering Algorithm
- 10 white backlit pushbuttons and engravable faceplate
- WAV file audio feedback
- Ethernet and Cresnet communications
- 10 designer colors: Almond, Black, Butter, Cream, Ecru, Smoke, Stone, White, and Wheat

Tilt Touchpanels

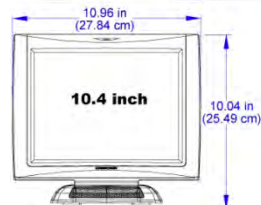
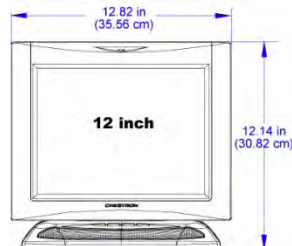
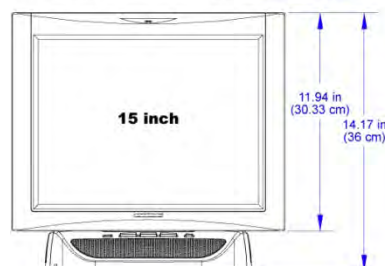
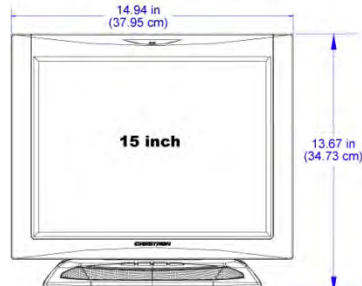
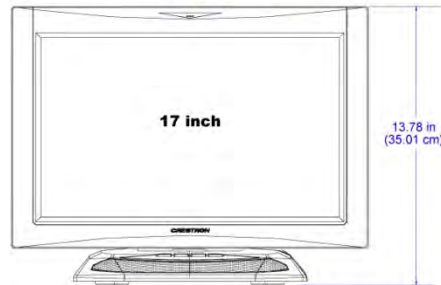
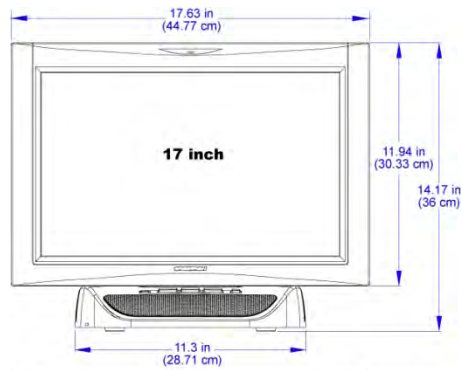

TPS Series Isys®

- Available in 12" (TPS-12L), 15" (TPS-15L) and 17" (TPS-17L) widescreen
- 24-bit Isys graphics | 1280 x 768 resolution
- DNav dynamic menu objects
- Full-motion video with gamma correction
- Interactive annotation capability
- Built-in biamplified speaker system and microphone
- Backlit hard key pushbuttons
- QuickMedia® and Crestron Home CAT5 AV connectivity
- High-speed Ethernet and Cresnet® communications
- Available in black or white

TPS Isys G-Series with Crestron Home or QuickMedia

- Available in 15" (TPS-15G-(QM or CH)-L) and 17" (TPS-17G-(QM or CH)-L) widescreen
- 24-Bit Isys graphics | 1024 x 768 resolution
- DNav dynamic menu objects
- Dual-window full-motion video, HDTV and RGB display
- Interactive annotation capability
- Built-in biamplified speaker system and microphone
- QuickMedia AV connectivity | audience presentation output
- High-speed Ethernet and Cresnet communications
- Backlit hard key pushbuttons
- Available in black or white

TPMC Isys i/O with Crestron Home or QuickMedia

- 12" active matrix touchscreen display
- 24-Bit Isys graphics | 800 x 600 resolution
- DNav dynamic menu objects
- Full-motion video with gamma correction
- Interactive annotation capability
- Windows XP Embedded operating system
- Onboard PC applications for Web browsing, streaming media, and remote computer access
- Multi-format streaming video and audio
- Direct panel-to-panel intercom over IP
- WAV file audio feedback
- Built-in amplified speakers and microphone
- QuickMedia* and Crestron Home CAT5 AV connectivity
- High-speed Ethernet and Cresnet communications
- Available in black or white

TPS-4000

- 10.4" active matrix touchscreen display
- Isys graphics engine with 640 x 480 resolution
- High performance video with gamma correction
- Built-in amplified speakers and microphone
- 5 engravable hardbuttons | Built-in light sensor
- Stylish flush mount design | Optional rack mount
- Cresnet communications

TPMC Series Isys i/O WiFi Touchpanels

TPMC-8T

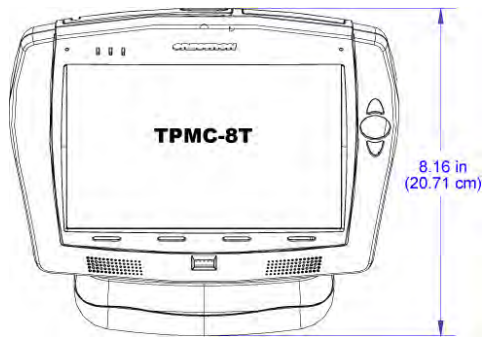

- 8.4" active matrix touchscreen display
- 16-bit Isys i/O graphics | 800 x 600 resolution
- Synapse image rendering algorithm
- DNav dynamic menu objects
- Windows XP Embedded operating system
- Onboard PC applications for Web browsing, streaming media, conferencing, VoIP, and remote computer access
- Streaming video from network cameras and servers
- Built-in microphone and stereo speakers
- 5-way thumbpad and 4 hard key buttons
- Includes stylus with onboard storage slot
- Built-in biometric fingerprint scanner
- Built-in Bluetooth technology
- Wired 10/100 Ethernet and 802.11a/b/g Wi-Fi communications

TPMC-8X

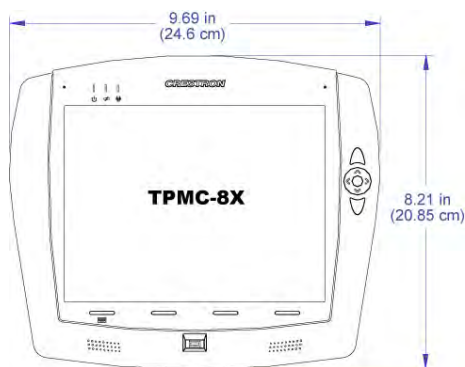

- Stylish and compact ergonomic design
- 8.4" active matrix touchscreen display
- 16-bit Isys i/O graphics | 800 x 600 resolution
- Synapse image rendering algorithm
- DNav dynamic menu objects
- 802.11a/b/g Wi-Fi 2-way wireless communications
- Windows XP Embedded operating system
- Onboard PC applications for Web browsing, streaming media, conferencing, VoIP, and remote computer access
- Wireless video from network cameras and servers
- Built-in microphone and stereo speakers
- 5-way thumbpad and 4 hard key buttons
- Includes stylus with onboard storage slot
- Built-in biometric fingerprint scanner
- Built-in Bluetooth technology
- Internal Li-Ion battery pack included
- External booster battery pack available
- Optional desktop and wall mount docking stations

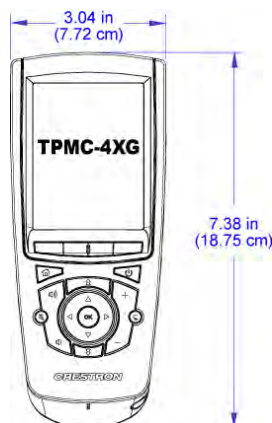

TPMC-4XG

- Stylish and ergonomic handheld design
- 3.5" active matrix touchscreen display | 240 x 320 resolution
- 16-bit Isys i/O graphics | Synapse image rendering algorithm
- Backlit hard buttons, thumbpad, and scroll wheel
- Microsoft Windows CE .NET operating system
- Windows SideShow-enabled
- Wireless video from network cameras and servers
- 802.11b/g Wi-Fi 2-way wireless communications
- Includes stylus with onboard storage slot
- Includes docking station and Li-Ion battery pack

Wireless Touchpanels and Handhelds

TPS-6X

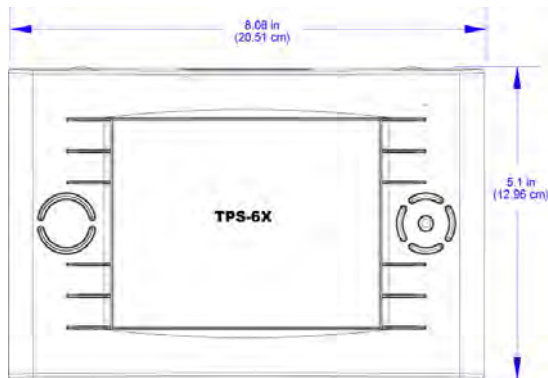

- Elegant high gloss black or white, or matte black finishes
- Non-slip rubber grips on rear
- Illuminated buttons and engravable backlit text
- 5.7" active matrix color touchscreen display
- 16-bit Isys® graphics | 640 x 480 resolution
- Dynamic graphics and text capability
- Synapse Image Rendering Algorithm
- Windows SideShow-enabled
- Displays full-motion video while docked
- High-power, high-speed 2.4 GHz RF wireless technology
- Up to 200 feet RF range indoors
- 1-way IR wireless capability also built in
- Includes tabletop tilt docking station, interface module, and NiMH rechargeable battery pack
- Wired Ethernet, Cresnet®, and Crestron Home CAT5 video connectivity

MT-1000C

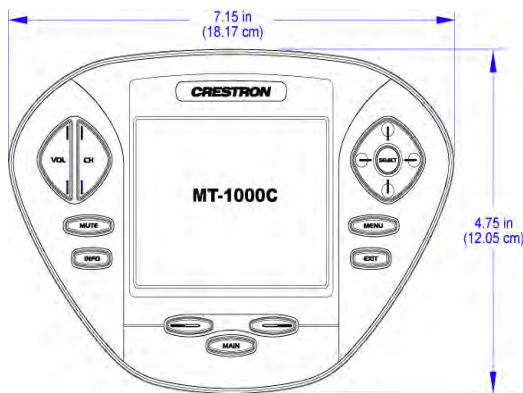

- Stylish and ergonomic handheld design
- 3.8" active-matrix color touchscreen
- 320 x 240 resolution | 16-bit Isys graphics
- Synapse Image Rendering Algorithm
- Backlit pushbuttons and 5-way thumbpad
- WAV file audio feedback
- Auto-shutoff and pick-up sensor
- 1-way RF or IR wireless communication
- Programmable using Crestron VPro-e software
- Includes docking station and Li-Ion battery pack

ML-600

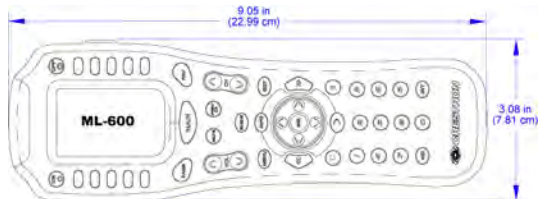

- Ergonomic handheld design
- Large programmable LCD screen flanked by 10 menu buttons
- 3 LCD menu navigation buttons
- 27 programmable function buttons
- 2 programmable power buttons
- 5-way thumb pad for OSM navigation
- EL backlighting of LCD screen and buttons
- 1-way RF or IR wireless communication
- Operates on 4 AAA alkaline batteries

WPR-48

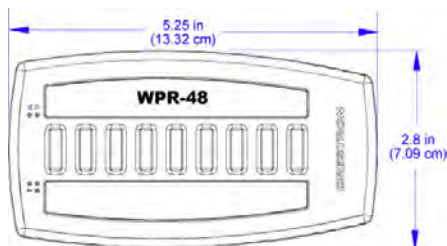

- Waterproof handheld remote
- Configurable for 9, 18, 27, or 48 function
- Multi-function buttons allow single-press, 2-position or 3-position rocker action
- Customizable labeling
- Electroluminescent backlighting
- 1-way RF or IR wireless communication
- Long-life lithium rechargeable batteries
- Includes docking station/charger and lanyard

Keypads

C2N-DB Series Decorator Keypads

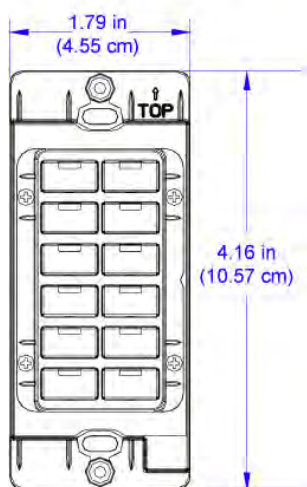
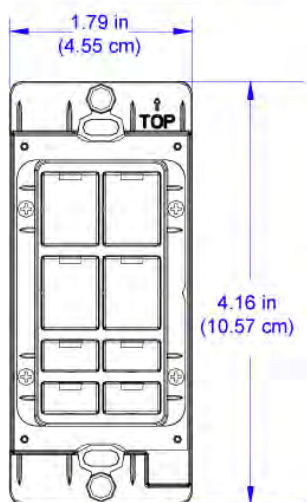
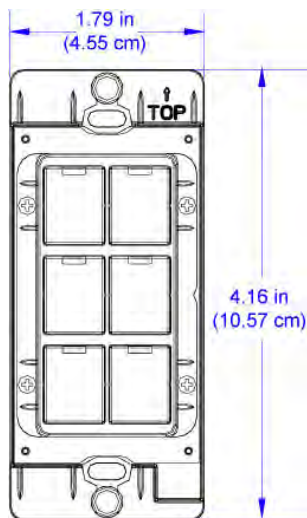

Crestron C2N-DB Decorator Series keypads deliver versatile keypad control with contemporary styling to support a broad range of residential and commercial applications from lighting to AV distribution.

Available in configurations of 6, 8, or 12 buttons, Decorator keypads are designed to allow installation in perfect harmony with non-Crestron devices using readily available Decora® style faceplates (not included). Mountable in a standard electrical gang box, multiple keypads can easily be ganged side-by-side along with other wall mount devices. All button caps are engravable and include integral red LED light pipe feedback indicators.

Features

- Fits standard electrical gang boxes and Decora® faceplates
- Available in 6, 8, and 12 button configurations
- Replaceable, custom-engravable button caps
- Programmable feedback LEDs
- Available in black, white, and almond
- Easy Cresnet® wiring

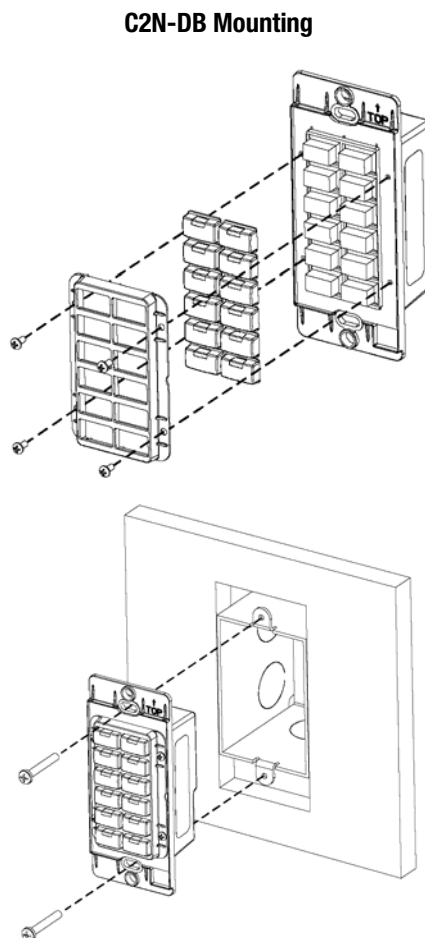

CNX Designer Series Keypads

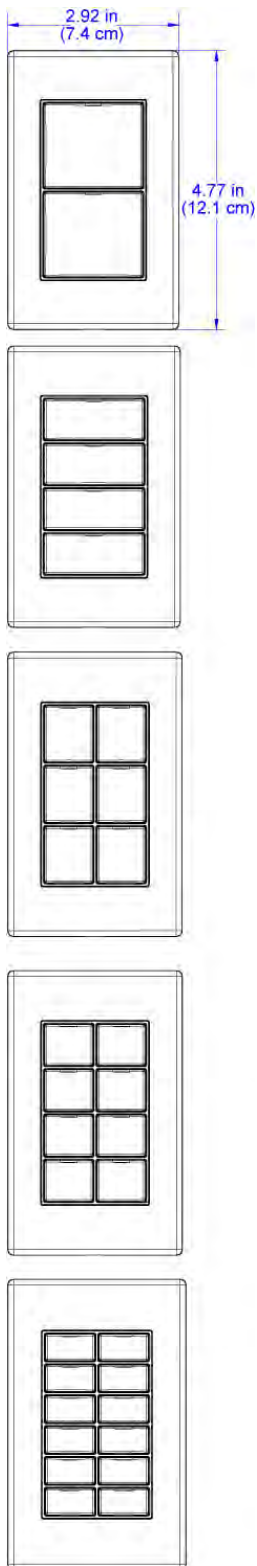

The CNX-B Designer series wall mount keypads are available in configurations of 2, 4, 6, 8, or 12 buttons. Buttons are large for optimal ergonomics. Each model mounts in a standard electrical gang box and includes a matching 1-gang faceplate. Optional 2 and 3-gang faceplates are available to allow up to three keypads to be installed side-by-side. Optional Designer and Architectural faceplates are offered in a variety of elegant finishes. Button caps are engravable and include LED feedback indicators. Standard models are available in White, Black or Almond. Backlit button caps are also available (black only).

CNX-B series keypads include built-in WAV sound file capability to enable customized audible feedback. An onboard temperature sensor is also included for general monitoring of room temperature. The product name corresponds to the number of keypad buttons. For example, CNX-B6 is a six-button keypad and a CNX-B12 is a 12-button keypad.

The CNX-B series keypads have a uniquely stylish shape and faceplates are available for the most common groupings; single, double, or three gang plate arrangements.

Features

- Available with 2, 4, 6, 8, or 12 buttons
- Colors include white, almond, or black
- Metal faceplate options:
 - Black Chrome
 - Brushed Gold
 - Polished Black
 - Polished Gold
 - Polished Brass
 - Stainless Steel
- Primed faceplate available
- All keypads can be custom engraved.
- All keypad buttons are backlit capable and have an LED that serves as a user feedback indicator. Status LEDs are controlled via SIMPL programming or the Crestron D3 Pro software. The illumination of each LED is independently addressable and programmable. Each LED can be programmed to dim at night and return to full intensity during the day
- Each keypad requires 3 watts of power

Crestron keypads can be ganged in one, two or three gang configurations and are mounted in standard electrical junction boxes. Custom multi-gang plates are required.

Mounting in Single-Gang Box

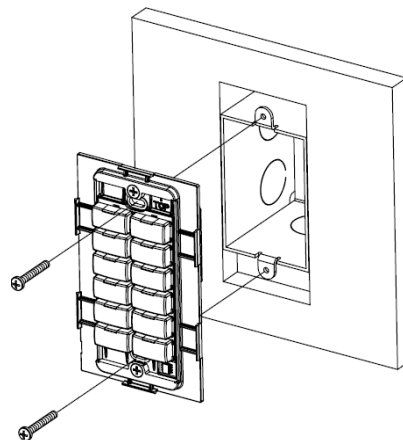

Cameo™

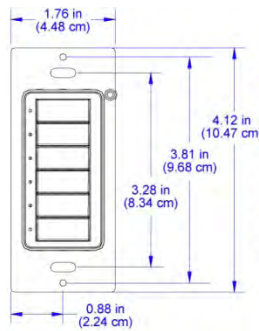

MODELS:
C2N-CBD-W KIT
C2N-CBD-A KIT
C2N-CBD-SM KIT
C2N-CBD-E KIT
C2N-CBD-MS KIT
C2N-CBD-ST KIT
C2N-CBD-B KIT
C2N-CBD-WH KIT
C2N-CBD-CR KIT
C2N-CBD-BT KIT

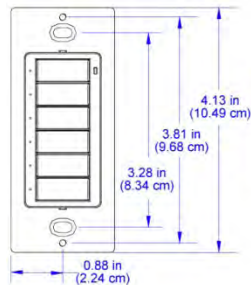

MODELS:
C2N-CBD-W-T
C2N-CBN-B-T
C2N-CBN-A-T
C2N-CBD-W-S
C2N-CBD-B-S
C2N-CBD-A-S

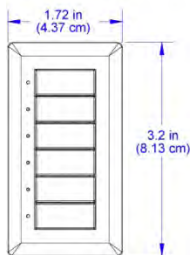

MODELS:
C2N-CBF-W KIT
C2N-CBF-B KIT
C2N-CBF-A KIT
C2N-CBF-EC KIT
C2N-CBF-MS KIT
C2N-CBF-ST KIT
C2N-CBF-SM KIT
C2N-CBF-WH KIT
C2N-CBF-CR KIT
C2N-CBF-BT KIT

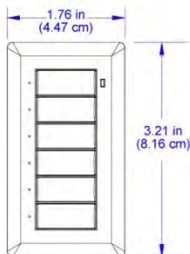

MODELS:
C2N-CBF-W-T
C2N-CBF-B-T
C2N-CBF-A-T

Crestron Cameo presents a fresh, innovative concept in keypad design featuring an incredibly small footprint and slim profile with versatile button configurations.

Cameo Standard Mount

The **C2N-CBD-TS** is a standard mount model designed for installation in a conventional electrical gang-box using a Decora® style faceplate (not included). New smooth and textured finishes match perfectly with popular off-the-shelf decorator faceplates. Available in a variety of designer colors, the smooth finish has a slick, glossy appearance, while the textured finish achieves a softer, satiny look.

Cameo Flush Mount

The Cameo unique flush mount design affords a very discreet appearance occupying just one-third the space of a conventional keypad. Employing a smart spring clamp mounting system, the C2N-CBF-T Cameo Flush Mount model installs easily in drywall without requiring a backbox. Five designer colors are available, each with a satiny, textured finish.

Customizable Buttons

Exquisitely simple yet highly customizable, a single Cameo keypad can be configured easily by the installer to provide from two to six buttons. Each keypad is actually furnished with an assortment of engravable button caps in three different sizes to support a variety of physical layouts. Their smoothly rounded shape and refined pushbutton action give each button press a positive feel with subtle surface relief for an excellent tactile response. Through programming, each button can be configured to support up to three separate functions simply by tapping, double-tapping, or holding the button. "Shift key" functionality is even possible, allowing any button to be held while pressing another. The button caps feature an ergonomically tapered shape for excellent tactile response. The taper of each button can be oriented upward or downward, enabling two vertically adjacent buttons to emulate the feel of a single rocker switch.

Auto-dimming Backlight

Cameo's new high-quality backlit laser engraving provides customizable button text that's easy to read under any lighting condition. A built-in light sensor controls the backlight intensity automatically to achieve a crisp, legible appearance in both darkened and fully lit rooms.

Enhanced LED Feedback

Six pinhead-sized white LED light pipes provide elegant and versatile button feedback. Ten different blink patterns are built in, enabling blinking LED feedback while simplifying programming and minimizing traffic on the Cresnet® network. Built-in bargraph logic allows the feedback LEDs to function as a 6-segment bar graph display to provide a visible level indication when adjusting lighting and audio settings. The overall LED intensity is auto-dimmable, adjusting automatically for optimal visibility under varying lighting conditions.

Contact Closure Inputs

Two sensing inputs are included on the rear of the keypad to provide a simple and convenient interface for low voltage contact-closure devices such as occupancy sensors, door switches, and motion detectors.

Ambient Light Sensor

In addition to controlling Cameo's backlight and LED intensity, the built-in light sensor can also be utilized by the control system to support daylight harvesting and other programmatic functions.

Available Colors and Textures

Black, White, Almond, Brown, Ivory, Brown, Dark Almond, and Dusk in smooth and textured versions.

Cameo™ Mounting Options

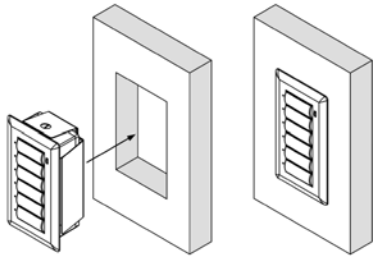

Cameo Flush Mount

Using the supplied template, carefully cut the hole for the Cameo keypad. After the keypad is connected to Cresnet®, insert it in the hole. The spring clip holds the keypad in place.

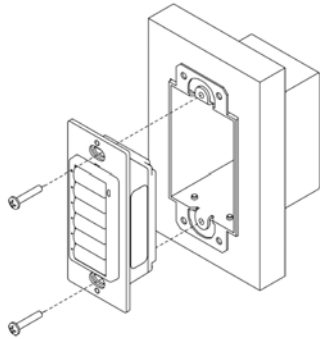

Cameo Standard Mount

Standard mount keypads fit in a standard single-gang box. Finish the installation with a Decora® style faceplate.

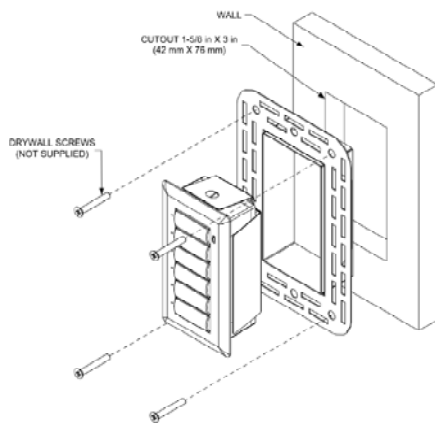

Mud Ring Mount Kit

The Mud Ring Mount Kit (MMK-CBF-T) is the preferred mounting option for the Crestron C2N-CB Series of Cameo keypads when cutouts in the drywall (for the flush-mount keypad installation) are too large. This kit provides support for additional plastering that can be applied to hide irregularities in the cutout.

NOTE: This mounting option is intended for flush-mount keypads only. Do not use the C2N-CB with the decorator-style keypads.

NOTE: A Crestron module in Crestron Database version 17.1.0, the C2N-Cameo Bargraph Feedback v1.0, makes it possible to use the feedback LEDs like a bar graph, for a function such as volume control, where the switches are used to control the volume, the LEDs display its level.

iLux Integrated Lighting Control System

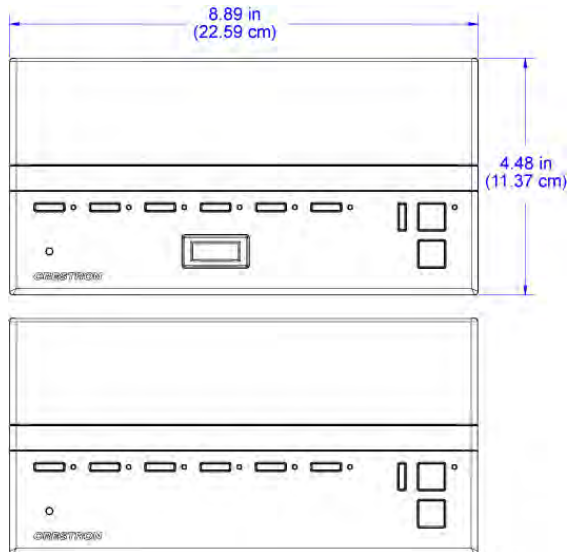

iLux is compliant with ASHRAE Standard 90.1-2004

All CLS Units are CEC Title 24 Listed

iLux is a complete, integrated lighting system designed for wall mount installation in boardrooms, auditoriums, theaters, or anywhere versatile and cost-effective control of lighting and shades is required. The iLux uses high quality integrated dimming, shade control, configurable rocker buttons; extensive integration ability and many other advanced features make iLux the ideal choice for all types of room lighting and shade control.

Dimming

Six channels of dimming are available for incandescent, magnetic low-voltage, neon/cold cathode, and 2-wire dimmable fluorescent loads. Control of on/off switching of many non-dimmable lighting loads is also possible. Each channel will handle up to 800 watts individually, with a total rating of 1920 (Electronic Low-voltage, 3 and 4-Wire Fluorescent, High-Inrush Switching, & 277V via CLS-EXP Series expansion modules)

Room Combining

The iLux has advanced room combining features capable of supporting even the most complex arrangements of divisible rooms. When linked with additional CLS slave units, combining of up to 9 rooms is possible.

Building Management System Integration

Crestron CLS-C6 includes BMS integration capabilities for straight forward inclusion of building management systems as a component of managing energy demands. (Requires DIN-IO8 or GLS-SIM, sold separately).

Shade Control

Using the Crestron networked Shade and Drapе Controllers (sold separately), the iLux devices enables versatile control of 32 motorized window treatments, screens or lifts in up to six groups, without using a lighting control channel.

Energy Management

With the addition of Green Light integration modules and light sensors, the iLux line of Integrated lighting systems allow for the management of room occupancy sensing, daylight harvesting and demand response for maximum energy efficiency and cost savings. (ASHRAE 90.1 and CEC Title 24 compliant)

Interface Support

The CLS line of room controllers can support up to 2 touch panels and up to 16 Keypads without a centralized processor. Individual buttons can be programmed to work through the master unit or can target specific slave units for maximum control and room management.

iLux Features

In Standard and Lights mode, the six bargraphs, each a series of seven LEDs, indicate the current light intensity for the six lighting loads. In Shades mode, they indicate the shade position for each of the shade groups.

Customizable label strip

In Standard mode, the Function buttons are used to select/recall scenes. In Lights and Shade mode, they are used to make temporary adjustments. They can also be programmed to perform other functions.

The IR detector responds to commands from the optional Crestron remote control.

The built-in motion detector can be used to activate/deactivate a particular scene based on room activity.

Three position "rocker" switch programmable for master lights control, master shade control, or as a "shift" button to allow a second set of functions for the six function buttons.

RS-232 programming port

Two-Digit Display

Reset Button

Selects the Lights mode. The LED illuminates when the mode is selected.

Selects the Shades mode. The LED illuminates when the mode is selected.

Navigate and execute setup functions

Shift LEDs indicate when the Shift mode is enabled via programming, two functions defined for each of the six function buttons.

The ON button always acts as a recall scene button for the "On" scene

The OFF button always acts as a recall scene button for the Off scene

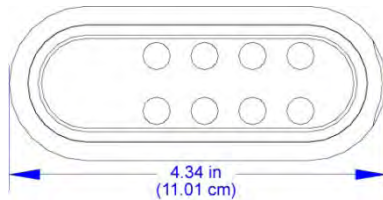
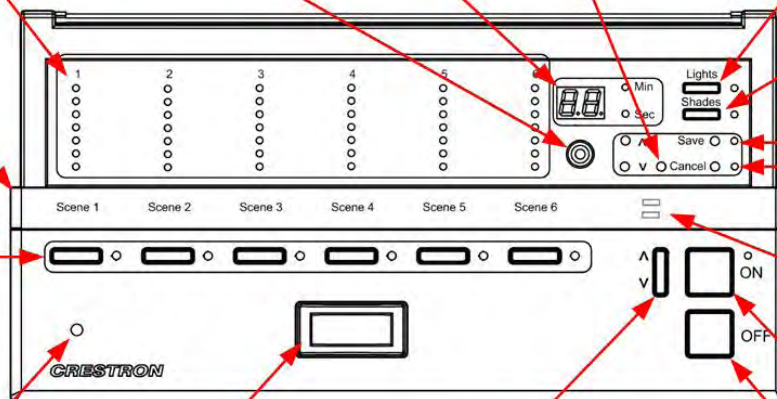

Wireless iLux Remote

The **CLS-IRHT8** is a compact IR wireless remote designed specifically for use with Crestron iLux Integrated Lighting Systems. The CLS-IRHT8 provides buttons for master up/down control, plus activation of scenes 1-4, ON, and OFF. The CLS-IRHT8 is non-programmable, and operates on two AA batteries (included).

Multi-Unit Expansion

One CLS-C6 master will support up to eight additional CLS-C6 (or CLS-C6M) units, enabling systems of up to 54 lighting zones and 54 shade groups. Commands for typical functions like scene recall, scene off, master dimming, and occupancy status are shared between the CLS-C6 units. Each individual unit can still support a complete assortment of local devices including keypads, shade controllers, and motion detectors.

NOTE: Shade groups are independent of lighting control zones.

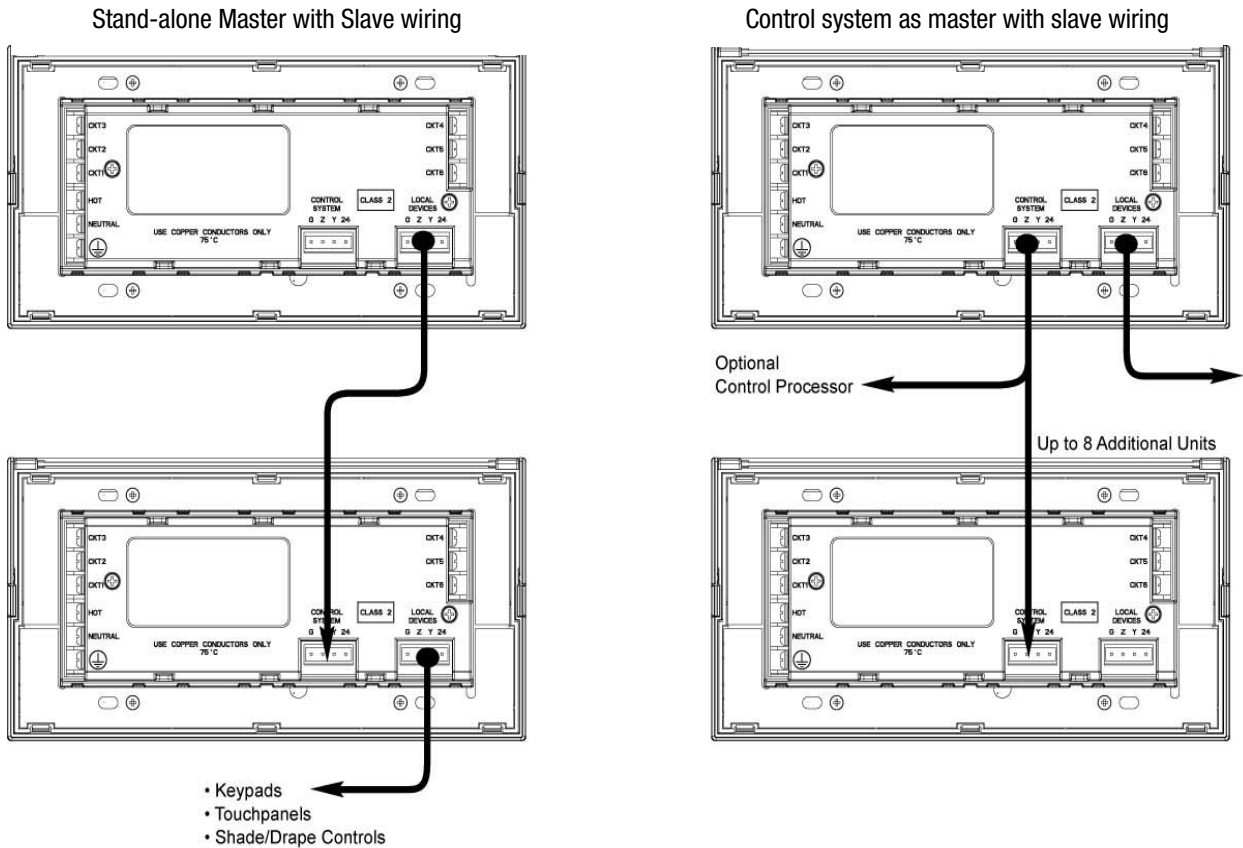

Control System Integration

The **CLS-C6** features two separate Cresnet® control networks, one for local devices and one for connection to a 2-Series control system.

Connecting the CLS-C6 to a control system allows its functions to be controlled from touchpanels, keypads, RF wireless remotes, and even computers.

The control system interface also enables extensive flexibility for integration with other systems such as security, HVAC and energy management, plus remote monitoring via SNMP and Crestron RoomView® applications.

NOTES: Dimmed outputs are not used to directly control outlets or other devices like projectors or AC motor loads. Connecting more than three devices (keypads or shade control modules) will require additional power supplies.

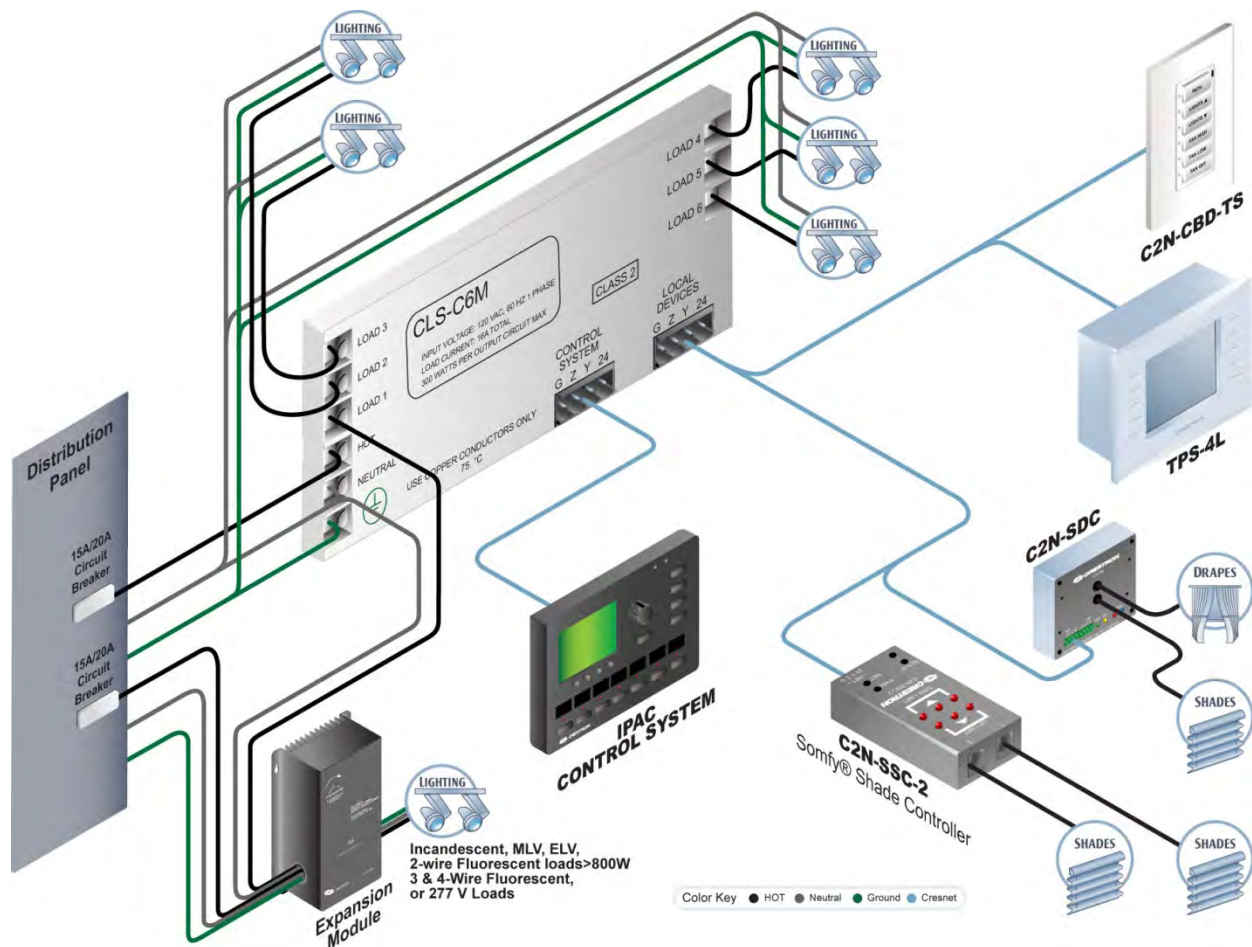

iLux Expansion Modules

All expansion modules are compatible with Crestron CLX-Series, CLW-Series, iLux, and infiNET™ in-wall dimmers.

Model	Load	Function
CLS-EXP-DIM	Supports incandescent, magnetic low voltage, neon/cold cathode, and 2-wire and 3-wire dimmable fluorescent loads (16A per load) 120V, 230V, & 277V compatibility	Forward Phase Dimming
CLS-EXP-DIMU	Supports incandescent, magnetic low voltage, Electronic low voltage, and 2-wire and 3-wire dimmable fluorescent loads (16A per load) 120V, 230V, & 277V compatibility	Forward and Reverse-Phase Dimming Auto Load Type Detection
CLS-EXP-DIMFLV	Supports 4-wire Fluorescent, Incandescent, MLV and ELV loads (16A per load) 120V, 230V, & 277V compatibility	0-10V Fluorescent Dimming plus High Inrush Switching
CLS-EXP-DIMFDB	Supports 3-wire Fluorescent	Fluorescent Dimming

UL2043 rated for use in air handling spaces.

Crestron CLS-EXP-DIM expansion modules are the only units on the market that are code compliant for installation in air handling spaces. Mounting these in the ceiling can save significant wiring costs on your projects.

NOTES: Refer to the wiring diagrams for expansion module connection details.

Each expansion module can control 120VAC /230/277 loads.

Up to four expansion modules of the same type can be controlled in a single zone.

Refer to the Crestron website for additional iLux example diagrams.

Expansion Modules Wiring Diagrams

Separate (Dual) Feed

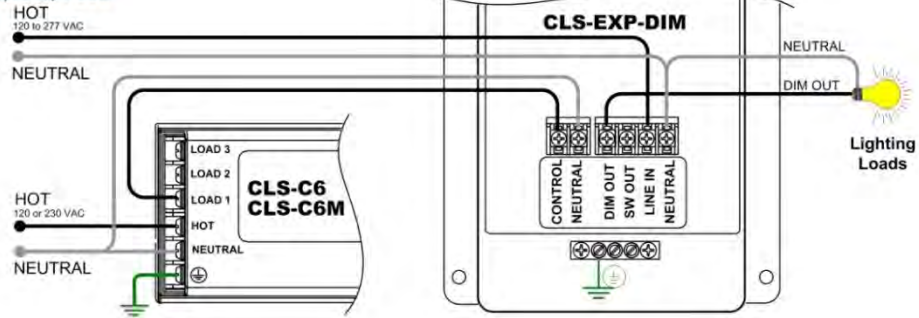

Multiple Expansion Units - Separate Feeds

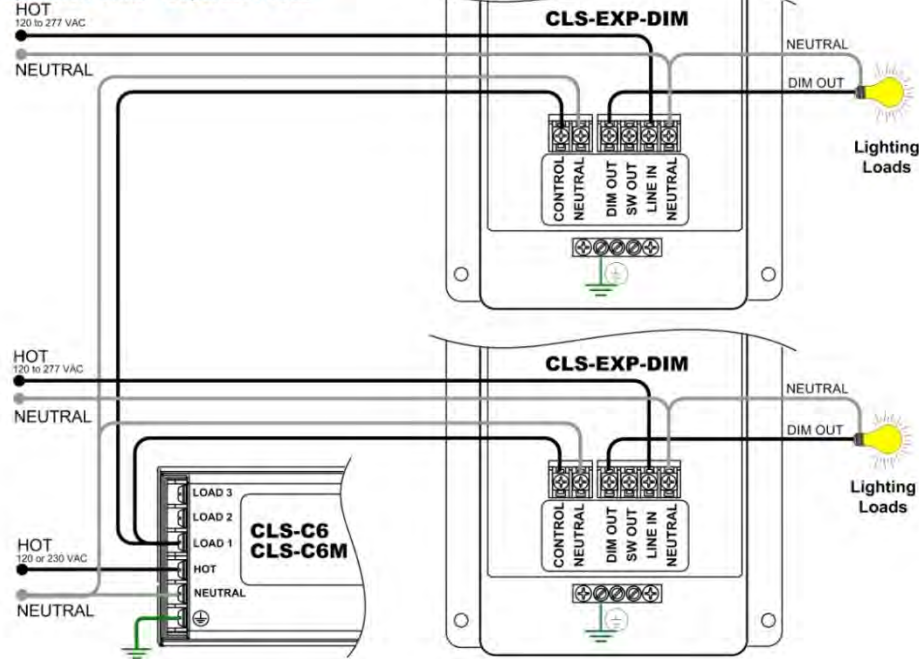

**3-Wire Fluorescent Dimming Ballast
Separate Feeds**

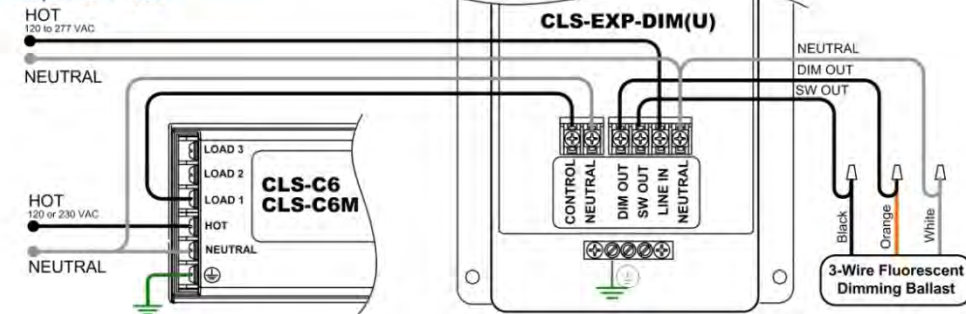

NOTE: 230V feed is available on CLSI units only

Wall Box Dimmers and Switches

Although the following devices are functional as a standalone dimmer or switch, they deliver greatly enhanced functionality as part of a complete Crestron control solution. Designed to replace any standard in-wall dimmer or light switch, when connected to a Crestron PAC2 or PAC2M automation control system (or any other 2-Series control system) via the Cresnet® network, extensive automation and control capability is enabled.

Underwriters Laboratories (UL) safety regulations require an air gap between the contacts. Building on this

requirement, Crestron has expanded the wall box dimmer and switch products to include many new features.

CLW-Series components are available in white, black, and almond and are designed for use with Decora® style faceplates (not included). A dual purpose LED is included to verify preset storage and serve as a beacon to make the dimmer easy to locate in the dark. Its connection to the control system allows the functions of the CLW-DIM to be controlled from touchpanels, keypads, wireless remotes, and computers to support unlimited flexibility for remote control and integration with other devices and systems.

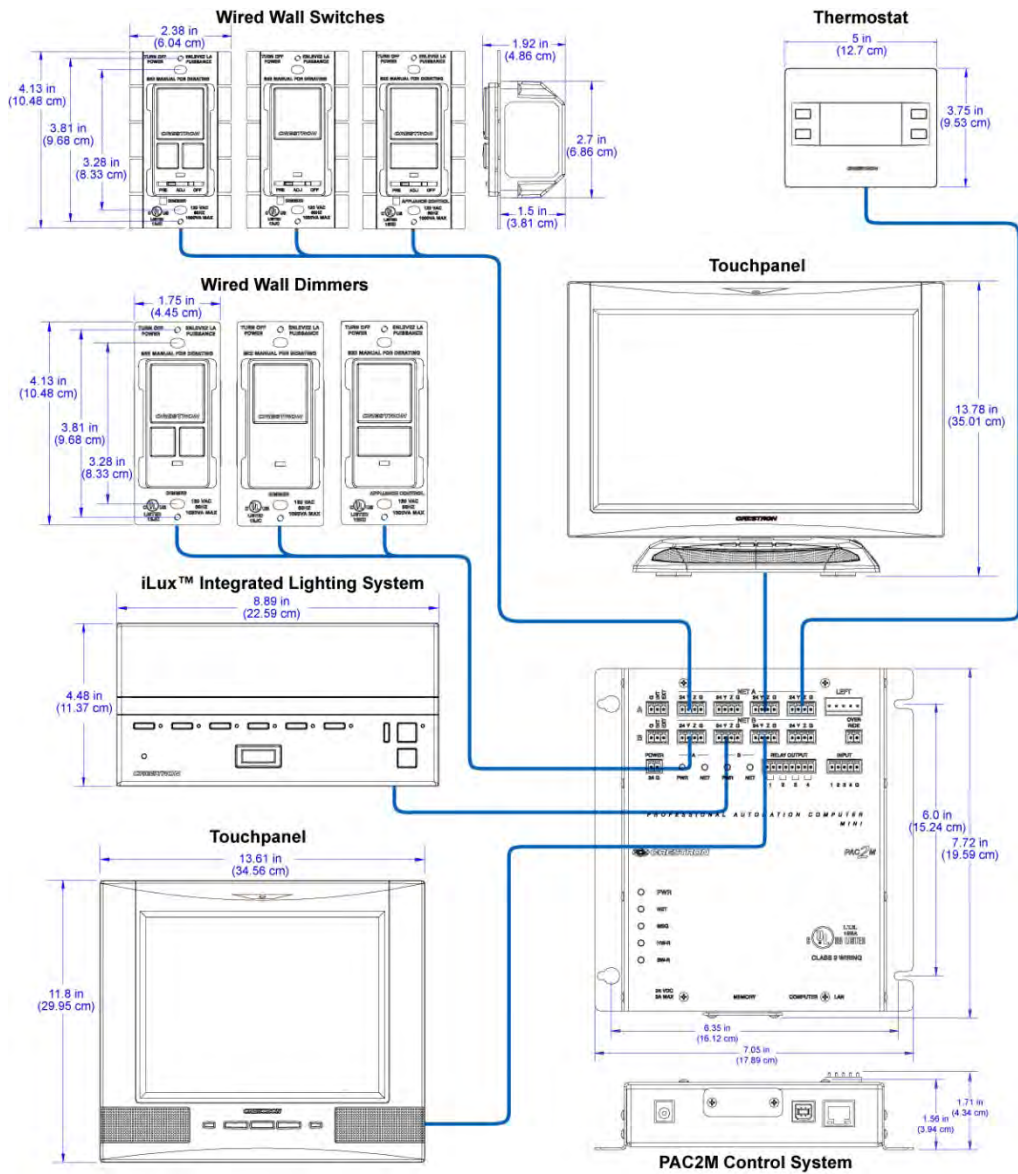

Cresnet Wall Box Dimmers

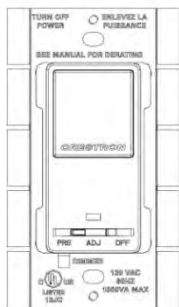
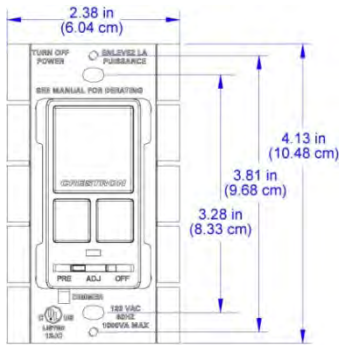

Model	Load	Features
CLW-DIM Wall Box Dimmer (Stand-alone)	Supports incandescent loads up to 1000 watts, or magnetic low voltage loads up to 1000VA/750 Watts	Four possible dimming level presets. The slide switch selects between ADJUST, PRESET, and OFF modes
CLW-DIM1 Wall Box Dimmer, Single Button (Stand-alone)	Supports incandescent loads up to 1000 Watts, or magnetic low voltage loads up to 1000VA/750 Watts	Two possible dimming level presets. The slide switch selects between ADJUST, PRESET, and OFF modes
CLW-DIMS Wall Box Master Dimmer (Master)	Supports incandescent loads up to 1000 Watts, or magnetic low voltage loads up to 1000VA/750 Watts	Four possible dimming level presets. The slide switch selects between ADJUST, PRESET, and OFF modes. Serves as the master for multi-point dimming control of a single load. Multi-point dimming (similar to 3-way or 4-way switching) is enabled using one CLW-DIMS with one or more CLW-SLVD Slave Dimmers.
NOTE: In multipoint systems, only the master unit is connected to Cresnet. Slave units are connected by the 120V (Traveler) wire.		
CLW-SLVD Wall Box Slave Dimmer (Slave)	Supports incandescent loads up to 1000 watts, or magnetic low voltage loads up to 1000VA/750 watts	One-gang wall mount slave dimmer designed for use with the CLW-DIMS Wall Box Master Dimmer to provide multi-point dimming control of a single load. The three pushbuttons on the CLW-SLVD provide parallel functionality to those on the CLW-DIMS
CLW-DIMS1 Wall Box Master Dimmer, Single Button (Master)	Supports incandescent loads up to 1000 Watts, or magnetic low voltage loads up to 1000VA/750 watts	Serves as the master for multi-point dimming control of a single load. Multi-point dimming (similar to 3-way or 4-way switching) is enabled using one CLW-DIMS1 with one or more CLW-SLVD1 Slave Dimmers Two possible dimming level presets. The slide switch selects between ADJUST, PRESET, and OFF modes
CLW-SLVD1 Wall Box Slave Dimmer, Single Button (Slave)	Supports incandescent loads up to 1000 watts, or magnetic low voltage loads up to 1000VA/750 watts	One-gang wall mount slave dimmer designed for use with the CLW-DIMS1 Wall Box Master Dimmer to provide multi-point dimming control of a single load The single pushbutton on the CLW-SLVD1 provides parallel functionality to that on the CLW-DIMS1
NOTE: In Multigang installation the inner tabs must be removed to fit and the load capacity must be derated. See table below for derating information for various applications.		

Derating Information for Incandescent and Tungsten Halogen Applications

Part Number	No Side Removed	One Side Removed	Two sides removed
-DIM1	1000W	600W	400W
-DIMS1	1000W	600W	400W
-SLVD1	No Derating Necessary		

Derating Information for Magnetic Low Voltage Applications

Part Number	No Side Removed	One Side Removed	Two sides removed
-DIM1	1000VA/ 750W	600VA/450WW	400VA/300W
-DIMS1	1000VA/750W	600VA/450W	400VA/300W
-SLVD1	No Derating Necessary		

Cresnet Wall Box Switches



Model	Load	Features
CLW-SW Wall Box Switch (Stand-alone)	Supports incandescent and electronic low voltage loads up to 1000 watts, or magnetic low-voltage and neon/cold cathode loads up to 1000VA/750 watts. Fluorescent ballasts, high-intensity discharge lighting, and ceiling fans can also be switched.	Large button provides instant on/off control of the load, while the small button turns the load off following a preset time delay. The slide switch selects between ADJUST, PRESET, and OFF modes. PRESET mode is the normal operating mode, and ADJUST mode is used for setting the delay time. NOTE: The wall box switches do not support fan speed control. Use the CLX-1FAN4 for fan speed control.
CLW-SW1 Wall Box Switch, Single Button (Stand-alone)	Supports incandescent and electronic low voltage loads up to 1000 watts, or magnetic low voltage and neon/cold cathode loads up to 1000VA/750 watts. Fluorescent ballasts, high-intensity discharge lighting, and ceiling fans can also be switched.	Provides instant turn-on control of the load. Pressing the button again turns the load off following a preset time delay. The time delay can be overridden by tapping the button a second time, turning the load off instantly. The slide switch on the CLW-SW1 selects ADJUST, PRESET, and OFF modes. PRESET mode is the normal operating mode, and ADJUST mode is used for setting the delay time.
CLW-SWS1 Wall Box Master Switch, Single Button (Master)	Supports incandescent and electronic low voltage loads up to 1000 watts, or magnetic low voltage and neon/cold cathode loads up to 1000VA/750 watts. Fluorescent ballasts, high-intensity discharge lighting, and ceiling fans can also be switched	Multiple units may be ganged side-by-side along with other CLW-Series switches and dimmers or non-Crestron devices. The single large button on the CLW-SWS1 provides instant turn-on control of the load. Pressing the button again turns the load off following a preset time delay. The time delay can be overridden by tapping the button a second time, turning the load off instantly. The slide switch on the CLW-SWS1 selects ADJUST, PRESET, and OFF modes. PRESET mode is the normal operating mode, and ADJUST mode is used for setting the delay time.
CLW-SLVS1 Wall Box Slave Switch, Single Button (Slave)	Supports incandescent and electronic low voltage loads up to 1000 watts, or magnetic low-voltage and neon/cold cathode loads up to 1000VA/750 watts.	One-gang wall mount slave switch designed for use with the CLW-SWS1 Wall Box Master Switch to provide multipoint switching control of a single load. The single pushbutton on the CLW-SLVS1 provides parallel functionality to that on the CLW-SWS1.
CLW-SWS Wall Box Master Switch (Master)	1000 watt electronic light switch designed to mount in a standard electrical gang box	Serves as the master for multipoint switching control of a single load. Multi-point switching functionality (similar to 3-way or 4-way switching) is enabled by using the CLW-SWS with one or more CLW-SLVS Slave Switches. The large button on the CLW-SWS allows for instant on/off control of the load, the small button turns the load off following a preset time delay. The slide switch selects between ADJUST, PRESET, and OFF modes. PRESET mode is the normal operating mode, and ADJUST mode is used for setting the delay time. NOTE: The wall box switches do not support fan speed control. Use the CLX-1FAN4 for fan speed control.
CLW-SLVS Wall Box Slave Switch (Multipoint Slave)	1000-Watt electronic light switch designed to mount in a standard electrical gang box	One-gang wall mount slave switch designed for use with the CLW-SWS Wall Box Master Switch to provide multipoint switching control of a single load. The pushbuttons on the CLW-SLVS provide parallel functionality to those on the CLW-SWS.
NOTE: In systems, only the master unit is connected to Cresnet®. Slave units are connected by the 120V (Traveler) wire.		

infiNET™ Wireless Technology

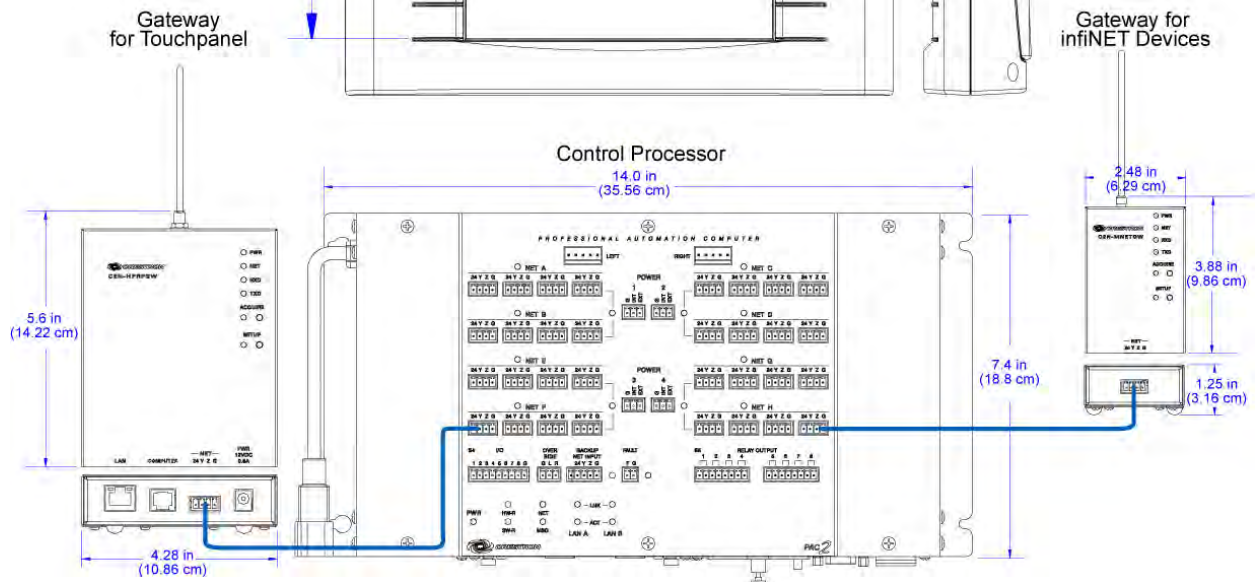
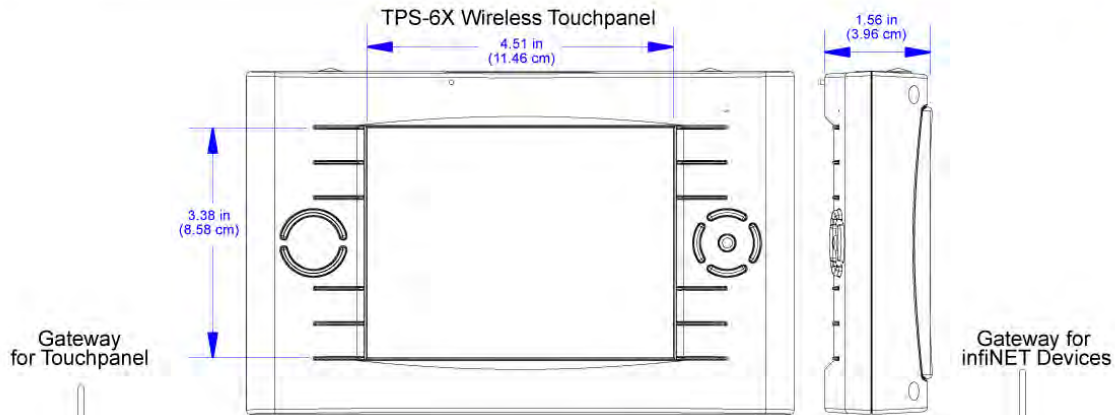
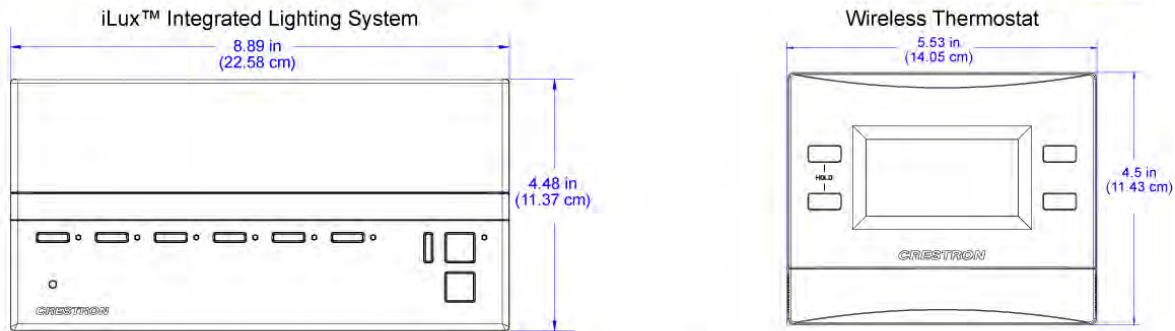
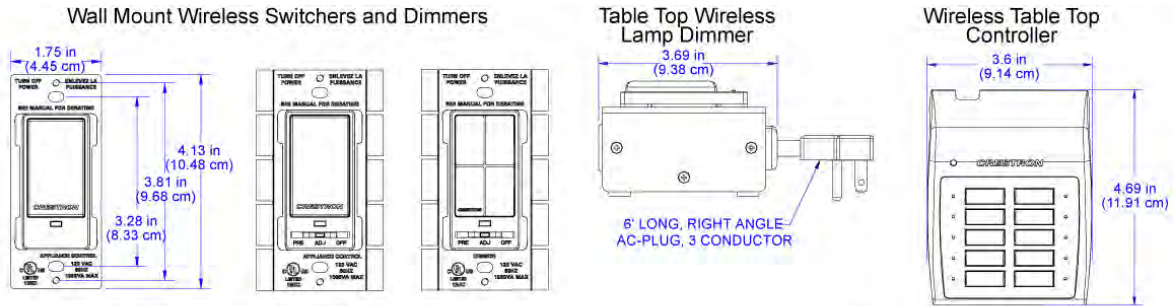

infiNET Dimmers, Switches, and Thermostat

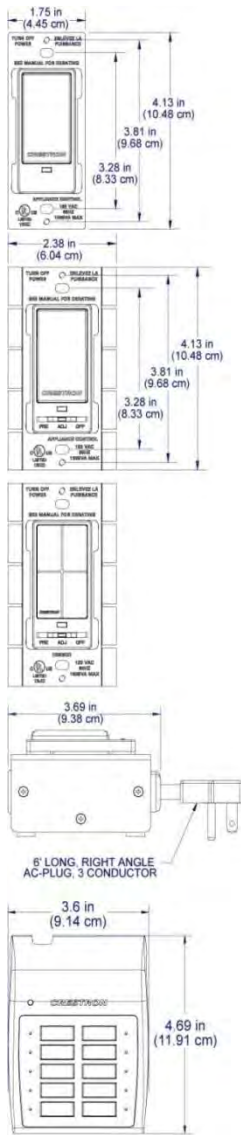

Model	Load	Function
CLW-DIM1RF infiNET Wall Box Dimmer	1000-watt wall mount dimmer	The single large rocker button provides access to three user presets. With each selection, the lighting levels fade naturally between each preset level. Pressing and holding the rocker button up or down allows manual adjustment of the lighting level.
CLW-DIM4RF infiNET Wall Box Dimmer and Keypad	1000-watt wall mount dimmer and programmable keypad	All four pushbuttons are software programmable for any Crestron system function, enabling control over additional lighting circuits, fans, drapes, audio levels, etc.
CLW-DIMS1RF infiNET Wall Box Master Dimmer	1000-Watt wall mount dimmer	Multipoint dimming is enabled using one CLW-DIMS1RF master dimmer along with one or more CLW-SLVD1RF slave dimmers. Multipoint dimming is similar to conventional 3-way or 4-way switching, allowing dimming control of a single load from multiple locations in the room.
CLW-DIMS4RF infiNET Wall Box Master Dimmer and Keypad	1000-watt wall mount dimmer and programmable keypad	Multi-point dimming is enabled using one CLW-DIMS4RF master dimmer along with one or more CLW-SLVD1RF slave dimmers. Multipoint dimming is similar to conventional 3-way or 4-way switching, allowing dimming control of a single load from multiple locations in the room. All four pushbuttons are software programmable for any Crestron system function, enabling control over additional lighting circuits, fans, drapes, audio levels, etc.
CLW-SLVD1RF infiNET Wall Box Slave Dimmer	1000-watt wall mount slave dimmer	Slave dimmer designed for use with the CLW-DIMS1RF and CLW-DIMS4RF infiNET master dimmers.
CLW-SW1RF infiNET Wall Box Switch	1000-watt wall mount switch	The single large rocker button provides simple on/off operation to control a range of lighting or fan loads. An adjustable turn-off delay allows the user time to exit the room before the lights shut off.
CLW-SWS1RF infiNET Wall Box Master Switch	1000-watt wall mount switch	Multi-point switching is enabled using one CLW-SWS1RF master switch along with one or more CLW-SLVS1RF slave switches. Multipoint switching is similar to conventional 3-way or 4-way switching, allowing control of a single load from multiple locations in the room.
CLW-SW4RF infiNET Wall Box Switch and Keypad	1000-watt wall mount switch and programmable keypad	An adjustable turn-off delay allows the user time to exit the room before the lights shut off. All four pushbuttons are software programmable for any Crestron system function, enabling control of additional lighting circuits, fans, drapes, audio levels, etc.
CLW-SWS4RF infiNET Wall Box Master Switch and Keypad	1000-watt wall mount switch and programmable keypad	All four pushbuttons are software programmable for any Crestron system function, enabling control of additional lighting circuits, fans, drapes, audio levels, etc. Multipoint switching is enabled using one CLW-SWS4RF master switch along with one or more CLW-SLVS1RF slave switches. Multipoint switching is similar to conventional 3-way or 4-way switching, allowing control of a single load from multiple locations in the room.
CLW-SLVS1RF infiNET Wall Box Slave Switch	1000-watt wall mount slave switch	Slave switch designed for use with the CLW-SWS1RF and CLW-SWS4RF infiNET master dimmers.
CLF-DIMRFB infiNET Lamp Dimmer	500 watts V/A Dimmer	Freestanding dimmer module designed to sit on the floor to provide dimming control of a conventional floor lamp or table lamp. It enables local dimming control via a built-in footswitch, and remote control via infiNET.
HTT-B10X infiNET Table Top Controller		The HTT-B10X is a simple, convenient wireless controller. Two-way infiNET wireless operation supports true-feedback. A clean array of 10 backlit pushbuttons with individual feedback LEDs affords easy, tactile control of any custom function. The HTT-B10X is a fully-programmable controller designed to operate as part of a complete Crestron automation system, communicating via the infiNET wireless control network.
CHV-TSTATRF Wireless Networked Thermostat		The CHV-TSTATRF is designed for heating and cooling control of baseboard, forced air, heat pump, and dual-fuel heat pump HVAC systems. The large backlit LCD display provides a clear view of current temperature, setpoint, system mode, fan status, and setup functions. Climate control features include separate heating and cooling setpoints, and adjustable anticipators to prevent overshooting the desired temperature. Continuous fan operation can be selected when needed for increased circulation.

Example infiNET system

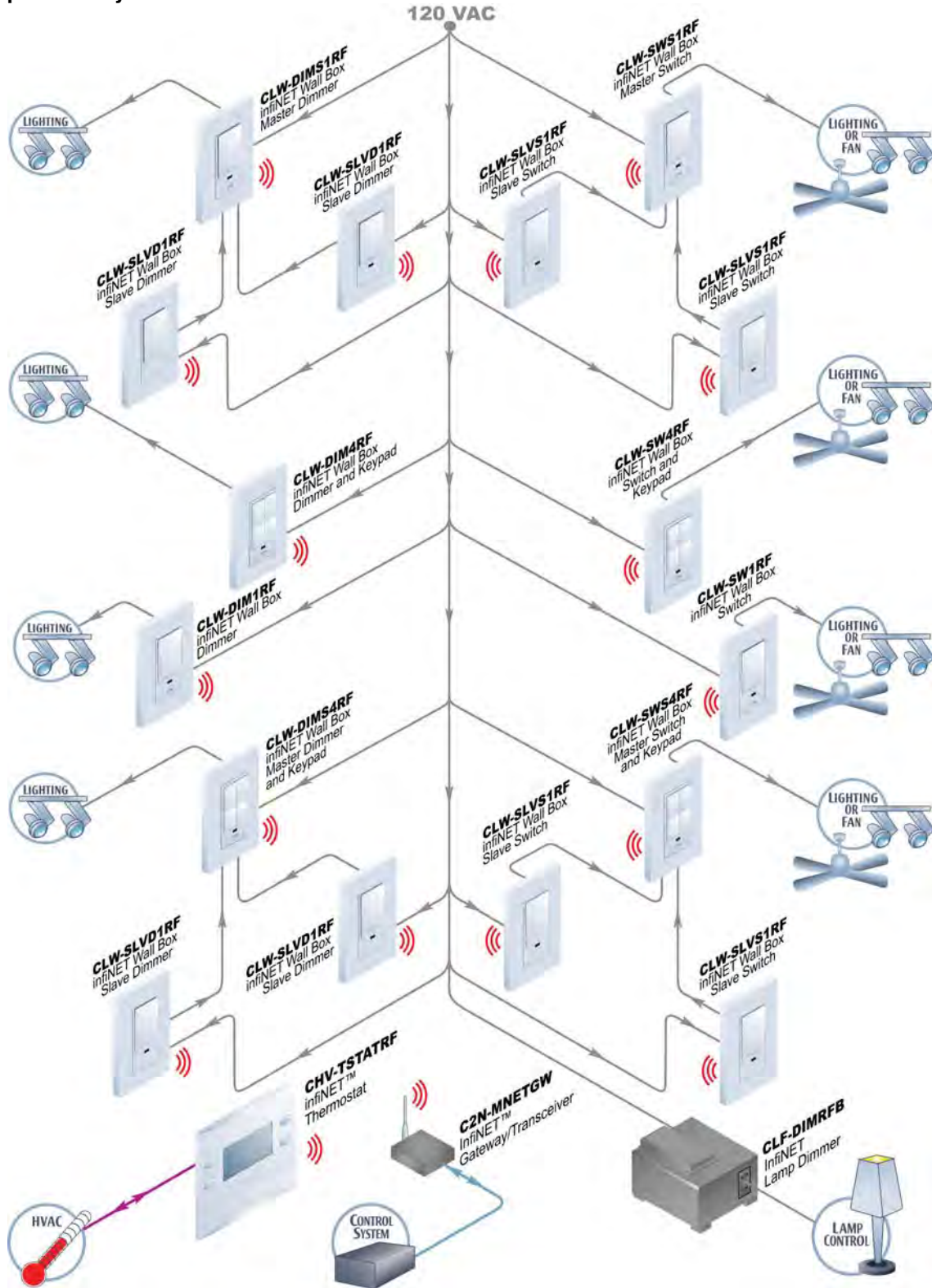

Control Processors

PAC2 Lighting Control Processor

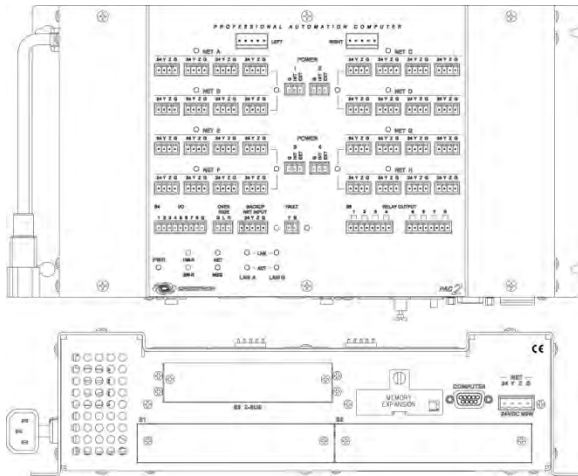

The PAC2 enables efficient control of lighting and other systems such as HVAC and security, and has been specifically designed for the Crestron automation enclosure and the Crestron lighting system (although other Crestron processors can also be used).

The PAC2 occupies one module space in single-width enclosures and two module spaces in double-width enclosures.

NOTE: Crestron recommends that the control processor be mounted within a separate CAEN enclosure to create a simplified low voltage wiring center.

Cresnet® Distribution

The built-in Cresnet Hub/Repeater serves as a repeater, splitter, and wiring block. The hub allows for 252 or more devices (touchpanels, keypads, etc.); 32 per segment (A-H) and distribution up to 3000 feet of Cresnet cable run per segment. There are eight independent segments, each with four Cresnet connectors wired in parallel. In addition, there is a master NET port on the bottom panel. The eight NET (A-H) activity LEDs illuminate when a device on the respective segment transmits data. When powered by the internal power supply, a maximum of 50 watts (DC) is available for all connected network devices. The LEDs indicate communication on the Cresnet link.

Memory Expansion

The on-board 36MB memory is enhanced with a 4GB expansion slot that supports off-the-shelf Type II compact flash memory and the IBM Microdrive® hard disk drive, for

on-board storage of program and touchpanel files, room and equipment profiles, upgrades, databases, and schedules. Memory is non-volatile to protect against power loss.

Ethernet and e-Control®2

The unique Crestron dual bus system, with its high speed I/O bus architecture, provides blazing fast throughput, system wide. The two 40Mb/s Y-BUS expansion slots offer the option of installing any of the CNX-series cards and all C2-series control cards listed in the Crestron Product Catalog. The 300Mb/s Z-BUS expansion slot is designed for super high speed control card applications such as 10/100 Ethernet, available via the Crestron single-port C2ENET-1 or dual-port C2ENET-2 cards.

The PAC2 also provides true secure network communications, which is required for today's corporate networks, automated residence systems, and the Internet. The Dual Port 10/100BaseT Ethernet card (C2ENET-2) supports dynamic and static IP addressing and full duplex TCP/IP and UDP/IP. It offers a WAN port for Internet and remote-location communications and a LAN port for local in-home or in-office use. A built-in firewall delivers network security with the Network Address Translator (NAT) and router functions. The built-in Web server uses memory storage on a compact flash card for remote access and control.

Backup and Override

The PAC2 provides external connections for both a backup processor and emergency override closure signals. In the absence of Cresnet, a signal is generated to switch power and communication of the Cresnet system to the backup processor. When the override connection receives a contact closure, a signal is passed to the lighting modules via the fifth wire of the module interconnect cable, and the lights are turned on to a programmed preset emergency level. They remain at this level until that contact closure is removed.

The **Backup Net Input** connector allows a backup control system to automatically take control of the Cresnet network in the unlikely event of an internal processor failure. The exclusive, built-in Cresnet watchdog switches over when the CPU fails.

The **Fault** connector provides a dry contact closure fault signal to notify an external control system when the PAC2 has a system fault. This output is connected to a digital input of the backup computer. A fault is defined as the CPU not interacting with Cresnet® for 10 seconds. The watchdog switches back if the backup computer is inactive for 10 seconds.

The PAC2 offers eight programmable analog and digital inputs as well as digital outputs. There are eight normally open relays, isolated with MOV suppression.

PAC2 Power Management & Requirements

When power requirements exceed 50 watts, additional power supplies may be added. For example, each keypad in the CNX-B series uses 3 watts, therefore only 15 keypads (allowing for a margin of safety) can be connected without adding an additional power supply.

To ensure sufficient power to accommodate all the Cresnet devices (keypads, touchpanels, shade/drape controllers, thermostats, sensors, and other interfaces) and to include voltage drops and wire runs, Crestron recommends the CLX-PWS75 75-watt Cresnet power supply module, or the C2N-SPWS300 300-watt system power supply.

The 75-watt power supply is designed to mount in a CAEN Automation Enclosure. A single CLX-PWS75 can be installed in any single-width enclosure, or up to two may be installed side-by-side in a double-width enclosure. Four (4) Cresnet power ports are provided on the CLX-PWS75, which may be used to supply power directly to Cresnet devices, or connect to the external power input ports of a PAC2 or PAC2M.

If the power needed for a hub segment exceeds the power available from the internal supply (50 watts, maximum), remove the jumper from the supplied 3-pin mini connector to disconnect the internal power supply, then connect the 24VDC and ground wires from an external source (Crestron 24 VDC - regulated power supply) to the EXT and G pins.

The 300-watt power supply, specifically designed for large Cresnet control systems, operates with an input of

100 to 240 VAC, 4A (maximum) and a noise rating less than 150mV. The C2N-SPWS300 provides regulated 24 VDC, 300-watts to Cresnet system components. The C2N-SPWS300 is capable of delivering a nominal 75 watts of power at 24 volts DC on any of its eight channels.

The CLX-PWS75 is a 75 watt Cresnet Power Supply Module designed to mount in a CAEN Automation Enclosure. A single CLX-PWS75 can be installed in any single-width enclosure, or up to two may be installed side-by-side in a double-width enclosure. Four (4) Cresnet power ports are provided on the CLX-PWS75, which may be used to supply power directly to Cresnet devices, or connect to the external power input ports of a PAC2 or PAC2M.

Additional power supplies should not be mounted on CAEN-UMP plates in an enclosure that contains dimmer units because this introduces low voltage in the high voltage section of the enclosure. If required, an extra power supply, attached to a CAEN-UMP plate, can be added to a separate CAEN enclosure.

Mounting the PAC2 in a double-wide enclosure

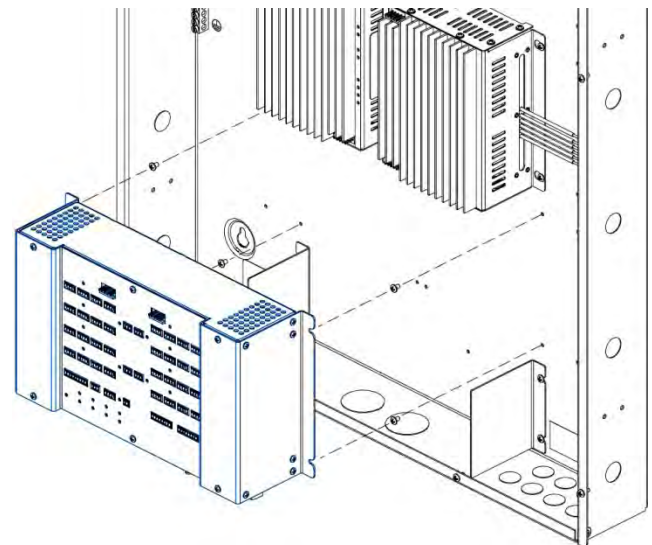

Refer to the PAC2 Operations Guide (Doc. 5941) for more detailed information.

PAC2M Professional Automation Mini Control System

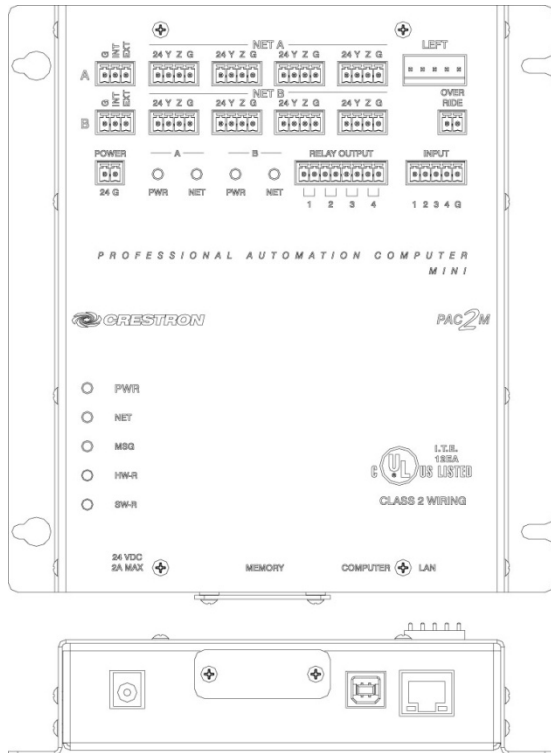

The PAC2M is a compact, low-cost alternative to the PAC2 designed for small lighting and automation applications. At half the size of a PAC2, the PAC2M is perfect for apartments and smaller homes as well as individual meeting rooms and MDU applications.

2-Series Control System

Built upon the reliable Crestron 2-Series control engine, the PAC2M is extensively programmable using the Crestron suite of powerful development software and vast database of drivers and software modules. The PAC2M works seamlessly with the entire Crestron line of lighting dimmers and shade controls, keypads and touchpanels, thermostats, wireless gateways, and expansion modules.

Whole House Integration

The PAC2M provides for the integration of non-Crestron devices and subsystems through a host of control interfaces. Four isolated relays and four digital input ports are built in to accommodate motion sensors, contactors, door strikes, and other low-voltage controls. Additional relays, I/O ports, serial COM ports, DTMF interfaces, and shade controllers can be added using Crestron expansion modules at any location throughout a residence or commercial facility.

Modular Enclosure or Wall Mount Installation

The PAC2M is designed to install in a CAEN automation enclosure and provide a direct bus to a cabinet full of CLX-Series lighting control modules. The PAC2M can also be mounted directly to a suitable surface without an enclosure where allowed.

NOTE: A separate supplemental power supply is required for the PAC2M. It is recommended that power fed to the PAC2M processor comes from a clean and uninterrupted source.

Ethernet and e-Control^{®2}

Built-in 10/100 Ethernet facilitates secure high speed network connectivity, enabling extensive capabilities for remote system maintenance and control, and providing an interface to other Crestron control systems. Native features include a built-in email client to report system troubles and other functions to a homeowner or maintenance/service company via instant email notification. An onboard Web server provides the foundation for the exclusive Crestron e-Control 2 XPanel technology, providing secure IP-based remote control using any Windows computer or CE/PocketPC[™] PDA device.

RoomView[®] and SNMP

For large facilities utilizing multiple PAC2M and other control systems, the exclusive Crestron RoomView Help Desk software delivers a comprehensive solution for remote monitoring and asset management. Also, built-in SNMP support enables similar capability using third-party network management software, allowing full control and monitoring from the IT Help Desk or NOC in a format that's familiar to IT personnel.

Cresnet[®] Distribution

Cresnet is the communications backbone for Crestron lighting modules, wall box dimmers, thermostats, keypads, and many other devices. This flexible 4-wire bus streamlines the wiring of a complete Crestron lighting system. The PAC2M provides connectivity for numerous Cresnet devices on multiple homeruns via 8 separate Cresnet ports. Its built-in Cresnet hub provides two isolated segments, each supporting 3000 feet of cabling and approximately 25 Cresnet devices. The Cresnet ports are arranged into two separate power groups providing a clean, flexible 24 Volt DC power distribution solution. An external power supply is required (sold separately).

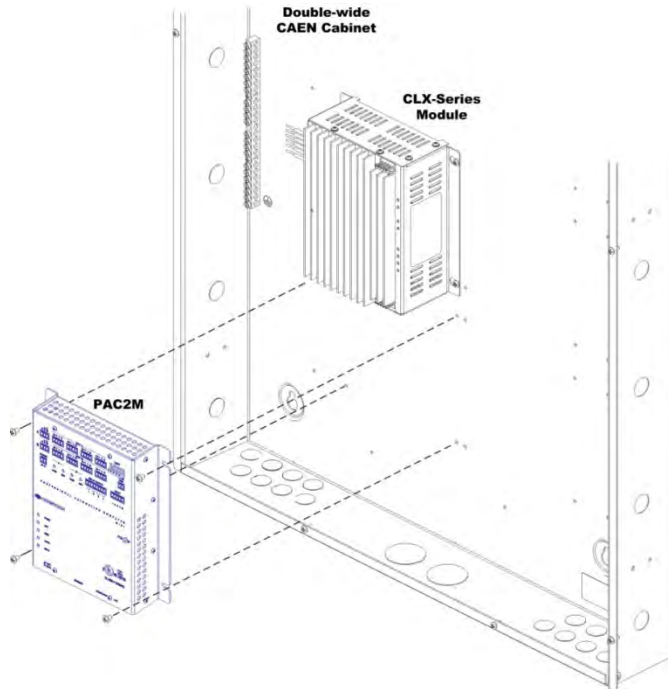

Override

An override input is provided to allow an external contact closure to bypass the PAC2M and activate a preset override state in each connected lighting module. A signal is passed to the lighting modules via the fifth wire of the interconnect cable, and the lights are turned on to a programmed preset emergency level.

Memory Expansion

A memory card slot allows for easy expansion of the PAC2M's internal memory using any MMC-compatible memory card up to 1 GB.

Double Width Enclosure Mounting

Module and associated terminal block installed in double width enclosure. The PAC2M processor occupies the lowest module position in either the single or double enclosure.

For additional information, refer to the PAC2M Operations Manual, Doc. 6507.

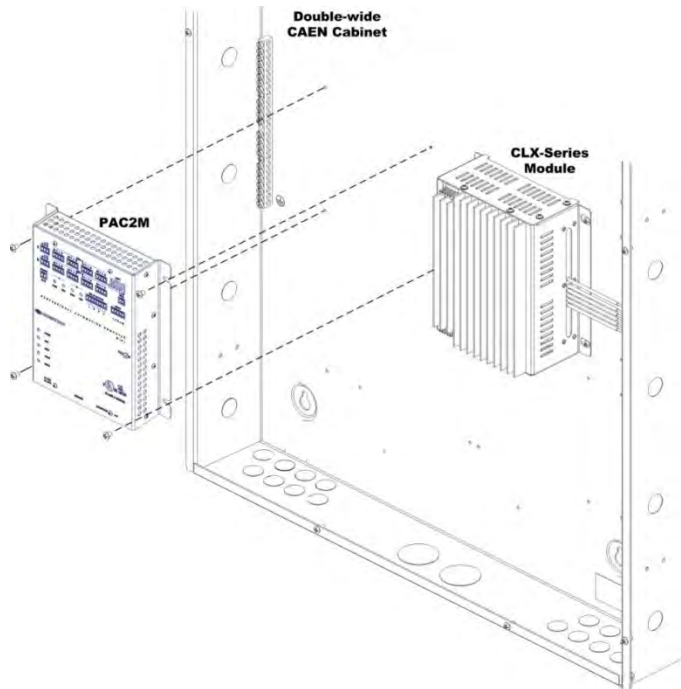

Basic Lighting System Interconnections

An example of a Crestron Lighting System that includes thermostat, shade control and interfaces

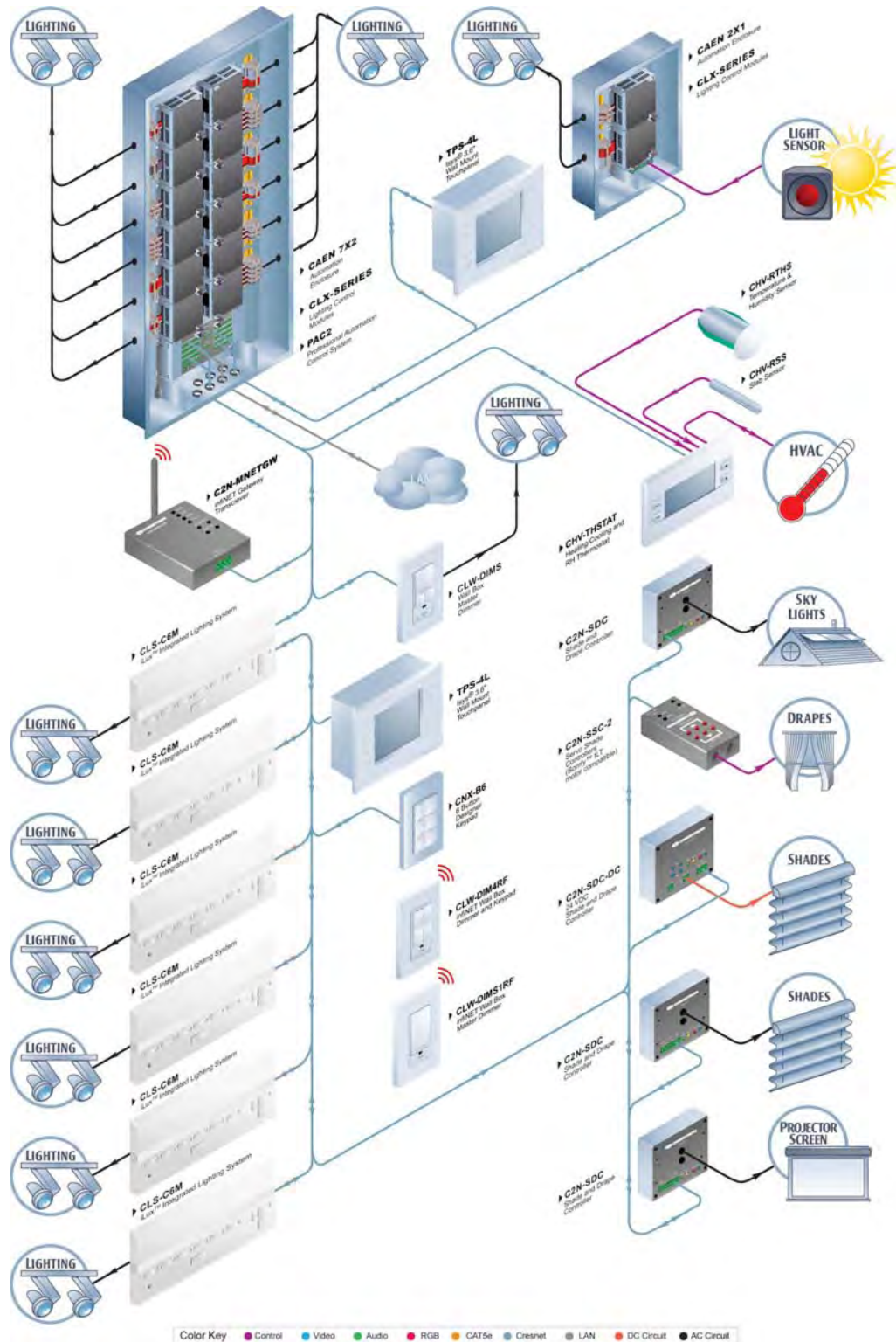

Occupancy and Photocell Sensors

GLS-ODT & GLS-OIR



Green Light Occupancy Sensors

Crestron Green Light™ sensors deliver a powerful and cost-effective solution for reducing energy costs and enhancing the functionality of lighting and environmental systems. Crestron offers ceiling and wall mount occupancy sensors for areas up to 2500 square feet.

Advanced self-adaptive motion sensing using a combination of ultrasonic and passive infrared technologies affords extreme reliability for control of lighting, climate control and other devices in the room. A built-in photocell can be set to override the occupancy sensor if the ambient light level is above a set threshold, preventing lights from turning on when there is sufficient daylight in the room.

Sensors are easily connected to the lighting control processor via the Cresnet control network using a GLS-SIM Sensor Integration Module. Alternately, they may be connected directly via a digital input port. Please refer to the product specification sheet for complete information.

Model	Mount Type	Coverage Area	Coverage Pattern
GLS-OD T-C-500	Ceiling	500 sq ft	180 degrees
GLS-ODT-C-1000	Ceiling	1000 sq ft	360 degrees
GLS-ODT-C-2000	Ceiling	2000 sq ft	360 degrees
GLS-ODT-W-1200	Wall	1200 sq ft	110 degrees
GLS-OIR-C-450	Ceiling	450 sq ft	360 degrees
GLS-OIR-C-1500	Ceiling	1500 sq ft	360 degrees
GLS-OIR-W-2500	Wall	2500 sq ft	110 degrees

GLS-LOL & GLS-LCL



Green Light Photocell Light Sensors

Crestron Photocell Light Sensors are designed for daylight harvesting applications to control the balance of natural and artificial lighting in an indoor space. By harnessing natural daylight from windows and skylights, electrical lighting can be turned off or dimmed, reducing energy usage while maintaining a consistent light level for a more efficient and comfortable work space. Outdoor lighting may also be turned off and on automatically using a photocell light sensor.

Please refer to the product specification sheet for complete information.

Model	Field of View	Light Sensitivity
GLS-LCL	60 degree cone	0 to 70 foot candles
GLS-LOL	60 degree cone	3 to 6000 foot candles

Integrated Shade and Drape Controllers

C2N-SDC

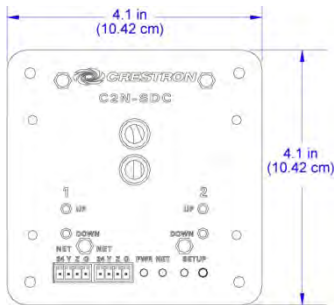

The C2N-SDC is a 2-channel shade and drape controller designed to provide a convenient and cost-effective solution for controlling a variety of motorized window treatments as well as motorized doors, sunroofs, lifts and projection screens.

The C2N-SDC is a Cresnet® device with two independently controlled 120V AC outputs. Each output provides up/down or open/close control of a conventional 3-wire bidirectional type motor. Built-in timing and interlock logic make it easy to program the C2N-SDC for fail-safe operation.

The C2N-SDC mounts in the wall or ceiling using an off-the-shelf 4" square or 2-gang electrical box. Pushbuttons on the front of the unit allow for manual operation of the motors during installation and setup.

C2N-SDC-DC

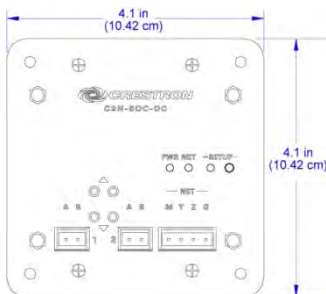

The C2N-SDC-DC is a 2-channel shade and drape controller designed to provide a convenient and cost-effective solution for controlling 24 volt DC motorized shades and drapes. The C2N-SDC-DC is a Cresnet device with two independently controlled 24V DC outputs, each designed to provide standard up/down or open/close control of a conventional two-wire bidirectional type motor.

The C2N-SDC-DC mounts in the wall or ceiling using an off-the-shelf 4" square or 2-gang electrical box. Pushbuttons on the front of the unit allow for manual operation of the motors during installation and setup.

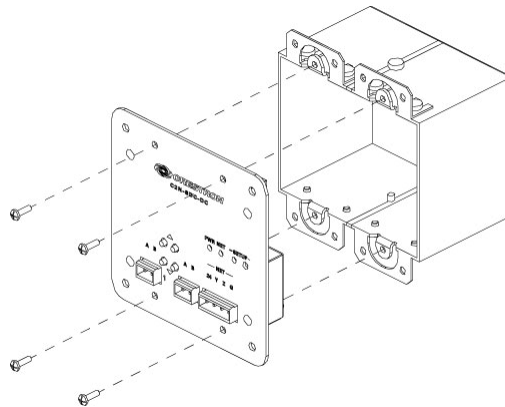

C2N-SSC-2

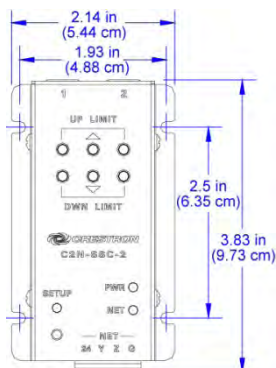

The C2N-SSC-2 Somfy Shade Controller is a compact Cresnet device designed to provide a bidirectional serial interface for up to two Somfy ILT Intelligent Shade Motors (<http://www.somfy.com/nam/index.cfm>). Window treatments equipped with the Somfy ILT motor offer enhanced capability compared to typical 3-wire models.

In addition to basic open/close commands, the C2N-SSC-2 allows for setting each shade to a specific position and polling for its current position with 16-bit precision. Feedback signals provide confirmation of each motor's activity to enable precise, predictable control, even from a remote location. Limit adjustments are set electronically using buttons provided on the face of the unit, and up to 20 presets for each output can be saved onboard the C2N-SSC-2 for easy recall through the control system. The C2N-SSC-2 mounts discreetly to any flat surface and requires a simple Cresnet connection to the control system.

Integrated Partner Modules

Crestron Electronics, Inc. Integrated Partner Program allows partner manufacturers' products to operate seamlessly in a Crestron systems environment. Integrated Partner Modules offer the Crestron control systems programmer a simplified, timesaving drag-and-drop solution for integration of partner products.

The Crestron Integrated Partner Program initiative makes it easy to take advantage of the enhanced functionality afforded by using a manufacturer's **serial**, **Ethernet**, or other **enhanced interface**. Integrated Partner Modules are created specifically for popular audio/video, security, lighting, HVAC and other products that incorporate communications protocol, relays, etc. We have created this collection of modules for our dealers to easily incorporate Integrated Partner's products into a Crestron network solution.



For a complete list of partners refer to:

http://www.crestron.com/tools_and_resources/programming_and_integration_resources/integrated_partner_modules/default.asp?browseby=manufacturers

Integrated Systems

Following are examples of the more common systems we integrate into both commercial and residential environments.

Audio/Video	Lighting Systems	HVAC	Security
<p>Integrated Partner business or home entertainment solutions allow you to easily control and enjoy your business presentations, home theater or audio distribution systems. Want to make a presentation, watch a movie? Press the appropriate icon and the drapes close, lights dim, projector turns on, audio engages and the experience begins... all while the popcorn pops.</p>	<p>Integrated Partner lighting systems work seamlessly in a Crestron environment.</p> <p>Depending on your lighting system you may enjoy party mode to brighten up the house for your guests, integrate it into "movie" mode, or set the system to "vacation" mode, for random lighting patterns giving your home that live-in look while you're away.</p>	<p>Integrated Partner heating and air-conditioning systems, pools and spas may also be incorporated into a Crestron system.</p> <p>Set the temperature and humidity range you most enjoy and live comfortably, regardless of the season.</p>	<p>Integrated Partner security companies trust Crestron to control and monitor their systems.</p> <p>Peace of mind is a touch away. Whether setting your system before retiring for the evening or receiving an e-mail that your family forgot to set the system before leaving for the day, Crestron-controlled security partners are there for your protection.</p>

Appendix A:

RoomView® Remote Asset Management

Crestron RoomView® is the first and only real time, multi-user remote asset management software that delivers complete facility-wide network control of lighting resources, HVAC and AV. RoomView works seamlessly with Crestron control systems and touchpanels to manage an entire network of devices and subsystems. RoomView is available in two versions to serve the control and management requirements for every situation.

RoomView allows administrators and support staff to manage AV resources, perform remote system diagnostics, track the usage of projector lamps, log network activity, monitor rooms, and automate tasks through event scheduling. An ideal master controller, RoomView remotely locks out selected rooms to prevent unauthorized use of AV equipment. In fact, RoomView can track any Crestron-based function, including lights, temperature, audio levels, motion detection, and much more. Interactive help desk capabilities allow users to send help requests from their touchpanel or Web browser. Support staff can send text messages back to the touchpanel, alert email contacts, and even launch e-Control® 2 to control the room and its AV equipment.

The valuable power of Crestron RoomView (both Express and Server Editions) extends far beyond the general description in this design guide. The Crestron control processor is capable of monitoring and/or controlling devices, in any and all realms of digital, analog or serial control.

RoomView, the industry's most powerful asset management tool, is second-to-none. The abilities of RoomView have been extended beyond the control and management of lighting and AV equipment to incorporate interfacing with other control systems (i.e., security and HVAC). Crestron design teams and regional support team members stand ready to help in the design of applicable RoomView features/attributes/abilities into your projects. Crestron welcomes your questions regarding RoomView...solutions are just a phone call or email away.

RoomView Server Edition

RoomView Server Edition offers enhanced customization, advanced plug-in modules, and both real-time PC and web-based clients that run simultaneously. Now facility managers, media directors and IT specialists have the best of both worlds – unmatched real-time control and cross-platform accessibility.

This multi-user resource and asset management program offers a high level of customization and efficiency, and features a “MyRoomView” environment, providing a personalized home page for every user.

The central screen area can be custom configured to display a selected overview of attributes for multiple rooms, a single room detail view, or room scheduling.

A choice of plug-in modules provides views such as Daily Schedule, Calendar, Room Hot List, Action Items, Instant Messaging, e-Control, Service Status, and Room Web Cam.

Manage and control every room from any PC. With RoomView Server Edition®, every room is connected, Features include:

- Web-based cross platform and PC executable interfaces
- Customizable and user-defined interface
- Direct database integration with SQL Server
- Fully Intergrated with MS Exchange Server for scheduling
- Networking support including DHCP and SSL
- Windows Event Log Support
- Device usage and call statistics report
- Asset management tools to track and schedule maintenance
- Enhanced customization of attributes, contacts, logs and reports
- Advanced plug –in modules for calendars, hot lists, action items instantaneous messaging, e-Control and web cameras
- Real time facility wide monitoring and control of devices and systems
- Fully customizable graphical interface with easy to read status icons
- Status display of virtually any function – Lights, temperature, room occupancy, audio levels and much more
- Tracking of projector lamp life in bar graph format
- Instant help request notification, service reminders, device failures, device removal or theft
- Email alerts to unlimited recipients with assignable contact attributes
- Time and date stamping of help requests
- Built in event scheduling
- Built in logging, report and chart generation to track device usage, call statistics and user history
- Unlimited users with password login and assignable permissions
- Built in asset manager
- Windows Even Log support for integration with third party applications

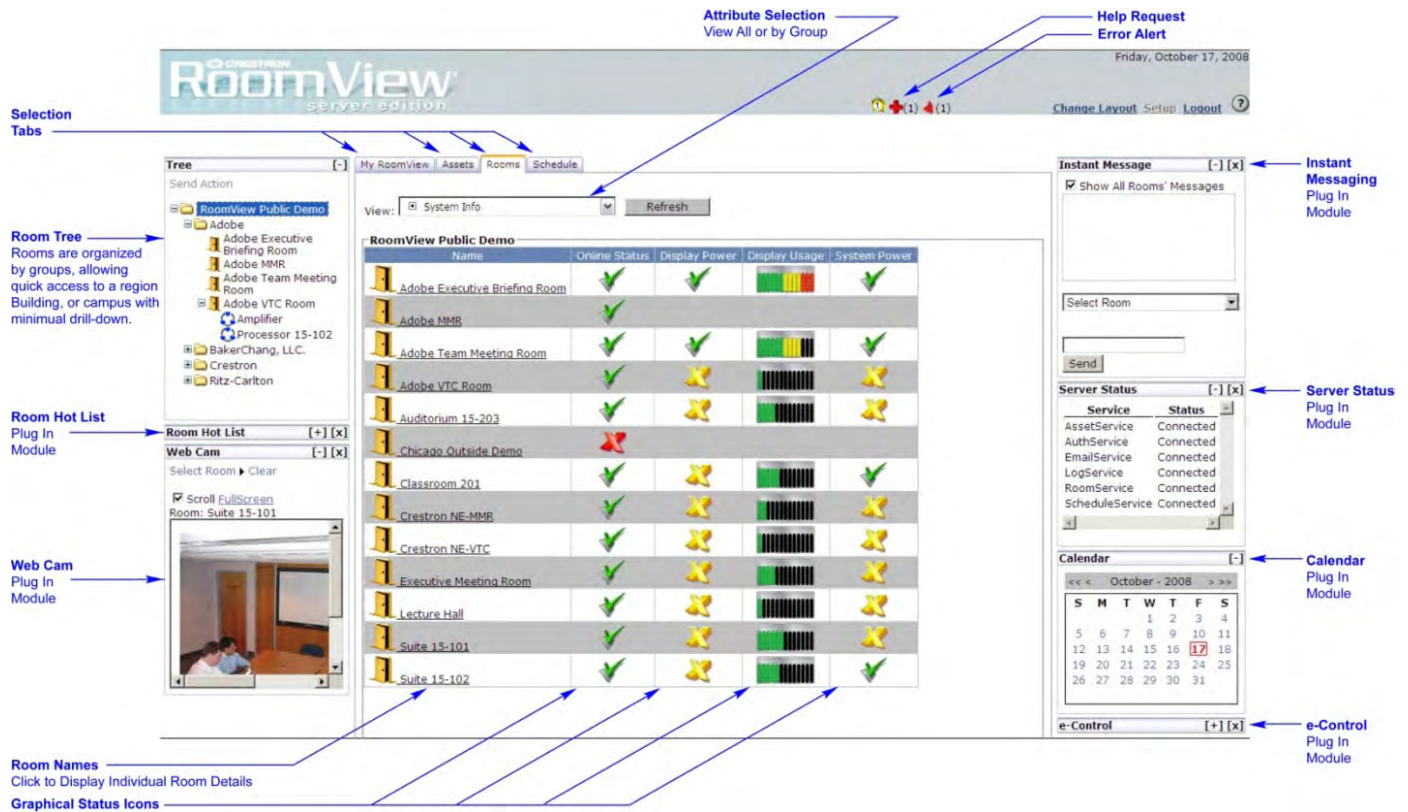

Example RoomView Server Edition® reports:

Call Type: Audio Conference

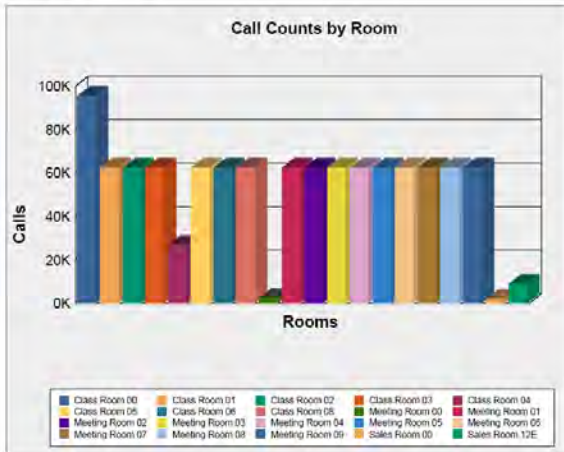

Error Totals

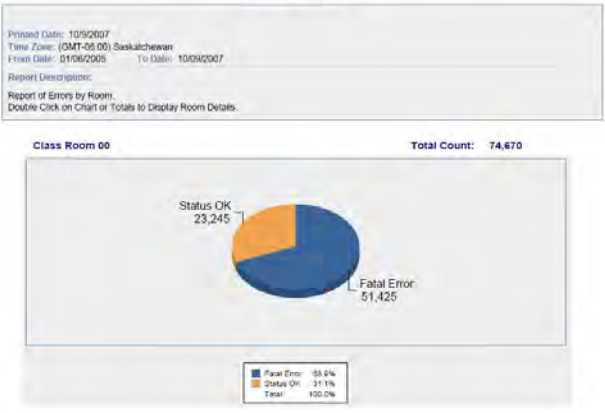

Device Usage by Date

Time Zone: (GMT-06:00) Saskatchewan
 From Date: 01/06/2005 To Date: 10/09/2007
 Printed Date: 10/9/2007

DVD Usage in Minutes for Class Room 00 Grouped by Quarter



Help Requests

Printed Date: 10/9/2007
 Time Zone: (GMT-06:00) Saskatchewan
 From Date: 01/06/2005 To Date: 10/09/2007

Report Description:
 Report of Help Requests by Room.
 Double Click on Chart or Totals to Display Room Details.

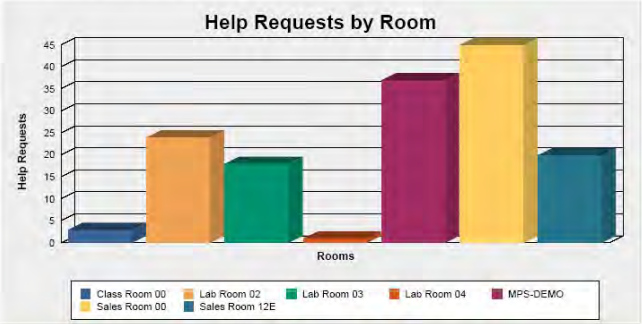

Help Requests Totals

Room Name	Total Count
Class Room 00:	3
Lab Room 02:	24
Lab Room 03:	18
Lab Room 04:	1
MPS-DEMO:	37
Sales Room 00:	45
Sales Room 12E:	20
Grand Total:	148

RoomView Express

RoomView® Express extends the power and simplicity of RoomView to large professional and educational facilities, supporting hundreds of rooms and unlimited users. No other Pro help desk software can match the capability of RoomView Express to monitor hundreds of rooms, in real time, in a single view.

Imagine managing all the device and Crestron-based functions throughout a facility with hundreds of rooms, allowing staff to log on and perform system tasks (while limiting their access to restricted areas) and automatically sending email alerts to any number of recipients based on their assigned status, all from any computer connection on the network.

With built-in logging, report, and chart generation, organizations can quickly determine equipment and purchasing needs, user activity and room usage. Tasks that could typically take days to complete are reduced to a few mouse clicks with RoomView Express!

- Real-time facility-wide monitoring and control of AV devices and systems
- Fully customizable graphical interface with easy-to-read status icons
- Status display of virtually any function – lights, audio levels, room occupancy, online status, temperature and much more
- Instant help request notifications, service reminders, device failures, device removal or theft
- Email alerts to unlimited recipients with assignable contact attributes
- Time and date stamping of help requests
- Built-in event scheduling
- Built-in logging and report, and chart generation, to track device usage, call statistics, and user history
- Unlimited users with password login and assignable permissions
- Fast, easy, and affordable implementation
- Built-in asset manager
- ODBC database integration for SQL Server

Scheduled Event
RoomView Express makes **scheduling of recurring or one time events easy**. Setting RoomView to automatically power down at midnight throughout the week can save valuable projector lamp life and ensure security inside the facility.

Help Alert
Real-time Interactive Help Desk requests are sorted to come to the top. The Help Desk then has the ability to respond with an automatic message or instant message the room with exact procedures.

Display Usage
Display Power
Check **on/off status** of display power and system power. View a bar graph to **monitor the percentage of available projector lamp life** and set an alert to notify the service department when a replacement lamp should be ordered before the lamp fails.

RoomView Express v.1.1.0 - RoomView

Name	Online	Log	System Power	Display Power	Display Usage	Help	Schedule
Auditorium	✓	✓	●	●	█	✓	⌚
Boardroom	✓	✓	●	●	█	✓	⌚
Room 1	✓	✓	●	●	█	✓	⌚
Room 2	✓	✓	●	●	█	✓	⌚
Room 3	✓	✓	●	●	█	✓	⌚
Room 4	✓	✓	●	●	█	✓	⌚
Room 5	✓	✓	●	●	█	✓	⌚
Room 6	✓	✓	●	●	█	✓	⌚
VideoConference	✓	✓	●	●	█	✓	⌚

About License Information
View Groups
Edit Assets
Edit Users
Edit Events
Edit Contacts
Edit Rooms
Edit Attributes
View Log
Find Room
Log Off

Group Tree View allows you to sort by parameters that you define, helping you to easily and quickly navigate through RoomView.

Select View by Rooms, Attributes, or Contacts
RoomView Express gives you the ability to simultaneously view **more than 250 rooms** from a single screen. Customize RoomView to view by room name, location, and group.

Room Name & Location (Sortable)

Online Status

Event Log
Automatically generate log files, reports and charts to analyze ROI and budget allocation. Track device usage, call statistics, and user history.

System Power

Additional Customized Attributes Available
RoomView Express gives you the ability to add an **unlimited number of attributes/columns** as you need. Customize parameters to monitor any signal available from the control system's SIMPL program including motion, lighting, audio levels, temperature, video sync, phone number dialed or whether or not a video-conference or audio call is active.

Appendix B

Green Light Designer Software™

Crestron Green Light™ Designer allows you to design and document a complete, energy-efficient commercial lighting solution that combines facility-wide lighting, shade/drape control with audio/video integration and network management—all without requiring extensive knowledge of Crestron products, or any other Crestron software.

Green Light Designer is based on the Green Light line of Crestron commercial lighting solutions, which are designed to maximize energy conservation and cost savings. Green Light systems offer users the flexibility of precise manual control of all devices, while providing customized levels of automation to achieve advanced features such as daylight harvesting and load shedding. A Crestron control system can schedule, monitor and manage all the technology centrally and globally from touchpanels, keypads and PCs.

Green Light Designer features a straightforward user interface, with all data entry confined to 4 easy-to-use tabs: load schedule, shades, control stations, and sensors. As you define your project, an Equipment List of required Crestron products is generated automatically behind the scenes. A Green Light Designer Project consists of one or more “systems”. Green Light Designer supports three basic system types: iLux local room dimming, centralized Power Switching, and centralized Architectural dimming. Each project can mix and match these system types as required. Within each system, your design is broken down by floors and rooms. To each room you can add lighting and shade circuits as dictated by your load schedule, as well as control stations such as touchpanels, keypads and handheld remotes.

For rapid design, a wizard is available to quickly add multiple copies of similar rooms. Once the project is designed and configured, Green Light Designer allows you to generate attractive and easy to read reports such as One-Line Diagrams, Load Schedules, Shade Schedules, Equipment Lists, and Equipment Lists by Room. Reports can be generated in a variety of formats (for example PDF, Excel, HTML, CSV, Text) ready to be sent via email or imported into other applications.

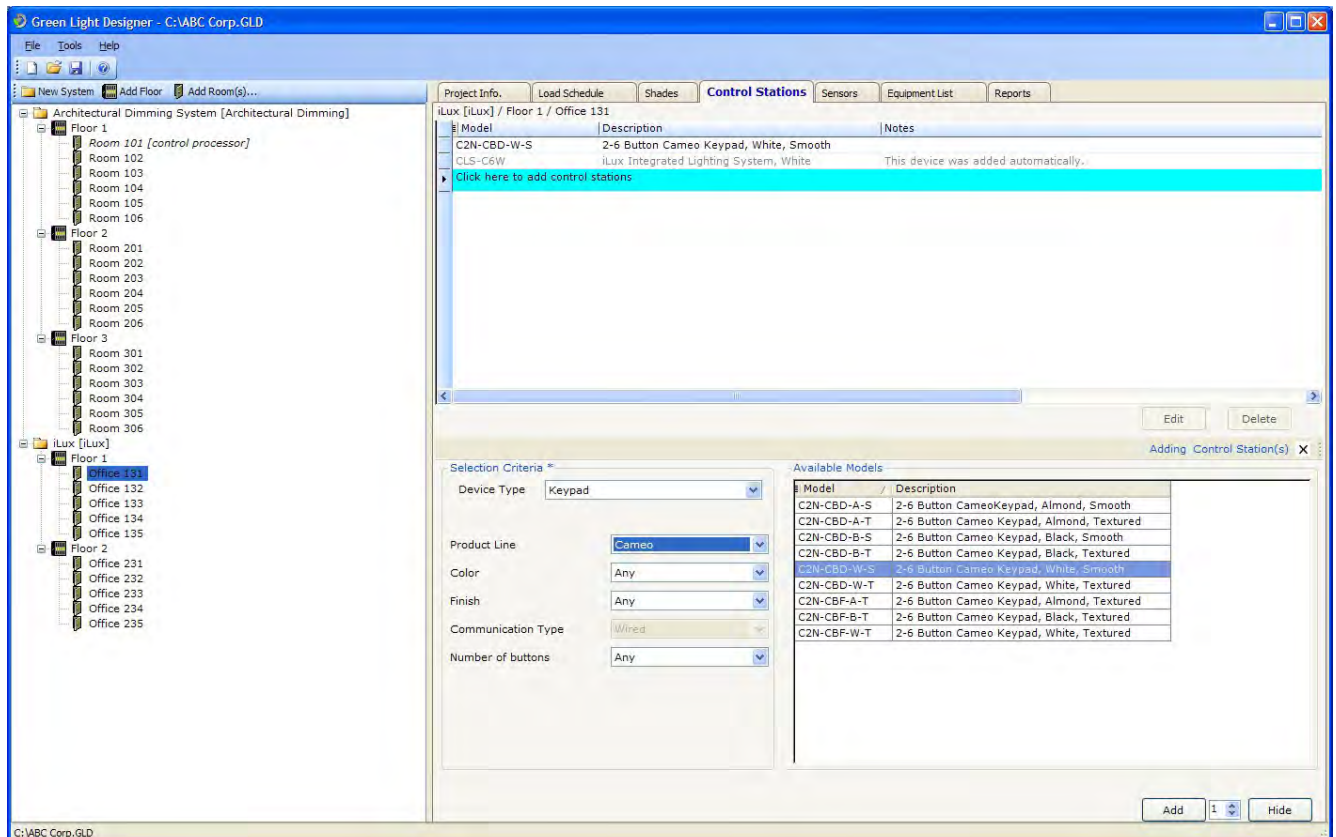

Project Info | **Load Schedule** | Shades | Control Stations | Sensors | Equipment List | Reports

iLux [iLux] / Floor 1

Fixture Type	Description	Load Type	Fixture Qty.	Fixture Wattage	Total Wattage	Dimmable	Voltage
Room : Office 131 - 3 item(s)							
AA	Fluorescent 2...		1	100	100	<input checked="" type="checkbox"/>	120
L1	LED 0-10V		1	6	6	<input checked="" type="checkbox"/>	120
L1	LED 0-10V		1	6	6	<input checked="" type="checkbox"/>	120
Room : Office 132 - 3 item(s)							
AA	Fluorescent 2...		1	100	100	<input checked="" type="checkbox"/>	120
L1	LED 0-10V		1	6	6	<input checked="" type="checkbox"/>	120
L1	LED 0-10V		1	6	6	<input checked="" type="checkbox"/>	120
Room : Office 133 - 3 item(s)							
AA	Fluorescent 2...		1	100	100	<input checked="" type="checkbox"/>	120
L1	LED 0-10V		1	6	6	<input checked="" type="checkbox"/>	120
L1	LED 0-10V		1	6	6	<input checked="" type="checkbox"/>	120
Room : Office 134 - 3 item(s)							
AA	Fluorescent 2...		1	100	100	<input checked="" type="checkbox"/>	120
L1	LED 0-10V		1	6	6	<input checked="" type="checkbox"/>	120
L1	LED 0-10V		1	6	6	<input checked="" type="checkbox"/>	120
Room : Office 135 - 3 item(s)							
AA	Fluorescent 2...		1	100	100	<input checked="" type="checkbox"/>	120
L1	LED 0-10V		1	6	6	<input checked="" type="checkbox"/>	120
L1	LED 0-10V		1	6	6	<input checked="" type="checkbox"/>	120

To add devices, select a Room node from tree

Edit Delete

WIRE NOTES:

- ⚠ CRESNET CABLE
- (1) PAIR #15AWG
- (1) TWISTED PAIR #22AWG
- ⚠ NON-PLENUM PN: CRESNET-NP-TL, PLENUM PN, CRESNET-P-TL
- ⚠ WIRE: SUITABLE GAUGE WIRE TO MEET LOAD REQUIREMENTS

NET2 GOTO PAGE: 3

NET3 GOTO PAGE: 5

NET1

CRN-211 FLOOR 1/ROOM 131

DP-3LW-214-120-80 FLOOR 1/ROOM 132

DP-3LW-214-120-80 FLOOR 1/ROOM 133

CR-3ED-7S FLOOR 1/ROOM 132

CR-3ED-7S FLOOR 1/ROOM 133

CR-3ED-7S FLOOR 1/ROOM 134

CR-3ED-7S FLOOR 1/ROOM 135

CR-3ED-7S FLOOR 1/ROOM 132

CR-3ED-7S FLOOR 1/ROOM 133

CR-3ED-7S FLOOR 1/ROOM 134

CR-3ED-7S FLOOR 1/ROOM 135

CR-3ED-7S FLOOR 1/ROOM 132

CR-3ED-7S FLOOR 1/ROOM 133

CR-3ED-7S FLOOR 1/ROOM 134

CR-3ED-7S FLOOR 1/ROOM 135

CR-3ED-7S FLOOR 1/ROOM 132

CR-3ED-7S FLOOR 1/ROOM 133

CR-3ED-7S FLOOR 1/ROOM 134

CR-3ED-7S FLOOR 1/ROOM 135

CRESTRON PROJECT: The ABC Corporation

Current Page: 1 | Total Pages: 16 | Zoom Factor: 100%

Appendix C: Touchpanel Comparison Charts

Tilt Touchpanels

	Isys Tilt Touchpanels					Isys G-Series		Isys i/O Tilt Touchpanel Media Centers			
	TPS-17B (TPS-17W)	TPS-15B (TPS-15W)	TPS-12B (TPS-12W)	TPS-4000	TPS-3000	TPS-15G-QM	TPS-12G-QM	TPMC-17-QM	TPMC-15-QM	TPMC-17-CH	TPMC-15-CH
Touchscreen Display											
Display Size	17"	15"	12"	10.4"	6.4"	15"	12"	17"	15"	17"	15"
Aspect Ratio	15:9 WXGA	4:3 XGA	4:3 SVGA	4:3 VGA	4:3 VGA	4:3 XGA	4:3 SVGA	15:9 WXGA	4:3 XGA	15:9 WXGA	4:3 XGA
Resolution	1280 x 768	1024 x 768	800 x 600	640 x 480	640 x 480	1024 x 768	800 x 600	1280 x 768	1024 x 768	1280 x 768	1024 x 768
Color Depth	24-bit 16.7M	24-bit 16.7M	18-bit 16.7M	18-bit 256k	18-bit 256k	24-bit 16.7M	18-bit 256k	24-bit 16.7M	24-bit 16.7M	24-bit 16.7M	24-bit 16.7M
Touchpanel Graphics											
Color Depth	24-bit 16.7M	24-bit 16.7M	24-bit 16.7M	16-bit 64k	16-bit 64k	24-bit 16.7M	18-bit 256k	24-bit 16.7M	24-bit 16.7M	24-bit 16.7M	24-bit 16.7M
8-bit Alpha Channel Transparency	●	●	●			●	●	●	●	●	●
Synapse Image Rendering and Multimode Objects	●	●	●	●	●	●	●	●	●	●	●
Dynamic Text and Animation	●	●	●	●	●	●	●	●	●	●	●
Dynamic Graphics and PNG Translucency	●	●	●			●	●	●	●	●	●
Dynamic Menu Graphics								●	●	●	●
Memory											
RAM	128MB	128MB	128MB	8MB	8MB	128MB	128MB	512MB	512MB	512MB	512MB
Flash	64MB	64MB	64MB	8MB	8MB	64MB	64MB	512MB	512MB	512MB	512MB
Memory Card Slot	up to 4GB	up to 4GB	up to 4GB			up to 4GB	up to 4GB	up to 4GB	up to 4GB	up to 4GB	up to 4GB
Maximum Project Size	160MB	160MB	160MB	7MB	7MB	160MB	160MB	190MB	190MB	190MB	190MB
Annotation & PC											
Windows XP Embedded OS								●	●	●	●
Embedded Applications and Viewers ⁴								●	●	●	●
Annotation						Live Only	Live Only	MediaMarker	MediaMarker	MediaMarker	MediaMarker
Keyboard/Mouse Input						USB Mouse	USB Mouse	USB	USB	USB	USB
Touch-the-PC						●	●	●	●		
Video/RGB											
Scalable Windows	1	1	1	1	1	2	2	2	2	2	2
Hardware Connections	QM, CH, BNC ¹	QM, CH, BNC ¹	QM, CH, BNC ¹	CH ¹ , BNC ¹	CH ¹ , BNC ¹	QM	QM	QM	QM	CH, BNC ¹	CH, BNC ¹
Composite	●	●	●	●	●	●	●	●	●	●	●
S-Video	●	●	●	●	●	●	●	●	●	●	●
Component	●	●	●			●	●	●	●	●	●
HDTV up to 1080i						●	●	●	●	●	●
RGB up to 1600 x 1200						●	●	●	●	●	●
Streaming Motion-JPEG								●	●	●	●
Media Player (Multiple Formats)								●	●	●	●
Display Output						●	●	●	●		
Audio											
Amplified Speakers and Microphone	●	●	●	●	●	●	●	●	●	●	●
WAV Sound File Audio Feedback	●	●	●	●	●	●	●	●	●	●	●
Network											
Cresnet	●	●	●	●	●	●	●	●	●	●	●
Ethernet	●	●	●			●	●	●	●	●	●
WiFi								●	●	●	●
Buttons											
Backlit Softkeys	4	4	4			4	4	4	4	4	4

¹ Connections via outboard IMC interface module (included)
² Wireless NIC required
³ Accessory sold separately
⁴ Refer to the product specification for a complete list of embedded applications

Wall Mount Touchpanels

	Isys Wall Mount Touchpanels						Isys G Series			Isys i/O Media Centers		
	TPS-17L	TPS-15L	TPS-12L	TPS-4000L	TPS-6L	TPS-4L	TPS-15G-QM-L	TPS-12G-QM-L	TPMC-17-QM-L	TPMC-15-QM-L	TPMC-17-CH-L	TPMC-15-CH-L
Touchscreen Display												
Display Size	17"	15"	12"	10.4"	5.7"	3.6"	15"	12"	17"	15"	17"	15"
Aspect Ratio	15:9 WXGA	4:3 XGA	4:3 SVGA	4:3 VGA	4:3 SVGA	4:3 QVGA	4:3 XGA	4:3 SVGA	15:9 WXGA	4:3 XGA	15:9 WXGA	4:3 XGA
Resolution	1280 x 768	1024 x 768	800 x 600	640 x 480	640 x 480	320 x 240	1024 x 768	800 x 600	1280 x 768	1024 x 768	1280 x 768	1024 x 768
Color Depth	24-bit 16.7M	24-bit 16.7M	18-bit 256k	18-bit 256k	18-bit 256k	16-bit 64k	24-bit 16.7M	18-bit 256k	24-bit 16.7M	24-bit 16.7M	24-bit 16.7M	24-bit 16.7M
Touchpanel Graphics												
Color Depth	24-bit 16.7M	24-bit 16.7M	24-bit 16.7M	16-bit 64K	16-bit 64K	16-bit 64K	24-bit 16.7M	24-bit 16.7M	24-bit 16.7M	24-bit 16.7M	24-bit 16.7M	24-bit 16.7M
8-bit Alpha Channel Transparency	●	●	●				●	●	●	●	●	●
Synapse Image Rendering and Multimode Objects	●	●	●	●		●	●	●	●	●	●	●
Dynamic Text and Animation	●	●	●	●		●	●	●	●	●	●	●
Dynamic Graphics and PNG Translucency	●	●	●			●	●	●	●	●	●	●
Dynamic Menu Objects									●	●	●	●
Memory												
RAM	128MB	128MB	128MB	8MB	32MB	16MB	128MB	128MB	512MB	512MB	512MB	512MB
Flash	64MB	64MB	64MB	8MB	32MB	8MB	64MB	64MB	512MB	512MB	512MB	512MB
Memory Card Slot	up to 4GB	up to 4GB	up to 4GB				up to 4GB	up to 4GB	up to 4GB	up to 4GB	up to 4GB	up to 4GB
Maximum Project Size	160MB	160MB	160MB	7MB	28MB	7MB	160MB	160MB	190MB	190MB	190MB	190MB
Annotation & PC												
Windows XP Embedded OS ⁵									●	●	●	●
Annotation									●	●	●	●
Keyboard/Mouse Input							Live Only	Live Only	Media Marker USB	Media Marker USB	Media Marker USB	Media Marker USB
Touch-the-PC									USB	USB	USB	USB
Video/RGB												
Scalable Windows	1	1	1	1	1		2	2	2	2	2	2
Hardware Connections	QM, CH, BNC ¹	QM, CH, BNC ¹	QM, CH, BNC ¹	CH, BNC			QM	QM	QM	QM	CH, BNC ¹	CH, BNC ¹
Composite	●	●	●	●			●	●	●	●	●	●
S-Video	●	●	●	●			●	●	●	●	●	●
Component	●	●	●				●	●	●	●	●	●
HDTV up to 1080i							●	●	●	●	●	●
RGB up to 1600 x 1200							●	●	●	●		
Streaming Motion-JPEG									●	●	●	●
Media Player (Multiple Formats)									●	●	●	●
Display Output							●	●	●	●		
Audio												
Amplified Speakers and Microphone	●	●	●	●	●		●	●	●	●	●	●
WAV Sound File Audio Feedback	●	●	●	●	●	●	●	●	●	●	●	●
Network												
Cresnet	●	●	●	●	●	●	●	●	●	●	●	●
Ethernet	●	●	●		●				●	●	●	●
Wi-Fi ³												
Buttons												
Backlit Softkeys	4	4	4				4	4	4	4	4	4
Programmable, Engravable Hard Buttons				5	12	10						
Finishes												
White or Black	●	●	●	●	●	●	●	●	●	●	●	●
Almond				●	●	●						
Additional Colors & Finishes				●	●	●						

1 Connections via outboard IMC interface module (included)
 2 Also supports coaxial connection
 3 Wireless NIC required
 4 Appropriate mounting accessory(ies) required
 5 Rack mount provided by others
 6 See product specification for a complete list of embedded applications

Wireless Touchpanels & Handheld Remotes

	Isys Wireless	Isys I/O WiFi				MiniTouch	Handheld Remotes			
	TPS-6X	TPMC-8X	TPMC-8T	TPMC-4X	MT-1000C	MLX-2	ML-600	WPR-48	CNRFHT	
Display Display Type	TFT Active Matrix Color Touchscreen	TFT Active Matrix Color Touchscreen	TFT Active Matrix Color Touchscreen	TFT Active Matrix Color Touchscreen	TFT Active Matrix Color Touchscreen	Backlit LCD	Backlit LCD			
Display Size	5.7"	8.4"	8.4"	3.5"	3.8"	1.5" W	2.1" H x 1.4" W			
Resolution	640 x 480 VGA	800 x 600 SVGA	800 x 600 SVGA	240 x 320 QVGA (portrait)	320 x 240 QVGA	102 x 120 7 lines	7 lines			
Color Depth	18-bit 262k Colors	18-bit 262k Colors	18-bit 262k Colors	16-bit 64k Colors	16-bit 64k Colors	Monochrome	Monochrome			
Buttons & Controls Programmable Hard Buttons	17 or 2	11	11	21	14	47	57	9 to 48	1 to 30	
Thumb Pad	●	●	●	●	●	●	●			
3-Way Toggle Wheel				●						
Biometric Fingerprint Scanner		●	●							
Button Backlighting	●			●	●	●	●	Label Inlay		
Custom Engravable	●							Label Inlay	●	
Touchpanel Graphics Color Depth	16-bit 64k	16-bit 64k	16-bit 64k	16-bit 64k	16-bit 64k					
Synapse Image Rendering	●	●	●	●	●					
Multimode Objects	●	●	●	●						
True Feedback, Dynamic Text, & Animation	●	●	●	●						
Dynamic Graphics & PNG Translucency	●	●	●	●						
DNav Dynamic Menu Objects		●	●							
Memory Ram	32MB	512MB	512MB	64MB	16MB					
Flash	32MB	1GB	1GB	32MB						
Memory Card Slot		up to 4GB	up to 4GB							
Maximum Project Size	28MB	190MB	190MB	12MB	16MB					
Embedded PC Operating System		Windows XP	Embedded Windows XP	Embedded Windows CE .NET 4.2						
Embedded Applications ¹		●	●							
Keyboard/Mouse Input		USB	USB							
Video Wired via Docking Station	●									
Streaming via Media Player		●	●							
Streaming MJPEG		●	●	●						
Audio Integrated Speakers & Microphone		●	●							
WAV Sound File Audio Feedback		●	●		●					
Network 2-Way High-Powered RF via CEN-HPRFGW	●									
2-Way Wi-Fi RF via 3rd-party 802.11x WAP		802.11a/b/g	802.11a/b/g	802.11b						
2-Way infinite™ EX RF via CEN-RFGW-EX						●				
1-Way RF 418 MHz via CNRFGWA-418 or MC2W					●		●	●		
1-Way RF 434 MHz via CNRFGWA or MC2W								●	●	
1-Way IR 38 kHz RC5 via C2N-IRGW or CNXRMIRD	●				●		●	●		
1-Way IR 455 kHz via CN-TVAV								●		
Wired Ethernet via Docking Station	●	●	●							
Wired Cresnet via Docking Station	●									
Batteries Internal Rechargeable	●	●		●	●			●		
External Booster Option		●								
Disposable						AAA (x4)	AAA (x4)		9 Volt (x1)	
Docking Station Desktop	●	● ²	Integrated	●	●			●		
Wall Mount	● ²	● ²								

¹ Refer to product specifications for a complete list of embedded applications
² Accessory sold separately

Appendix D: General Lighting Design Considerations

Crestron provides many options for illumination control. The following general lighting design information can help you formulate a complete, energy efficient lighting design plan.

Light plays an essential role in our ability to view the world around us, and how we perceive a space it can even influence how we act in that space. Lighting can affect performance, mood, morale, safety, security and decision making.

The first step in producing the right lighting design is asking about the use of the space. The lighting designer can then determine quantity of light, color quality, brightness and direction.

There are two aspects of lighting design that go hand in hand: the qualitative or aesthetic aspect, and the quantitative or engineering aspect. The qualitative aspect has to do with ensuring that the space has a pleasing feel and ambiance. It is the artistic interspersing of light and shadow, illumination and darkness, figure and form.

The quantitative aspect ensures that there is adequate light for the task at hand. The Illuminating Engineering Society (IES) of North America publishes guidelines of light levels for many tasks and activities based on the nature of the task, the size of objects handled, the detail required, the average age of the people in that space, and so on. For example, a typical office is lit to an illumination of 30 to 100 "footcandles". Light levels can also be expressed in the metric unit "lux" 1 footcandle is approximately 10 lux.

The rate of energy consumption is called "power" and is measured in watts. A 200 watt lamp is consuming energy at twice the rate of a 100 watt lamp. The electric company charges consumers for the total amount of energy they consume. This is measured in kilowatt-hours or kWh. A 200-watt lamp burning for 5 hours consumes 1,000 watt-hours of energy, which is a kilowatt-hour. Note that burning a thousand watt lamp for one hour costs the same as burning a hundred watt lamp for ten hours.

Static and Dynamic Elements

The lighting design requires you to define the building envelope, electric lighting, façade features, and other static elements that affect lighting. Window placement and glazing, floor layout, building orientation, and fixture placement are all static elements that define the building space and lighting environment. Crestron control is

required for the dynamic elements, the elements that change in response to environmental and human variables. These static and dynamic elements are fully integrated in a complete lighting design.

Simple Lighting Coverage Areas

In some rooms, one lighting fixture or a group of fixtures provide all the illumination. These rooms include closets, storage rooms, utility rooms and garages. In these areas, the functionality of the fixtures outweighs style consideration.

The greatest energy efficiency is achieved with compact fluorescent downlights. The best performing systems use a 32 watt "triple tube" downlight, providing more light than a 100 watt incandescent lamp while consuming 1/3 the amount of energy.

For many spaces, such as garages and closets, a simple lighting solution is the most appropriate. In storage rooms, basements, and other places, basic lighting may be all that is needed. These are excellent opportunities for energy efficient lighting fixtures, especially if lights are left on for extended periods of time.

Task Lighting for Specific Work Areas

Task lights minimize reliance on overhead lighting and provide directed lighting for countertop work in kitchens, workshop, office, etc. Energy efficient CFL recessed can lights or reflectorized CFLs are recommended for this application. Recessed downlights are located over task locations, especially in the kitchen, bath, shower, or at a desk. One recessed light may be all that is needed in a shower stall or tub, but in a kitchen, a group of downlights often provides more flexible task lighting. It is best to locate downlights directly over a task, but in the kitchen keep in mind that the downlight must also illuminate into the base cabinets, making fixture locations over the center of the room equally important.

Under-cabinet lights are used whenever there is an overhead cabinet above a counter, such as in a kitchen, laundry room or home office. Fluorescent and LED under-cabinet lights produce significantly more light than incandescent strips, and use much less energy.

Ambient Lighting for Mood and Highlights

Ambient light is the general, overall light that fills in shadows, reduces contrast, and lights vertical surfaces to give the space a brighter feel. Ambient light is what you need for casual activities in your rooms. Ambient lighting sets a dramatic or subtle mood within a living space. Use ambient lights to illuminate hallways, entryways, artwork and architectural highlights in the home or office. The nature and quality of ambient lighting determines the overall feel of the room. Even if your design produces the right amount of light for each task and display and you have sconces or chandeliers, it is possible that more ambient light is needed. Ambient light is intentionally obscure, and as such it can be difficult to determine when more is necessary. Often the best way to provide ambient light is with hidden fixtures.

Ambient light is a primary concern in the kitchen, where table lamps and floor lamps aren't welcome because they get in the way. Some common ways to introduce ambient light in the kitchen are:

- Fluorescent uplights on top of cabinets
- Central fluorescent lights on the ceiling
- Wall sconces, especially those with uplight
- Decorative lights with an open top that place most of the light on the ceiling

Decorative Lighting

Decorative lighting includes chandeliers, sconces, and table lamps, and is usually chosen based on style and appearance. Generally, decorative lights produce only modest amounts of illumination. A lighting design begins with architecture, style and décor. Some things just look right, feel right, and fit well with the overall design of the room. Decorative lighting such as chandeliers, sconces, and table lamps are part of our culture, and they provide at least some portion of the light needed for certain tasks. As a general rule, designers should choose the decorative lighting that fits the space. Traditional locations include a chandelier over the dining room table, a pendant light over the breakfast table, a lamp on a side table in the living room, or a lantern by the front door. Keep in mind that other lighting may also be needed (to illuminate tasks or displays), but due to the important role that decorative lighting plays, it comes first. Accent lighting gives the space a third dimension, adding to the quality of the space.

Focal Lighting

Focal, or display lighting illuminates art, architecture, collections and other displays. Determine whether you

want to highlight objects of art, memorabilia, bookcases, or other things that you may wish to have stand out. For many families, the fireplace mantel and the wall above the mantel are primary locations for display items.

As a rule of thumb, mount the focal light 21 inches from the wall with an 8-foot ceiling, 27 inches from the wall with a 9-foot ceiling, 34 inches from the wall with a 10-foot ceiling, and so on. One accent light will illuminate anything from a small object (with a 10-15 degree spot lamp) to a painting up to 3 feet wide (with a 35-35 degree flood lamp). Add a second light for every 30-36 inches of width of the object you are lighting.

Key Light

When shining a light on an object from a single point source it is called key light. A key light highlights the contours of an object and creates shadows. The exact effect depends on the angle of the beam of light. Most of the time we want to light the object so we can see its front. In these cases, the light source may be best placed in front of and to the side of the object at an angle of 45°.

Fill Light

A fill light can either be directional or diffused. Shining a directional light on an object from the opposite direction of the key light can soften or eliminate shadows, depending on the strength of the fill light relative to the strength of the key light. Fill light sources can be placed behind objects to light the entire room evenly.

Uplighting

The effect of uplighting is either very desirable or very undesirable because of unusual effects that can range from intimate to eerie. A lot of landscape lighting includes uplighting to accentuate bushes and trees.

Sparkle and Glitter Effects

To add an atmosphere of elegance, add little lighting points of interest in the form of sparkle or glitter. This effect can be produced by either producing sharp reflections on reflective surfaces in the room (sparkle), such as silverware in a restaurant, or by making the light source itself a source of interest (glitter) such as with a chandelier. Avoid glare in these cases by adjusting the angle of the light source.

Grazing and Washing Surfaces

On walls or on the surface of an object, changing the way light is focused produces different effects. To emphasize a rough textured brick wall, graze the surface with light striking the surface at a sharp angle. To emphasize a smooth wall, wash the surface with light by striking the surface at a wider angle.

Switch and Dimmer Locations

The proper location for a switch or dimmer is a function of code requirements (the National Electrical Code establishes some specific locations where control devices are required) and common sense. For example, the code requires a wall switch adjacent to the door upon entry to a room. but you can also add a switch in a preferred location, such as next to the bed.

Another choice are motion sensors that automatically switch lights off when the room is empty, and they are especially efficient devices in spaces like garages, utility rooms and other spaces where lights are only needed occasionally and are often left on inadvertently.

Crestron offers the most technologically sophisticated products that permit handheld remote dimming, whole house master controls, and many other features.

Color Temperature

Color temperature is the color of the light source. By convention, yellow-red colors (like the flames of a fire) are considered warm, and blue-green colors (like light from an overcast sky) are considered cool. Color temperature is measured in Kelvin (K) temperature. Higher Kelvin temperatures (3600–5500 K) are considered cool and

lower Kelvin color temperatures (2700–3000 K) are considered warm. Cool light is preferred for visual tasks because it produces a higher contrast than warm light. Warm light is preferred for living spaces because it is more flattering to skin tones and clothing. A warm color temperature of 2700–3600 K is generally recommended for most indoor general and task lighting applications.

Color Rendition

Color rendition is the appearance of colors when illuminated by a light source. Color rendition is generally considered to be a more important lighting quality than color temperature. Most objects are not a single color, but a combination of many colors. Light sources that are deficient in certain colors may change the apparent color of an object. The Color Rendition Index (CRI) is a 1–100 scale that measures a light source's ability to render colors the same way sunlight does. The top value of the CRI scale (100) is based on illumination by a 100 watt incandescent light bulb. A light source with a CRI of 80 or higher is considered acceptable for most indoor residential applications.

Glare

Glare is primarily the result of relative placement of light sources and the objects viewed. Often, it is excessive brightness from a direct light source making it difficult to see. A bright object in front of a dark background usually causes glare. Bright lights reflecting off a television or computer screen or even a printed page produces glare. Intense light sources—such as bright incandescent lamps—are likely to produce more direct glare than large fluorescent lamps.

Appendix E: Glossary of Lighting Terminology

A

AMPERE: The standard unit of measurement for electric current that is equal to one coulomb per second. It defines the quantity of electrons moving past a given point in a circuit during a specific period, abbreviated amp.

ANSI: Abbreviation for American National Standards Institute

ARC TUBE: A tube enclosed by the outer glass envelope of a HID lamp and made of clear quartz or ceramic that contains the arc stream

ASHRAE: American Society of Heating, Refrigerating and Air-Conditioning Engineers

B

BAFFLE: A single opaque or translucent element used to control light distribution at certain angles

BALLAST: A device used to operate fluorescent and HID lamps. The ballast provides the necessary starting voltage, while limiting and regulating the lamp current during operation

BALLAST CYCLING: Undesirable condition under which the ballast turns lamps on and off (cycles) due to the overheating of the thermal switch inside the ballast. This may be due to incorrect lamps, improper voltage being supplied, high ambient temperature around the fixture, or the early stage of ballast failure

BALLAST EFFICIENCY FACTOR: The ballast efficiency factor (BEF) is the ballast factor (see below) divided by the input power of the ballast. The higher the BEF (within the same lamp-ballast type) the more efficient the ballast.

BALLAST FACTOR: The ballast factor (BF) for a specific lamp-ballast combination represents the percentage of the rated lamp lumens that will be produced by the combination

C

CANDELA: Unit of luminous intensity, describing the intensity of a light source in a specific direction

CANDELA DISTRIBUTION: A curve, often on polar coordinates, illustrating the variation of luminous intensity of a lamp or luminaire in a plane through the light center

CANDLEPOWER: A measure of luminous intensity of a light source in a specific direction, measured in candelas (see above)

CBM: Abbreviation for Certified Ballast Manufacturers Association.

CEC: Abbreviation for California Energy Commission

COEFFICIENT OF UTILIZATION: The ratio of lumens from a luminaire received on the work plane to the lumens produced by the lamps alone. (Also called "CU")

COLOR RENDERING INDEX (CRI): A scale of the effect of a light source on the color appearance of an object compared to its color appearance under a reference light source. Expressed on a scale of 1 to 100, where 100 indicates no color shift. A low CRI rating suggests that the colors of objects will appear unnatural under that particular light source

COLOR TEMPERATURE: The color temperature is a specification of the color appearance of a light source, relating the color to a reference source heated to a particular temperature, measured by the thermal unit Kelvin. The measurement can also be described as the "warmth" or "coolness" of a light source. Generally, sources below 3200K are considered "warm;" while those above 4000K are considered "cool" sources

COMPACT FLUORESCENT: A small fluorescent lamp that is often used as an alternative to incandescent lighting. The lamp life is about 10 times longer than incandescent lamps and is 3-4 times more efficacious. Also called PL, Twin-Tube, CFL, or BIA lamps

CONSTANT WATTAGE (CW) BALLAST: A premium type of HID ballast in which the primary and secondary coils are isolated. It is considered a high performance, high loss ballast featuring excellent output regulation

CONSTANT WATTAGE AUTOTRANSFORMER (CWA) BALLAST: A popular type of HID ballast in which the primary and secondary coils are electrically connected. Considered an appropriate balance between cost and performance

CONTRAST: The relationship between the luminance of an object and its background

CRI: (SEE COLOR RENDERING INDEX)

CUT-OFF ANGLE: The angle from a fixture's vertical axis at which a reflector, louver, or other shielding device cuts off direct visibility of a lamp. It is the complementary angle of the shielding angle

D

DALI: Digital Addressable Lighting Interface is a protocol set out in the technical standard IEC 60929. A DALI system is self-contained. A ballast and a multi-sensor, offer benefits such as constant light control, PIR movement-detection and IR remote operation. Multiple DALI systems can be connected together using gateways to building management systems. Software programs offer more sophisticated programming functionality for grouped systems, such as scene setting, time clock, and partition control

DAYLIGHT COMPENSATION: A dimming system controlled by a photocell that reduces the output of the lamps when daylight is present. As daylight levels increase, lamp intensity decreases. An energy-saving technique used in areas with significant daylight contribution

DERATING: Components can be treated in such a way as to enhance their life expectancy. Derating is the name normally given to operating a component well inside its normal operating limits to extend the life of a component, and is a practical means of reducing failures. The National Electrical Code and local electrical codes determine the amount of available current based on a derating factor. A derating factor improves reliability by reducing the upper limit of current carrying capacity to compensate for electrical, mechanical and thermal stress

DIFFUSE: Term describing dispersed light distribution. Refers to the scattering or softening of light

DIFFUSER: A translucent piece of glass or plastic sheet that shields the light source in a fixture. The light transmitted throughout the diffuser will be redirected and scattered

DIRECT GLARE: Glare produced by a direct view of light sources. Often the result of insufficiently shielded light sources. (See GLARE)

DOWNLIGHT: A type of ceiling luminaire, usually fully recessed, where most of the light is directed downward. May feature an open reflector and/or shielding device

E

EFFICACY: A metric used to compare light output to energy consumption. Efficacy is measured in lumens per watt. Efficacy is similar to efficiency, but is expressed in dissimilar units. For example, if a 100-watt source produces 9000 lumens, then the efficacy is 90 lumens per watt

ELECTROLUMINESCENT: A light source technology used in exit signs that provides uniform brightness, long lamp life (approximately eight years), while consuming very little energy (less than one watt per lamp)

ELECTRONIC BALLAST: A ballast that uses semi-conductor components to increase the frequency of fluorescent lamp operation (typically in the 20-40 kHz range. Smaller inductive components provide the lamp current control. Fluorescent system efficiency is increased due to high frequency lamp operation

ELECTRONIC DIMMING BALLAST: A variable output electronic fluorescent ballast

ELECTRONIC LOW-VOLTAGE (ELV): Electronic low-voltage lighting uses an electronic (solid-state technology) transformer to convert line voltage (120 VAC) to low voltage (typically 12 VAC). This lower voltage is then used power an incandescent low-voltage lamp. Track lights are usually electronic low-voltage

EMI: Abbreviation for electromagnetic interference. EMI is the high frequency interference (electrical noise) caused by electronic components or fluorescent lamps that interferes with the operation of electrical equipment. EMI is measured in micro-volts, and can be controlled by filters. Because EMI can interfere with communication devices, the Federal Communication Commission (FCC) has established limits for EMI

ENERGY-SAVING BALLAST: A type of magnetic ballast designed so that the components operate more efficiently, cooler and longer than "standard magnetic" ballast. By US law, standard magnetic ballasts can no longer be manufactured

ENERGY-SAVING LAMP: A lower wattage lamp, generally producing fewer lumens

F

FC: (SEE FOOTCANDLE)

FLUORESCENT LAMP: A light source consisting of a tube filled with argon, along with krypton or other inert gas. When electrical current is applied, the resulting arc emits ultraviolet radiation that excites the phosphors inside the lamp wall, causing them to radiate visible light

FOOTCANDLE (FC): The English unit of measurement of the illuminance (or light level) on a surface. One footcandle is equal to one lumen per square foot

FOOTLAMBERT: English unit of luminance. One footlambert is equal to 1/π candelas per square foot.

FORWARD PHASE DIMMING: Rather than attempting to restrict the amplitude of the current flowing through a lamp, as in other forms of dimming, forward phase control works by switching off the beginning part of each cycle of the alternating current supply

FOUR-WIRE 10V ANALOG SIGNAL DIMMING: Two power wires (switched hot and neutral) and two additional control wires that are connected to a low-voltage circuit. Note: these ballasts do not turn on and off like DALI ballasts, so in addition to the low-voltage-level control circuit, they must also have a line-voltage switch. Zero to ten-volt control is a low-voltage DC dimming method. Power wires are rated Class 1 and control wires are rated Class 2. This separation allows multiple circuits to use the same dimming signal without additional power equipment

G

GLARE: The effect of brightness or differences in brightness within the visual field sufficiently high to cause annoyance, discomfort or loss of visual performance

H

HALOGEN: (SEE TUNGSTEN HALOGEN LAMP)

HARMONIC DISTORTION: A harmonic is a sinusoidal component of a periodic wave having a frequency that is a multiple of the fundamental frequency. Harmonic distortion from lighting equipment can interfere with other appliances and the operation of electric power networks. The total harmonic distortion (THD) is usually expressed as a percentage of the fundamental line current. THD for 4-foot fluorescent ballasts usually range from 20% to 40%. For compact fluorescent ballasts, THD levels greater than 50% are not uncommon

HID: Abbreviation for high intensity discharge. Generic term describing mercury vapor, metal halide, high-pressure sodium, and (informally) low-pressure sodium light sources and luminaires

HIGH BAY: Pertains to the type of lighting in an industrial application where the ceiling is 20 feet or higher. Also describes the application itself

HIGH OUTPUT (HO): A lamp or ballast designed to operate at higher currents (800 mA) and produce more light.

HIGH POWER FACTOR: Ballast with a 0.9 or higher rated power factor, which is achieved by using a capacitor.

HIGH PRESSURE SODIUM LAMP: A high intensity discharge (HID) lamp whose light is produced by radiation from sodium vapor (and mercury)

HOT RESTART or HOT RESTRIKE: The phenomenon of re-striking the arc in an HID light source after a momentary power loss. Hot restart occurs when the arc tube has cooled a sufficient amount

I

IESNA: Abbreviation for Illuminating Engineering Society of North America.

ILLUMINANCE: A photometric term that quantifies light incident on a surface or plane. Illuminance is commonly called light level. It is expressed as lumens per square foot (footcandles), or lumens per square meter (lux)

INDIRECT GLARE: Glare produced from a reflective surface.

INSTANT START: A fluorescent circuit that ignites the lamp instantly with a very high starting voltage from the ballast. Instant start lamps have single-pin bases

L

LAMP CURRENT CREST FACTOR (LCCF): The peak lamp current divided by the RMS (average) lamp current. Lamp manufacturers require <1.7 for best lamp life. An LCCF of 1.414 is a perfect sine wave

LAMP LUMEN DEPRECIATION FACTOR (LLDF): A factor that represents the reduction of lumen output over time. The factor is commonly used as a multiplier to the initial lumen rating in illumination calculations, which compensates for the lumen depreciation. The LLD factor is a dimensionless value between 0 and 1

LAY-IN-TROFFER: A fluorescent fixture; usually a 2' x 4' fixture that sets or "lays" into a specific ceiling grid

LED: Abbreviation for light emitting diode. An illumination technology used for exit signs. Consumes low wattage and has a rated life of greater than 80 years

LENS: Transparent or translucent medium that alters the directional characteristics of light passing through it. Usually made of glass or acrylic

LIGHT LOSS FACTOR (LLF): Factors that allow for a lighting system's operation at less than initial conditions. These factors are used to calculate maintained light levels. LLFs are divided into two categories, recoverable and non-recoverable. Examples are lamp lumen depreciation and luminaire surface depreciation

LIFE-CYCLE COST: The total costs associated with purchasing, operating, and maintaining a system over the life of that system

LOUVER: Grid type of optical assembly used to control light distribution from a fixture. Can range from small-cell plastic to the large-cell anodized aluminum louvers used in parabolic fluorescent fixtures

LOW POWER FACTOR: Essentially, an uncorrected ballast power factor of less than 0.9 (SEE NPF)

LOW-PRESSURE SODIUM: A low-pressure discharge lamp in which light is produced by radiation from sodium vapor. Considered a monochromatic light source (most colors are rendered as gray)

LOW-VOLTAGE LAMP: A lamp (typically compact halogen) that provides both intensity and good color rendition. Lamp operates at 12V and requires the use of a transformer. Common lamps are MR11, MR16, and PAR36

LOW-VOLTAGE SWITCH: A relay (magnetically-operated switch) that allows local and remote control of lights, including centralized time clock or computer control

LUMEN: A unit of light flow, or luminous flux. The lumen rating of a lamp is a measure of the total light output of the lamp

LUMINAIRE: A complete lighting unit consisting of a lamp or lamps, along with the parts designed to distribute the light, hold the lamps, and connect the lamps to a power source. Also called a fixture

LUMINAIRE EFFICIENCY: The ratio of total lumen output of a luminaire and the lumen output of the lamps, expressed as a percentage. For example, if two luminaires use the same lamps, more light will be emitted from the fixture with the higher efficiency.

LUMINANCE: A photometric term that quantifies brightness of a light source or of an illuminated surface that reflects light. It is expressed as footlamberts (English units) or candelas per square meter (Metric units)

LUX (LX): The metric unit of measure for illuminance of a surface. One lux is equal to one lumen per square meter. One lux equals 0.093 footcandles

M

MAINTAINED ILLUMINANCE: Refers to light levels of a space at other than initial or rated conditions. This term considers light loss factors such as lamp lumen depreciation, luminaire dirt depreciation, and room surface dirt depreciation

MAGNETIC LOW-VOLTAGE (MLV): Magnetic low-voltage lighting uses a magnetic (core and coil technology) transformer to convert line voltage (120 VAC) to low voltage (typically 12 VAC). This lower voltage is then used to power an incandescent low-voltage lamp. Recessed lights are most often magnetic low-voltage. Magnetic low-voltage lights tend to be larger and heavier than electronic low-voltage

MERCURY VAPOR LAMP: A type of high intensity discharge (HID) lamp in which most of the light is produced by radiation from mercury vapor. Emits a blue-green cast of light. Available in clear and phosphor-coated lamps

METAL HALIDE: A type of high intensity discharge (HID) lamp in which most of the light is produced by radiation of metal halide and mercury vapors in the arc tube. Available in clear and phosphor-coated lamps

MR-16: A low-voltage quartz reflector lamp, only 2" in diameter. Typically the lamp and reflector is one unit, which directs a sharp, precise beam of light

N

NADIR: A reference direction directly below a luminaire, or "straight down" (0 degree angle)

NEMA: Abbreviation for National Electrical Manufacturers Association

NEON/COLD CATHODE: Highly inductive boost transformer for neon/cold cathode lighting

NIST: Abbreviation for National Institute of Standards and Technology

NPF (NORMAL POWER FACTOR): A ballast/lamp combination in which no components (e.g., capacitors) have been added to correct the power factor, making it normal (essentially low, typically 0.5 or 50%)

O

OCCUPANCY SENSOR: Control device that turns lights off after the space becomes unoccupied. May be ultrasonic, infrared or other type

OPTICS: A term referring to the components of a light fixture (such as reflectors, refractors, lenses, louvers) or to the light emitting or light-controlling performance of a fixture

P

PAR LAMP: A parabolic aluminized reflector lamp. An incandescent, metal halide, or compact fluorescent lamp used to redirect light from the source using a parabolic reflector. Lamps are available with flood or spot distributions

PAR 36: A PAR lamp that is 36 one-eighths of an inch in diameter with a parabolic shaped reflector (SEE PAR LAMP)

PARABOLIC LUMINAIRE: A popular type of fluorescent fixture that has a louver composed of aluminum baffles curved in a parabolic shape. The

resultant light distribution produced by this shape provides reduced glare, better light control, and is considered to have greater aesthetic appeal

PARACUBE: A metallic coated plastic louver made up of small squares. Often used to replace the lens in an installed troffer to enhance its appearance. The paracube is visually comfortable, but the luminaire efficiency is lowered. Also used in rooms with computer screens because of their glare-reducing qualities

PHOTOCELL: A light sensing device used to control luminaires and dimmers in response to detected light levels

PHOTOMETRIC REPORT: A photometric report is a set of printed data describing the light distribution, efficiency, and zonal lumen output of a luminaire. This report is generated from laboratory testing

POWER FACTOR: The ratio of the AC Volts x Amps through a device to the AC wattage of the device. A device such as a ballast that measures 120 Volts, 1 Amp, and 60 Watts has a power factor of 50% (Volts x Amps = 120 VA, therefore 60 Watts/120 VA = 0.5). Some utilities charge customers for low power factor systems

PREHEAT: A type of ballast/lamp circuit that uses a separate starter to heat up a fluorescent lamp before high voltage is applied to start the lamp

Q

QUAD-TUBE LAMP: A compact fluorescent lamp with a double twin tube configuration

R

RADIO FREQUENCY INTERFERENCE (RFI): Interference to the radio frequency band caused by other high frequency equipment or devices in the immediate area. Fluorescent lighting systems generate RFI

RAPID START (RS): The most popular fluorescent lamp/ballast combination used today. This ballast quickly and efficiently preheats lamp cathodes to start the lamp. Uses a "bi-pin" base

ROOM CAVITY RATIO (RCR): A ratio of room dimensions used to quantify how light will interact with room surfaces. A factor used in illuminance calculations

REFLECTANCE: The ratio of light reflected from a surface to the light incident on the surface. Reflectances are often used for lighting calculations. The reflectance of a dark carpet is around 20%, and a clean white wall is roughly 50% to 60%

REFLECTOR: The part of a light fixture that shrouds the lamps and redirects some light emitted from the lamp

REFRACTOR: A device used to redirect the light output from a source, primarily by bending the waves of light.

RECESSED: The term used to describe the doorframe of a troffer where the lens or louver lies above the surface of the ceiling.

REGULATION: The ability of a ballast to hold constant (or nearly constant) the output watts (light output) during fluctuations in the voltage feeding of the ballast. Normally specified as +/- percent change in output compared to +/- percent change in input.

RELAY: A device that switches an electrical load on or off based on small changes in current or voltage. Examples: low voltage relay and solid state relay

RETROFIT: Refers to upgrading a fixture, room, or building by installing new parts or equipment

REVERSE PHASE DIMMING: Rather than attempting to restrict the amplitude of the current flowing through a lamp, as in other forms of dimming, reverse phase control works by switching off the end part of each cycle of the alternating current supply

S

SELF-LUMINOUS EXIT SIGN: An illumination technology using phosphor-coated glass tubes filled with radioactive tritium gas. The exit sign uses no electricity and thus does not need to be hardwired

SEMI-SPECULAR: Term describing the light reflection characteristics of a material. Some light is reflected directionally, with some amount of scatter

SHIELDING ANGLE: The angle measured from the ceiling plane to the line of sight where the bare lamp in a luminaire becomes visible. Higher shielding angles reduce direct glare. It is the complementary angle of the cutoff angle. (See: CUTOFF ANGLE)

SPACING CRITERION: A maximum distance that interior fixtures may be spaced that ensures uniform illumination on the work plane. The luminaire height above the work plane multiplied by the spacing criterion equals the center-to-center luminaire spacing

SPECULAR: Mirrored or polished surface. The angle of reflection is equal to the angle of incidence. This word describes the finish of the material used in some louvers and reflectors

STARTER: A device used with a ballast to start (preheat) fluorescent lamps

STROBOSCOPIC EFFECT: Condition where rotating machinery or other rapidly moving objects appear to be standing still due to the alternating current supplied to light sources. Sometimes called "strobe effect."

T

T12 LAMP: Industry standard for a fluorescent lamp that is 12 one-eighths, one inch in diameter. Other sizes are T10 and T8 lamps

TANDEM WIRING: A wiring option in which a single ballast is shared by two or more luminaires. This reduces labor, materials, and energy costs. Also called "master-slave" wiring.

THERMAL FACTOR: A factor used in lighting calculations that compensates for the change in light output of a fluorescent lamp due to a change in bulb wall temperature. It is applied when the lamp-ballast combination under consideration is different from that used in the photometric tests.

THREE-WIRE ANALOG POWER DIMMING: Three-wire control is a line-voltage phase-control dimming method. Along with Hot and Neutral, the dimming signal is communicated via a third wire called Dimmed Hot. All three wires are rated Class 1 and can be run within the same conduit.

TRIGGER START: Type of ballast commonly used with 15-watt and 20-watt straight fluorescent lamps

TROFFER: The term used to refer to a recessed fluorescent light fixture (combination of trough and coffer)

TUNGSTEN HALOGEN LAMP: A gas-filled tungsten filament incandescent lamp with a lamp envelope made of quartz to withstand the high temperature. This lamp contains some halogens (namely iodine, chlorine, bromine, and fluorine), which slow the evaporation of the tungsten. Also, commonly called a quartz lamp

TWIN-TUBE: (SEE COMPACT FLUORESCENT LAMP)

TWO-WIRE ANALOG POWER DIMMING: Two-wire is a line-voltage phase-control dimming method. The ballast receives the dimming signal through the Dimmed Hot wire. Intended for small-scale retrofit applications, the two-wire control method is often the easiest way to implement dimming in existing fluorescent fixtures

U

ULTRA VIOLET (UV): Invisible radiation that is shorter in wavelength and higher in frequency than visible violet light (literally beyond the violet light)

UNDERWRITERS' LABORATORIES (UL): An independent organization whose responsibilities include rigorous testing of electrical products. When products pass these tests, they can be labeled (and advertised) as "UL listed." UL tests for product safety only

V

VANDAL-RESISTANT: Fixtures with rugged housings, break-resistant type shielding, and tamper-proof screws

VCP: Abbreviation for visual comfort probability. VCP is a rating system for evaluating direct discomfort glare. This method is a subjective evaluation of visual comfort expressed as the percent of occupants of a space who will be bothered by direct glare. VCP allows for several factors: luminaire luminances at different angles of view, luminaire size, room size, luminaire mounting height, illuminance, and room surface reflectivity. VCP tables are often provided as part of photometric reports

VERY HIGH OUTPUT (VHO): A fluorescent lamp that operates at a "very high" current (1500 mA), producing more light output than a "high output" lamp (800 mA) or standard output lamp (430 mA)

VOLT: The standard unit of measurement for electrical potential. It defines the "force" or "pressure" of electricity

VOLTAGE: The difference in electrical potential between two points of an electrical circuit

W

WALLWASHER: Describes luminaires that illuminate vertical surfaces.

WATT (W): The unit for measuring electrical power. It defines the rate of energy consumption by an electrical device when it is in operation. The energy cost of operating an electrical device is calculated as its wattage times the hours of use. In single-phase circuits, it is related to volts and amps by the formula: Volts x Amps x PF = Watts. (Note: For AC circuits, PF must be included.)

WORK PLANE: The level at which work is done and at which illuminance is specified and measured. For office applications, this is typically a horizontal plane 30 inches above the floor (desk height)

Z

ZENITH: The direction directly above the luminaire



Crestron Electronics, Inc.
15 Volvo Drive
Rockleigh, NJ 07647
www.crestron.com

Specifications subject
to change without notice
Doc. 4775A
04.09

Free Manuals Download Website

<http://myh66.com>

<http://usermanuals.us>

<http://www.somanuals.com>

<http://www.4manuals.cc>

<http://www.manual-lib.com>

<http://www.404manual.com>

<http://www.luxmanual.com>

<http://aubethermostatmanual.com>

Golf course search by state

<http://golfingnear.com>

Email search by domain

<http://emailbydomain.com>

Auto manuals search

<http://auto.somanuals.com>

TV manuals search

<http://tv.somanuals.com>