

Isys Wall Mount Touchpanels overview

Crestron's wall mount touchpanels are elegantly designed to provide a perfect flush mount control solution for all types of applications. A single touchpanel can provide the ideal centralized controller for a facility full of equipment. Or, multiple touchpanels can be deployed throughout a home or commercial facility to provide extensive multipoint control of a large AV distribution or automation system. Whatever the application, with a complete range of sizes available, Isys Wall Mount Touchpanels provide the ideal combination of performance, programmability, and versatile installation.

Every one of Crestron's tilt touchpanel models, from 6.4" to 17" widescreen, is also offered in an attractive flush mount version designed for lectern, wall, and rack mount installations. Each model features the same high performance and

connectivity as its tilt model counterpart. Fresh, modern styling with backlit hard buttons, front-firing speakers and integral microphone provide exceptional function and great looks.

For homes and offices requiring a smaller, more cost-effective solution, Crestron offers the compact **Isys TPS-4L** 3.6" Wall Mount Touchpanel. Its bright active matrix color touchscreen and high-speed Ethernet connectivity deliver a very powerful and elegant user interface in the space of a common keypad or light switch. Also available, the **Isys TPS-2000L** affords a 5" touchpanel solution with video and intercom capabilities that's affordable enough to put one in every room.

All Isys Wall Mount Touchpanels are available in a choice of black or white, with additional designer colors and finishes available for models 10.4" and smaller.

Typical Isys Wall Mount Touchpanel Application using Crestron Home® CAT5 AV

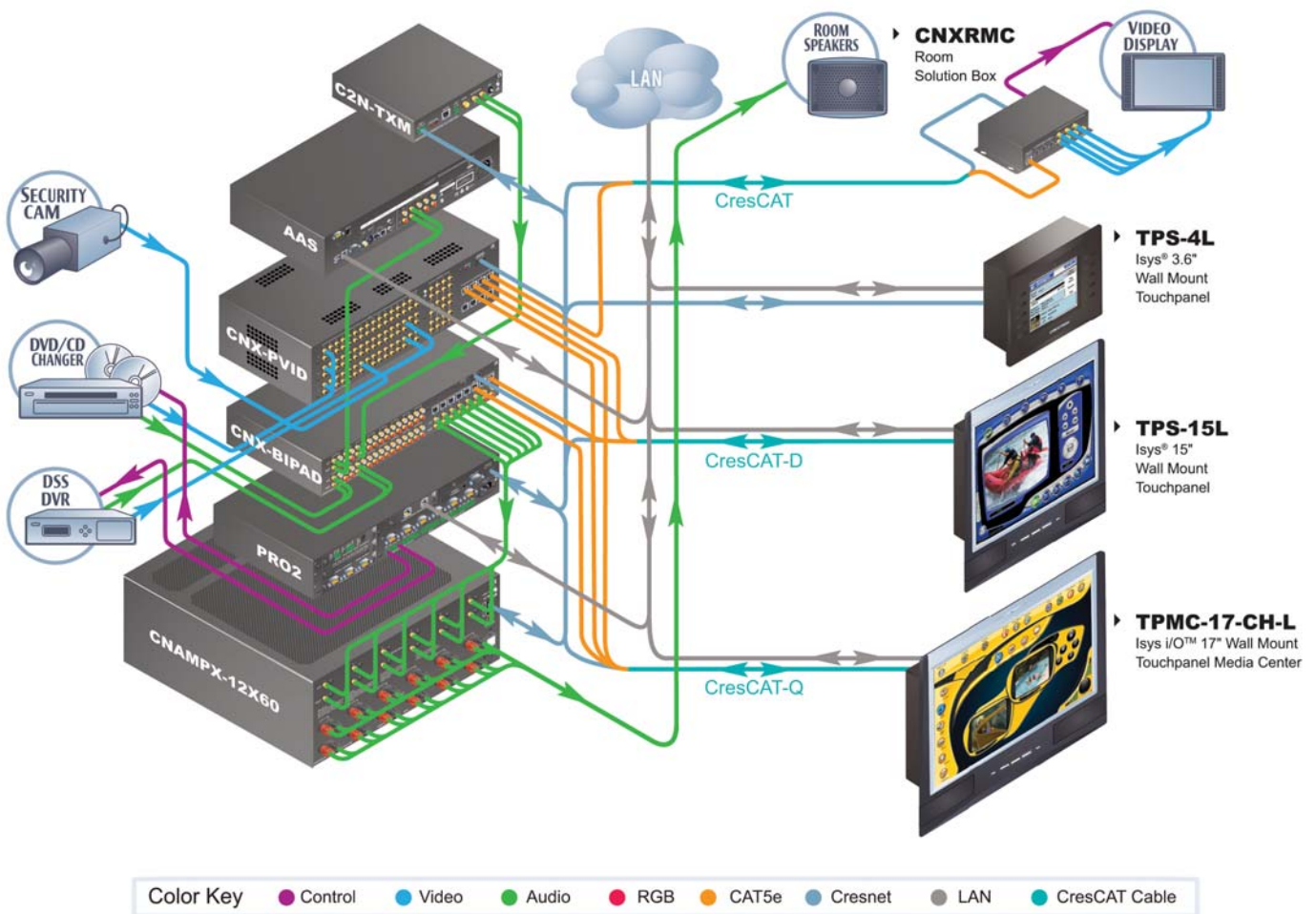

See end of section for additional diagrams

Isys Wall Mount Touchpanels cross reference

Isys Wall Mount Touchpanels					
	TPS-17L	TPS-15L	TPS-12L	TPS-4000L	TPS-3100L
Touchscreen Display					
Display Size	17"	15"	12"	10.4"	6.4"
Aspect Ratio	15:9 WXGA	4:3 XGA	4:3 SVGA	4:3 VGA	4:3 VGA
Resolution	1280 x 768	1024 x 768	800 x 600	640 x 480	640 x 480
Color Depth	24-bit 16.7M	24-bit 16.7M	18-bit 256k	18-bit 256k	18-bit 256k
Touchpanel Graphics					
Color Depth	24-bit 16.7M	24-bit 16.7M	24-bit 16.7M	16-bit 64K	16-bit 64K
8-bit Alpha Channel Transparency	•	•	•		
Synapse Image Rendering and Multimode Objects	•	•	•	•	•
Dynamic Text and Animation	•	•	•	•	•
Dynamic Graphics and PNG Translucency	•	•	•		
Dynamic Menu Objects					
Memory					
RAM	128MB	128MB	128MB	8MB	8MB
Flash	64MB	64MB	64MB	8MB	8MB
Memory Card Slot	up to 4GB	up to 4GB	up to 4GB		
Maximum Project Size	160MB	160MB	160MB	7MB	7MB
Annotation & PC					
Windows XP Embedded OS					
Web Browser and Media Player, Remote Desktop, VoIP, NetMeeting, Yahoo! Widgets, MS Office and Adobe Document Viewers ⁶					
Annotation					
Keyboard/Mouse Input					
Touch-the-PC					
Video/RGB					
Scalable Windows	1	1	1	1	1
Hardware Connections	QM, CH, BNC ¹	QM, CH, BNC ¹	QM, CH, BNC ¹	CH, BNC	CH, BNC
Composite	•	•	•	•	•
S-Video	•	•	•	•	•
Component	•	•	•		
HDTV up to 1080i					
RGB up to 1600 x 1200					
Streaming Motion-JPEG					
Media Player (Multiple Formats)					
Display Output					
Audio					
Amplified Speakers and Microphone	•	•	•	•	•
WAV Sound File Audio Feedback	•	•	•	•	•
Network					
Cresnet	•	•	•	•	•
Ethernet	•	•	•		
Wi-Fi ²					
Buttons					
Backlit Softkeys	4	4	4		
Programmable, Engravable Hard Buttons				5	5
Mounting					
Wall or Lectern Mount ⁴	•	•	•	•	•
Rack Mount ⁴	9U	9U	8U	6U	5U
Finishes					
White or Black	•	•	•	•	•
Almond				•	•
Additional Colors & Finishes				•	•

¹ Connections via outboard IMC interface module (included)

² Also supports coaxial connection

³ Wireless NIC required

⁴ Appropriate mounting accessory(ies) required

⁵ Rack mount provided by others

⁶ See product spec for a complete list of embedded applications

This chart intended for summary comparison only; see each product specification for complete information.

ISYS® WALL MOUNT TOUCHPANELS

→ Isys® Wall Mount Touchpanels

TPS-17L Isys® 17" Widescreen Wall Mount Touchpanel



High-Performance Video—The TPS-17L can display full-motion video from an external AV source, either full screen or in a scalable window. Motion adaptive deinterlacing brings out the highest detail, minimizing visible scan lines and motion artifacts for a truly remarkable picture. Advanced gamma correction and built-in time base correction ensure accurate color reproduction and a jitter-free image.

High-Quality Audio—The high-powered biamplified speaker system provides amplification for external AV sources, and supports intercom functionality in combination with the integrated microphone. Customized WAV files can be loaded on the touchpanel to add dimension to the touchscreen graphics with personalized sounds, button feedback, and voice prompts.

Crestron Home® CAT5 AV—Connecting audio and video sources to the TPS-17L is facilitated using inexpensive CAT5 wire, enabling direct connection to Crestron's popular CAT5 balanced audio and video distribution switchers. A single video input port accepts signals from composite, S-Video, and standard-definition component sources over wiring distances of up to 750 feet. A bidirectional audio port receives stereo program audio and intercom signals, and outputs audio from the internal microphone. To facilitate the connection of conventional video and audio devices, an external interface module is included.

QuickMedia™—The TPS-17L is also equipped with a single QuickMedia input port. Through QuickMedia (QM), the TPS-17L interfaces directly with Crestron's QM-based MediaManager products using a single CAT5e type cable. Over wiring distances of up to 300 feet, the QM Input port accepts video signals from composite, S-Video, and standard-definition component sources along with discrete audio signals from one (1) stereo program source and up to two (2) microphones.

High-Speed Connectivity—Both Cresnet and high-speed Ethernet are standard on the TPS-17L, providing for easy network integration and seamless communications with Crestron control systems.

Versatile Flush Mount Design—The TPS-17L is designed for flush-mount installation in a wall, lectern or similar flat surface. A variety of mounting accessories is offered including optional back box and 19" rack mount kit. Five backlit pushbuttons are also provided, allowing for quick access to commonly used functions.

Crestron's new Isys touchpanels deliver a higher level of performance to meet the demands of today's sophisticated control and automation applications. Incorporating modern styling in a versatile flush mount design, the Isys TPS-17L features a spectacular 17" WXGA widescreen display offering an extra wide viewing angle with exceptional brightness and contrast for stunning control graphics, high-resolution images, and full-motion video.

Crestron touchpanels offer an ideal user-interface for multimedia presentation, videoconferencing, home automation, and much more, providing a wide-open canvas for the creation of custom control screens tailored to the needs of the end-user. Touchpanels do away with piles of remote controls, cryptic control panels and cluttered wall switches, simultaneously expanding and simplifying control over a broad range of complex devices and systems.

Isys®—Isys power and beauty are infused throughout Crestron's entire touchpanel lineup. Under the hood, the TPS-17L offers vibrant 24-bit color depth with 8-bit alpha channel transparency to produce incredible 3D graphics and high-res images. The Isys engine supports dynamic graphics and text, full-motion animations, multimode objects, and PNG translucency - all with astonishing speed.

Synapse™—Crestron's exclusive Synapse Image Rendering Algorithm enables system programmers to produce amazing graphics - faster and easier. Advanced antialiasing delivers crisper, sharper objects and text. Enhanced 3D effects add new depth and style. And because Synapse is native to the touchpanel, memory requirements and upload time are substantially reduced.

ISYS® WALL MOUNT TOUCHPANELS

→ Isys® Wall Mount Touchpanels

Isys® 17" Widescreen Wall Mount Touchpanel **TPS-17L**

- ▶ 17" widescreen active matrix touchscreen display | 1280 x 768 resolution
- ▶ 24-Bit Isys graphics | Synapse image rendering algorithm
- ▶ Full-motion video with gamma correction and motion adaptive deinterlacing
- ▶ Built-in biamplified speaker system and microphone
- ▶ Backlit "Softkey" pushbuttons
- ▶ QuickMedia and Crestron Home CAT5 AV connectivity
- ▶ High-speed Ethernet and Cresnet communications
- ▶ Wall, lectern, and rack mounting options
- ▶ Available in black or white

AVAILABLE MODELS

TPS-17LB

Isys 17" Widescreen Wall Mount Touchpanel, Black

TPS-17LW

Isys 17" Widescreen Wall Mount Touchpanel, White

TPS-17L using CAT5 AV Interface Module

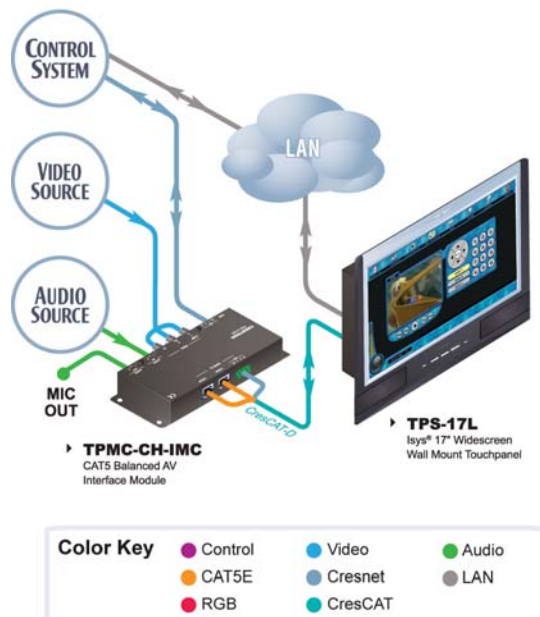

SPECIFICATIONS

Touchscreen Display

Display Type: TFT Active matrix color LCD
Size: 17 inch (43.2 cm) diagonal widescreen
Aspect Ratio: 15:9 WXGA
Resolution: 1280 x 768 pixels
Brightness: 450 nits (cd/m²)
Contrast: 400:1
Color Depth: 24-bit, 16.7M colors
Illumination: Backlit fluorescent
Viewing Angle: ±88° horizontal, ±88° vertical
Touchscreen: Resistive membrane

Processor

CPU: 32-bit Freescale ColdFire® Microprocessor

Memory

DDR RAM: 128 MB
Flash: 64 MB
Compact Flash: Accepts up to 4GB Type II CF (not included)
Maximum Project Size: 160 MB

Graphic Engine

Isys engine, 24-bit non-palette graphics + 8-bit alpha channel transparency, 16.7 million colors, Synapse image rendering algorithm, multi-mode objects, dynamic graphics, PNG translucency, full-motion (60 fps) animation, transition effects, color key video windowing

Ethernet

10BaseT/100BaseTX, auto-switching, auto-negotiating, full/half duplex, TCP/IP, UDP/IP, CIP, IEEE 802.3U compliant

Video

Signal Types: Auto-detecting composite, S-Video, or component
Formats: NTSC 480i or PAL 576i
Color Depth: 24-bit, 16.7M colors
Features: Single-window scalable to full-screen, input switching between QM and VIDEO inputs, time base correction, gamma correction, line doubling, motion adaptive deinterlacing, reverse 3:2/2:2 pulldown

Audio

Hardware Features: Built-in microphone and biamplified speakers, stereo headphone output, internal volume control and audio mixer
Audio Feedback (WAV): 8-bit PCM, mono, 8 kHz sampling rate
D-A Conversion (QM only): 24-bit, 48 kHz
Amplification: Biamplified, mono, 5 Watts for high-frequency, 5 Watts for low-frequency

Buttons

- (4) Backlit "softkey" buttons, programmable
- (1) Backlit hard reset button, reboots the touchpanel

> continued

ISYS® WALL MOUNT TOUCHPANELS

→ Isys® Wall Mount Touchpanels

TPS-17L Isys® 17" Widescreen Wall Mount Touchpanel (continued)

Connectors

QM IN: (1) 8-wire RJ45 female, QuickMedia input port
Signal Types: Auto-detecting component (YPbPr), S-Video (Y/C), or composite video with stereo program audio and (2) mic channels;
Video Formats: NTSC 480i or PAL 576i;
Connects to QM output port of a QM-TX or other QuickMedia device via CresCAT-QM or CresCAT-IM cable;
Maximum Cable Length: 300 ft (aggregate distance from QM origination)

VIDEO IN: (1) 8-wire RJ45 female, CAT5 balanced video input port
Signal Types: Auto-detecting component (YPbPr), S-Video (Y/C), or composite;
Formats: NTSC 480i or PAL 576i
Input Impedance: 100 ohms balanced
Connects to any Crestron CAT5 balanced video source, or TPMC-CH-IMC interface module (included), via CresCAT cable or TPS/TPMC-CBL-T "triamese" cable (sold separately);
Maximum Cable Length: 500 feet for component, 750 feet for composite/S-Video

AUDIO I/O: (1) 8-wire RJ45 female
Bidirectional CAT5 balanced audio port
Signal Types: Receives (1) balanced stereo audio signal, and transmits (1) balanced stereo audio signal from internal microphone;
Maximum Input Level: 4 V_{RMS}
Maximum Output Level: 2 V_{RMS}
Input/Output Impedance: 600 ohms
Connects to any other Crestron CAT5 balanced audio port, or TPMC-CH-IMC interface module (included), via CresCAT cable or TPS/TPMC-CBL-T "triamese" cable (sold separately);
Maximum Cable Length: 1000 feet

HEADPHONES: (1) 3.5 mm TRS mini phone jack
Output Power: 12mW per channel
Minimum Impedance: 32 ohms

USB: (1) USB Type B female (reserved for future applications)

NET: (1) 4-pin 3.5mm detachable terminal block; Cresnet Slave port
Connects to Cresnet control network or TPMC-CH-IMC interface module (included) via CresCAT, Cresnet, or TPS/TPMC-CBL-T "triamese" cable (sold separately)

LAN: (1) 8-wire RJ45 with 2 LED indicators
10BaseT/100BaseTX Ethernet port
Green LED indicates link status
Yellow LED indicates Ethernet activity

RS-232: (1) 6-pin RJ11 female
Computer console, touch output or mouse input port
Bidirectional RS-232 up to 115.2k baud
Hardware and software handshaking support

G: (1) 6-32 screw, chassis ground lug

MEMORY EXPANSION: (1) Type II Compact Flash card slot for memory expansion

Power Requirements

Cresnet Power Usage: 74 Watts (3.1 Amps @ 24 Volts DC)

Environmental

Temperature: 41° to 113°F (5° to 45°C)

Humidity: 10% to 90% RH (non-condensing)

Enclosure

Construction: Metal, flush mountable, 9U 19" rack-mountable (all mounting kits sold separately)

Front Bezel: Injection-molded plastic; black w/silver or white w/gray accent

Dimensions

Height: 13.81 in (35.06 cm)

Width: 16.98 in (43.11 cm)

Depth: 3.84 in (9.74 cm)

Weight

12.7 lbs (5.76 kg)

INCLUDED ACCESSORIES

TPMC-CH-IMC

CAT5 Balanced AV Interface Module (See TPMC-CH-IMC specifications for complete information)

TPS-17L using QuickMedia

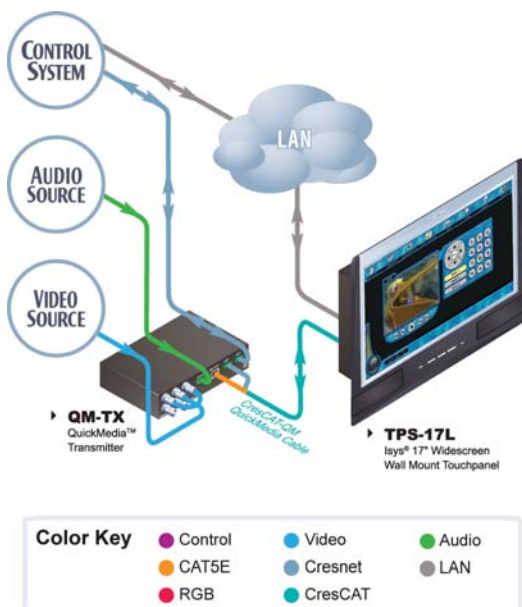

ISYS® WALL MOUNT TOUCHPANELS

► Isys® Wall Mount Touchpanels

Isys® 17" Widescreen Wall Mount Touchpanel **TPS-17L**

TPS-17L in a CAT5 AV Distribution System

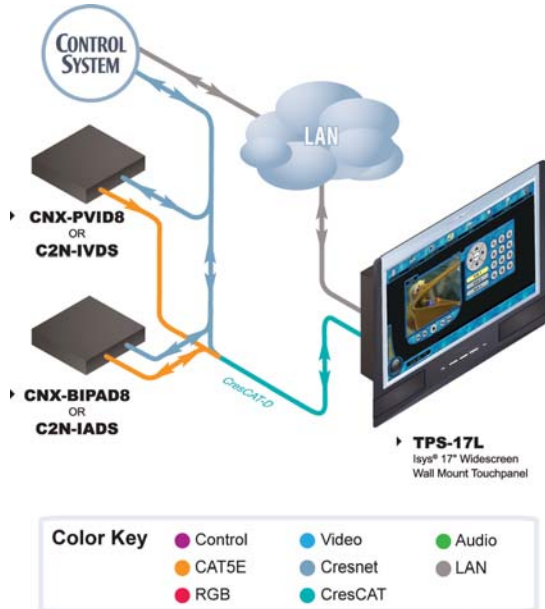

Wall mount touchpanels

AVAILABLE ACCESSORIES

- | | | | |
|--|--|--|--|
| ▶ BB-17L
Pre-Construction
Wall Mount Back Box | ▶ WMKT-17L
Lectern Mount Kit
with Trim Ring | ▶ TPS/TPMC-CBL-T
Triamese Interface Cables | ▶ CresCAT®D
Crestron Home® CAT5
Balanced AV Cable |
| ▶ PMK-17L
Pre-Construction
Wall Mount Kit | ▶ RMK-17L
Rack Mount Kit | ▶ QM-TX
QuickMedia Transmitter | ▶ CresCAT®QM
QuickMedia™ Cable |
| ▶ TMK-17L
Trim Ring | ▶ TPMC-CH-IMW
CAT5 Balanced AV
Interface Wall Plate | ▶ ST-PK
Programming Cable Kit | ▶ CresCAT®IM
iMedia Cable |
| ▶ MMK-17L
Mud Ring | | | |

ISYS® WALL MOUNT TOUCHPANELS

→ Isys® Wall Mount Touchpanels

TPS-15L Isys® 15" Wall Mount Touchpanel



wall mount touchpanels

Crestron's new Isys touchpanels deliver a higher level of performance to meet the demands of today's sophisticated control and automation applications. Incorporating modern styling in a versatile flush mount design, the Isys TPS-15L features a spectacular 15" XGA true-color display offering an extra wide viewing angle with exceptional brightness and contrast for stunning control graphics, high-resolution images, and full-motion video.

Crestron touchpanels offer an ideal user-interface for multimedia presentation, videoconferencing, home automation, and much more, providing a wide-open canvas for the creation of custom control screens tailored to the needs of the end-user. Touchpanels do away with piles of remote controls, cryptic control panels and cluttered wall switches, simultaneously expanding and simplifying control over a broad range of complex devices and systems.

Isys®—Isys power and beauty are infused throughout Crestron's entire touchpanel lineup. Under the hood, the TPS-15L offers vibrant 24-bit color depth with 8-bit alpha channel transparency to produce incredible 3D graphics and high-res images. The Isys engine supports dynamic graphics and text, full-motion animations, multimode objects, and PNG translucency - all with astonishing speed.

Synapse™—Crestron's exclusive Synapse Image Rendering Algorithm enables system programmers to produce amazing graphics - faster and easier. Advanced antialiasing delivers crisper, sharper objects and text. Enhanced 3D effects add new depth and style. And because Synapse is native to the touchpanel, memory requirements and upload time are substantially reduced.

High-Performance Video—The TPS-15L can display full-motion video from an external AV source, either full screen or in a scalable window. Motion adaptive deinterlacing brings out the highest detail, minimizing visible scan lines and motion artifacts for a truly remarkable picture. Advanced gamma correction and built-in time base correction ensure accurate color reproduction and a jitter-free image.

High-Quality Audio—The high-powered biamplified speaker system provides amplification for external AV sources, and supports intercom functionality in combination with the integrated microphone. Customized WAV files can be loaded on the touchpanel to add dimension to the touchscreen graphics with personalized sounds, button feedback, and voice prompts.

Crestron Home®—CAT5 AVConnecting audio and video sources to the TPS-15L is facilitated using inexpensive CAT5 wire, enabling direct connection to Crestron's popular CAT5 balanced audio and video distribution switchers. A single video input port accepts signals from composite, S-Video, and standard-definition component sources over wiring distances of up to 750 feet. A bidirectional audio port receives stereo program audio and intercom signals, and outputs audio from the internal microphone. To facilitate the connection of conventional video and audio devices, an external interface module is included.

QuickMedia™—The TPS-15L is also equipped with a single QuickMedia input port. Through QuickMedia (QM), the TPS-15L interfaces directly with Crestron's QM-based MediaManager products using a single CAT5e type cable. Over wiring distances of up to 300 feet, the QM Input port accepts video signals from composite, S-Video, and standard-definition component sources along with discrete audio signals from one (1) stereo program source and up to two (2) microphones.

High-Speed Connectivity—Both Cresnet and high-speed Ethernet are standard on the TPS-15L, providing for easy network integration and seamless communications with Crestron control systems.

Versatile Flush Mount Design—The TPS-15L is designed for easy flush-mount installation in a wall, lectern or similar flat surface. A variety of mounting accessories is offered including optional back box and 19" rack mount kit. Five backlit pushbuttons are also provided, allowing for quick access to commonly used functions.

ISYS® WALL MOUNT TOUCHPANELS

→ Isys® Wall Mount Touchpanels

Isys® 15" Wall Mount Touchpanel **TPS-15L**

- ▶ 15" active matrix touchscreen display | 1024 x 768 resolution
- ▶ 24-Bit Isys graphics | Synapse image rendering algorithm
- ▶ Full-motion video with gamma correction and motion adaptive deinterlacing
- ▶ Built-in biamplified speaker system and microphone
- ▶ Backlit "Softkey" pushbuttons
- ▶ QuickMedia and Crestron Home CAT5 AV connectivity
- ▶ High-speed Ethernet and Cresnet communications
- ▶ Wall, lectern, and rack mounting options
- ▶ Available in black or white

AVAILABLE MODELS

TPS-15LB

Isys 15" Wall Mount Touchpanel, Black

TPS-15LW

Isys 15" Wall Mount Touchpanel, White

SPECIFICATIONS

Touchscreen Display

Display Type: TFT Active matrix color LCD

Size: 15 inch (38.1 cm) diagonal

Aspect Ratio: 4:3 XGA

Resolution: 1024 x 768 pixels

Brightness: 350 nits (cd/m²)

Contrast: 700:1

Color Depth: 24-bit, 16.7M colors

Illumination: Backlit fluorescent

Viewing Angle: ±85° horizontal, ±85° vertical

Touchscreen: Resistive membrane

Processor

CPU: 32-bit Freescale ColdFire® Microprocessor

Memory

DDR RAM: 128 MB

Flash: 64 MB

Compact Flash: Accepts up to 4GB Type II CF (not included)

Maximum Project Size: 160 MB

Graphic Engine

Isys engine, 24-bit non-palette graphics + 8-bit alpha channel transparency, 16.7 million colors, Synapse image rendering algorithm, multi-mode objects, dynamic graphics, PNG translucency, full-motion (60 fps) animation, transition effects, color key video windowing

Embedded Software Applications¹

Microsoft Internet Explorer w/Macromedia® Flash® plug-in, Windows Media® Player, RealPlayer®, Axis® Media Control, Crestron MediaMarker™, Remote Desktop, NetMeeting®, Skype™, Java™ Runtime, DirectX®, Yahoo! Widgets®, Adobe® Acrobat® Reader, and viewers for MS Word, Excel, and PowerPoint®

Ethernet

10BaseT/100BaseTX, auto-switching, auto-negotiating, full/half duplex, TCP/IP, UDP/IP, CIP, IEEE 802.3U compliant

Video

Signal Types: Auto-detecting composite, S-Video, or component

Formats: NTSC 480i or PAL 576i

Color Depth: 24-bit, 16.7M colors

Features: Single-window scalable to full-screen, input switching between QM and VIDEO inputs, time base correction, gamma correction, line doubling, motion adaptive deinterlacing, reverse 3:2/2:2 pulldown

Audio

Hardware Features: Built-in microphone and biamplified speakers, stereo headphone output, internal volume control and audio mixer

Audio Feedback (WAV): 8-bit PCM, mono, 8 kHz sampling rate

D-A Conversion (QM only): 24-bit, 48 kHz

Amplification: Bi-amplified, mono, 5 Watts for high-frequency, 5 Watts for low-frequency

Buttons

(4) Backlit "softkey" buttons, programmable

(1) Backlit hard reset button, reboots the touchpanel

TPS-15L using CAT5 AV Interface Module

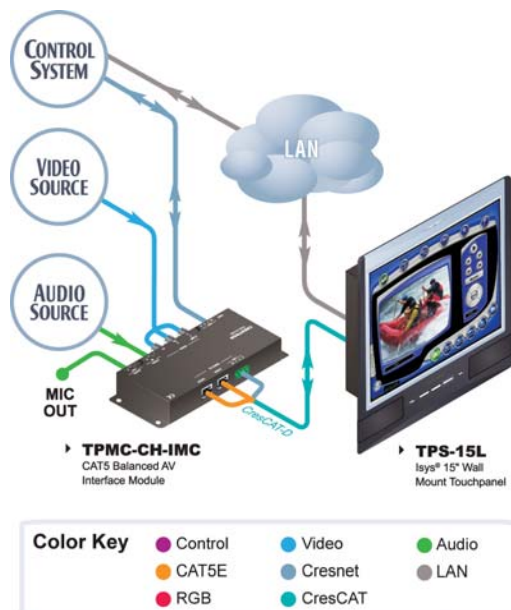

> continued

ISYS® WALL MOUNT TOUCHPANELS

→ Isys® Wall Mount Touchpanels

TPS-15L Isys® 15" Wall Mount Touchpanel (continued)

Connectors

QM IN: (1) 8-wire RJ45 female, QuickMedia input port
Signal Types: Auto-detecting component (YPbPr), S-Video (Y/C), or composite video with stereo program audio and (2) mic channels;
Video Formats: NTSC 480i or PAL 576i
Connects to QM output port of a QM-TX or other QuickMedia device via CresCAT-QM or CresCAT-IM cable;
Maximum Cable Length: 300 ft (aggregate distance from QM origination)

VIDEO IN: (1) 8-wire RJ45 female, CAT5 balanced video input port
Signal Types: Auto-detecting component (YPbPr), S-Video (Y/C), or composite;
Formats: NTSC 480i or PAL 576i
Input Impedance: 100 ohms balanced
Connects to any Crestron CAT5 balanced video source, or TPMC-CH-IMC interface module (included), via CresCAT cable or TPS/TPMC-CBL-T "triamese" cable (sold separately);
Maximum Cable Length: 500 feet for component, 750 feet for composite/S-Video

AUDIO I/O: (1) 8-wire RJ45 female
Bidirectional CAT5 balanced audio port
Signal Types: Receives (1) balanced stereo audio signal, and transmits (1) balanced stereo audio signal from internal microphone;
Maximum Input Level: 4 V_{RMS}
Maximum Output Level: 2 V_{RMS}
Input/Output Impedance: 600 ohms
Connects to any other Crestron CAT5 balanced audio port, or TPMC-CH-IMC interface module (included), via CresCAT cable or TPS/TPMC-CBL-T "triamese" cable (sold separately);
Maximum Cable Length: 1000 feet

HEADPHONES: (1) 3.5 mm TRS mini phone jack
Output Power: 12mW per channel
Minimum Impedance: 32 ohms

USB: (1) USB Type B female (reserved for future applications)

NET: (1) 4-pin 3.5mm detachable terminal block; Cresnet Slave port
Connects to Cresnet control network, or TPMC-CH-IMC interface module (included) via CresCAT, Cresnet, or TPS/TPMC-CBL-T "triamese" cable (sold separately)

LAN: (1) 8-wire RJ45 with 2 LED indicators
10BaseT/100BaseTX Ethernet port
Green LED indicates link status
Yellow LED indicates Ethernet activity

RS-232: (1) 6-pin RJ11 female
Computer console, touch output or mouse input port
Bidirectional RS-232 up to 115.2k baud
Hardware and software handshaking support

G: (1) 6-32 screw, chassis ground lug

MEMORY EXPANSION: (1) Type II Compact Flash card slot for memory expansion

Power Requirements

Cresnet Power Usage: 65 Watts (2.7 Amps @ 24 Volts DC)

Environmental

Temperature: 41° to 113°F (5° to 45°C)

Humidity: 10% to 90% RH (non-condensing)

Enclosure

Construction: Metal, flush mountable, 9U 19" rack-mountable (all mounting kits sold separately)

Front Bezel: Injection-molded plastic; black w/silver or white w/gray accent

Dimensions

Height: 13.59 in (34.52 cm)

Width: 14.17 in (35.99 cm)

Depth: 3.80 in (9.66 cm)

Weight

9.4 lbs (4.26 kg)

INCLUDED ACCESSORIES

TPMC-CH-IMC

CAT5 Balanced AV Interface Module

(See TPMC-CH-IMC specifications for complete information)

TPS-15L using QuickMedia

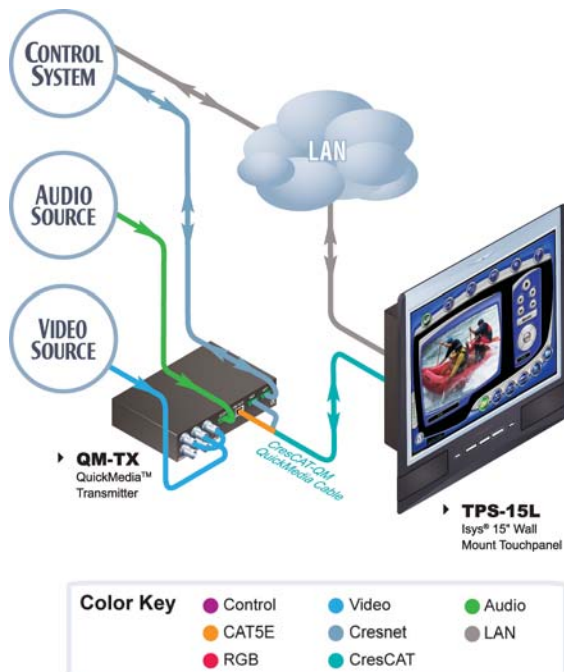

ISYS® WALL MOUNT TOUCHPANELS

→ Isys® Wall Mount Touchpanels

Isys® 15" Wall Mount Touchpanel **TPS-15L**

TPS-15L in a CAT5 AV Distribution System

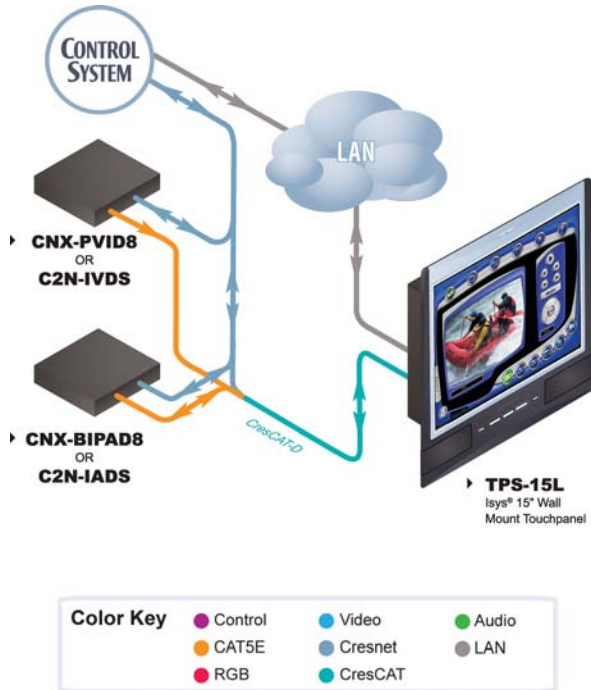

Wall mount touchpanels

AVAILABLE ACCESSORIES

- | | | | |
|--|--|--|--|
| ▶ BB-15L
Pre-Construction
Wall Mount Back Box | ▶ WMKT-15L
Lectern Mount Kit
with Trim Ring | ▶ TPS/TPMC-CBL-T
Triamese Interface Cables | ▶ CresCAT®D
Crestron Home® CAT5
Balanced AV Cable |
| ▶ PMK-15L
Pre-Construction
Wall Mount Kit | ▶ WMKM-15L
Post-Construction Wall
Mount Kit with Mud Ring | ▶ QM-TX
QuickMedia Transmitter | ▶ CresCAT®QM
QuickMedia™ Cable |
| ▶ TMK-15L
Trim Ring | ▶ RMK-15L
Rack Mount Kit | ▶ ST-PK
Programming Cable Kit | ▶ CresCAT®IM
iMedia Cable |
| ▶ MMK-15L
Mud Ring | ▶ TPMC-CH-IMW
CAT5 Balanced AV
Interface Wall Plate | | |

ISYS® WALL MOUNT TOUCHPANELS

→ Isys® Wall Mount Touchpanels

TPS-12L Isys® 12" Wall Mount Touchpanel



Crestron's new Isys touchpanels deliver a higher level of performance to meet the demands of today's sophisticated control and automation applications. Incorporating modern styling in a versatile flush mount design, the Isys TPS-12L features a spectacular 12" SVGA display offering a wide viewing angle with exceptional brightness and contrast for stunning control graphics, high-resolution images, and full-motion video.

Crestron touchpanels offer an ideal user-interface for multimedia presentation, videoconferencing, home automation, and much more, providing a wide-open canvas for the creation of custom control screens tailored to the needs of the end-user. Touchpanels do away with piles of remote controls, cryptic control panels and cluttered wall switches, simultaneously expanding and simplifying control over a broad range of complex devices and systems.

Isys®—Isys power and beauty are infused throughout Crestron's entire touchpanel lineup. Under the hood, the TPS-12L offers vibrant 24-bit color depth with 8-bit alpha channel transparency to produce incredible 3D graphics and high-res images. The Isys engine supports dynamic graphics and text, full-motion animations, multimode objects, and PNG translucency - all with astonishing speed.

Synapse™—Crestron's exclusive Synapse Image Rendering Algorithm enables system programmers to produce amazing graphics - faster and easier. Advanced antialiasing delivers crisper, sharper objects and text. Enhanced 3D effects add new depth and style. And because Synapse is native to the touchpanel, memory requirements and upload time are substantially reduced.

High-Performance Video—The TPS-12L can display full-motion video from an external AV source, either full screen or in a scalable window. Motion adaptive deinterlacing brings out the highest detail, minimizing visible scan lines and motion artifacts for a truly remarkable picture. Advanced gamma correction and built-in time base correction ensure accurate color reproduction and a jitter-free image.

High-Quality Audio—The high-powered biamplified speaker system provides amplification for external AV sources, and supports intercom functionality in combination with the integrated microphone. Customized WAV files can be loaded on the touchpanel to add dimension to the touchscreen graphics with personalized sounds, button feedback, and voice prompts.

Crestron Home® CAT5 AV—Connecting audio and video sources to the TPS-12L is facilitated using inexpensive CAT5 wire, enabling direct connection to Crestron's popular CAT5 balanced audio and video distribution switchers. A single video input port accepts signals from composite, S-Video, and standard-definition component sources over wiring distances of up to 750 feet. A bidirectional audio port receives stereo program audio and intercom signals, and outputs audio from the internal microphone. To facilitate the connection of conventional video and audio devices, an external interface module is included.

QuickMedia™—The TPS-12L is also equipped with a single QuickMedia input port. Through QuickMedia (QM), the TPS-12L interfaces directly with Crestron's QM-based MediaManager products using a single CAT5e type cable. Over wiring distances of up to 300 feet, the QM Input port accepts video signals from composite, S-Video, and standard-definition component sources along with discrete audio signals from one (1) stereo program source and up to two (2) microphones.

High-Speed Connectivity—Both Cresnet and high-speed Ethernet are standard on the TPS-12L, providing for easy network integration and seamless communications with Crestron control systems.

Versatile Flush Mount Design—The TPS-12L is designed for easy flush-mount installation in a wall, lectern or similar flat surface. A variety of mounting accessories is offered including optional back box and 19" rack mount kit. Five backlit pushbuttons are also provided, allowing for quick access to commonly used functions.

ISYS® WALL MOUNT TOUCHPANELS

→ Isys® Wall Mount Touchpanels

Isys® 12" Wall Mount Touchpanel **TPS-12L**

- ▶ 12" active matrix touchscreen display | 800 x 600 resolution
- ▶ 24-Bit Isys graphics | Synapse image rendering algorithm
- ▶ Full-motion video with gamma correction and motion adaptive deinterlacing
- ▶ Built-in biamplified speaker system and microphone
- ▶ Backlit "Softkey" pushbuttons
- ▶ QuickMedia and Crestron Home CAT5 AV connectivity
- ▶ High-speed Ethernet and Cresnet communications
- ▶ Wall, lectern, and rack mounting options
- ▶ Available in black or white

AVAILABLE MODELS

TPS-12LB

Isys 12" Wall Mount Touchpanel, Black

TPS-12LW

Isys 12" Wall Mount Touchpanel, White

TPS-12L using CAT5 AV Interface Module

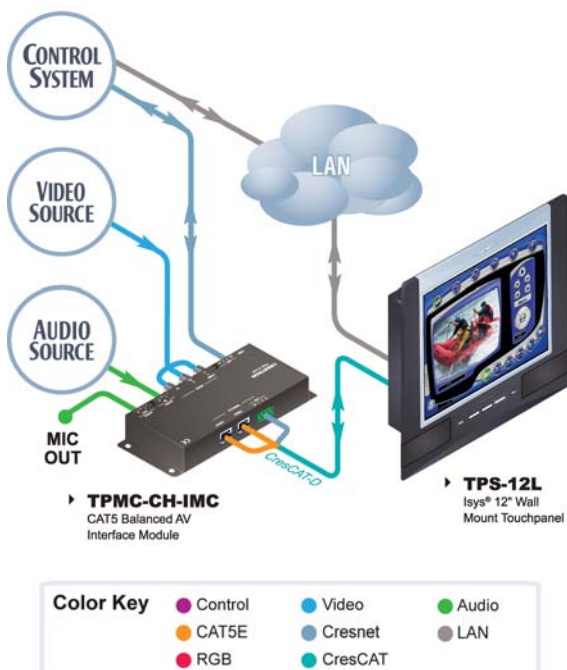

SPECIFICATIONS

Touchscreen Display

Display Type: TFT Active matrix color LCD

Size: 12 inch (30.5 cm) diagonal

Aspect Ratio: 4:3 SVGA

Resolution: 800 x 600 pixels

Brightness: 400 nits (cd/m²)

Contrast: 300:1

Color Depth: 18-bit, 256k colors

Illumination: Backlit fluorescent

Viewing Angle: ±70° horizontal, +45/-55° vertical

Touchscreen: Resistive membrane

Processor

CPU: 32-bit Freescale ColdFire® Microprocessor

Memory

DDR RAM: 128 MB

Flash: 64 MB

Compact Flash: Accepts up to 4GB Type II CF (not included)

Maximum Project Size: 160 MB

Graphic Engine

Isys engine, 24-bit non-palette graphics + 8-bit alpha channel transparency, 16.7 million colors, Synapse image rendering algorithm, multi-mode objects, dynamic graphics, PNG translucency, full-motion (60 fps) animation, transition effects, color key video windowing

Ethernet

10BaseT/100BaseTX, auto-switching, auto-negotiating, full/half duplex, TCP/IP, UDP/IP, CIP, IEEE 802.3U compliant

Video

Signal Types: Auto-detecting composite, S-Video, or component

Formats: NTSC 480i or PAL 576i

Color Depth: 24-bit, 16.7M colors

Features: Single-window scalable to full-screen, input switching between QM and VIDEO inputs, time base correction, gamma correction, line doubling, motion adaptive deinterlacing, reverse 3:2:2:2 pulldown

Audio

Hardware Features: Built-in microphone and biamplified speakers, stereo headphone output, internal volume control and audio mixer

Audio Feedback (WAV): 8-bit PCM, mono, 8 kHz sampling rate

D-A Conversion (QM only): 24-bit, 48 kHz

Amplification: Biamplified, mono, 5 Watts for high-frequency, 5 Watts for low-frequency

Buttons

(4) Backlit "softkey" buttons, programmable

(1) Backlit hard reset button, reboots the touchpanel

> continued

ISYS® WALL MOUNT TOUCHPANELS

→ Isys® Wall Mount Touchpanels

TPS-12L Isys® 12" Wall Mount Touchpanel (continued)

Connectors

QM IN: (1) 8-wire RJ45 female, QuickMedia input port
Signal Types: Auto-detecting component (YPbPr), S-Video (Y/C), or composite video with stereo program audio and (2) mic channels;
Video Formats: NTSC 480i or PAL 576i
Connects to QM output port of a QM-TX or other QuickMedia device via CresCAT-QM or CresCAT-IM cable;
Maximum Cable Length: 300 ft (aggregate distance from QM origination)

VIDEO IN: (1) 8-wire RJ45 female, CAT5 balanced video input port
Signal Types: Auto-detecting component (YPbPr), S-Video (Y/C), or composite;
Formats: NTSC 480i or PAL 576i
Input Impedance: 100 ohms balanced
Connects to any Crestron CAT5 balanced video source, or TPMC-CH-IMC interface module (included), via CresCAT cable or TPS/TPMC-CBL-T "triamese" cable (sold separately);
Maximum Cable Length: 500 feet for component, 750 feet for composite/S-Video

AUDIO I/O: (1) 8-wire RJ45 female
Bidirectional CAT5 balanced audio port
Signal Type: Receives (1) balanced stereo audio signal, and transmits (1) balanced stereo audio signal from internal microphone;
Maximum Input Level: 4 V_{RMS}
Maximum Output Level: 2 V_{RMS}
Input/Output Impedance: 600 ohms
Connects to any other Crestron CAT5 balanced audio port, or TPMC-CH-IMC interface module (included), via CresCAT cable or TPS/TPMC-CBL-T "triamese" cable (sold separately);
Maximum Cable Length: 1000 feet

HEADPHONES: (1) 3.5 mm TRS mini phone jack
Output Power: 12mW per channel
Minimum Impedance: 32 ohms

USB: (1) USB Type B female (reserved for future applications)

NET: (1) 4-pin 3.5mm detachable terminal block, Cresnet Slave port
Connects to Cresnet control network, or TPMC-CH-IMC interface module (included) via CresCAT, Cresnet, or TPS/TPMC-CBL-T "triamese" cable (sold separately)

LAN: (1) 8-wire RJ45 with 2 LED indicators
10BaseT/100BaseTX Ethernet port
Green LED indicates link status
Yellow LED indicates Ethernet activity

RS-232: (1) 6-pin RJ11 female
Computer console, touch output or mouse input port
Bidirectional RS-232 up to 115.2k baud
Hardware and software handshaking support

G: (1) 6-32 screw, chassis ground lug

MEMORY EXPANSION: (1) Type II Compact Flash card slot for memory expansion

Power Requirements

Cresnet Power Usage: 43 Watts (1.8 Amps @ 24 Volts DC)

Environmental

Temperature: 41° to 113°F (5° to 45°C)

Humidity: 10% to 90% RH (non-condensing)

Enclosure

Construction: Metal, flush mountable, 8U 19" rack-mountable (all mounting kits sold separately)

Front Bezel: Injection-molded plastic; black w/silver or white w/gray accent

Dimensions

Height: 11.80 in (29.98 cm)

Width: 13.61 in (34.57 cm)

Depth: 3.80 in (9.66 cm)

Weight

8.5 lbs (3.86 kg)

INCLUDED ACCESSORIES

TPMC-CH-IMC

CAT5 Balanced AV Interface Module

(See TPMC-CH-IMC specifications for complete information)

TPS-12L using QuickMedia

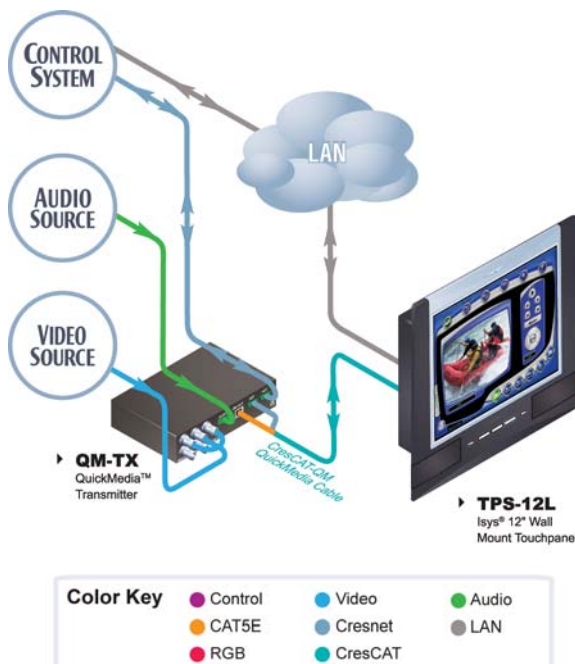

ISYS® WALL MOUNT TOUCHPANELS

► Isys® Wall Mount Touchpanels

Isys® 12" Wall Mount Touchpanel **TPS-12L**

TPS-12L in a CAT5 AV Distribution System

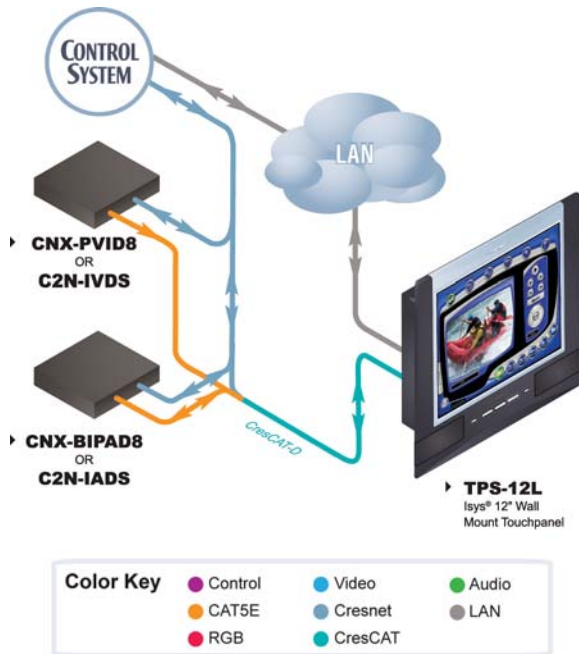

Wall mount touchpanels

AVAILABLE ACCESSORIES

- ▶ **BB-12L**
Pre-Construction Wall Mount Back Box
- ▶ **PMK-12L**
Pre-Construction Wall Mount Kit
- ▶ **TMK-12L**
Trim Ring
- ▶ **MMK-12L**
Mud Ring
- ▶ **WMKT-12L**
Lectern Mount Kit with Trim Ring
- ▶ **WMKM-12L**
Post-Construction Wall Mount Kit with Mud Ring
- ▶ **RMK-12L**
Rack Mount Kit
- ▶ **TPMC-CH-IMW**
CAT5 Balanced AV Interface Wall Plate
- ▶ **TPS/TPMC-CBL-T**
Triamese Interface Cables
- ▶ **QM-TX**
QuickMedia Transmitter
- ▶ **ST-PK**
Programming Cable Kit
- ▶ **CresCAT®D**
Crestron Home® CAT5 Balanced AV Cable
- ▶ **CresCAT®QM**
QuickMedia™ Cable
- ▶ **CresCAT®IM**
iMedia Cable

ISYS® WALL MOUNT TOUCHPANELS

→ Isys® Wall Mount Touchpanels

TPS-4000L Isys® 10.4" Wall Mount Touchpanel

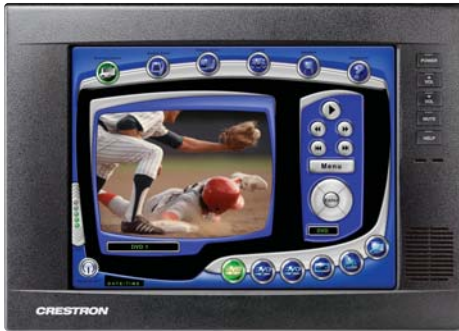

The Isys TPS-4000L presents a state-of-the-art flush mount touchpanel solution complete with integrated video and audio. A vibrant 640 x 480 10.4" touchscreen display delivers astounding graphical performance to support a host of control applications. The addition of 5 programmable hardbuttons provides quick pushbutton access to commonly used functions.

Crestron touchpanels offer an ideal user-interface for multimedia presentation, videoconferencing, lighting, climate control, and much more, providing a wide-open canvas for the creation of custom control screens perfectly tailored to the needs of the end-user. Touchpanels do away with piles of remote controls, cryptic front panels, and cluttered wall switches, affording true "one-touch" control over a broad range of complex devices and systems.

Isys®—Isys power and beauty are infused throughout Crestron's entire touchpanel lineup. Under the hood, the Isys engine produces astonishing full-color graphics with lightning-fast performance and incredible versatility. A 32-bit Freescale ColdFire® Microprocessor combines with an ingenious and ultra efficient operating system to support high-resolution graphics and images, dynamic text, full-motion video, animations, multimode objects (buttons, frames, gauges, and sliders), popup/drop down subpages, and more.

Synapse™—Crestron's exclusive Synapse Image Rendering Algorithm enables system programmers to produce amazing graphics - faster and easier. Advanced antialiasing delivers crisper, sharper objects and text. Enhanced 3D effects add new depth and style. And because Synapse is native to the touchpanel, memory requirements and upload time are substantially reduced.

Video with Advanced Gamma Correction—Video capability is standard in the TPS-4000L, accepting any NTSC/PAL composite or S-Video source, scalable for display in any sized window or full screen. Advanced gamma correction and built-in time base correction ensure accurate color reproduction and a jitter-free image.

Tactile Pushbuttons—Five programmable "hard" buttons are included to provide quick pushbutton access to commonly used functions. Individual button caps are custom engravable for easy operation at a glance.

Built-in Audio—Audio features include built-in amplified speakers, volume control, line-level stereo input, and a microphone with automatic gain control and line-level output. The speakers may be used to amplify signals from TV and video sources, or to support programmable intercom functionality in combination with the microphone. Customized WAV files can be loaded on the touchpanel to add dimension to the touchscreen graphics and pushbuttons with personalized sounds, button feedback, and voice prompts.

Cresnet®—Cresnet communication ensures compatibility with Crestron's complete product line.

Versatile Flush-Mount Design—The TPS-4000L is designed for easy flush-mount installation in a wall, lectern or similar flat surface. A variety of mounting accessories is offered including optional back box and 19" rack mount kit. A light sensor is built in to automatically adjust the display brightness for optimal visibility under varying light conditions.

- ▶ 10.4" active matrix touchscreen display
- ▶ Isys graphics engine | 640 x 480 resolution
- ▶ Synapse Image Rendering Algorithm
- ▶ High-performance video with gamma correction
- ▶ Built-in amplified speakers and microphone
- ▶ 5 engravable hardbuttons | Built-in light sensor
- ▶ Stylish flush mount design | Optional rack mount
- ▶ Cresnet communications

AVAILABLE MODELS

TPS-4000LA

Isys 10.4" Wall Mount Touchpanel, Almond

TPS-4000LB

Isys 10.4" Wall Mount Touchpanel, Black

TPS-4000LW

Isys 10.4" Wall Mount Touchpanel, White

ISYS® WALL MOUNT TOUCHPANELS

→ Isys® Wall Mount Touchpanels

Isys® 10.4" Wall Mount Touchpanel **TPS-4000L**

SPECIFICATIONS

Touchscreen Display

Display Type: TFT Active matrix color LCD
Size: 10.4 inch (26.4 cm) diagonal
Aspect Ratio: 4:3 VGA
Resolution: 640 x 480 pixels
Brightness: 450 nits (cd/m²)
Contrast: 600:1
Color Depth: 18-bit, 256k colors
Illumination: Edgelit fluorescent
Viewing Angle: ±70° horizontal, +45°/-55° vertical
Touchscreen: Resistive membrane

Buttons

(5) Replaceable engravable buttons with red feedback LEDs, programmable

Light Sensor

Programmable photosensor for automatic backlight dimming

Processor

CPU: 32-bit Freescale ColdFire® Microprocessor

Memory

DRAM: 8 MB
Flash: 8 MB
Maximum Project Size: 7 MB

Graphic Engine

Isys engine, 16-bit non-palette graphics; 65,536 colors; Synapse image rendering algorithm; multi-mode objects, color key video windowing

Video

Signal Types: Auto-detecting composite/S-Video
Formats: NTSC 480i or PAL 576i
Color Depth: 18-bit; 262,144 colors
Features: Single-window scalable to full-screen, time base correction, gamma correction

Audio

Hardware Features: Built-in microphone with defeatable AGC, built-in amplified speakers, internal volume control and audio mixer
Audio Feedback (WAV): 8-bit PCM, mono, 8 kHz sampling rate
Amplification: 5 Watts X2 channels for built-in speakers (mono)

Connectors

RS-232: (1) 6-pin RJ11 female
Serial connection to PC for loading screen files
Touchscreen output to PC or Telestrator
Bidirectional RS-232 up to 115.2k baud
Hardware and software handshaking support

NET: (1) 4-pin 3.5mm detachable terminal block
Connects to Cresnet control network

MIC OUT: (1) 3-pin 3.5mm detachable terminal block
Balanced/unbalanced stereo line-level output
Output Impedance: 600 ohms balanced, 300 ohms unbalanced
Maximum Output Level: 2 V_{RMS} balanced, 1 V_{RMS} unbalanced

AUDIO INPUT: (1) 6-pin 3.5mm detachable terminal block
Balanced/unbalanced stereo line-level input
Input Impedance: 20k ohms balanced, 10k ohms unbalanced
Maximum Input Level: 4 V_{RMS} balanced, 2 V_{RMS} unbalanced

NTSC/PAL INPUT (Balanced): (1) 6-pin 3.5mm detachable terminal block, composite or S-Video input, balanced
Input Impedance: 100 ohms
Connects to any Crestron CAT5 balanced video source

NTSC/PAL INPUT (Coaxial): (2) 2-pin 3.5mm detachable terminal blocks, composite or S-Video input
Input Impedance: 75 ohms

Power Requirements

Cresnet Power Usage: 22 Watts (0.92 Amp @ 24 Volts DC)

TPS-4000L using conventional AV sources

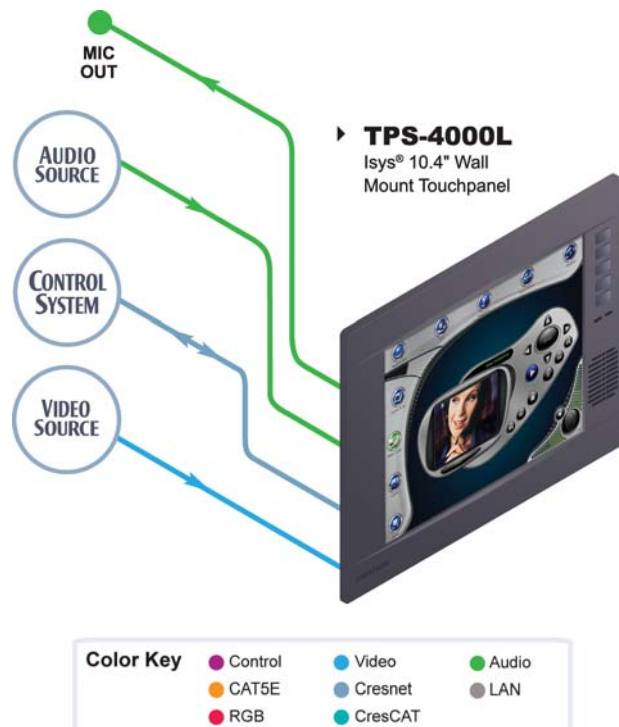

wall mount touchpanels

> continued

ISYS® WALL MOUNT TOUCHPANELS

► Isys® Wall Mount Touchpanels

TPS-4000L Isys® 10.4" Wall Mount Touchpanel (continued)

Environmental

Temperature: 50° to 113°F (10° to 45°C)
Humidity: 10% to 90% RH (non-condensing)

Enclosure

Construction: Black metal, flush mountable, 6U 19" rack-mountable (rack kit sold separately)
Faceplate: Injection-molded plastic; white, black, or almond

Dimensions

Height: 8.56 in (21.74 cm)
Width: 11.97 in (30.40 cm)
Depth: 2.99 in (7.60 cm)

Weight

4.6 lbs (2.1 kg)

TPS-4000L in a CAT5 AV Distribution System

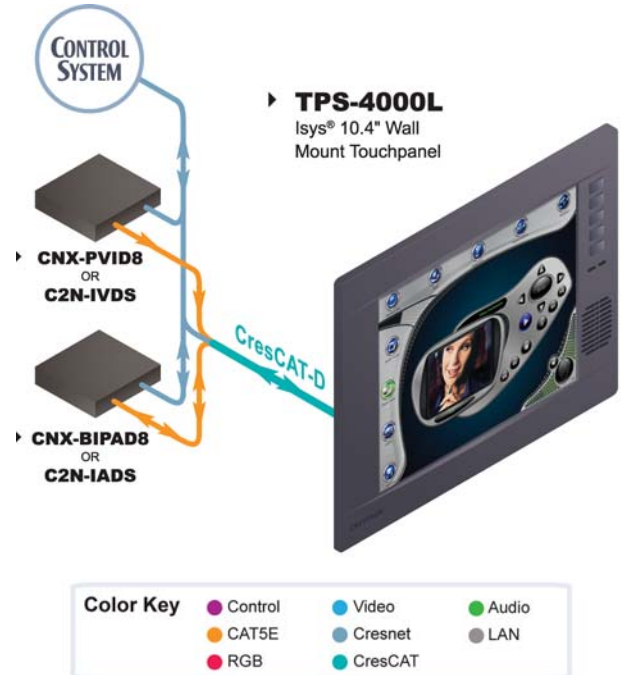

wall mount touchpanels

AVAILABLE ACCESSORIES

- | | | | |
|--|--|---|--|
| ► 3100L/4000L-BTN
Engravable Button Cap | ► PMK-4000L
Pre-construction
Wall Mount Kit | ► WMKT-4000L
Lectern or Post-construction
Wall Mount Kit w/Trim Ring | ► ST-PK
Programming Cable Kit |
| ► TPS-FPAR4000L
Architectural Faceplates | ► TMK-4000L
Trim Ring | ► WMKM-4000L
Post-construction Wall
Mount Kit w/Mud Ring | ► CresCAT®D
Crestron Home® CAT5
Balanced AV Cable |
| ► BB-4000L
Wall Mount Back Box | ► MMK-4000L
Mud Ring | ► RMK-4000L
Rack Mount Kit | |

ISYS® WALL MOUNT TOUCHPANELS

→ Isys® Wall Mount Touchpanels

Isys® 6.4" Wall Mount Touchpanel **TPS-3100L**

The Isys TPS-3100L presents a state-of-the-art flush mount touchpanel solution complete with integrated video and audio. A vibrant 640 x 480 6.4" touchscreen display delivers astounding graphical performance to support a host of control applications. The addition of 5 programmable hardbuttons provides quick pushbutton access to commonly used functions.

Crestron touchpanels offer an ideal user-interface for multimedia presentation, videoconferencing, lighting, climate control, and much more, providing a wide-open canvas for the creation of custom control screens perfectly tailored to the needs of the end-user. Touchpanels do away with piles of remote controls, cryptic front panels, and cluttered wall switches, affording true "one-touch" control over a broad range of complex devices and systems.

Isys®—Isys power and beauty are infused throughout Crestron's entire touchpanel lineup. Under the hood, the Isys engine produces astonishing full-color graphics with lightning-fast performance and incredible versatility. A 32-bit Freescale ColdFire® Microprocessor combines with an ingenious and ultra efficient operating system to support high-resolution graphics and images, dynamic text, full-motion video, animations, multimode objects (buttons, frames, gauges, and sliders), popup/dropdown subpages, and more.

Synapse™—Crestron's exclusive Synapse Image Rendering Algorithm enables system programmers to produce amazing graphics - faster and easier. Advanced antialiasing delivers crisper, sharper objects and text. Enhanced 3D effects add new depth and style. And because Synapse is native to the touchpanel, memory requirements and upload time are substantially reduced.

Video with Advanced Gamma Correction—Video capability is standard in the TPS-3100L, accepting any NTSC/PAL composite or S-Video source, scalable for display in any sized window or full screen. Advanced gamma correction and built-in time base correction ensure accurate color reproduction and a jitter-free image.

Tactile Pushbuttons—Five programmable "hard" buttons are included to provide quick pushbutton access to commonly used functions. Individual button caps are custom engravable for easy operation at a glance.

Built-in Audio—Audio features include built-in amplified speakers, volume control, line-level stereo input, and a microphone with automatic gain control and line-level output. The speakers may be used to amplify signals from TV and video sources, or to support programmable



intercom functionality in combination with the microphone. Customized WAV files can be loaded on the touchpanel to add dimension to the touchscreen graphics and pushbuttons with personalized sounds, button feedback, and voice prompts.

Cresnet®—Cresnet communication ensures compatibility with Crestron's complete product line.

Versatile Flush-Mount Design—The TPS-3100L is designed for easy flush-mount installation in a wall, lectern or similar flat surface. A variety of mounting accessories is offered including optional back box and 19" rack mount kit. A light sensor is built in to automatically adjust the display brightness for optimal visibility under varying light conditions.

- ▶ 6.4" active matrix touchscreen display
- ▶ Isys graphics engine | 640 x 480 resolution
- ▶ Synapse Image Rendering Algorithm
- ▶ High-performance video with gamma correction
- ▶ Built-in amplified speakers and microphone
- ▶ 5 engravable hardbuttons | Built-in light sensor
- ▶ Stylish flush mount design | Optional rack mount
- ▶ Cresnet communications

AVAILABLE MODELS

TPS-3100LA

Isys 6.4" Wall Mount Touchpanel, Almond

TPS-3100LB

Isys 6.4" Wall Mount Touchpanel, Black

TPS-3100LW

Isys 6.4" Wall Mount Touchpanel, White

> continued

ISYS® WALL MOUNT TOUCHPANELS

→ Isys® Wall Mount Touchpanels

TPS-3100L Isys® 6.4" Wall Mount Touchpanel (continued)

SPECIFICATIONS

Touchscreen Display

Display Type: TFT Active matrix color LCD
Size: 6.4 inch (16.3 cm) diagonal
Aspect Ratio: 4:3 VGA
Resolution: 640 x 480 pixels
Brightness: 400 nits (cd/m²)
Contrast: 250:1
Color Depth: 18-bit, 256k colors
Illumination: Edgelit fluorescent
Viewing Angle: ±60° horizontal, +40°/-55° vertical
Touchscreen: Resistive membrane

Buttons

(5) Replaceable engravable buttons with red feedback LEDs, programmable

Light Sensor

Programmable photosensor for automatic backlight dimming

Processor

CPU: 32-bit Freescale ColdFire® Microprocessor

Memory

DRAM: 8 MB
Flash: 8 MB
Maximum Project Size: 7 MB

Graphic Engine

Isys engine, 16-bit non-palette graphics; 65,536 colors; Synapse image rendering algorithm; multi-mode objects, color key video windowing

Video

Signal Types: Auto-detecting composite/S-Video
Formats: NTSC 480i or PAL 576i
Color Depth: 18-bit; 262,144 colors
Features: Single-window scalable to full-screen, time base correction, gamma correction

Audio

Hardware Features: Built-in microphone with defeatable AGC, built-in amplified speakers, internal volume control and audio mixer
Audio Feedback (WAV): 8-bit PCM, mono, 8 kHz sampling rate
Amplification: 5 Watts X2 channels for built-in speakers (mono)

Connectors

RS-232: (1) 6-pin RJ11 female
 Serial connection to PC for loading screen files
 Touchscreen output to PC or Telestrator
 Bidirectional RS-232 up to 115.2k baud
 Hardware and software handshaking support

NET: (1) 4-pin 3.5mm detachable terminal block
 Connects to Cresnet control network

MIC OUT: (1) 3-pin 3.5mm detachable terminal block
 Balanced/unbalanced stereo line-level output
 Output Impedance: 600 ohms balanced, 300 ohms unbalanced
 Maximum Output Level: 2 V_{RMS} balanced, 1 V_{RMS} unbalanced

AUDIO INPUT: (1) 6-pin 3.5mm detachable terminal block
 Balanced/unbalanced stereo line-level input
 Input Impedance: 20k ohms balanced, 10k ohms unbalanced
 Maximum Input Level: 4 V_{RMS} balanced, 2 V_{RMS} unbalanced

NTSC/PAL INPUT (Balanced): (1) 6-pin 3.5mm detachable terminal block, composite or S-Video input, balanced;
 Input Impedance: 100 ohms
 Connects to any Crestron CAT5 balanced video source

NTSC/PAL INPUT (Coaxial): (2) 2-pin 3.5mm detachable terminal blocks, composite or S-Video input;
 Input Impedance: 75 ohms

wall mount touchpanels

TPS-3100L using conventional AV sources

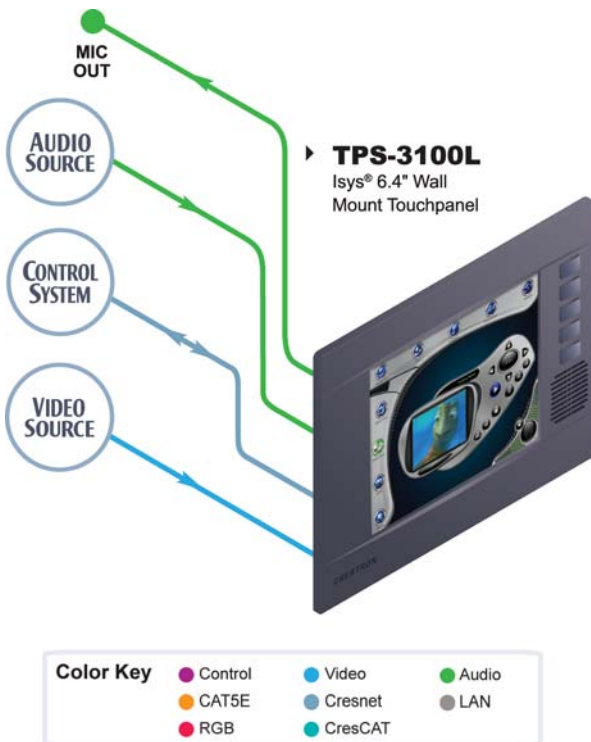

ISYS® WALL MOUNT TOUCHPANELS

→ Isys® Wall Mount Touchpanels

Isys® 6.4" Wall Mount Touchpanel **TPS-3100L**

Power Requirements

Cresnet Power Usage: 20 Watts (0.84 Amp @ 24 Volts DC)

Environmental

Temperature: 50° to 113°F (10° to 45°C)

Humidity: 10% to 90% RH (non-condensing)

Enclosure

Construction: Black metal, flush mountable, 5U 19" rack-mountable (rack kit sold separately)

Faceplate: Injection-molded plastic; white, black, or almond

Dimensions

Height: 6.06 in (15.39 cm)

Width: 8.57 in (21.77 cm)

Depth: 2.99 in (7.60 cm)

Weight

2.8 lbs (1.3 kg)

TPS-3100L in a CAT5 AV Distribution System

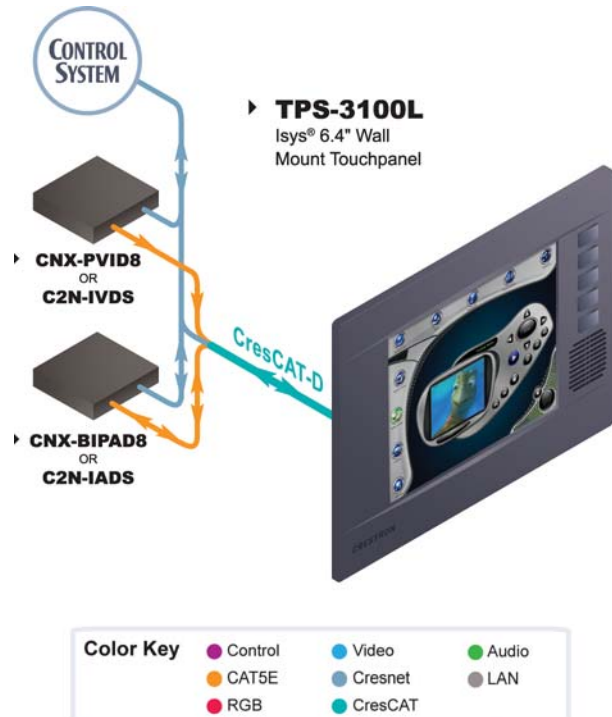

Wall mount touchpanels

AVAILABLE ACCESSORIES

- | | | | |
|--|--|---|--|
| ▶ 3100L/4000L-BTN
Engravable Button Cap | ▶ PMK-3100L
Pre-construction
Wall Mount Kit | ▶ WMKT-3100L
Lectern or Post-construction
Wall Mount Kit w/Trim Ring | ▶ ST-PK
Programming Cable Kit |
| ▶ TPS-FPAR3100L
Architectural Faceplates | ▶ TMK-3100L
Trim Ring | ▶ WMKM-3100L
Post-construction Wall
Mount Kit w/Mud Ring | ▶ CresCAT®D
Crestron Home® CAT5
Balanced AV Cable |
| ▶ BB-3100L
Wall Mount Back Box | ▶ MMK-3100L
Mud Ring | ▶ RMK-3100L
Rack Mount Kit | |

ISYS® WALL MOUNT TOUCHPANELS

→ Isys® Wall Mount Touchpanels

TPS-2000L Isys® 5" Wall Mount Touchpanel



crisper, sharper objects and text. Enhanced 3D effects add new depth and style. And because Synapse is native to the touchpanel, memory requirements and upload time are substantially reduced.

Video with 2:1 Virtual Pan/Zoom—A full motion video input provides an exceptional utility for viewing security cameras and other video sources on the touchscreen display. The ingenious virtual pan/tilt function with 2:1 digital zoom achieves "motorized pan/tilt" behavior, even from fixed-position cameras. Simply dragging a fingertip across the screen lets the user zero in on any subject for the best view. The video image is also scalable for display in any sized window or full screen. Advanced gamma correction and built-in time base correction ensure accurate color reproduction and a jitter-free image.

Tactile Pushbuttons—Ten programmable "hard" buttons are included to provide quick pushbutton access to commonly used functions. Individual button caps are custom engravable for easy operation at a glance.

Built-in Audio—Audio features include built-in amplified speakers, volume control, line-level input, and a microphone with automatic gain control and line-level output. The speakers and microphone are ideal to support programmable intercom or baby-monitor capability. Customized WAV files can be loaded on the touchpanel to add dimension to the touchscreen graphics and pushbuttons with personalized sounds, button feedback, and voice prompts.

Cresnet®—Cresnet communication ensures compatibility with Crestron's complete product line.

Versatile Flush-Mount Design—The TPS-2000L features an eye-pleasing flush-mount design furnished standard with white faceplate and buttons. Optional Designer faceplates are offered in a variety of elegant metallic finishes with engravable buttons to complement any decor. Numerous versatile mounting options are available to facilitate a clean installation in any wall or similar flat surface. To accommodate a range of mounting heights, the display image may be inverted to attain an optimum viewing angle. A light sensor is also built in to automatically adjust the display brightness for optimal visibility under varying light conditions.

The TPS-2000L provides Isys style and performance in a compact wall mount design. Featuring a vivid 5" active matrix color touchscreen plus 10 engravable pushbuttons and integrated video and audio, the TPS-2000L puts a world of control capability in the space of a common light switch.

Crestron touchpanels offer an ideal user-interface for controlling everything from audio distribution to complete home automation, providing a wide-open canvas for the creation of custom control screens perfectly tailored to the needs of the end-user. Touchpanels do away with piles of remote controls, cryptic front panels, and cluttered wall switches, affording true "one-touch" control over a broad range of complex devices and systems.

Isys®—Isys power and beauty are infused throughout Crestron's entire touchpanel lineup. Under the hood, the Isys engine produces astonishing full-color graphics with lightning-fast performance and incredible versatility. A 32-bit Freescale ColdFire® Microprocessor combines with an ingenious and ultra efficient operating system to support high-resolution graphics and images, dynamic text, full-motion video, animations, multimode objects (buttons, frames, gauges, and sliders), popup/dropdown subpages, and more.

Synapse™—Crestron's exclusive Synapse Image Rendering Algorithm enables system programmers to produce amazing graphics - faster and easier. Advanced antialiasing delivers

ISYS® WALL MOUNT TOUCHPANELS

→ Isys® Wall Mount Touchpanels

Isys® 5" Wall Mount Touchpanel **TPS-2000L**

- ▶ 5" active matrix touchscreen display
- ▶ Isys graphics engine | 320 x 234 resolution
- ▶ Synapse Image Rendering Algorithm
- ▶ Integrated video with 2:1 virtual pan/zoom
- ▶ Built-in amplified speakers and microphone
- ▶ 10 engravable hardbuttons | Built-in light sensor
- ▶ Cresnet communications
- ▶ Stylish flush mount design

SPECIFICATIONS

Touchscreen Display

Display Type: TFT Active matrix color LCD
Size: 5 inch (12.7 cm) diagonal
Resolution: 320 x 234 pixels
Color Depth: 16-bit, 64k colors
Illumination: Edgellit fluorescent
Viewing Angle: ±65° horizontal, +40°/-65° vertical (invertible)
Touchscreen: Resistive membrane

TPS-2000L using conventional AV sources



Buttons

(10) Replaceable engravable buttons, programmable

Light Sensor

Programmable photosensor for automatic backlight dimming

Processor

CPU: 32-bit Freescale ColdFire® Microprocessor

Memory

DRAM: 8 MB

Flash: 2 MB

Maximum Project Size: 1.5 MB

Graphic Engine

Isys engine, 16-bit non-palette graphics; 65,536 colors; Synapse image rendering algorithm; multi-mode objects, color key video windowing

Video

Signal Types: Composite

Formats: NTSC 480i or PAL 576i

Color Depth: 16-bit; 65,536 colors

Features: Single-window scalable to full-screen, time base correction, gamma correction, 2:1 virtual pan/zoom

Audio

Hardware Features: Built-in microphone with defeatable AGC, built-in amplified speakers, internal volume control and audio mixer
Audio Feedback (WAV): 8-bit PCM, mono, 8 kHz sampling rate, ~3 minutes capacity

Amplification: 2 Watts for built-in speakers (mono)

Connectors

NET: (1) 4-pin 3.5mm detachable terminal block
Connects to Cresnet control network

AUDIO/VIDEO: (1) 8-pin 3.5mm detachable terminal block;
Comprises:

MIC OUT: (1) Balanced/unbalanced mono line-level output
Output Impedance: 600 ohms balanced, 300 ohms unbalanced
Maximum Output Level: 2 V_{RMS} balanced, 1 V_{RMS} unbalanced

AUDIO IN: (1) Balanced/unbalanced mono line-level input
Input Impedance: 20k ohms balanced, 10k ohms unbalanced
Maximum Input Level: 4 V_{RMS} balanced, 2 V_{RMS} unbalanced

VIDEO IN: (1) Composite video input, balanced
Input Impedance: 100 ohms (compatible with 75 ohm coaxial)
Input Level: 1 V_{P-P}
Connects to any Crestron CAT5 balanced or coaxial video source

> continued

ISYS® WALL MOUNT TOUCHPANELS

→ Isys® Wall Mount Touchpanels

TPS-2000L Isys® 5" Wall Mount Touchpanel (continued)

Power Requirements

Cresnet Power Usage: 16 Watts (0.67 Amp @ 24 Volts DC)

Environmental

Temperature: 50° to 113°F (10° to 45°C)

Humidity: 10% to 90% RH (non-condensing)

Enclosure

Construction: Injection-molded plastic, white, flush mountable (wall/lectern mounting kits sold separately)

Faceplate: Injection-molded plastic, white (optional colors and finishes available)

Dimensions

Height: 4.77 in (12.10 cm)

Width: 6.73 in (17.10 cm)

Depth: 3.43 in (8.71 cm)

Weight

1.41 lbs (0.64 kg)

TPS-2000L in a CAT5 AV Distribution System

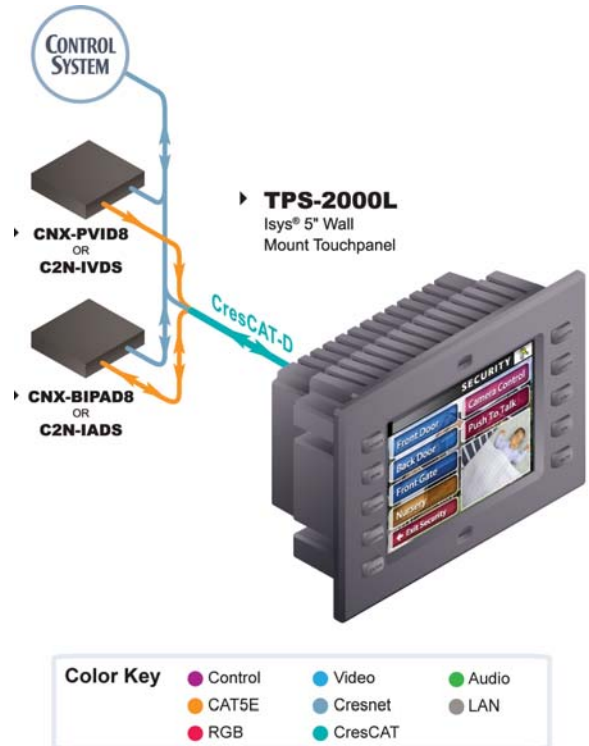

AVAILABLE ACCESSORIES

- | | | | |
|---|---|--|---|
| ▶ 1000/2000-BTN
Engravable Button Cap | ▶ BB-2000L
Wall Mount Back Box | ▶ MMK-2000L
Mud Ring | ▶ TPS-WPK
Water Resistant Cover Kit |
| ▶ TPS-FP
Designer and Standard Faceplates | ▶ PMK-2000L
Pre-construction Wall Mount Kit | ▶ WMKT-2000L
Lectern or Post-construction Wall Mount Kit w/Trim Ring | ▶ CresCAT®D
Crestron Home® CAT5 Balanced AV Cable |
| ▶ TPS-FPAR2000L
Architectural Faceplates | ▶ TMK-2000L
Trim Ring | ▶ WMKM-2000L
Post-construction Wall Mount Kit w/Mud Ring | |

ISYS® WALL MOUNT TOUCHPANELS

→ Isys® Wall Mount Touchpanels

Isys® 3.6" Wall Mount Touchpanel **TPS-4L**

The TPS-4L compact wall mount touchpanel delivers amazing touchpanel performance at an incredibly low cost. In the space of a common light switch, the TPS-4L packs a bright, high-contrast 3.6" active matrix color touchscreen with astonishing 16-bit Isys color graphics and 10 backlit pushbuttons.

Crestron touchpanels offer an ideal user-interface for controlling everything from audio distribution to complete home automation, providing a wide-open canvas for the creation of custom control screens perfectly tailored to the needs of the end-user. Touchpanels do away with piles of remote controls, cryptic front panels, and cluttered wall switches, affording true "one-touch" control over a broad range of complex devices and systems.

Isys®—Isys power and beauty are infused throughout Crestron's entire touchpanel lineup. Under the hood, the TPS-4L offers vibrant 16-bit color depth to produce eye-catching graphics and high-res images. The Isys engine supports dynamic graphics and text, full-motion animations, multimode objects, and PNG translucency - all with astonishing speed.

Synapse™—Crestron's exclusive Synapse Image Rendering Algorithm enables system programmers to produce amazing graphics - faster and easier. Advanced antialiasing delivers crisper, sharper objects and text. Enhanced 3D effects add new depth and style. And because Synapse is native to the touchpanel, memory requirements and upload time are substantially reduced.

Tactile Pushbuttons—Ten programmable "hard" buttons are included for quick pushbutton access to commonly used functions. Translucent white backlit buttons and a custom engravable faceplate simplify operation while providing an alluring appearance.

Audio Feedback—Customized WAV files can be loaded on the touchpanel to add dimension to the touchscreen graphics and pushbuttons with personalized sounds, button feedback, and voice prompts.

High-Speed Connectivity—Both Cresnet and high-speed Ethernet are standard on the TPS-4L, providing for easy network integration and seamless communications with Crestron control systems.

Versatile Flush-Mount Design—The TPS-4L is designed for easy flush-mount installation in a wall, lectern or similar flat surface. Mounting clips furnished with the TPS-4L facilitate a clean installation in post-construction drywall and many furniture applications. Additional mounting options are available.



10 Designer Colors—Optional faceplates are available in a choice of 10 designer colors to match any décor. Faceplates may be ordered with or without custom engraving.

- ▶ 3.6" active matrix color touchscreen display
- ▶ 16-bit Isys graphics | 320 x 240 resolution
- ▶ Synapse Image Rendering Algorithm
- ▶ 10 white backlit pushbuttons and engravable faceplate
- ▶ WAV file audio feedback
- ▶ Ethernet and Cresnet communications
- ▶ Stylish flush wall mount design | 10 designer colors

AVAILABLE MODELS

TPS-4LA

Isys 3.6" Wall Mount Touchpanel, Almond

TPS-4LB

Isys 3.6" Wall Mount Touchpanel, Black

TPS-4LW

Isys 3.6" Wall Mount Touchpanel, White

SPECIFICATIONS

Touchscreen Display

Display Type: TFT Active matrix color LCD

Size: 3.6 inch (9.1 cm) diagonal

Aspect Ratio: 4:3 QVGA

Resolution: 320 x 240 pixels

Brightness: 300 nits (cd/m²)

Contrast: 300:1

Color Depth: 16-bit, 64k colors

Illumination: Edgelit LED

Viewing Angle: ±80° horizontal, +80°/-50° vertical

Touchscreen: Resistive membrane

Buttons

Functions: (10) Translucent white backlit pushbuttons, programmable

Reset: (1) Miniature pushbutton behind faceplate, used to reset the touchpanel

> continued

ISYS® WALL MOUNT TOUCHPANELS

→ Isys® Wall Mount Touchpanels

TPS-4L Isys® 3.6" Wall Mount Touchpanel (continued)

Processor

CPU: 32-bit Freescale ColdFire® Microprocessor

Memory

DRAM: 16 MB

Flash: 8 MB

Maximum Project Size: 7 MB

Graphic Engine

Isys engine; 16-bit non-palette graphics; 65,536 colors; Synapse image rendering algorithm; multi-mode objects, dynamic graphics, PNG translucency, full-motion (60 fps) animation, transition effects

Ethernet

10BaseT/100BaseTX, auto-switching, auto-negotiating, full/half duplex, TCP/IP, UDP/IP, CIP, IEEE 802.3U compliant

Audio

Hardware Features: Built-in amplified speaker (rear), internal volume control

Audio Feedback (WAV): 8-bit PCM, mono, 8 kHz sampling rate

Amplification: 1 Watt for built-in speaker

Connectors

NET: (1) 4-pin 3.5mm detachable terminal block, Cresnet slave port
Connects to Cresnet control network

LAN: (1) 8-wire RJ45 with 2 LED indicators

10/100BaseT Ethernet port

Green LED indicates link status

Yellow LED indicates Ethernet activity

Power Requirements

Cresnet Power Usage: 5 Watts (0.21 Amp @ 24 Volts DC)

Environmental

Temperature: 41° to 104°F (5° to 40°C)

Humidity: 10% to 90% RH (non-condensing)

Enclosure

Construction: Injection-molded plastic, flush-mountable using clips provided (additional mounting kits available)

Faceplate: Injection-molded plastic

Dimensions

Height: 4.54 in (11.52 cm)

Width: 6.19 in (15.73 cm)

Depth: 2.13 in (5.40 cm)

Weight

15.0 oz (0.43 kg)

wall mount touchpanels

TPS-4L in a Typical Application

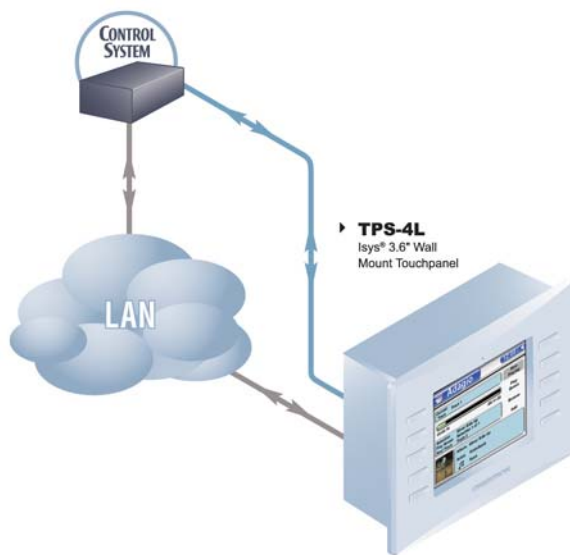

Color Key					
●	Control	●	Video	●	Audio
●	CAT5E	●	Cresnet	●	LAN
●	RGB	●	CresCAT		

AVAILABLE ACCESSORIES

- | | | | |
|---|------------------------------|---|--|
| ▶ TPS/TPMC-4L-FP
Engravable Faceplate –
10 designer colors | ▶ TMK-4L
Trim Ring | ▶ WMKT-4L
Lectern or Post-Construction
Wall Mount Kit with Trim Ring | ▶ WMKB-4L
Replacement Wall Mount Clips |
| ▶ BB-4L
Pre-Construction Wall
Mount Back Box | ▶ MMK-4L
Mud Ring | ▶ WMKM-4L
Post-Construction Wall
Mount Kit with Mud Ring | ▶ Cresnet®
Control Cable |
| ▶ PMK-4L
Pre-Construction Wall Mount Kit | | | |

ISYS® WALL MOUNT TOUCHPANELS

→ Isys® G-Series Wall Mount Touchpanels

Isys® G-Series 15" Wall Mount Touchpanel w/QuickMedia™ **TPS-15G-QM-L**

Crestron's Isys G-Series touchpanels deliver a higher level of performance with dual-window video, RGB, and HDTV display to meet the demands of today's sophisticated control and automation applications. Incorporating modern styling in a versatile flush mount design, the Isys TPS-15G-QM-L features a spectacular 15" XGA display offering a wide viewing angle with exceptional brightness and contrast for stunning control graphics, high-resolution images, and full-motion HD video.

Crestron touchpanels offer an ideal user-interface for multimedia presentation, videoconferencing, home automation, and much more, providing a wide-open canvas for the creation of custom control screens tailored to the needs of the end-user. Touchpanels do away with piles of remote controls, cryptic control panels and cluttered wall switches, simultaneously expanding and simplifying control over a broad range of complex devices and systems.

Isys®—Isys power and beauty are infused throughout Crestron's entire touchpanel lineup. Under the hood, the TPS-15G-QM-L offers vibrant 24-bit color depth with 8-bit alpha channel transparency to produce incredible 3D graphics and high-res images. The Isys engine supports dynamic graphics and text, full-motion animations, multimode objects, and PNG translucency – all with astonishing speed.

Synapse™—Crestron's exclusive Synapse Image Rendering Algorithm enables system programmers to produce amazing graphics – faster and easier. Advanced antialiasing delivers crisper, sharper objects and text. Enhanced 3D effects add new depth and style. And because Synapse is native to the touchpanel, memory requirements and upload time are substantially reduced.

Dual-Window HD Video and RGB²—The TPS-15G-QM-L can simultaneously display two fully-scalable, full-motion video windows, each supporting standard video, HDTV, and high-resolution RGB signals from external AV and computer sources. Discrete video scalers with motion adaptive deinterlacing bring out the highest detail, minimizing visible scan lines and motion artifacts for a truly remarkable picture. Advanced gamma correction and built-in time base correction ensure accurate color reproduction and a jitter-free image.



Touch-the-PC—Crestron's exclusive "Touch-the-PC" technology allows real-time touchpanel navigation of any Windows PC through a direct high-speed serial connection.

Built-in Annotation—Built-in annotation capability allows presenters to write or draw over computer and video images on the touchscreen using a finger or stylus, and output the image live for audience display.

High-Quality Audio²—The high-powered biamplified speaker system provides amplification for external AV sources, and supports intercom functionality in combination with the integrated microphone. Customized WAV files can be loaded on the touchpanel to add dimension to the touchscreen graphics with personalized sounds, button feedback, and voice prompts.

QuickMedia™—All audio and video connections are facilitated using Crestron's revolutionary QuickMedia transport, providing a flexible yet remarkably simple wiring solution. Through QuickMedia (QM), the TPS-15G-QM-L interfaces directly with other QM-based products using inexpensive CAT5e type cable.

The two QM Input ports each support non-interlaced RGB up to 1600 X 1200 pixels, as well as composite, S-Video, and component video signals. QM Input #1 includes software-adjustable compensation for cable runs up to 450 feet; Input #2 allows up to 300 feet for video and HDTV, and shorter distances for RGB computer signals. Both QM Inputs receive audio signals from external microphone and stereo line level sources.

> continued

ISYS® WALL MOUNT TOUCHPANELS

→ Isys® G-Series Wall Mount Touchpanels

TPS-15G-QM-L Isys® G-Series 15" Wall Mount Touchpanel w/QuickMedia™ (continued)

The QM Output port allows RGB output of the touchpanel screen image to feed a display device for audience presentation. A 24-bit digital audio signal is also present for distribution of the internal microphone signal.

High-Speed Connectivity—Both Cresnet and high-speed Ethernet are standard on the TPS-15G-QM-L, providing for easy network integration and seamless communications with Crestron control systems. USB connectivity is also included for connection of an external mouse, touchscreen, or similar pointing device¹.

Versatile Flush Mount Design—The TPS-15G-QM-L is designed for easy flush-mount installation in a wall, lectern or similar flat surface. A variety of mounting accessories is offered including optional back box and 19" rack mount kit. Five backlit pushbuttons are also provided, allowing for quick access to commonly used functions.

- ▶ 15" active matrix touchscreen display | 1024 x 768 resolution
- ▶ 24-Bit Isys graphics | Synapse image rendering algorithm
- ▶ Dual-window full-motion video, HDTV and RGB display²
- ▶ Built-in bi-amplified speaker system and microphone²
- ▶ QuickMedia AV connectivity | audience presentation output²
- ▶ High-speed Ethernet and Cresnet communications
- ▶ Built-in real-time annotation
- ▶ Backlit "Softkey" pushbuttons
- ▶ Wall, lectern, and rack mounting options
- ▶ Available in black or white

AVAILABLE MODELS

TPS-15G-QM-LB

Isys G-Series 15" Wall Mount Touchpanel, Black

TPS-15G-QM-LW

Isys G-Series 15" Wall Mount Touchpanel, White

SPECIFICATIONS

Touchscreen Display

Display Type: TFT Active matrix color LCD

Size: 15 inch (38.1 cm) diagonal

Aspect Ratio: 4:3 XGA

Resolution: 1024 x 768 pixels

Brightness: 350 nits (cd/m²)

Contrast: 700:1

Color Depth: 24-bit, 16.7M colors

Illumination: Backlit fluorescent

Viewing Angle: ±85° horizontal, ±85° vertical

Touchscreen: Resistive membrane

Processor

CPU: 32-bit Freescale ColdFire® Microprocessor

Memory

DDR RAM: 128 MB

Flash: 64 MB

Compact Flash: Accepts up to 4GB Type II CF (not included)

Maximum Project Size: 160 MB

Graphic Engine

Isys engine, 24-bit non-palette graphics + 8-bit alpha channel transparency, 16.7 million colors, Synapse image rendering algorithm, multi-mode objects, dynamic graphics, PNG translucency, full-motion (60 fps) animation, transition effects, color key video windowing

Ethernet

10BaseT/100BaseTX, auto-switching, auto-negotiating, full/half duplex, TCP/IP, UDP/IP, CIP, IEEE 802.3U compliant

TPS-15G-QM-L using a single QuickMedia Transmitter

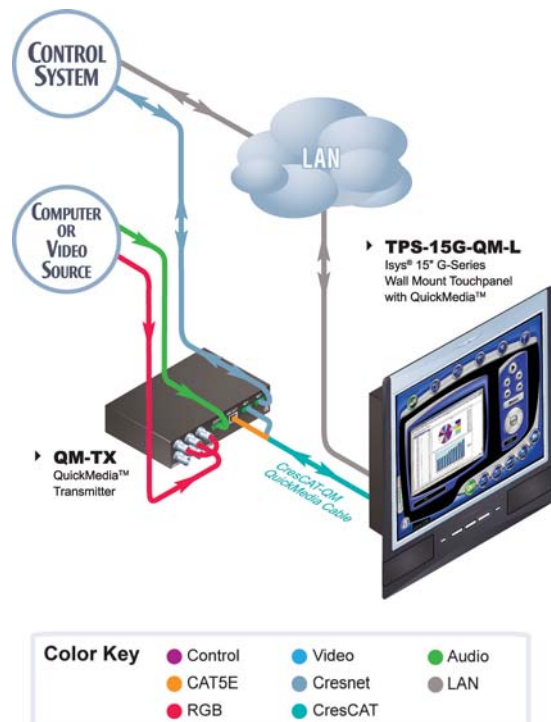

ISYS® WALL MOUNT TOUCHPANELS

→ Isys® G-Series Wall Mount Touchpanels

Isys® G-Series 15" Wall Mount Touchpanel w/QuickMedia™ **TPS-15G-QM-L**

Video/RGB²

Signal Types: RGB and auto-detecting composite, S-Video, or component video

Formats: SDTV 480i (NTSC) & 576i (PAL), EDTV 480p & 576p, HDTV 720p & 1080i; RGB(VGA) up to UXGA 1600 x 1200

Color Depth: 24-bit, 16.7M colors

Features: Dual-window each scalable to full-screen, time base correction, gamma correction, line doubling, motion adaptive deinterlacing, reverse 3:2/2:2 pulldown

Audio²

Hardware Features: Built-in microphone and biamplified speakers, stereo headphone output, internal volume control and audio mixer

Audio Feedback (WAV): 8-bit PCM, mono, 8 kHz sampling rate

D-A Conversion (QM): 24-bit, 48 kHz

Amplification: Bi-amplified, mono, 5 Watts for high-frequency, 5 Watts for low-frequency

Buttons

(4) Backlit "softkey" buttons, programmable

(1) Backlit hard reset button, reboots the touchpanel

Connectors

QM IN 1: (1) 8-wire RJ45 female, QuickMedia input port

Signal Types: Dynamically configurable under system control as:

(1) RGB input with stereo program audio and (2) mic channels, or

(1) Auto-detecting component (YPbPr), S-Video (Y/C), or composite video input with stereo program audio and (2) mic channels;

RGB Format: RGBHV

RGB Input Resolution, Non-interlaced: 640 x 480 minimum to 1600 x 1200 maximum (60 Hz limit at 1600 x 1200);

Video/HDTV Formats: 480i (NTSC), 576i (PAL), 480p, 576p, 720p and 1080i;

Horizontal Frequency: 15 to 100 kHz

Vertical Frequency: 50 to 85 Hz

Delay Skew Compensation: 0 - 22 nS

Connects to QM output port of a QM-TX or other QuickMedia device via CresCAT-QM or CresCAT-IM cable;

Maximum Cable Length: 450 ft (aggregate distance from QM origination)

QM IN 2: (1) 8-wire RJ45 female, QuickMedia input port

Signal Types: Dynamically configurable under system control as:

(1) RGB input with stereo program audio and (2) mic channels, or

(1) Auto-detecting component (YPbPr), S-Video (Y/C), or composite video input with stereo program audio and (2) mic channels;

RGB Format: RGBHV

RGB Input Resolution, Non-interlaced: 640 x 480 minimum to 1600 x 1200 maximum (60 Hz limit at 1600 x 1200);

Video/HDTV Formats: 480i (NTSC), 576i (PAL), 480p, 576p, 720p and 1080i;

Horizontal Frequency: 15 to 100 kHz

Vertical Frequency: 50 to 85 Hz

Delay Skew Compensation: none

Connects to QM output port of a QM-TX or other QuickMedia device via CresCAT-QM or CresCAT-IM cable;

Maximum Cable Length (Video/HDTV): 300 ft (aggregate distance from QM origination);

Maximum Cable Length (RGB @ 60Hz): 216 ft for 640x480, 140 ft for 800x600, 84 ft for 1024x768, 70 ft for 1280x768, 30 ft for 1600x1200 (using CresCAT-QM or CresCAT-IM cable)

QM OUT 1: (1) 8-wire RJ45 female, QuickMedia output port containing RGB (same as touchscreen), WAV file audio, and internal microphone signals;

RGB Format: RGBHV

RGB Output Resolution, Non-interlaced: 1024 x 768 pixels @ 60Hz

Connects to QM input port of any QuickMedia device via CresCAT-QM or CresCAT-IM cable

HEADPHONES: (1) 3.5 mm TRS mini phone jack

Output Power: 12mW per channel

Minimum Impedance: 32 ohms

RS-232: (1) 6-pin RJ11 female

Computer console, touch output, or mouse/touch input port

Bidirectional RS-232 up to 115.2k baud

Hardware and software handshaking support

LAN: (1) 8-wire RJ45 with 2 LED indicators

10BaseT/100BaseTX Ethernet port

Green LED indicates link status

Yellow LED indicates Ethernet activity

24VDC: (1) 2.1mm barrel DC power jack

Do not use

NET: (1) 4-pin 3.5mm detachable terminal block

Cresnet Slave Port, connects to Cresnet control network

USB: (2) USB Type A female

USB 1.1 ports for mouse or touchscreen input¹

GND: (1) 6-32 screw, chassis ground lug

MEMORY EXP.: (1) Type II Compact Flash card slot for memory expansion

PC CARD A - B: (2) Type II PC Card slots

(reserved for future applications)¹

Power Requirements

Cresnet Power Usage: 75 Watts (3.13 Amps @ 24 Volts DC)

Note: 24VDC jack should not be used.

Environmental

Temperature: 41° to 113°F (5° to 45°C)

Humidity: 10% to 90% RH (non-condensing)

Enclosure

Construction: Metal, flush mountable, 9U 19" rack-mountable (all mounting kits sold separately)

Front Bezel: Injection-molded plastic; black w/silver or white w/gray accent

> continued

ISYS® WALL MOUNT TOUCHPANELS

→ Isys® G-Series Wall Mount Touchpanels

TPS-15G-QM-L Isys® G-Series 15" Wall Mount Touchpanel w/QuickMedia™ (continued)

Dimensions

Height: 13.59 in (34.52 cm)

Width: 14.17 in (35.99 cm)

Depth: 3.80 in (9.66 cm)

Weight

9.8 lbs (4.4 kg)

¹ See Web site or contact Crestron for a current list of compatible devices.

² One or more QuickMedia devices are required to facilitate the input and output of audio, video, and RGB signals. See the "MediaManager" section of this catalog or visit the Crestron Website for more information about QuickMedia.

TPS-15G-QM-L in a QuickMedia System

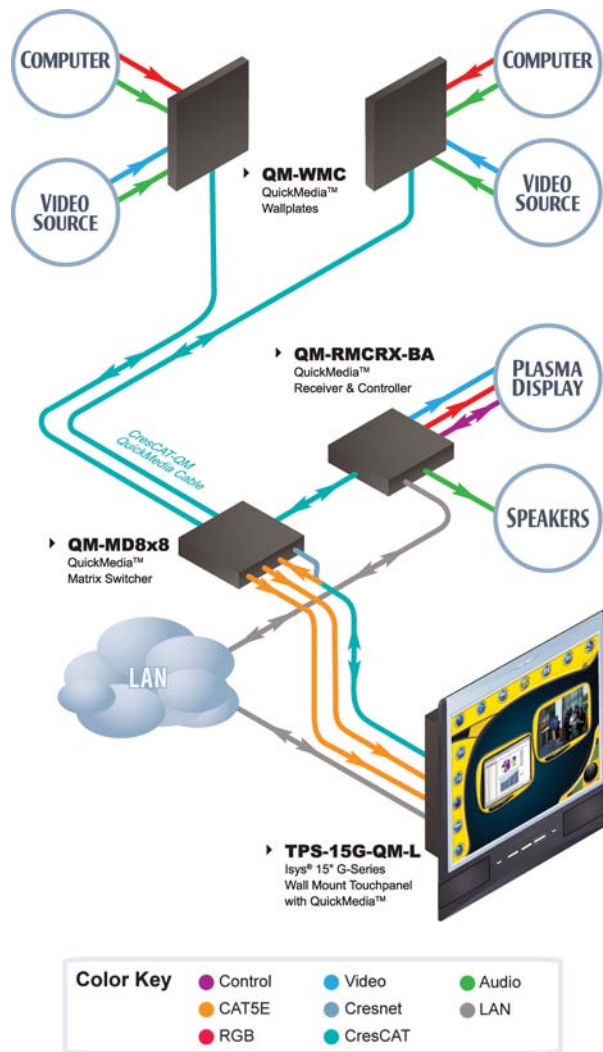

wall mount touchpanels

AVAILABLE ACCESSORIES

- ▶ **BB-15L**
Pre-Construction
Wall Mount Back Box
- ▶ **PMK-15L**
Pre-Construction
Wall Mount Kit
- ▶ **TMK-15L**
Trim Ring
- ▶ **MMK-15L**
Mud Ring
- ▶ **WMKT-15L**
Lectern or Post-Construction
Wall Mount Kit with Trim Ring
- ▶ **WMKM-15L**
Post-Construction Wall
Mount Kit with Mud Ring
- ▶ **RMK-15L**
Rack Mount Kit
- ▶ **QM-TX**
QuickMedia Transmitter
- ▶ **TPS/TPMC-CBL-T**
Triamese Interface Cables
- ▶ **ST-PK**
Programming Cable Kit
- ▶ **CresCAT®QM**
QuickMedia™ Cable
- ▶ **CresCAT®IM**
iMedia Cable

ISYS® WALL MOUNT TOUCHPANELS

→ Isys® G-Series Wall Mount Touchpanels

Isys® G-Series 12" Wall Mount Touchpanel w/QuickMedia™ **TPS-12G-QM-L**

Crestron's Isys G-Series touchpanels deliver a higher level of performance with dual-window video, RGB, and HDTV display to meet the demands of today's sophisticated control and automation applications. Incorporating modern styling in a versatile flush mount design, the Isys TPS-12G-QM-L features a spectacular 12" SVGA display offering a wide viewing angle with exceptional brightness and contrast for stunning control graphics, high-resolution images, and full-motion HD video.

Crestron touchpanels offer an ideal user-interface for multimedia presentation, videoconferencing, home automation, and much more, providing a wide-open canvas for the creation of custom control screens tailored to the needs of the end-user. Touchpanels do away with piles of remote controls, cryptic control panels and cluttered wall switches, simultaneously expanding and simplifying control over a broad range of complex devices and systems.

Isys®—Isys power and beauty are infused throughout Crestron's entire touchpanel lineup. Under the hood, the TPS-12G-QM-L offers vibrant 24-bit color depth with 8-bit alpha channel transparency to produce incredible 3D graphics and high-res images. The Isys engine supports dynamic graphics and text, full-motion animations, multimode objects, and PNG translucency – all with astonishing speed.

Synapse™—Crestron's exclusive Synapse Image Rendering Algorithm enables system programmers to produce amazing graphics - faster and easier. Advanced antialiasing delivers crisper, sharper objects and text. Enhanced 3D effects add new depth and style. And because Synapse is native to the touchpanel, memory requirements and upload time are substantially reduced.

Dual-Window HD Video and RGB²—The TPS-12G-QM-L can simultaneously display two fully-scalable, full-motion video windows, each supporting standard video, HDTV, and high-resolution RGB signals from external AV and computer sources. Discrete video scalars with motion adaptive deinterlacing bring out the highest detail, minimizing visible scan lines and motion artifacts for a truly remarkable picture. Advanced gamma correction and built-in time base correction ensure accurate color reproduction and a jitter-free image.



Touch-the-PC—Crestron's exclusive "Touch-the-PC" technology allows real-time touchpanel navigation of any Windows PC through a direct high-speed serial connection.

Built-in Annotation—Built-in annotation capability allows presenters to write or draw over computer and video images on the touchscreen using a finger or stylus, and output the image live for audience display.

High-Quality Audio²—The high-powered biamplified speaker system provides amplification for external AV sources, and supports intercom functionality in combination with the integrated microphone. Customized WAV files can be loaded on the touchpanel to add dimension to the touchscreen graphics with personalized sounds, button feedback, and voice prompts.

QuickMedia™—All audio and video connections are facilitated using Crestron's revolutionary QuickMedia transport, providing a flexible yet remarkably simple wiring solution. Through QuickMedia (QM), the TPS-12G-QM-L interfaces directly with other QM-based products using inexpensive CAT5e type cable.

The two QM Input ports each support non-interlaced RGB up to 1600 X 1200 pixels, as well as composite, S-Video, and component video signals. QM Input #1 includes software adjustable compensation for cable runs up to 450 feet; Input #2 allows up to 300 feet for video and HDTV, and shorter distances for RGB computer signals. Both QM Inputs receive audio signals from external microphone and stereo line level sources.

> continued

ISYS® WALL MOUNT TOUCHPANELS

→ Isys® G-Series Wall Mount Touchpanels

TPS-12G-QM-L Isys® G-Series 12" Wall Mount Touchpanel w/QuickMedia™ (continued)

The QM Output port allows RGB output of the touchpanel screen image to feed a display device for audience presentation. A 24-bit digital audio signal is also present for distribution of the internal microphone signal.

High-Speed Connectivity—Both Cresnet and high-speed Ethernet are standard on the TPS-12G-QM-L, providing for easy network integration and seamless communications with Crestron control systems. USB connectivity is also included for connection of an external mouse, touchscreen, or similar pointing device¹.

Versatile Flush Mount Design—The TPS-12G-QM-L is designed for easy flush-mount installation in a wall, lectern or similar flat surface. A variety of mounting accessories is offered including optional back box and 19" rack mount kit. Five backlit pushbuttons are also provided, allowing for quick access to commonly used functions.

- ▶ 12" active matrix touchscreen display | 800 x 600 resolution
- ▶ 24-Bit Isys graphics | Synapse image rendering algorithm
- ▶ Dual-window full-motion video, HDTV and RGB display²
- ▶ Built-in biamplified speaker system and microphone²
- ▶ QuickMedia AV connectivity | audience presentation output²
- ▶ High-speed Ethernet and Cresnet communications
- ▶ Built-in real-time annotation
- ▶ Backlit "Softkey" pushbuttons
- ▶ Wall, lectern, and rack mounting options
- ▶ Available in black or white

AVAILABLE MODELS

TPS-12G-QM-LB

Isys G-Series 12" Wall Mount Touchpanel, Black

TPS-12G-QM-LW

Isys G-Series 12" Wall Mount Touchpanel, White

SPECIFICATIONS

Touchscreen Display

Display Type: TFT Active matrix color LCD
Size: 12 inch (30.5 cm) diagonal
Aspect Ratio: 4:3 SVGA
Resolution: 800 x 600 pixels
Brightness: 400 nits (cd/m²)
Contrast: 300:1
Color Depth: 18-bit, 256k colors
Illumination: Backlit fluorescent
Viewing Angle: ±70° horizontal, +45/-55° vertical
Touchscreen: Resistive membrane

Processor

CPU: 32-bit Freescale ColdFire® Microprocessor
Processing Speed: 410 MIPS (Dhrystone 2.1 benchmark)

Memory

DDR RAM: 128 MB
Flash: 64 MB
Compact Flash: Accepts up to 4GB Type II CF (not included)
Maximum Project Size: 160 MB

Graphic Engine

Isys engine, 24-bit non-palette graphics + 8-bit alpha channel transparency, 16.7 million colors, Synapse image rendering algorithm, multi-mode objects, dynamic graphics, PNG translucency, full-motion (60 fps) animation, transition effects, color key video windowing

TPS-12G-QM-L using a single QuickMedia Transmitter

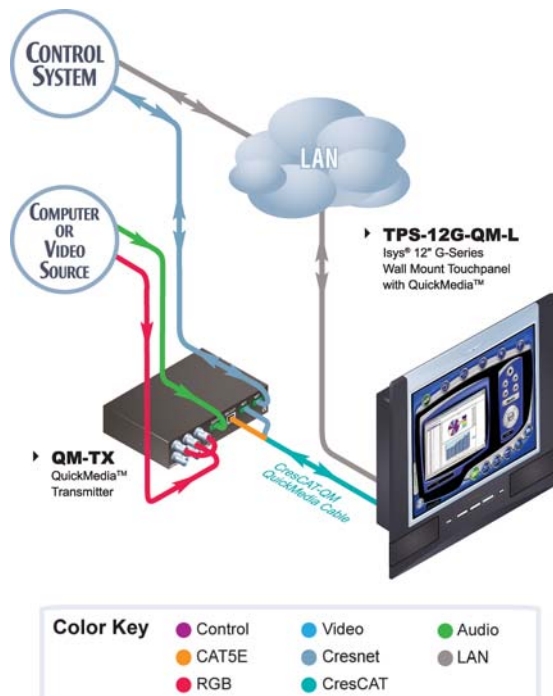

ISYS® WALL MOUNT TOUCHPANELS

→ Isys® G-Series Wall Mount Touchpanels

Isys® G-Series 12" Wall Mount Touchpanel w/QuickMedia™ **TPS-12G-QM-L**

Ethernet

10BaseT/100BaseTX, auto-switching, auto-negotiating, full/half duplex, TCP/IP, UDP/IP, CIP, IEEE 802.3U compliant

Video/RGB²

Signal Types: RGB and auto-detecting composite, S-Video, or component video

Formats: SDTV 480i (NTSC) & 576i (PAL), EDTV 480p & 576p, HDTV 720p & 1080i; RGB(VGA) up to UXGA 1600 x 1200

Color Depth: 24-bit, 16.7M colors

Features: Dual-window each scalable to full-screen, time base correction, gamma correction, line doubling, motion adaptive deinterlacing, reverse 3:2/2:2 pulldown

Audio²

Hardware Features: Built-in microphone and biamplified speakers, stereo headphone output, internal volume control and audio mixer

Audio Feedback (WAV): 8-bit PCM, mono, 8 kHz sampling rate

D-A Conversion (QM): 24-bit, 48 kHz

Amplification: Bi-amplified, mono, 5 Watts for high-frequency, 5 Watts for low-frequency

Buttons

(4) Backlit "softkey" buttons, programmable

(1) Backlit hard reset button, reboots the touchpanel

Connectors

QM IN 1: (1) 8-wire RJ45 female, QuickMedia input port

Signal Types: Dynamically configurable under system control as:

- (1) RGB input with stereo program audio and (2) mic channels, or
- (1) Auto-detecting component (YPbPr), S-Video (Y/C), or composite video input with stereo program audio and (2) mic channels;

RGB Format: RGBHV

RGB Input Resolution, Non-interlaced: 640 x 480 minimum to 1600 x 1200 maximum (60 Hz limit at 1600 x 1200);

Video/HDTV Formats: 480i (NTSC), 576i (PAL), 480p, 576p, 720p and 1080i;

Horizontal Frequency: 15 to 100 kHz

Vertical Frequency: 50 to 85 Hz

Delay Skew Compensation: 0 - 22 nS

Connects to QM output port of a QM-TX or other QuickMedia device via CresCAT-QM or CresCAT-IM cable;

Maximum Cable Length: 450 ft (aggregate distance from QM origination)

QM IN 2: (1) 8-wire RJ45 female, QuickMedia input port

Signal Types: Dynamically configurable under system control as:

- (1) RGB input with stereo program audio and (2) mic channels, or
- (1) Auto-detecting component (YPbPr), S-Video (Y/C), or composite video input with stereo program audio and (2) mic channels;

RGB Format: RGBHV

RGB Input Resolution, Non-interlaced: 640 x 480 minimum to 1600 x 1200 maximum (60 Hz limit at 1600 x 1200);

Video/HDTV Formats: 480i (NTSC), 576i (PAL), 480p, 576p, 720p and 1080i;

Horizontal Frequency: 15 to 100 kHz

Vertical Frequency: 50 to 85 Hz

Delay Skew Compensation: none

Connects to QM output port of a QM-TX or other QuickMedia device via CresCAT-QM or CresCAT-IM cable;

Maximum Cable Length (Video/HDTV): 300 ft (aggregate distance from QM origination);

Maximum Cable Length (RGB @ 60Hz): 216 ft for 640x480, 140 ft for 800x600, 84 ft for 1024x768, 70 ft for 1280x768, 30 ft for 1600x1200 (using CresCAT-QM or CresCAT-IM cable)

QM OUT 1: (1) 8-wire RJ45 female, QuickMedia output port containing RGB (same as touchscreen), WAV file audio, and internal microphone signals;

RGB Format: RGBHV

RGB Output Resolution, Non-interlaced: 800 x 600 pixels @ 60Hz

Connects to QM input port of any QuickMedia device via CresCAT-QM or CresCAT-IM cable

HEADPHONES: (1) 3.5 mm TRS mini phone jack

Output Power: 12mW per channel

Minimum Impedance: 32 ohms

RS-232: (1) 6-pin RJ11 female

Computer console, touch output, or mouse/touch input port¹

Bidirectional RS-232 up to 115.2k baud

Hardware and software handshaking support

LAN: (1) 8-wire RJ45 with 2 LED indicators

10BaseT/100BaseTX Ethernet port

Green LED indicates link status

Yellow LED indicates Ethernet activity

24VDC: (1) 2.1mm barrel DC power jack

24V DC power input (power supply sold separately)

NET: (1) 4-pin 3.5mm detachable terminal block

Cresnet Slave Port, connects to Cresnet control network

USB: (2) USB Type A female

USB 1.1 ports for mouse or touchscreen input¹

GND: (1) 6-32 screw, chassis ground lug

MEMORY EXP.: (1) Type II Compact Flash card slot

For memory expansion

PC CARD A - B: (2) Type II PC Card slots

(reserved for future applications)¹

Power Requirements

24VDC: 50 Watts (2.08 Amps) @ 24 Volts DC (PW-2420RU power supply sold separately)

Cresnet Power Usage: 50 Watts (2.08 Amps @ 24 Volts DC)

Note: Power should only be applied to the 24VDC power jack OR the NET port, not both.

> continued

ISYS® WALL MOUNT TOUCHPANELS

→ Isys® G-Series Wall Mount Touchpanels

TPS-12G-QM-L Isys® G-Series 12" Wall Mount Touchpanel w/QuickMedia™ (continued)

Environmental

Temperature: 41° to 113°F (5° to 45°C)

Humidity: 10% to 90% RH (non-condensing)

Enclosure

Construction: Metal, flush mountable, 8U 19" rack-mountable (all mounting kits sold separately)

Front Bezel: Injection-molded plastic; black w/silver or white w/gray accent

Dimensions

Height: 11.80 in (29.98 cm)

Width: 13.61 in (34.57 cm)

Depth: 3.80 in (9.66 cm)

Weight

8.2 lbs (3.8 kg)

¹ See Web site or contact Crestron for a current list of compatible devices.

² One or more QuickMedia devices are required to facilitate the input and output of audio, video, and RGB signals. See the "MediaManager" section of this catalog or visit the Crestron Website for more information about QuickMedia.

TPS-12G-QM-L in a QuickMedia System

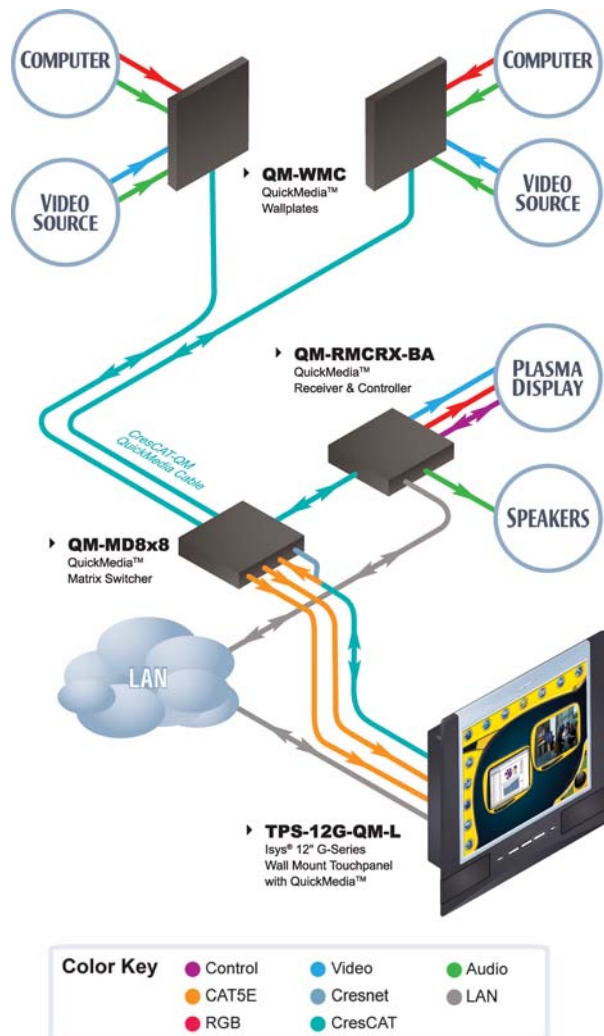

wall mount touchpanels

AVAILABLE ACCESSORIES

- | | | | |
|--|--|--|--|
| ▶ BB-12L
Pre-Construction
Wall Mount Back Box | ▶ WMKT-12L
Lectern or Post-Construction
Wall Mount Kit with Trim Ring | ▶ QM-TX
QuickMedia Transmitter | ▶ PW-2420RU
Power Supply |
| ▶ PMK-12L
Pre-Construction
Wall Mount Kit | ▶ WMKM-12L
Post-Construction Wall
Mount Kit with Mud Ring | ▶ TPS/TPMC-CBL-T
Triamese Interface Cables | ▶ CresCAT®QM
QuickMedia™ Cable |
| ▶ TMK-12L
Trim Ring | ▶ RMK-12L
Rack Mount Kit | ▶ ST-PK
Programming Cable Kit | ▶ CresCAT®IM
iMedia Cable |
| ▶ MMK-12L
Mud Ring | | | |

ISYS® WALL MOUNT TOUCHPANELS

→ Isys i/O™ Wall Mount Touchpanel Media Centers

Isys i/O™ 17" Wall Mount Touchpanel Media Center w/QuickMedia™ **TPMC-17-QM-L**

Isys i/O ingeniously integrates touchpanel control with embedded PC functionality, delivering a unified multimedia presentation solution. Incorporating modern styling in a versatile flush mount design, the TPMC-17-QM-L Touchpanel Media Center features a spectacular 17" WXGA widescreen display offering an extra wide viewing angle with exceptional brightness and contrast for stunning control graphics, high-res images, embedded PC applications, and full-motion HD video.

Touchpanel Control and Presentation—In every sense, the TPMC-17-QM-L is a true Crestron touchpanel, offering vibrant 24-bit color depth with 8-bit alpha channel transparency to produce incredible 3D graphics using new dynamic menu objects, dynamic graphics, full-motion animations, multimode objects, PNG translucency, and exclusive Synapse™ image rendering – all with astonishing speed. But more than a touchpanel, the TPMC-17-QM-L is also a dynamic presentation source, outputting high-resolution graphics and audio to any sized audience via integrated QuickMedia transport technology.

Embedded PC—The power of Isys i/O is in its embedded PC engine, combining rock solid touchpanel performance with enhanced capabilities for surfing the Internet, streaming digital media, and viewing online documents. Running the Microsoft® Windows® XP Embedded operating system, Isys i/O delivers a powerful and secure platform for touchpanel control with integrated PC functionality. Programmatic control erases the lines between control system and PC, allowing programmers to customize each application's behavior within the touchpanel environment to create a truly powerful and user-friendly interface.

With built-in Windows Media® Player, RealPlayer®, and Internet Explorer, plus viewers for Word, Excel, PowerPoint®, and Adobe® Acrobat®, the TPMC-17-QM-L serves as a complete multimedia presentation source without necessitating a separate computer. You can also access data and run applications on other computers via Remote Desktop, and use NetMeeting® and Skype™ for interactive conferencing and voice-over-IP (VoIP) communications – right on the touchpanel. Plus, support for Yahoo! Widgets affords an easy solution for integrating everything from calendars and clocks to stock tickers, weather forecasts, news feeds, and thousands of other fun and useful utilities.



MediaMarker™ Annotation—Built-in annotation allows presenters to write or draw electronically on the touchscreen using a finger or stylus. Whether drawing freehand on a whiteboard screen, highlighting points on a spreadsheet, or making notes over motion video or still images, MediaMarker facilitates crystal clear visual communications.

Dual-Window HD Video and RGB²—In addition to its internal PC and streaming video applications, the TPMC-17-QM-L can also simultaneously display two fully-scalable, full-motion video windows. Each window supports standard video, HDTV, and high-resolution RGB signals from external AV and computer sources. Discrete video scalers with motion adaptive deinterlacing bring out the highest detail, minimizing visible scan lines and motion artifacts for a truly remarkable picture. Advanced gamma correction and built-in time base correction ensure accurate color reproduction and a jitter-free image.

High-Quality Audio²—An integrated microphone, biamplified speakers, stereo headphone output, and PC audio output are all built into the touchpanel to support full AV, intercom, desktop conferencing, and multimedia computer capabilities. Customized WAV files can be loaded on the touchpanel to add dimension to the touchscreen graphics with personalized sounds, button feedback, and voice prompts.

QuickMedia™—All audio and video connections are facilitated using Crestron's revolutionary QuickMedia transport, providing a flexible yet remarkably simple wiring solution. Through QuickMedia (QM), the TPMC-17-QM-L interfaces directly with other QM-based products using inexpensive CAT5e type cable.

> continued

wall mount touchpanels

ISYS® WALL MOUNT TOUCHPANELS

→ Isys i/O™ Wall Mount Touchpanel Media Centers

TPMC-17-QM-L Isys i/O™ 17" Wall Mount Touchpanel Media Center w/QuickMedia™

The two QM Input ports each support non-interlaced RGB up to 1600 X 1200 pixels, as well as composite, S-Video, and component video signals. QM Input #1 includes software-adjustable compensation for cable runs up to 450 feet; Input #2 allows up to 300 feet for video and HDTV, and shorter distances for RGB computer signals. Both QM Inputs receive audio signals from external microphone and stereo line level sources.

High-resolution RGB graphics and 24-bit digital audio are output from the internal PC and microphone via the QM Output port for audience presentation and intercom purposes.

Connectivity and Expansion—Both Cresnet and high-speed Ethernet are standard on the TPMC-17-QM-L, providing for seamless communications with Crestron control systems, computers, digital media servers, and other IP-based devices. Wi-Fi wireless networking and memory expansion are easily added through two PC card slots, and two USB ports enable the connection of an external mouse and keyboard (not included), as well as USB cameras, CD ROM drives, and memory devices.¹

Versatile Flush Mount Design—The TPMC-17-QM-L is designed for flush-mount installation in a wall, lectern or similar flat surface. A variety of mounting accessories is offered including optional back box and 19" rack mount kit. Five backlit pushbuttons are also provided, allowing for quick access to commonly used functions.

- ▶ [17" widescreen active matrix touchscreen display | 1280 x 768 resolution](#)
- ▶ [24-Bit Isys i/O graphics | Synapse image rendering algorithm](#)
- ▶ [Windows XP Embedded operating system](#)
- ▶ [Onboard PC applications for Web browsing, streaming media, conferencing, VoIP, remote desktop, and digital media presentation - no computer required!](#)
- ▶ [Built-in real-time annotation using Crestron MediaMarker](#)
- ▶ [Dual-window HD video and RGB display²](#)
- ▶ [Built-in 10 watt biamplified speaker system and microphone²](#)
- ▶ [QuickMedia AV connectivity | audience presentation output²](#)
- ▶ [Secure high-speed Ethernet and Cresnet communications](#)
- ▶ [Wall, lectern, and rack mounting options](#)
- ▶ [Available in black or white](#)

AVAILABLE MODELS

TPMC-17-QM-LB

Isys i/O 17" Wall Mount Touchpanel Media Center, Black

TPMC-17-QM-LW

Isys i/O 17" Wall Mount Touchpanel Media Center, White

SPECIFICATIONS

Touchscreen Display

Display Type: TFT Active matrix color LCD
Size: 17 inch (43.2 cm) diagonal widescreen
Aspect Ratio: 15:9 WXGA
Resolution: 1280 x 768 pixels
Brightness: 450 nits (cd/m²)
Contrast: 400:1
Color Depth: 24-bit, 16.7M colors
Illumination: Backlit fluorescent
Viewing Angle: ±88° horizontal, ±88° vertical
Touchscreen: Resistive membrane

Processor

VIA Eden™ 667 MHz CPU

Memory

SDRAM: 512 MB
Flash: 512 MB
PC Card: Accepts up to (2) 4GB Type II PC Cards (not included)
Maximum Project Size: 190 MB

Operating System

Microsoft® Windows® XP Embedded

Graphic Engine

Isys i/O engine, VIA Unichrome™ CLE266 chipset, 24-bit non-palette graphics + 8-bit alpha channel transparency, 16.7 million colors, Synapse image rendering algorithm, multi-mode objects, dynamic menu objects, dynamic graphics, PNG translucency, full-motion (60 fps) animation, transition effects, color key video windowing

Embedded Software Applications¹

Microsoft Internet Explorer w/Macromedia® Flash® plug-in, Windows Media® Player, RealPlayer®, Axis® Media Control, Crestron MediaMarker™, Remote Desktop, NetMeeting®, Skype™, Java™ Runtime, DirectX®, Yahoo! Widgets®, Adobe® Acrobat® Reader, and viewers for MS Word, Excel, and PowerPoint®

Ethernet

10BaseT/100BaseTX, auto-negotiating, full/half duplex TCP/IP, UDP/IP, CIP, DHCP, IEEE 802.3U compliant

Wireless

Wireless Ethernet capable using third-party 802.11 PC card¹ (Wired connections required for power, audio, video and RGB)

Video/RGB²

Signal Types: RGB and auto-detecting composite, S-Video, or component video
Formats: SDTV 480i (NTSC) & 576i (PAL), EDTV 480p & 576p, HDTV 720p & 1080i; RGB(VGA) up to UXGA 1600 x 1200

ISYS® WALL MOUNT TOUCHPANELS

→ Isys i/O™ Wall Mount Touchpanel Media Centers

Isys i/O™ 17" Wall Mount Touchpanel Media Center w/QuickMedia™ **TPMC-17-QM-L**

Color Depth: 24-bit, 16.7M colors

Features: Dual-window each scalable to full-screen, time base correction, gamma correction, line doubling, motion adaptive deinterlacing, reverse 3:2:2:2 pulldown

Streaming/File Formats: MPEG4 and MJPEG via Axis Media Control plus all formats supported by the embedded media player applications¹

Audio²

Hardware Features: Built-in microphone and biamplified speakers, stereo headphone output, internal volume control and audio mixer

Streaming/File Formats: All formats supported by the embedded media player applications¹

Audio Feedback (WAV): 8 & 16 bit PCM, mono & stereo, 8 – 44 kHz sampling rates

D-A / A-D Conversion (QM): Burr Brown 24-bit, 48 kHz

Amplification: Bi-amplified, mono, 5 Watts for high-frequency, 5 Watts for low-frequency

Buttons

(4) Backlit "softkey" buttons, programmable

(1) Backlit hard reset button, reboots the touchpanel system

Connectors

QM IN 1: (1) 8-wire RJ45 female, QuickMedia input port
Signal Types: Dynamically configurable under system control as:

(1) RGB input with stereo program audio and (2) mic channels, or

(1) Auto-detecting component (YPbPr), S-Video (Y/C), or composite video input with stereo program audio

and (2) mic channels;

RGB Format: RGBHV

RGB Input Resolution, Non-interlaced: 640 x 480 minimum to 1600 x 1200 maximum (60 Hz limit at 1600 x 1200);

Video/HDTV Formats: 480i (NTSC), 576i (PAL), 480p, 576p, 720p and 1080i;

Horizontal Frequency: 15 to 100 kHz

Vertical Frequency: 50 to 85 Hz

Delay Skew Compensation: 0 – 22 nS

Connects to QM output port of a QM-TX or other QuickMedia device via CresCAT-QM or CresCAT-IM cable;

Maximum Cable Length: 450 ft (aggregate distance from QM origination)

QM IN 2: (1) 8-wire RJ45 female, QuickMedia input port

Signal Types: Dynamically configurable under system control as:

(1) RGB input with stereo program audio and (2) mic channels, or

(1) Auto-detecting component (YPbPr), S-Video (Y/C), or composite video input with stereo program audio

and (2) mic channels;

RGB Format: RGBHV

RGB Input Resolution, Non-interlaced: 640 x 480 minimum to 1600 x 1200 maximum (60 Hz limit at 1600 x 1200);

Video/HDTV Formats: 480i (NTSC), 576i (PAL), 480p, 576p, 720p and 1080i;

Horizontal Frequency: 15 to 100 kHz

Vertical Frequency: 50 to 85 Hz

Delay Skew Compensation: none

Connects to QM output port of a QM-TX or other QuickMedia device via CresCAT-QM or CresCAT-IM cable;

Maximum Cable Length (Video/HDTV): 300 ft (aggregate distance from QM origination);

Maximum Cable Length (RGB @ 60Hz): 216 ft for 640x480, 140 ft for 800x600, 84 ft for 1024x768, 70 ft for 1280x768, 30 ft for 1600x1200 (using CresCAT-QM or CresCAT-IM cable)

TPMC-17-QM-L using a single QuickMedia Transmitter

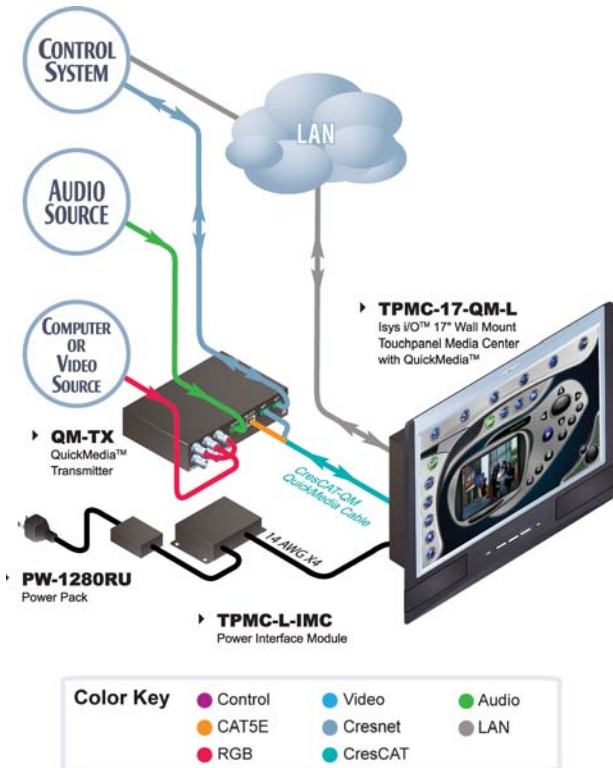

Wall mount touchpanels

> continued

ISYS® WALL MOUNT TOUCHPANELS

→ Isys i/O™ Wall Mount Touchpanel Media Centers

TPMC-17-QM-L Isys i/O™ 17" Wall Mount Touchpanel Media Center w/QuickMedia™

QM OUT 1: (1) 8-wire RJ45 female, QuickMedia output port containing RGB output with stereo audio from internal PC and (2) discrete channels from internal mic;
RGB Format: RGBHV
RGB Output Resolution, Non-interlaced: 1280 x 768 pixels @ 60 Hz
Connects to QM input port of any QuickMedia device via CresCAT-QM or CresCAT-IM cable

HEADPHONES: (1) 3.5 mm TRS mini phone jack
Output Power: 105 mW per channel
Minimum Impedance: 8 ohms

USB: (2) USB Type A female, USB 1.1 ports for mouse, keyboard, and storage devices¹

RS-232: (1) 6-pin RJ11 female, computer console port
Bidirectional RS-232 up to 115.2k baud
Hardware and software handshaking support

PC CARD A - B: (2) Type II PC Card slots for memory expansion, project upload, and wireless NIC¹

ETHERNET: (1) 8-wire RJ45 with 2 LED indicators
10BaseT/100BaseTX Ethernet port
Green LED indicates network speed
Yellow LED indicates Ethernet activity

NET: (1) 4-pin 3.5mm detachable terminal block
Cresnet Slave Port (data only; 24V terminal not used)
Connects to Cresnet control network

PWR: (1) 4-pin DC power jack, 12.5V DC power input (external power supply included)

PWR OUT: (1) 4-pin DC power jack
Connects to PWR jack using 9-inch 4-pin DC power patch cable (included) when locating power supply remotely; passes 12.5V DC power from PWR IN terminal blocks

PWR IN: (2) 2-pin detachable terminal blocks, paralleled
Used to extend power cabling up to 60 feet using 4 conductor, 14 AWG wire connected to a TPMC-L-IMC power interface module (included) at remote power supply location

G: (1) 6-32 screw, chassis ground lug

Power Requirements

TPMC-17-QM-L: 8.4 Amps @ 12.5 Volts DC

External Power Supply (included): 2.2 Amps @ 100-250 Volts AC, 50/60 Hz

Cresnet Power Usage: 0 Watt @ 24 Volts DC

Environmental

Temperature: 50° to 113°F (10° to 45°C)

Humidity: 10% to 90% RH (non-condensing)

Enclosure

Construction: Metal, flush mountable, 9U 19" rack-mountable (all mounting kits sold separately)

Front Bezel: Injection-molded plastic; black w/silver or white w/gray accent

Dimensions

Height: 13.81 in (35.06 cm)

Width: 16.98 in (43.11 cm)

Depth: 3.84 in (9.74 cm)

Weight

13.4 lbs (6.10 kg)

INCLUDED ACCESSORIES

(See individual product specifications for complete information.)

TPMC-L-IMC

Power Interface Module

PW-1280RU

Power Supply

¹ See Web site or contact Crestron for a current list of compatible devices and embedded applications. To ensure reliable performance, new device drivers and applications are available only from Crestron through firmware updates.

² One or more QuickMedia devices are required to facilitate the input and output of audio, video, and RGB signals. See the "MediaManager" section of this catalog or visit the Crestron Website for more information about QuickMedia.

ISYS® WALL MOUNT TOUCHPANELS

→ Isys i/O™ Wall Mount Touchpanel Media Centers

Isys i/O™ 17" Wall Mount Touchpanel Media Center w/QuickMedia™ **TPMC-17-QM-L**

TPMC-17-QM-L in a QuickMedia System

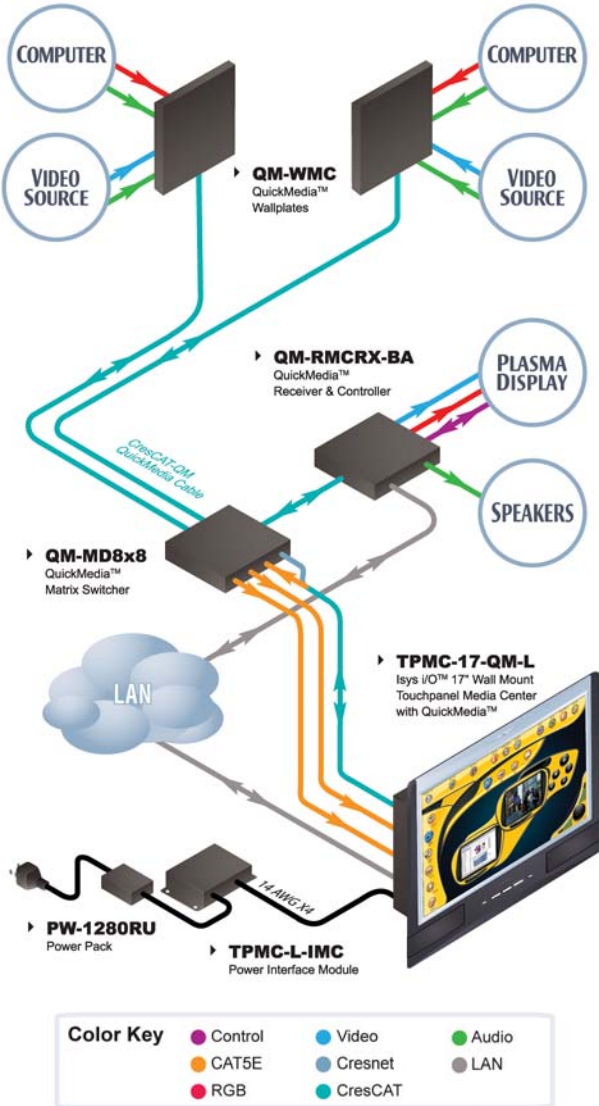

Wall mount touchpanels

AVAILABLE ACCESSORIES

- ▶ **BB-17L**
Pre-Construction Wall Mount Back Box
- ▶ **MMK-17L**
Mud Ring
- ▶ **QM-TX**
QuickMedia Transmitter
- ▶ **CresCAT®QM**
QuickMedia™ Cable
- ▶ **PMK-17L**
Pre-Construction Wall Mount Kit
- ▶ **WMKT-17L**
Lectern Mount Kit with Trim Ring
- ▶ **TPS/TPMC-CBL-T**
Triamese Interface Cables
- ▶ **CresCAT®IM**
iMedia Cable
- ▶ **TMK-17L**
Trim Ring
- ▶ **RMK-17L**
Rack Mount Kit

ISYS® WALL MOUNT TOUCHPANELS

→ Isys i/O™ Wall Mount Touchpanel Media Centers

TPMC-15-QM-L Isys i/O™ 15" Wall Mount Touchpanel Media Center w/QuickMedia™



wall mount touchpanels

Isys i/O ingeniously integrates touchpanel control with embedded PC functionality, delivering a unified multimedia presentation solution. Incorporating modern styling in a versatile flush mount design, the TPMC-15-QM-L Touchpanel Media Center features a spectacular 15" XGA display offering an extra wide viewing angle with exceptional brightness and contrast for stunning control graphics, high-res images, embedded PC applications, and full-motion HD video.

Touchpanel Control and Presentation—In every sense, the TPMC-15-QM-L is a true Crestron touchpanel, offering vibrant 24-bit color depth with 8-bit alpha channel transparency to produce incredible 3D graphics using new dynamic menu objects, dynamic graphics, full-motion animations, multimode objects, PNG translucency, and exclusive Synapse™ image rendering – all with astonishing speed. But more than a touchpanel, the TPMC-15-QM-L is also a dynamic presentation source, outputting high-resolution graphics and audio to any sized audience via integrated QuickMedia transport technology.

Embedded PC—The power of Isys i/O is in its embedded PC engine, combining rock solid touchpanel performance with enhanced capabilities for surfing the Internet, streaming digital media, and viewing online documents. Running the Microsoft® Windows® XP Embedded operating system, Isys i/O delivers a powerful and secure platform for touchpanel control with integrated PC functionality. Programmatic control erases the lines between control system and PC, allowing programmers to customize each application's behavior within the touchpanel environment to create a truly powerful and user-friendly interface.

With built-in Windows Media® Player, RealPlayer®, and Internet Explorer, plus viewers for Word, Excel, PowerPoint®, and Adobe® Acrobat®, the TPMC-15-QM-L serves as a

complete multimedia presentation source without necessitating a separate computer. You can also access data and run applications on other computers via Remote Desktop, and use NetMeeting® and Skype™ for interactive conferencing and voice-over-IP (VoIP) communications – right on the touchpanel. Plus, support for Yahoo! Widgets affords an easy solution for integrating everything from calendars and clocks to stock tickers, weather forecasts, news feeds, and thousands of other fun and useful utilities.

MediaMarker™ Annotation—Built-in annotation allows presenters to write or draw electronically on the touchscreen using a finger or stylus. Whether drawing freehand on a whiteboard screen, highlighting points on a spreadsheet, or making notes over motion video or still images, MediaMarker facilitates crystal clear visual communications.

Dual-Window HD Video and RGB²—In addition to its internal PC and streaming video applications, the TPMC-15-QM-L can also simultaneously display two fully-scalable, full-motion video windows. Each window supports standard video, HDTV, and high-resolution RGB signals from external AV and computer sources. Discrete video scalers with motion adaptive deinterlacing bring out the highest detail, minimizing visible scan lines and motion artifacts for a truly remarkable picture. Advanced gamma correction and built-in time base correction ensure accurate color reproduction and a jitter-free image.

High-Quality Audio²—An integrated microphone, biamplified speakers, stereo headphone output, and PC audio output are all built into the touchpanel to support full AV, intercom, desktop conferencing, and multimedia computer capabilities. Customized WAV files can be loaded on the touchpanel to add dimension to the touchscreen graphics with personalized sounds, button feedback, and voice prompts.

QuickMedia™—All audio and video connections are facilitated using Crestron's revolutionary QuickMedia transport, providing a flexible yet remarkably simple wiring solution. Through QuickMedia (QM), the TPMC-15-QM-L interfaces directly with other QM-based products using inexpensive CAT5e type cable.

The two QM Input ports each support non-interlaced RGB up to 1600 X 1200 pixels, as well as composite, S-Video, and component video signals. QM Input #1 includes software-adjustable compensation for cable runs up to 450 feet; Input #2 allows up to 300 feet for video and HDTV, and shorter distances for RGB computer signals. Both QM Inputs receive audio signals from external microphone and stereo line level sources.

ISYS® WALL MOUNT TOUCHPANELS

→ Isys i/O™ Wall Mount Touchpanel Media Centers

Isys i/O™ 15" Wall Mount Touchpanel Media Center w/QuickMedia™ **TPMC-15-QM-L**

High-resolution RGB graphics and 24-bit digital audio are output from the internal PC and microphone via the QM Output port for audience presentation and intercom purposes.

Connectivity and Expansion—Both Cresnet and high-speed Ethernet are standard on the TPMC-15-QM-L, providing for seamless communications with Crestron control systems, computers, digital media servers, and other IP-based devices. Wi-Fi wireless networking and memory expansion are easily added through two PC card slots, and two USB ports enable the connection of an external mouse and keyboard (not included), as well as USB cameras, CD ROM drives, and memory devices.¹

Versatile Flush Mount Design—The TPMC-15-QM-L is designed for easy flush-mount installation in a wall, lectern or similar flat surface. A variety of mounting accessories is offered including optional back box and 19" rack mount kit. Five backlit pushbuttons are also provided, allowing for quick access to commonly used functions.

- ▶ 15" active matrix touchscreen display | 1024 x 768 resolution
- ▶ 24-Bit Isys i/O graphics | Synapse image rendering algorithm
- ▶ Windows XP Embedded operating system
- ▶ Onboard PC applications for Web browsing, streaming media, conferencing, VoIP, remote desktop, and digital media presentation - no computer required!
- ▶ Built-in real-time annotation using Crestron MediaMarker
- ▶ Dual-window HD video and RGB display²
- ▶ Built-in 10 watt biamplified speaker system and microphone²
- ▶ QuickMedia AV connectivity | audience presentation output²
- ▶ Secure high-speed Ethernet and Cresnet communications
- ▶ Wall, lectern, and rack mounting options
- ▶ Available in black or white

AVAILABLE MODELS

TPMC-15-QM-LB

Isys i/O 15" Wall Mount Touchpanel Media Center, Black

TPMC-15-QM-LW

Isys i/O 15" Wall Mount Touchpanel Media Center, White

SPECIFICATIONS

Touchscreen Display

Display Type: TFT Active matrix color LCD
Size: 15 inch (38.1 cm) diagonal
Aspect Ratio: 4:3 XGA
Resolution: 1024 x 768 pixels
Brightness: 350 nits (cd/m²)
Contrast: 700:1

Color Depth: 24-bit, 16.7M colors
Illumination: Backlit fluorescent
Viewing Angle: ±85° horizontal, ±85° vertical
Touchscreen: Resistive membrane

Processor

VIA Eden™ 667 MHz CPU

Memory

SDRAM: 512 MB
Flash: 512 MB
PC Card: Accepts up to (2) 4GB Type II PC Cards (not included)
Maximum Project Size: 190 MB

Operating System

Microsoft® Windows® XP Embedded

Graphic Engine

Isys i/O engine, VIA Unichrome™ CLE266 chipset, 24-bit non-palette graphics + 8-bit alpha channel transparency, 16.7 million colors, Synapse image rendering algorithm, multi-mode objects, dynamic menu objects, dynamic graphics, PNG translucency, full-motion (60 fps) animation, transition effects, color key video windowing

Embedded Software Applications¹

Microsoft Internet Explorer w/Macromedia® Flash® plug-in, Windows Media® Player, RealPlayer®, Axis® Media Control, Crestron MediaMarker™, Remote Desktop, NetMeeting®, Skype™, Java™ Runtime, DirectX®, Yahoo! Widgets®, Adobe® Acrobat® Reader, and viewers for MS Word, Excel, and PowerPoint®

Ethernet

10BaseT/100BaseTX, auto-negotiating, full/half duplex TCP/IP, UDP/IP, CIP, DHCP, IEEE 802.3U compliant

Wireless

Wireless Ethernet capable using third-party 802.11 PC card¹ (Wired connections required for power, audio, video and RGB)

Video/RGB²

Signal Types: RGB and auto-detecting composite, S-Video, or component video

Formats: SDTV 480i (NTSC) & 576i (PAL), EDTV 480p & 576p, HDTV 720p & 1080i; RGB(VGA) up to UXGA 1600 x 1200

Color Depth: 24-bit, 16.7M colors

Features: Dual-window each scalable to full-screen, time base correction, gamma correction, line doubling, motion adaptive deinterlacing, reverse 3:2:2:2 pull-down

Streaming/File Formats: MPEG4 and MJPEG via Axis Media Control plus all formats supported by the embedded media player applications¹

Audio²

Hardware Features: Built-in microphone and biamplified speakers, stereo headphone output, internal volume control and audio mixer

Streaming/File Formats: All formats supported by the embedded media player applications¹

Audio Feedback (WAV): 8 & 16 bit PCM, mono & stereo, 8 – 44 kHz sampling rates

> continued

ISYS® WALL MOUNT TOUCHPANELS

→ Isys i/O™ Wall Mount Touchpanel Media Centers

TPMC-15-QM-L Isys i/O™ 15" Wall Mount Touchpanel Media Center w/QuickMedia™

D-A / A-D Conversion (QM): Burr Brown 24-bit, 48 kHz
Amplification: Bi-amplified, mono, 5 Watts for high-frequency, 5 Watts for low-frequency

Buttons

- (4) Backlit "softkey" buttons, programmable
- (1) Backlit hard reset button, reboots the touchpanel system

Connectors

QM IN 1: (1) 8-wire RJ45 female, QuickMedia input port
 Signal Types: Dynamically configurable under system control as:
 (1) RGB input with stereo program audio and (2) mic channels, or
 (1) Auto-detecting component (YPbPr), S-Video (Y/C), or composite video input with stereo program audio and (2) mic channels;

RGB Format: RGBHV

RGB Input Resolution, Non-interlaced: 640 x 480 minimum to 1600 x 1200 maximum (60 Hz limit at 1600 x 1200);

Video/HDTV Formats: 480i (NTSC), 576i (PAL), 480p, 576p, 720p and 1080i;

Horizontal Frequency: 15 to 100 kHz

Vertical Frequency: 50 to 85 Hz

Delay Skew Compensation: 0 – 22 nS

Connects to QM output port of a QM-TX or other QuickMedia device via CresCAT-QM or CresCAT-IM cable;

Maximum Cable Length: 450 ft (aggregate distance from QM origination)

QM IN 2: (1) 8-wire RJ45 female, QuickMedia input port
 Signal Types: Dynamically configurable under system control as:
 (1) RGB input with stereo program audio and (2) mic channels, or
 (1) Auto-detecting component (YPbPr), S-Video (Y/C), or composite video input with stereo program audio and (2) mic channels;

RGB Format: RGBHV

RGB Input Resolution, Non-interlaced: 640 x 480 minimum to 1600 x 1200 maximum (60 Hz limit at 1600 x 1200);

Video/HDTV Formats: 480i (NTSC), 576i (PAL), 480p, 576p, 720p and 1080i;

Horizontal Frequency: 15 to 100 kHz

Vertical Frequency: 50 to 85 Hz

Delay Skew Compensation: none

Connects to QM output port of a QM-TX or other QuickMedia device via CresCAT-QM or CresCAT-IM cable;

Maximum Cable Length (Video/HDTV): 300 ft (aggregate distance from QM origination);

Maximum Cable Length (RGB @ 60Hz): 216 ft for 640x480, 140 ft for 800x600, 84 ft for 1024x768, 70 ft for 1280x768, 30 ft for 1600x1200 (using CresCAT-QM or CresCAT-IM cable)

QM OUT 1: (1) 8-wire RJ45 female, QuickMedia output port containing RGB output with stereo audio from internal PC and (2) discrete channels from internal mic;

RGB Format: RGBHV

RGB Output Resolution, Non-interlaced: 1024 x 768 pixels @ 60 Hz

Connects to QM input port of any QuickMedia device via CresCAT-QM or CresCAT-IM cable

HEADPHONES: (1) 3.5 mm TRS mini phone jack

Output Power: 105 mW per channel

Minimum Impedance: 8 ohms

TPMC-15-QM-L using a single QuickMedia Transmitter

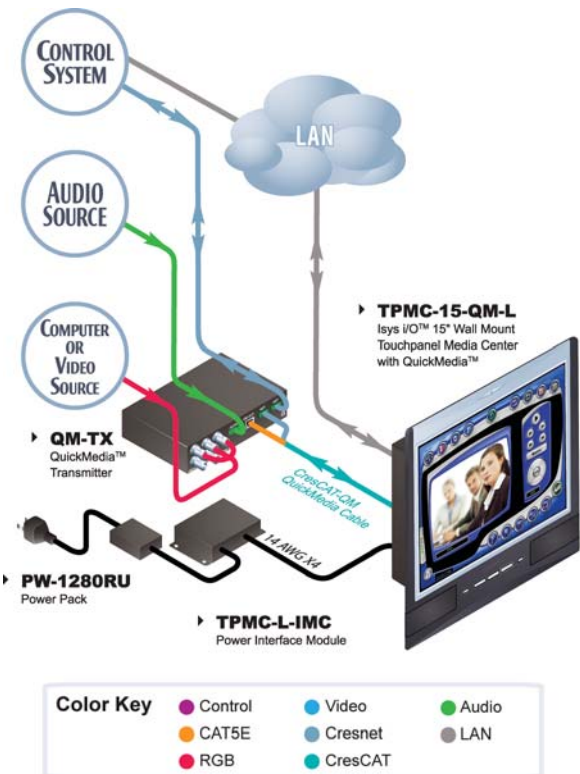

USB: (2) USB Type A female, USB 1.1 ports for mouse, keyboard, and storage devices'

RS-232: (1) 6-pin RJ11 female, computer console port
 Bidirectional RS-232 up to 115.2k baud
 Hardware and software handshaking support

PC CARD A – B: (2) Type II PC Card slots for memory expansion, project upload, and wireless NIC'

ETHERNET: (1) 8-wire RJ45 with 2 LED indicators
 10BaseT/100BaseTX Ethernet port
 Green LED indicates network speed
 Yellow LED indicates Ethernet activity

NET: (1) 4-pin 3.5mm detachable terminal block
 Cresnet Slave Port (data only; 24V terminal not used)
 Connects to Cresnet control network

PWR: (1) 4-pin DC power jack, 12.5V DC power input (external power supply included)

PWR OUT: (1) 4-pin DC power jack
 Connects to PWR jack using 9-inch 4-pin DC power patch cable (included) when locating power supply remotely; passes 12.5V DC power from PWR IN terminal blocks

PWR IN: (2) 2-pin detachable terminal blocks, paralleled
 Used to extend power cabling up to 60 feet using 4 conductor, 14 AWG wire connected to a TPMC-L-IMC power interface module (included) at remote power supply location

G: (1) 6-32 screw, chassis ground lug

wall mount touchpanels

ISYS® WALL MOUNT TOUCHPANELS

→ Isys i/O™ Wall Mount Touchpanel Media Centers

Isys i/O™ 15" Wall Mount Touchpanel Media Center w/QuickMedia™ **TPMC-15-QM-L**

Power Requirements

TPMC-15-QM-L: 8.4 Amps @ 12.5 Volts DC
External Power Supply (included):
 2.2 Amps @ 100–250 Volts AC, 50/60 Hz
Cresnet Power Usage: 0 Watt @ 24 Volts DC

Environmental

Temperature: 50° to 113°F (10° to 45°C)
Humidity: 10% to 90% RH (non-condensing)

Enclosure

Construction: Metal, flush mountable, 8U 19" rack-mountable (all mounting kits sold separately)
Front Bezel: Injection-molded plastic; black w/silver or white w/gray accent

Dimensions

Height: 13.59 in (34.52 cm)
Width: 14.17 in (35.99 cm)
Depth: 3.80 in (9.66 cm)

Weight

10.0 lbs (4.50 kg)

INCLUDED ACCESSORIES

(See individual product specifications for complete information.)

TPMC-L-IMC

Power Interface Module

PW-1280RU

Power Supply

¹ See Web site or contact Crestron for a current list of compatible devices and embedded applications. To ensure reliable performance, new device drivers and applications are available only from Crestron through firmware updates.

² One or more QuickMedia devices are required to facilitate the input and output of audio, video, and RGB signals. See the "MediaManager" section of this catalog or visit the Crestron Website for more information about QuickMedia.

TPMC-15-QM-L in a QuickMedia System

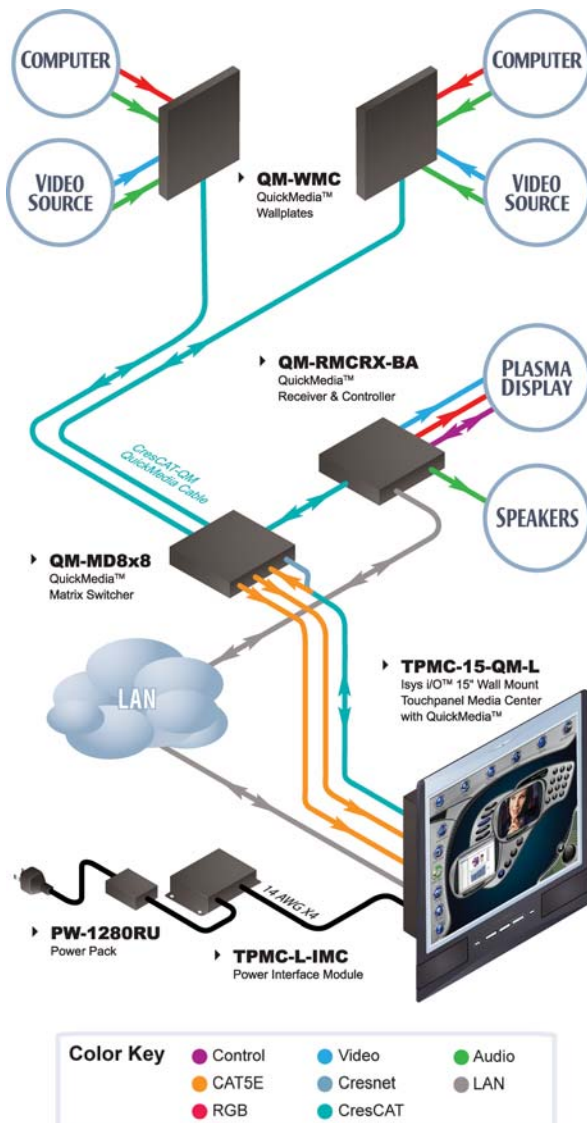

wall mount touchpanels

AVAILABLE ACCESSORIES

- | | | | |
|--|--|--|--|
| ▶ BB-15L
Pre-Construction
Wall Mount Back Box | ▶ MMK-15L
Mud Ring | ▶ RMK-15L
Rack Mount Kit | ▶ CresCAT®QM
QuickMedia™ Cable |
| ▶ PMK-15L
Pre-Construction Wall Mount Kit | ▶ WMKT-15L
Lectern or Post-Construction
Wall Mount Kit with Trim Ring | ▶ QM-TX
QuickMedia Transmitter | ▶ CresCAT®IM
iMedia Cable |
| ▶ TMK-15L
Trim Ring | ▶ WMKM-15L
Post-Construction Wall
Mount Kit with Mud Ring | ▶ TPS/TPMC-CBL-T
Triamese Interface Cables | |

ISYS® WALL MOUNT TOUCHPANELS

→ Isys i/O™ Wall Mount Touchpanel Media Centers

TPMC-17-CH-L Isys i/O™ 17" Wall Mount Touchpanel Media Center w/CH CAT5 AV



With built-in Windows Media® Player, RealPlayer®, and Internet Explorer, plus viewers for Word, Excel, PowerPoint®, and Adobe® Acrobat®, the TPMC-17-CH-L provides everything needed for viewing Web pages, enjoying online music and movies, and downloading documents without necessitating a separate computer. You can also access data and run applications on other computers via Remote Desktop, and use NetMeeting® and Skype™ for interactive conferencing and voice-over-IP (VoIP) communications – right on the touchpanel. Plus, support for Yahoo! Widgets affords an easy solution for integrating everything from calendars and clocks to stock tickers, weather forecasts, news feeds, and thousands of other fun and useful utilities.

Dual-Window HD Video—In addition to its internal PC and streaming video applications, the TPMC-17-CH-L can also simultaneously display two fully-scalable, full-motion video windows. Each window supports standard video and HDTV formats from external sources. Discrete video scalars with motion adaptive deinterlacing bring out the highest detail, minimizing visible scan lines and motion artifacts for an incredible picture. Advanced gamma correction and built-in time base correction ensure accurate color reproduction and a jitter-free image.

High-Quality Audio—An integrated microphone, bi-amplified speakers, stereo headphone output, and PC audio output are all built into the touchpanel to support full AV, intercom, desktop conferencing, and multimedia computer capabilities. Customized WAV files can be loaded on the touchpanel to add dimension to the touchscreen graphics with personalized sounds, button feedback, and voice prompts.

Crestron Home® CAT5 AV—All audio and video connections are facilitated using inexpensive CAT5 wire, enabling direct connection to Crestron's popular CAT5 balanced audio and video distribution switchers. Two video input ports are provided, each supporting composite, S-Video, and HDTV/component formats over wiring distances of up to 500 feet. A bidirectional audio port receives stereo program audio and intercom signals, and outputs audio from the internal microphone and PC for intercom and whole-house audio distribution. To facilitate the connection of conventional video and audio devices, an external interface module is included.

Connectivity and Expansion—Both Crestron and high-speed Ethernet are standard on the TPMC-17-CH-L, providing for seamless communications with Crestron control systems, computers, digital media servers, and other IP-based devices. Wi-Fi wireless networking and memory expansion are easily added through two PC card slots, and

Isys i/O ingeniously integrates touchpanel control with embedded PC functionality, delivering a unified solution for controlling AV and home automation, browsing the Internet, and streaming digital media. Incorporating modern styling in a versatile flush mount design, the TPMC-17-CH-L Touchpanel Media Center features a spectacular 17" WXGA widescreen display offering an extra wide viewing angle with exceptional brightness and contrast for stunning control graphics, high-res images, embedded PC applications, and full-motion HD video.

Enhanced Touchpanel Control—In every sense, the TPMC-17-CH-L is a true Crestron touchpanel, offering vibrant 24-bit color depth with 8-bit alpha channel transparency to produce incredible 3D graphics using new dynamic menu objects, dynamic graphics, full-motion animations, multimode objects, PNG translucency, and exclusive Synapse™ image rendering – all with astonishing speed. But more than a touchpanel, the TPMC-17-CH-L is also a dynamic resource for managing routine online tasks and enjoying streaming music and video, and a high-resolution video monitor with performance rivaling the best LCD flat-panel displays available.

Embedded PC—The power of Isys i/O is in its embedded PC engine, combining rock solid touchpanel performance with enhanced capabilities for surfing the Internet, streaming digital media, and viewing online documents. Running the Microsoft® Windows® XP Embedded operating system, Isys i/O delivers a powerful and secure platform for touchpanel control with integrated PC functionality. Programmatic control erases the lines between control system and PC, allowing programmers to customize each application's behavior within the touchpanel environment to create a truly powerful and user-friendly interface.

ISYS® WALL MOUNT TOUCHPANELS

→ Isys i/O™ Wall Mount Touchpanel Media Centers

Isys i/O™ 17" Wall Mount Touchpanel Media Center w/CH CAT5 AV TPMC-17-CH-L

two USB ports enable the connection of an external mouse and keyboard (not included), as well as USB cameras, CD ROM drives, and memory devices.¹

Versatile Flush Mount Design—The TPMC-17-CH-L is designed for flush-mount installation in a wall, lectern or similar flat surface. A variety of mounting accessories is offered including optional back box and 19" rack mount kit. Five backlit pushbuttons are also provided, allowing for quick access to commonly used functions.

- ▶ 17" widescreen active matrix touchscreen display | 1280 x 768 resolution
- ▶ 24-Bit Isys i/O graphics | Synapse image rendering algorithm
- ▶ Windows XP Embedded operating system
- ▶ Onboard PC applications for Web browsing, streaming media, conferencing, VoIP, and remote desktop – no computer required!
- ▶ High-performance dual-window HD video display²
- ▶ Built-in 10 watt biamplified speaker system and microphone
- ▶ Crestron Home CAT5 AV connectivity
- ▶ Secure high-speed Ethernet and Cresnet communications
- ▶ Wall, lectern, and rack mounting options
- ▶ Available in black or white

TPMC-17-CH-L using CAT5 AV Interface Module

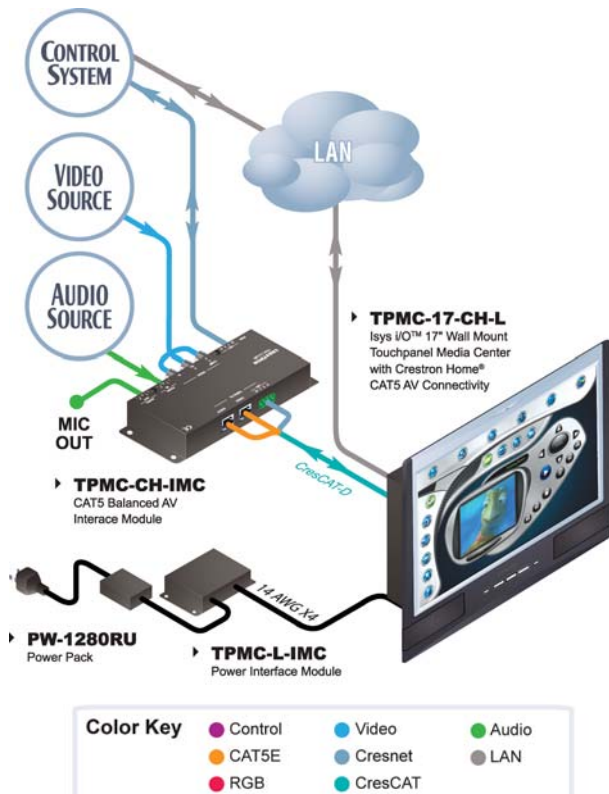

AVAILABLE MODELS

TPMC-17-CH-LB

Isys i/O 17" Wall Mount Touchpanel Media Center, Black

TPMC-17-CH-LW

Isys i/O 17" Wall Mount Touchpanel Media Center, White

SPECIFICATIONS

Touchscreen Display

Display Type: TFT Active matrix color LCD
Size: 17 inch (43.2 cm) diagonal widescreen
Aspect Ratio: 15:9 WXGA
Resolution: 1280 x 768 pixels
Brightness: 450 nits (cd/m²)
Contrast: 400:1
Color Depth: 24-bit, 16.7M colors
Illumination: Backlit fluorescent
Viewing Angle: ±88° horizontal, ±88° vertical
Touchscreen: Resistive membrane

Processor

VIA Eden™ 667 MHz CPU

Memory

SDRAM: 512 MB
Flash: 512 MB
PC Card: Accepts up to (2) 4GB Type II PC Cards (not included)
Maximum Project Size: 190 MB

Operating System

Microsoft® Windows® XP Embedded

Graphic Engine

Isys i/O engine, VIA Unichrome™ CLE266 chipset, 24-bit non-palette graphics + 8-bit alpha channel transparency, 16.7 million colors, Synapse image rendering algorithm, multi-mode objects, dynamic menu objects, dynamic graphics, PNG translucency, full-motion (60 fps) animation, transition effects, color key video windowing

Embedded Software Applications¹

Microsoft Internet Explorer w/Macromedia® Flash® plug-in, Windows Media® Player, RealPlayer®, Axis® Media Control, Crestron MediaMarker™, Remote Desktop, NetMeeting®, Skype™, Java™ Runtime, DirectX®, Yahoo! Widgets®, Adobe® Acrobat® Reader, and viewers for MS Word, Excel, and PowerPoint®

Ethernet

10BaseT/100BaseTX, auto-negotiating, full/half duplex TCP/IP, UDP/IP, CIP, DHCP, IEEE 802.3U compliant

Wireless

Wireless Ethernet capable using third-party 802.11 PC card¹ (Wired connections required for power, audio, and video)

> continued

TPMC-17-CH-L Isys i/O™ 17" Wall Mount Touchpanel Media Center w/CH CAT5 AV

Video

Signal Types: Auto-detecting composite, S-Video, or component

Formats: SDTV 480i (NTSC) & 576i (PAL), EDTV 480p & 576p, HDTV 720p & 1080i

Color Depth: 24-bit, 16.7M colors

Features: Dual-window² each scalable to full-screen, time base correction, gamma correction, line doubling, motion adaptive deinterlacing, reverse 3:2/2:2 pull-down

Streaming/File Formats: MPEG4 and MJPEG via Axis Media control plus all formats supported by the embedded media player applications¹

Audio

Hardware Features: Built-in microphone and amplified speakers, stereo headphone output, internal volume control and audio mixer

Streaming/File Formats: All formats supported by the embedded media player applications¹

Audio Feedback (WAV): 8 & 16 bit PCM, mono & stereo, 8 – 44 kHz sampling rates

Amplification: Bi-amplified, mono, 5 Watts for high-frequency, 5 Watts for low-frequency

Buttons

(4) Backlit "softkey" buttons, programmable

(1) Backlit hard reset button, reboots the touchpanel system

Connectors

CH VIDEO IN 1 – 2: (2) 8-wire RJ45 female CAT5 balanced video input ports

Signal Types: Auto-detecting component (YPbPr), S-Video (Y/C), or composite video;

Formats: SDTV 480i (NTSC) & 576i (PAL), EDTV 480p & 576p, HDTV 720p & 1080i;

Input Impedance: 100 ohms balanced

Connect to any Crestron CAT5 balanced video source(s) or TPMC-CH-IMC interface module (included) via CresCAT cable or TPS/TPMC-CBL-T "triamese" cable (sold separately);

Maximum Cable Length: 500 feet for component/HDTV, 750 feet for composite/S-Video

CH AUDIO I/O: (1) 8-wire RJ45 female

Bidirectional CAT5 balanced audio port

Signal Types: Receives (1) balanced stereo audio signal, and transmits (1) balanced stereo audio signal from internal PC or microphone (dynamically selectable);

Maximum Input Level: 4 V_{RMS}

Maximum Output Level: 2 V_{RMS}

Input/Output Impedance: 600 ohms

Connects to any other Crestron CAT5 balanced audio port or TPMC-CH-IMC interface module (included) via CresCAT cable or TPS/TPMC-CBL-T "triamese" cable (sold separately);

Maximum Cable Length: 1000 feet

HEADPHONES: (1) 3.5 mm TRS mini phone jack

Output Power: 105 mW per channel

Minimum Impedance: 8 ohms

USB: (2) USB Type A female, USB 1.1 ports for mouse, keyboard, and storage devices¹

RS-232: (1) 6-pin RJ11 female, computer console port

Bidirectional RS-232 up to 115.2k baud

Hardware and software handshaking support

PC CARD A – B: (2) Type II PC Card slots for memory expansion, project upload, and wireless NIC¹

ETHERNET: (1) 8-wire RJ45 with 2 LED indicators

10BaseT/100BaseTX Ethernet port

Green LED indicates network speed

Yellow LED indicates Ethernet activity

NET: (1) 4-pin 3.5mm detachable terminal block

Cresnet Slave Port (data only, 24V terminal not used)

Connects to Cresnet control network, or TPMC-CH-IMC interface module (included) via CresCAT, Cresnet, or TPS/TPMC-CBL-T "triamese" cable (sold separately)

PWR: (1) 4-pin DC power jack, 12.5V DC power input

(external power supply included)

PWR OUT: (1) 4-pin DC power jack

Connects to PWR jack using 9-inch 4-pin DC power patch cable (included) when locating power supply remotely, passes 12.5V DC power from PWR IN terminal blocks

PWR IN: (2) 2-pin detachable terminal blocks, paralleled

Used to extend power cabling up to 60 feet using 4 conductor,

14 AWG wire connected to a TPMC-L-IMC power interface

module (included) at remote power supply location

G: (1) 6-32 screw, chassis ground lug

Power Requirements

TPMC-17-CH-L: 8.4 Amps @ 12.5 Volts DC

External Power Supply (included):

2.2 Amps @ 100-250 Volts AC, 50/60 Hz

Cresnet Power Usage: 0 Watt @ 24 Volts DC

Environmental

Temperature: 50° to 113°F (10° to 45°C)

Humidity: 10% to 90% RH (non-condensing)

Enclosure

Construction: Metal, flush mountable, 9U 19" rack-mountable (all mounting kits sold separately)

Front Bezel: Injection-molded plastic; black w/silver or white w/gray accent

Dimensions

Height: 13.81 in (35.06 cm)

Width: 16.98 in (43.11 cm)

Depth: 3.84 in (9.74 cm)

Weight

13.4 lbs (6.10 kg)

ISYS® WALL MOUNT TOUCHPANELS

→ Isys i/O™ Wall Mount Touchpanel Media Centers

Isys i/O™ 17" Wall Mount Touchpanel Media Center w/CH CAT5 AV **TPMC-17-CH-L**

INCLUDED ACCESSORIES

(See individual product specifications for complete information.)

TPMC-CH-IMC

CAT5 Balanced AV Interface Module

TPMC-L-IMC

Power Interface Module

PW-1280RU

Power Supply

¹ See Web site or contact Crestron for a current list of compatible devices and embedded applications. To ensure reliable performance, new device drivers and applications are available only from Crestron through firmware updates.

² Additional CAT5 Balanced AV equipment is required to facilitate the input of more than one external video signal. See the "Audio Video Distribution and Surround Sound" section of this catalog or visit the Crestron Website for more information about Crestron Home CAT5 Balanced AV.

TPMC-17-CH-L in a CAT5 AV Distribution System

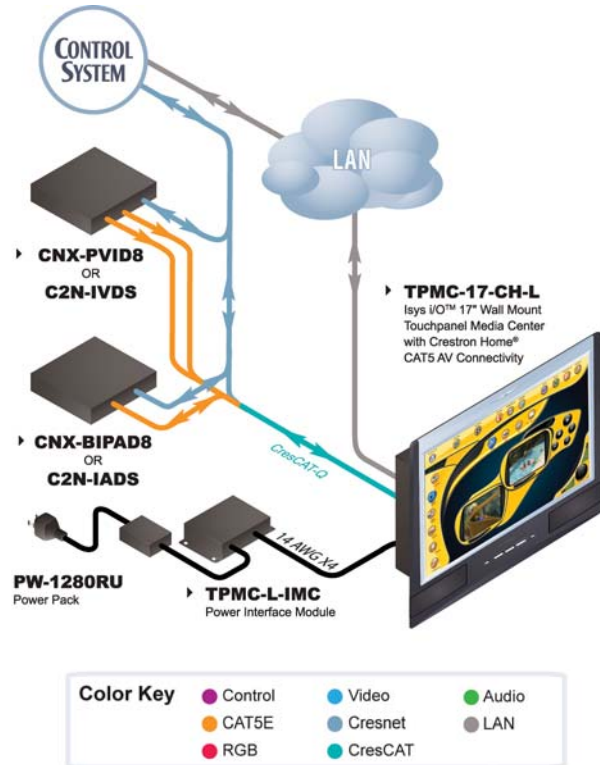

Wall mount touchpanels

AVAILABLE ACCESSORIES

- ▶ **BB-17L**
Pre-Construction
Wall Mount Back Box
- ▶ **MMK-17L**
Mud Ring
- ▶ **RMK-17L**
Rack Mount Kit
- ▶ **TPS/TPMC-CBL-T**
Triamese Interface Cables
- ▶ **PMK-17L**
Pre-Construction
Wall Mount Kit
- ▶ **WMKT-17L**
Lectern Mount Kit
with Trim Ring
- ▶ **TPMC-CH-IMW**
CAT5 Balanced AV
Interface Wall Plate
- ▶ **CresCAT®Q**
Crestron Home® CAT5 AV Cable
- ▶ **TMK-17L**
Trim Ring

ISYS® WALL MOUNT TOUCHPANELS

→ Isys i/O™ Wall Mount Touchpanel Media Centers

TPMC-15-CH-L Isys i/O™ 15" Wall Mount Touchpanel Media Center w/CH CAT5 AV



With built-in Windows Media® Player, RealPlayer®, and Internet Explorer, plus viewers for Word, Excel, PowerPoint®, and Adobe® Acrobat®, the TPMC-15-CH-L provides everything needed for viewing Web pages, enjoying online music and movies, and downloading documents without necessitating a separate computer. You can also access data and run applications on other computers via Remote Desktop, and use NetMeeting® and Skype™ for interactive conferencing and voice-over-IP (VoIP) communications – right on the touchpanel. Plus, support for Yahoo! Widgets affords an easy solution for integrating everything from calendars and clocks to stock tickers, weather forecasts, news feeds, and thousands of other fun and useful utilities.

Dual-Window HD Video—In addition to its internal PC and streaming video applications, the TPMC-15-CH-L can also simultaneously display two fully-scalable, full-motion video windows. Each window supports standard video and HDTV formats from external sources. Discrete video scalers with motion adaptive deinterlacing bring out the highest detail, minimizing visible scan lines and motion artifacts for an incredible picture. Advanced gamma correction and built-in time base correction ensure accurate color reproduction and a jitter-free image.

High-Quality Audio—An integrated microphone, biamplified speakers, stereo headphone output, and PC audio output are all built into the touchpanel to support full AV, intercom, desktop conferencing, and multimedia computer capabilities. Customized WAV files can be loaded on the touchpanel to add dimension to the touchscreen graphics with personalized sounds, button feedback, and voice prompts.

Crestron Home® CAT5 AV—All audio and video connections are facilitated using inexpensive CAT5 wire, enabling direct connection to Crestron's popular CAT5 balanced audio and video distribution switchers. Two video input ports are provided, each supporting composite, S-Video, and HDTV/component formats over wiring distances of up to 500 feet. A bidirectional audio port receives stereo program audio and intercom signals, and outputs audio from the internal microphone and PC for intercom and whole-house audio distribution. To facilitate the connection of conventional video and audio devices, an external interface module is included.

Connectivity and Expansion—Both Cresnet and high-speed Ethernet are standard on the TPMC-15-CH-L, providing for seamless communications with Crestron control systems, computers, digital media servers, and other IP-based devices. Wi-Fi wireless networking and memory

Isys i/O ingeniously integrates touchpanel control with embedded PC functionality, delivering a unified solution for controlling AV and home automation, browsing the Internet, and streaming digital media. Incorporating modern styling in a versatile flush mount design, the TPMC-15-CH-L Touchpanel Media Center features a spectacular 15" XGA display offering an extra wide viewing angle with exceptional brightness and contrast for stunning control graphics, high-res images, embedded PC applications, and full-motion HD video.

Enhanced Touchpanel Control—In every sense, the TPMC-15-CH-L is a true Crestron touchpanel, offering vibrant 24-bit color depth with 8-bit alpha channel transparency to produce incredible 3D graphics using new dynamic menu objects, dynamic graphics, full-motion animations, multimode objects, PNG translucency, and exclusive Synapse™ image rendering – all with astonishing speed. But more than a touchpanel, the TPMC-15-CH-L is also a dynamic resource for managing routine online tasks and enjoying streaming music and video, and a high-resolution video monitor with performance rivaling the best LCD flat-panel displays available.

Embedded PC—The power of Isys i/O is in its embedded PC engine, combining rock solid touchpanel performance with enhanced capabilities for surfing the Internet, streaming digital media, and viewing online documents. Running the Microsoft® Windows® XP Embedded operating system, Isys i/O delivers a powerful and secure platform for touchpanel control with integrated PC functionality. Programmatic control erases the lines between control system and PC, allowing programmers to customize each application's behavior within the touchpanel environment to create a truly powerful and user-friendly interface.

ISYS® WALL MOUNT TOUCHPANELS

→ Isys i/O™ Wall Mount Touchpanel Media Centers

Isys i/O™ 15" Wall Mount Touchpanel Media Center w/CH CAT5 AV **TPMC-15-CH-L**

expansion are easily added through two PC card slots, and two USB ports enable the connection of an external mouse and keyboard (not included), as well as USB cameras, CD ROM drives, and memory devices.¹

Versatile Flush Mount Design—The TPMC-15-CH-L is designed for easy flush-mount installation in a wall, lectern or similar flat surface. A variety of mounting accessories is offered including optional back box and 19" rack mount kit. Five backlit pushbuttons are also provided, allowing for quick access to commonly used functions.

- ▶ 15" active matrix touchscreen display | 1024 x 768 resolution
- ▶ 24-Bit Isys i/O graphics | Synapse image rendering algorithm
- ▶ Windows XP Embedded operating system
- ▶ Onboard PC applications for Web browsing, streaming media, conferencing, VoIP, and remote desktop – no computer required!
- ▶ High-performance dual-window HD video display²
- ▶ Built-in 10 watt biamplified speaker system and microphone
- ▶ Crestron Home CAT5 AV connectivity
- ▶ Secure high-speed Ethernet and Cresnet communications
- ▶ Wall, lectern, and rack mounting options
- ▶ Available in black or white

AVAILABLE MODELS

TPMC-15-CH-LB

Isys i/O 15" Wall Mount Touchpanel Media Center, Black

TPMC-15-CH-LW

Isys i/O 15" Wall Mount Touchpanel Media Center, White

SPECIFICATIONS

Touchscreen Display

Display Type: TFT Active matrix color LCD
Size: 15 inch (38.1 cm) diagonal
Aspect Ratio: 4:3 XGA
Resolution: 1024 x 768 pixels
Brightness: 350 nits (cd/m²)
Contrast: 700:1
Color Depth: 24-bit, 16.7M colors
Illumination: Backlit fluorescent
Viewing Angle: ±85° horizontal, ±85° vertical
Touchscreen: Resistive membrane

Processor

VIA Eden™ 667 MHz CPU

Memory

SDRAM: 512 MB
Flash: 512 MB
PC Card: Accepts up to (2) 4GB Type II PC Cards (not included)
Maximum Project Size: 190 MB

Operating System

Microsoft® Windows® XP Embedded

Graphic Engine

Isys i/O engine, VIA Unichrome™ CLE266 chipset, 24-bit non-palette graphics + 8-bit alpha channel transparency, 16.7 million colors, Synapse image rendering algorithm, multi-mode objects, dynamic menu objects, dynamic graphics, PNG translucency, full-motion (60 fps) animation, transition effects, color key video windowing

Embedded Software Applications¹

Microsoft Internet Explorer w/Macromedia® Flash® plug-in, Windows Media® Player, RealPlayer®, Axis® Media Control, Crestron MediaMarker™, Remote Desktop, NetMeeting®, Skype™, Java™ Runtime, DirectX®, Yahoo! Widgets®, Adobe® Acrobat® Reader, and viewers for MS Word, Excel, and PowerPoint®

Ethernet

10BaseT/100BaseTX, auto-negotiating, full/half duplex TCP/IP, UDP/IP, CIP, DHCP, IEEE 802.3U compliant

Wireless

Wireless Ethernet capable using third-party 802.11 PC card¹ (Wired connections required for power, audio, and video)

TPMC-17-CH-L using CAT5 AV Interface Module

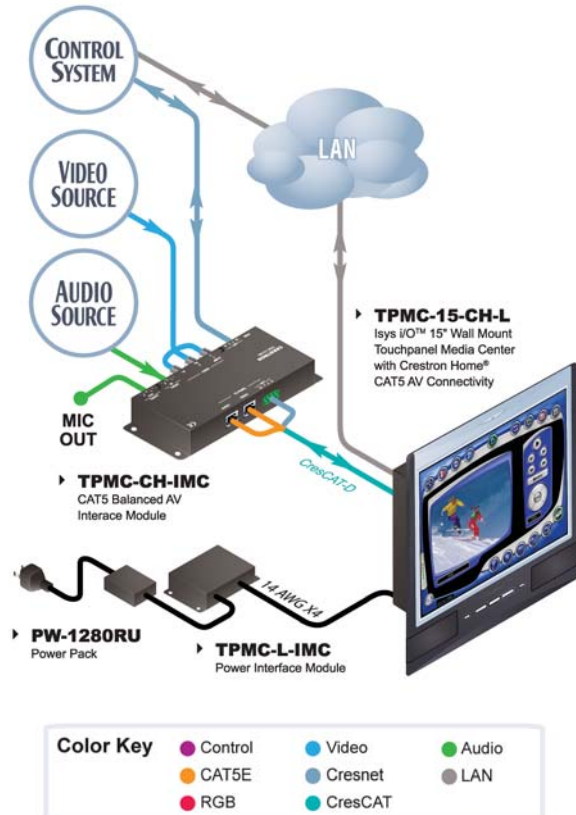

> continued

TPMC-15-CH-L Isys i/O™ 15" Wall Mount Touchpanel Media Center w/CH CAT5 AV

Video

Signal Types: Auto-detecting composite, S-Video, or component

Formats: SDTV 480i (NTSC) & 576i (PAL), EDTV 480p & 576p, HDTV 720p & 1080i

Color Depth: 24-bit, 16.7M colors

Features: Dual-window² each scalable to full-screen, time base correction, gamma correction, line doubling, motion adaptive deinterlacing, reverse 3:2/2:2 pull-down

Streaming/File Formats: MPEG4 and MJPEG via Axis Media control plus all formats supported by the embedded media player applications¹

Audio

Hardware Features: Built-in microphone and amplified speakers, stereo headphone output, internal volume control and audio mixer

Streaming/File Formats: All formats supported by the embedded media player applications¹

Audio Feedback (WAV): 8 & 16 bit PCM, mono & stereo, 8 – 44 kHz sampling rates

Amplification: Amplified, mono, 5 Watts for high-frequency, 5 Watts for low-frequency

Buttons

(4) Backlit "softkey" buttons, programmable

(1) Backlit hard reset button, reboots the touchpanel system

Connectors

CH VIDEO IN 1 – 2: (2) 8-wire RJ45 female CAT5 balanced video input ports

Signal Types: Auto-detecting component (YPbPr), S-Video (Y/C), or composite video;

Formats: SDTV 480i (NTSC) & 576i (PAL), EDTV 480p & 576p, HDTV 720p & 1080i;

Input Impedance: 100 ohms balanced

Connect to any Crestron CAT5 balanced video source(s) or TPMC-CH-IMC interface module (included) via CresCAT cable or TPS/TPMC-CBL-T "triamese" cable (sold separately);

Maximum Cable Length: 500 feet for component/HDTV, 750 feet for composite/S-Video

CH AUDIO I/O: (1) 8-wire RJ45 female

Bidirectional CAT5 balanced audio port

Signal Types: Receives (1) balanced stereo audio signal, and transmits (1) balanced stereo audio signal from internal PC or microphone (dynamically selectable);

Maximum Input Level: 4 V_{RMS}

Maximum Output Level: 2 V_{RMS}

Input/Output Impedance: 600 ohms

Connects to any other Crestron CAT5 balanced audio port or TPMC-CH-IMC interface module (included) via CresCAT cable or TPS/TPMC-CBL-T "triamese" cable (sold separately);

Maximum Cable Length: 1000 feet

HEADPHONES: (1) 3.5 mm TRS mini phone jack

Output Power: 105 mW per channel

Minimum Impedance: 8 ohms

USB: (2) USB Type A female, USB 1.1 ports for mouse, keyboard, and storage devices¹

RS-232: (1) 6-pin RJ11 female, computer console port

Bidirectional RS-232 up to 115.2k baud

Hardware and software handshaking support

PC CARD A – B: (2) Type II PC Card slots for memory expansion, project upload, and wireless NIC¹

ETHERNET: (1) 8-wire RJ45 with 2 LED indicators

10BaseT/100BaseTX Ethernet port

Green LED indicates network speed

Yellow LED indicates Ethernet activity

NET: (1) 4-pin 3.5mm detachable terminal block

Cresnet Slave Port (data only; 24V terminal not used)

Connects to Cresnet control network, or TPMC-CH-IMC interface module (included) via CresCAT, Cresnet, or TPS/TPMC-CBL-T "triamese" cable (sold separately)

PWR: (1) 4-pin DC power jack, 12.5V DC power input

(external power supply included)

PWR OUT: (1) 4-pin DC power jack

Connects to PWR jack using 9-inch 4-pin DC power patch cable (included) when locating power supply remotely; passes 12.5V DC power from PWR IN terminal blocks

PWR IN: (2) 2-pin detachable terminal blocks, paralleled

Used to extend power cabling up to 60 feet using 4 conductor, 14 AWG wire connected to a TPMC-L-IMC power interface module (included) at remote power supply location

G: (1) 6-32 screw, chassis ground lug

Power Requirements

TPMC-15-CH-L: 8.4 Amps @ 12.5 Volts DC

External Power Supply (included):

2.2 Amps @ 100-250 Volts AC, 50/60 Hz

Cresnet Power Usage: 0 Watt @ 24 Volts DC

Environmental

Temperature: 50° to 113°F (10° to 45°C)

Humidity: 10% to 90% RH (non-condensing)

Enclosure

Construction: Metal, flush mountable, 8U 19" rack-mountable (all mounting kits sold separately)

Front Bezel: Injection-molded plastic; black w/silver or white w/gray accent

Dimensions

Height: 13.59 in (34.52 cm)

Width: 14.17 in (35.99 cm)

Depth: 3.80 in (9.66 cm)

Weight

10.0 lbs (4.50 kg)

ISYS® WALL MOUNT TOUCHPANELS

► Isys i/O™ Wall Mount Touchpanel Media Centers

Isys i/O™ 15" Wall Mount Touchpanel Media Center w/CH CAT5 AV **TPMC-15-CH-L**

INCLUDED ACCESSORIES

(See individual product specifications for complete information.)

TPMC-CH-IMC

CAT5 Balanced AV Interface Module

TPMC-L-IMC

Power Interface Module

PW-1280RU

Power Supply

¹ See Web site or contact Crestron for a current list of compatible devices and embedded applications. To ensure reliable performance, new device drivers and applications are available only from Crestron through firmware updates.

² Additional CAT5 Balanced AV equipment is required to facilitate the input of more than one external video signal. See the "Audio Video Distribution and Surround Sound" section of this catalog or visit the Crestron Website for more information about Crestron Home CAT5 Balanced AV.

TPMC-15-CH-L in a CAT5 AV Distribution System

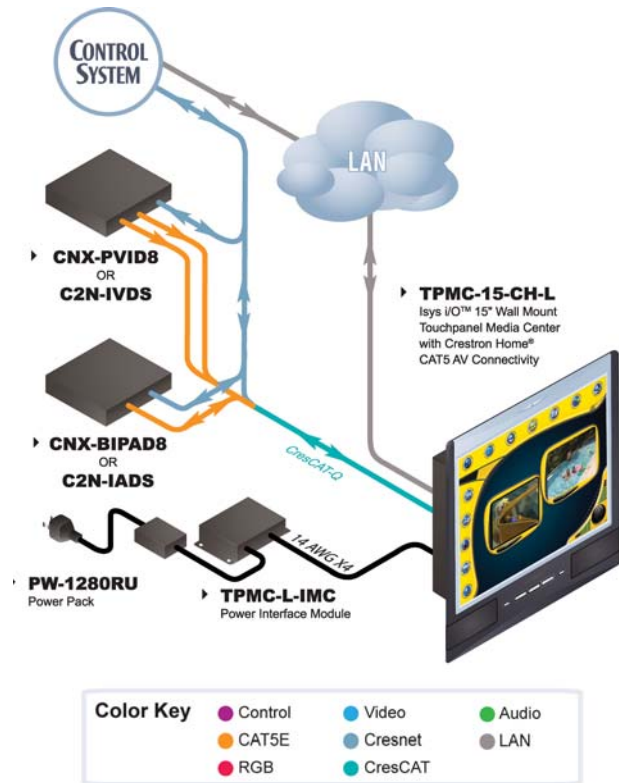

Wall mount touchpanels

AVAILABLE ACCESSORIES

- | | | | |
|--|--|--|--|
| ▶ BB-15L
Pre-Construction
Wall Mount Back Box | ▶ MMK-15L
Mud Ring | ▶ RMK-15L
Rack Mount Kit | ▶ TPS/TPMC-CBL-T
Triamese Interface Cables |
| ▶ PMK-15L
Pre-Construction
Wall Mount Kit | ▶ WMKT-15L
Lectern or Post-Construction
Wall Mount Kit with Trim Ring | ▶ TPMC-CH-IMW
CAT5 Balanced AV
Interface Wall Plate | ▶ CresCAT®Q
Crestron Home® CAT5 AV Cable |
| ▶ TMK-15L
Trim Ring | ▶ WMKM-15L
Post-Construction Wall
Mount Kit with Mud Ring | | |

POWER SUPPLIES

PW-1280RU Regulated Universal Power Pack 12.5V DC, 8A

The PW-1280RU is the universal regulated power pack that is included as standard with every Isys i/O 15" and 17" Touchpanel Media Center. Designed for US/International use.

SPECIFICATIONS

Connections

AC Input: (1) IEC320 male socket
Mates with removable 120V AC power cord, included

DC Output: (1) Attached 8 ft. (2.44 m) cable with 4-pin DC power plug, male;
Output: 7.92 Amps minimum @ 12.5 Volts DC, regulated
Connects to PWR jack of touchpanel, or PWR IN jack of TPMC-L-IMC if used

Power Requirements

2.2 Amps @ 100-250 Volts AC, 50/60 Hz

Enclosure

Black plastic, desktop



PW-2420RU Regulated Universal Power Pack 24VDC, 2A (50 Watts)

The PW-2420RU is a 2 Amp regulated power supply designed to provide 24 Volts DC to power some models of Crestron control systems and touchpanels. Generally, the PW-2420RU may be used to power nearly any Cresnet device(s) provided the total combined power factor does not exceed 50 Watts. For US/International use.

SPECIFICATIONS

Connectors

AC Input: (1) IEC320 male socket
Mates with removable 120V AC power cord, included

DC Output: (1) Attached cable with 2.1mm barrel-type DC connector, male; center pin +;
Output: 50 Watts (2 Amp @ 24 Volts DC) regulated

Power Requirements

100-250 Volts AC, 50/60 Hz

Enclosure

Black plastic, desktop



INTERFACE MODULES AND CABLES

QM-TX QuickMedia™ Transmitter

The QM-TX provides a low-cost multimedia interface solution for QuickMedia-based Touchpanels and MediaManager systems. Portable or rack-mounted, the QM-TX can be used to send audio, video, and computer signals to any QM-equipped touchpanel via Crestron's exclusive single-wire QuickMedia transport.

Five BNC's are provided on the QM-TX to accept composite, S-Video, component, HDTV, or RGB signals (up to 1600 x 1200 at 60 Hz). Balanced stereo line-level audio signals are transmitted simultaneously with 24-bit digital resolution. Video formats can be switched dynamically and automatically under system control. The QM-TX is 1/2-space rack-mountable using the optional ST-RMK kit.



- NET:** (2) 4-pin 3.5mm detachable terminal blocks
Cresnet slave ports, paralleled
Connect to Cresnet control network
- G:** (1) 6-32 screw, chassis ground lug

LED Indicators

- PWR:** (green) Indicates DC power supplied from Cresnet network
- NET:** (yellow) Indicates communication with Cresnet system
- VIDEO ACT:** (red) Indicates presence of a valid video input signal
- SETUP (rear):** (red) Used for touch-settable ID (TSID)

Controls

- SETUP:** (1) Button for touch-settable ID (TSID)

Power Requirements

- Cresnet Power Usage:** 5 Watts (0.21 Amp @ 24 Volts DC)

Environmental

- Temperature:** 41° to 104°F (5° to 40°C)
- Humidity:** 10% to 90% RH (non-condensing)

Enclosure

- Black metal, 0.5U 19" rack-mountable using optional ST-RMK (sold separately)

Dimensions

- Height:** 1.80 in (4.57 cm)
- Width:** 7.07 in (17.96 cm)
- Depth:** 7.02 in (17.83 cm)

Weight

- 2.05 lbs (0.93 kg)

AVAILABLE ACCESSORIES

ST-RMK

Rack Mount Kit

* For QuickMedia wiring use CresCAT-QM or -IM cable; the maximum aggregate cable length and delay skew between any QM transmitter (origination point) and QM receiver (endpoint) is 450 ft (137 m) and 22 nS.

SPECIFICATIONS

Video

- Gain:** 0dB (75 ohm termination)
- Bandwidth:** 100MHz (-3dB) at unity gain
- Formats:** Supports standard definition and HDTV up to 720p and 1080i

RGB

- Gain:** 0dB (75 ohm termination)
- Maximum Resolution:** 1600x1200 @ 60Hz (at unity gain) with cable length of 100 meters and maximum compensation at receiver (touchpanel)

Audio

- A-D Conversion:** Burr Brown 24-bit, 48 kHz
- Frequency Response:** 20Hz to 20kHz

Connectors

- R/C/P_R, G/Y/Y, B/COMP/P_B, H, V:** (5) BNC female RGB/Video input
- Formats: RGBHV, RGBS, RGsB, YP_BP_R, S-Video (Y/C), composite;
- Input Impedance: 75 ohms (R/C/P_R, G/Y/Y, & B/COMP/P_B)
- Sync Impedance: 620 ohms (H and V)
- Maximum Input Voltage: 0.7 V_{P-P} for RGB and C of S-Video; 1 V_{P-P} for composite and Y of S-Video; 5 V_{P-P} for H and V Sync;
- Video signal sensing on Y, COMP, and H

- AUDIO:** (1) 5-pin 3.5mm detachable terminal block
- Balanced/unbalanced stereo line-level audio input
- Maximum Input Level: 4 V_{RMS} balanced, 2 V_{RMS} unbalanced;
- Input Impedance: 10k ohms balanced, 5k ohms unbalanced

- QM OUT:** (1) 8-wire RJ45 female, QuickMedia output port
- Connects to QM input port of touchpanel of other QuickMedia device via CresCAT-QM or CresCAT-IM cable*

INTERFACE MODULES AND CABLES

TPMC-CH-IMC CAT5 Balanced AV Interface Module

The TPMC-CH-IMC is an audio/video interface module that is included as standard with many Isys touchpanels that utilize Crestron Home (CH) CAT5 AV connectivity*. The interface module can connect to the touchpanel using a “triamese” interface cable (included with tilt model touchpanels) or using CresCAT-D cable (sold separately). Installed neatly out of view near the touchpanel, or mounted remotely in the central equipment cabinet, the TPMC-CH-IMC provides connections for Cresnet, bidirectional audio, and (1) video input signal. The balanced CAT5 AV outputs support cable runs up to 300 feet (observe distance limitations based upon power consumption for the touchpanel in use).

Additional interface modules may be purchased and installed to facilitate connectivity for a single movable touchpanel at multiple locations. The TPMC-CH-IMC can also be used as a CAT5 balanced AV interface for use with other Crestron CAT5 AV products.

SPECIFICATIONS

Connectors

NET: (1) 4-pin 3.5mm detachable terminal block
Cresnet slave port, connects to Cresnet control network

VIDEO COMP/Y/Y, C/P_B, P_R: (3) BNC female
Provides (1) composite, S-Video, or component video input
Input Impedance: 75 ohms
Input Level: 1 V_{P-P} nominal, 1.5 V_{P-P} maximum
Maximum DC Offset: 1.5 Volts

AUDIO IN: (1) 5-pin 3.5mm detachable terminal block
Balanced/unbalanced stereo line-level input
Input Impedance: 20k ohm balanced, 10k ohm unbalanced
Maximum Input Level: 4 V_{RMS} balanced, 2 V_{RMS} unbalanced

AUDIO OUT: (1) 5-pin 3.5mm detachable terminal block
Balanced stereo line-level output (unbuffered pass-thru from AUDIO TO PANEL)

AUDIO TO PANEL: (1) 8-pin RJ45 female
Bidirectional CAT5 balanced stereo audio port
Output Impedance: 100 ohms balanced
Maximum Output Level: 2 V_{RMS}
Input Impedance: Infinite (unbuffered pass-thru to AUDIO OUT)



VIDEO TO PANEL: (1) 8-pin RJ45 female
CAT5 balanced video output port
Output Impedance: 100 ohms balanced

NET TO PANEL: (1) 4-pin 3.5mm detachable terminal block
Pass-thru from NET port

LED Indicators

PWR: (green) Indicates power supplied from
Cresnet network

Power Requirements

Cresnet Power Usage: 2 Watts
(0.08 Amps @ 24 Volts DC)

Environmental

Temperature: 41° to 122°F (5° to 50°C)
Humidity: 10% to 90% RH (non-condensing)

Enclosure

Black metal, surface mount box with (2) integral
mounting flanges

Dimensions

Height: 1.29 in (3.28 cm)
Width: 7.30 in (18.54 cm)
Depth: 3.95 in (10.03 cm)

Weight

9.7 oz (0.28 kg)

**The TPMC-CH-IMC is not compatible with QuickMedia or 10-pin RJ45 based systems.*

INTERFACE MODULES AND CABLES

TPMC-L-IMC Power Interface Module

The TPMC-L-IMC is a power interface module that is included with the TPMC-15-CH-L, TPMC-15-QM-L, TPMC-17-CH-L, and TPMC-17-QM-L Wall Mount Touchpanel Media Centers. The TPMC-L-IMC is a passive device designed to facilitate the remote placement of the touchpanel's power supply up to 60 feet from the touchpanel using any 14 AWG, 4-conductor wire including ordinary speaker wire.



SPECIFICATIONS

Connectors

PWR IN: (1) 4-pin DC power jack
Connects to 12.5 Volt DC output of PW-1280RU power supply (included with touchpanel)

PWR OUT: (2) 2-pin 7.62mm detachable terminal blocks, paralleled;
Used to extend power cabling to a TPMC-15-(CH or QM)-L or TPMC-17-(CH or QM)-L wall mount touchpanel up to 60 feet using 4 conductor, 14 AWG wire

LED Indicators

PWR: (1) green LED, indicates 12.5 Volts DC power supplied from PW-1280RU power supply (included with touchpanel)

Environmental

Temperature: 41° to 122°F (5° to 50°C)
Humidity: 10% to 90% RH (non-condensing)

Enclosure

Black metal, surface mount box with (2) integral mounting flanges

Dimensions

Height: 1.05 in (2.67 cm)
Width: 3.43 in (8.70 cm)
Depth: 2.23 in (5.66 cm)

INTERFACE MODULES AND CABLES

TPMC-CH-IMW CAT5 Balanced AV Interface Wall Plate

The TPMC-CH-IMW is a wall plate version of the TPMC-CH-IMC interface module, providing a wall plate connection for new Isys® TPS and TPMC-CH series touchpanels that utilize Crestron Home® (CH) CAT5 Balanced AV connectivity*. It mounts into a 2-gang electrical box and includes front panel connections for a single “triamese” cable (provided with the touchpanel or sold separately). Several TPMC-CH-IMW wall plates may be installed to facilitate connectivity for a single movable touchpanel at multiple locations.

Wired as part of a complete Crestron Home CAT5 AV distribution system, the TPMC-CH-IMW requires just a single CresCAT-D cable, carrying Cresnet, bidirectional audio, and (1) video signal up to 500 feet within a single bundled cable (observe distance limitations based upon power consumption for the touchpanel in use). The TPMC-CH-IMW can also be connected to conventional audio and coaxial video sources.

SPECIFICATIONS

Connectors - Front Panel

NET: (1) 4-pin 3.5mm detachable terminal block, pass-thru from rear NET port

AUDIO: (1) 8-pin RJ45 female
Bidirectional CAT5 balanced stereo audio port
Output Impedance: 100 ohms balanced
Maximum Output Level: 2 V_{RMS}
Input Impedance: Infinite (unbuffered pass-thru to rear AUDIO OUT port)

VIDEO: (1) 8-pin RJ45 female
CAT5 balanced video output port
Output Impedance: 100 ohms balanced

Connectors - Rear Panel

NET: (1) 4-pin 5mm detachable terminal block;
Cresnet slave port, connects to Cresnet control network

VIDEO COMP/Y/Y, C/Pb, Pr: (1) 9-pin 3.5mm detachable terminal block;
Provides (1) composite, S-Video, or component video input
Input Impedance: 100 ohms balanced (also accepts 75 ohm unbalance);
Input Level: 1 V_{P-P} nominal, 1.5 V_{P-P} maximum
Maximum DC Offset: 1.5 Volts
Connects to any Crestron CAT5 Video Out port via CresCAT cable, or a conventional coax video source

AUDIO IN: (1) 5-pin 3.5mm detachable terminal block
Balanced/unbalanced stereo line-level input
Input Impedance: 20k ohm balanced, 10k ohm unbalanced



Maximum Input Level: 4 V_{RMS} balanced, 2 V_{RMS} unbalanced
Connects to any Crestron CAT5 Audio port via CresCAT cable, or a conventional audio source

AUDIO OUT: (1) 5-pin 3.5mm detachable terminal block
Balanced stereo line-level output (unbuffered pass-thru from front AUDIO port);
Connects to any Crestron CAT5 Audio port via CresCAT cable, or a conventional balanced audio input

LED Indicators

PWR: (green) Indicates 24 Volts DC power supplied from Cresnet control network

Power Requirements

Cresnet Power Usage: 2 Watts
(0.08 Amps @ 24 Volts DC)

Environmental

Temperature: 41° to 122°F (5° to 50°C)
Humidity: 10% to 90% RH (non-condensing)

Enclosure

2-gang mountable in a standard electrical box (2.5 inch deep minimum); includes black metal front panel Decora® inserts; requires Decora faceplate (provided by others)

Dimensions

Height: 4.11 in (10.44 cm)
Width: 3.50 in (8.89 cm)
Depth: 1.66 in (4.22 cm)

Weight

7.5 oz (0.21 kg)

**The TPMC-CH-IMW is not compatible with QuickMedia or 10-pin RJ45 based systems.*

INTERFACE MODULES AND CABLES

TPS/TPMC-CBL-T Triamese Cables for New Isys Touchpanels

The TPS/TPMC-CBL-T series of “triamese” cables provides a clean, flexible cable solution for Crestron’s new series of Isys 12”, 15” and 17” touchpanels. Available in 3, 6 and 9 foot lengths, these cables are designed primarily for use in combination with the TPMC-CH-IMC interface module. A single TPS/TPMC-CBL-T cable may be used in place of the 15 ft cable furnished with certain tilt model touchpanels, and is also compatible with comparable wall mount models wherever a short pre-made cable solution is called for.

Each triamese cable is composed of a single Cresnet cable terminated on each end with a 3.5mm terminal block connector, and two (2) CAT5e cables each terminated with 8-pin RJ45 connectors, providing connections for Cresnet data and power, plus bidirectional audio and (1) video signal between the module and the touchpanel.

TPS/TPMC-CBL-T cables may also be used with QuickMedia-based touchpanels to provide a clean cable solution between the touchpanel and any compatible QuickMedia interface device. These cables are not compatible with older 10-pin RJ45 based touchpanels or interface modules.



AVAILABLE MODELS

TPS/TPMC-CBL-T3-B

3 foot (0.9 meters) Triamese Cable, Black

TPS/TPMC-CBL-T3-W

3 foot (0.9 meters) Triamese Cable, White

TPS/TPMC-CBL-T6-B

6 foot (1.8 meters) Triamese Cable, Black

TPS/TPMC-CBL-T6-W

6 foot (1.8 meters) Triamese Cable, White

TPS/TPMC-CBL-T9-B

9 foot (2.7 meters) Triamese Cable, Black

TPS/TPMC-CBL-T9-W

9 foot (2.7 meters) Triamese Cable, White

INTERFACE MODULES AND CABLES

ST-PK Programming Cable Kit

The ST-PK is a programming cable kit for SmarTouch™ wireless touchpanels and most Isys® touchpanels. It is used only for loading touchpanel files, updating firmware, and configuring the touchpanel prior to operation. The ST-PK may also be used to update firmware and adjust the digital audio signal processing in Crestron's 7.1 surround sound processors and room solution boxes.



SPECIFICATIONS

Cables

3.5mm to RJ11 Cable Assembly (CNSP-585)

Provides connection between a SmarTouch wireless touchpanel and the control processor via a RJ11 Cresnet port; may require an additional CNRJ11, ST-CNB, or C2N-HBLOCK accessory.

RJ11-to-RJ11 Cable plus RJ11-to-DB9F Adapter (STCP-502)

Provides connection between an Isys touchpanel, surround processor, or room solution box RS-232 port and PC COM port.

MOUNTING KITS

BB Back Boxes

BB-Series back boxes provide a recess-mounted steel enclosure for Isys wall mount touchpanels. Designed for pre-construction applications, these back boxes permit fastening to the studs of a framed wall prior to installation of sheet rock. An assortment of knockouts is provided to accommodate conduit fittings, and a blank cover plate is included with each model.

AVAILABLE MODELS

BB-17L

Back Box for New Isys 17" Wall Mount Touchpanels

Touchpanel Models:

TPS-17L, TPMC-17-QM-L, TPMC-17-CH-L

Dimensions (HWD):

14.34 x 17.00 x 3.31 in (36.42 x 43.17 x 8.41 cm)

BB-15L

Back Box for New Isys 15" Wall Mount Touchpanels

Touchpanel Models:

TPS-15L, TPS-15G-QM-L, TPMC-15-QM-L, TPMC-15-CH-L

Dimensions (HWD):

13.97 x 14.31 x 3.31 in (35.49 x 36.36 x 8.41 cm)

BB-12L

Back Box for New Isys 12" Wall Mount Touchpanels

Touchpanel Models:

TPS-12L, TPS-12G-QM-L

Dimensions (HWD):

12.17 x 13.75 x 3.31 in (30.92 x 34.92 x 8.41 cm)

BB-4000L

Back Box for Isys 10.4" Wall Mount Touchpanels

Touchpanel Models: TPS-4000L

Dimensions (HWD):

9.18 x 12.75 x 3.31 in (23.32 x 32.37 x 8.41 cm)

BB-3100L

Back Box for Isys 6.4" Wall Mount Touchpanels

Touchpanel Models: TPS-3100L

Dimensions (HWD):

6.69 x 9.34 x 3.31 in (16.97 x 23.73 x 8.41 cm)

BB-2000L

Back Box for Isys 5" Wall Mount Touchpanels

Touchpanel Models: TPS-2000L

Dimensions (HWD):

6.69 x 7.62 x 3.31 in (16.97 x 16.51 x 8.41 cm)

BB-4L

Back Box for Isys 3.6" Wall Mount Touchpanels

Touchpanel Models: TPS-4L

Dimensions (HWD):

5.79 x 6.93 x 3.31 in (14.71 x 17.60 x 8.41 cm)



AVAILABLE ACCESSORIES

TMK

Trim Rings

MMK

Mud Rings

Note: Dimensions shown do not include mounting brackets; consult the installation manual for actual cutout dimensions, clearances, and complete mounting instructions.

MOUNTING KITS

PMK Pre-Construction Mounting Kits

PMK-Series mounting kits provide a nail-in solution for installing Isys wall mount touchpanels. Designed for pre-construction applications, these mounting kits permit fastening to the studs of a framed wall prior to installation of sheet rock. A blank cover plate is included with each model.

AVAILABLE MODELS

PMK-17L

Pre-construction Mounting Kit for New Isys 17" Wall Mount Touchpanels

Touchpanel Models: TPS-17L, TPMC-17-QM-L, TPMC-17-CH-L

PMK-15L

Pre-construction Mounting Kit for New Isys 15" Wall Mount Touchpanels

Touchpanel Models: TPS-15L, TPS-15G-QM-L, TPMC-15-QM-L, TPMC-15-CH-L

PMK-12L

Pre-construction Mounting Kit for New Isys 12" Wall Mount Touchpanels

Touchpanel Models: TPS-12L, TPS-12G-QM-L

PMK-4000L

Pre-construction Mounting Kit for Isys 10.4" Wall Mount Touchpanels

Touchpanel Models: TPS-4000L

PMK-3100L

Pre-construction Mounting Kit for Isys 6.4" Wall Mount Touchpanels

Touchpanel Models: TPS-3100L

PMK-2000L

Pre-construction Mounting Kit for Isys 5" Wall Mount Touchpanels

Touchpanel Models: TPS-2000L

PMK-4L

Pre-construction Mounting Kit for Isys 3.6" Wall Mount Touchpanels

Touchpanel Models: TPS-4L

AVAILABLE ACCESSORIES

TMK

Trim Rings

MMK

Mud Rings



MOUNTING KITS

TMK Trim Rings

TMK-Series trim rings are optional accessories designed for use with BB-Series back boxes and PMK-Series mounting kits to provide a smooth edge around the opening and compensate for minor drywall cutout imperfections.

AVAILABLE MODELS

TMK-17L

Trim Ring for BB-17L or PMK-17L

TMK-15L

Trim Ring for BB-15L or PMK-15L

TMK-12L

Trim Ring for BB-12L or PMK-12L

TMK-4000L

Trim Ring for BB-4000L or PMK-4000L

TMK-3100L

Trim Ring for BB-3100L or PMK-3100L

TMK-2000L

Trim Ring for BB-2000L or PMK-2000L

TMK-4L

Trim Ring for BB-4L or PMK-4L



MMK Mud Rings

MMK-Series mud rings are optional accessories designed for use with BB-Series back boxes and PMK-Series mounting kits to compensate for significant drywall cutout imperfections. The addition of a mud ring provides an appropriate surface for the application of plaster for a finished appearance.

AVAILABLE MODELS

MMK-17L

Mud Ring for BB-17L or PMK-17L

MMK-15L

Mud Ring for BB-15L or PMK-15L

MMK-12L

Mud Ring for BB-12L or PMK-12L

MMK-4000L

Mud Ring for BB-4000L or PMK-4000L

MMK-3100L

Mud Ring for BB-3100L or PMK-3100L

MMK-2000L

Mud Ring for BB-2000L or PMK-2000L

MMK-4L

Mud Ring for BB-4L or PMK-4L

MOUNTING KITS

WMKT Post-Construction Mounting Kits w/Trim Ring

WMKT-Series mounting kits provide a quick solution for installing Isys wall mount touchpanels in an existing wall or similar flat surface. Designed for post-construction applications, these mounting kits each include a TMK-Series trim ring to provide a smooth edge around the opening and compensate for minor drywall cutout imperfections.

WMKT-Series Mounting kits are also advised for lectern mount installations.

AVAILABLE MODELS

WMKT-17L*

Lectern Mounting Kit for New Isys 17" Wall Mount Touchpanels

Touchpanel Models:

TPS-17L, TPMC-17-QM-L, TPMC-17-CH-L

WMKT-15L

Post-construction Mounting Kit w/Trim Ring for New Isys 15" Wall Mount Touchpanels

Touchpanel Models:

TPS-15L, TPS-15G-QM-L, TPMC-15-QM-L, TPMC-15-CH-L

WMKT-12L

Post-construction Mounting Kit w/Trim Ring for New Isys 12" Wall Mount Touchpanels

Touchpanel Models: TPS-12L, TPS-12G-QM-L

WMKT-4000L

Post-construction Mounting Kit w/Trim Ring for Isys 10.4" Wall Mount Touchpanels

Touchpanel Models: TPS-4000L

WMKT-3100L

Post-construction Mounting Kit w/Trim Ring for Isys 6.4" Wall Mount Touchpanels

Touchpanel Models: TPS-3100L

WMKT-2000L

Post-construction Mounting Kit w/Trim Ring for Isys 5" Wall Mount Touchpanels

Touchpanel Models: TPS-2000L

WMKT-4L

Post-construction Mounting Kit w/Trim Ring for Isys 3.6" Wall Mount Touchpanels

Touchpanel Models: TPS-4L

** Due to weight considerations, the WMKT-17L is not intended for wall mount applications.*

MOUNTING KITS

WMKM Post-Construction Mounting Kits w/Mud Ring

WMKM-Series mounting kits provide a quick solution for installing Isys wall mount touchpanels in an existing wall or similar flat surface. Designed for post-construction applications, these mounting kits each include a MMK-Series mud ring to compensate for significant drywall cutout imperfections.

AVAILABLE MODELS

WMKM-15L

Post-construction Mounting Kit w/Mud Ring for New Isys 15" Wall Mount Touchpanels

Touchpanel Models:

TPS-15L, TPS-15G-QM-L, TPMC-15-QM-L, TPMC-15-CH-L

WMKM-12L

Post-construction Mounting Kit w/Mud Ring for New Isys 12" Wall Mount Touchpanels

Touchpanel Models: TPS-12L, TPS-12G-QM-L

WMKM-4000L

Post-construction Mounting Kit w/Mud Ring for Isys 10.4" Wall Mount Touchpanels

Touchpanel Models: TPS-4000L

WMKM-3100L

Post-construction Mounting Kit w/Mud Ring for Isys 6.4" Wall Mount Touchpanels

Touchpanel Models: TPS-3100L

WMKM-2000L

Post-construction Mounting Kit w/Mud Ring for Isys 5" Wall Mount Touchpanels

Touchpanel Models: TPS-2000L

WMKM-4L

Post-construction Mounting Kit w/Mud Ring for Isys 3.6" Wall Mount Touchpanels

Touchpanel Models: TPS-4L

WMKB-4L Wall Mount Clips for TPS-4L (10 Sets)

The WMKB-4L is a package containing 10 sets of 4 wall mount clips identical to those included with each TPS-4L touchpanel. Designed specifically for the TPS-4L, these clips provide a quick and cost-effective alternative to other mounting kits.

MOUNTING KITS

RMK Rack Mount Kits

RMK-Series rack mount kits are optional accessories for Isys wall mount touchpanels designed to allow for installation of the touchpanel in a 19" EIA equipment rack.

AVAILABLE MODELS

RMK-17L

**Rack Mount Kit for New Isys
17" Wall Mount Touchpanels**

Touchpanel Models:

TPS-17L, TPMC-17-QM-L, TPMC-17-CH-L

Rack Spaces: Nine (9)

RMK-15L

**Rack Mount Kit for New Isys
15" Wall Mount Touchpanels**

Touchpanel Models:

TPS-15L, TPS-15G-QM-L, TPMC-15-QM-L, TPMC-15-CH-L

Rack Spaces: Nine (9)

RMK-12L

**Rack Mount Kit for New Isys
12" Wall Mount Touchpanels**

Touchpanel Models: TPS-12L, TPS-12G-QM-L

Rack Spaces: Eight (8)

RMK-4000L

**Rack Mount Kit for Isys 10.4"
Wall Mount Touchpanels**

Touchpanel Models: TPS-4000L

Rack Spaces: Six (6)

RMK-3100L

**Rack Mount Kit for Isys 6.4"
Wall Mount Touchpanels**

Touchpanel Models: TPS-3100L

Rack Spaces: Five (5)

FACEPLATES AND BUTTONS

TPS-FPAR Architectural Series Faceplates

Architectural series faceplates enhance the appearance of Isys wall mount touchpanels with a distinctive style ideally suited to today's contemporary interiors. Elegantly crafted of a luminum, Architectural series faceplates are offered in a variety of luxurious finishes.

Button caps are not included, and a "no button" option can be ordered for select touchpanel models to effectively eliminate the pushbuttons, exposing only the touchscreen display.



AVAILABLE MODELS

For TPS-4000L 10.4" Isys Wall Mount Touchpanel

TPS-FPAR4000L-A*	Almond
TPS-FPAR4000L-W*	White
TPS-FPAR4000L-A/BLK*	Black Anodized
TPS-FPAR4000L-S/STEEL*	Stainless Steel**

For TPS-3100L 6.4" Isys Wall Mount Touchpanel

TPS-FPAR3100L-A*	Almond
TPS-FPAR3100L-W*	White
TPS-FPAR3100L-A/BLK*	Black Anodized
TPS-FPAR3100L-S/STEEL*	Stainless Steel**

For TPS-2000L 5" Isys Wall Mount Touchpanel

TPS-FPAR2000L-A	Almond
TPS-FPAR2000L-W	White
TPS-FPAR2000L-A/BLK	Black Anodized
TPS-FPAR2000L-S/STEEL	Stainless Steel**
TPS-FPAR2000L-A-NB*	Almond, no button holes
TPS-FPAR2000L-W-NB*	White, no button holes
TPS-FPAR2000L-A/BLK-NB*	Black Anodized, no button holes
TPS-FPAR2000L-S/STEEL-NB*	Stainless Steel**, no button holes

* Available by special order - allow 60 days for delivery.

** Aluminum composition; may not be suitable for sterile environments.

Architectural Finishes

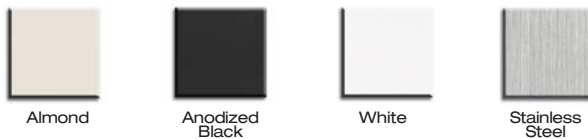

FACEPLATES AND BUTTONS

TPS-FP Designer Series and Standard Faceplates

Designer faceplates are available for the Isys TPS-2000L 5" wall mount touchpanel to enable a customized appearance to match any décor. Designer faceplates are offered in a variety of elegant metallic finishes inset within plastic trim. A primed metal surface option is available to accommodate paint or wallpaper.

Standard plastic faceplates are also available in white, black, or almond.

All faceplates include a set of 10 button caps with custom laser engraving.

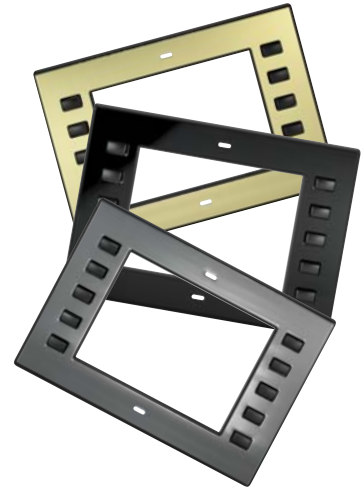

AVAILABLE MODELS

Designer Series - Engraving Available On Buttons Only

TPS-FP-BLK/CHR	Black Chrome with black trim and buttons
TPS-FP-BR/GLD	Brushed Gold with black trim and buttons
TPS-FP-P/BLK	Polished Black with black trim and buttons
TPS-FP-P/BRAS	Polished Brass with black trim and buttons
TPS-FP-P/GLD	Polished Gold with black trim and buttons
TPS-FP-S/STEEL	Stainless Steel* with black trim and buttons
TPS-FPINA	Primed metal faceplate with almond trim and buttons
TPS-FPINB	Primed metal faceplate with black trim and buttons
TPS-FPINW	Primed metal faceplate with white trim and buttons

Standard - Engraving Available On Buttons and Faceplate

TPS-FPA	Almond faceplate and buttons
TPS-FPB	Black faceplate and buttons
TPS-FPW	White faceplate and buttons

* Aluminum and plastic composition; may not be suitable for sterile environments.

Designer Metallic Finishes



Black Chrome



Brushed Gold



Polished Gold



Polished Brass



Polished Black



Stainless Steel

Standard Finishes



Almond



Black



White

FACEPLATES AND BUTTONS

TPS-WPK Water Resistant Cover Kit (4 Pack)

TPS-WPK covers are great for protecting the Isys TPS-2000L 5" wall mount touchpanel wherever it is likely to be exposed to moisture or dampness such as basements, pools, boathouses, bathrooms, laundries and garages. Each TPS-WPK kit contains four urethane covers, which install easily over the faceplate of the touchpanel. Without hindering normal use, they effectively prevent liquids and other airborne materials from settling onto the face of the panel.

Please note that Crestron touchpanels are not intended to be exposed to the elements or used under conditions exceeding the environmental limits of 50° to 113°F (10° to 45°C), 10% to 90% RH (non-condensing). The TPS-WPK is designed only for use with standard plastic faceplates with buttons.

Kit Contents: (4) flexible urethane covers



TPS/TPMC-4L-FP Faceplates for TPS-4L

These optional plastic faceplates are available for the TPS-4L touchpanel in a choice of 10 designer colors designed to harmonize with any décor and match the popular Cameo® series keypads. Each faceplate may be ordered with or without custom engraving.

AVAILABLE MODELS

TPS/TPMC-4L-FPA

Almond

TPS/TPMC-4L-FPB

Black

TPS/TPMC-4L-FPBT

Butter

TPS/TPMC-4L-FPCR

Cream

TPS/TPMC-4L-FPEC

Ecru

TPS/TPMC-4L-FPMS

Mustard

TPS/TPMC-4L-FPSM

Smoke

TPS/TPMC-4L-FPST

Stone

TPS/TPMC-4L-FPW

White

TPS/TPMC-4L-FPWH

Wheat



Isys Wall Mount Touchpanels diagrams

Typical Isys Wall Mount Touchpanel Application using QuickMedia

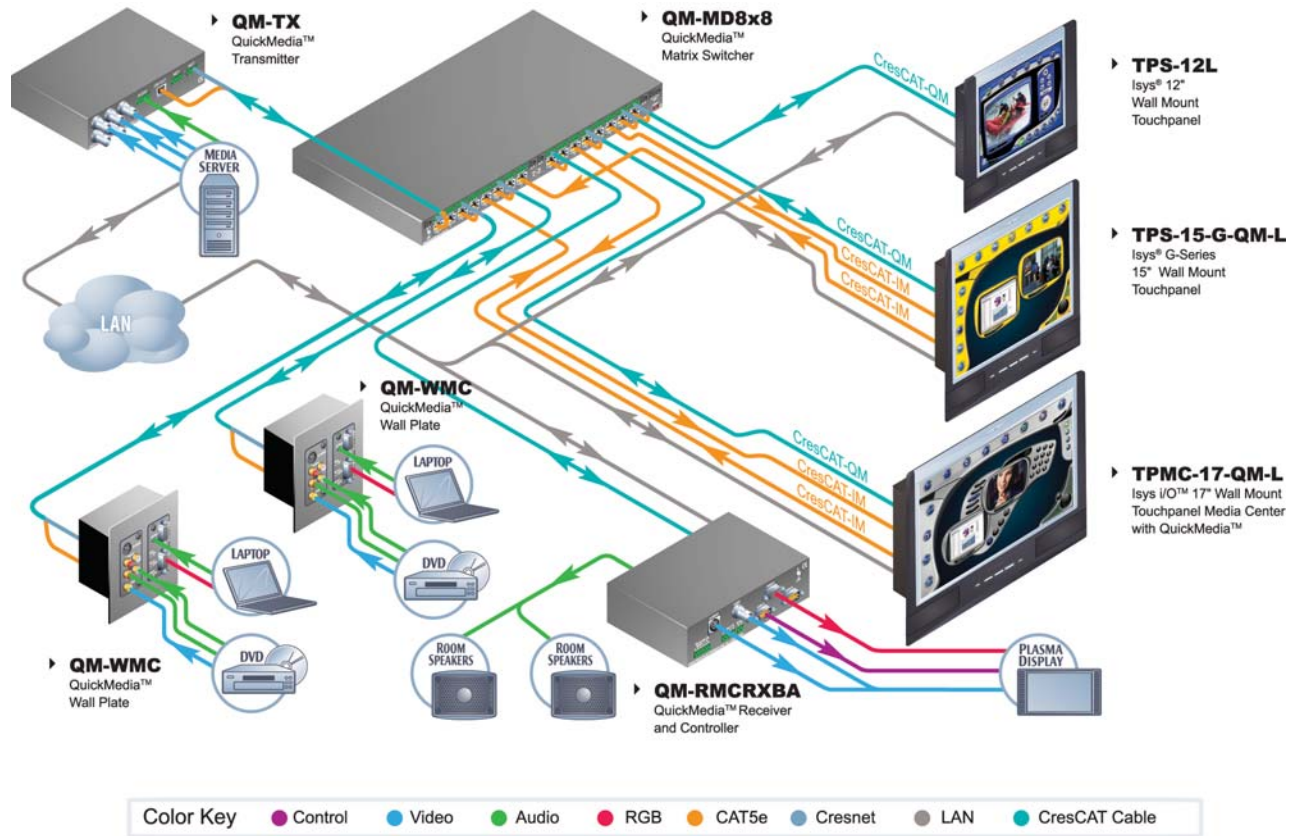

Free Manuals Download Website

<http://myh66.com>

<http://usermanuals.us>

<http://www.somanuals.com>

<http://www.4manuals.cc>

<http://www.manual-lib.com>

<http://www.404manual.com>

<http://www.luxmanual.com>

<http://aubethermostatmanual.com>

Golf course search by state

<http://golfingnear.com>

Email search by domain

<http://emailbydomain.com>

Auto manuals search

<http://auto.somanuals.com>

TV manuals search

<http://tv.somanuals.com>