

# Crestron **CEN-UPS1250**

## Uninterruptible Power Supply

---

## Operations & Installation Guide



This document was prepared and written by the Technical Documentation department at:



Crestron Electronics, Inc.

15 Volvo Drive

Rockleigh, NJ 07647

1-888-CRESTRON

All brand names, product names and trademarks are the property of their respective owners.

©2008 Crestron Electronics, Inc.

---

## Safety Information

**Read this manual**

Read all of the safety and operating instructions before installing and operating this device.

**Keep this manual**

Retain this manual and all of the safety information that came with this device.

**Warnings**

Comply with all warnings presented in this manual, as well as any warnings found on the device.

**Follow instructions**

Follow all instructions that pertain to operating and using this device.

**Cleaning**

Shut off and unplug this device from the wall outlet and disconnect the battery before cleaning. Use a soft damp cloth for cleaning. Do not use liquid or aerosol cleaners.

---

**NOTE:** Any equipment connected to this device will not be powered or protected from uninterrupted service during this process.

---

**Water and Moisture**

Do not use this product near any source of water or in an environment where the relative humidity may exceed 95% (non-condensing).

**Placement**

Do not install this device on an unsteady surface. Do not install this device on any type of heat source.

**Ventilation**

Do not install this device in an area where the device's vents, provided for cooling purposes, may become blocked and impede air flow.

**Power**

Ensure this device is connected to a properly grounded AC power source. Further ensure the device is plugged into a source that provides the required 120 VAC. Do not use a plug adapter to defeat the AC plug ground pin.

**Polarization**

This device has a polarized AC line plug and one blade is wider than the other. This plug will only fit into the wall outlet in one orientation, which is a safety feature. Do not remove the round grounding pin or use an adapter that defeats this safety feature.

**Power Cord**

Ensure power cords are routed in a manner that will ensure they are not pinched, frayed or stepped on. After connecting other devices to this device, do not push the rear of the device up against any surface (wall or shelving unit). This can cause power cords to bend excessively, which can break the strands of wire inside the cord.

**Antenna Grounding**

Although this device provides protection against electrical surges, if you are connecting an outside antenna or cable system to this device, ensure the antenna or cable system is grounded to provide additional protection against voltage surges and static discharges in accordance with Section 810 of the National Electric Code, ANSI/NFPA No. 70 (and as shown in the illustration on the following page).

**Other Grounding**

This device provides a grounding lug on the rear panel for grounding the device to an external transient voltage surge suppression (TVSS) device. Ensure these ground connections are made in accordance with the instructions provided with the TVSS device.

**Lightning**

This device employs metal oxide varistors (MOVs) and other circuitry to protect against lightning and other sources of sudden voltage surges and sags. It is not necessary to turn this device or the devices connected to this device off during a lightning storm.

**Power Lines**

Do not locate outside antenna systems near overhead power lines or other electric light or power circuits or where they may fall on or otherwise come in contact with these power sources. If you allow the ladder being used or the antenna itself to come into contact with these power sources, it could be fatal.

**Overloading**

Do not overload the wall outlet where this device is connected and do not overload this device. Ensure the total load to this device does not exceed the value listed in the Specifications section of this manual.

**Openings**

Do not insert any object through the device's cooling vents. It may come in contact with high voltage components and cause injury, death or damage to the device. Do not allow liquids to enter any opening in this device.

**Servicing**

This device does not contain any user serviceable components. Removing the cover from this device may present a shock hazard and/or may void the warranty.

**Damage Requiring Service**

If any damage occurs to this device, immediately disconnect (unplug) the AC power cord from the wall outlet. Do not use the **Power** switch or disconnect the AC power cord from the connector on the rear of the device to disconnect power. Notify Crestron Technical Support or customer Service at once.

**Replacement Parts**

None of the components in this device can or should be removed or replaced unless it is by a Crestron qualified technician.

**Periodic Inspection**

Inspect the line cords, telephone/data cords and DSS-CATV coaxial cables connected to this device to ensure they are fully inserted or attached.

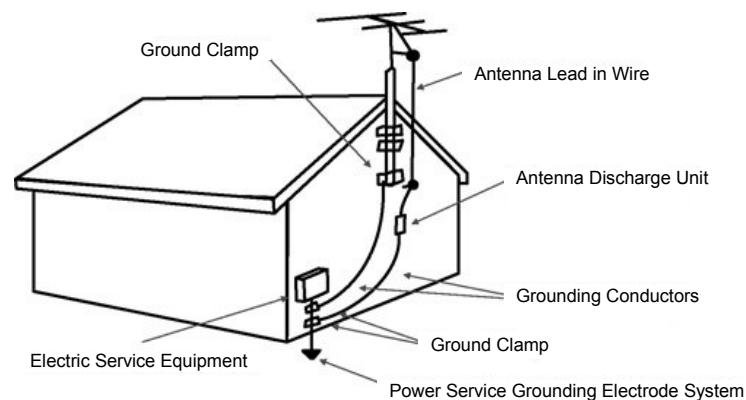
**Example of Antenna Grounding Per National Electric Code (NEC)**

# Contents

Safety Information .....	i
<b>Uninterruptible Power Supply: CEN-UPS1250</b>	<b>1</b>
Introduction .....	1
Features and Functions .....	1
Specifications .....	3
Physical Description .....	5
Industry Compliance .....	10
Setup .....	11
Ethernet .....	11
Identity Code .....	11
Supplied Hardware .....	11
Installation .....	11
Hardware Hookup .....	15
Programming Software .....	17
Earliest Version Software Requirements for the PC .....	17
Programming with Crestron SystemBuilder .....	17
Programming with SIMPL Windows .....	17
Example Program .....	19
Uploading and Upgrading .....	20
Establishing Communication .....	20
Programs and Firmware .....	21
Program Checks .....	21
Operation .....	22
Performing the System Test .....	22
Status and Informational Screens .....	24
Setup Screens .....	26
Problem Solving .....	31
Troubleshooting .....	31
Reference Documents .....	32
Further Inquiries .....	32
Future Updates .....	32
Return and Warranty Policies .....	33
Merchandise Returns / Repair Service .....	33
CRESTRON Limited Warranty .....	33



# Uninterruptible Power Supply: CEN-UPS1250

---

## Introduction

### Features and Functions

- UPS and power conditioning – Engineered by APC®
- 2-Series control system integration
- Centralized management via RoomView® software
- Battery backup and power control management
- Surge protection for power line, coax and telco
- Isolated EMI and RFI noise filtering
- Automatic voltage regulation
- Built-in environmental monitoring
- Onboard timestamp logging
- 19” four post EIA rack mountable

### *Uninterruptible Power Supply*

The CEN-UPS1250 is a 1250 Watt, 120 Volt uninterruptible power supply and power conditioner *Engineered by APC®* specifically for Crestron. Designed to protect Crestron® control systems, media servers, video displays and other devices, the CEN-UPS1250 employs pure sine wave battery backup to maintain continuous operation of critical components whenever power is disrupted. Remote monitoring and control through Crestron’s award-winning RoomView® software and full 2-Series control system integration deliver a comprehensive power management and protection solution that is an integral part of the complete Crestron control network.

### *Pure Sine Wave Battery Backup*

Any unexpected shutdown due to the sudden loss of power will certainly disrupt workflow and stop a presentation dead in its tracks but it can also cause the loss of precious data and system settings and can even damage hard drives and other vulnerable components. The CEN-UPS1250 constantly monitors the incoming power line and instantly transfers power to battery backup in the event of such a power loss, ensuring the connected components continue to operate unhampered. It may also be configured to transfer to battery in the case of an over or under voltage condition or

if excessive line noise or distortion is detected, ensuring optimum performance of sensitive video and audio equipment during momentary power glitches.

When running on battery backup, the CEN-UPS1250 can power a rack full of equipment for several minutes without interruption. In the event of a prolonged power outage, a properly managed shutdown of the equipment can be performed automatically. Configurable “load-shedding” allows only certain components to be shut down, preserving battery fuel and extending runtime for more vital components. The CEN-UPS1250 will also ensure a smooth changeover from primary power to a backup generator.

### ***Managed Power Control***

The CEN-UPS1250 provides twelve 120 Volt power outlets organized in four banks. Each of the four banks of outlets is independently switchable, with fully managed power up and shutdown available at the press of a single button or control system command. Up to 10 seconds of delay adjustment on banks 3 and 4 enables customized sequential switching capability. Sequential switching ensures that all the components of a complete system are powered up and down in proper order, avoiding dangerous transients that can damage delicate components and trip the main circuit breaker. Components such as video projectors and media servers that require systematic shutdown and restart can be managed seamlessly through integration with a control system.

### ***Automatic Voltage Regulation***

Keeping the voltage within a safe operating range helps prevent equipment malfunctions and can even improve audio and video performance. Using automatic voltage regulation, the CEN-UPS1250 can correct for many high and low voltage fluctuations without having to switch to battery operation, preserving battery fuel for more serious situations.

### ***Surge Protection***

The CEN-UPS1250 provides thorough protection against surges, spikes and lightning. In addition to power line protection on all 12 outlets, there is also built-in surge protection for two separate coax lines and one telephone line, delivering a complete solution for protecting TVs, cable and satellite receivers, modems and conferencing devices.

### ***Noise Filtering***

Built-in EMI and RFI noise filtering eliminates the electromagnetic and radio frequency interference that can negatively impact sound and video quality. Each of the four outlet banks provides filtering protection specialized for a specific type of device: DIGITAL, DISPLAY, ANALOG and HI-CURRENT. Each bank is electrically isolated to prevent any noise present on one bank from reaching the devices connected to any other bank.

### ***Environmental Monitoring***

Using the included external probe, ambient temperature and relative humidity levels can be measured, recorded and even reported to the control system or central help desk. Using this feature, safe operating limits can be specified for all of the equipment within a room or rack so that whenever the limits are exceeded, the user is notified, climate control is adjusted and if necessary, the equipment can be powered down safely.



### **RoomView® and Control System Integration**

Monitoring and operation of the CEN-UPS1250 extends beyond its front panel, providing direct communication with Crestron's RoomView Remote Asset Management Software as well as with Ethernet enabled 2-Series control systems. The CEN-UPS1250 notifies RoomView whenever it switches to battery backup and warns if the battery is low or overloaded. It also reports which outlet banks are on, as well as the line voltage, output voltage, frequency, voltage regulation status, system load, internal temperature, ambient temperature and humidity and battery condition. Centralized monitoring and logging via RoomView provides an invaluable resource for quickly resolving power line problems and maintaining batteries.

### **Built-in Logging**

In addition to RoomView, the CEN-UPS1250 also supports onboard timestamp logging. Data can be set to log every 1 to 60 minutes with sufficient memory for at least 30 days of history, recording the load, battery condition, line voltage, outlet on/off status and environmental conditions. Instantaneous events such as switching to battery, low battery warnings and self tests are also logged.

### **Rack Mountable**

A heavy duty rack mount hardware kit is provided to mount the unit into any EIA standard four post 19" equipment rack up to 28" deep. The feet on the bottom of the unit can be unscrewed and removed to save space when the unit is rack-mounted.

## **Specifications**

Specifications for the CEN-UPS1250 are listed in the following table.

#### *CEN-UPS1250 Specifications*

<b>SPECIFICATION</b>	<b>DETAILS</b>
UPS/Power Conditioner	
Output Power Capacity	1250 Watts (1440 VA) @ 120 Volts AC nominal
Efficiency	90% at full load
Output Voltage Distortion	<5% at full load
Output Frequency	47 to 63 Hz (sync to line power input)
Waveform Type	Sine wave
Transfer Time	7 ms typical, 10 ms maximum during blackout
Power Line Surge Protection	Rated for 4080 Joules
Filtering	Full time multi-pole noise filtering, 5% IEEE surge let-thru, zero clamping response time, meets UL 1449 Dataline protection
Voltage Regulation	Performs voltage boost or trim to maintain 120 V nominal output
Maximum Output Current	12 Amps per outlet, 12 Amps total
Power Requirements	
Input Voltage	92 to 142 Volts AC, 120 Volts nominal
Input Frequency	47 to 63 Hz
Maximum Input Current	12 Amps (when fed from 15 Amp circuit)

*(Continued on following page)*

*CEN-UPS1250 Specifications (Continued)*

SPECIFICATION	DETAILS
Battery	
Internal Battery	(4) 12 Volt, 9 Ah maintenance free sealed lead acid w/suspended electrolyte, Crestron model CEN-UPS1250-BTP included
Backup Runtime	~12 minutes @ half load (625 W), ~2.7 minutes @ full load (1250 W)
Recharging Time	~8 hours typical to 90% capacity following a discharge to shutdown @ half load
Battery Life	2 to 5 years under normal use
Ethernet	10BaseT/100BaseTX, auto switching, auto negotiating, auto discovery, full/half duplex, TCP/IP, UDP/IP, CIP, SNMP, 128 bit SSL encryption, IEEE 802.3U compliant
Alarm	Audible alarm indicates when in backup mode, when battery is low and when overloaded
Minimum 2-Series Control System Update File <sup>1 2</sup>	Version 3.155.1240 or later
Environmental	
Temperature	32° to 104°F (0° to 40°C)
Humidity	10% to 90% RH (non-condensing)
Heat Dissipation	100 BTU/Hr
Enclosure	
Chassis	Steel, black matte powder coat finish
Cooling	Microprocessor controlled ultra quiet rear facing fan, vented sides
Faceplate	Extruded aluminum, black matte powder coat finish with polycarbonate label overlay
Mounting	Freestanding or 3U 19" rack mountable, rack must be four post type up to 28" maximum depth (removable feet and rack mount kit included)
Dimensions	
Height	5.21 in (13.22 cm) without feet 5.54 in (14.06 cm) with feet
Width	17.02 in (43.22 cm) without ears 19.11 in (48.53 cm) with ears
Depth	19.73 in (50.10 cm)
Weight (approximate)	62 lbs (28.12 kg)
Included Accessories	
CEN-UPS1250-BTP	Internal Battery Pack

1. The latest software versions can be obtained from the Crestron website. Refer to the NOTE following these footnotes.
2. Crestron 2-Series control systems include the AV2 and PRO2. Consult the latest Crestron Product Catalog for a complete list of 2-Series control systems.

**NOTE:** Crestron software and any files on the website are for authorized Crestron dealers and Crestron Authorized Independent Programmers (CAIP) only. New users may be required to register to obtain access to certain areas of the site (including the FTP site).

### Physical Description

This section provides information on the connections, controls and indicators available on your CEN-UPS1250.

*CEN-UPS1250 Front View*

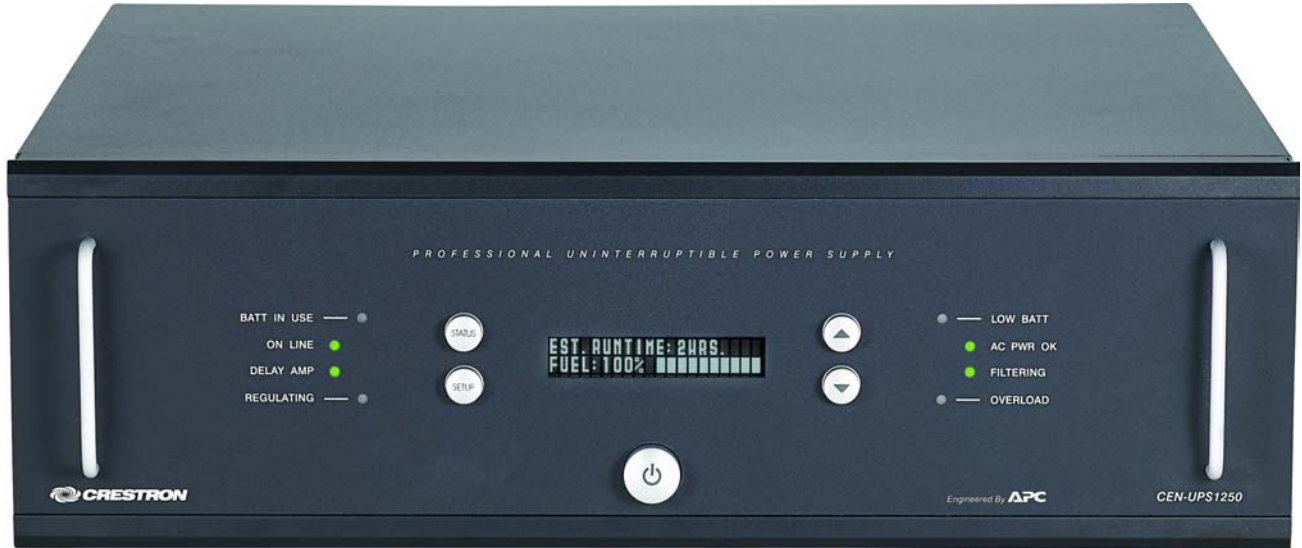

*CEN-UPS1250 Rear View*



*CEN-UPS1250 Overall Dimensions (Front and Top Views)*

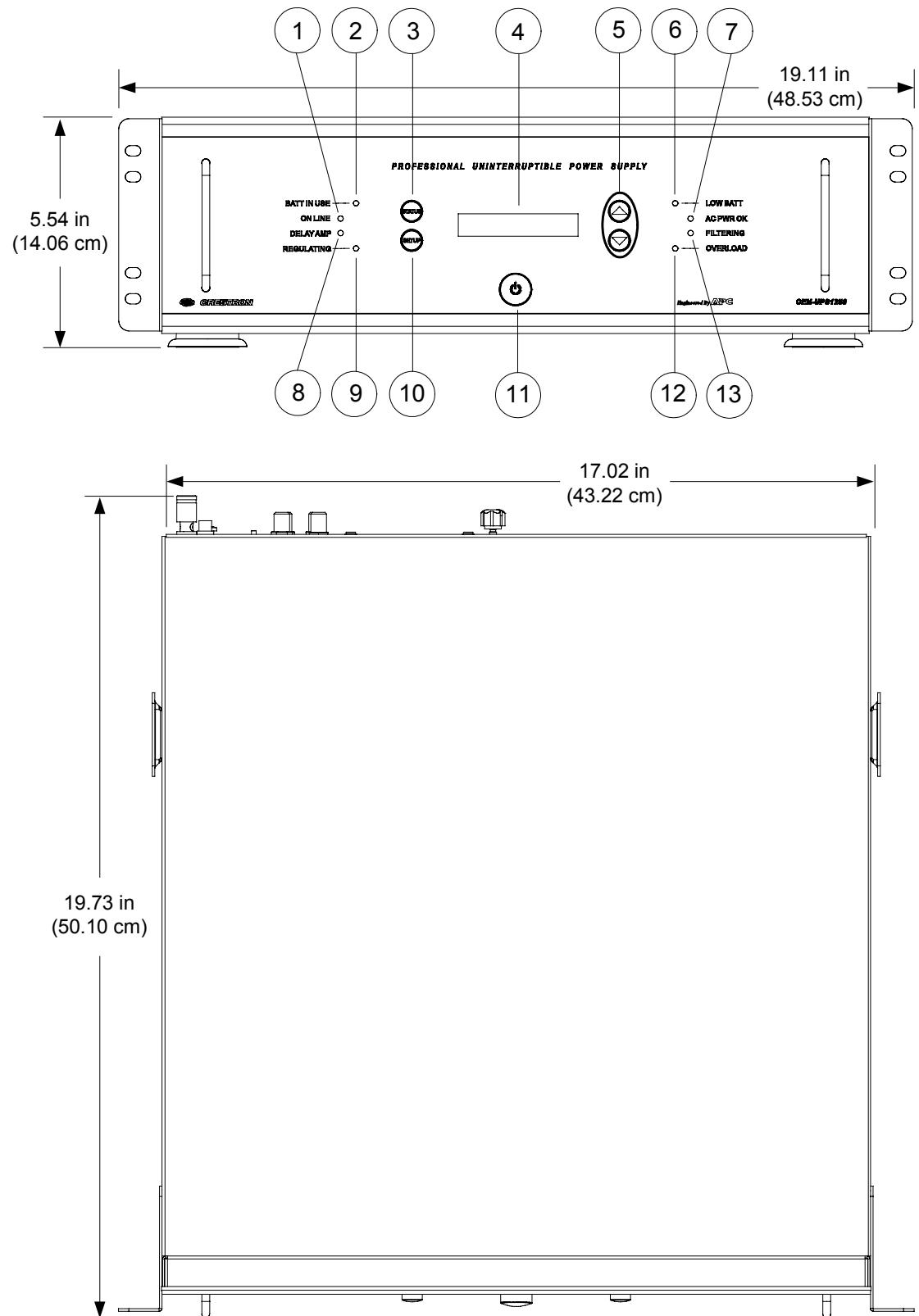

*CEN-UPS1250 Overall Dimensions (Rear View)*

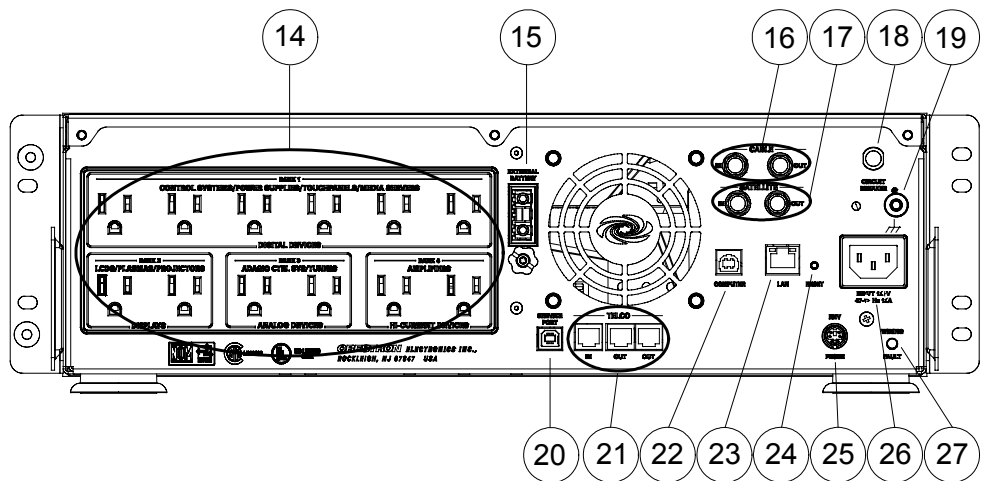





*Connectors, Controls & Indicators*

#	CONNECTORS, CONTROLS & INDICATORS	DESCRIPTION
1	ON LINE LED	(1 green) Indicates a working connection to the control system.
2	BATT IN USE LED	(1 red) Indicates output power is being fed from battery backup.
3	STATUS BUTTON	(1) Sequences through display of various electrical and environmental measurements, operational status, battery condition and other system information.
4	DISPLAY	Vacuum fluorescent, 2 lines x 20 characters per line.
5	▲, ▼ BUTTONS	(2) Used to adjust configuration settings up/down or on/off.
6	LOW BATT LED	(1 red) Indicates remaining backup time has fallen below a preset amount, adjustable from 2 to 26 minutes <sup>1</sup> .
7	AC PWR OK LED	(1 green) Indicates the line input voltage is within the acceptable operating range of 92 V to 142 V.
8	DELAY AMP LED	(1 green) Indicates the <b>BANK 4- HI-CURRENT DEVICES</b> output bank is turned on.
9	REGULATING LED	(1 green) Indicates voltage regulation is operating to compensate for a high or low line voltage condition.
10	SETUP BUTTON	(1) Sequences through various configuration settings and operations.
11	POWER/STANDBY BUTTON	(1) Turns all output banks on or off, forces cold start to battery when held.
12	OVERLOAD LED	(1 red) Indicates there is too much load connected to the output.

*(Continued on following page)*

*Connectors, Controls & Indicators (Continued)*

#	CONNECTORS, CONTROLS & INDICATORS	DESCRIPTION
13	FILTERING LED	(1 green) Indicates the EMI and RFI noise reduction circuit is active.
14	OUTLET BANKS	<p><b>BANK 1 – DIGITAL DEVICES</b>  (6) NEMA 5-15R female;  Grounded AC power outlets, switched;  Includes noise filtering and protection for digital devices such as control systems, power supplies, touchpanels and media servers.</p> <p><b>BANK 2 – DISPLAYS</b>  (2) NEMA 5-15R female;  Grounded AC power outlets, switched;  Includes noise filtering and protection for display devices such as LCDs, plasmas and projectors.</p> <p><b>BANK 3 – ANALOG DEVICES</b>  (2) NEMA 5-15R female;  Grounded AC power outlets, delay switched;  Delayed turn on, adjustable from 0 to 10 seconds;  Includes noise filtering and protection for analog devices such as Adagio<sup>®</sup> control systems and tuners.</p> <p><b>BANK 4 – HI-CURRENT DEVICES</b>  (2) NEMA 5-15R female;  Grounded AC power outlets, delay switched;  Delayed turn on, adjustable from 0 to 10 seconds;  Includes noise filtering and protection for high current devices such as amplifiers.</p>
15	EXTERNAL BATTERY	(1) Connector for optional external battery, sold by APC <sup>2</sup> .
16	<p>CABLE</p> 	<p><b>IN</b> – (1) F-type coaxial, female;  Coaxial cable or antenna source connection.</p> <p><b>OUT</b> – (1) F-type coaxial, female, protected TV/receiver or modem device connection.</p>
17	<p>SATELLITE</p> 	<p><b>IN</b> – (1) F-type coaxial, female;  Coaxial cable or antenna source connection.</p> <p><b>OUT</b> – (1) F-type coaxial, female, protected TV/receiver or modem device connection.</p>
18	CIRCUIT BREAKER BUTTON	Disrupts power to all outputs in case of an overload condition, press to reset.
19	<p>G</p> 	(1) Binding post, chassis ground lug.
20	<p>SERVICE PORT</p> 	(1) USB Type B female; Used for factory configuration only.

*(Continued on following page)*

Connectors, Controls & Indicators (Continued)

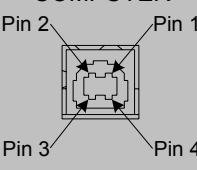
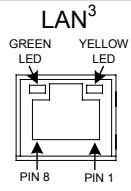
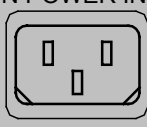
#	CONNECTORS, CONTROLS & INDICATORS	DESCRIPTION																				
21	<p>TELCO</p> 	<p><b>IN</b> – (1) 4-pin RJ-11 female; Dual line telephone connection.  <b>OUT</b> – (2) 4-pin RJ-11 female; Protected dual line telephone/modem device connection.</p>																				
22	<p>COMPUTER</p> 	<p>(1) USB Type B female; USB computer console port (cable included).</p> <table border="1"> <thead> <tr> <th>PIN</th> <th>DESCRIPTION</th> </tr> </thead> <tbody> <tr> <td>1</td> <td>+5 VDC</td> </tr> <tr> <td>2</td> <td>Data -</td> </tr> <tr> <td>3</td> <td>Data +</td> </tr> <tr> <td>4</td> <td>Ground</td> </tr> </tbody> </table>	PIN	DESCRIPTION	1	+5 VDC	2	Data -	3	Data +	4	Ground										
PIN	DESCRIPTION																					
1	+5 VDC																					
2	Data -																					
3	Data +																					
4	Ground																					
23	<p>LAN<sup>3</sup></p> 	<p>(1) 8-wire RJ-45 with two LED indicators; 10/100BaseT Ethernet port; Green LED indicates link status; Yellow LED indicates Ethernet activity.</p> <table border="1"> <thead> <tr> <th>PIN</th> <th>SIGNAL</th> <th>PIN</th> <th>SIGNAL</th> </tr> </thead> <tbody> <tr> <td>1</td> <td>TX +</td> <td>5</td> <td>N/C</td> </tr> <tr> <td>2</td> <td>TX -</td> <td>6</td> <td>RC -</td> </tr> <tr> <td>3</td> <td>RC+</td> <td>7</td> <td>N/C</td> </tr> <tr> <td>4</td> <td>N/C</td> <td>8</td> <td>N/C</td> </tr> </tbody> </table>	PIN	SIGNAL	PIN	SIGNAL	1	TX +	5	N/C	2	TX -	6	RC -	3	RC+	7	N/C	4	N/C	8	N/C
PIN	SIGNAL	PIN	SIGNAL																			
1	TX +	5	N/C																			
2	TX -	6	RC -																			
3	RC+	7	N/C																			
4	N/C	8	N/C																			
24	<p>RESET BUTTON</p>	<p>(1) Red miniature pushbutton, resets communications board.</p>																				
25	<p>ENV PROBE</p>	<p>6-pin mini-DIN female; Connection for external temperature/RH sensor (included).</p>																				
26	<p>INPUT 120V 47-63 Hz 12A (MAIN POWER INPUT)</p> 	<p>(1) IEC-320 C14 chassis plug; Line power input, mates with 10 ft. (3.05 m) power cord (included).</p>																				
27	<p>WIRING FAULT LED</p>	<p>(1 red) Indicates a missing ground, overloaded neutral or reversed polarity at the line power input.</p>																				

1. The unit does not have to be powered on for batteries to recharge.
2. American Power Conversion Corp. (APC), W. Kingston, Rhode Island, US; Website: [www.apc.com](http://www.apc.com).
3. To determine which is pin 1 on the cable, hold the cable so that the end of the eight pin modular jack is facing away from you, with the clip down and copper side up. Pin 1 is on the far left.

**CAUTION:** When resetting the **Circuit Breaker**, push the button in quickly and release the button. **Do not** hold the **Circuit Breaker** button in. Failure to comply may result in equipment damage.

## Industry Compliance

This unit has been manufactured to comply with the following Standards for Safety in the United States, Canada and Mexico.



---

**NOTE:** This device complies with part 15 of the FCC rules. Operation is subject to the following two conditions: (1) this device may not cause harmful interference and (2) this device must accept any interference received, including interference that may cause undesired operation.

This equipment has been tested and found to comply with the limits for a Class B digital device, pursuant to part 15 of the FCC Rules. These limits are designed to provide reasonable protection against harmful interference in a residential installation. This equipment generates, uses and can radiate radio frequency energy and if not installed and used in accordance with the instructions, may cause harmful interference to radio communications. However, there is no guarantee that interference will not occur in a particular installation. If this equipment does cause harmful interference to radio or television reception, which can be determined by turning the equipment off and on, the user is encouraged to try to correct the interference by one or more of the following measures:

- Reorient or relocate the receiving antenna.
  - Increase the separation between the equipment and receiver.
  - Connect the equipment into an outlet on a circuit different from that to which the receiver is connected.
  - Consult the dealer or an experienced radio/TV technician for help.
-



## Setup

### Ethernet

Unlike other Crestron network devices, the CEN-UPS1250 does not use Cresnet<sup>®</sup> for communications between the device and the control system. The CEN-UPS1250 requires the use of a high-speed Ethernet connection for control system communications.

For information on connecting Ethernet devices in a Crestron system, refer to the latest version of the Crestron e-Control<sup>®</sup> Reference Guide (Doc. 6052), which is available for download from the Crestron website ([www.crestron.com/manuals](http://www.crestron.com/manuals)).

### Identity Code

The IP ID is set within the CEN-UPS1250's table using Crestron Toolbox<sup>™</sup>. For information on setting an IP table, refer to the Crestron Toolbox help file. The IP IDs of multiple CEN-UPS1250 devices in the same system must be unique.

When setting the IP ID, consider the following:

- The IP ID of each unit must match an IP ID specified in the SIMPL<sup>™</sup> Windows<sup>®</sup> program.
- Each device using IP to communicate with a control system must have a unique IP ID.

### Supplied Hardware

The hardware supplied with the CEN-UPS1250 is listed in the following table.

*Supplied Hardware for the CEN-UPS1250*

DESCRIPTION	PART NUMBER	QUANTITY
Left Rail Assembly	2020250	1
Right Rail Assembly	2020251	1
#10-32 x 1/2" Pan Head Phillips Screw	2020255	10
#10-32 x 1/2" Ornamental Screw	2020254	6
#8-32 x 3/8" Pan Head Phillips Screw	2020252	4
#10-24 x 3/8" Pan Head Phillips Screw	2020256	8
Cleat 2" Formed	2020257	2
Rack Mounting Ear, 3U, Modified	2020253	2

### Installation

The CEN-UPS1250 may be installed on a flat, solid surface or rack mounted. Proper placement of the CEN-UPS1250 should be accomplished in accordance with the following procedures.

**WARNING:** The CEN-UPS1250 weighs 62 pounds (28.12 kg) and we recommend that two people lift the unit. If you remove the battery as described on the following page, it will make lifting and positioning the unit much easier. Lift the unit carefully

by firmly grasping both sides of the unit in the middle. Failure to comply may result in personal injury and/or damage to the equipment.

**WARNING:** The CEN-UPS1250 should not be lifted or moved using the two handles on the front panel. These are intended only for removing the front panel to access the internal battery, not for lifting or positioning the unit.

---

### **Ventilation**

The CEN-UPS1250 should be used in a well-ventilated area. The venting holes should not be obstructed under any circumstances.

To prevent overheating, do not operate this product in an area that exceeds the environmental temperature range listed in the table of specifications. Consider using forced air ventilation and/or incrementing the spacing between units to reduce overheating. Consideration must be given if installed in a closed or multi-unit rack assembly since the operating ambient temperature of the rack environment may be greater than the room ambient temperature. Contact with thermal insulating materials should be avoided on all sides of the unit.

### **Removing the Battery Pack**

To remove the battery pack:

1. Remove the battery retaining bar after loosening the thumb screw that holds it in place. (Refer to illustration on page 15.)
2. Disconnect the battery wire connector.
3. Pull the battery straight back.
4. Press in the retaining tabs to allow the battery to come out completely.

### **Installing on a Flat Surface**

Place the unit on a flat, solid surface that is capable of supporting at least 62 pounds (28.12 kg).

**NOTE:** Avoid placing other components directly on top of or behind the unit. Leave at least one inch of space on all sides to allow for proper air ventilation. Do not block the fan.

---

### **Rack Mounting**

If the CEN-UPS1250 unit is to be rack mounted, please follow these four basic steps:

**WARNING:** To prevent bodily injury when mounting or servicing this unit in a rack, take special precautions to ensure that the system remains stable. The following guidelines are provided to ensure your safety:

- When mounting this unit in a partially filled rack, load the rack from the bottom to the top with the heaviest component at the bottom of the rack.
- If the rack is provided with stabilizing devices, install the stabilizers before mounting or servicing the unit in the rack.

**NOTE:** The rack mounting hardware that is shipped with the unit is designed for 19 inch wide racks only.

---

---

**NOTE:** Reliable earthing of rack-mounted equipment should be maintained. Particular attention should be given to supply connections other than direct connections to the branch circuit (e.g. use of power strips).

---

1. Install the rack mount rails (refer to illustration below).
2. Install the rail cleats (refer to illustrations on the following page).
3. Install the rack mount ears (optional).

---

**CAUTION:** Rack mount ears should *not* be used alone to support the unit. Rack mount rails should always be used to support the unit's weight when it is mounted in a rack.

---

**NOTE:** Rack mount ears are required only if you want to lock the unit to the front of the rack to prevent front to rear movement.

---

4. Slide the unit into the rack so that the cleats mounted on the side of the unit fit within the track of the rack mount rails. If the ears were mounted, screw the mounted ears into the rack to lock the unit into position.

---

**NOTE:** Avoid placing other components directly on top of or behind the unit. Leave at least one inch of space on all sides to allow for proper air ventilation. Do not block the vents or fan.

---

#### *Installing Rack Mounting Rails*

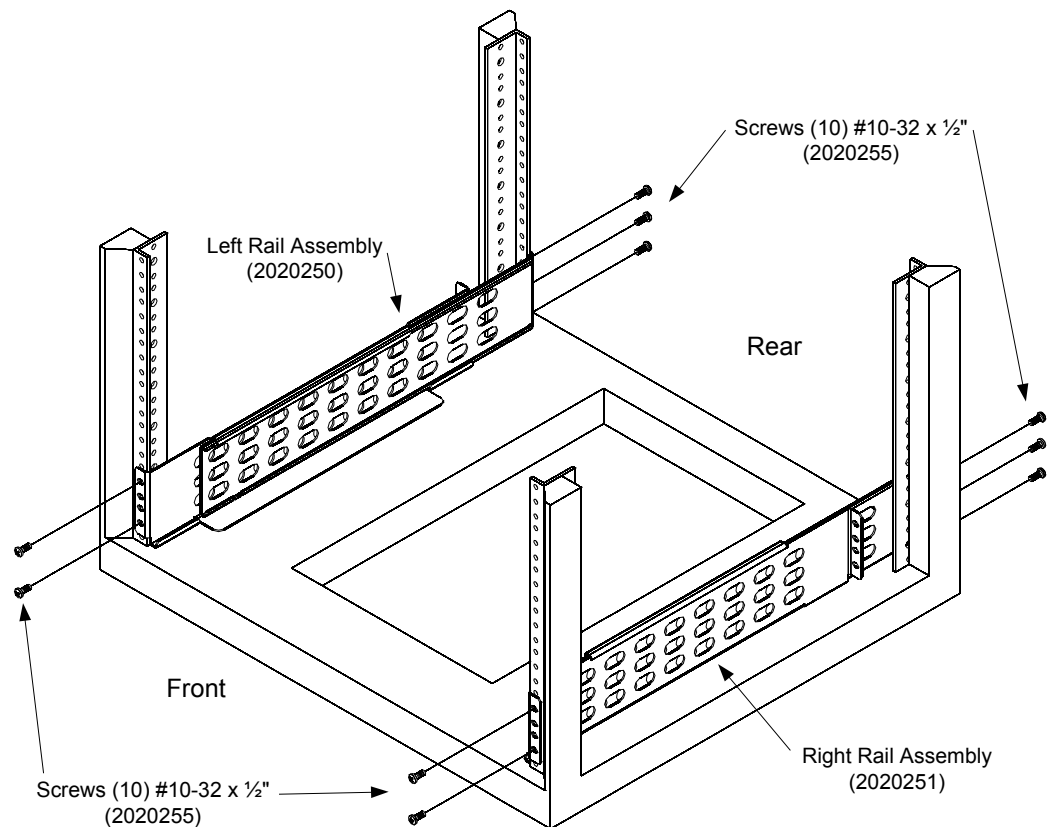

*Attaching Cleats and Rack Mount Ears*

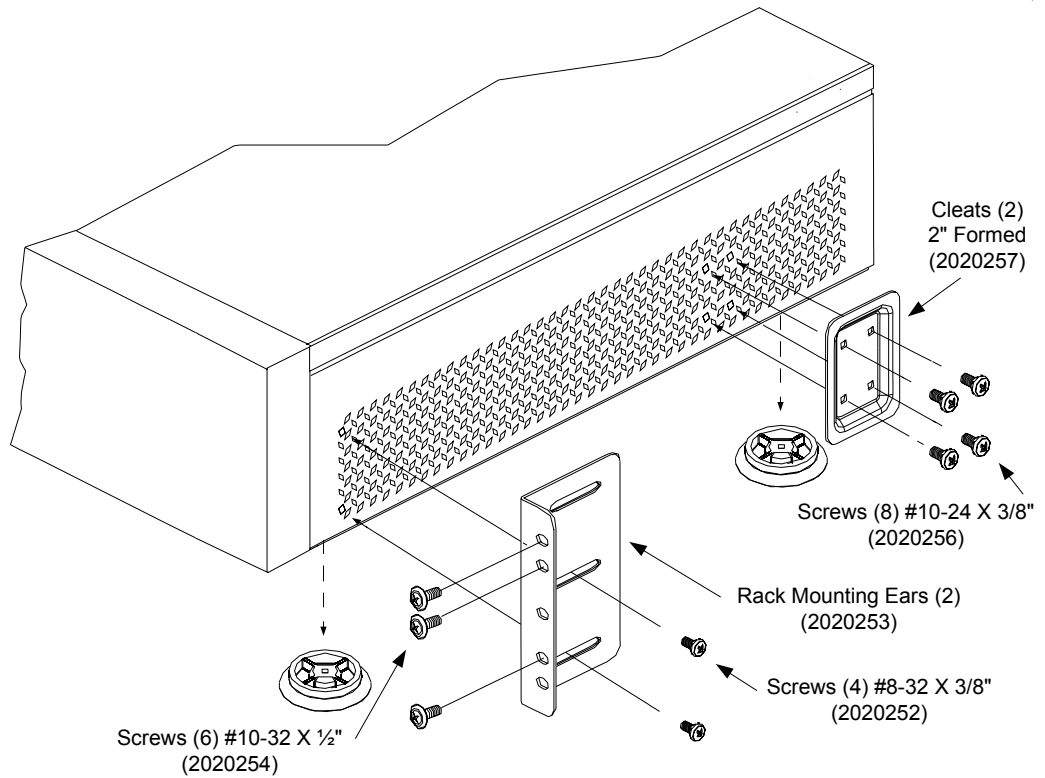



---

**NOTE:** When sliding assembled unit on to rack mounting rails, ensure the cleats properly align with top and bottom inside groove of rails, as shown in the illustration below.

---

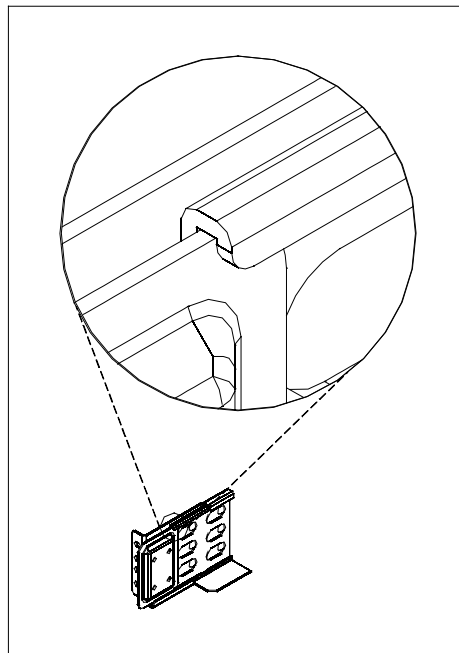
*Aligning Cleats with Rack Mounting Rails*



**Inserting and Connecting the Battery**

The CEN-UPS1250 is shipped with the internal battery pack disconnected. The front bezel of the unit is also not attached to the unit when it is shipped.

This procedure is for connecting the battery when the front bezel has been prematurely installed onto the chassis. Perform the following steps to connect the internal battery pack:

1. Grasp the front panel at the sides and pull the front bezel from the unit.
2. Remove the battery retaining bar after loosening the thumbscrew that holds it in place (refer to illustration below).
3. Push the battery wire connector into the hole located to the left of the battery pack. Ensure it is secure by gently pulling on the wire to be certain it is attached to the connector.

**Battery Wire Connection**

4. Install the battery retaining bar and tighten the thumb screw to secure it in position.

---

**WARNING:** Failure to install the battery retaining bar can be hazardous to the installer.

---

5. Install the front bezel by aligning the four pins located on the back side of the bezel with the holes in the left and right sides of the front of the unit. Gently push the front bezel into place.

**Hardware Hookup**

---

**WARNING:** Do not make telephone, cable, Ethernet, antenna, electrical or ground system connections during a lightning storm. Failure to comply may result in personal injury or death.

---

**Connect the Device**

Due to the unique filtering provided by the CEN-UPS1250, Crestron recommends that you connect the AV components as labelled on the rear panel of the unit.

To ensure ground loops are eliminated and to ensure there is no audible hum in your speaker system, ground all AV components to the ground binding post (marked **G**) located on the rear panel.

Make the necessary connections as called out in the illustration that follows this paragraph.

When making connections to the CEN-UPS1250, consider that the included AC cable cannot be extended.

*Hardware Connections for the CEN-UPS1250*

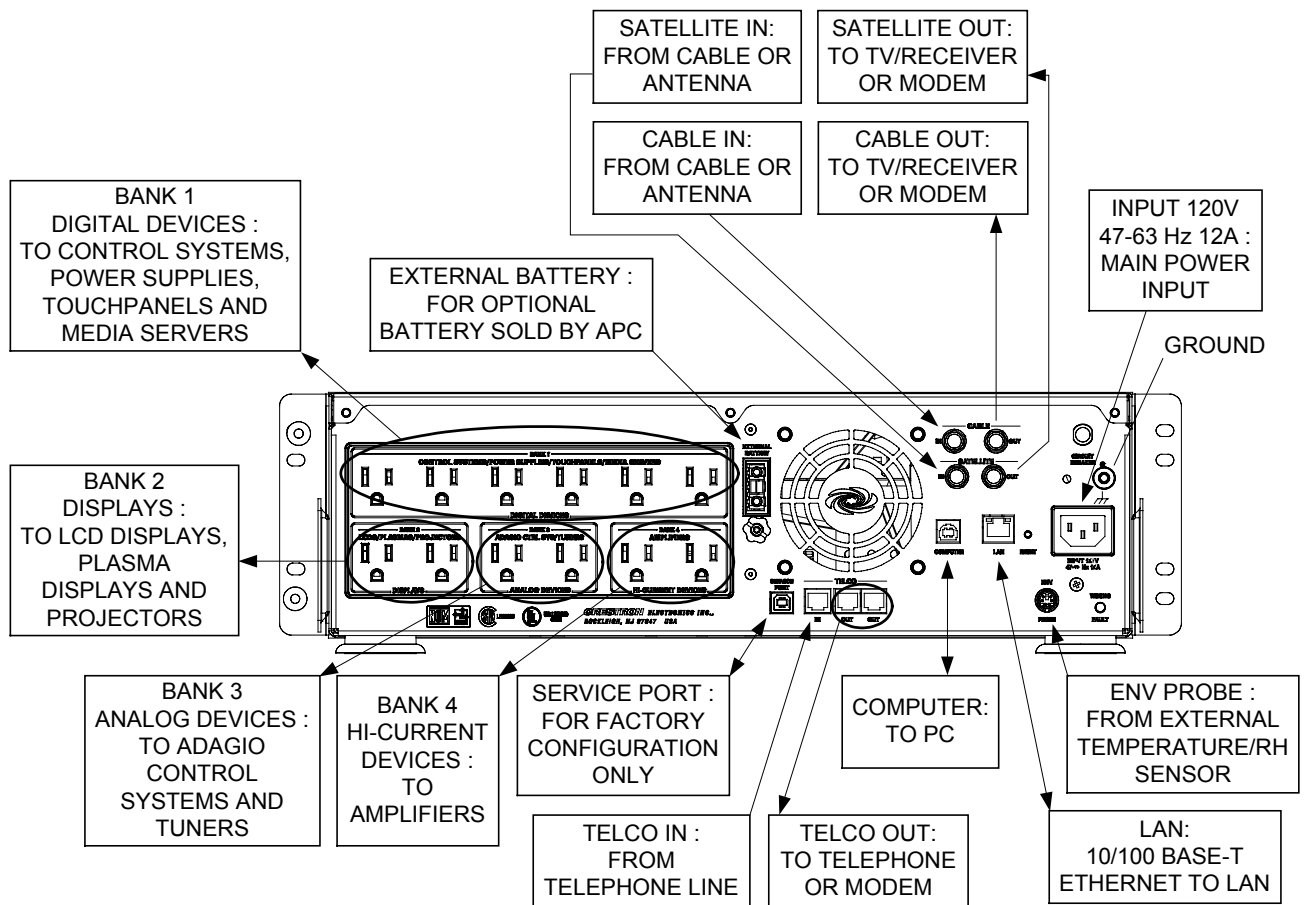

**Ground Wire Connections**

Proper grounding is required. Connect the ground from the CEN-UPS1250 to earth ground. (Refer to the grounding diagram in the front of this manual.)

---

## Programming Software

---

### Have a question or comment about Crestron software?

Answers to frequently asked questions (FAQs) can be viewed in the Online Help section of the Crestron website. To post a question or view questions you have submitted to Crestron's True Blue Support, log in at <http://support.crestron.com>. First-time users will need to establish a user account.

---

### Earliest Version Software Requirements for the PC

---

**NOTE:** Crestron recommends that you use the latest software to take advantage of the most recently released features. The latest software is available from the Crestron website.

---

Crestron has developed an assortment of Windows®-based software tools to develop a controlled system. For the minimum recommended software versions, visit the Version Tracker page of the Crestron website ([www.crestron.com/versiontracker](http://www.crestron.com/versiontracker)).

### Programming with Crestron SystemBuilder

Crestron SystemBuilder is the easiest method of programming but does not offer as much flexibility as SIMPL Windows. For additional details, download SystemBuilder from the Crestron website and examine the extensive help file.

### Programming with SIMPL Windows

---

**NOTE:** While SIMPL Windows can be used to program the CEN-UPS1250, it is recommended to use SystemBuilder for configuring a system.

---

SIMPL Windows is Crestron's premier software for programming Crestron control systems. It is organized into two separate but equally important "Managers".

#### **Configuration Manager**

Configuration Manager is the view where programmers "build" a Crestron control system by selecting hardware from the *Device Library*.

- To incorporate the CEN-UPS1250 into the system, drag the CEN-UPS1250 from the Ethernet Control Modules | Ethernet I/O Control folder of the *Device Library* and drop it in the *System Views*.

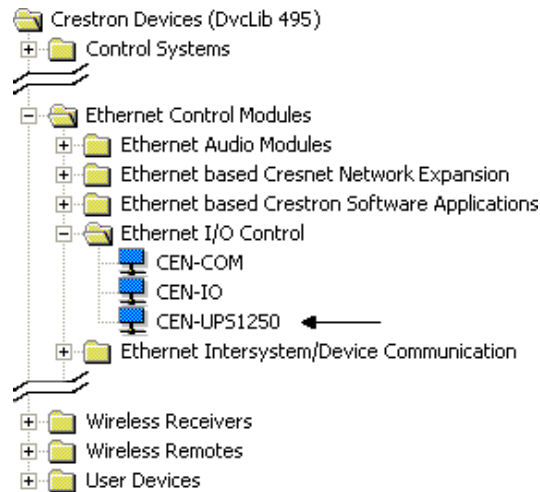
*Locating the CEN-UPS1250 in the Device Library*

- The system tree of the control system displays the device in the appropriate slot with a default IP ID as shown in the following illustration.

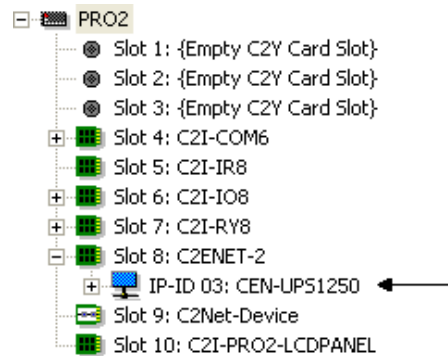
*C2Net Device, Slot 8*

- Additional CEN-UPS1250 devices are assigned different IP ID numbers as they are added.
- If necessary, double click a device to open the “Device Settings” window and change the IP ID, as shown in the following figure.



*“CEN-UPS1250 Device Settings” Window*

- The ID code specified in the SIMPL Windows program must match the IP ID of each unit. Refer to “Identity Code” on page 11.

### *Program Manager*

Program Manager is the view where programmers “program” a Crestron control system by assigning signals to symbols.

The symbol can be viewed by double clicking on the icon or dragging it into *Detail View*. Each signal in the symbol is described in the SIMPL Windows help file (**F1**).

## Example Program

An example program for the CEN-UPS1250 is available from the Crestron website ([www.crestron.com/exampleprograms](http://www.crestron.com/exampleprograms)).

## Uploading and Upgrading

Crestron recommends using the latest programming software and that each device contains the latest firmware to take advantage of the most recently released features. However, before attempting to upload or upgrade it is necessary to establish communication. Once communication has been established, files (for example, programs or firmware) can be transferred to the control system (and/or device). Finally, program checks can be performed (such as changing the device ID or creating an IP table) to ensure proper functioning.

### Establishing Communication

Use Crestron Toolbox for communicating with the CEN-UPS1250; refer to the Crestron Toolbox help file for details. There are two methods of communication.

#### USB Communication

**NOTE:** Required for initial setup of Ethernet parameters.

##### USB Communication

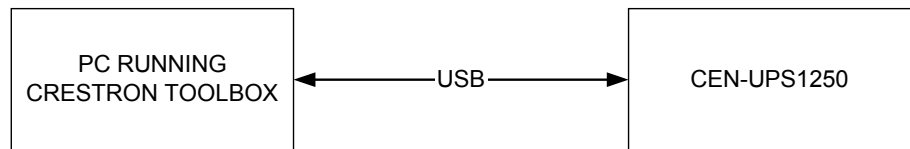

- The **COMPUTER** port on the CEN-UPS1250 connects to the USB port on the PC via the included Type A to Type B USB cable.
- Use the Address Book in Crestron Toolbox to create an entry using the expected communication protocol (USB). When multiple USB devices are connected, identify the CEN-UPS1250 by entering "CEN-UPS1250" in the *Model* textbox, the unit's serial number in the *Serial* textbox or the unit's hostname in the *Hostname* textbox. The hostname can be found in the "System Info" window in the section marked *Ethernet* however, communications must be established in order to see this information in the "System Info" window.
- Display the CEN-UPS1250's "System Info" window (click the  icon); communications are confirmed when the device information is displayed.

#### TCP/IP Communication

**NOTE:** Required for operation with a Crestron control system.

##### Ethernet Communication

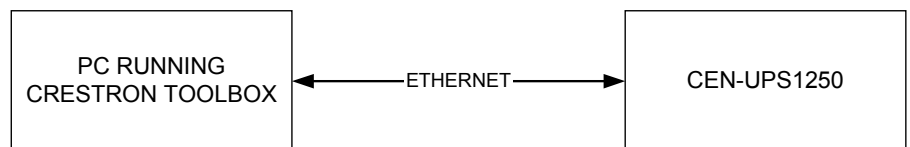

- Establish serial communication between CEN-UPS1250 and PC.

- Enter the IP address, IP mask and default router of the CEN-UPS1250 via the Crestron Toolbox (**Functions | Ethernet Addressing**); otherwise enable DHCP.
- Confirm Ethernet connections between CEN-UPS1250 and PC. If connecting through a hub or router, use CAT5 straight through cables with 8-pin RJ-45 connectors. Alternatively, use a CAT5 crossover cable to connect the two LAN ports directly without using a hub or router.
- Use the Address Book in the Crestron Toolbox to create an entry for the CEN-UPS1250 with the CEN-UPS1250's TCP/IP communication parameters.
- Display the "System Info" window (click the  icon) and select the CEN-UPS1250 entry.

## Programs and Firmware

Program or firmware files may be distributed from programmers to installers or from Crestron to dealers. Firmware upgrades are available from the Crestron website as new features are developed after product releases. One has the option to upload programs via the programming software or to upload and upgrade via the Crestron Toolbox. For details on uploading and upgrading, refer to the SIMPL Windows help file or the Crestron Toolbox help file.

### *SIMPL Windows*

If a SIMPL Windows program is provided, it can be uploaded to the control system using SIMPL Windows or Crestron Toolbox.

### *Firmware*

Check the Crestron website to find the latest firmware. (New users may be required to register to obtain access to certain areas of the site, including the FTP site.)

Upgrade CEN-UPS1250 firmware via Crestron Toolbox.

- Establish communication with the CEN-UPS1250 and display the "System Info" window.
- Select **Functions | Firmware...** to upgrade the CEN-UPS1250 firmware.

## Program Checks

In Crestron Toolbox, display the "System Info window (click the  icon) and select the **Functions** menu to display actions that can be performed on the CEN-UPS1250.

Be sure to use the Crestron Toolbox to create the CEN-UPS1250 IP table.

- Select **Functions | IP Table Setup**.
- Add, modify or delete entries in the IP table. The CEN-UPS1250 can have only one IP table entry.
- A defined IP table can be saved to a file or sent to the device.

Edit the control system's IP table to include an entry for the CEN-UPS1250. The entry should list the CEN-UPS1250's IP ID (specified on the CEN-UPS1250's IP table) and the internal gateway IP address 127.0.0.1.

---

## Operation

### Performing the System Test

Before connecting equipment to the CEN-UPS1250, ensure the unit is functional by connecting the AC power cord provided with the unit to the AC power connector on the rear panel and then to an AC outlet. Also, ensure the internal battery is connected. Press the front panel power switch. Once power is applied to the unit, the display provides the information screens shown below and defined in the accompanying paragraphs.

The “CRESTRON CEN-UPS1250” screen indicates the unit has power and is functioning.

*“CRESTRON CEN-UPS1250” Screen*

**CRESTRON  
CEN-UPS1250**

The “POWER CONDITIONER WITH BATTERY BACKUP” screen indicates the proper firmware was installed for the model purchased.

*“POWER CONDITIONER WITH BATTERY BACKUP” Screen*

**POWER CONDITIONER  
WITH BATTERY BACKUP**

The “DELAYED OUTLET1:ON; DELAYED OUTLET2:OFF” screen indicates power is available to the devices connected to the rear panel outlets marked **BANK 3**. It also shows that power is not yet available to the devices connected to the rear panel outlets marked **BANK 4**. Power to the **BANK 4** devices will be available after the factory preset delay (five seconds) has elapsed. Refer to “Setup Screens” which starts on page 26 to change the delay period. Once power is available for **BANK 4** devices, the screen will change to **DELAYED OUTLETS2: ON** and the **DELAY AMP** LED will be lit.

*“DELAYED OUTLET1:ON; DELAYED OUTLET2:OFF” Screen*

**DELAYED OUTLET1:ON  
DELAYED OUTLET2:OFF**

The “SELFTTEST IS ON; ON-LINE SELFTTEST” screen indicates the selftest is on and the on-line selftest is active. This selftest is conducted using utility power.

*“SELFTEST IS ON...; ON-LINE SELFTEST” Screen*

**SELFTEST IS ON...  
ON-LINE SELFTEST**

The “SELFTEST IS ON; ON-BATTERY SELFTEST” screen indicates the on-battery selftest is active with the unit internally switched to derive power from the internal battery pack (which should already be connected within the unit). The **BATT IN USE LED** is also lit during this test.

*“SELFTEST IS ON...; ON-BATTERY SELFTEST” Screen*

**SELFTEST IS ON...  
ON-BATTERY SELFTEST**

The “SELFTEST RESULT: TEST HAS PASSED” screen indicates the selftest ran successfully to completion. If the message TEST HAS FAILED is displayed, please contact Crestron Technical Support.

*“SELFTEST RESULT: TEST HAS PASSED” Screen*

**SELFTEST RESULT:  
TEST HAS PASSED**

The “DATAPORT: USB” screen indicates whether the USB cable is connected or disconnected. In the example screen below, the USB cable is not connected.

*“DATAPORT: USB” Screen*

**DATAPORT: USB  
REMOVED**

During the selftest, the unit will also test to determine if an optional external battery pack (available from APC) is connected. If no external battery pack is connected to the unit, the message NO EXTERNAL BATTERY CONNECTED will be displayed, as shown below.

*“NO EXTERNAL BATTERY CONNECTED” Screen*

**NO EXTERNAL BATTERY  
CONNECTED**

## Status and Informational Screens

The following paragraphs describe the various status and informational screens that are available with the CDN-UPS1250. These are accessed by using the **STATUS** button on the front panel.

---

**NOTE:** For your convenience, you can set the unit to display any of the status screens as the “default” screen. The default screen is the screen that the system will return to once the preset time has expired for other screens that are being displayed.

**NOTE:** The display will revert to the default screen after about 30 seconds of inactivity. To change the default screen, first press the **STATUS** button until the desired screen is displayed. Then press and hold the **STATUS** button for approximately three seconds until the screen displays CURRENT SCREEN IS SAVED AS DEFAULT.

---

The “SOURCE: XXXXXXXX; EST. RUNTIME: XHRS” screen displays which type of source the unit is deriving power from (UTILITY, BATTERY or STANDBY). It also displays the EST. RUNTIME based on the power source and connected equipment load. In STANDBY, the unit does not provide power to the rear panel outlets.

---

**NOTE:** When the CEN-UPS1250 is connected to utility power, the electronics inside the unit are active. If the front panel power switch is turned off, the unit goes into STANDBY mode and shuts off power to the rear panel outlets but the display remains active.

---

### “SOURCE: UTILITY; EST. RUNTIME: XHRS” Screen

SOURCE:UTILITY  
EST.RUNTIME:2HRS

### “SOURCE: BATTERY; EST. RUNTIME: XHRS” Screen

SOURCE:BATTERY  
EST.RUNTIME:118MIN

The “EST. RUNTIME: XHRS; FUEL: XXX%” screen displays the estimated runtime as EST. RUNTIME, as well as the FUEL capacity of the internal battery pack (as a percentage) based on the total load connected to the device. If the estimated runtime is less than one hour, the EST. RUNTIME will show in minutes.

### “EST. RUNTIME: XHRS; FUEL: XXX%” Screen

EST.RUNTIME: 2HRS  
FUEL: 100%

The “SYSTEM LOAD: XXXW; LOAD: XXX%” screen displays the value (load) of the connected equipment in Watts and as a percentage of the total allowable load

connected to the unit. Loads of less than 5% of rates load (63 Watts) will be displayed as <5%.

**“SYSTEM LOAD: XXXW; LOAD: XXX%” Screen**

**SYSTEM LOAD: <63W**  
**LOAD: <5%**

The “INPUT VOLTAGE: XXXV; OUTPUT VOLTAGE: XXXV” screen displays the actual input utility voltage level as well as the actual voltage level being output to the connected devices.

---

**NOTE:** As shown in the illustration below, at times, the voltage values on the screen may not match. This may be because separate circuits are used to make these voltage measurements and there is a time delay between the two circuits when updating the status screen. This condition is considered part of the normal operation of the unit.

---

**“INPUT VOLTAGE: XXXV; OUTPUT VOLTAGE: XXXV” Screen**

**INPUT VOLTAGE:124V**  
**OUTPUT VOLTAGE:125V**

The “INPUT FREQ: XXHZ; OUTPUT FREQ: XXHZ” screen displays the actual input utility voltage frequency as well as the actual voltage frequency being output to the connected devices.

---

**NOTE:** At times, the frequency values on this screen may not match. This is because separate circuits are used to make frequency measurements and there is a time delay between the two circuits when updating the status screen. This condition is considered part of the normal operation of the unit.

---

**“INPUT FREQ: XXHZ; OUTPUT FREQ: XXHZ” Screen**

**INPUT FREQ:60HZ**  
**OUTPUT FREQ:60HZ**

The outlet status screens shown below display which of the four outlet banks are turned on or off. The outlet banks can be turned on or off independently using a control system connected via the LAN port on the rear panel.

**“BANK1 (DIGITAL): ON; BANK2 (DISPLAY): ON” Screen**

**BANK1 (DIGITAL):ON**  
**BANK2 (DISPLAY):ON**

*“BANK3 (ANALOG):ON; BANK4 (HI AMP):ON” Screen*

```
BANK3 (ANALOG):ON  
BANK4 (HI AMP):ON
```

The model number and serial number screen displays information about your CEN-UPS1250.

*“MODEL #; S/N” Screen*

```
MODEL#:CEN-UPS 1250  
S/N:PB0707130791
```

The “ENV. TEMPERATURE” screen displays room temperature in both Celsius and Fahrenheit when the included temperature/RH sensor is connected to the unit. The values displayed may be rounded.

*“ENV. TEMPERATURE” Screen*

```
ENV. TEMPERATURE:  
24.50C           76.0F
```

The “R. HUMIDITY” screen displays the relative humidity when the included temperature/RH sensor is connected to the unit.

*“R. HUMIDITY” Screen*

```
R. HUMIDITY: NOT AVAIL
```

## Setup Screens

You can use the front panel **SETUP** and up/down arrow buttons to configure (turn on or off) various functions provided by each CEN-UPS1250 unit. When you press the **SETUP** button, the unit functions are displayed in the following order:

1. Audible Alarm
2. Sensitivity
3. Display Dimmer
4. LED Dimmer
5. Go To Battery If <XX Volts
6. Go To Battery If >XX Volts
7. Outlet Delay1
8. Outlet Delay2
9. Low Battery Warning



10. Battery Replacement Date
11. Do Quick Selftest
12. Do Runtime Calculation
13. Display Beep Test
14. Screen Saver On/Off
15. Reset To Default

**AUDIBLE ALARM** setting – When the alarm is set to ON, it indicates an abnormal condition with the power or unit. It provides an audible tone (beep) whenever the unit detects an internal problem or a problem with an externally connected battery pack. When it is set to OFF, the audible tone is silenced.

*“AUDIBLE ALARM” Screen*

**AUDIBLE ALARM:OFF**  
**PRESS ↑↓ TO CHANGE**

**SENSITIVITY** setting – This feature is used to adjust how the unit reacts to input voltage waveform distortion and momentary power fluctuations. It allows you to adjust the sensitivity of the CEN-UPS1250 to **LOW**, **MEDIUM** and **HIGH** using the up/down arrow buttons.

The **SENSITIVITY** adjustments have the following values:

- **HIGH** – This should be used when the connected equipment is sensitive to momentary low voltage or brief power fluctuations. When it is set to **HIGH**, the unit is very sensitive to voltage distortion and is more likely to switch back and forth to battery power than it would at a **MEDIUM** or **LOW** setting.
- **MEDIUM** – This is the default setting suitable for most situations.
- **LOW** – this setting should be used when the CEN-UPS1250 frequently goes to battery (even though the utility voltage appears normal).

*“SENSITIVITY” Screen*

**SENSITIVITY:MEDIUM**  
**PRESS ↑↓ TO CHANGE**

**DISPLAY DIMMER** setting – This lets you set a brightness level for the display of **HIGH**, **LOW** or **OFF**. Repeatedly pressing the up/down arrow buttons allows you to set the brightness of the display. Once the display brightness is set to the desired level, press the **SETUP** button to store the setting.

---

**NOTE:** Even when the display dimmer is set to **OFF**, the screen will turn back on momentarily when there is a significant change in system status, such as a power outage or a low battery condition.

---

*“DISPLAY DIMMER” Screen*

DISPLAY DIMMER:HIGH  
PRESS ↑↓ TO CHANGE

LED DIMMER setting – This screen lets you set a brightness level of HIGH, LOW or OFF for the front panel LED indicators. Press the up/down arrow buttons to set the brightness level of the LEDs.

*“LED DIMMER” Screen*

LED DIMMER:HIGH  
PRESS ↑↓ TO CHANGE

GO TO BAT IF < XXXV setting – This setting allows you to set a low voltage threshold for the unit, which will force it to switch to power from the internal battery pack when the threshold is reached. Settings range from 92 to 100 Volts.

*“GOTO BAT IF < XXV” Screen*

GOTO BAT IF < 100V  
PRESS ↑↓ TO CHANGE

GO TO BAT IF > XXXV setting – This setting allows you to set a high voltage threshold for the unit, which will force it to switch to power from the internal battery pack when the threshold is reached. Settings range from 134 to 142 Volts.

*“GOTO BAT IF > XXV” Screen*

GOTO BAT IF > 134V  
PRESS ↑↓ TO CHANGE

OUTLET DELAY1 and OUTLET DELAY2 setting – These settings let you define a time delay (0 to 10 seconds) for when the unit provides power to the rear panel outlets marked BANK 3 and BANK 4 respectively. By setting this delay, it prevents power on or power off glitches from affecting other equipment connected to the unit.

*“OUTLET DELAY1” Screen*

OUTLET DELAY1:5SEC  
PRESS ↑↓ TO CHANGE

*“OUTLET DELAY2” Screen*

OUTLET DELAY2:5SEC  
PRESS ↑↓ TO CHANGE

LOWBATWARNING setting – This screen lets you set the unit to sound an alarm and illuminate the **LOW BATT** LED on the front panel whenever the battery pack’s estimated runtime remaining drops to or below the programmed setting (2 to 26 minutes).

*“LOWBATWARNING” Screen*

LOWBATWARNING:2MIN  
PRESS ↑↓ TO CHANGE

BATREPDATE setting – This function allows you to input the exact date a replacement battery pack is installed in the unit. First, use the up/down arrow buttons to set the correct month, then press the **SETUP** button to move the cursor to the day of the month field. Set the day of the month using the up/down arrow buttons. Press the **SETUP** button to move the cursor to the year field. Set the year using the up/down arrow buttons.

*“BATREPDATE” Screen*

BATREPDATE:02/19/07  
PRESS ↑↓ TO CHANGE

DO QUICK SELFTEST setting – This function lets you manually initiate a selftest to ensure the battery pack is in good health and that the unit is operating properly.

---

**NOTE:** When you advance to this screen, press the up/down arrow buttons to start the selftest. During the selftest, the same screens that were previously defined in this manual are displayed. (Refer to “Performing the System Test” on page 22 for details.)

---

*“DO QUICK SELFTEST” Screen*

DO QUICK SELFTEST:NO  
PRESS ↑↓ TO CHANGE

DO RUNTIME CAL setting – This function allows you to manually initiate a runtime calculation test to calibrate internal measurements, which should result in more accurate runtime estimates. This should be done once every six months or when the connected load size changes significantly. Once initiated, the unit will operate on battery power until a low battery condition occurs.

---

**NOTE:** Before you initiate RUNTIME CAL, the battery must be at 100% capacity (fully charged) and the load must be greater than 10% of the rated load.

---

*“DO RUNTIME CAL” Screen*

**DO RUNTIME CAL:NO  
PRESS ↑↓ TO CHANGE**

DISPLAY-BEEP TEST setting – This function allows you to force the unit to perform display and beep tests. Simply press either the up or down arrow button. This will cause all the indicators and display fields to illuminate, as shown in the illustration on the following page) and an audible beep to sound.

*“DISPLAY-BEEP TEST” Screen*

**DISPLAY-BEEP TEST:NO  
PRESS ↑↓ TO CHANGE**

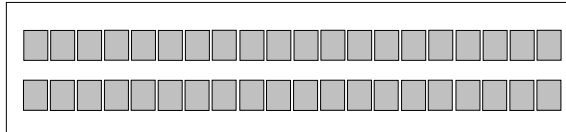
*Display-Beep Testing Screen*

SCREEN SAVER setting – This function allows you to force the unit to continuously alternate the message CEN-UPS POWER CONDITIONER WITH BATTERY BACKUP between the two lines of fields on the display. This feature helps maintain display quality as well as extending the life of the display.

---

**NOTE:** Even when the screen saver is set to ON, the screen saver message will only display when the system load is less than 5%.

---

*“SCREEN SAVER” Screen*

**SCREEN SAVER:ON  
PRESS ↑↓ TO CHANGE**

RESET TO DEFAULT setting – This function allows you to force the unit to reset all previous settings to the factory default values. Simply press either the up or down arrow button. The system will display two messages: INITIALIZING SETUP TO FACTORY DEFAULT and INITIALIZATION COMPLETE. The system then returns to the RESET TO DEFAULT screen.

---

**NOTE:** The screen illustrations in this section show default values.

---

*“RESET TO DEFAULT” Screen*

**RESET TO DEFAULT:NO  
PRESS ↑↓ TO CHANGE**

## Problem Solving

### Troubleshooting

The following table provides corrective action for possible trouble situations. If further assistance is required, please contact a Crestron customer service representative.

#### *CEN-UPS1250 Troubleshooting*

TROUBLE	POSSIBLE CAUSE(S)	CORRECTIVE ACTION
Device does not function.	Battery is not connected.	Remove the front bezel by grasping the handles and pulling straight back. The battery is located on the right side of the unit. The black battery connector should be pushed snugly into the battery socket located just to the left of the battery pack. (Refer to "Inserting and Connecting the Battery" in the "Installation" section, which starts on page 11.
	No power or insufficient power is available at the wall outlet.	Ensure the wall outlet has good power by checking it with a voltmeter or by plugging the power cord of a known good device into the outlet. <b>NOTE:</b> The unit will not turn on and accept incoming utility power if the power is out of range. The unit can still be "cold started" using battery power by pressing and holding the power switch in until the unit beeps.
	Circuit breaker has tripped.	Check both your home and unit circuit breakers. If the circuit breaker on the rear of the CEN-UPC1250 has tripped, the center post will be extended out about ¼ to ½ inch. Push it back in to reset it. If it trips again, reduce the number of devices that are plugged into the unit one at a time and try again. <b>NOTE:</b> The unit circuit breaker is rated for 15 Amps, however, the National Electrical Code (NEC) dictates that any particular home circuit should not be loaded to more than 80% of its rating.
Loss of functionality due to electrostatic discharge.	Improper grounding.	Check that all ground connections have been made properly.

## Reference Documents

The latest version of all documents mentioned within the guide can be obtained from the Crestron website ([www.crestron.com/manuals](http://www.crestron.com/manuals)). This link will provide a list of product manuals arranged in alphabetical order by model number.

### *List of Related Reference Documents*

DOCUMENT TITLE
Crestron e-Control Reference Guide

## Further Inquiries

If you cannot locate specific information or have questions after reviewing this guide, please take advantage of Crestron's award winning customer service team by calling the Crestron corporate headquarters at 1-888-CRESTRON [1-888-273-7876]. For assistance in your local time zone, refer to the Crestron website ([www.crestron.com/offices](http://www.crestron.com/offices)) for a listing of Crestron worldwide offices.

You can also log onto the online help section of the Crestron website ([www.crestron.com/onlinehelp](http://www.crestron.com/onlinehelp)) to ask questions about Crestron products. First-time users will need to establish a user account to fully benefit from all available features.

## Future Updates

As Crestron improves functions, adds new features and extends the capabilities of the CEN-UPS1250, additional information may be made available as manual updates. These updates are solely electronic and serve as intermediary supplements prior to the release of a complete technical documentation revision.

Check the Crestron website periodically for manual update availability and its relevance. Updates are identified as an “Addendum” in the Download column.

---

## Return and Warranty Policies

### Merchandise Returns / Repair Service

1. No merchandise may be returned for credit, exchange or service without prior authorization from CRESTRON. To obtain warranty service for CRESTRON products, contact an authorized CRESTRON dealer. Only authorized CRESTRON dealers may contact the factory and request an RMA (Return Merchandise Authorization) number. Enclose a note specifying the nature of the problem, name and phone number of contact person, RMA number and return address.
2. Products may be returned for credit, exchange or service with a CRESTRON Return Merchandise Authorization (RMA) number. Authorized returns must be shipped freight prepaid to CRESTRON, 6 Volvo Drive, Rockleigh, N.J. or its authorized subsidiaries, with RMA number clearly marked on the outside of all cartons. Shipments arriving freight collect or without an RMA number shall be subject to refusal. CRESTRON reserves the right in its sole and absolute discretion to charge a 15% restocking fee plus shipping costs on any products returned with an RMA.
3. Return freight charges following repair of items under warranty shall be paid by CRESTRON, shipping by standard ground carrier. In the event repairs are found to be non-warranty, return freight costs shall be paid by the purchaser.

### CRESTRON Limited Warranty

CRESTRON ELECTRONICS, Inc. warrants its products to be free from manufacturing defects in materials and workmanship under normal use for a period of three (3) years from the date of purchase from CRESTRON, with the following exceptions: disk drives and any other moving or rotating mechanical parts, pan/tilt heads and power supplies are covered for a period of one (1) year; touchscreen display and overlay components are covered for 90 days; batteries and incandescent lamps are not covered.

This warranty extends to products purchased directly from CRESTRON or an authorized CRESTRON dealer. Purchasers should inquire of the dealer regarding the nature and extent of the dealer's warranty, if any.

CRESTRON shall not be liable to honor the terms of this warranty if the product has been used in any application other than that for which it was intended or if it has been subjected to misuse, accidental damage, modification or improper installation procedures. Furthermore, this warranty does not cover any product that has had the serial number altered, defaced or removed.

This warranty shall be the sole and exclusive remedy to the original purchaser. In no event shall CRESTRON be liable for incidental or consequential damages of any kind (property or economic damages inclusive) arising from the sale or use of this equipment. CRESTRON is not liable for any claim made by a third party or made by the purchaser for a third party.

CRESTRON shall, at its option, repair or replace any product found defective, without charge for parts or labor. Repaired or replaced equipment and parts supplied under this warranty shall be covered only by the unexpired portion of the warranty.

Except as expressly set forth in this warranty, CRESTRON makes no other warranties, expressed or implied, nor authorizes any other party to offer any warranty, including any implied warranties of merchantability or fitness for a particular purpose. Any implied warranties that may be imposed by law are limited to the terms of this limited warranty. This warranty statement supersedes all previous warranties.

#### Trademark Information

*All brand names, product names and trademarks are the sole property of their respective owners. Windows is a registered trademark of Microsoft Corporation. Windows95/98/Me/XP/Vista and WindowsNT/2000 are trademarks of Microsoft Corporation.*



**Crestron Electronics, Inc.**  
15 Volvo Drive Rockleigh, NJ 07647  
Tel: 888.CRESTRON  
Fax: 201.767.7576  
[www.crestron.com](http://www.crestron.com)

**Operations & Installation Guide – DOC. 6635A**  
**(2019504)**  
**01.08**  
Specifications subject to  
change without notice.



## Free Manuals Download Website

<http://myh66.com>

<http://usermanuals.us>

<http://www.somanuals.com>

<http://www.4manuals.cc>

<http://www.manual-lib.com>

<http://www.404manual.com>

<http://www.luxmanual.com>

<http://aubethermostatmanual.com>

Golf course search by state

<http://golfingnear.com>

Email search by domain

<http://emailbydomain.com>

Auto manuals search

<http://auto.somanuals.com>

TV manuals search

<http://tv.somanuals.com>