

Crestron **Adagio™** AADS

Adagio Audio Distribution System

Operations Guide



This document was prepared and written by the Technical Documentation department at:



Crestron Electronics, Inc.
15 Volvo Drive
Rockleigh, NJ 07647
1-888-CRESTRON

Important Safety Instructions

- Read these instructions.
- Keep these instructions.
- Heed all warnings.
- Follow all instructions.
- Do not use this apparatus near water.
- Clean only with dry cloth.
- Do not block any ventilation openings. Install in accordance with the manufacturer's instructions.
- Do not install near any heat sources such as radiators, heat registers, stoves, or other apparatus (including amplifiers) that produce heat.
- Do not defeat the safety purpose of the polarized or grounding-type plug. A polarized plug has two blades with one wider than the other. A grounding-type plug has two blades and a third grounding prong. The wide blade or the third prong are provided for your safety. If the provided plug does not fit into your outlet, consult an electrician for replacement of the obsolete outlet.
- Protect the power cord from being walked on or pinched particularly at plugs, convenience receptacles, and the point where they exit from the apparatus.
- Only use attachments/accessories specified by the manufacturer.
- Unplug this apparatus during lightning storms or when unused for long periods of time.
- Refer all servicing to qualified service personnel. Servicing is required when the apparatus has been damaged in any way, such as power-supply cord or plug is damaged, liquid has been spilled or objects have fallen into the apparatus, the apparatus has been exposed to rain or moisture, does not operate normally, or has been dropped.
- Disconnect power prior to connecting or disconnecting equipment.
- Do not install in direct sunlight.
- The apparatus must be installed in a way that the power cord can be removed either from the wall outlet or from the device itself in order to disconnect the mains power.
- Prevent foreign objects from entering the device.

WARNING:

TO REDUCE THE RISK OF FIRE OR ELECTRIC SHOCK, DO NOT EXPOSE THIS APPARATUS TO RAIN OR MOISTURE. THE APPARATUS SHALL NOT BE EXPOSED TO DRIPPING OR SPLASHING. OBJECTS FILLED WITH LIQUIDS, SUCH AS VASES, SHOULD NOT BE PLACED ON THE APPARATUS.

WARNING:

TO PREVENT ELECTRIC SHOCK, DO NOT REMOVE COVER. THERE ARE NO USER SERVICEABLE PARTS INSIDE. ONLY QUALIFIED SERVICE PERSONNEL SHOULD PERFORM SERVICE.



AVIS: RISQUE DE CHOC ELECTRIQUE NE PAS OUVRIR



The lightning flash with arrowhead symbol, within an equilateral triangle, is intended to alert the user to the presence of uninsulated "dangerous voltage" within the product's enclosure that may be of sufficient magnitude to constitute a risk of electric shock to persons.



The exclamation point within an equilateral triangle is intended to alert the user to the presence of important operating and maintenance (servicing) instructions in the literature accompanying the appliance.

WARNING:

THIS IS AN APPARATUS WITH CLASS I CONSTRUCTION. IT SHALL BE CONNECTED TO AN ELECTRICAL OUTLET WITH AN EARTHING GROUND TERMINAL.

IMPORTANT:

The AADS can be used with Class 2 output wiring.

Contents

Audio Distribution System: Adagio AADS	1
Introduction	1
Features and Functions	1
Multi-Room Audio	2
High-End Performance.....	2
Front Panel Control	2
Preset Groups	2
Versatile Room Controls.....	2
Dual AM/FM Radio, XM Radio, and MP3 Audio Servers	2
2-Series Ethernet Control System	3
Home Automation and Integration.....	3
Applications.....	3
Specifications	5
Physical Description.....	8
Industry Compliance	15
Setup.....	16
Network Wiring.....	16
Hardware Hookup	16
Configuration.....	23
Configure the AADS for Operation.....	23
Configure Sources	30
Configure Rooms	31
Configure Presets	33
Operation	36
Source Mode.....	36
Controlling a Tuner	36
Controlling an iPod	43
Controlling an Adagio Audio Server (AAS).....	45
Route a Source	49
Room Mode.....	50
Recall a Preset Group	52
Turn off the System.....	53
Programming Software.....	54
Earliest Version Software Requirements for the PC	54
Programming with Adagio Composer	54
Programming with Crestron SystemBuilder.....	55
Programming with SIMPL Windows	55
Example Program	56
Uploading and Upgrading.....	57
Establishing Communication.....	57
Programs and Firmware	58
Problem Solving	59
Troubleshooting.....	59
Check Network Wiring.....	60
Reference Documents.....	61
Further Inquiries	61

Future Updates	61
Appendix: RDS/RBDS Function Support.....	62
Return and Warranty Policies	63
Merchandise Returns / Repair Service	63
CRESTRON Limited Warranty.....	63

Audio Distribution System: Adagio AADS

Introduction

Features and Functions

- Whole-house audio distribution system
- Out-of-the-box functionality (no programming required):
 - ⇒ Audio distribution for six rooms at 45 watts per channel; expandable up to 12 rooms when used with Adagio Audio Expander (AAE)
 - ⇒ Control from front panel or any combination of six (up to 12 if used with AAE) APAD LCD controllers or C2N-DBF12 12-button room keypads
 - ⇒ Built-in support for (1) Interface for Apple iPod® (CEN-IDOC), (1) AAE and (1) Adagio Audio Server (AAS)
- 45 watts per channel for six rooms, expandable to 24 rooms with additional AAEs
- Four inputs for line-level audio sources
- Front panel control provides flexible control of whole-house audio
- Control audio functions from the built-in LCD-driven front panel, 12-button room keypads, or APAD LCD controllers. Other control devices can be used with additional programming
- Two built-in AM/FM radio tuners with RDS/RBDS¹ (one AM/FM tuner on AADS-XM)
- XM^{®2} Satellite Radio (AADS-XM)
- Plug-and-play support for AAS Audio Servers (AAS-1, AAS-2, AAS-4) and Interface for Apple iPod (CEN-IDOC)
- 2-Series Ethernet control system — programmable to support Crestron® touchpanels, wireless remotes, lighting dimmers, thermostats, and more!

1. The Radio Data System (RDS), a European standard, and Radio Broadcast Data System (RBDS), a North American standard, permit broadcasters to use a sub-carrier frequency to transmit inaudible digital data along with their regular FM programming to receivers equipped to process the data. Refer to “Appendix: RDS/RBDS Function Support” on page 62 for more information.
2. Hardware and required basic monthly subscription sold separately. Premium Channel available at additional monthly cost. Installation costs and other fees and taxes, including a one-time activation fee may apply. Subscription fee is consumer only. All fees and programming subject to change. Subscriptions subject to Customer Agreement available at xmradio.com. Only available in the 48 contiguous United States. ©2006 XM Satellite Radio Inc. All rights reserved. All other trademarks are the property of their respective owners.

Multi-Room Audio

The AADS supports up to six sets of stereo room speakers, allowing listeners in each room to listen selectively to any of six different stereo sources. Its integrated multi-channel power amplifier delivers a robust 45 watts per channel to all rooms. Without requiring any programming, the AADS can easily be expanded to support a total of 12 rooms by adding an AAE Audio Expander. Or, as many as 24 rooms can be handled using three AAEs with simple setup provided by Crestron Adagio Composer software.

High-End Performance

An advanced Class G amplifier topology produces the great sound of a classic Class AB design with near-digital efficiency. A massive MOH-core toroidal power transformer directs pure, continuous power to each channel, achieving exceptional dynamic range and low distortion sound quality in every room. Gentle power-up is achieved through a “soft-start” inrush current limiting circuit, and quick-response output protection on each channel prevents failure caused by speaker line faults and overheating.

Front Panel Control

The AADS's front panel provides for controlling audio to a houseful of speakers, with custom naming of rooms and sources facilitated on the LCD display. The six room select buttons can also be custom labeled using Crestron Engraver software.

Preset Groups

The "Group" feature makes it simple to combine speakers in adjacent rooms, or switch into whole-house party mode, by letting the user link any number of rooms to function as one. Grouping lets you easily route one source to multiple rooms at once without the sync problems common to streaming-based systems. Up to six groups can be defined within the *Preset* mode.

Versatile Room Controls

A choice of basic 12-button keypads or the advanced APAD Wall Mount LCD Controller enables versatile control of the AADS in every room. A keypad provides the essential controls for adjusting volume, selecting sources, and toggling up and down through tracks and radio channels. For more elegant control, the APAD provides true feedback for display of audio sources, radio stations, CD titles, artists, and tracks by name, plus audio settings and many other parameters.

Dual AM/FM Radio, XM Radio, and MP3 Audio Servers

Two built-in AM/FM radio tuners let listeners in different rooms each enjoy their own choice of music, news, sports and talk. RDS/RBDS enables the display of the full radio station name and other detailed information about the song or program that is selected.

The AADS-XM includes an XM Satellite Radio tuner for additional programming variety.

In addition to radio, four line-level inputs are provided to accommodate external audio sources including Crestron's AAS Audio Server and CEN-IDOC Interface for Apple iPod. Plug-and-play compatibility with the AAS and CEN-IDOC delivers instant access to an entire collection of music from any room in the house with fully-bidirectional communications for browsing by album, artist, and song title.

2-Series Ethernet Control System

At the heart of the AADS is the powerful 2-Series control engine. With both Cresnet® and Ethernet connectivity, plus custom programmability using Crestron SystemBuilder™ software, the AADS allows nearly limitless expansion and customization using Crestron's entire line of touchpanels, wireless remotes, and hundreds of other devices. The built-in Web server with native e-Control®2 XPanel support enables full remote control over IP from computers and PDA devices, as well as remote diagnostics and updates. Built-in IR and RS-232 ports are included to interface the AADS with non-Crestron devices ranging from CD changers to security systems.

Home Automation and Integration

The AADS can grow as part of a complete home automation solution supporting all of Crestron's Cresnet and iNET™ controllable dimmers, shade controllers, thermostats, and so much more.

Applications

The following diagram shows an AADS as the centerpiece of an Adagio system using out-of-the-box functionality.

AADS as the Centerpiece of an Adagio System

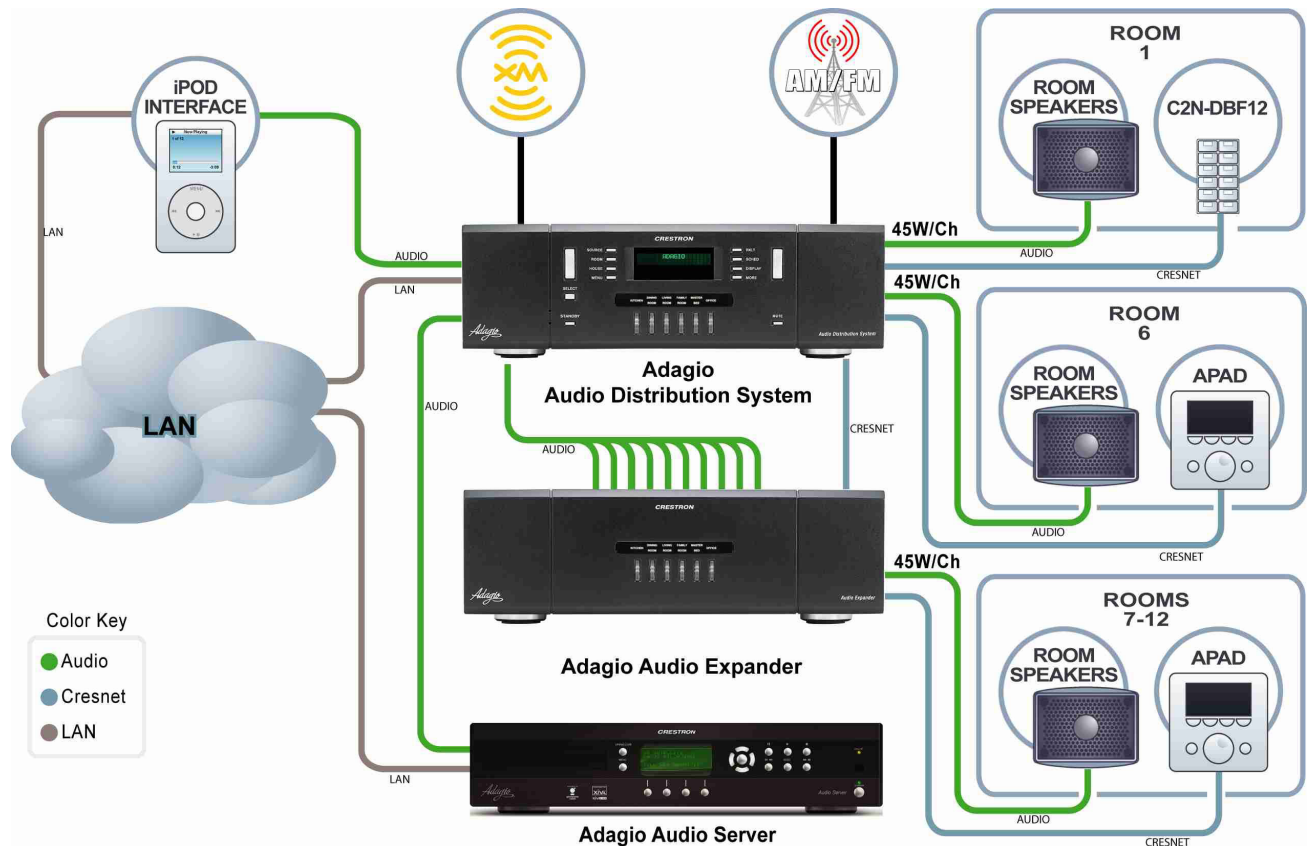

Available models are:

- AADS: AADS with built-in dual AM/FM tuner
- AADS-XM: AADS with built-in AM/FM/XM tuner
- AADSI: AADS for International (230 VAC) use with built-in AM/FM tuner

Out of the box, the AADS can support one AAS (Adagio Audio Server), one AAE (Adagio Audio Expander) for control of up to 12 zones, one CEN-IDOC (Interface for Apple® iPod), and a combination of up to 12 C2N-DBF12 (12-button keypads) or APAD controllers for local control of each zone.

With custom programming (via Adagio Composer, Crestron SystemBuilder™, or SIMPL™ Windows®) additional Crestron and third-party devices may also be added.

Specifications

Specifications for the AADS are listed in the following table.

AADS Specifications

SPECIFICATION	DETAILS
Processor CPU Processing Speed	32-bit Freescale ColdFire® Microprocessor 100 MIPS (Dhrystone 2.1 Benchmark)
Memory	8MB Flash, 32MB SDRAM, 256KB NVRAM
Operating System	Real-time, preemptive, multitasking kernel, multi-threaded, FAT32 file system with long names; supports SIMPL Windows and SIMPL+®
Ethernet	10/100BaseT, static IP or DHCP/DNS, SSL, autonegotiating, full duplex TCP/IP, UDP/IP, SMTP, SNMP, built-in Web server and e-mail client; supports Crestron e-Control®2 XPanel and RoomView® applications
Audio Specifications (Typical of six room outputs)	
Controls	Volume, Balance, Bass, Treble, Loudness, Mute, Mono, Input Compensation
Amplifier Output	
Power	45 Watts into 8 Ohms 60 Watts into 4 Ohms
Frequency Response	20Hz to 20kHz ±0.75dB
Signal-to-Noise Ratio (SNR)	98dB
Total Harmonic Distortion (THD)	0.05%
Stereo Separation	> 75dB
AM Tuner	
Frequency Range	530-1710 kHz
Sensitivity	3.5 µV (RF input level 10dB S+N/N)
Selectivity	10 kHz
Up/Dn Freq Increments	10 kHz/9 kHz
Alternate Channel Selectivity	55 dB
Image Rejection	35 dB
IF Rejection	60 dB
Audio Output level @ 1 kHz	1 V _{rms}

(Continued on following page)

AADS Specifications (Continued)

SPECIFICATION	DETAILS
FM Tuner Frequency Range Step Frequency Intermediate Frequency Usable sensitivity (Mono) S/N Ratio @ 65 dBf IF Rejection AM Rejection Stereo separation Audio Output Level @ 1 KHz XM Satellite Radio Tuner (AADS-XM only)	87.50-108 MHz 50 kHz/ 100 kHz 10.7 MHz 11 dBf 64 dB (mono), 60 dB (stereo) 100 dB 55dB 40 dB 1V _{rms} 160+ digital channels
Inputs Audio Maximum Input Input Impedance Input Compensation Antenna Impedance	(4) unbalanced stereo line-level audio inputs with parallel loop-thrus; connect to outputs of sources, with loop-thru to AAE 3.2 V _{rms} (flat) 47k Ohms ±10dB Antenna inputs for included AM, FM, & XM (AADS-XM only) antennas FM: 75 ohms AM: 50 ohms XM: 50 ohms
Outputs Tuner Maximum Output Output Impedance Infrared/Serial IR output Serial output	(2) unbalanced stereo line-level audio outputs for tuner output signals to connect to AAE AM/FM: 1 V _{rms} XM: 2 V _{rms} 100 Ohms (4) mini-phone jack, IR/Serial port; Up to 1.2 MHz One-way serial TTL/RS-232 (0-5V) up to 9600 baud
Communication Cresnet®	(6) Cresnet Master ports, provide data and power for C2N-DBF12 keypads and APAD devices (2) Cresnet Master ports, paralleled with six Cresnet ports previously described, provide data to connected Adagio Audio Expanders (AAE)

(Continued on following page)

AADS Specifications (Continued)

SPECIFICATION	DETAILS
Communication (continued) Serial Console Ethernet	(1) DB9, male, bidirectional RS-232 ports; Up to 115.2k baud, hardware and software handshaking support for communication with serial devices (1) RJ-11 female, bidirectional RS-232 computer console port for connection to PC (1) RJ-45 port for Ethernet communications
Power Power Consumption AADS/AADS-XM/ AADSI Available Cresnet Power Heat Dissipation* 8-ohm impedance 4-ohm impedance	7 Amps, 120 Volts AC @ 60Hz 3.5 Amps, 230 Volts AC @ 50Hz 20 Watts (0.83 Amps @ 24 Volts DC) 650 BTU/hr 750 BTU/hr
LCD Display	Green LCD dot matrix, two lines by 20 characters, adjustable LED backlight
Environmental Temperature Humidity	41° to 104°F (5° to 40°C) 10% to 90% RH (non-condensing)
Enclosure	Black metal with molded ABS/PC front panel
Dimensions Height Width Depth	5.64 in (14.33 cm) 17.16 in (43.58 cm) 18.11 in (45.99 cm)
Weight	38 lb (17.2 kg)
Available Models AADS AADS-XM AADSI	AADS with dual AM/FM tuners AADS with AM/FM/XM Satellite Radio tuners AADS for International (230 VAC) use with Dual AM/FM tuners

* BTU/hr ratings made while all channels loaded to 1/8 full power with specified impedance.

Physical Description

This section provides information on the connections, controls, and indicators available on your AADS.

AADS Physical View (Front)



AADS Physical View (Rear),



AADS-XM Physical View (Rear),



AADS Overall Dimensions

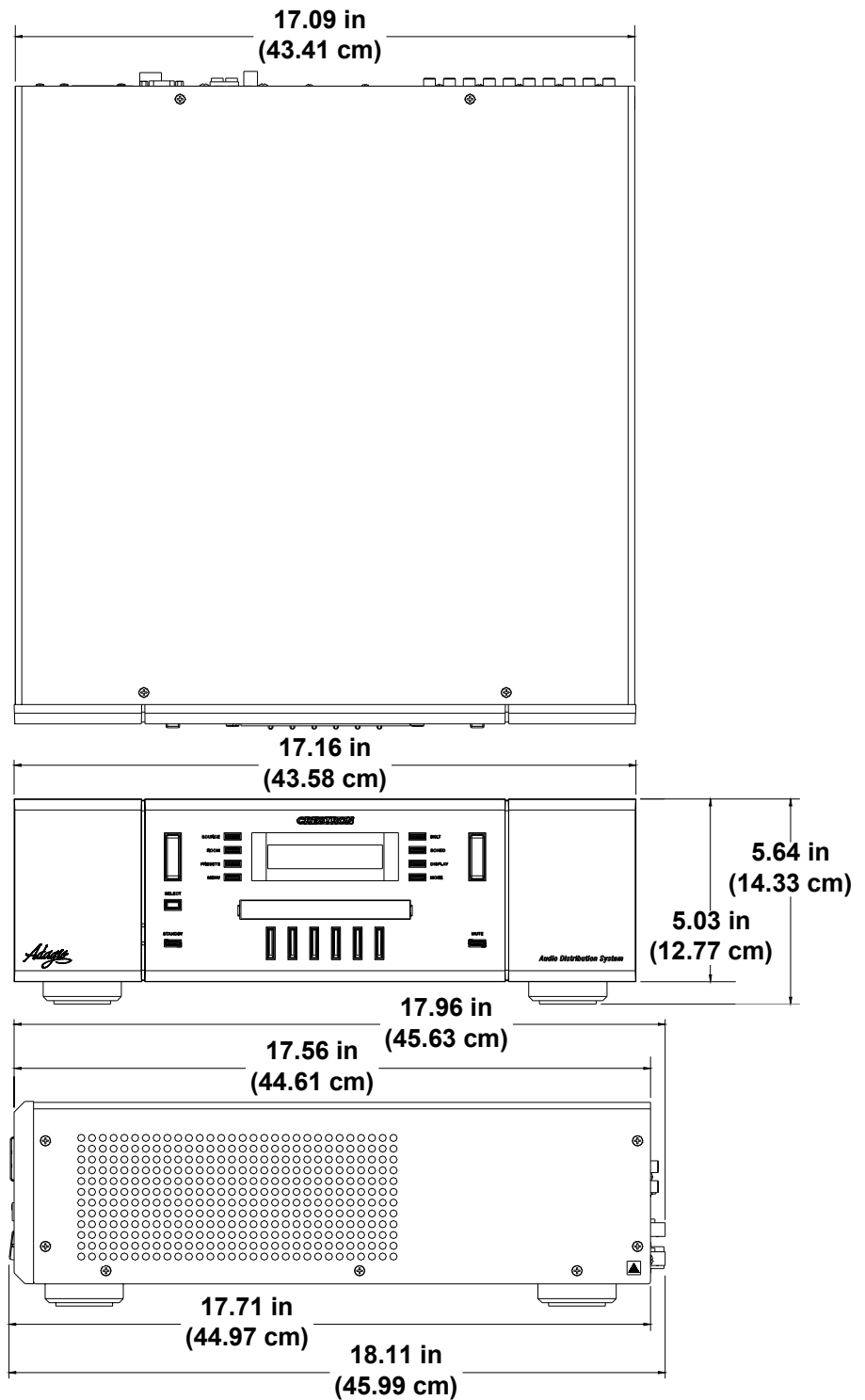

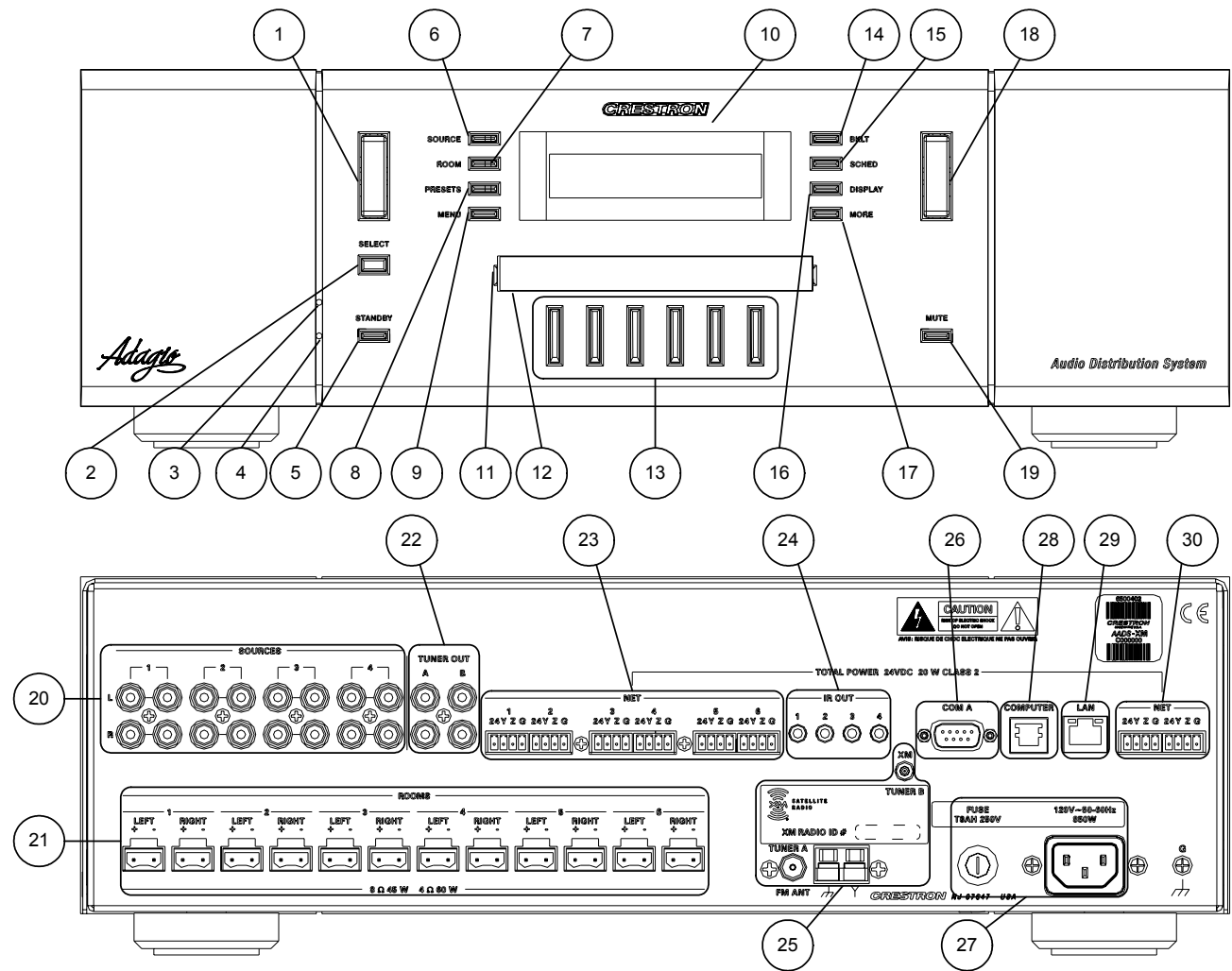

NOTE: Cable connections can extend the overall depth of the AADS by approximately two to three inches.

AADS Buttons and Ports (AADS-XM Shown)













Connectors, Controls, & Indicators

#	CONNECTORS, CONTROLS, & INDICATORS ¹	DESCRIPTION
1	SELECTION CONTROL 	Used to select rooms, sources, and radio stations (when using tuner).
2	SELECT BUTTON SELECT 	The SELECT button confirms changes made to AADS settings.



(Continued on following page)

Connectors, Controls, & Indicators (Continued)

#	CONNECTORS, CONTROLS, & INDICATORS ¹	DESCRIPTION
3	HARDWARE RESET 	Recessed below the front panel. Press this button to initiate a system hardware reset. This has the same effect as disconnecting and reconnecting power.
4	SOFTWARE RESET 	Recessed below the front panel. Press this button while the system is running to restart the program without rebooting the processor. Hold during reboot to bypass the custom program and run the built-in out-of-the-box functionality.
5	STANDBY BUTTON STANDBY 	The STANDBY button places the unit in <i>Standby</i> . The button is lit when the AADS is in use. When in <i>Standby</i> , the button will not be lit, all switching connections are broken, and all of the amplifier and pre-amplifier outputs are powered off. Turning on a room turns on the AADS.
6	SOURCE BUTTON SOURCE 	The SOURCE button places the AADS in the <i>Source</i> mode.
7	ROOM BUTTON ROOM 	The ROOM button places the AADS in the <i>Room</i> mode.
8	PRESETS BUTTON PRESETS 	Used to configure and select preset groups.
9	MENU BUTTON MENU 	The MENU button returns the display (#10) to the previous screen.
10	LIQUID CRYSTAL DISPLAY	The Liquid Crystal Display (LCD) shows system information such as audio controls, tuner controls, and room controls.
11	LABEL ACCESS	A notch in the front panel allows removal of the label cover with a flat-head screwdriver.
12	LABEL STRIP COVER	Covers the engraved label strip.
13	ROOM BUTTONS 	Room buttons select and indicate the room(s) controlled by the AADS. Room buttons also indicate rooms contained in a room group.
14	BKLT  BKLT	The BKLT button adjusts the display and key backlighting to one of three levels (high, medium, low).
15	SCHED  SCHED	The SCHED button places the AADS in the <i>Schedule</i> mode that is programmed in SystemBuilder.
16	DISPLAY  DISPLAY	The DISPLAY button toggles the information shown on the display (i.e. artist and/or song title).

(Continued on following page)

Connectors, Controls, & Indicators (Continued)

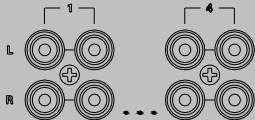
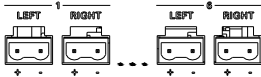
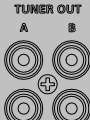
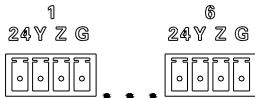
#	CONNECTORS, CONTROLS, & INDICATORS ¹	DESCRIPTION
17	<p>MORE</p> 	The MORE button displays additional information (when available).
18	<p>VOLUME CONTROL</p> 	Push “up” to raise the volume of a room; push “down” to lower the volume of a room. Pressing and releasing the volume control will adjust the volume level in fine increments while pressing and holding the volume control will adjust the volume level in larger increments. Volume level is displayed on the LCD. Operates in <i>Room</i> mode only.
19	<p>MUTE BUTTON</p> 	The MUTE button is used to mute or unmute the currently selected room. When lit, the selected room is muted.
20	<p>SOURCES</p> 	(4) Sets of unbalanced, line-level audio inputs with loop through output.
21	<p>ROOMS</p> 	(6) Sets of speaker-level, mono/stereo outputs provide 45 watts per channel into 8-ohm impedance speakers (60 watts into 4-ohm impedance speakers). Two-pin terminal block interface connectors which accept up to 16 – 14 AWG (1.5 – 2.5 mm ²) speaker wire are included for each speaker terminal.
22	<p>TUNER OUT</p> 	(2) Sets of unbalanced, line-level audio outputs deliver audio from TUNER A and TUNER B to a connected AAE.
23	<p>NET 1-6</p> 	(6) Four-pin terminal blocks provide home run Cresnet® connections to distribute power and Cresnet data to rooms for keypads and/or APADs. Four-pin terminal block interface connectors are included for each port.



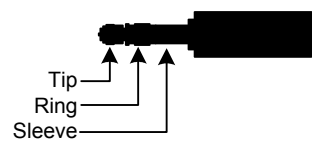
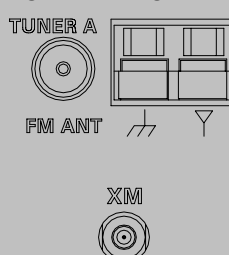
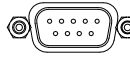

(Continued on following page)

Connectors, Controls, & Indicators (Continued)

#	CONNECTORS, CONTROLS, & INDICATORS ¹	DESCRIPTION																														
24	<p style="text-align: center;">IR OUT IR OUT</p> 	<p>(4) 3.5mm tip-ring-sleeve (TRS) mini-phone ports enable serial communication in a variety of formats including infrared and one-way RS-232; Use Crestron Infrared Emitter Probe (part number STIRP, sold separately) for controlling infrared devices. For information on other serial control cables, contact Crestron.</p>  <p>Tip: IR Data Out Ring: No Connection Sleeve: Ground</p>																														
25	<p style="text-align: center;">TUNER A / TUNER B</p> 	<p>AADS/AADSI: The AADS & AADSI have two AM/FM antenna inputs (labeled TUNER A and TUNER B) for connecting the supplied antennas.</p> <p>AADS-XM: The AADS-XM has one AM/FM tuner input labeled TUNER A and one XM tuner input labeled XM for connecting the supplied antennas.</p>																														
26	<p style="text-align: center;">COM A COM A</p> 	<p>(1) DB9, male, bidirectional RS-232 port; Up to 115.2k baud with hardware and software handshaking support for communication with serial devices. Can also be used for modem communications. The following table lists the pin assignments of the serial ports.</p> <table border="1" data-bbox="1019 1327 1474 1810"> <thead> <tr> <th>PIN</th> <th>DIRECTION</th> <th>DESCRIPTION</th> </tr> </thead> <tbody> <tr> <td>1</td> <td>To AADS</td> <td>(DCD) Data Carrier Detect</td> </tr> <tr> <td>2</td> <td>To AADS</td> <td>(RXD) Receive Data</td> </tr> <tr> <td>3</td> <td>From AADS</td> <td>(TXD) Transmit Data</td> </tr> <tr> <td>4</td> <td>From AADS</td> <td>(DTR) Data Terminal Ready</td> </tr> <tr> <td>5</td> <td>Common</td> <td>(GND) Ground</td> </tr> <tr> <td>6</td> <td>From AADS</td> <td>(DSR) Data Set Ready</td> </tr> <tr> <td>7</td> <td>From AADS</td> <td>(RTS) Request To Send</td> </tr> <tr> <td>8</td> <td>To AADS</td> <td>(CTS) Clear To Send</td> </tr> <tr> <td>9</td> <td>To AADS</td> <td>(RI) Ring Indicator</td> </tr> </tbody> </table>	PIN	DIRECTION	DESCRIPTION	1	To AADS	(DCD) Data Carrier Detect	2	To AADS	(RXD) Receive Data	3	From AADS	(TXD) Transmit Data	4	From AADS	(DTR) Data Terminal Ready	5	Common	(GND) Ground	6	From AADS	(DSR) Data Set Ready	7	From AADS	(RTS) Request To Send	8	To AADS	(CTS) Clear To Send	9	To AADS	(RI) Ring Indicator
PIN	DIRECTION	DESCRIPTION																														
1	To AADS	(DCD) Data Carrier Detect																														
2	To AADS	(RXD) Receive Data																														
3	From AADS	(TXD) Transmit Data																														
4	From AADS	(DTR) Data Terminal Ready																														
5	Common	(GND) Ground																														
6	From AADS	(DSR) Data Set Ready																														
7	From AADS	(RTS) Request To Send																														
8	To AADS	(CTS) Clear To Send																														
9	To AADS	(RI) Ring Indicator																														

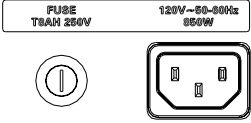
(Continued on following page)

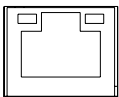
Connectors, Controls, & Indicators (Continued)

#	CONNECTORS, CONTROLS, & INDICATORS ¹	DESCRIPTION
27	<p style="text-align: center;">POWER INPUT</p> 	<p>Fuse terminal and power connector.</p> <p>The AADS requires a T8AH-type fuse rated at 250 Volts². The AADS requires 120 VAC, 50-60 Hz, 7 Amps.</p> <p>The AADSI requires a T4AH-type fuse rated at 250 Volts². The AADSI requires 230 VAC, 50-60 Hz, 3.5 Amps³.</p>
28	<p style="text-align: center;">COMPUTER PIN 1 — COMPUTER</p> 	<p>One 6-pin RJ-11 female, computer console port. Use with included serial cable.</p> <p>Pin 1: CTS Pin 2: GND Pin 3: RXD Pin 4: TXD Pin 5: RTS Pin 6: N/C (Not connected)</p>
29	<p style="text-align: center;">LAN LAN</p> 	<p>One 8-wire, RJ-45 female connector with two LED indicators. The green LED indicates link status while the yellow LED indicates Ethernet activity. The port supports 10BaseT/100BaseTX Ethernet communications.</p>
30	<p style="text-align: center;">NET NET</p> <p style="text-align: center;">24Y Z G 24Y Z G</p> 	<p>(2) Four-pin terminal block connectors provide Cresnet connections to AAE devices. A four-pin terminal block interface connector is included for each port.</p>

1. Interface connectors for **NET** and **ROOMS** ports are provided with the unit.
2. Refer to “Fuse Replacement” on page 20 for additional details.
3. Refer to “Hardware Hookup”, which begins on page 16 for additional cord details.

Industry Compliance

This product is Listed to applicable UL Standards and requirements by Underwriters Laboratories Inc.

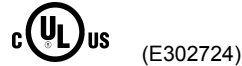

As of the date of manufacture, the AADS has been tested and found to comply with specifications for CE marking and standards per EMC and Radiocommunications Compliance Labelling.



NOTE: This device complies with part 15 of the FCC rules. Operation is subject to the following two conditions: (1) this device may not cause harmful interference, and (2) this device must accept any interference received, including interference that may cause undesired operation.

This equipment has been tested and found to comply with the limits for a Class B digital device, pursuant to part 15 of the FCC Rules. These limits are designed to provide reasonable protection against harmful interference in a residential installation. This equipment generates, uses and can radiate radio frequency energy and, if not installed and used in accordance with the instructions, may cause harmful interference to radio communications. However, there is no guarantee that interference will not occur in a particular installation. If this equipment does cause harmful interference to radio or television reception, which can be determined by turning the equipment off and on, the user is encouraged to try to correct the interference by one or more of the following measures:

- Reorient or relocate the receiving antenna.
 - Increase the separation between the equipment and receiver.
 - Connect the equipment into an outlet on a circuit different from that to which the receiver is connected.
 - Consult the dealer or an experienced radio/TV technician for help.
-

Setup

Network Wiring

When wiring the AAE Adagio Audio Expander, APAD controller, or C2N-DBF12 keypad to the AADS, consider the following:

- Use Crestron Certified Wire.
- Use Crestron power supplies for Crestron equipment.
- Provide sufficient power to the system.

CAUTION: Insufficient power can lead to unpredictable results or damage to the equipment. Please use the Crestron Power Calculator to help calculate how much power is needed for the system (<http://www.crestron.com/calculators>).

- For larger networks, Use a Cresnet Hub/Repeater (CNXHUB) to maintain signal quality

For more details, refer to “Check Network Wiring” on page 60.

Hardware Hookup

Ventilation

The AADS should be used in a well-ventilated area. The venting holes should not be obstructed under any circumstances. If the AADS is hot to the touch, consider using forced air ventilation and/or incrementing the spacing between units.

To prevent overheating, do not operate this product in an area that exceeds the environmental temperature range listed in the table of specifications. Consideration must be given if installed in a closed or multi-unit rack assembly since the operating ambient temperature of the rack environment may be greater than the room ambient. Contact with thermal insulating materials should be avoided on all sides of the unit.

Out-of-the-box Connections

WARNING: To prevent injury and / or equipment damage due to electric shock, disconnect power from the AADS prior to making any wiring connections.

When using the out-of-the-box functionality, the AADS can support up to one AAE, one CEN-IDOC, one AAS-1/-2/-4, and any combination of six APAD or C2N-DBF12 control devices (plus an additional six on the AAE if connected). Observe the following when connecting hardware to the AADS.

- CEN-IDOC (Optional): The audio output of the CEN-IDOC must be connected to source input port 4 on the AADS when using the out-of-the-box configuration. The CEN-IDOC and AADS must be connected to the same DHCP router.
- AAS Devices (Optional): Source input ports 1 through 3 are reserved for the different variations of the AAS. The AAS and AADS must be connected to the same DHCP router.
 - ⇒ AAS-1: The audio output of the AAS-1 must be connected to source input port 1.

- ⇒ AAS-2: Audio output A of the AAS-2 must be connected to source input port 1 and audio output B must be connected to source input port 2.
- ⇒ AAS-4: Audio output A of the AAS-4 must be connected to source input port 1. Audio output B must be connected to source input port 2. Audio output C must be connected to source input port 3. Audio output D must be connected to source input port 4.

NOTE: If a CEN-IDOC is part of the system, audio output D cannot be used since the CEN-IDOC is connected to source input port 4.

- Control Devices (Optional): Any combination of six APADs or C2N-DBF12 devices can be connected to any of the six NET ports on the rear of the AADS. If an AAE is connected, six more APADs or C2N-DBF12 devices can be connected.
- AAE (Optional): One AAE can be connected to the AADS' loop-through ports and tuner outputs.

NOTE: When using the out-of-the-box functionality, the Net ID of the AAE is automatically set to its default value (31) when identifying keypads (refer to page 28). For information on other methods of setting the AAE's Net ID, refer to the latest version of the AAE guide (Doc. 6460) which is available from the Crestron website (www.crestron.com/manuals).

The connections shown in the following diagram must be made for the AADS to properly control and switch connected devices when using the out-of-the-box functionality.

CAUTION: Speakers must be rated to full available output.

CAUTION: Do not bridge speaker outputs.

CAUTION: Devices such as the AAS and the AAE must be fully grounded to the AADS. Additionally, any other source devices should be grounded to the AADS as well.

NOTE: The AADS can only be powered by the included power cord. Power cannot be supplied from network devices that are connected to the mini-terminal block connectors.

NOTE: The AADSI (International version) requires a power cord that is harmonized to the country's national and local electrical code. Each inner wire in the cord should be at least 16 AWG or (1.5 mm²) and rated for at least 500V. The temperature rating of the cord should be at least 60°C. The cord length should be 1.5 meters to 2 meters.

Hardware Connections for Out-of-the-Box Functionality

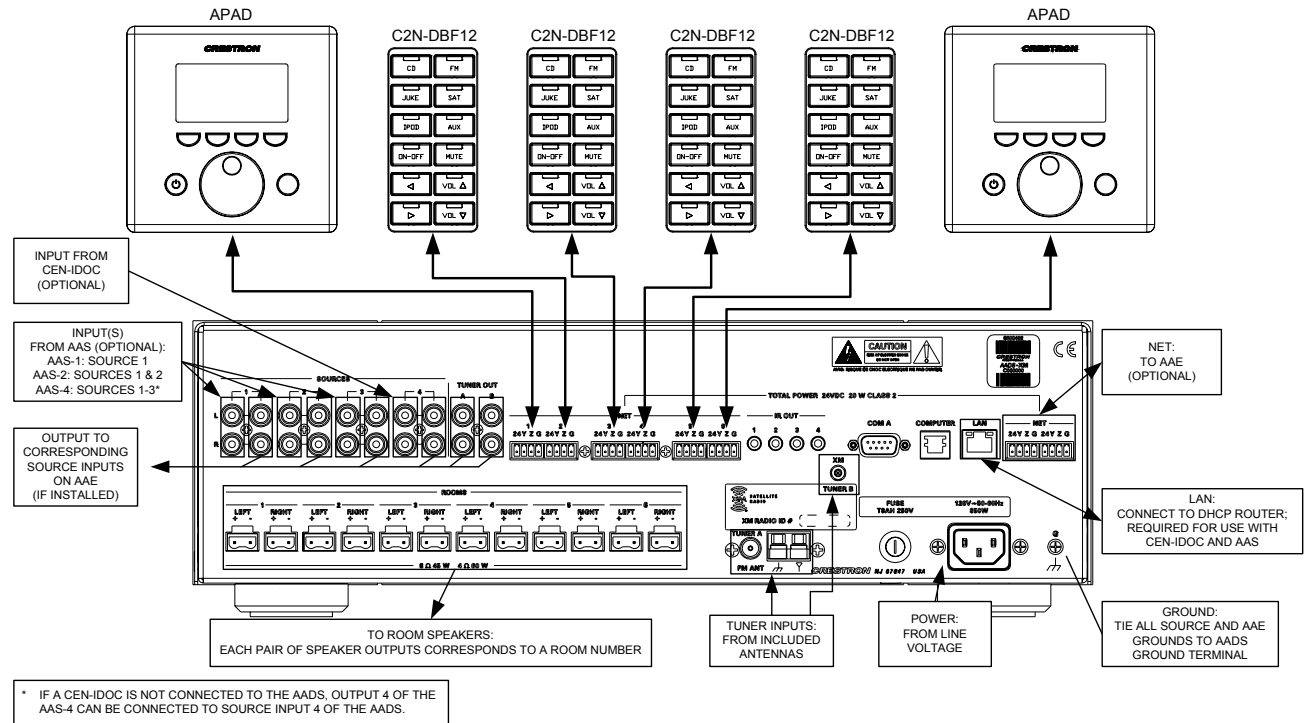

Custom Program Connections

Refer to the following when not using the out-of-the-box functionality:

WARNING: To prevent injury and / or equipment damage due to electric shock, disconnect power from the AADS prior to making any wiring connections.

Make the necessary connections as called out in the illustration that follows this paragraph. Refer to “Network Wiring” on page 16 before attaching the 4-position terminal block connectors. Apply power after all connections have been made.

CAUTION: Speakers must be rated to full available output.

CAUTION: Do not bridge speaker outputs.

CAUTION: Devices such as the AAS and the AAE must be fully grounded to the AADS. Additionally, any other source devices should be grounded to the AADS as well.

NOTE: The AADS can only be powered by the included power cord. Power cannot be supplied from network devices that are connected to the mini-terminal block connectors.

NOTE: The AADSI (International version) requires a power cord that is harmonized to the country’s national and local electrical code. Each inner wire in the cord should be at least 16 AWG or (1.5 mm²) and rated for at least 500V. The temperature rating of the cord should be at least 60°C. The cord length should be 1.5 meters to 2 meters.

Custom Program Connections for the AADS

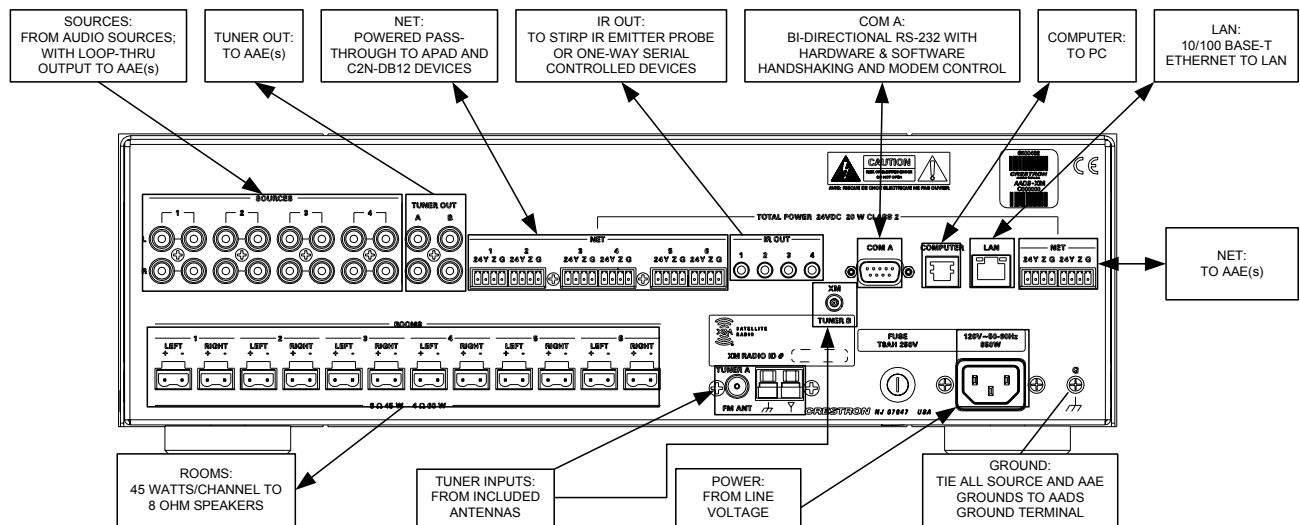

Antennas

The AADS and AADSI are equipped with two AM/FM tuners while the AADS-XM is equipped with an AM/FM tuner and an XM Satellite tuner.

The following antennas are supplied with AADS, AADSI, and AADS-XM:

MODEL	AM LOOP (QUANTITY)	FM T-TYPE (QUANTITY)	XM ANTENNA (QUANTITY)
AADS	2	2	0
AADSI	2	2	0
AADS-XM	1	1	1

For proper operation, the included antennas must be connected and oriented for optimum reception.

Connect Antennas

Connect the supplied AM antenna(s) by connecting the shield of the antenna wire to the connector's ground input and the inner conductor of the antenna wire to the connector's signal input.

Connect the supplied FM antenna or an outdoor antenna with the supplied conversion connector to the connector's signal input.

Connect the supplied XM antenna to receive XM radio signals (AADS-XM only).

Orient the Antennas

Once the antennas have been connected, it may be necessary to orient the AM loop antenna so that the flat surface of the loop antenna faces the metropolitan area originating the broadcast signals. This is particularly necessary when signals are weak. If you are not aware of the source or directions of the signals to which you will listen, simply rotate the loop antenna in clear space for maximum signal strength. The supplied antenna has a folding stand that allows you to place the antenna on a flat surface.

The recommended FM antenna is an outdoor type, commonly available in electronics stores. Use of the supplied indoor FM antenna is recommended only if you cannot use an outdoor antenna. Outdoor antennas are particularly needed in rural areas, some distance from FM radio signal sources. The FM antenna supplied with the AADS is a T-type, and it should be stretched horizontally in space that is as clear as possible. Some reorientation may be necessary if signals in your area are weak. Best results usually can be achieved if the length of the antenna faces the metropolitan area originating the FM signals that you wish to receive. The supplied antenna has a fitting at its end that will enable you to fasten it in place.

For XM operation, the antenna should be oriented toward the southern sky where the satellite is located. If the antenna is placed outdoors, it should be in an area where there are no obstacles within 20 to 60 degrees of elevation facing the southern sky. The antenna should be placed on a flat surface that is parallel to the ground. If the antenna is placed where obstacles such as buildings or trees are in the path to the satellite, the antenna may not receive radio signals from the satellite. Certain areas provide satellite radio ground repeaters that retransmit satellite radio signals. Antenna extension cables are available from your dealer or from Crestron.

AADS Control Devices

Any combination of six AADS control devices such as the APAD or the C2N-DBF12 can be simultaneously connected to the powered NET ports located on the middle of the rear panel. Refer to the following diagram and “Network Wiring” on page 16 for wiring information when connecting either APAD devices or C2N-DBF12 keypads.

AADS with Control Devices

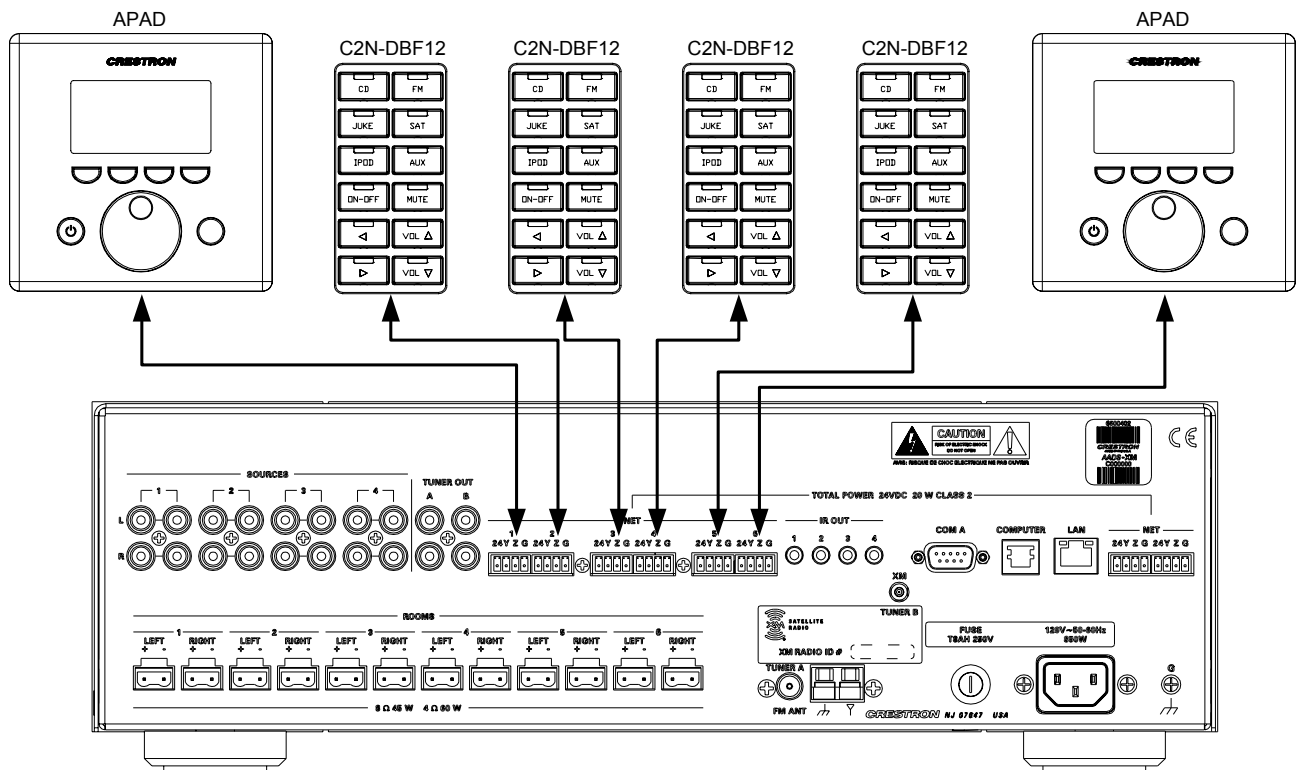

Fuse Replacement

If the AADS does not power up when it is plugged into an AC outlet, the fuse may need to be replaced. The fuse holder is located on bottom-right of the rear panel (next to the power cord connector).

To replace the fuse:

1. Press **STANDBY** to place the unit in *Standby* and remove the power cable.
2. Use a flat-head screwdriver to push in the fuse holder. While pushing in the fuse holder, turn screwdriver counterclockwise until the fuse holder pops out.
3. Remove the fuse from the fuse holder and insert a new fuse.

CAUTION: Only use the specified type of fuse when replacing a blown fuse. Failure to do so may cause damage to the AADS.

AADS MODEL	REQUIRED FUSE TYPE
AADS, AADS-XM (US & Canada)	T8AH (¼" x 1¼", 250V, 8A, time-lag, high-rupture rated)
AADSI (International/230VAC)	T4AH (5mm x 20mm, 250V, 4A, time-lag, high-rupture rated)

4. Insert the fuse holder into the AADS.
5. Push in the fuse holder with a flat head screwdriver. While pushing in the fuse holder, turn the screwdriver clockwise until the fuse holder sinks in.
6. Push in the fuse holder a little further and turn the screwdriver clockwise until the fuse holder locks in place.
7. Connect power to the AADS.

Room Button Labels

Use Adagio Composer or Crestron Engraver software to create and print custom labels on overhead transparency film for the AADS' room buttons.

NOTE: When printing custom labels, some experimentation may be required for optimum results.

Custom-engraved labels can also be ordered from Crestron. Contact Crestron for more information.

To remove the label:

1. Remove the label cover with a small, flat-head screwdriver. The label cover is magnetically attached to the front panel of the Adagio component. The label strip will be exposed.
2. Insert the screwdriver behind the label strip as shown below.

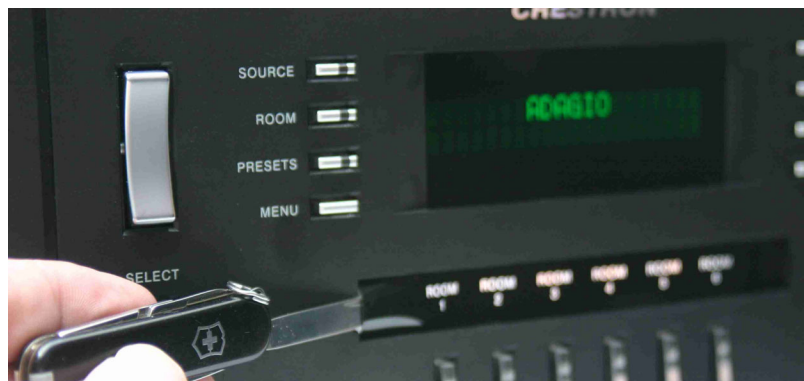

3. Continue sliding the screwdriver behind the label strip until the top of the label strip slides out as shown in the following picture.



4. Continue sliding the screwdriver until the entire top of the label strip is visible. Remove the label strip by pulling the top of the label strip up from the Adagio component as shown below.

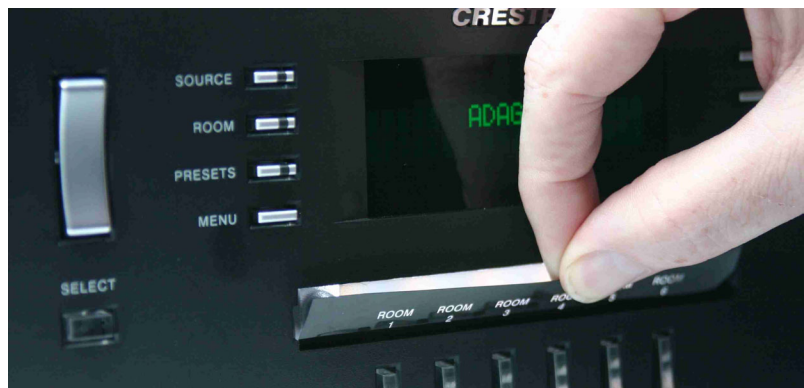

To install the new label:

- Engraved Label Cover: Place the engraved label cover over the label area of the Adagio component until the label cover's integrated magnets snap the label cover into place.
- Printed Label: Place the bottom of the label strip into the Adagio component. Bend the label strip and position the top of the label strip into the Adagio component. Replace the label cover over the new label strip.

NOTE: Observe proper orientation so the letters are right-side up.

Configuration

After making all hardware connections to the AADS, the system must be configured for operation.

Configuring the system is broken down into four processes:

- Configure the AADS for Operation
- Configure Sources
- Configure Rooms
- Configure Preset Groups

Configure the AADS for Operation

The AADS must be configured for operation prior to configuring sources, rooms, or groups. Use the Installer Tools to configure the AADS for operation.

NOTE: If a custom program was created with Adagio Composer or SystemBuilder, the following is not required.

Open Installer Tools

- Press and hold the **ROOM** and **SOURCE** buttons for five seconds to open the Installer Tools menu.

Installer Tools Menu

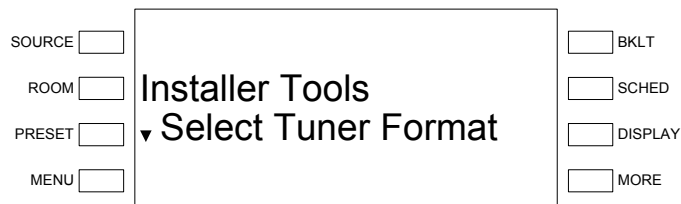

- Scroll through the list of available options by pressing up or down on the selection control. Arrows indicate available directions (up or down). The selected option will be displayed. Available options are:
 - ⇒ Select Tuner Format – Specifies the North American or European tuning format for the AM/FM tuner.
 - ⇒ Configure Network – Configures the AADS to communicate with devices that are connected to the AADS over Ethernet.
 - ⇒ Set Number of Rooms – Sets the number of rooms to be controlled by the AADS.
 - ⇒ Name Rooms – Allows custom naming of rooms controlled by the AADS.
 - ⇒ Name Sources – Allows custom naming of audio sources connected to the AADS.
 - ⇒ Hide Sources – Hides sources that are not used from the source list.
 - ⇒ Identify Keypads – Registers APAD devices and C2N-DBF12 keypads that are connected to the system.

- ⇒ Configure Keypads – Configures the source assignments of the top six buttons of every C2N-DBF12 keypad that is connected to the system.
- ⇒ Restore Defaults – Restores default settings
- ⇒ System Information – Provides information about the AADS such as IP data, firmware version, and program information.

To configure the displayed option, press the **SELECT** button.

To exit Installer Tools and save changes to the AADS' configuration, press the **MENU** button.

Select Tuner Format

Select the tuning format to specify the tuning method used by an installed AM/FM tuner. When using the North American tuner format, the tuner will tune FM frequencies in 100 kHz steps and AM frequencies in 10 kHz steps. When using the European tuner format, the tuner will tune FM frequencies in 50 kHz steps and AM frequencies in 9kHz steps.

- Open Installer Tools as described on page 23, select **Select Tuner Format**, and press the **SELECT** button

Select Tuner Format Menu

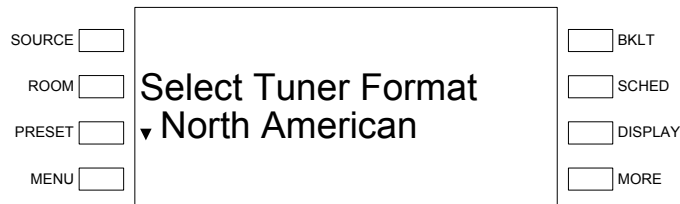

- To select a tuner format, press the selection control up or down to display the desired tuner format and press **SELECT**. To cancel and return to the Installer Tools menu, press the **MENU** button.

Configure the Network

The AADS must be configured to recognize devices that communicate over Ethernet (i.e. AAS, CEN-IDOC).

- Open Installer Tools as described on page 23, select **Configure Network**, and press the **SELECT** button. The AADS will poll the network to find compatible devices.

Configure Network

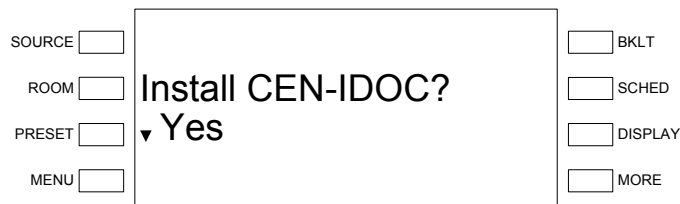

- To install a CEN-IDOC, press the **SELECT** button and follow the instructions onscreen. The source name “iPod” will be displayed in place of “Source 4” in the list of sources. Otherwise, press the selection control down to display **No** and press the **SELECT** button.

- The AADS will then prompt you to install an AAS. To install an AAS, press the **SELECT** button and follow the instructions onscreen. The source names will be renamed as follows:

- ⇒ Source 1 becomes “Server 1”
- ⇒ Source 2 becomes “Server 2”^{1,2}
- ⇒ Source 3 becomes “Server 3”²

- 1: If an AAS-2 model is detected
- 2: If an AAS-4 model is detected

If a CEN-IDOC is not configured and an AAS-4 is installed, Source 4 becomes “Server 4”.

If you do not want to add an AAS, press the selection control down to display **No** and press the **SELECT** button.

- To cancel and return to the Installer Tools menu, press the **MENU** button.

NOTE: When installing an AAS, only one AAS can be present on the network.

Set the Number of Rooms

Set the number of rooms so the AADS does not display unused rooms during configuration and operation.

- Open Installer Tools as described on page 23, select **Set Number of Rooms**, and press the **SELECT** button.

Set the Number of Rooms

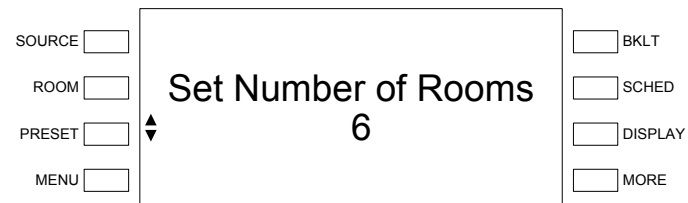

- To select the number of rooms, press the selection control up or down to display the number of rooms and press **SELECT**. To cancel and return to the Installer Tools menu, press **MENU**.

NOTE: With an AAE connected to the AADS, the maximum number of rooms that can be selected is 12 (when using out-of-the-box functionality).

Name Rooms

This screen allows you to customize the name of each room displayed on the LCD.

- Open Installer Tools as described on page 23, select **Name Rooms**, and press the **SELECT** button.

Select Room To Name

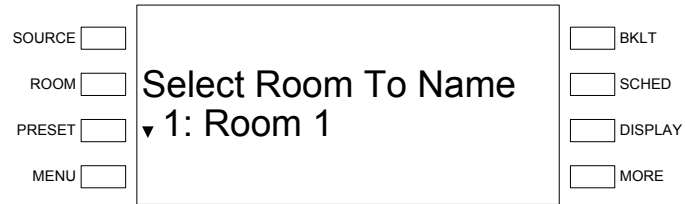

- To select a room to name, press the selection control up or down until the room to be named is displayed and press the **SELECT** button. To cancel and return to the Installer Tools menu, press **MENU**.

Room names can be entered using a custom name or any of the factory-installed room names.

- To use one of the factory-installed names, press the selection control up or down until the desired room name is displayed and press the **SELECT** button.

Select Room Name

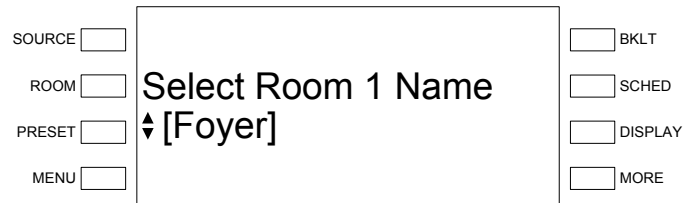

- To enter a custom name, press the selection control up until **[Custom Name]** is displayed and press the **SELECT** button.

Edit Room Name

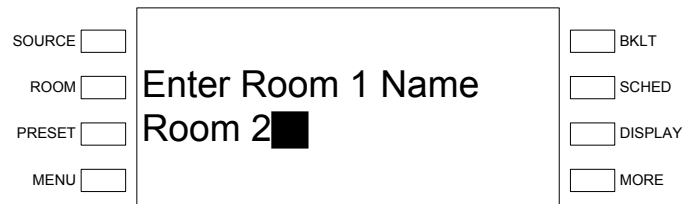

- ⇒ Move the cursor position by pressing the selection control up or down. Select letters (upper and lower-case), numbers, or other characters by pressing the volume control up or down until the desired letter, number, or other character is displayed on the LCD.

NOTE: The maximum length for any room name is 16 characters.

- ⇒ After entering the new room name, press the **SELECT** button to save the name and return to the list of rooms. If all of the rooms have been named/renamed, press **MENU** to return to the Installer Tools menu.

Name Sources

This screen allows you to customize the name of each source displayed on the LCD.

- Open Installer Tools as described on page 23, select **Name Sources**, and press the **SELECT** button.

Name Sources

SOURCE <input type="checkbox"/>	Select Src. To Name ▼ 1: Source 1	<input type="checkbox"/> BKLT
ROOM <input type="checkbox"/>		<input type="checkbox"/> SCHED
PRESET <input type="checkbox"/>		<input type="checkbox"/> DISPLAY
MENU <input type="checkbox"/>		<input type="checkbox"/> MORE

- To select a source to be named, press the selection control up or down until the source to be named is displayed and press the **SELECT** button. To cancel and return to the Installer Tools menu, press **MENU**.

Source names can be entered using any of the factory-installed source names or a custom name.

- To use one of the factory-installed names, press the selection control up or down to display the desired source name and press the **SELECT** button.

Select Source Name

SOURCE <input type="checkbox"/>	Select Src. 1 Name ▲ [AAS]	<input type="checkbox"/> BKLT
ROOM <input type="checkbox"/>		<input type="checkbox"/> SCHED
PRESET <input type="checkbox"/>		<input type="checkbox"/> DISPLAY
MENU <input type="checkbox"/>		<input type="checkbox"/> MORE

- To enter a custom name, press the selection control up until [**Custom Name**] is displayed and press the **SELECT** button.

Edit Source Name

SOURCE <input type="checkbox"/>	Enter Src. 1 Name Source 1 ■	<input type="checkbox"/> BKLT
ROOM <input type="checkbox"/>		<input type="checkbox"/> SCHED
PRESET <input type="checkbox"/>		<input type="checkbox"/> DISPLAY
MENU <input type="checkbox"/>		<input type="checkbox"/> MORE

- ⇒ Move the cursor position by pressing the selection control up or down. Select letters (upper and lower-case), numbers, or other characters by pressing the volume control up or down until the desired letter, number, or other character is displayed on the LCD.

NOTE: The maximum length for any source name is 16 characters.

- ⇒ After entering the new source name, press the **SELECT** button to save the name and return to the list of sources. If all of the sources have been named/renamed, press **MENU** to return to the Installer Tools menu.

Hide Sources

Sources that are not used can be hidden from the list of available sources while in *Source* mode. This allows quicker scrolling through the connected sources while in the *Source* mode.

- Open Installer Tools as described on page 23, select **Hide Sources**, and press the **SELECT** button. The AADS will list Source 1 with its visibility status.

NOTE: Hidden sources are indicated with an asterisk (*).

- Press the **SELECT** button to toggle the visibility setting (hidden or revealed).

Identify Keypads

This screen allows you to identify 12-button keypads and APAD devices that are connected to the AADS.

- Open Installer Tools as described on page 23, select **Identify Keypads**, and press the **SELECT** button. The AADS will poll the network to detect any connected keypads or APAD device.

NOTE: Any attached AAE will automatically be identified by the AADS during this step.

- Press the **SELECT** button to clear any existing keypad data and begin the identification process.

Select Keypad Type

SOURCE <input type="checkbox"/>	Select Room 1 keypad ▼ APAD	<input type="checkbox"/> BKLT
ROOM <input type="checkbox"/>		<input type="checkbox"/> SCHED
PRESET <input type="checkbox"/>		<input type="checkbox"/> DISPLAY
MENU <input type="checkbox"/>		<input type="checkbox"/> MORE

- To select the control device type for the first room controlled by the AADS (Room Output 1), press the selection control up or down to display **APAD** or **12-button keypad** and press **SELECT**. If there is no control device for that room, press the selection control down to display **None** and press **SELECT**.
- Follow the onscreen instructions for identifying the device. After identifying the device, the AADS will prompt for the next room's control device.

NOTE: If a device is not identified within two minutes, the AADS will indicate that the keypad was not found. Try again by pressing the **SELECT** button or cancel the process by pressing the selection control down to display **Abort** and pressing the **SELECT** button.

- Repeat the procedure until control devices for all of the specified rooms (refer to page 25) have been identified.

Configure Keypads

This screen allows you to assign sources to the top six keys of a C2N-DBF12 keypad. The source assignment is applied to every C2N-DBF12 keypad that is connected to the system. The functions of the bottom six keys cannot be changed when using the out-of-the-box program.

- Open Installer Tools as described on page 23, select **Configure Keypads**, and press the **SELECT** button.

Select Button To Map

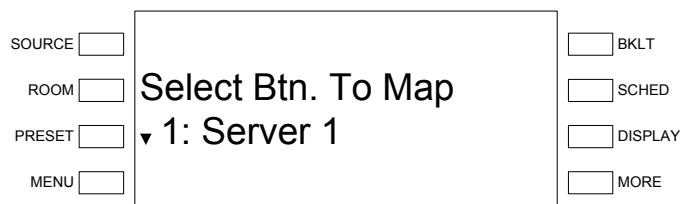

- Press the selection control up or down to display the button to be mapped (refer to the diagram below for button locations) and press the **SELECT** button. To cancel and return to the Installer Tools menu, press **MENU**.

Select Source for Button and Button Layout

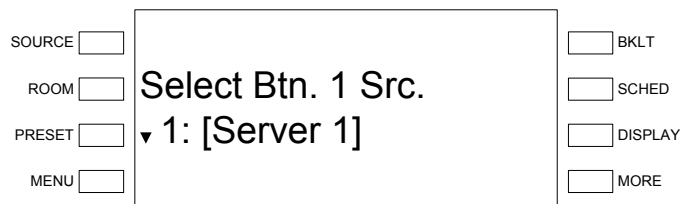

C2N-DBF12 Keypad Button Layout

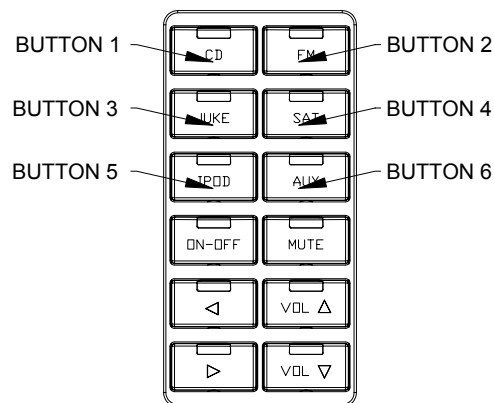

- Select the source for the button by pressing the selection control up or down until the desired source is displayed on the LCD and pressing **SELECT**. If a button is not to be used, select **Not Used** and press **SELECT**.
- Repeat the process for the remaining buttons. If all of the buttons have been assigned/reassigned, press **MENU** to return to the Installer Tools menu.

Restore Defaults

This screen allows you to restore the AADS to its factory default settings. The AADS can restore all of the factory settings or just the audio settings.

- Open Installer Tools as described on page 23, select **Restore Defaults**, and press the **SELECT** button.

Restore Defaults: Audio Settings Only

SOURCE <input type="checkbox"/>	Restore Defaults ▾ Audio Settings Only	<input type="checkbox"/> BKLT
ROOM <input type="checkbox"/>		<input type="checkbox"/> SCHED
PRESET <input type="checkbox"/>		<input type="checkbox"/> DISPLAY
MENU <input type="checkbox"/>		<input type="checkbox"/> MORE

- Press the **SELECT** button to restore the audio settings to the factory defaults.
- Press down on the selection control until **All Settings** is displayed and press **SELECT** to restore all settings (audio, room names, source names, keypad button assignments, and the tuner region) to the factory defaults. Ethernet settings will not be reset.
- To cancel, press down on the selection control until **Abort** is displayed and press **SELECT**.

System Information

This screen allows you to view information about the AADS.

- Open Installer Tools as described on page 23, select **System Information**, and press the **SELECT** button.

System Information

SOURCE <input type="checkbox"/>	System Information ▾ IP Address	<input type="checkbox"/> BKLT
ROOM <input type="checkbox"/>		<input type="checkbox"/> SCHED
PRESET <input type="checkbox"/>		<input type="checkbox"/> DISPLAY
MENU <input type="checkbox"/>		<input type="checkbox"/> MORE

- Press the **SELECT** button to view the IP address of the AADS. Press **MENU** to return to the System Information display.
- To see additional system information, press the selection control up or down to display the parameter name and press **SELECT** to view details.

Configure Sources

The gain of each source can be customized from the AADS control panel.

Adjust the Gain of a Source

To adjust a source's gain:

- Select a source to adjust by pressing **SOURCE** and using the selection control to display a source.
- Press and hold the **SOURCE** and **MORE** buttons at the same time to open the Gain control.

Gain Control

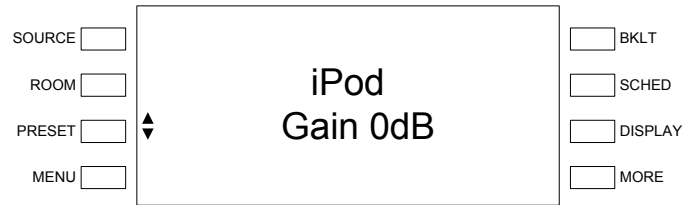

- Adjust the gain level with the selection control. Press up to raise the gain level or press down to lower the gain level.
- Press **SELECT** to store the new setting and exit.

Configure Rooms

The sound quality, minimum volume, maximum volume and startup volume settings, of each room can be customized from the AADS control panel.

Access the Room Setup Mode

- Select a room to configure by pressing a room button. Alternatively, press **ROOM** and select the room with the selection control.
- Press the **ROOM** and **MORE** buttons at the same time for several seconds to open the Room Setup menu.

Room Setup Menu

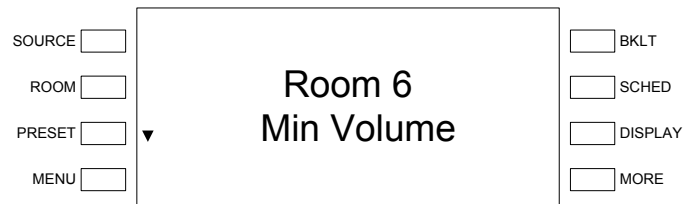

Press up or down on the selection control to display a parameter to adjust and press **SELECT**. Parameters that can be adjusted include:

- ⇒ Minimum Volume
- ⇒ Maximum Volume
- ⇒ Startup Volume
- ⇒ Mono/Stereo

- To exit the Room Setup menu, press a room button or the **MENU** button.

Adjust the Minimum Volume

The minimum volume establishes the lowest volume level setting for a room. The minimum volume settings of each room can be adjusted independently.

- Access the Room Setup mode as described above.
- Press the **SELECT** button to open the Minimum Volume control. The current minimum volume setting is displayed.

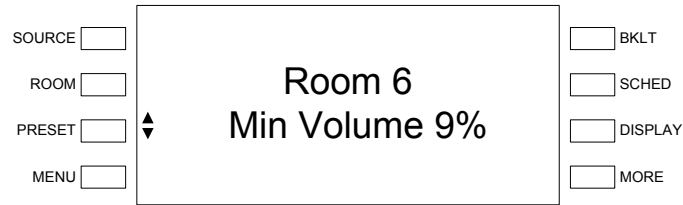
Minimum Volume Control

- Adjust the minimum volume with the selection control. Press up to raise the minimum volume or press down to lower the minimum volume. The highest minimum volume setting is 30%.
- Press **SELECT** to store the minimum volume setting and to return to the Room Setup menu.

Adjust the Maximum Volume

The maximum volume establishes the highest volume level setting for a room. The maximum volume settings of each room can be adjusted independently.

- Access the Room Setup mode as described on page 31.
- Press down on the selection control until **Max Volume** is displayed and press **SELECT** to open the Maximum Volume control. The current maximum volume setting is displayed.

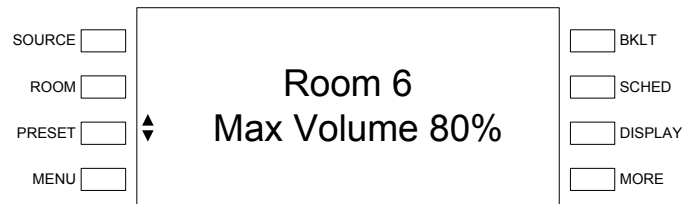
Maximum Volume Control

- Adjust the maximum volume with the selection control. Press up to raise the maximum volume or press down to lower the maximum volume. The lowest maximum volume setting is 70%.
- Press **SELECT** to store the maximum volume setting and to return to the Room Setup menu.

Adjust the Startup Volume

The startup volume establishes the volume level setting for a room when a room is turned on. The startup volume settings of each room can be adjusted independently.

- Access the Room Setup mode as described on page 31.
- Press down on the selection control until **Start Volume** is displayed and press **SELECT** to open the Startup Volume control. The current startup volume setting is displayed.

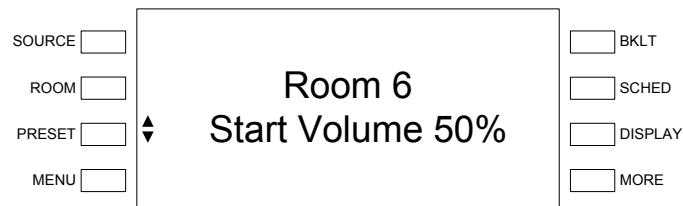
Startup Volume Control

- Adjust the maximum volume with the selection control. Press up to raise the maximum volume or press down to lower the maximum volume. The maximum startup volume setting is 50%.
- Press **SELECT** to store the startup volume setting and to return to the Room Setup menu.

Set Mono or Stereo Mode

The audio sent to the speakers in each room can be set for either stereo or mono. When set to stereo, the audio signal is separated into left and right channels for distribution to left and right speakers. When set to mono, the audio signal is combined into one signal for use in larger rooms where stereo separation is not practical. The mono/stereo settings of each room can be adjusted independently.

- Access the Room Setup mode as described on page 31.
- Press down on the selection control until **Stereo/Mono** is displayed and press **SELECT** to open the Stereo/Mono control. The selected mode is displayed on the LCD.

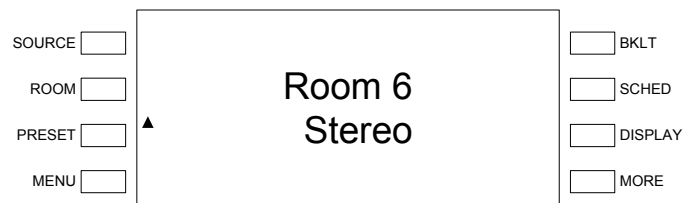
Stereo/Mono Control

- To select stereo, press the selection control down to display **Stereo** and press **SELECT**.
- To select mono, press the selection control up to display **Mono** and press **SELECT**.
- To cancel and return to the Room Setup menu, press the **MENU** button.

Configure Presets

Presets can be created to group speakers in adjacent rooms with a specified source, or switch into a whole-house “party” mode, by letting the user link a source with any number of rooms. Changing the source in any one room changes the source in all of the rooms in the preset.

Edit a Preset

To edit a preset:

- Press and hold the **PRESET** button for approximately five seconds to view the Edit Presets control shown in the following diagram.

Edit Presets Control

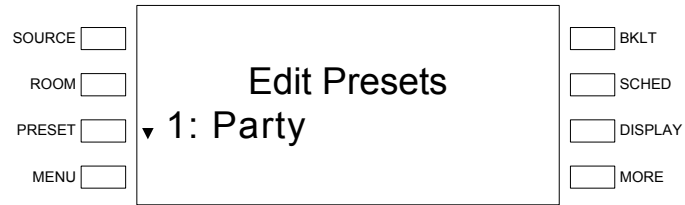

- To configure a preset, press up or down on the selection control to display the preset to be configured and press **SELECT**.
- To add rooms to the preset, press the corresponding room buttons on the AADS or AAE (if connected). The room button's LED will turn on. Press again to remove the room from the preset group. The room button's LED will turn off.
- To select a source for the preset:
 - ⇒ Press up or down on the selection control until the word **Source** is displayed and press **SELECT**.

Select Preset Source

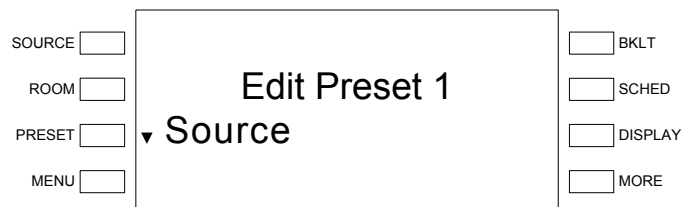

- ⇒ Press up or down on the selection control until the desired source is displayed and press **SELECT**.
- To change the name of the preset:
 - ⇒ Press up or down on the selection control until the word **Name** is displayed and press **SELECT**.
 - ⇒ Press the selection control up or down to display any of the built-in preset names and press the **SELECT** button.

Select Preset Name

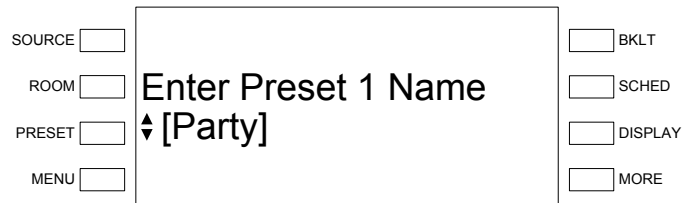

- ⇒ To enter a custom name, press the selection control up until [**Custom Name**] is displayed and press the **SELECT** button.

Edit Preset Name

SOURCE <input type="checkbox"/>	Enter Preset 1 Name Party█	<input type="checkbox"/> BKLT
ROOM <input type="checkbox"/>		<input type="checkbox"/> SCHED
PRESET <input type="checkbox"/>		<input type="checkbox"/> DISPLAY
MENU <input type="checkbox"/>		<input type="checkbox"/> MORE

⇒ Move the cursor position by pressing the selection control up or down. Select letters (upper and lower-case), numbers, or other characters by pressing the volume control up or down until the desired letter, number, or other character is displayed on the LCD.

NOTE: The maximum length for any preset name is 16 characters.

⇒ Press **SELECT** to store the name.

- If all of the presets have been configured, press **MENU** twice to exit the Preset Control menu.

Operation

Prior to using this section, refer to the QuickStart Guide (Doc. 6459) that is included with the AADS.

For instructions on using the APAD and the C2N-DBF12 with the AADS refer to the latest version of the Out-Of-The-Box Functionality Guide (Doc. 6493).

Operating the AADS is broken down into four modes:

- *Source Mode*
- *Room Mode*
- *Preset Mode*
- Turn Off the System

Source Mode

Source mode is used to select and control sources that are connected to the AADS. A selected source can also be routed to any room or rooms connected to the AADS or a connected AAE.

Select a Source

To select a source:

- Press **SOURCE** to put the AADS in *Source mode*. The current controlled source is displayed on the LCD.

Source Mode

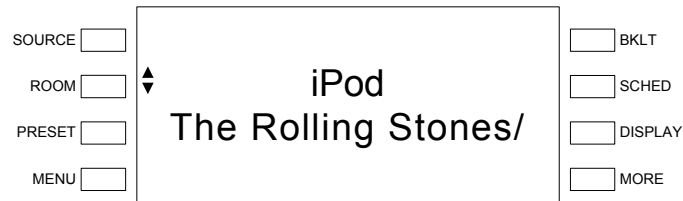

- Press the selection control up or down until the desired source is displayed on the LCD. Rooms that are connected to the displayed source are indicated on the room buttons.
- Press the **SELECT** button to select and control the source.

When using the out-of-the-box functionality, the front panel of the AADS can control the AM/FM or XM (AADS-XM only) tuners, an iPod connected to a CEN-IDOC, and an AAS (when connected).

Controlling a Tuner

The built-in tuners can be controlled by the AADS front panel.

Find the Tuner Controls

- Place the AADS in the *Source mode* (refer to “Select a Source” above).
- Press the selection control up or down to display the desired tuner source. The frequency/channel and other information will be displayed.

FM Radio Source

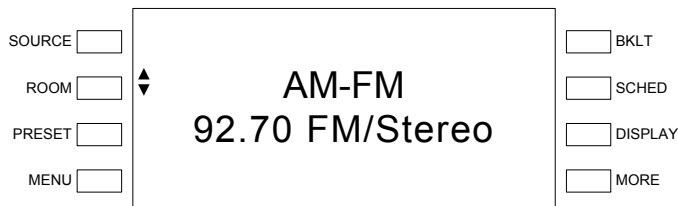

XM Radio Source

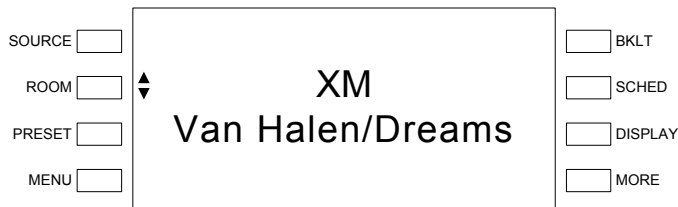

- Press the **SELECT** button to open the tuner controls.

Control the AM/FM Tuner

The AM/FM tuner controls allow access to the AM/FM tuner functions. The tuner controls can recall and store presets, tune and scan stations on the frequency band, change frequency bands (AM or FM), or view signal strength.

AM/FM Controls

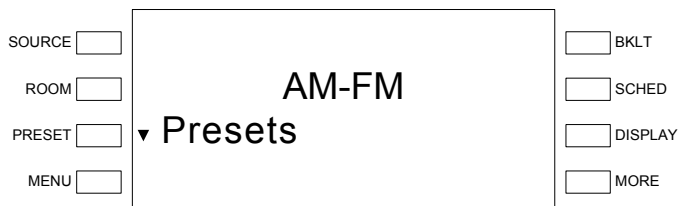

- **Presets:**
Use presets to recall and store favorite stations.
 - ⇒ To recall a preset:
 - ❖ Select the AM/FM tuner controls as described on page 36.
 - ❖ Press the selection control up or down to display **Presets** and press **SELECT**.

Preset Controls

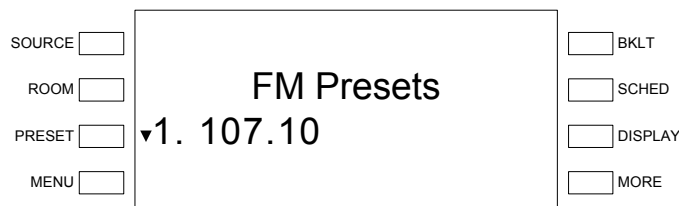

- ❖ Select a preset location by pressing the selection control up or down and pressing the **SELECT** button when the desired preset is displayed.

⇒ To store a preset:

- ❖ Select the AM/FM tuner controls as described on page 36.
- ❖ Tune the desired station using the *Manual* tuning mode (as described on page 38).
- ❖ Press the **MENU** button to return to the tuner controls.
- ❖ Press the selection control up or down to display **Preset** and press **SELECT**.

Preset Controls



- ❖ Select a preset location by pressing the selection control up or down to display the desired preset location and press the **MORE** button.

Replace Preset Prompt

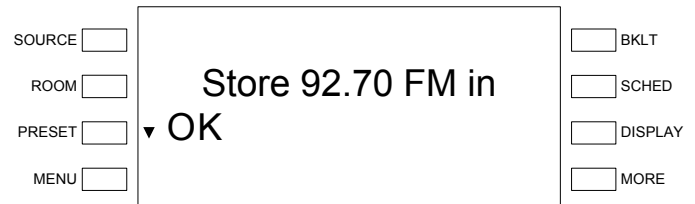

- ❖ To store the preset in the location, press the selection control up or down to display **OK** and press **SELECT**. To cancel, press the selection control up or down to display **Cancel** and press **SELECT**.

- **Manual Tuning:**

Manually tune stations to listen to a specific channel or to set up a preset.

- ⇒ Select the AM/FM tuner controls as described on page 36.
- ⇒ Press the selection control up or down to display **Manual Tuning** and press **SELECT**.

Manual Tuning

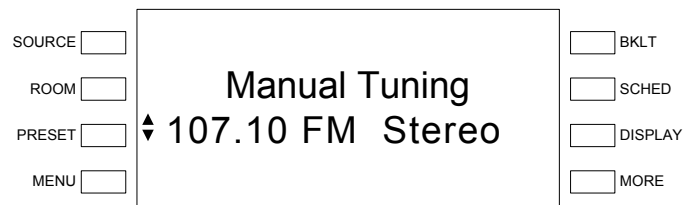

- ⇒ Press the selection control up to manually increase the frequency; or down to manually decrease the frequency.
- ⇒ Press the **MENU** button to return to the tuner controls.

- *Scan Stations:*

- ⇒ Select the AM/FM tuner controls as described on page 36.
- ⇒ Press the selection control up or down to display **Scan Stations** and press **SELECT**.

Scan Stations

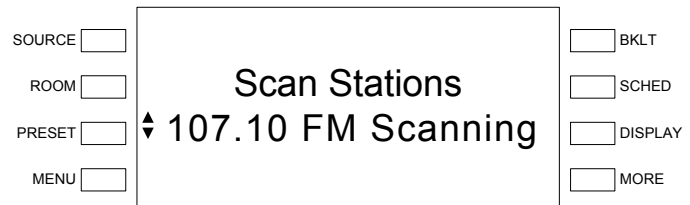

- ⇒ Press the selection control “up” to start a scan that increases in frequency; or press the selection control “down” to start a scan that decreases in frequency to the next clear frequency.
- ⇒ Stop the scan by pressing the selection control up or down. The scan automatically stops when the tuner reaches the frequency where the scan originally started.
- ⇒ Press the **MENU** button to return to the tuner controls.

- *Band Selection:*

- ⇒ Select the AM/FM tuner controls as described on page 36.
- ⇒ Press the selection control up or down to display **Band** and press **SELECT**.
- ⇒ Press the selection control up or down to select the tuning band.
- ⇒ Press the **MENU** button to return to the tuner controls.

- *Signal Strength and Tuning Mode:*

- ⇒ To view the signal strength of the tuned frequency:
 - ❖ Select the AM/FM tuner controls as described on page 36.
 - ❖ Press the selection control up or down to display **Tech** and press **SELECT**.
 - ❖ To view the selected station’s signal strength, press the selection control up or down to display **Signal Strength** and press **SELECT**. Press **MENU** to return to the tuner controls.

Signal Strength

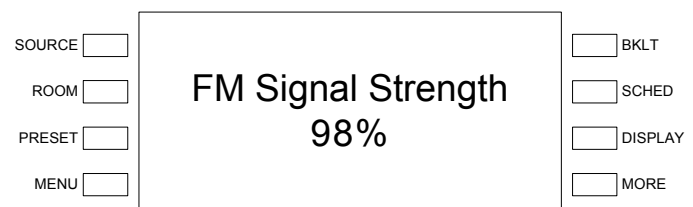

- ⇒ To select the stereo or mono tuning mode (FM band only):
 - ❖ Press the selection control up or down to display **Stereo/Mono** and press **SELECT**.

- ❖ Select the tuning mode by pressing up or down on the selection control to display the desired mode. Press **MENU** to return to the tuner controls.

Stereo/Mono Mode

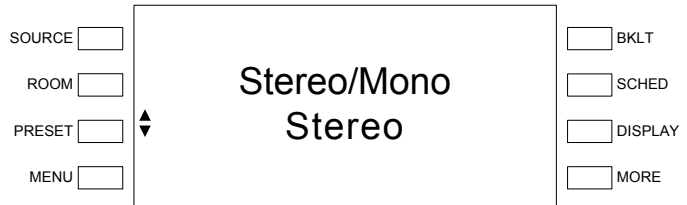

**Control the XM Tuner
(AADS-XM Only)**

The XM tuner controls allow access to the XM tuner functions. The tuner controls can recall and store presets, tune stations by categories or channel, or view XM technical information.

- **Presets:**
Use presets to recall and store favorite stations.

⇒ To recall a preset:

- ❖ Select the XM tuner controls as described on page 36.

XM Controls

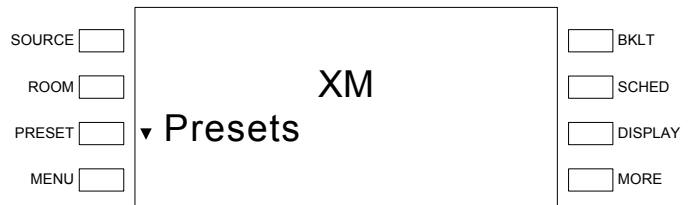

- ❖ Press the selection control up or down to display **Presets** and press **SELECT**.

Preset Controls

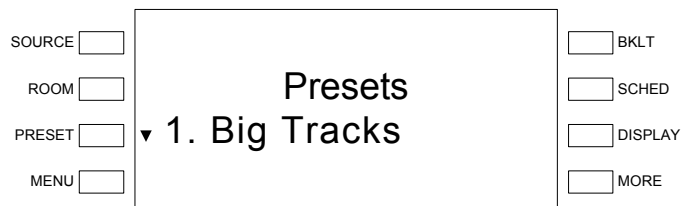

- ❖ Select a preset location by pressing the selection control up or down and pressing the **SELECT** button when the desired preset is displayed.

⇒ To store a preset:

- ❖ Select the XM tuner controls as described on page 36.
- ❖ Tune the desired station using the *Category* tuning mode (page 41) or *Channel* tuning mode (page 42).
- ❖ Press the **MENU** button to return to the tuner controls.

- ❖ Press the selection control up or down to display **Preset** and press **SELECT**.

Preset Controls

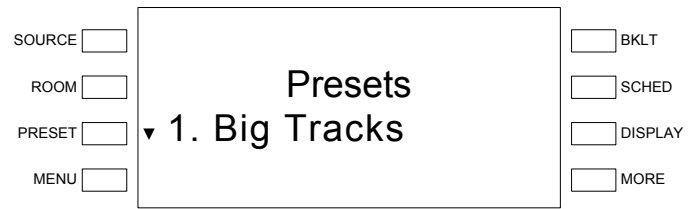

- ❖ Select a preset location by pressing the selection control up or down to display the desired preset location and press the **MORE** button.

Replace Preset Prompt

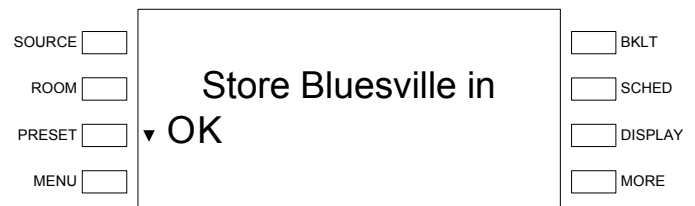

- ❖ To store the preset in the location, press the selection control up or down to display **OK** and press **SELECT**. To cancel, press the selection control up or down to display **Cancel** and press **SELECT**.

- **Category Tuning:**

Tune stations by category to listen to a specific type of channel or to set up a preset.

- ⇒ Select the XM tuner controls as described on page 36.
- ⇒ Press the selection control up or down to display **Categories** and press **SELECT**.

Category Tuning

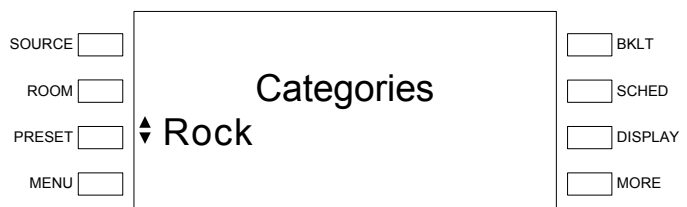

- ⇒ Press the selection control up or down to browse through the categories. When the desired category is displayed, press **SELECT** to view the channel(s) within the selected category.

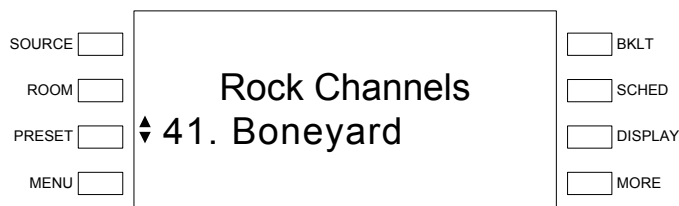
Category Channels

⇒ Press the selection control up or down to browse through the channels within the selected category. When the desired channel is displayed, press **SELECT** to select the channel. The display will indicate that the channel has been selected.

- **Channel Tuning:**

Tune stations by channel to listen to a specific channel or to set up a preset.

⇒ Select the XM tuner controls as described on page 36.

⇒ Press the selection control up or down to display **Channels** and press **SELECT**.

Channel Tuning

⇒ Press the selection control up or down to browse the list of channels. When the desired channel is displayed, press **SELECT** to select the channel. The display will indicate that the channel has been selected.

- **Signal Strength & Radio ID:**

⇒ To view the signal strength of the XM tuner:

- ❖ Select the XM tuner controls as described on page 36.

- ❖ Press the selection control up or down to display **Tech** and press **SELECT**.

- ❖ To view the selected station's signal strength, press the selection control up or down to display **Signal Strength** and press **SELECT**. Press **MENU** to return to the tuner controls.

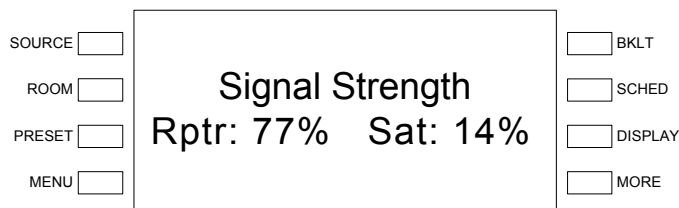
Signal Strength

⇒ To view the Radio ID of the XM tuner:

- ❖ Select the XM tuner controls as described on page 36.
- ❖ Press the selection control up or down to display **Radio ID** and press **SELECT**. Press **MENU** to return to the tuner controls.

Radio ID

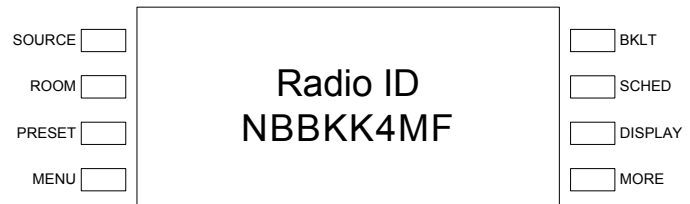

Controlling an iPod

An Apple iPod can be controlled from the AADS front panel with an optional CEN-IDOC Interface for Apple iPod.

The following assumes that the CEN-IDOC has been installed and an iPod has been connected as described in the CEN-IDOC guide.

Find the iPod Controls

- Place the AADS in the *Source* mode (refer to “Select a Source” on page 36).
- Press the selection control up or down to display the iPod source. The current track and artist will be displayed.

iPod Source

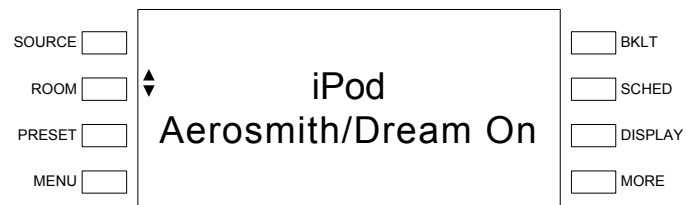

- Press the **SELECT** button to open the iPod controls.

iPod Controls

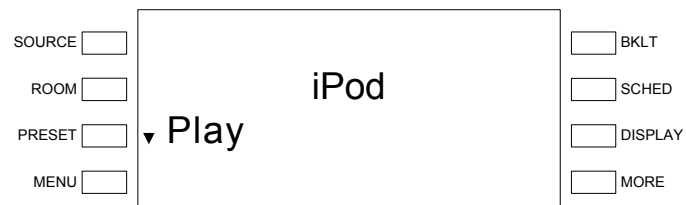

- Press the selection control up or down to view the different iPod control options.

Play iPod Tracks with the AADS

The AADS can be used to control the iPod’s playback functions.

- Open the iPod controls as described above.

- Press the selection control up or down until **Play** is displayed and press **SELECT**. The display will briefly show instructions for using the AADS front panel to skip songs, pause playback, and resume playback. The display will then show the artist and track information as well as the playback status. Press **DISPLAY** to switch the display between artist and album information.

iPod Playing

- To resume or pause playback, press the **SELECT** button.
- To skip to the next track, press the selection control up.
- To return to the beginning of a track or skip to the previous track, press the selection control down.

Repeat Controls

The AADS can be used to select the iPod's repeat mode.

- Open the iPod controls as described on page 43.
- Press the selection control up or down until **Repeat** is displayed and press **SELECT**. The display will show the current setting for the repeat mode.

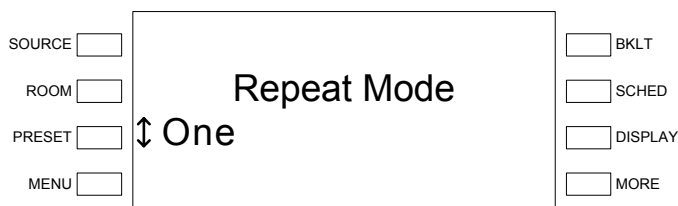
Repeat Mode

- Press the selection control up or down to display the different repeat modes:
 - ⇒ **One:** Repeats the current track.
 - ⇒ **All:** Repeats all of the tracks in a list of songs.
 - ⇒ **Off:** Turns off the repeat function.
- Press **SELECT** to activate the displayed mode and return to the iPod controls.

Shuffle Controls

The AADS can be used to select the iPod's shuffle mode.

- Open the iPod controls as described on page 43.
- Press the selection control up or down until **Shuffle** is displayed and press **SELECT**. The display will show the current setting for the shuffle mode.

Shuffle Mode

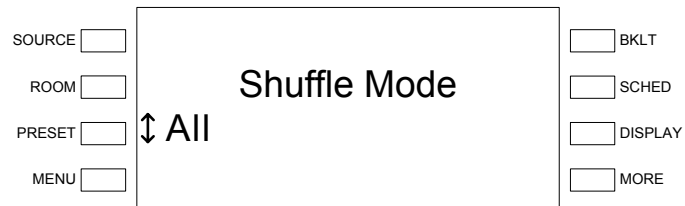

- Press the selection control up or down to display the shuffle modes:
 - ⇒ **Album:** Plays an album in order then shuffles to the next album in the playlist.
 - ⇒ **All:** Shuffles all of the tracks within a playlist.
 - ⇒ **Off:** Turns off the shuffle function.
- Press **SELECT** to activate the displayed mode and return to the iPod controls.

Select Tracks with the AADS

The AADS front panel can be used to select a specific playlist, artist, album, or track on an iPod.

- Open the iPod controls as described on page 43.
- Press the selection control up or down until **Music** is displayed and press **SELECT**. The display will show the top level of the music directory.

Music Controls

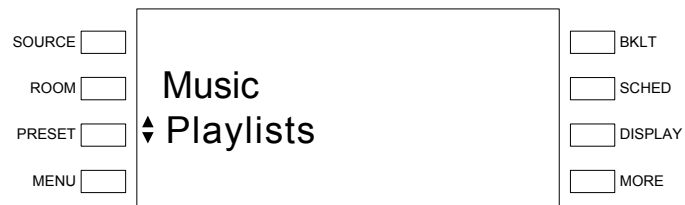

- Press the selection control up or down to display an item (Playlists, Artists, Albums, etc.) and press the **SELECT** button. If a playlist, artist, or album is displayed, pressing the **SELECT** button will list the next subcategory (albums or tracks). If a track name is displayed, pressing the **SELECT** button will begin playback.
- To return to the previous topic (playlist, album, etc.) press the **MENU** button.

Controlling an Adagio Audio Server (AAS)

An AAS can be controlled from the AADS front panel.

The following assumes that the AAS has been installed and connected as described in the AAS guide.

Find the AAS Controls

- Place the AADS in the *Source* mode (refer to “Select a Source” on page 36).

- Press the selection control up or down to display an AAS source (Server 1 for an AAS-1, Servers 1 and 2 for an AAS-2, or Servers 1, 2, 3 and 4 for an AAS-4 if using out-of-the-box functionality). The track and artist information will be displayed.

NOTE: Server 4 will only be displayed if a CEN-IDOC is not installed.

AAS Source

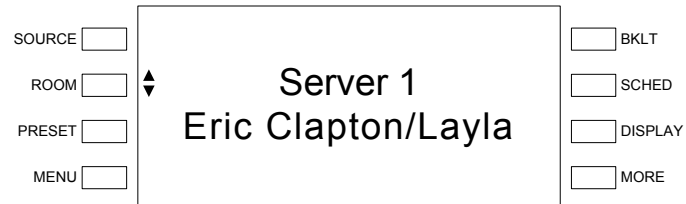

- Press the **SELECT** button to open the AAS display. The display will show the track and artist information. Press **DISPLAY** to show the album name.

AAS Display



- Press the **SELECT** button again to open the AAS controls.

AAS Controls

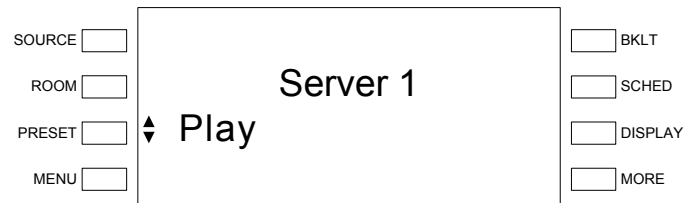

Press the selection control up or down to view the different AAS control options.

Play AAS Tracks with the AADS

The AADS can be used to control the AAS' playback functions.

- Open the AAS controls as described on page 45.
- Press the selection control up or down until **Play** is displayed and press **SELECT**. The display will briefly show instructions for using the AADS front panel to skip songs, pause playback, and resume playback. The display will then show the artist and track information. Press **DISPLAY** to show the album name.

AAS Playing



- To resume or pause playback, press the **SELECT** button.
- To skip to the next track, press the selection control up.
- To return to the beginning of a track or skip to the previous track, press the selection control down.

Browse the AAS Library with the AADS

The AADS front panel can be used to select a category (playlist, artist, album, era, etc.) or song in the AAS library. Categories and individual tracks can either be played or added to the play queue.

- Open the AAS controls as described on page 45.
- Press the selection control up or down until **Browse** is displayed and press **SELECT** to open the browse controls.

Browse Controls

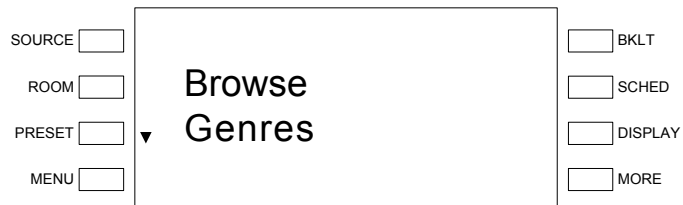

- To select an item (Genre, Artists, Albums, track, etc.), press the selection control up or down to display the item and press the **SELECT** button.

For more information on the library structure, refer to the latest version of the AAS guide.

Track List

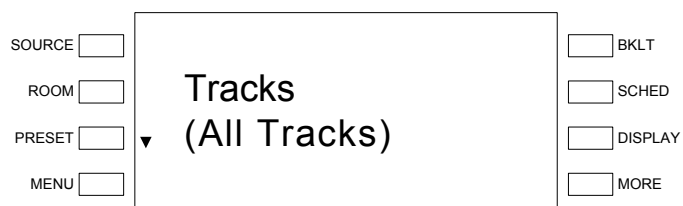

When an individual track or **(All Tracks)** is selected, you will be prompted to either play the selection (and delete the current play queue) or add the selected item to the play queue.

- ⇒ To play the selection and delete the current play queue, press the selection control up or down to display **Play** and press **SELECT**.

- ⇒ To add the selection to the play queue, press the selection control up or down to display **Add** and press **SELECT**.
- ⇒ To cancel, press the selection control up or down to display **Cancel** and press **SELECT**.

The AADS front panel can be used to jump alphabetically within a category.

- To jump within a category while browsing through the AAS library, start browsing through a category as described on page 47 and press the **MORE** button to open the search tool.

Select Search Letter

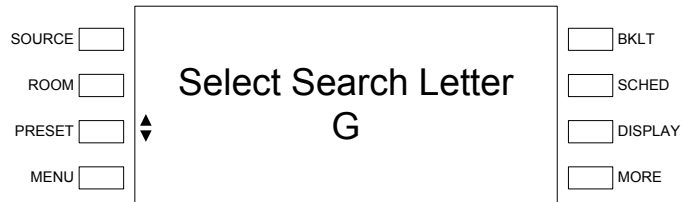

- Press the selection control up or down to display the desired letter and press **SELECT** to jump to the first item in the browsed category that starts with the selected letter.

Repeat Controls

The AADS can be used to select the AAS' repeat mode.

- Open the AAS controls as described on page 45.
- Press the selection control up or down until **Repeat** is displayed and press **SELECT**. The display will show the current setting for the repeat mode.

Repeat Mode

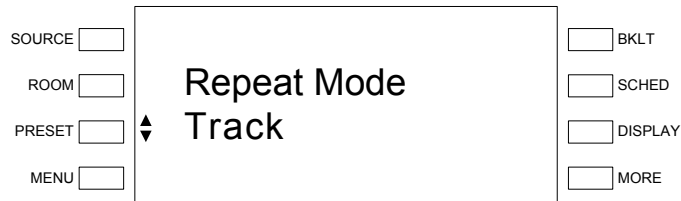

- Press the selection control up or down to display the different repeat modes:
 - ⇒ **Track:** Repeats the track that is currently playing.
 - ⇒ **Queue:** Repeats all of the tracks in the play queue.
 - ⇒ **Off:** Plays all queued items once.
- Press **SELECT** to activate the displayed mode and return to the AAS controls.

Shuffle Controls

The AADS can be used to select the AAS' shuffle mode.

- Open the AAS controls as described on page 45.
- Press the selection control up or down until **Shuffle** is displayed and press **SELECT**. The display will show the current setting for the shuffle mode.

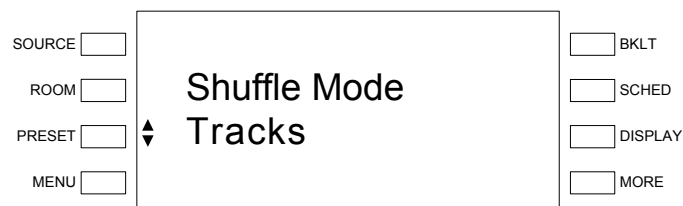
Shuffle Mode

- Press the selection control up or down to display the different shuffle modes:
 - ⇒ **Selections:** Randomly plays all items in the play queue. Group items such as Playlists will be played in order. However, the order of group items will be shuffled.
 - ⇒ **Tracks:** Randomly plays all of the tracks in the play queue.
 - ⇒ **Off:** Turns off the shuffle function.
- Press **SELECT** to activate the displayed mode and return to the AAS controls.

Queue Management

The AADS front panel can be used to manage items in the play queue.

- Open the AAS controls as described on page 45.
- Press the selection control up or down until **Queue** is displayed and press **SELECT**. The display will flash instructions for managing the play queue and then display the play queue.

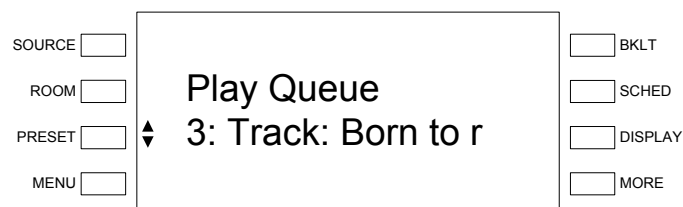
Play Queue Controls

- To clear an item, press the selection control up or down to display an item (Artist, Track, etc.) and press the **SELECT** button.
- To clear the play queue, press the **MORE** button.

Play queues can be saved from an APAD that is connected to the AADS. For more information, refer to the latest version of the Out-Of-The-Box Functionality Guide (Doc. 6493).

Route a Source

Rooms that are connected to the source are indicated on the room buttons.

- Select a source as described on page 36.
- Press room buttons on the AADS or AAE to route the selected source to a room.

NOTE: Volume adjustment is not available when the AADS is in *Source* mode. When a source is routed to a room that is not already on, the room will be turned on at the startup volume specified on page 32.

Room Mode

Room mode is used to select and control a room that is connected to the AADS.

Select a Room

To select a room:

- Press **ROOM** to put the AADS in the *Room* mode. The current selected room is displayed on the LCD along with the source that is routed to the room. If there is no source routed to the room, the display will indicate that the room is off.

Room Mode

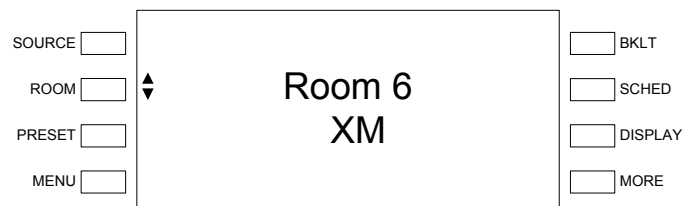

- To select a room, press the selection control up or down until the desired room is displayed on the LCD and press **SELECT**. Alternatively, press a room button on the AADS or AAE (if connected).

Control a Room

After a room is selected, a source can be selected, the room can be turned “off”, room and global volume can be adjusted, or the room output can be muted.

- Select a source by pressing the selection control up or down until the desired source is displayed on the LCD and pressing the **SELECT** button. Press the **MORE** button to view options for adjusting audio parameters (global volume, bass, treble, balance, and loudness).
- Adjust the room’s volume by pressing up or down on the volume control. The volume level will be displayed on the LCD.
- Mute the room output by pressing the **MUTE** button (the MUTE LED will light). Unmute the room by pressing the **MUTE** button again.
- Turn off the room by pressing the room button.

Global Volume

The volume in all rooms can be adjusted from the global volume control. Adjusting the global volume adjusts the volume in every room that is currently turned on. The volumes are adjusted proportionately so the room volume levels do not jump to the same level when the global volume control is used.

- To open the global volume control, press the **MORE** button. The global volume level will be displayed on the LCD.
- Adjust the global volume by pressing up or down on the volume control. The global volume level will be displayed on the LCD. Press **MENU** to return to the room menu.

Global Volume

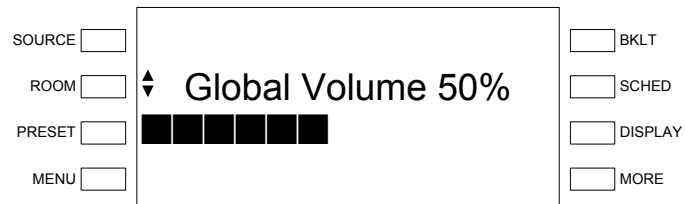

- Press the **SELECT** button to set the global volume level. If left untouched, the new level will be set and the display will return to the room mode.

Adjust the Bass

The bass level of each room can be adjusted independently.

- While in *Room* mode, press the **MORE** button twice.
- Press the **SELECT** button to open the bass control.

Bass Control

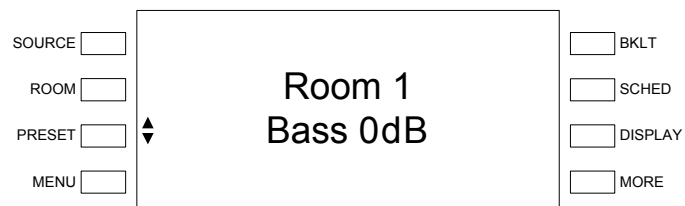

- Adjust the bass level with the selection control. Press up to raise the bass level or press down to lower the bass level.
- Press the **SELECT** button to save changes and return to the previous screen.

Adjust the Treble

The treble levels of each room can be adjusted independently.

- While in *Room* mode, press the **MORE** button twice.
- Press the selection control down until **Treble** is displayed on the LCD.
- Press the **SELECT** button to open the treble control.

Treble Control



- Adjust the treble level with the selection control. Press up to raise the treble level or press down to lower the treble level. Press the soft button labeled **Flat** to set the treble level to 0dB.
- Press the **MENU** button to save changes and return to the previous screen.

Adjust the Balance

The balance of each room can be adjusted independently.

- While in *Room* mode, press the **MORE** button twice.
- Press the selection control down until **Balance** is displayed on the LCD.
- Press the **SELECT** button to open the balance control.

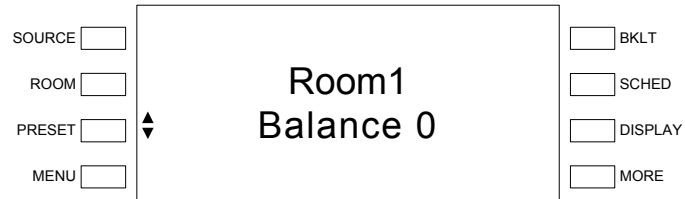
Balance Control

- Adjust the balance with the selection control. Press up to set the balance to the right or press down to set the balance to the left.
- Press **MENU** to save changes and return to the previous screen.

Set Loudness

The loudness settings of each room can be adjusted independently.

- While in *Room* mode, press the **MORE** button twice.
- Press the selection control down until **Loudness** is displayed on the LCD.
- Press the **SELECT** button to open the loudness control.

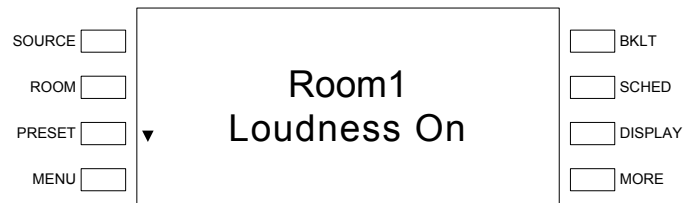
Loudness Control

- The current setting is displayed. If loudness is off, press the selection control up to turn it on. If loudness is on, press the selection control down to turn it off.
- Press **MENU** to save changes and return to the previous screen.

Recall a Preset Group

Press the **PRESET** button to open the Preset Control menu.

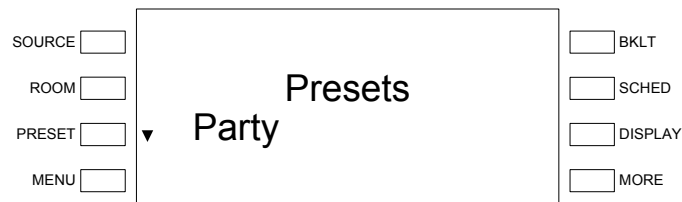
Preset Control Menu

- Scroll through the preset groups by pressing up or down on the selection control. Active preset groups are indicated with a *.
- To activate a preset group, use the selection control to find an inactive preset group and press the **SELECT** button. A * will appear next to the preset group name.

NOTE: If a room is shared by two or more preset groups, the source from the most recently activated preset group will be routed to all of the activated groups.

- To deactivate a preset group, use the selection control to find an active preset group and press the **SELECT** button. The * next to the preset name will disappear.

Turn off the System

Press **STANDBY** to turn off all of the rooms.

Programming Software

Refer to this section only if a custom program for the AADS is to be created.

A built-in program containing the out-of-the-box functionality resides in a protected area of the AADS' flash memory. The program cannot be erased and can be recalled at any time by holding the software reset button during a hardware reset.

The built-in-program cannot be modified using the tools described in this section.

Have a question or comment about Crestron software?

Answers to frequently asked questions (FAQs) can be viewed in the Online Help section of the Crestron website. To post a question or view questions you have submitted to Crestron's True Blue Support, log in at <http://support.crestron.com>. First-time users will need to establish a user account.

Earliest Version Software Requirements for the PC

NOTE: Crestron recommends that you use the latest software to take advantage of the most recently released features. The latest software is available from the Crestron website.

Crestron has developed an assortment of Windows®-based software tools to develop a Cresnet system. The following are the minimum recommended software versions for the PC:

Software

TASK	REQUIRED SOFTWARE VERSION
Simplified programming with wizards for Adagio systems (optional but recommended)	Adagio Composer; part of Crestron SystemBuilder™ version 3.1 or later with SystemBuilder Templates version 3.0 or later; Refer to software release notes or Crestron website for other required Crestron software packages
Program the AADS functions	SIMPL Windows version 2.08 or later with SIMPL+ Cross Compiler version 1.1 or later; Also requires Crestron Database version 18.2.0 or later
Uploading program and firmware	Crestron Toolbox 1.02.37 or later
Create custom LCD screens and page flips for custom programs	SIMPL Windows' front panel editor
Create labels for room buttons	Crestron Engraver 3.0 or later; Requires Crestron Database version 18.2.0 or later

Programming with Adagio Composer

To add additional Crestron sources, third-party sources, and interfaces use Adagio Composer. Adagio Composer is part of the Crestron SystemBuilder application which can be downloaded from the Crestron website.

Adagio Composer provides a quick method of configuring a custom audio distribution system without prior programming knowledge. For additional details,

download Adagio Composer from the Crestron website and examine the extensive help file.

To create more advanced systems that include non-audio distribution devices such as lighting and HVAC, use Crestron SystemBuilder or SIMPL Windows.

Programming with Crestron SystemBuilder

Crestron SystemBuilder is the easiest method of programming, but does not offer as much flexibility as SIMPL Windows. For additional details, download SystemBuilder from the Crestron website and examine the extensive help file.

Any program created for the AADS with SystemBuilder will include the out-of-the-box functionality in addition to any additional programming created with SystemBuilder.

Programming with SIMPL Windows

NOTE: While SIMPL Windows can be used to program the AADS, it is recommended to use Adagio Composer or SystemBuilder for configuring a system.

SIMPL Windows is Crestron's premier software for programming Crestron control systems. It is organized into two separate, but equally important "Managers".

Any SIMPL Windows program written for an AADS will contain all of the AADS' out-of-the-box functions in a protected area of the program. The parts of the program that contain the out-of-the-box functions are locked and cannot be changed or deleted. When a program is compiled, the custom program plus the out-of-the-box program's logic, default front panel operation, and control device (APAD or keypad) logic are loaded.

NOTE: When programming an AADS in SIMPL Windows, always begin with the example program as a program and modify as required. To find example programs, refer to "Example Program" on page 56. Also visit Crestron's True Blue Support on the web for more programming tips.

Configuration Manager

Configuration Manager is the view where programmers "build" a Crestron control system by selecting hardware from the *Device Library*.

- To incorporate the AADS into the system, drag the AADS from the Control Systems folder of the *Device Library* and drop it in the *System Views*.

Locating the AADS in the Device Library

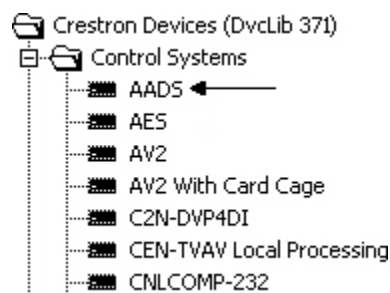

Programming Manager

Programming Manager is the view where programmers "program" a Crestron control system by assigning signals to symbols.

Signals that are part of the AADS' out-of-the-box functionality are locked and cannot be modified or deleted. Locked signals are grayed out in the AADS' SIMPL Windows symbols. To prevent corruption of the out-of-the-box functionality, locked signal names should not be copied or driven to other destinations in the SIMPL Windows program.

The symbol can be viewed by double clicking on the icon or dragging it into *Detail View*. A description for each signal in the symbol is described in the SIMPL Windows help file (F1).

Example Program

An example program for the AADS is available from the Crestron website (<http://www.crestron.com/exampleprograms>).

Uploading and Upgrading

Crestron recommends using the latest programming software and that each device contains the latest firmware to take advantage of the most recently released features. However, before attempting to upload or upgrade, it is necessary to establish communication.

Establishing Communication

Use Crestron Toolbox for communicating with the AADS; refer to the Crestron Toolbox help file for details. There are two methods of communication.

Direct Serial Communication

NOTE: Serial Communication must be used for initial setup of Ethernet parameters when the out-of-the-box functionality is not used.

Direct Serial Communication

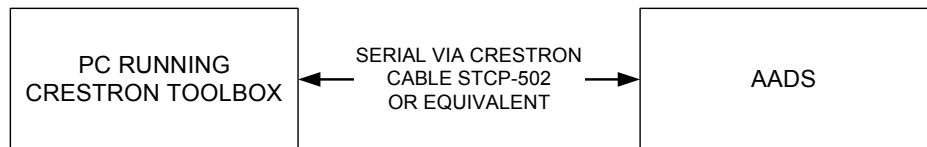

- The **COMPUTER** port on the AADS connects to the serial port on the PC via the included serial cable (Crestron STCP-502 or equivalent).
- Use the Address Book in Crestron Toolbox to create an entry using the expected serial communication protocol (RS232, auto-detect baud rate, no parity, 8 data bits, 1 stop bit, XON/XOFF disabled, RTS/CTS enabled).
- Display the AADS' "System Info" window (click the  icon); communications are confirmed when the device information is displayed.

TCP/IP Communication

NOTE: A connection to an Ethernet network is required for operation with a CEN-IDOC, AAS, or any other TCP/IP enabled device.

Ethernet Communication

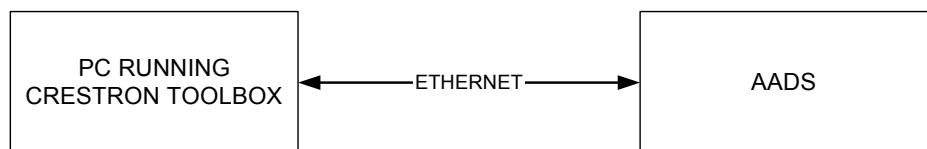

- Establish direct serial communications between the AADS and PC.
- Enter the IP address, IP mask, and default router of the AADS via Crestron Toolbox (**Functions | Ethernet Addressing**); otherwise enable DHCP.

NOTE: When taken out of the box, the AADS is configured for DHCP operation. If a DHCP server is available and the AADS is connected to the network, the IP address can be obtained from the *About* screen as described on page 30.

- Confirm Ethernet connections between the AADS and PC. If connecting through a hub, use CAT5 straight through cables with 8-pin RJ-45 connectors. Alternatively, Use a CAT5 crossover cable to connect the two LAN ports directly, without using a hub.
- Use the Address Book in Crestron Toolbox to create an entry for the AADS with the AADS' TCP/IP communication parameters.
- Display the “System Info” window (click the  icon) and select the AADS entry. Communications are confirmed when the device information is displayed.

Programs and Firmware

- The **Functions** menu displays a list of actions that can be performed on the AADS:
 - ⇒ Upgrade firmware
 - ⇒ IP Table
 - ⇒ SIMPL Program
- Upload the SIMPL Windows file to the AADS using SIMPL Windows or Crestron Toolbox.
- Upload the VisionTools Pro-e file to the AADS using VisionTools Pro-e or the Crestron Toolbox.
- Upgrade AADS firmware via Crestron Toolbox.
 - ⇒ Establish serial or TCP/IP communications with the AADS.
 - ⇒ Select **Functions | Firmware...** to upgrade the AADS firmware.

For details on uploading and upgrading, refer to the SIMPL Windows help file, VisionTools Pro-e help file, or the Crestron Toolbox help file.

Problem Solving

Troubleshooting

The following table provides corrective action for possible trouble situations. If further assistance is required, please contact a Crestron customer service representative.

AADS Troubleshooting

TROUBLE	POSSIBLE CAUSE(S)	CORRECTIVE ACTION
AADS does not function.	AADS is not receiving power.	Use the provided power cord. Verify connection.
C2N-DBF12 or APAD does not function.	AADS is not communicating with C2N-DBF12 or APAD devices.	Verify that C2N-DBF12 and APAD devices are properly connected to the AADS and are identified by the AADS as described on page 28.
AADS only allows six rooms (maximum) when using the out-of-the-box functionality.	A AE is not properly connected to the AADS.	Verify that the AAE is properly connected to the AADS.
	A AE is not registered with AADS.	Open Installer Tools and select "Identify Keypads". Identify all keypads in the system.
		Use Crestron Toolbox to manually set the AADS Net ID to 31.
Buttons on AAE do not light or do anything	A AE is not properly connected to the AADS.	Verify that the AAE is properly connected to the AADS.
	A AE is not registered with AADS.	Open Installer Tools and select "Identify Keypads". Identify all keypads in the system.
		Use Crestron Toolbox to manually set AAE Net ID to 31.
Tuner sources are not working.	Antennas are not properly installed or oriented.	Install and orient the antennas as described on page 19.
CEN-IDOC or AAS devices not listed on the LCD or APAD as available sources.	CEN-IDOC or AAS are not receiving power.	Verify that each device is receiving power.
	CEN-IDOC or AAS are not communicating with AADS over Ethernet.	Verify each device's TCP/IP settings.
	Sources are hidden.	Use Installer Tools to "unhide" missing sources.

(continued on following page)

AADS Troubleshooting (continued)

TROUBLE	POSSIBLE CAUSE(S)	CORRECTIVE ACTION
Sound is not heard.	Room is muted or turned off.	Turn off mute function or route a source to the room.
	Volume is turned down.	Raise volume to an audible level.
	Speakers are not properly connected.	Verify speaker connections.
	Source is not selected/properly connected.	Verify that source is selected and properly connected.

Check Network Wiring**Use the Right Wire**

In order to ensure optimum performance over the full range of your installation topology, Crestron Certified Wire, and only Crestron Certified Wire, may be used. Failure to do so may incur additional charges if support is required to identify performance deficiencies because of using improper wire.

Calculate Power

CAUTION: Use only Crestron power supplies for Crestron equipment. Failure to do so could cause equipment damage or void the Crestron warranty.

CAUTION: Provide sufficient power to the system. Insufficient power can lead to unpredictable results or damage to the equipment. Please use the Crestron Power Calculator to help calculate how much power is needed for the system (<http://www.crestron.com/calculators>).

When calculating the length of wire for a particular Cresnet run, the wire gauge and the Cresnet power usage of each network unit to be connected must be taken into consideration. Use Crestron Certified Wire only. If Cresnet units are to be daisy-chained on the run, the Cresnet power usage of each network unit to be daisy-chained must be added together to determine the Cresnet power usage of the entire chain. If the unit is home-run from a Crestron system power supply network port, the Cresnet power usage of that unit is the Cresnet power usage of the entire run. The wire gauge and the Cresnet power usage of the run should be used in the following equation to calculate the cable length value on the equation's left side.

Cable Length Equation

$$L < \frac{40,000}{R \times P}$$

Where: L = Length of run (or chain) in feet
 R = 6 Ohms (Crestron Certified Wire: 18 AWG (0.75 MM²))
 or 1.6 Ohms (Cresnet HP: 12 AWG (4 MM²))
 P = Cresnet power usage of entire run (or chain)

Make sure the cable length value is less than the value calculated on the right side of the equation. For example, a Cresnet run using 18 AWG Crestron Certified Wire and drawing 20 watts should not have a length of run more than 333 feet. If Cresnet HP is used for the same run, its length could extend to 1250 feet.

NOTE: All Crestron certified Cresnet wiring must consist of two twisted pairs. One twisted pair is the +24V conductor and the GND conductor and the other twisted pair is the Y conductor and the Z conductor.

Strip and Tin Wire

When daisy-chaining Cresnet units, strip the ends of the wires carefully to avoid nicking the conductors. Twist together the ends of the wires that share a pin on the network connector, and tin the twisted connection. Apply solder only to the ends of the twisted wires. Avoid tinning too far up the wires or the end becomes brittle. Insert

the tinned connection into the Cresnet connector and tighten the retaining screw. Repeat the procedure for the other three conductors.

Add Hubs

For larger networks (i.e., greater than 28 network devices), it may become necessary to add a Cresnet Hub/Repeater (CNXHUB) to maintain signal quality throughout the network. Also, for networks with lengthy cable runs, it may be necessary to add a Hub/Repeater after only 20 devices.

Reference Documents

The latest version of all documents mentioned within the guide can be obtained from the Crestron website (<http://www.crestron.com/manuals>). This link will provide a list of product manuals arranged in alphabetical order by model number.

List of Related Reference Documents

DOCUMENT TITLE
2-Series Control Systems Reference Guide
AAE Audio Expander
AAS Audio Server
APAD Wall Mount LCD Controller
C2N-DBF12 Decorator Wall Panels
CEN-IDOC Interface for Apple iPod
Crestron e-Control Reference Guide
User Interface Device Out-Of-The-Box Functionality Guide

Further Inquiries

If you cannot locate specific information or have questions after reviewing this guide, please take advantage of Crestron's award winning customer service team by calling the Crestron corporate headquarters at 1-888-CRESTRON [1-888-273-7876]. For assistance in your local time zone, refer to the Crestron website (<http://www.crestron.com/>) for a listing of Crestron worldwide offices.

You can also log onto the online help section of the Crestron website to ask questions about Crestron products. First-time users will need to establish a user account to fully benefit from all available features.

Future Updates

As Crestron improves functions, adds new features, and extends the capabilities of the AADS, additional information may be made available as manual updates. These updates are solely electronic and serve as intermediary supplements prior to the release of a complete technical documentation revision.

Check the Crestron website periodically for manual update availability and its relevance. Updates are identified as an "Addendum" in the Download column.

Appendix: RDS/RBDS Function Support

Many radio stations transmit additional information, such as traffic information, radio text, real time clock etc., with their regular FM programming. The FM tuner contains circuitry that retrieves this information.

The US format for such information is called the Radio Broadcast Data System (RBDS), and in Europe this format is called the Radio Data System (RDS). There are some differences between the US and European standards.

The tables in this appendix describe information included in the standard.

This information can be viewed on APAD devices that are connected to the AADS.

RDS/RBDS Supported Feature Overview

FEATURES	DESCRIPTION
Program type name (PTY)	There are 31 program types such as jazz, classic etc. Each station that supports RDS will report its program type. (Refer to program type list following this table.)
Program service name (PS)	The station reports its service name such as WIRL, KTU etc.
Program type additional Info (PTYN)	The station sometimes will report additional information about its program type. For example, a program type "Sport" station may report a PTYN of "Football".
Radio text display support (RT)	The station will report radio text information such as phone numbers, artist, song, stations name, etc., in this field. This field could be either 32 or 64 characters.
Universal real time clock (UTC)	Some stations transmit the universal time clock year, month, day, hour, minute, and GMT offset.
Traffic information report (TA/TP)	The stations that support the traffic information.
Station search by TA, TP or TA&TP traffic information types	The FM Tuner can search for stations, which either broadcast or know about other stations that transmit the traffic information. TA = This station has information about other station which carries the traffic announcements. TP = This station broadcasts traffic announcements, but none is being broadcasted right now. TA&TP = This station is currently broadcasting the traffic announcements.
Station search by PTY	The FM Tuner is able to search for station with specified program type.

Return and Warranty Policies

Merchandise Returns / Repair Service

1. No merchandise may be returned for credit, exchange, or service without prior authorization from CRESTRON. To obtain warranty service for CRESTRON products, contact an authorized CRESTRON dealer. Only authorized CRESTRON dealers may contact the factory and request an RMA (Return Merchandise Authorization) number. Enclose a note specifying the nature of the problem, name and phone number of contact person, RMA number, and return address.
2. Products may be returned for credit, exchange, or service with a CRESTRON Return Merchandise Authorization (RMA) number. Authorized returns must be shipped freight prepaid to CRESTRON, 6 Volvo Drive, Rockleigh, N.J. or its authorized subsidiaries, with RMA number clearly marked on the outside of all cartons. Shipments arriving freight collect or without an RMA number shall be subject to refusal. CRESTRON reserves the right in its sole and absolute discretion to charge a 15% restocking fee, plus shipping costs, on any products returned with an RMA.
3. Return freight charges following repair of items under warranty shall be paid by CRESTRON, shipping by standard ground carrier. In the event repairs are found to be non-warranty, return freight costs shall be paid by the purchaser.

CRESTRON Limited Warranty

CRESTRON ELECTRONICS, Inc. warrants its products to be free from manufacturing defects in materials and workmanship under normal use for a period of three (3) years from the date of purchase from CRESTRON, with the following exceptions: disk drives and any other moving or rotating mechanical parts, pan/tilt heads and power supplies are covered for a period of one (1) year; touchscreen display and overlay components are covered for 90 days; batteries and incandescent lamps are not covered.

This warranty extends to products purchased directly from CRESTRON or an authorized CRESTRON dealer. Purchasers should inquire of the dealer regarding the nature and extent of the dealer's warranty, if any.

CRESTRON shall not be liable to honor the terms of this warranty if the product has been used in any application other than that for which it was intended, or if it has been subjected to misuse, accidental damage, modification, or improper installation procedures. Furthermore, this warranty does not cover any product that has had the serial number altered, defaced, or removed.

This warranty shall be the sole and exclusive remedy to the original purchaser. In no event shall CRESTRON be liable for incidental or consequential damages of any kind (property or economic damages inclusive) arising from the sale or use of this equipment. CRESTRON is not liable for any claim made by a third party or made by the purchaser for a third party.

CRESTRON shall, at its option, repair or replace any product found defective, without charge for parts or labor. Repaired or replaced equipment and parts supplied under this warranty shall be covered only by the unexpired portion of the warranty.

Except as expressly set forth in this warranty, CRESTRON makes no other warranties, expressed or implied, nor authorizes any other party to offer any warranty, including any implied warranties of merchantability or fitness for a particular purpose. Any implied warranties that may be imposed by law are limited to the terms of this limited warranty. This warranty statement supersedes all previous warranties.

Trademark Information

All brand names, product names, and trademarks are the sole property of their respective owners. Windows is a registered trademark of Microsoft Corporation. Windows95/98/Me/XP and WindowsNT/2000 are trademarks of Microsoft Corporation. The XM name and XM Ready are registered trademarks of XM Satellite Radio Inc. iPod is a trademark of Apple Computer, Inc., registered in the U.S. and other countries.



Crestron Electronics, Inc.
15 Volvo Drive Rockleigh, NJ 07647
Tel: 888.CRESTRON
Fax: 201.767.7576
www.crestron.com

Operations Guide – DOC. 6458
(2014560)
10.06
Specifications subject to
change without notice.

Free Manuals Download Website

<http://myh66.com>

<http://usermanuals.us>

<http://www.somanuals.com>

<http://www.4manuals.cc>

<http://www.manual-lib.com>

<http://www.404manual.com>

<http://www.luxmanual.com>

<http://aubethermostatmanual.com>

Golf course search by state

<http://golfingnear.com>

Email search by domain

<http://emailbydomain.com>

Auto manuals search

<http://auto.somanuals.com>

TV manuals search

<http://tv.somanuals.com>