

Crestron **QM-AMP3x80 Series** QuickMedia™ 3-Channel Amplifiers

Operations Guide



This document was prepared and written by the Technical Documentation department at:



Crestron Electronics, Inc.
15 Volvo Drive
Rockleigh, NJ 07647
1-888-CRESTRON

Important Safety Instructions

- Read and keep these instructions.
- Heed all warnings.
- Clean only with a dry cloth.
- To prevent shock or fire hazard, do not expose the device to rain or moisture.
- Install in accordance with the included instructions.
- Do not block any ventilation openings.
- Disconnect power prior to connecting or disconnecting equipment
- Do not defeat the safety purpose of the supplied grounding-type plug. The grounding-type plug has two blades and a third grounding prong. The third prong is provided for your safety. If the provided plug does not fit into your outlet, consult an electrician for replacement of the outlet.
- Protect the power cord and other cables so items placed on or against them cannot cause damage.
- Prevent foreign objects from entering the device.
- Refer all servicing to qualified service personnel. Servicing is required when the apparatus has been damaged in any way, such as power supply cord or plug is damaged, liquid has been spilled or objects have fallen into the device, the device has been exposed to rain or moisture, does not operate normally, or has been dropped.

WARNING:

TO PREVENT ELECTRIC SHOCK, DO NOT REMOVE COVER. THERE ARE NO USER SERVICEABLE PARTS INSIDE. ONLY QUALIFIED SERVICE PERSONNEL SHOULD PERFORM SERVICE.



IMPORTANT:

The QM-AMP3x80 series of amplifiers require Class 2 output wiring.

All brand names, product names and trademarks are the property of their respective owners.
©2004 Crestron Electronics, Inc.

Contents

QuickMedia™ 3-Channel Amplifiers: QM-AMP3x80 Series	1
Introduction	1
Features and Functions	1
Applications	2
Specifications	3
Physical Description	4
Industry Compliance	7
Setup	8
Network Wiring	8
Identity Code	9
Rack Mounting	12
Stacking	13
Hardware Hookup	13
Configuration Software	15
Earliest Version Software Requirements for the PC	15
Configuring with Crestron SystemBuilder	16
Configuring with SIMPL Windows	16
Uploading and Upgrading	20
Communication Settings	20
Uploading a SIMPL Windows Program	22
Firmware Upgrade	24
Problem Solving	25
Troubleshooting	25
Further Inquiries	26
Future Updates	26
Return and Warranty Policies	27
Merchandise Returns / Repair Service	27
CRESTRON Limited Warranty	27

QuickMedia™ 3-Channel Amplifiers: QM-AMP3x80 Series

Introduction

Features and Functions

The Crestron® QM-AMP3x80 (hereinafter referred to as AMP3x80) series of three-channel amplifiers deliver exceptional audio performance as part of a complete MediaManager™ AV system or anywhere multi-channel amplification is required. Each model features three amplifier channels to complement the discrete stereo program and mono speech output channels of Crestron's QM-MD7x2 QuickMedia™ Distribution Center and QM-RMCRX QuickMedia Receiver.

Functional Summary

- Four models for domestic and international use
- Built-in amplifiers drive stereo program speakers and/or distributed loudspeakers for speech reinforcement (depending on model)
- Balanced and unbalanced audio
- Class G amplifier topology puts more output power in less space while generating less heat when compared to conventional amplifier designs
- One Rack Unit (1 RU) height
- Optimized for use with Crestron MediaManager components
- Can operate as a stand-alone amplifier or a Cresnet® device
- Built-in power control and internal temperature monitoring via Cresnet from any 2-Series or MediaManager control system
- Touch-settable ID (TSID) ready

The AMP3x80 series feature class G topology to provide power for driving a pair of program loudspeakers and/or distributed ceiling loudspeakers for speech reinforcement. The class G design provides more output power while using less space and generating significantly less heat. The AMP3x80 series feature a fixed input gain that has been optimized for use with Crestron's line of MediaManager components.

Four models make up the AMP3x80 series of amplifiers. Refer to "Specifications" on page 3 for details of each model.

Applications

The AMP3x80 series of amplifiers are part of the Crestron MediaManager line of integrated presentation solutions. They are ideally suited to work with Crestron's MediaManager wall plate media centers, FlipTop media centers, receivers and control processors to provide an integrated solution for amplifying program audio and microphone signals in a presentation system. MediaManager devices are designed for conference room, auditorium, and lecture hall applications, or anywhere else where audio, video, or computer equipment needs to be easily connected and disconnected from a presentation system or room control system.

Of the four models in the AMP3x80 series, two are designated for international use. All of the features are identical to the US versions with the exceptions of the power output rating for the speech channels, the international AC power requirements, the power cord, and the unit nomenclature of QMI-AMP3x80SR (where "SR" stands for "Speech Reinforcement") and QMI-AMP3x80MM (where "MM" stands for "Multi Media"). Throughout this operations guide, all references to AMP3x80 apply to the US and international versions except where noted.

The following diagram shows an AMP3x80 in a lectern application.

QM Solution in Lectern using QM-AMP3x80MM

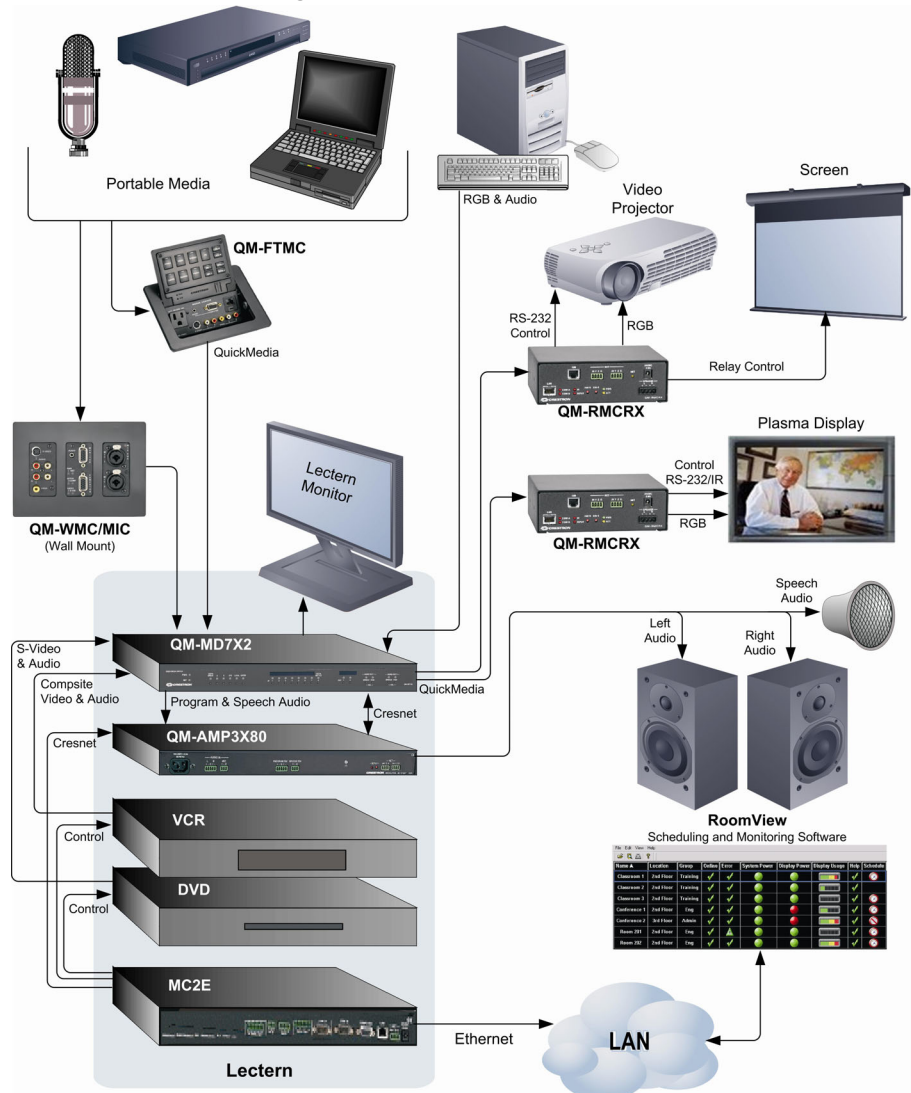

Specifications

The following table provides specifications for the QM-AMP3x80 series of amplifiers.

QM-AMP3x80 Series Specifications

SPECIFICATION	DETAILS
Cresnet Power Requirements	3 Watts (24VDC @ 0.125A)
Default Net ID	09
Control System Update Files 2-Series Control System ^{1,2}	Version C2-V3.093.CUZ or later
Channels	3
Balanced Output Power:	
QM-AMP3x80MM	80 Watts/Channel into 8-ohm loads/110 Watts/Channel into 4-ohm loads (x2), 80 Watts at 70 V (x1)
QMI-AMP3x80MM	80 Watts/Channel into 8-ohm loads/110 Watts/Channel into 4-ohm loads (x2), 80 Watts at 100 V (x1)
QM-AMP3x80SR	80 Watts at 70 V (x3)
QMI-AMP3x80SR	80 Watts at 100 V (x3)
Input Impedance	Balanced: 19k ohms Unbalanced: 9.5k ohms
Input Sensitivity	1.2 Vrms for rated power (80 W / 8 ohms)
Power Bandwidth	75 W, 20-20k Hz, 8 ohms 95 W, 20-20k Hz, 4 ohms 75 W, 100-20k Hz, 70/100 V outputs
Frequency Response	20-20k Hz, +0 dB / -0.5 dB / 8 ohm outputs 100-20k Hz, +0 dB / -3 dB, 70 / 100 V outputs
Total Harmonic Distortion (1k Hz)	< 0.1% @ 1 Watt into 4 and 8 ohms < 0.1% @ 75 Watts into 8 ohms < 0.2% @ 100 Watts into 4 ohms < 0.1% @ 1 and 75 Watts into 70/100 V outputs
Signal to Noise Ratio (S/N) "A" Weighted	110dB below rated output power, A-weighted
Damping Factor	> 150 (4/8 ohm outputs)
QM-AMP3x80 Firmware	QM-AMP3x80.v2.0.upg or later
Rack Space Required	1U
Power Input Requirements:	
QM-AMP3x80MM, QM-AMP3x80SR QMI-AMP3x80MM, QMI-AMP3x80SR	120 VAC +15%/-25%, 60 Hz 230 VAC +15%/-25%, 50 Hz
Environmental Temperature & Humidity	32 to 104° F (0 to 40°C) 10 to 90% RH (non-condensing)
Dimensions & Weight	Height: 1.96 in (4.99 cm) Width: 19.00 in (48.26 cm) – with ears 17.01 in (43.21 cm) – without ears Depth: 12.53 in (31.82 cm) Weight: AMP3x80MM: 15.2 lb (6.9 kg) AMP3x80SR: 17.4 lb (7.9 kg)

1. The latest software versions can be obtained from the Downloads | Software Updates section of the Crestron website (www.crestron.com). Refer to the NOTE following these footnotes.
2. Crestron 2-Series control systems include the AV2 and PRO2. Consult the latest Crestron Product Catalog for a complete list of 2-Series control systems.

NOTE: Crestron software and any files on the website are for Authorized Crestron dealers and Crestron Authorized Independent Programmers (CAIP) only. New users may be required to register to obtain access to certain areas of the site (including the FTP site).

Physical Description

The AMP3x80 is housed in a black enclosure with labeling on the front and rear panels. The front panel has a master power switch and LED to indicate AC power. All audio input and output, Cresnet system, and power connections are made on the rear panel. The rear panel also has a switch that bypasses Cresnet control so the amplifier can operate in a stand-alone configuration. A pushbutton on the rear panel with an accompanying LED is used to set the AMP3x80's network ID. Refer to the following illustrations of the front and rear panels and the physical views.

Two mounting ears are provided for rack mounting, and four round rubber feet are preinstalled for stability and to prevent slippage in tabletop placement or stacking configurations. For information on rack mounting and use of the rubber feet, refer to "Rack Mounting" on page 12.

QM-AMP3x80MM



QM-AMP3x80SR



QM-AMP3x80 Physical Views

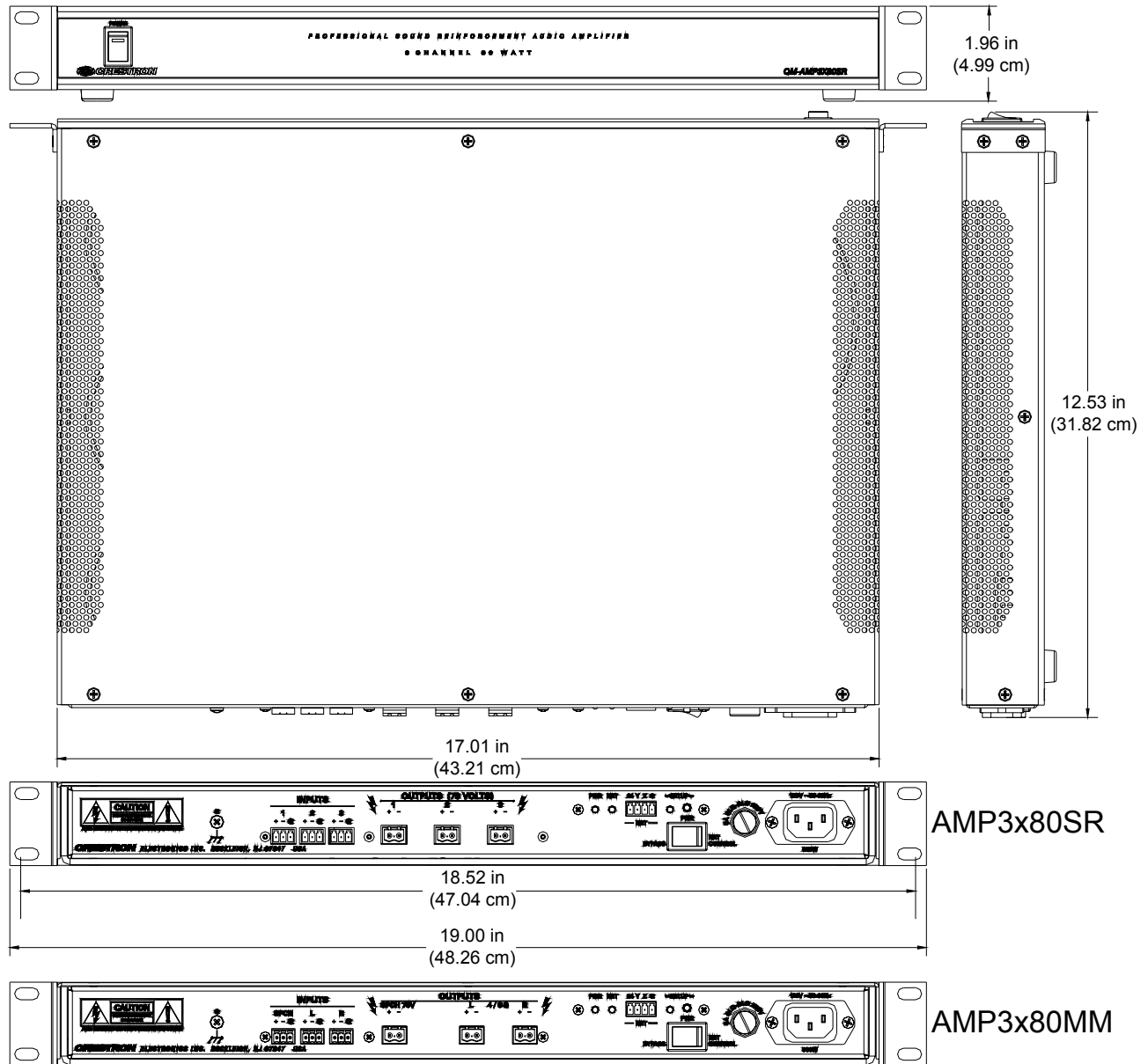

NOTE: The rear panel of the AMP3x80MM, which has different connectors than the AMP3x80SR, is shown on the bottom of the diagram. For a detailed view, refer to “Hardware Hookup” on page 13.

Ports

All connections to the AMP3x80 are made through the ports on the rear panel. Refer to the illustrations and descriptions that follow.

NOTE: Interface connectors for the NET and audio ports are provided with the AMP3x80.

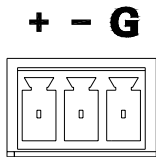
**INPUTS**

The AMP3x80 contains three sets of balanced/unbalanced, line-level audio inputs. On the QM/QMI-AMP3x80MM, two of the inputs are reserved for program audio and one input is reserved for speech audio. The inputs are labeled to designate program and speech audio. On the QM/QMI-AMP3x80SR, all of the inputs are designated for speech audio.

Each input port uses a 3-position mini-terminal block connector for connecting the audio output of a QM-RMCRX, QM-MD7x2, or other preamp. For wiring information, refer to “Hardware Hookup” on page 13.

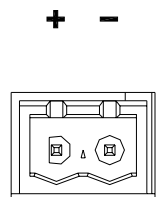
**OUTPUTS**

The AMP3x80 contains three sets of balanced speaker outputs. The QM/QMI-AMP3x80MM has two outputs that are reserved for the left and right channels of the audio program (4/8 ohm impedance) and one output that is reserved for speech audio distribution (70 V or 100 V output). The outputs are labeled to designate program and speech audio. On the QM/QMI-AMP3x80SR, all of the outputs are for audio distribution (70 V or 100 V).

Each output port uses a 2-position terminal block connector for connecting the appropriate type speaker. For wiring information, refer to “Hardware Hookup” on page 13.

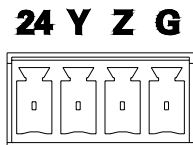
**NET**

This 4-position mini-terminal block connector is used to connect the AMP3x80 to the Cresnet system. Data and network power for the AMP3x80 are provided via the connection. Refer to “Network Wiring” on page 8 for more information.

**5A SLO-BLO 250V (T2.5A 250V on QMI)**

This port holds the operating fuse for the AMP3x80. If the fuse is blown, replace with the type described on the label. On the QM-AMP3x80SR and QM-AMP3x80MM, the port is labeled **5A SLO-BLO 250V**. The port on the QMI-AMP3x80SR and QMI-AMP3x80MM is labeled **T2.5A 250V**.

WARNING: Only use the specified type of fuse when replacing a blown fuse. Failure to do so may cause damage to the amplifier.

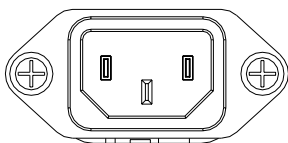
**120V ~50-60 Hz (230V ~50-60 Hz on QMI)**

This IEC-320-C-14 port is used to connect the AMP3x80 to an AC outlet. On the QM-AMP3x80SR and QM-AMP3x80MM, the port is labeled **120V ~50-60 Hz**. The QMI-AMP3x80SR and QMI-AMP3x80MM are labeled **230V ~50-60 Hz**. Use the supplied power cord to connect to an AC outlet.

Switches, Buttons, and Indicators

POWER

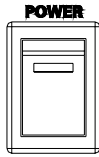

This two-position switch, located on the front panel, turns operating power to the AMP3x80 circuitry on and off. A built-in LED indicates when the switch is in the “ON” position. The switch must be in the “ON” position when the unit is to be controlled by the control system or when it is operating as a stand-alone unit.

PWR (BYPASS/NET CONTROL)

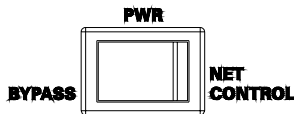

This two-position switch, located on the rear panel, is used to override Cresnet control of the amplifier so it can operate as a stand-alone unit. When the switch is in the **NET CONTROL** position, the amplifier will be controlled and monitored by the Crestron control system (the amplifier must be connected to a Crestron control system running a program that includes the amplifier). When the switch is in the **BYPASS** position, the amplifier will operate independently of the control system.

SETUP LED and Pushbutton



The AMP3x80 devices are TSID ready. Located on the rear of each device, the **SETUP** pushbutton and its associated LED are used for setting up the unit’s network ID during the initial configuration of a Cresnet system or when the device is being added/replaced. Refer to “Method B (Touch Settable ID)” on page 10 for detailed information.

PWR (Power)



This LED, located on the rear panel, illuminates when 24 VDC is supplied to the AMP3x80 and the **POWER** switch on the front panel is in the “ON” position.

NET



This LED, located on the rear panel, illuminates when communication between the control system and the AMP3x80 is established (the unit is polled on the network). Illumination indicates that the SIMPL Windows program currently loaded has a network device defined at the same Net ID as the AMP3x80. The LED flashes when communication with the processor occurs.

Industry Compliance

As of the date of manufacture, this unit has been tested and found to comply with specifications for CE marking and standards per EMC and Radio Communications Compliance Labeling (N11785)



NOTE: This device complies with part 15 of the FCC rules. Operation is subject to the following two conditions: (1) this device may not cause harmful interference, and (2) this device must accept any interference received, including interference that may cause undesired operation.

This equipment has been tested and found to comply with the limits for a Class B digital device, pursuant to part 15 of the FCC Rules. These limits are designed to provide reasonable protection against harmful interference in a residential installation. This equipment generates, uses and can radiate radio frequency energy and, if not installed and used in accordance with the instructions, may cause harmful interference to radio communications. However, there is no guarantee that interference will not occur in a particular installation. If this equipment does cause harmful interference to radio or television reception, which can be determined by turning the equipment off and on, the user is encouraged to try to correct the interference by one or more of the following measures:

- Reorient or relocate the receiving antenna.
 - Increase the separation between the equipment and receiver.
 - Connect the equipment into an outlet on a circuit different from that to which the receiver is connected.
 - Consult the dealer or an experienced radio/TV technician for help.
-

Setup

Network Wiring

CAUTION: Use only Crestron power supplies for Crestron equipment. Failure to do so could cause equipment damage or void the Crestron warranty.

CAUTION: Provide sufficient power to the system. Insufficient power can lead to unpredictable results or damage to the equipment. Please use the Crestron Power Calculator (http://www.crestron.com/dealer-tech_resources/power_calculator.asp) to help calculate how much power is needed for the system.

CAUTION: Possible equipment damage if miswired.

NOTE: When installing network wiring, refer to the latest revision of the wiring diagram(s) appropriate to your specific system configuration, available from the Downloads | Product Manuals | Wiring Diagrams section of the Crestron website (www.crestron.com).

NOTE: Do not power up system until all wiring is verified. Care should be taken to ensure data (Y, Z) and power (24, G) connections are not crossed.

When calculating the wire gauge for a particular Cresnet run, the length of the run and the power factor of each Cresnet unit to be connected must be taken into consideration. If Cresnet units are to be daisy-chained on the run, the power factor of each network unit to be daisy-chained must be added together to determine the power factor of the entire chain. The length of the run in feet and the power factor of

the run should be used in the following resistance equation to calculate the value on the right side of the equation.

Resistance Equation

$$R < \frac{40,000}{L \times PF}$$

Where: R = Resistance (refer to table below).
L = Length of run (or chain) in feet.
PF = Power factor of entire run (or chain).

The required wire gauge should be chosen such that the resistance value is less than the value calculated in the resistance equation. Refer to the table after this paragraph.

Wire Gauge Values

RESISTANCE (R)	WIRE GAUGE
4	16
6	18
10	20
15	22
13	Doubled CAT5
8.7	Tripled CAT5

NOTE: All network wiring must consist of two twisted pairs. One twisted pair is the +24V conductor and the GND conductor. The other twisted pair is the Y and Z conductors.

NOTE: When daisy-chaining Cresnet units, strip the ends of the wires carefully to avoid nicking the conductors. Twist together the ends of the wires that share a pin on the network connector, and tin the twisted connection. Apply solder only to the ends of the twisted wires. Avoid tinning too far up the wires or the end becomes brittle. Insert the tinned connection into the Cresnet connector and tighten the retaining screw. Repeat the procedure for the other three conductors.

NOTE: For larger networks (i.e., greater than 28 network devices), it may become necessary to add a Cresnet Hub/Repeater (CNXHUB) or Cresnet Network Poll Accelerator (C2N-NPA8) to maintain signal quality throughout the network. Also, for networks with lengthy cable runs, it may be necessary to add a Hub/Repeater after only 20 devices.

Identity Code

All equipment and user interfaces within the network require a unique identity code (Net ID). These codes are two-digit hexadecimal numbers from 03 to FE. The Net ID of each unit must match an ID code specified in the SIMPL Windows program. Refer to “Setting the Net ID in Device Settings” on page 18 for details of the SIMPL Windows procedure.

Refer to the note on page 20 for a definition of Viewport.

The Net ID of the AMP3x80 has been factory set to **09**. The Net IDs of multiple AMP3x80s in the same system must be unique. Net IDs are changed from a personal computer (PC) via the Crestron Viewport.

NOTE: For detailed information on establishing communication between the PC and control system, refer to “Communication Settings” on page 20. If communication cannot be established, refer to the “Troubleshooting Communications” section in the respective Operations Guide for the control system.

There are two different methods—Method A or Method B—for setting the Net ID:

Method A (Cresnet address-settable ID), described below, applies to devices in a Cresnet system with a 2-Series control system that require a single unit be the only network device connected to the control system.

Method B (Touch Settable ID or TSID), which begins below, applies to all TSID-ready devices in a Cresnet system with 2-Series control system upgrade file (CUZ) version 3.029 or later. TSID functionality makes it possible for the control system to recognize a network device via its serial number, which is stored in the device's memory. This method does not require that any devices be disconnected from the network; Net IDs may be set with the entire Cresnet system intact. This method requires the use of the Crestron Viewport version 3.35 or later.

Use the appropriate method to set the Net ID.

Method A (Cresnet address-settable ID)

1. Ensure that the device requiring a Net ID change is the only unit connected to the control system.
2. Open the Crestron Viewport.
3. From the Viewport menu, select **Functions | Set Network ID**. The software checks the baud rate and then opens the "Set Network ID" window.
4. In the "Set Network ID" window, select the device requiring a Net ID change from the *Current Network Devices* text window.
5. Select the new Net ID for the device from the *Choose the new network ID for the selected device (Hex)*: text box.
6. Click Set ID to initiate the change. This will display the "ID command has been sent" window.
7. In the "Command Complete" window, click **OK**.
8. In the *Current Network Devices* text window, verify the new Net ID code.
9. In the "Set Network ID" window, click **Close**.

NOTE: The new Net ID code may also be verified by selecting **Diagnostic | Report Network Devices** in the Viewport (alternately, select **F4**).

10. Repeat this procedure for each additional network device requiring a Net ID change.

Method B (Touch Settable ID)

Before using this method, you should have a list of all current network devices and their Net IDs, to avoid assigning duplicate IDs.

Set Net ID by TSID

These procedures are for TSID-enabled network devices during the initial configuration of a Cresnet system or when such devices are being added/replaced.

1. Ensure that all network devices are connected to the control system.
2. Open the Crestron Viewport version 3.35 or later.

- From the Viewport menu, select **Functions | Assign Cresnet ID by Serial Number**. The “Set Net ID by TSID” window appears, shown below. The window is first displayed with the data fields empty.
- Click on the **Search for Touch Settable Devices** button. The system searches the network and lists all TSID-enabled devices found. The list is similar to the report produced by pressing **F4** (Report Network Devices); the first eight digits of each line constitute the TSID number (hexadecimal form of the serial number).

“Set Net ID by TSID” Window

- Enter either the serial number or TSID number of the device that requires a change. The list scrolls to and highlights the device listing. The listing should show the device’s default Cresnet ID (a.k.a. Net ID).
- Enter the Cresnet ID that the device should be set to and click **OK**. The number you enter should appear on the list.

CAUTION: This function does not prevent you from setting duplicate IDs. Be sure to check current assignments before entering the desired Cresnet ID number.

Serial Number to TSID Conversion

This utility is useful in a case where there are multiple devices of the same type on a network, you need to locate a particular one, you know the TSID but not the serial number, and your site installation list is based on device serial numbers. In this (or the reverse) situation, do the following:

- Open the Crestron Viewport.
- From the Viewport menu, select **Functions | Serial Number ↔ TSID Conversion Tool**. The “Serial Number ↔TSID Conversion Tool” window is displayed.

“Serial Number to TSID Conversion Tool” Window

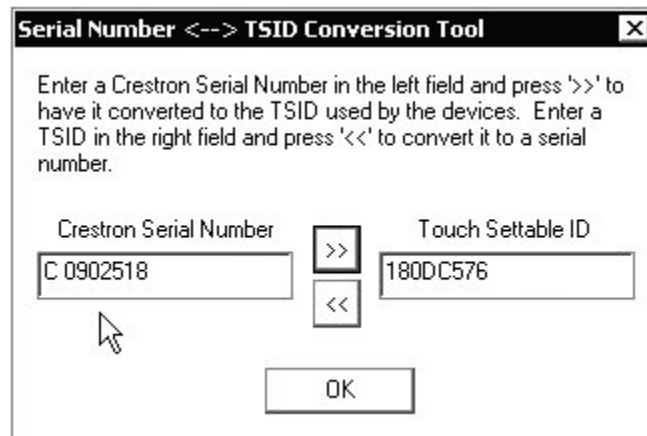

3. Enter the serial number or TSID number as instructed; press the appropriate button to obtain the corresponding number.

NOTE: Enter serial numbers, including spaces, exactly as they appear on the unit label. Alpha characters in serial numbers or TSID numbers may be entered in upper or lower case.

Rack Mounting

WARNING: To prevent bodily injury when mounting or servicing this unit in a rack, take special precautions to ensure that the system remains stable. The following guidelines are provided to ensure your safety:

- When mounting this unit in a partially filled rack, load the rack from the bottom to the top with the heaviest component at the bottom of the rack.
- If the rack is provided with stabilizing devices, install the stabilizers before mounting or servicing the unit in the rack.

NOTE: If rack mounting is not required, rubber feet are preinstalled for tabletop mounting or stacking. Refer to “Stacking” on page 13 for details.

NOTE: Reliable earthing of rack-mounted equipment should be maintained. Particular attention should be given to supply connections other than direct connections to the branch circuit. (e.g., use of power strips).

NOTE: There is no specific amount of clearance required between components in a rack. However, if there are multiple amplifiers or heat-generating devices stored in a closed rack, the amplifier should be placed below other equipment as it dissipates heat from the bottom. Putting an open space between the components or providing proper ventilation for the equipment in the rack can prolong the life of the amplifier.

Two “ears” are provided with the AMP3x80 so that the unit can be rack mounted. These ears must be installed prior to mounting. Complete the following procedure to attach the ears to the unit. The only tool required is a #2 Phillips screwdriver.

1. There are several screws (#6-32 x 0.5" L) that secure each side of the AMP3x80 top cover. Using a #2 Phillips screwdriver, remove the two screws closest to the front panel from one side of the unit. Refer to the diagram following step 3 for a detailed view.

2. Position a rack ear so that its mounting holes align with the holes vacated by the screws in step 1.
3. Secure the ear to the unit with the two screws from step 1, as shown in the following diagram.

Ear Attachment for Rack Mounting

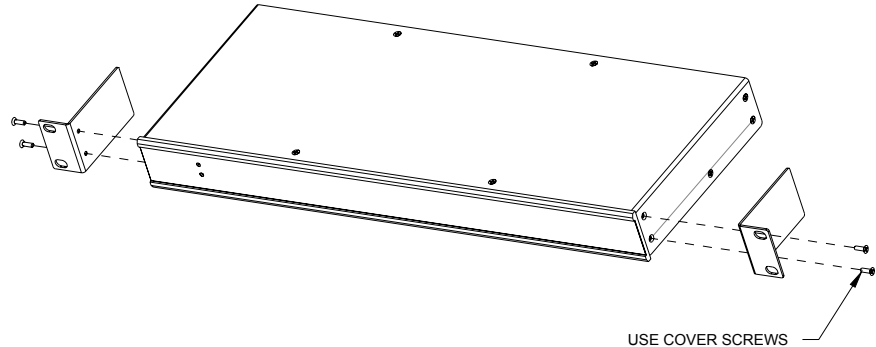

4. Repeat procedure (steps 1 through 3) to attach the remaining ear to the opposite side.

Stacking

Four "feet" are preinstalled on the AMP3x80 so that if the unit is not rack mounted, the rubber feet can provide stability when the unit is placed on a flat surface or stacked.

Hardware Hookup

Refer to the following hookup diagrams for the appropriate AMP3x80 model and, aside from attaching power last, complete the connections in any order. Refer to "Network Wiring" on page 8 when making network connections.

WARNING: To prevent injury and / or equipment damage due to electric shock, disconnect power from the AMP3x80 prior to making any wiring connections.

NOTE: Use only the supplied power cord, or equivalent, to connect to the AC power source.

NOTE: To prevent overheating, do not operate this product in an area that exceeds the environmental temperature range listed in the table of specifications. Consideration must be given if installed in a closed or multi-unit rack assembly since the operating ambient temperature of the rack environment may be greater than the room ambient. Contact with thermal insulating materials should be avoided on all sides of the unit.

NOTE: The maximum continuous current from equipment under any external load conditions shall not exceed a current limit that is suitable for the minimum wire gauge used in interconnecting cables. The ratings on the connecting unit's supply input should be considered to prevent overloading the wiring.

Hardware Connections for the QM-AMP3x80MM (Back of the Unit is Shown)

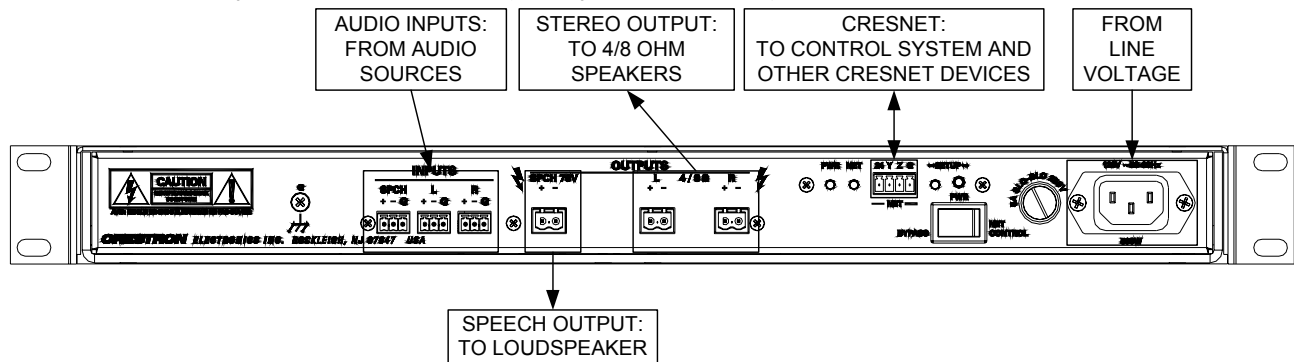

NOTE: The QMI-AMP3x80MM speech output is rated at 100V.

Hardware Connections for the QM-AMP3x80SR (Back of the Unit is Shown)

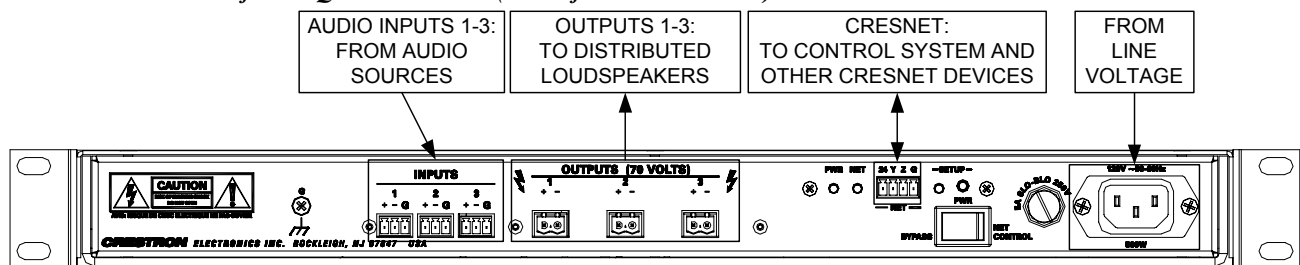

NOTE: The QMI-AMP3x80SR outputs are rated at 100V.

Connecting Audio Sources

The AMP3x80 can receive balanced or unbalanced audio input signals. Refer to the following diagrams when connecting balanced and unbalanced sources to the signal inputs on the AMP3x80.

Wiring for Unbalanced Audio (left) and Balanced Audio (right)

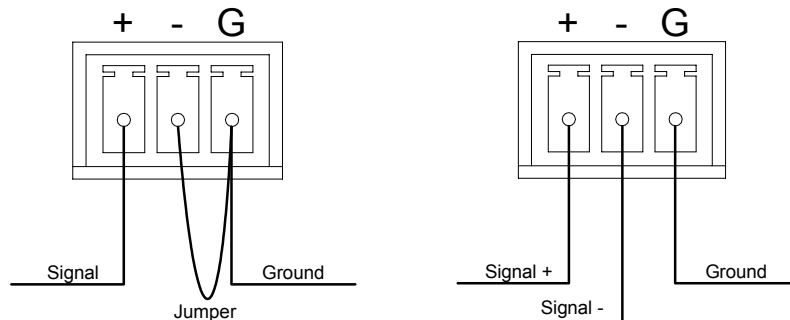

Connecting Speakers to Audio Outputs

Each model in the AMP3x80 series is equipped with three speaker outputs.

The AMP3x80MM uses one of the speaker outputs for a 70V public address speaker, while the two remaining outputs can be connected to a pair of 4/8 ohm stereo speakers. On the QMI-AMP3x80MM, the public address speaker output is rated for use with a 100V public address speaker.

The QM-AMP3x80SR has three outputs that are rated for use with three 70V public address speakers. The outputs on the QMI-AMP3x80SR are rated for use with 100V public address speakers.

WARNING: The audio outputs operate at high voltage/current. Disconnect power prior to connecting speakers to avoid damage to equipment.

Configuration Software

Have a question or comment about Crestron software?

Answers to frequently asked questions (FAQs) can be viewed in the Online Help section of the Crestron website (www.crestron.com). To post a question or view questions you have submitted to Crestron's True Blue Support, log in at <http://support.crestron.com>. First-time users will need to establish a user account.

Configuration is easy thanks to Crestron's Windows-based programming software. Crestron SystemBuilder™ software creates a complete project, with no special programming required. SystemBuilder completes all necessary programming for a base system including all touchpanel screens and the control system program. The program output of SystemBuilder is a SIMPL Windows program with much of the functionality encapsulated in macros and templates. Once SystemBuilder creates the project, the system interfaces and program logic can be customized in SystemBuilder or can be easily modified with Crestron development tools (i.e., SIMPL Windows and Crestron VisionTools® Pro-e (VT Pro-e) software packages).

SystemBuilder comes with templates for all supported interfaces. If a user wishes to create a touchpanel project using templates with a different look-and-feel, this can be accomplished by making a custom template. This custom template can then be used by SystemBuilder to create the final project files to be loaded into the panels. Alternatively, VT Pro-e can be used to tweak projects created with the SystemBuilder or develop original touchpanel screen designs.

Once the program created by SystemBuilder is loaded into the control system, Digital Media Tools (DMT) Software can be used to tune the system for optimal performance. DMT software can be used to test the quality of audio and video signals as well as fine-tune audio and video settings.

Earliest Version Software Requirements for the PC

NOTE: Crestron recommends the use of SystemBuilder and Digital Media Tools software for creating and fine-tuning a QuickMedia system.

NOTE: Crestron recommends that you use the latest software to take advantage of the most recently released features. The latest software is available from the Downloads | Software Updates section of the Crestron website (www.crestron.com).

NOTE: Crestron software and any files on the website are for Authorized Crestron dealers and Crestron Authorized Independent Programmers (CAIP) only. New users may be required to register to obtain access to certain areas of the site (including the FTP site).

The following are the earliest useable software version requirements for the PC:

- (Optional) SystemBuilder (Requires SIMPL Windows).
- SIMPL Windows version 2.05.08 or later with library update file 291. Requires SIMPL+® Cross Compiler version 1.1.
- Crestron Database version 16.2.0 or later. Required by SIMPL Windows.
- Digital Media Tools software version 3.01.00 or later.

Configuring with Crestron SystemBuilder

NOTE: The AMP3x80 is configured with Crestron SystemBuilder version 1.0 software. As of press time, this version of Crestron SystemBuilder had not been released. Please check the Crestron FTP site.

The Crestron SystemBuilder interface guides you through a few basic steps for specifying the control system, designating rooms and touchpanels, devices, and functionality. The Crestron SystemBuilder then configures the system, including all touchpanel projects and control system logic, including Crestron RoomView™ management software.

The Crestron SystemBuilder is fully integrated with the Crestron suite of software development tools, including SIMPL Windows, Cross Compiler, VT Pro-e, Crestron Database, User IR Database, and User Modules Directory. The Crestron SystemBuilder accesses all these tools behind the scenes, enabling you to easily create robust systems.

SystemBuilder provides a step-by-step process that guides the user through the process of selecting components and determining signal routing and control. The control code and complete equipment lists are automatically generated. Crestron SystemBuilder automatically compiles and uploads your program to the control system.

A template is provided with SystemBuilder to allow easy configuration. After entering the appropriate information in each step, SystemBuilder creates the control system logic and touchpanel pages, ready to upload to the controller.

NOTE: After uploading the program to the control system and installing the hardware, values for properties such as volume, balance, treble and bass can be adjusted as required.

For additional details, download SystemBuilder from the Crestron website (www.crestron.com) and examine the extensive help file.

Configuring with SIMPL Windows

NOTE: While SIMPL Windows can be used to configure the AMP3x80, Crestron recommends SystemBuilder and Digital Media Tools software for configuring and tuning a QuickMedia system.

NOTE: The following are acceptable file extensions for programs that include a QM-RMCRX and an AMP3x80, developed for specific control system types:

- .smw *projectname.smw* (source file)
- .spz *projectname.spz* (compiled file for 2-Series)
- .usp *projectname.usp* (source code module for SIMPL+)

.ir *projectname.ir* (user IR)
 .umc *projectname.umc* (user macro)
 .ush *projectname.ush* (completed SIMPL+)

SIMPL Windows is the Crestron graphical, Windows®-based development tool for programming control systems. The SIMPL Windows interface provides two workspaces: the Configuration Manager, for configuring the control system, touchpanels, and controlled network devices; and Program Manager, for designing the logic and functionality of the control system.

In addition, you can use the powerful Crestron Viewport utility to accomplish multiple system tasks, such as uploading the program to the control system and performing diagnostic functions. Together with the Crestron Database, these tools provide you with the essential components you need to program the QM-RMCRX and AMP3x80. Crestron software is available from the Crestron website (www.crestron.com) — registration is required for downloading.

NOTE: Crestron software and any files on the website are for Authorized Crestron dealers and Crestron Authorized Independent Programmers (CAIP) only. New users may be required to register to obtain access to certain areas of the site (including the FTP site).

NOTE: The information in this section assumes that the reader has knowledge of SIMPL Windows. If not, refer to the extensive help information provided with the software.

NOTE: In the following example, a QM-RMCRX is used as the QuickMedia receiver for the AMP3x80.

In Configuration Manager, drag the QM-RMCRX from the Control Systems folder of the *Device Library* to *System Views*.

QM-RMCRX System View

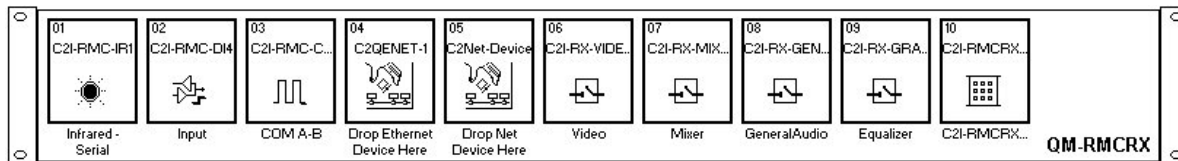

The *System Views* lower pane displays the QM-RMCRX system tree. This tree can be expanded to display and configure the communications ports.

Expanded QM-RMCRX System Tree

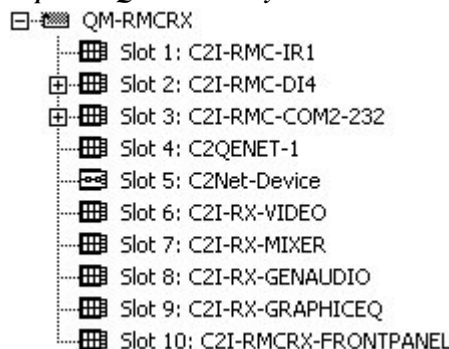

C2Net-Device Slot in Configuration Manager

To incorporate an AMP3x80 into the system, drag the QM-AMP3x80 from the Cresnet Control Modules | QM Series folder of the *Device Library* and drop it in *System Views*. The QM-RMCRX system tree displays the QM-AMP3x80 in Slot 5, with a default Net ID of 09 as shown in the following illustration.

NOTE: The first AMP3x80 in a system is preset with a Net ID of 09 when its symbol is dragged into the upper pane of *System Views*. Additional units are assigned different Net ID numbers as they are added.

C2Net Device, Slot 5

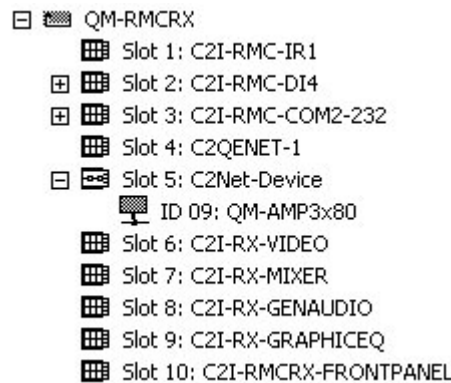

Setting the Net ID in Device Settings

Double-click the QM-AMP3x80 icon in the upper pane to open the “Device Settings” window. This window displays QM-AMP3x80 device information. The Net ID can be changed in this window using the *Net ID* tab, as shown in the following figure.

“QM-AMP3x80 Device Settings” Window

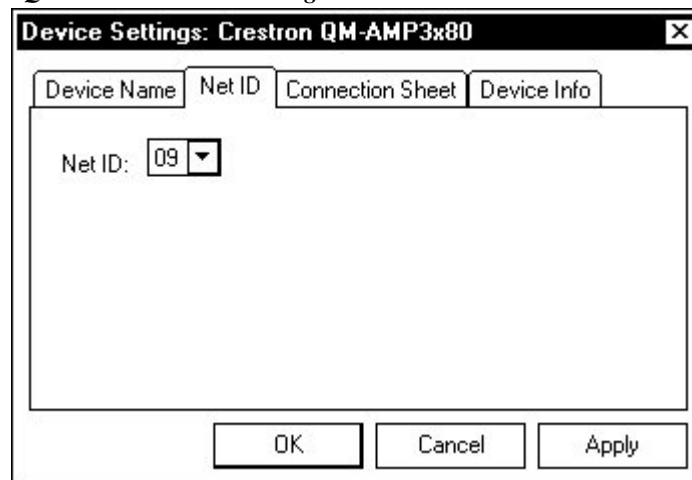

NOTE: This procedure sets the Net ID for the AMP3x80 in the program only. It does not automatically set the Net ID for the AMP3x80 itself. SIMPL Windows automatically changes Net ID values of a device added to a program if a duplicate device or a device with the same Net ID already exists in the program. Always ensure that the hardware and software settings of the Net ID match. For Net ID hardware setting details, refer to “Identity Code” on page 9.

QM-AMP3x80 Symbol in Programming Manager

Programming Manager is where programmers “program” a Crestron control system by assigning signals to symbols. The following describes the AMP3x80 symbol in the SIMPL Windows Programming Manager.

QM-AMP3x80 symbol in SIMPL Windows Programming Manager

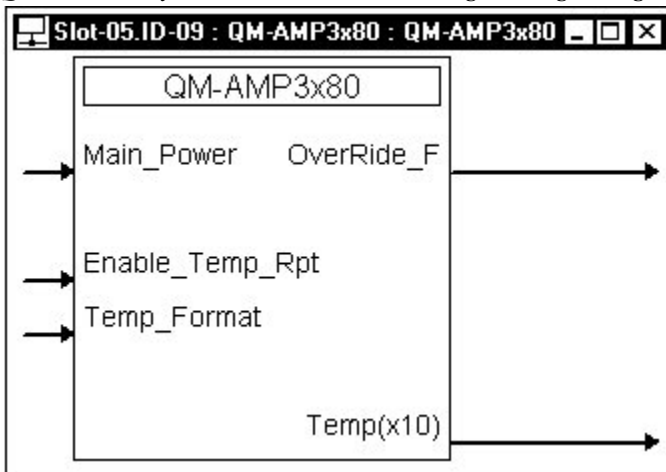

QM-AMP3x80 Digital Input Signal Descriptions

INPUT	DESCRIPTION
Main_Power	Activates the main operating power to the AMP3x80 circuitry for as long as <Main_Power> remains high. When the signal goes low, main power shuts off. The POWER switch on the front panel must be in the <i>ON</i> position. The PWR switch on the rear panel must be in the <i>NET CONTROL</i> position
Enable_Temp_Rpt	If this signal is high, the internal temperature value will update every 2 seconds.
Temp_Format	If this signal is high, the temperature will be displayed in degrees Celsius; if low, degrees Fahrenheit.

QM-AMP3x80 Digital Output Signal Description

OUTPUT	DESCRIPTION
OverRide_F	Goes high whenever the PWR switch on the back of the AMP3x80 is in the <i>BYPASS</i> position.

QM-AMP3x80 Analog Output Signal Descriptions

OUTPUT	DESCRIPTION
Temp(x10)	Reports the temperature inside the AMP3x80 enclosure and updates that value every two seconds as long as Enable_Temp_Rpt is high.

Example Program

An example program for the AMP3x80 is available from the Crestron FTP site (<ftp://ftp.crestron.com/Examples/>). Search for the file named QM-AMP3x80_DEMO.ZIP that contains the example program, associated files and a README.TXT file that describes the program.

Uploading and Upgrading

Assuming a PC is properly connected to the entire system, Crestron programming software allows the programmer to upload programs and projects after their development to the system and network devices. However, there are times when the files for the program and projects are compiled and not uploaded. Instead, compiled files may be distributed from programmers to installers, from Crestron to dealers, etc. Even firmware upgrades are available from the Crestron website as new features are developed after product releases. In those instances, one has the option to upload via the programming software or to upload and upgrade via the Crestron Viewport.

NOTE: The Crestron Viewport is available as a pull-down command from SIMPL Windows and VT Pro-e (**Tools | Viewport**) or as a standalone utility. The Viewport utility accomplishes multiple system tasks, primarily via an RS-232 or TCP/IP connection between the control system and a PC. It is used to observe system processes, upload new operating systems and firmware, change system and network parameters, and communicate with network device consoles and touchpanels, among many other tasks. Viewport can also function as a terminal emulator for generic file transfer. All of these functions are accessed through the commands and options in the Viewport menus. Therefore, for its effectiveness as a support and diagnostic tool, the Crestron Viewport may be preferred over development tools when uploading programs and projects.

The following sections define how one would upload a SIMPL Windows program containing an AMP3x80 to a control system or upgrade the firmware of the AMP3x80. However, before attempting to upload or upgrade, it is necessary to establish communications.

Communication Settings

NOTE: For laptops and other PCs without a built-in RS-232 port, Crestron recommends the use of PCMCIA cards, rather than USB-to-serial adapters. If a USB-to-serial adapter must be used, Crestron has tested the following devices with good results:

Belkin (large model) F5U103
I/O Gear GUC232A
Keyspan USA-19QW (Discontinued)

Results may vary depending on the computer being used. Other models, even from the same manufacturer, may not yield the same results.

The procedure in this section provides details for RS-232 communication between the PC and the control system. If TCP/IP communication is preferred, consult the latest version of the Crestron e-Control Reference Guide (Doc. 6052) or the respective Operations Guide for the control system. These documents are available from the Downloads | Product Manuals section of the Crestron website (www.crestron.com). Refer to the figure on the next page for a typical connection diagram when uploading files

NOTE: When connecting a PC to the QM-RMCRX, use a standard DB9 female-to-female “null modem” cable. To connect to other control systems refer to the Operations Guide included with the control system.

Typical Connection Diagram When Uploading

QM-AMP3x80



↑
Cresnet
↓



QM-RMCRX

← RS-232

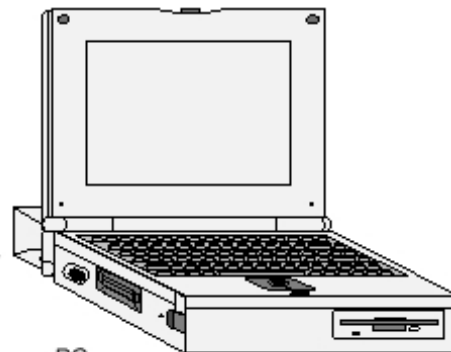

PC

1. Open the Crestron Viewport.
Either launch the stand-alone version of Viewport or start SIMPL Windows and from the menu bar, select **Tools | Viewport**.
2. Refer to the following figure after this step. From the Viewport menu, select **Setup | Communications settings** (alternatively, press **Alt+D**) to open the “Port Settings” window.

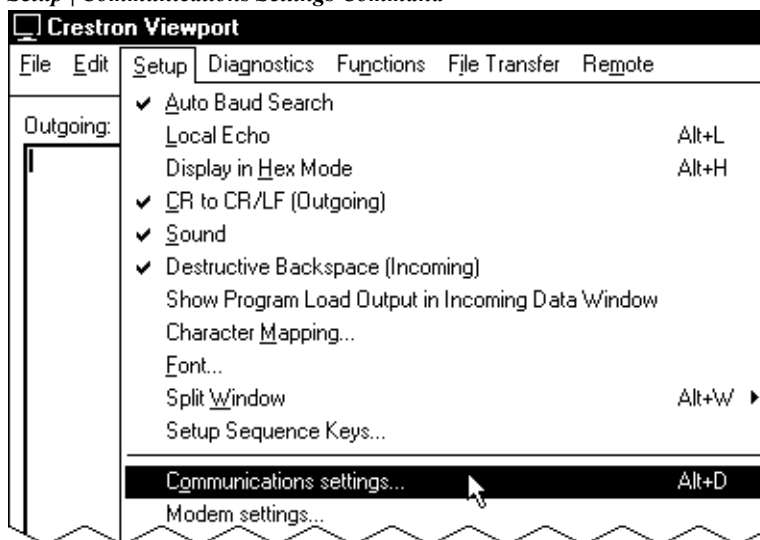
Setup | Communications Settings Command

3. Select **RS-232** as the connection type. Verify that an available COM port (COM 1 is shown after this step) is selected, and that all communication parameters and necessary options from the “Port Settings” window are selected as shown after this step. Click the **OK** button to save the settings and close the window.

“Port Settings” Window

NOTE: The parameters shown in the illustration above are the port settings for a 2-Series control system. Consult the Operations Guide for the control system being used for exact parameter selection.

- To verify communication, select **Diagnostics | Establish Communications (Find Rack)**. This should display a window that gives the COM port and baud rate. If communication cannot be established, refer to the “Troubleshooting Communications” section in the respective Operations Guide for the control system.

Uploading a SIMPL Windows Program

The SIMPL Windows file can be uploaded to the control system using SIMPL Windows or via the Crestron Viewport.

Upload via SIMPL Windows

- Start SIMPL Windows.
- Select **File | Open** to view the “Open” window, navigate to the SIMPL Window file (.smw), and click **Open**.
- Select **Project | Transfer Program**.

Upload via Crestron Viewport

- Verify that the procedure for “Communication Settings” that begins on page 20 has been performed.
- As shown after this step, select **File Transfer | Send Program** (alternatively, press **Alt+P**) from the Viewport menu.

A control system source file has the extension .smw. A compiled SIMPL Windows file has the extension .spz for a 2-Series control system.

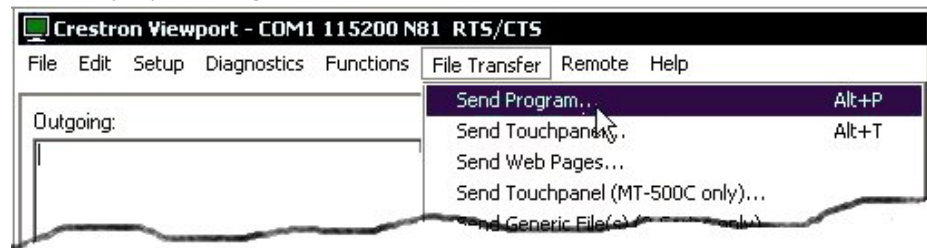
File Transfer | Send Program Command

3. The “Send Program” window appears, as shown after this step. Click **Browse**, locate the compiled file (.spz for PRO2) and click **Open**. This will display the program's header information and enable one or both of the *What to Send* check boxes. If the program does not contain any SIMPL+ modules, only the *SIMPL Program* check box will be enabled. If it does contain SIMPL+ modules, then the *SIMPL+ Program(s)* check box will also be enabled. Select one or both check boxes and then click **Send Program** to begin the transfer.

NOTE: Refer to the respective Operations Guide for the control system for details about the other fields shown on the “Send Program” window.

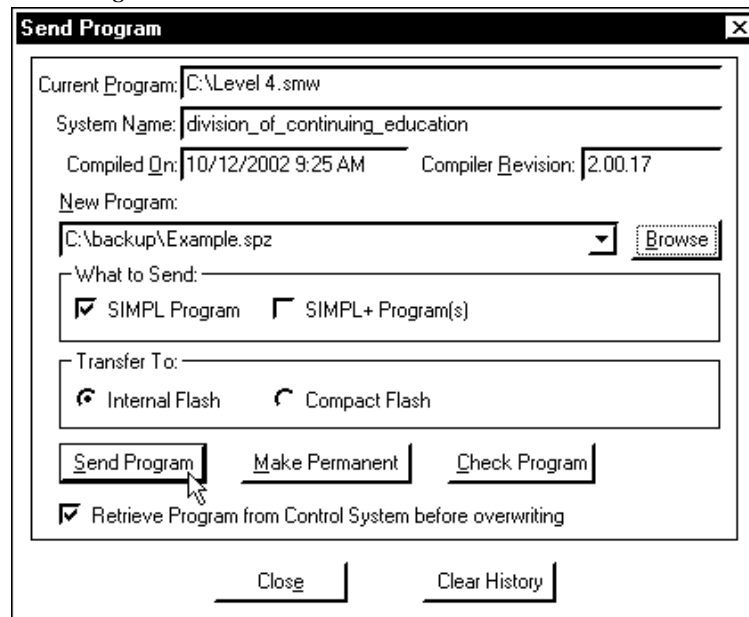
“Send Program” Window

4. To verify that the program has been transferred successfully, select **Diagnostics | Report Program Information**. This should display a window that provides details about the current program loaded into the control system.

A firmware upgrade file has the extension .upg.

Firmware Upgrade

To take advantage of all the AMP3x80 features, it is important that the unit contains the latest firmware available. Therefore, please check the Crestron website (http://www.crestron.com/downloads/software_updates.asp) for the latest version of firmware. Not every product has a firmware upgrade, but as Crestron improves functions, adds new features, and extends the capabilities of its products, firmware upgrades are posted. To upgrade the firmware, complete the following steps.

1. Make sure that “Communication Settings” that begins on page 20 has been performed.
2. As shown after this step, select **File Transfer | Load Network Device** from the Viewport menu.

File Transfer | Load Network Device Command

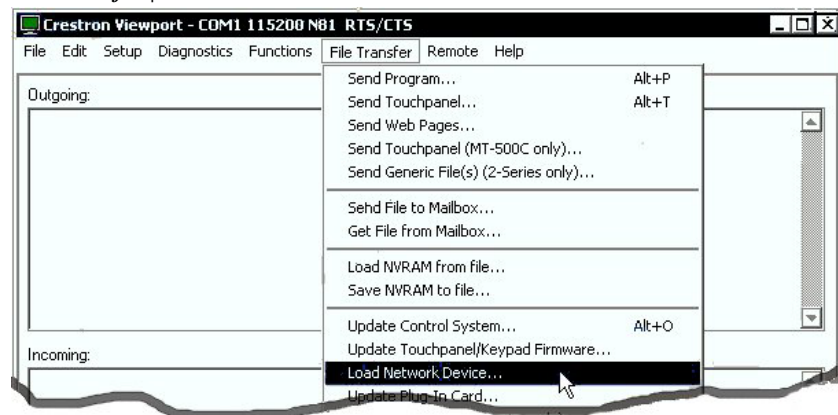

3. As shown after this step, select the Net ID of the AMP3x80 and then click **OK**. The “Open” window appears (refer to the subsequent graphic).

“Select Network ID” Window

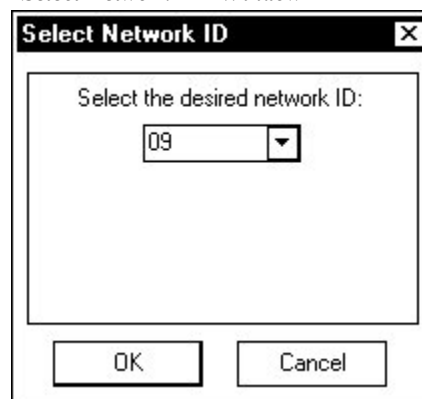

NOTE: When transferring any Cresnet file (touchpanel project/firmware), lower the port speed baud rate to 38400 to match the Cresnet bus speed.

“Open” Window

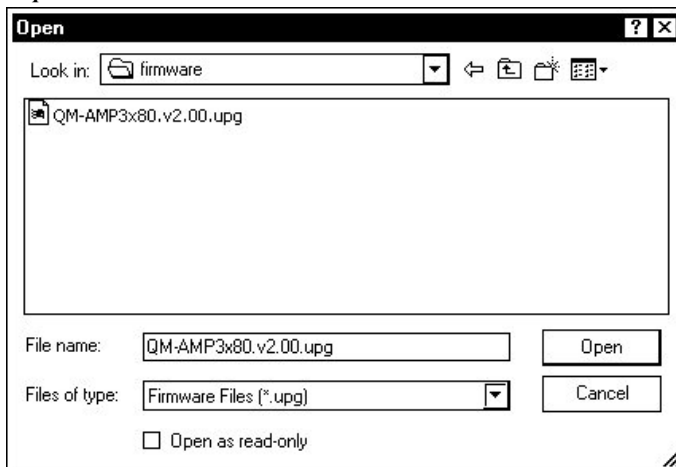

4. Browse to the desired .upg file and click **Open** to begin the transfer.

Problem Solving

Troubleshooting

The following table provides corrective action for possible trouble situations. If further assistance is required, please contact a Crestron customer service representative.

QM-AMP3x80 Troubleshooting

TROUBLE	POSSIBLE CAUSE(S)	CORRECTIVE ACTION
POWER LED does not illuminate.	AMP3x80 is not receiving power.	Verify that the amp is turned on and connected to an AC outlet. Check the fuse.
NET LED does not illuminate.	AMP3x80 Net ID is not correct.	In Viewport, poll the network to verify Net ID.
	AMP3x80 Net ID is not set to match the Net ID specified in SIMPL Windows.	Verify SIMPL Windows program for setting Net ID.
	AMP3x80 is not connected to the network.	Verify network cabling is secure and that the rear panel switch is set to NET CONTROL .
Hum on audio.	Grounding problem.	Connect chassis to ground.
Audio is supplied regardless of programming.	Rear panel switch is set to BYPASS .	Set rear panel switch to NET CONTROL .
Audio is distorted or not present at speakers.	Audio input cable(s) loose or not connected.	Verify that input cables are connected to the appropriate input ports.
	Room speaker wires loose or not connected.	Verify that speaker wires are connected to the appropriate speaker ports.

Further Inquiries

If, after reviewing this Operations Guide for the AMP3x80, you cannot locate specific information or have questions, please take advantage of Crestron's award winning customer service team in your area. Dial one of the following numbers.

- In the US and Canada, call Crestron's corporate headquarters at 1-888-CRESTRON [1-888-273-7876].
- In Europe, call Crestron International at +32-15-50-99-50.
- In Asia, call Crestron Asia at +852-2341-2016.
- In Latin America, call Crestron Latin America at +5255-5093-2160.
- In Australia and New Zealand, call Crestron Pacific at +613-9480-2999.

You can also log onto the online help section of the Crestron website (www.crestron.com) to ask questions about Crestron products. First-time users will need to establish a user account to fully benefit from all available features.

Future Updates

As Crestron improves functions, adds new features, and extends the capabilities of the AMP3x80, additional information may be made available as manual updates. These updates are solely electronic and serve as intermediary supplements prior to the release of a complete technical documentation revision.

Check the Crestron website (www.crestron.com) periodically for manual update availability and its relevance. Updates are available from the Downloads | Product Manuals section and are identified as an “Addendum” in the Download column.

Return and Warranty Policies

Merchandise Returns / Repair Service

1. No merchandise may be returned for credit, exchange, or service without prior authorization from CRESTRON. To obtain warranty service for CRESTRON products, contact the factory and request an RMA (Return Merchandise Authorization) number. Enclose a note specifying the nature of the problem, name and phone number of contact person, RMA number, and return address.
2. Products may be returned for credit, exchange, or service with a CRESTRON Return Merchandise Authorization (RMA) number. Authorized returns must be shipped freight prepaid to CRESTRON, 6 Volvo Drive, Rockleigh, N.J. or its authorized subsidiaries, with RMA number clearly marked on the outside of all cartons. Shipments arriving freight collect or without an RMA number shall be subject to refusal. CRESTRON reserves the right in its sole and absolute discretion to charge a 15% restocking fee, plus shipping costs, on any products returned with an RMA.
3. Return freight charges following repair of items under warranty shall be paid by CRESTRON, shipping by standard ground carrier. In the event repairs are found to be non-warranty, return freight costs shall be paid by the purchaser.

CRESTRON Limited Warranty

CRESTRON ELECTRONICS, Inc. warrants its products to be free from manufacturing defects in materials and workmanship under normal use for a period of three (3) years from the date of purchase from CRESTRON, with the following exceptions: disk drives and any other moving or rotating mechanical parts, pan/tilt heads and power supplies are covered for a period of one (1) year; touchscreen display and overlay components are covered for 90 days; batteries and incandescent lamps are not covered.

This warranty extends to products purchased directly from CRESTRON or an authorized CRESTRON dealer. Purchasers should inquire of the dealer regarding the nature and extent of the dealer's warranty, if any.

CRESTRON shall not be liable to honor the terms of this warranty if the product has been used in any application other than that for which it was intended, or if it has been subjected to misuse, accidental damage, modification, or improper installation procedures. Furthermore, this warranty does not cover any product that has had the serial number altered, defaced, or removed.

This warranty shall be the sole and exclusive remedy to the original purchaser. In no event shall CRESTRON be liable for incidental or consequential damages of any kind (property or economic damages inclusive) arising from the sale or use of this equipment. CRESTRON is not liable for any claim made by a third party or made by the purchaser for a third party.

CRESTRON shall, at its option, repair or replace any product found defective, without charge for parts or labor. Repaired or replaced equipment and parts supplied under this warranty shall be covered only by the unexpired portion of the warranty.

Except as expressly set forth in this warranty, CRESTRON makes no other warranties, expressed or implied, nor authorizes any other party to offer any warranty, including any implied warranties of merchantability or fitness for a particular purpose. Any implied warranties that may be imposed by law are limited to the terms of this limited warranty. This warranty statement supercedes all previous warranties.

Trademark Information

All brand names, product names, and trademarks are the sole property of their respective owners. Windows is a registered trademark of Microsoft Corporation. Windows95/98/Me/XP and WindowsNT/2000 are trademarks of Microsoft Corporation.



Crestron Electronics, Inc.
15 Volvo Drive Rockleigh, NJ 07647
Tel: 888.CRESTRON
Fax: 201.767.7576
www.crestron.com

Operations Guide – DOC. 6272
05.04

Specifications subject to
change without notice.

Free Manuals Download Website

<http://myh66.com>

<http://usermanuals.us>

<http://www.somanuals.com>

<http://www.4manuals.cc>

<http://www.manual-lib.com>

<http://www.404manual.com>

<http://www.luxmanual.com>

<http://aubethermostatmanual.com>

Golf course search by state

<http://golfingnear.com>

Email search by domain

<http://emailbydomain.com>

Auto manuals search

<http://auto.somanuals.com>

TV manuals search

<http://tv.somanuals.com>