

Crestron **C2N-TFM** FM Radio Tuner

Operations Guide



This document was prepared and written by the Technical Documentation department at:



Crestron Electronics, Inc.
15 Volvo Drive
Rockleigh, NJ 07647
1-888-CRESTRON

All brand names, product names, and trademarks are the property of their respective owners.
©2004 Crestron Electronics, Inc.

Contents

FM Radio Tuner: C2N-TFM	1
Introduction	1
Features and Functions.....	1
Specifications	2
Physical Description.....	3
Industry Compliance	7
Setup.....	8
Network Wiring.....	8
Identity Code	9
Hardware Hookup	12
FM Tuner Example Program	12
Preparation	13
Running the FM Tuner Example Program	13
Programming Software.....	15
Earliest Version Software Requirements for the PC	16
Programming with Crestron SystemBuilder.....	16
Programming with SIMPL Windows	16
Uploading and Upgrading	33
Communication Settings	34
Uploading a SIMPL Windows Program	36
Firmware Upgrade – FM Tuner	37
Firmware Upgrade – AMWX Tuner	38
Problem Solving	40
Troubleshooting	40
Further Inquiries.....	40
Future Updates	40
Appendix: RDS/RBDS Function Support	41
Return and Warranty Policies.....	43
Merchandise Returns / Repair Service	43
CRESTRON Limited Warranty	43

FM Radio Tuner: C2N-TFM

Introduction

Features and Functions

The Crestron® C2N-TFM is a Crestron-controlled FM Radio tuner (FM Tuner) designed to work stand-alone or with the companion AM/Weather band tuner, the C2N-TAMWX (AM/WX Tuner). The FM Tuner adds high-quality FM radio programming to your whole-house audio distribution system.

The FM Tuner is designed to work in a Crestron control system (Cresnet® system). You can use any Crestron multi-mode touchpanel to search through the stations and control tuner functions. The built-in RDS/RBDS feature permits display of digital data, such as program type, clock time, traffic announcements, etc., that may be transmitted along with regular FM programming. (Refer to “RDS/RBDS Feature” on page 2.) User-programmable presets let you quickly select your favorite station. Audio output from the FM Tuner can be routed to a local amplifier or to a surround sound decoder such as the C2N-DAP8 or C2N-DAP8RC. Output can also be routed to a CNX-BIPAD8 for distribution to other rooms via CAT5 cabling. (Refer also to the configuration diagram on page 12.)

Functional Summary

- Headphone connector for local monitoring of audio output
- Up to twenty presets for fast program selection
- RDS/RBDS feature for display of program types, traffic announcements, GMT-based clock time and more
- Two RCA connectors for line-level FM stereo output
- RJ-45 connector provides link (up to 500 feet) to C2N-TAMWX AM/Weather band tuner
- Integrated configuration lets local FM Tuner buttons control AM/WX Tuner

RDS/RBDS Feature

The Radio Data System (RDS), a European standard, and Radio Broadcast Data System (RBDS), a North American standard, permit broadcasters to use a sub-carrier frequency to transmit inaudible digital data along with their regular FM programming to receivers equipped to process the data.

The FM Tuner circuitry is compatible with the RDS/RBDS standards; the example program discussed later in this guide provides some typical applications of this feature, such as the display of program type name, UTC (universal time clock) data, program name and category, and traffic information. A typical benefit of this feature is the ability to search for stations based on program type.

Refer to “Appendix: RDS/RBDS Function Support” on page 41 for more information.

Mute and Mono Functions

The FM Tuner incorporates automatic as well as manual selection of mute and mono mode functions.

- The tuner can be put into mono/stereo mode or mute mode via the touchpanel.
- The tuner cannot be put into mono/stereo mode or mute mode via the tuner controls.
- After tuning to a station, the tuner will automatically switch to mono mode if the signal level is low and mono mode is off.
- The tuner automatically mutes the output during rapid scan functions.
- After tuning to a station, the radio will automatically mute if the signal level is too low and the radio-forced mono mode is off.
- The auto mute/mute feature can be disabled via the touchpanel.

Specifications

The following table summarizes the specifications for the C2N-TFM tuner.

Specifications of the C2N-TFM

SPECIFICATION	DETAILS
Power Requirements	
FM Tuner only	8.0 Watts (0.3 Amp @ 24 VDC)
FM Tuner plus AM/WX Tuner	16.0 Watts (0.66 Amp @ 24 VDC)
Default Net ID	56
Control System Update Files ^{1, 2, 3}	
2-Series Control System	Version 3.038.CUZ or later
CNMSX-AV/PRO	Version 5.12.63X.UPZ or later
CNRACKX-DP	Version 5.12.63W.UPZ or later
CEN/CN-TVAV	Version 5.12.63V.UPZ or later
C2N-TFM Firmware	C2N-TFM.1.12.upg or later
Audio Output	
AUDIO OUT L, R	Two RCA connectors for line level stereo audio
Frequency Range	87.5 MHz to 108 MHz
Sensitivity (Usable sensitivity mono/stereo)	11 dBf / 60 dBf
Maximum Signal	100 dBf

(continued on next page)

Specifications of the C2N-TFM (continued)

SPECIFICATION	DETAILS
S/N Ratio @ 65 dBf, mono/stereo	72 dB / 67 dB
IF Rejection	100 dB
AM Rejection	55 dB
Stereo Separation	40 dB
Audio output level @ 1 kHz _{RMS}	1V _{RMS}
Output impedance	<100 ohms single-ended
Recommended load impedance	>1K Ohm
Ports/Connectors	
AM RADIO	RJ-45 for link (up to 500 feet) to AM/Weather band tuner
FM ANT	F-Type coaxial connector for FM antenna input
NET	One 4-pin mini-terminal block connector for Cresnet® interface (24, Y, Z, G)
Environmental temperature	41° to 122°F (5° to 50°C)
Humidity	10% to 90% RH (non-condensing)
Dimensions	Height: 1.80 in (4.57 cm) Width: 7.07 in (17.96 cm) Depth: 6.88 in (17.48 cm)
Weight	1.86 lb (0.837 kg)

- 1 The latest versions can be obtained from the Downloads | Software Updates section of the Crestron website (www.crestron.com). Refer to NOTE below.
- 2 Crestron 2-Series control systems include the AV2 and PRO2. Consult the latest Crestron Product Catalog for a complete list of 2-Series control systems.
- 3 Filenames for CNX and ST-CP update files have a UPZ extension. Files on the website may be .zip or self-extracting .exe files containing the .cuz or .upz file. All can be obtained from the Downloads section of the Crestron website. To avoid program problems, make sure you are using the update file with the correct suffix letter (e.g., S, V, W, X)

NOTE: Crestron software and any files on the website are for Authorized Crestron dealers and Crestron Authorized Independent Programmers (CAIP) only. New users may be required to register to obtain access to certain areas of the site (including the FTP site).

Physical Description

The C2N-TFM is housed in a black enclosure with labeling on the front and rear panels. The front of the unit includes ten LEDs that indicate the unit’s status, and all local controls. All connections, except for headphones, are made on the back of the unit. Four rubber feet on the bottom of the unit provide stability and prevent slippage. Refer to the figures below and on the following page.

C2N-TFM Physical Views





C2N-TFM Overall Dimensions

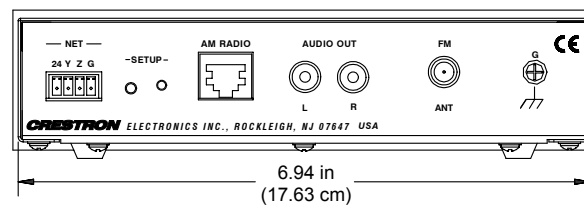
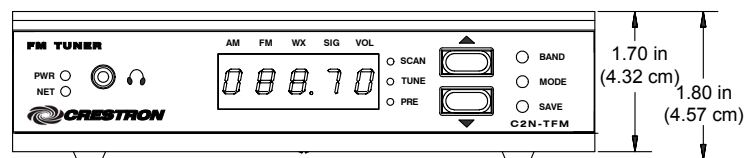
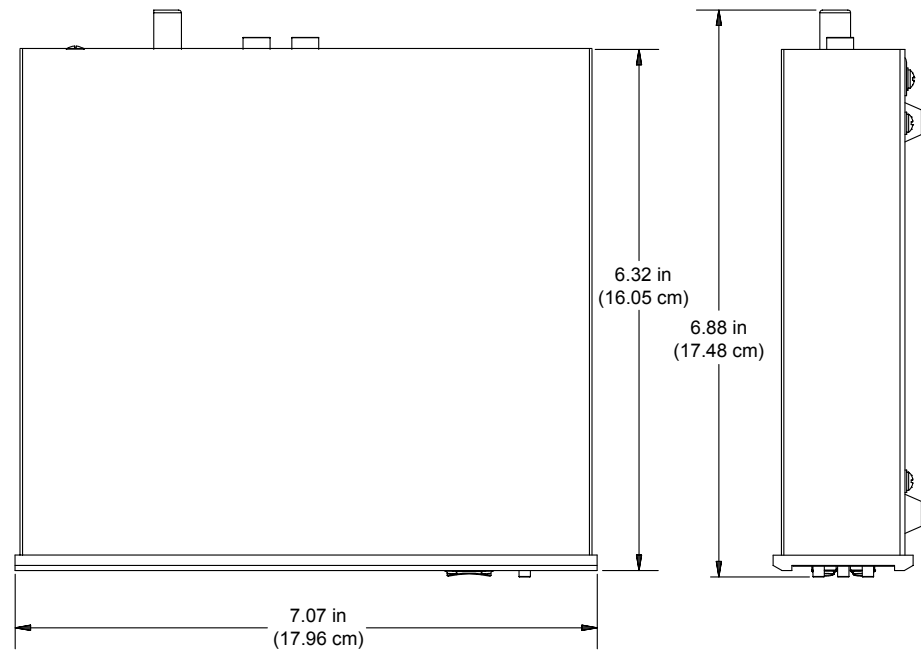

C2N-TFM Ports

All connections to the C2N-TFM, except headphones, are made through the ports on the rear panel. Refer to the illustrations and descriptions, which follow.

C2N-TFM Ports

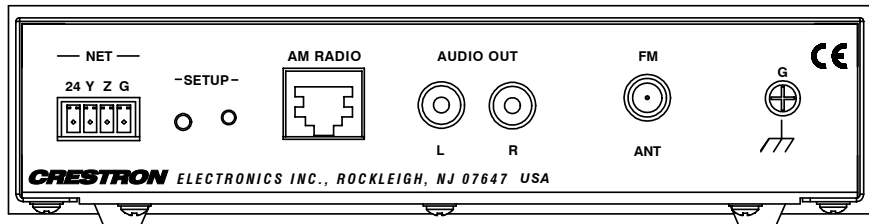

NET

This 4-pin mini-terminal block connector is used to connect the C2N-TFM module to the Cresnet system. Data and power for the C2N-TFM are provided via the connection. Refer to “Network Wiring” on page 8.

AM RADIO (RJ-45)

The RJ-45 **AM RADIO** port provides CAT5 interface (up to 500 feet) to the companion Crestron C2N-TAMWX AM/Weather Tuner. Wiring for the connector is shown in the following diagrams.

PIN #	SIGNAL
1	+24V
2	+24V
3	COM+
4	Audio+
5	Audio-
6	COM-
7	Ground
8	Ground

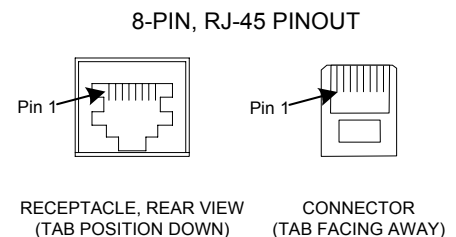

NOTE: This connector is to be used only to provide interface to Crestron products specifically designed to work with this unit. It cannot be used for connections to Cresnet or Crestron audio distribution devices.

AUDIO OUT L, R

These two RCA connectors provide line level stereo output for local amplifiers.

FM ANT

This Type F coaxial connector is for an FM antenna cable (not supplied).

G (Chassis Ground)

Use this chassis screw to ground the unit to the amplifier and audio source common grounds.

🎧 (Headphone)

The only connection on the front panel of the FM Tuner is the mini-phone jack, which permits the use of headphones to monitor the audio signal (mono only). The volume mode, selected by the MODE switch, allows adjustment of the volume to the headphones only. Note that plugging in headphones does not interrupt the unit's other audio output.

Front Panel Controls and Indicators

Ten LED indicators, a five-digit display, and three pushbutton switches are located on the front panel of the C2N-TFM. Refer to the illustration and descriptions that follow.

C2N-TFM Front Panel Controls and Indicators

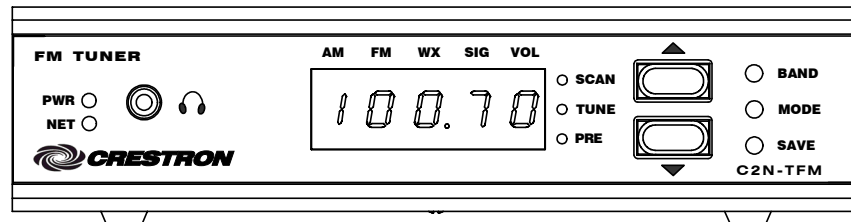

PWR (Power)

This green LED illuminates when power is supplied to the C2N-TFM.

NET

This yellow LED illuminates when communication between the control system and the C2N-TFM is established (the unit is polled on the network). Illumination indicates that the program currently loaded has a network device defined at the same ID as the C2N-TFM. The LED flashes or remains on when communication with the processor occurs.

BAND Switch

Use the **BAND** switch to select between the AM, FM and WX (weather) bands. The corresponding red LEDs (**AM**, **FM**, **WX**) illuminate as each band is selected, and the five-digit display shows the appropriate values. If the AM/WX Tuner is not included in your configuration, the AM and WX modes cannot be selected.

MODE Switch, ▲▼ (Up/Down) Buttons, and Display

Use the **MODE** switch to select between the signal, volume, preset, tune, and scan modes. The corresponding red LEDs (**SIG**, **VOL**, **PRE**, **TUNE**, and **SCAN**) illuminate as each mode is selected. In each mode, the five-digit display shows the appropriate values.

In the signal mode, the display shows a letter (d = distance mode; L = local mode) and the corresponding relative signal strength (01 through 99). The FM Tuner defaults to distance mode; when the FM signal level is too high, the program automatically switches to local mode and the signal is attenuated by 10 dB.

In the volume mode, the up/down buttons select ten volume levels (0 through 9) for the signal (mono) supplied to the headphone jack.

In the preset mode, the up/down buttons let you sequence through the preset numbers (1-20) to select a station or to save a new station in a preset location.

In the tune mode, the up/down buttons let you sequence through the band frequencies in 100 kHz increments (50 kHz increments when Europe mode is enabled).

In the scan mode, the up/down buttons initiate the scan and direction of the search for the next station with a signal strong enough for good reception. Pressing either button will halt the scan.

SAVE Button

Use the **SAVE** button to save a station frequency in a preset location. To save a preset, select the desired station, use the **MODE** switch to select the preset mode, use the up/down buttons to select the preset location, and then press **SAVE**. The display will briefly show “SAVE” as the preset is saved.

SETUP LED and Pushbutton

The C2N-TFM is Touch Settable ID (TSID) ready. The **SETUP** pushbutton and its associated LED are located on the rear panel and are used for setup of the unit’s network ID during the initial configuration of a Cresnet system or when the device is being added/replaced. Refer to “Method B (Touch Settable IDs)” on page 10 for detailed information.

Industry Compliance

As of the date of manufacture, the C2N-TFM has been tested and found to comply with specifications for CE marking and standards per EMC and Radiocommunications Compliance Labelling.



NOTE: This device complies with part 15 of the FCC rules. Operation is subject to the following two conditions: (1) these devices may not cause harmful interference, and (2) these devices must accept any interference received, including interference that may cause undesired operation.

Setup

Network Wiring

CAUTION: Use only Crestron power supplies for Crestron equipment. Failure to do so could cause equipment damage or void the Crestron warranty.

CAUTION: Provide sufficient power to the system. Insufficient power can lead to unpredictable results or damage to the equipment. Please use the Crestron Power Calculator to help calculate how much power is needed for the system.

http://www.crestron.com/dealer-tech_resources/power_calculator.asp

NOTE: When installing network wiring, refer to the latest revision of the wiring diagram(s) appropriate for your specific system configuration, available from the Downloads | Product Manuals | Wiring Diagrams section of the Crestron website (www.crestron.com).

When calculating the wire gauge for a particular Cresnet run, the length of the run and the power factor of each network unit to be connected must be taken into consideration. If Cresnet units are to be daisy-chained on the run, the power factor of each unit to be daisy-chained must be added together to determine the power factor of the entire chain. If the unit is a home-run from a Crestron system power supply network port, the power factor of that unit is the power factor of the entire run. The length of the run in feet and the power factor of the run should be used in the resistance equation below to calculate the value on the right side of the equation.

Resistance Equation

$$R < \frac{40,000}{L \times PF}$$

Where: R = Resistance (refer to table below).
 L = Length of run (or chain) in feet.
 PF = Power factor of entire run (or chain).

The required wire gauge should be chosen such that the resistance value is less than the value calculated in the resistance equation. Refer to the following table.

Wire Gauge Values

RESISTANCE	WIRE GAUGE
4	16
6	18
10	20
15	22
13	Doubled CAT5
8.7	Tripled CAT5

NOTE: All Cresnet wiring must consist of two twisted pairs. One twisted pair is the +24V conductor and the GND conductor, and the other twisted pair is the Y conductor and the Z conductor.

NOTE: When daisy-chaining Cresnet units, strip the ends of the wires carefully to avoid nicking the conductors. Twist together the ends of the wires that share a pin on the network connector, and tin the twisted connection. Apply solder only to the ends of the twisted wires. Avoid tinning too far up the wires or the end becomes brittle. Insert the tinned connection into the Cresnet connector and tighten the retaining screw. Repeat the procedure for the other three conductors.

Identity Code

Every equipment and user interface within the network requires a unique identity code (Net ID). These codes are two-digit hexadecimal numbers from 03 to FE. The Net ID of each unit must match an ID code specified in the SIMPL Windows program. Refer to “Setting the Net ID in Device Settings” on page 18 for details of the SIMPL Windows procedure.

Refer to the note on page 33 for a definition of Viewport.

The Net ID of the C2N-TFM has been factory set to **56**. The Net IDs of multiple C2N-TFMs in the same system must be unique. Net IDs are changed from a personal computer (PC) via the Crestron Viewport.

NOTE: For detailed information on establishing communication between the PC and control system, refer to “Communication Settings” on page 34. If communication cannot be established, refer to the “Troubleshooting Communications” section in the respective Operations Guide for the control system.

There are two different methods—Method A or Method B—for setting the C2N-TFM Net IDs:

Method A (Cresnet address-settable ID), described below, applies to C2N-TFMs in a Cresnet system with a CNX control system or with a 2-Series control system upgrade file (CUZ) version prior to 3.008, but can be used with later versions of firmware and requires that a single unit be the only network device connected to the control system.

Method B (Touch Settable IDs), which begins on the next page, applies to C2N-TFMs in a Cresnet system with 2-Series control system upgrade file (CUZ) version 3.029 or later. These upgrades enable Touch Settable ID (TSID) functionality, which makes it possible for the control system to recognize a network device via its serial number, which is stored in the device’s memory. This method does not require that any devices be disconnected from the network; Net IDs may be set with the entire Cresnet system intact. This method requires the use of the Crestron Viewport version 3.35 or later.

Use the appropriate method to set the C2N-TFM Net ID.

Method A (Cresnet address-settable ID)

1. Ensure that the C2N-TFM is the only device connected to the control system.
2. Open the Crestron Viewport.
3. From the Viewport menu, select **Functions | Set Network ID**. The software checks the baud rate and then opens the "Set Network ID" window.
4. In the "Set Network ID" window, select the C2N-TFM from the *Current Network Devices* text window.
5. Select the new Net ID for the C2N-TFM from the *Choose the new network ID for the selected device (Hex):* text box.
6. Click **Set ID** to initiate the change. This will display the "ID command has been sent" window.
7. In the "Command Complete" window, click **OK**.
8. In the *Current Network Devices* text window, verify the new Net ID code.

- In the "Set Network ID" window, click **Close**.

NOTE: The new Net ID code may also be verified by selecting **Diagnostic | Report Network Devices** in the Viewport (alternately, select **F4**).

- Repeat this procedure for each C2N-TFM to be added to the system.

Method B (Touch Settable IDs)

Before using this method, you should have a list of all current network devices and their Net IDs, to avoid assigning duplicate IDs.

Set Net ID by TSID

These procedures are for TSID-enabled network devices during the initial configuration of a Cresnet system or when such devices are being added/replaced.

- Ensure that all C2N-TFMs are connected to the control system.
- Open the Crestron Viewport version 3.35 or later.
- From the Viewport menu, select **Functions | Assign Cresnet ID by Serial Number**. The "Set Net ID by TSID" window appears. The window is first displayed with the data fields empty. (Refer to the following figure.)

"Set Net ID by TSID" Window

- Click on the **Search for Touch Settable Devices** button. The system searches the network and lists all TSID-enabled devices found. The list is similar to the report produced by pressing **F4** (Report Network Devices); the first eight digits of each line constitute the TSID number (hexadecimal form of the serial number).

5. As you enter either the serial number or TSID number of the device that requires a change, the corresponding TSID or serial number automatically appears in its appropriate field, and the list scrolls to and highlights the device listing. The listing should show the device's current Cresnet ID.
6. Enter the Cresnet ID that the device should be set to and click **OK**. The number you enter should appear on the list.

CAUTION: This function does not prevent you from setting duplicate IDs. Be sure to check current assignments before entering the desired Cresnet ID number.

Serial Number to TSID Conversion

This utility is useful in a case where there are multiple devices of the same type on a network, you need to locate a particular one, you know the TSID but not the serial number, and your site installation list is based on device serial numbers. In this (or the reverse) situation, do the following:

1. Open the Crestron Viewport.
2. From the Viewport menu, select **Functions | Serial Number ↔ TSID Conversion Tool**. The “Serial Number ↔TSID Conversion Tool” window is displayed. (Refer to the following figure.)

“Serial Number to TSID Conversion Tool” Window

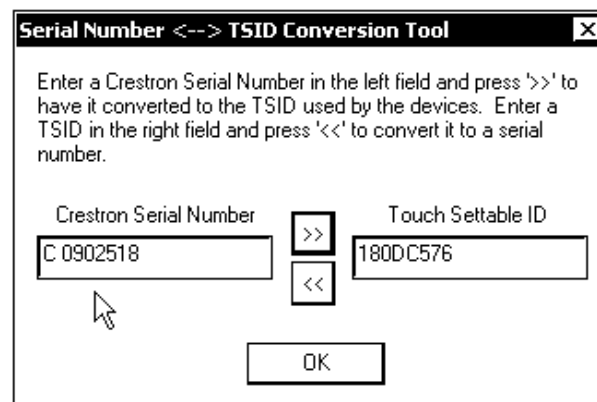

3. Enter the serial number or TSID number as instructed; press the appropriate button to obtain the corresponding number.

NOTE: Enter serial numbers, including spaces, exactly as they appear on the unit label. Alpha characters in serial numbers or TSID numbers may be entered in upper or lower case.

Hardware Hookup

Refer to the hookup diagram below. Complete the connections in any order. The subsequent graphic is a typical configuration diagram for the FM Tuner plus the AM/WX Tuner. (The TV audio and video portion of this configuration applies only to the Crestron television and FM radio tuner, C2N-TTVFM.)

Cresnet System Hookup Connections for C2N-TFM

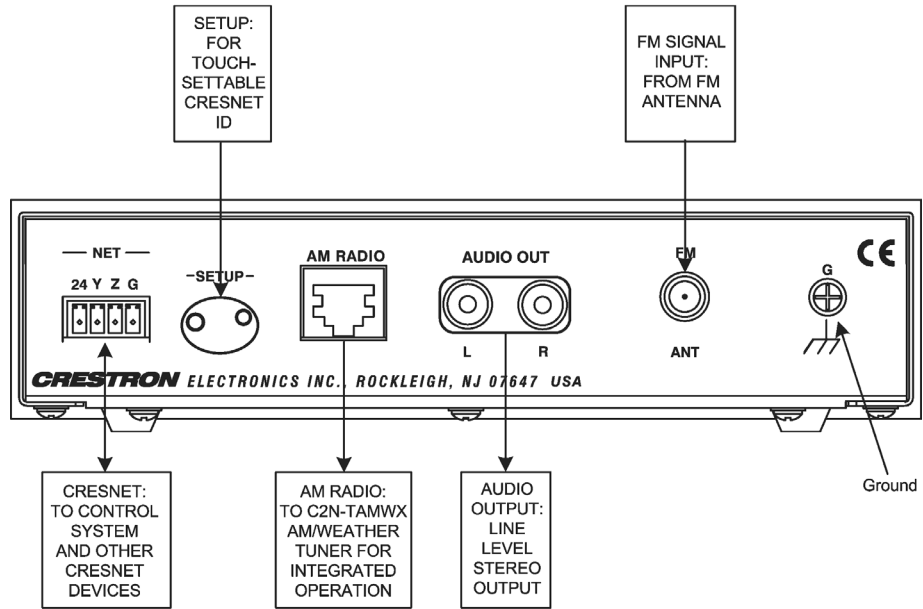

Typical Configuration Diagram for C2N-TFM

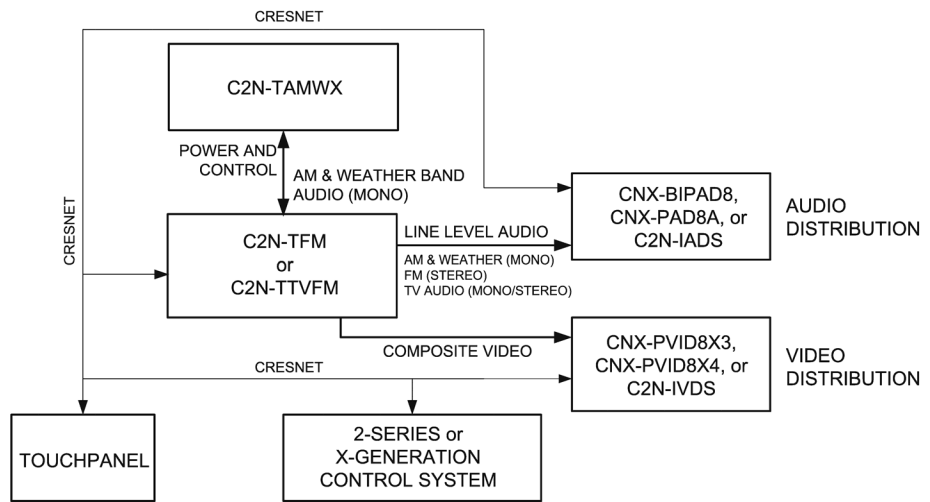

FM Tuner Example Program

The example program for the FM Tuner demonstrates the various features of the unit. The program also serves as a model for those individuals who wish to develop a customized program using Crestron's programming software.

The FM Tuner program supplied for the FM Tuner is designed to operate on a Crestron TPS-4500 touchpanel (requires firmware version 2.000 or later). If your

Cresnet system uses a different model touchpanel, you may wish to recompile the project for that touchpanel.

Preparation

In preparation for running the FM Tuner example program, do the following:

1. Complete the procedures detailed in “Setup,” which begins on page 8.
2. Verify that communication setup procedures described in “Communication Settings” on page 34 have been completed.
3. After downloading the Example Program from the Crestron website, www.crestron.com/exampleprograms, (search for C2N-TFM.Basic Example.zip), use the instructions given in “Upload via Crestron Viewport” on page 36, to load the .spz program to the control system and the .vtz program to the touchpanel.

Running the FM Tuner Example Program

Once the programs are loaded to the touchpanel and the control system, the main screen appears on the touchpanel, as shown in the following illustration.

NOTE: The example program described below is preliminary and included to illustrate the level of functionality available with this product. This information will be replaced as soon as the final version of the program becomes available.

FM Tuner Example Program Main Screen

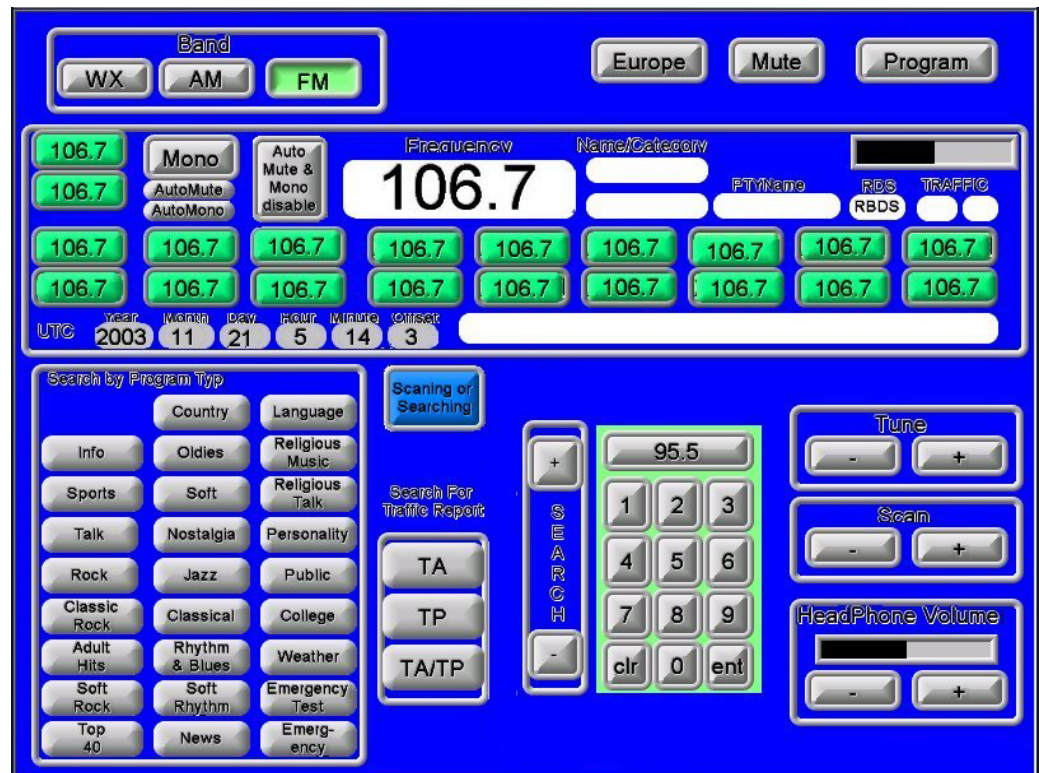

The buttons at the top of the screen select the FM Tuner’s general functions: Band buttons – **FM**, **AM**, or **WX** (weather) choose the desired tuning band; the **Europe**

button changes the frequency scan and step rate from 100 kHz to 50 kHz (the 50 kHz rate is needed in European radios); the **Mute** button which mutes/unmutes the audio output to the speakers and the headphones; and the **Program** button which enables/disables programming of station presets on the touchpanel.

The middle section of the screen includes twenty preset buttons that can be programmed to permit easy selection of favorite stations. It also includes the **Auto Mono** and **Auto Mute** indicators; the **Mono** and the **Auto Mute & Mono Disable** buttons, the selected **Frequency** display, and a graphic signal strength indicator. This section also provides displays of RBDS/RDS data for **Name/Category**, **PTY Name**, **RDS** type, **Traffic** information types, **UTC Clock** for GMT date and time display, and a single-line window that displays up to 64 alphanumeric characters of station/program/artist information.

The lower portion of the screen contains twenty-six **Search By Type** buttons and three **Search For Traffic Report** buttons (**TA**, **TP**, **TA/TP**), both search operations made possible by the RDS/RBDS circuits. Also included in this section are the +/- **SEARCH** buttons, a **Scanning/Searching** indicator, a frequency selection keypad, +/- **Tune** buttons, +/- **Scan** buttons, and +/- **Headphone** buttons along with a graphic display to show the relative volume level.

RDS/RBDS Features

The RDS/RBDS data features included in the example program are just some of the functions that can be utilized. Refer to “Appendix: RDS/RBDS Function Support” on page 41 for more information.

Presets

The presets feature allows you to specify up to twenty FM stations that you wish to select quickly. Initially, each one is set to 106.7.

To set up the presets, press **Program**, tune in a station, and press one of the preset buttons to save that station frequency in that preset location.

Mute

Use this button to mute/unmute the audio signal to the headphones as well as to the AUDIO OUTPUT connectors.

Mono Mode and Mono Status/Mute Status Functions

The **Mono** button lets you select mono mode in those instances where the station signal is low and the stereo quality is poor. The FM Tuner automatically selects a mute mode or mono mode if the signal level is low and the mono mode is off. The **Auto Mute & Mono disable** button lets you override the FM Tuner’s automatic mute and mono mode functions.

Tuning/Search Functions

The example program enables several types of station selection operations.

- You can enter a specific station number using the keypad in the bottom section of the screen. Select the station number and press **ent** to enter the selection. Your selections appear in the blue **Frequency** display as you enter them. Press **clr** to clear your selection if you make a mistake.
- Use the Tune +/- buttons to select frequencies in 100 kHz steps (50 kHz in Europe mode).

- Search for stations that broadcast particular program types using the Search by Program Type buttons.
- Search for stations that broadcast traffic information using the Search For Traffic Report buttons. The **TA** button searches for stations that broadcast special traffic announcements, the **TP** button searches for stations that regularly broadcast traffic information during the day, and the **TA/TP** button searches for stations currently broadcasting traffic reports.
- Search for the next station with a signal strong enough for good reception using the SEARCH +/- buttons.
- Scan (slow scan) all stations until you find a program you wish to select, using the Scan +/- buttons. In this type of search, the unit scans to the next viable station, pauses for about five seconds so you can determine if you wish to select the station, then scans to the next station, and so on. Scanning will continue until you press either button or until the beginning station is reached.
- The **Scanning or Searching** indicator alerts you to scan or search functions, but does not indicate actual tuning functions via the keypad or the Tune buttons.

Programming Software

Have a question or comment about Crestron software?

Answers to frequently asked questions (FAQs) can be viewed in the Online Help section of the Crestron website (www.crestron.com). To post your own question or view questions you have submitted to Crestron's True Blue Support, log in at <http://support.crestron.com/>. First-time users will need to establish a user account.

Setup is easy thanks to Crestron's Windows®-based programming software. The Crestron SystemBuilder™ creates a complete project, with no special programming required. Crestron SystemBuilder completes all necessary programming for a base system including all touchpanel screens and the control system program. Once Crestron SystemBuilder creates the project, the system interfaces and program logic can be customized. It can easily be modified with Crestron development tools (i.e., SIMPL Windows and Crestron VisionTools® Pro-e (VT Pro-e) software packages).

The program output of Crestron SystemBuilder is a SIMPL Windows program with much of the functionality encapsulated in macros. Therefore, extending the capabilities of the system is very easy. Crestron SystemBuilder and SIMPL Windows are intended for users with different levels of programming knowledge. Crestron SystemBuilder is easier to use for the beginning programmer, and much faster for all programmers. However, it does not allow the degree of control and flexibility that SIMPL Windows does. Of course, one can initiate programming using the easiest method (Crestron SystemBuilder) and use advanced techniques that are available from SIMPL Windows to customize the job.

Crestron SystemBuilder comes with templates for all supported interfaces. If a user wishes to create a touchpanel project using templates with a different look-and-feel, this can be accomplished by making a custom template. This custom template can then be used by Crestron SystemBuilder to create the final project files to be loaded into the panels. Alternatively, VT Pro-e can be used to tweak projects created with the Crestron SystemBuilder or develop original touchpanel screen designs.

Earliest Version Software Requirements for the PC

NOTE: Crestron recommends that you use the latest software to take advantage of the most recently released features. The latest software is available from the Downloads | Software Updates section of the Crestron website (www.crestron.com).

The following are recommended software version requirements for the PC:

- (Optional) Crestron SystemBuilder version 1.02 or later. Requires SIMPL Windows.
SIMPL Windows version 2.05.16 or later.
Requires SIMPL+ Cross Compiler version 1.1.
- Crestron Database version 16.1.0 or later. Required by SIMPL Windows.
- Crestron Viewport version 3.99.01 or later.

Programming with Crestron SystemBuilder

Crestron SystemBuilder offers automatic programming for such residential and commercial applications as audio distribution, home theater, and video conferencing. The interface of this tool guides you through a few basic steps for designating rooms and specifying the control system, touchpanels, devices, and functionality. Crestron SystemBuilder then programs the system, including all touchpanel projects and control system logic.

Crestron SystemBuilder is fully integrated with Crestron's suite of software development tools, including SIMPL Windows, VT Pro-e, and the Crestron Database. Crestron SystemBuilder accesses these tools behind the scenes, enabling you to easily create robust systems.

Programming with SIMPL Windows

NOTE: The following are acceptable file extensions for programs that include a C2N-TFM, developed for specific control system types:

.smw	<i>projectname</i> .smw (source file)
.spz	<i>projectname</i> .spz (compiled file for 2-series)
.bin	<i>projectname</i> .bin (compiled file for CNX generation)
.csz	<i>projectname</i> .csz (compiled file for CNX generation with SIMPL+)
.ush	<i>projectname</i> .ush (compiled file for CNX generation with SIMPL+ header file)
.usp	<i>projectname</i> .usp (source code module for SIMPL+)

SIMPL Windows is Crestron's software for programming Crestron control systems. It provides a well-designed graphical environment with a number of workspaces (i.e., windows) in which a programmer can select, configure, program, test, and monitor a Crestron control system. SIMPL Windows offers drag and drop functionality in a familiar Windows® environment.

NOTE: The following descriptions assume that the reader has knowledge of SIMPL Windows. If not, refer to the extensive help information provided with the software.

NOTE: In the following description, the PRO2 control system is used.

The easiest method of programming, but does not offer as much flexibility as SIMPL Windows.

This section describes a sample SIMPL Windows program that includes a C2N-TFM.

Configuration Manager is where programmers “build” a Crestron control system by selecting hardware from the *Device Library*. In Configuration Manager, drag the PRO2 from the Control Systems folder of the *Device Library* and drop it in the upper pane of the *System Views*. The PRO2 with its associated communication ports is displayed in the *System Views* upper pane.

PRO2 System View

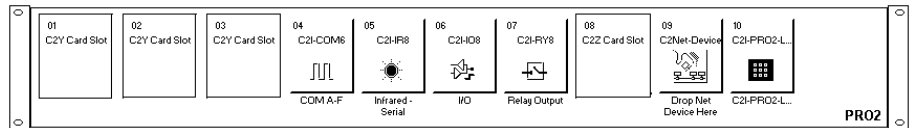

The *System Views* lower pane displays the PRO2 system tree (refer to the following graphic). This tree can be expanded to display and configure the communications ports.

Expanded PRO2 System Tree

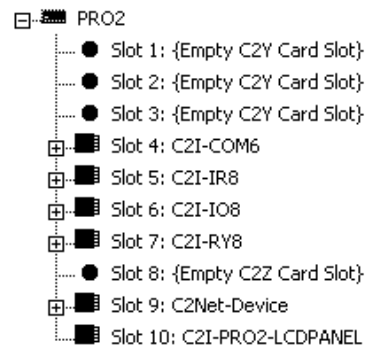

C2Net Device Slot in Configuration Manager

To incorporate a C2N-TFM into the system, drag the C2N-TFM from the Cresnet Control Modules | Cresnet Audio Modules folder of the *Device Library* and drop it in *System Views*. The PRO2 system tree displays the C2N-TFM in Slot 9, with a default Net ID of 56 as shown in the following illustration.

NOTE: For convenience, the C2N-TFM symbol includes an AM Tuner Controls slot for integrated configurations. If your system does not include the AM/WX Tuner, simply ignore the AM Tuner Controls inputs and outputs in your program.

NOTE: The first C2N-TFM in a system is preset with a Net ID of 56 when its symbol is dragged into the upper pane of *System Views*. Additional units are assigned different Net ID numbers as they are added.

C2Net Device, Slot 9

- [-] PRO2
 - Slot 1: {Empty C2Y Card Slot}
 - Slot 2: {Empty C2Y Card Slot}
 - Slot 3: {Empty C2Y Card Slot}
 - [+] Slot 4: C2I-COM6
 - Slot 5: C2I-IR8
 - [+] Slot 6: C2I-IO8
 - [+] Slot 7: C2I-RY8
 - Slot 8: {Empty C2Z Card Slot}
 - [-] Slot 9: C2Net-Device
 - [+] ID 56 : C2N-TFM w/C2N-TAMWX
 - Slot 1: FM Tuner Controls
 - Slot 2: FM Tuner RDS Information
 - Slot 3: AM Tuner Controls
 - Slot 10: C2I-PRO2-LCDPANEL

Setting the Net ID in Device Settings

Double-click the C2N-TFM icon to open the “Device Settings” window. This window displays the C2N-TFM device information. If necessary, select the *Net ID* tab to change the C2N-TFM Net ID, as shown in the following figure.

C2N-TFM “Device Settings” Window

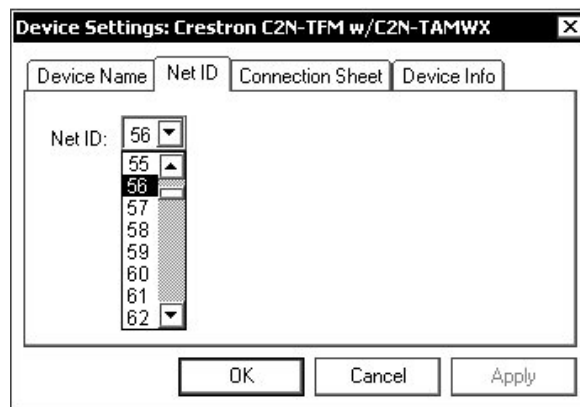

NOTE: SIMPL Windows automatically changes Net ID values of a device added to a program if a duplicate device or a device with the same default Net ID already exists in the program. Always ensure that the hardware and software settings of the Net ID match. For Net ID hardware setting details, refer to “Identity Code” on page 9.

C2N-TFM Symbol in Programming Manager

Programming Manager is where programmers “program” a Crestron control system by assigning signals to symbols. Due to the extensive functionality of the unit, a single C2N-TFM symbol in SIMPL Windows would be too complex. Instead, the C2N-TFM functions are divided into three sub-slots: Slot 01 – FM Tuner Controls; Slot 02 – FM Tuner RDS Information; and Slot 03 – AM Tuner Controls. In Program Manager, expand the C2N-TFM to view the individual sub-slots; then drag the desired symbols to *Detail View*. The C2N-TFM sub-slots and corresponding symbols are described in the following paragraphs. Because the FM tuner controls and the AM tuner controls symbols are also complex, each is illustrated and described in two parts: digital inputs and outputs and analog inputs and outputs. Tables defining the input and output signals follow each section.

C2N-TFM Sub-Slot 01: FM Tuner Controls Digital Input and Output Signals

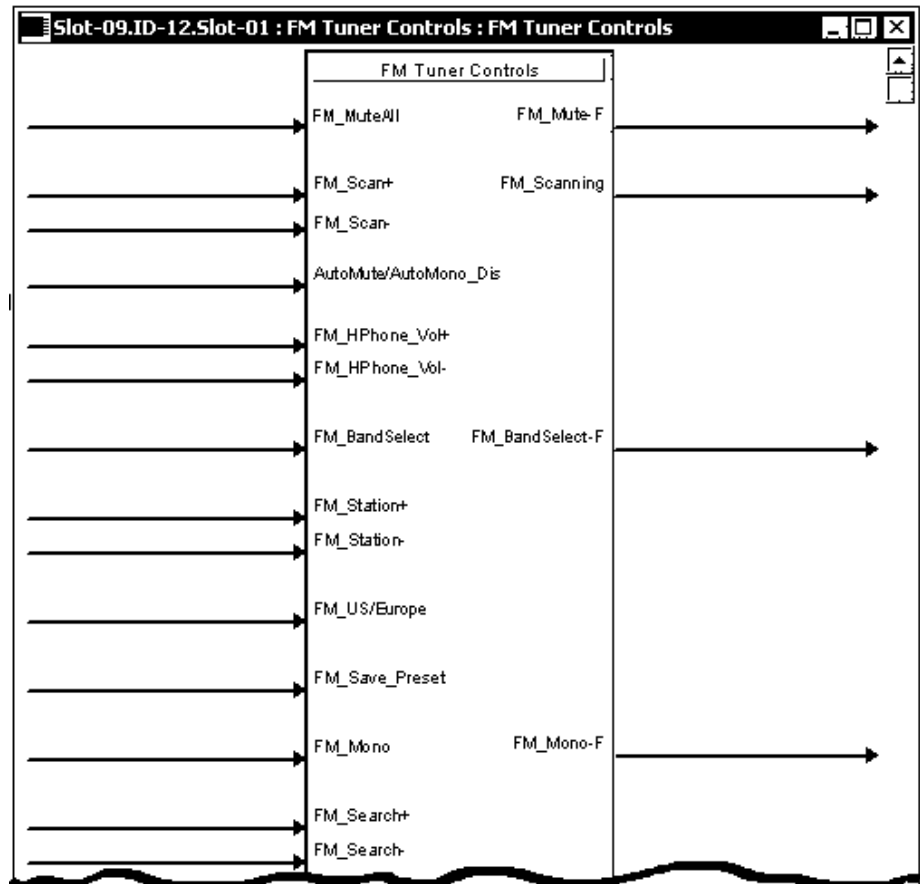

C2N-TFM Digital Input and Output Signal Descriptions

SIGNAL TYPE AND NAME	DESCRIPTION
Input: <FM_MuteAll>	Mute toggle. Mutes the speaker and headphone audio for as long as the input is high. Un-mutes the audio when the input goes low. High/1 = Mute FM audio; Low/0 = Un-mute FM audio
Output: <FM_Mute-F>	Indicates that FM audio is muted. The output will be high for as long as the audio remains muted. Audio will mute whenever: 1) the <MuteAll> input is high; or 2) auto-mute is turned on and the signal strength is too weak; or 3) when the FM antenna is removed. The auto-mute feature is turned on and off via the <AutoMute/AutoMono_Dis> input described later. High/1 = FM audio muted; Low/0 = FM audio not muted

(continued on next page)

C2N-TFM Digital Input and Output Signal Descriptions (continued)

SIGNAL TYPE AND NAME	DESCRIPTION
Inputs: <FM_Scan+>, <FM_Scan->	<p>Scans through FM stations on the rising edge of the input.</p> <p>Users can scan for stations by pressing the local up (▲) and down (▼) buttons on the C2N-TFM when the unit is in SCAN mode; or from remote buttons defined on a touchpanel or other interface.</p> <p>The tuner will scan up (+) or down (-) to a station, pause for five seconds, and then continue scanning to the next station. Pressing the local or remote scan button again will stop the scan operation.</p> <p>The scan operation also stops when:</p> <ol style="list-style-type: none"> 1) the local BAND or MODE buttons are pressed; or 2) a remote band or search button is pressed; or 3) when it wraps around to the original station, if that station is scannable; or 4) if the original station is not scannable, after a maximum of repeat counts. <p>High/1 (rising edge) = Scan up or down; Low/0 = No effect</p>
Output: <FM_Scanning>	<p>Indicates that the tuner is busy scanning. The output will be high for as long as the tuner remains scanning.</p> <p>High/1 = Scanning; Low/0 = Not scanning</p>
Input: <AutoMute/AutoMono_Dis>	<p>Disables the auto-mute and auto-mono features in the FM tuner when the input is high. When low, the auto features are enabled.</p> <p>Auto mode automatically sets the tuner to mono as the signal strength weakens, and mutes the audio when the signal strength is weak.</p> <p>High/1 = Disable auto-mute and auto-mono mode; Low/0 = Enable auto-mute and auto-mono mode</p>
Inputs: <FM_Hphone_Vol+>, <FM_Hphone_Vol->	<p>Increases (+) and decreases (-) the headphone volume on the rising edge of the signal.</p> <p>Users can control the headphone volume by pressing the local up (▲) and down (▼) buttons on the C2N-TFM when the unit is in VOL mode, or from remote buttons defined on a touchpanel or other interface.</p> <p>If the input is high for longer than 300 milliseconds, the volume will continue to increase or decrease until:</p> <ol style="list-style-type: none"> 1) the input goes low (the local or remote volume button is released); or 2) after maximum "repeats". <p>High/1 = Raise/lower volume (volume button pressed); Low/0 = volume button released</p>

(continued on next page)

C2N-TFM Digital Input and Output Signal Descriptions (continued)

SIGNAL TYPE AND NAME	DESCRIPTION
Input: <FM_BandSelect>	<p>Selects the FM band for as long as the input is high.</p> <p>Users can select the band by pressing the local BAND button on the C2N-TFM; or from a remote button defined on a touchpanel or other interface.</p> <p>This signal is interlocked with the AM and WX band selection inputs. That is, only one band can be selected at a time. The band will be set to whichever <bandselect> input goes high last.</p> <p>If the AM/WX tuner is not used, this signal can be left undefined.</p> <p>High/1 = Select FM band; Low/0 = Exit FM band</p>
Output: <FM_BandSelect-F>	<p>Indicates that the FM band has been selected via the local BAND button on the C2N-TFM.</p> <p>If the band is changed from a remote button, the feedback will not be returned on this signal.</p> <p>High/1 = FM band selected via local BAND button; Low/0 = FM band not selected via local BAND button</p>
Inputs: <FM_Station+>, <FM_Station->	<p>Tunes the FM station up (+) or down (-) on the rising edge of the signal.</p> <p>Users can tune to stations by pressing the local up (▲) and down (▼) buttons on the C2N-TFM when the unit is in TUNE mode; or from remote buttons defined on a touchpanel or other interface.</p> <p>If the input is high for longer than 300 milliseconds, the tuner will continue to tune from station to station until:</p> <ol style="list-style-type: none"> 1) the input goes low (the local or remote button is released); or 2) it wraps around to the original station; or 3) after maximum repeats. <p>The tuner will jump in 100 kHz steps if in US mode; or in 50 kHz steps if in European mode. The step rate is selected via the <FM_US/Europe> input.</p> <p>High/1 = Change station (tune button pressed); Low/0 = Stop station changing (tune button released)</p>
Input: <FM_US/Europe>	<p>Selects the FM frequency step rate.</p> <p>When low, the frequency is set to US steps (100 kHz).</p> <p>When high, the frequency is set to European steps (50 kHz).</p> <p>The tuner stores the frequency selection in the EEPROM. On power-up, it restores this value.</p> <p>High/1 = European mode; Low/0 = US mode</p>

(continued on next page)

C2N-TFM Digital Input and Output Signal Descriptions (continued)

SIGNAL TYPE AND NAME	DESCRIPTION
Input: <FM_Save_Preset>	<p>Saves the current station to the preset given by the <FM Presets> analog.</p> <p>Users can save a preset by pressing the local Save button on the C2N-TFM when the tuner is in PRE mode; or from remote buttons defined on a touchpanel or other interface.</p> <p>High/1 (rising edge) = Save preset; Low/0 = No effect</p>
Input: <FM_Mono>	<p>Sets the tuner to mono when high. When low, the tuner operates in stereo.</p> <p>High/1 = Set tuner to mono; Low/0 = Set tuner to stereo</p>
Output: <FM_Mono-F>	<p>Indicates that the tuner is in the mono state. When low, indicates that the tuner is operating in stereo.</p> <p>The tuner will go into the mono state whenever:</p> <ol style="list-style-type: none"> 1) the <FM_Mono> input is high; or 2) auto-mono is turned on and the signal strength is weak. <p>High/1 = In mono mode; Low/0 = In stereo</p>
Inputs: <FM_Search+>, <FM_Search->	<p>Searches in the up (+) or down (-) direction for FM stations, for as long as the signal is high.</p> <p>Users can search for stations by pressing remote search buttons defined on a touchpanel or other interface. (The C2N-TFM does not provide local search buttons.)</p> <p>The Search function will continue until:</p> <ol style="list-style-type: none"> 1) the remote search button is released; or 2) it wraps around to the original station, if that station is searchable; or 3) if the original station is not searchable, after maximum repeats. <p>High/1 = Search up or down (search button pressed); Low/0 = Stop search (search button released)</p>

C2N-TFM Sub-Slot 01: FM Tuner Controls Analog Input and Output Signals

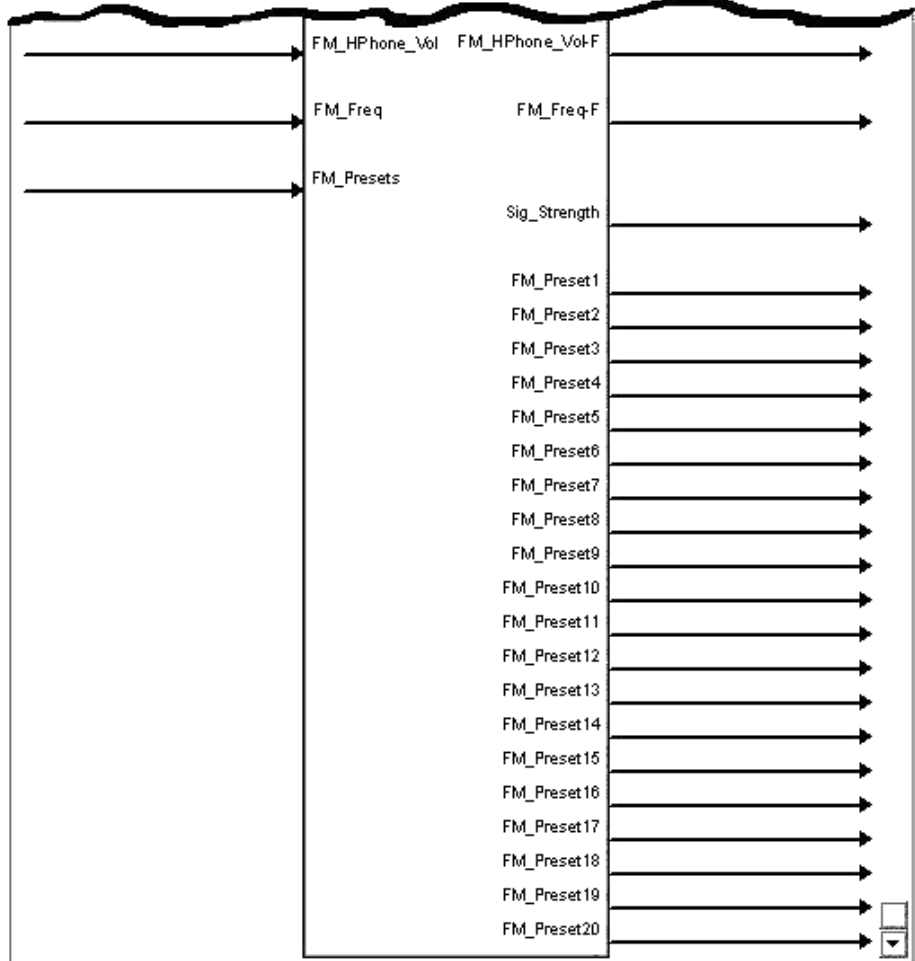

C2N-TFM FM Tuner Controls Analog Input and Output Signal Descriptions

SIGNAL TYPE AND NAME	DESCRIPTION
Input: <FM_Hphone_Volume>	Sets the headphone volume level from 0% to 100%.
Output: <FM_Hphone_Volume-F>	Indicates the current headphone volume level.
Input: <FM_Freq>	Sets the tuner to the indicated FM frequency. In US mode, valid analog values range from 8800d (for 88.00MHz) to 10800d (for 108.00MHz). In European mode, valid analog values range from 8750d (for 87.50MHz) to 10800d (for 108.00MHz). Values above and below the maximum and minimum values will hold at the min/max frequencies.
Output: < FM_Freq-F>	Indicates the current station frequency.

(continued on next page)

C2N-TFM FM Tuner Controls Analog Input and Output Signal Descriptions (continued)

SIGNAL TYPE AND NAME	DESCRIPTION
Input: <FM Presets>	Selects a station preset to Play or Save. When the <FM_Save_Preset> input is high, the tuner saves the selected preset. When <FM_Save_Preset> is low, the tuner plays the selected preset. Valid analog values range from 0d (for Preset 1) to 19d (for Preset 20). No other values are valid.
Output: <Sig_Strength>	Indicates the FM signal strength. The analog values will range from 0 (for no signal) to 65535 (maximum signal strength).
Outputs: <FM_Preset1> through <FM_Preset20>	Indicates the frequency of the corresponding preset. For example, if Preset 4 is FM station 88.3, then <FM_Preset4> will equal 8830d. The analog values will differ depending on whether the tuner is set to US or European mode (refer to the <FM_Freq> input described earlier).

C2N-TFM Slot 02, FM Tuner RDS Information Input and Output Signals

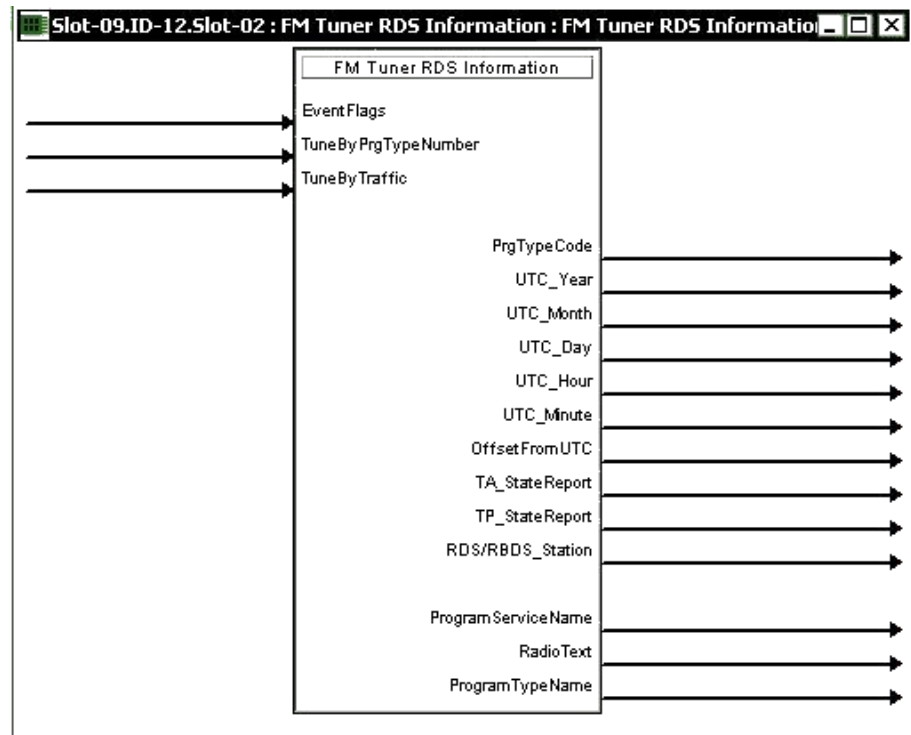

C2N-TFM FM Tuner RDS Information Input and Output Signal Descriptions

SIGNAL TYPE AND NAME	DESCRIPTION
Analog input: <EventFlags>	<p>Each FM RDS/RBDS report code can be enabled or disabled by setting the individual bits to high (enable) or low (disable).</p> <p>Bit0 = PI Code report - not supported Bit1 = PTY (Program Type) Code report - enabled by default Bit2 = PS (Program Service) Code report code - enabled by default Bit3 = Extended Country Code report - not supported Bit4 = Language Code report - not supported Bit5 = Emergency Channel Code report - not supported Bit6 = Clock Year Code report - enabled by default Bit7 = Clock Month Code report - enabled by default Bit8 = Clock Day Code report - enabled by default Bit9 = Clock Hour Code report - enabled by default Bit10 = Clock Minute Code report - enabled by default Bit11 = Clock Offset Code report - enabled by default Bit12 = Radio Text report - enabled by default Bit13 = PTYN (Program Type Name) Text report - enabled by default Bit14 = TA (Traffic Announcement) Code report - enabled by default Bit15 = TP (Traffic Program) code report - enabled by default</p>
Analog input: <TuneByPrgTypeNumber>	<p>Selects a PTN code (program type number) to search. There are 31 different program categories available for selection. The categories differ depending on whether the tuner is in US or European mode.</p> <p>Valid values range from 1 to 31. Refer to the table at the end of this topic for a table of codes and their corresponding categories.</p> <p>Setting this analog value to a valid PTN initiates the search. The search operation stops when:</p> <ol style="list-style-type: none"> 1) a station is found with the given category; or 2) the Tune, Scan, TA/TP Search, or Band mode buttons are pressed; or 3) the maximum loop counter has been reached. <p>Sending a new analog value will cancel the current search and initiate a new search.</p>

(continued on next page)

*C2N-TFM FM Tuner RDS Information Input and Output Signal Descriptions
(continued)*

SIGNAL TYPE AND NAME	DESCRIPTION
Analog input: <TuneByTraffic>	Selects a traffic report station to search. Valid analog values are as follows: 1 = TA (Traffic Announcement) - searches for stations that broadcast special traffic announcements. 2 = TP (Traffic Program) - searches for stations that regularly broadcast traffic information during the day. 3 = TA/TP (combination) - searches for stations currently broadcasting traffic announcements. Setting this analog to a valid traffic report value initiates the search. The search operation stops when: 1) a station is found with the given TA/TP flag; or 2) the Tuner, Scan, PTY Search, or Band mode buttons are pressed; or 3) the maximum loop counter has been reached. Sending a new analog value will cancel the current search and initiate a new search.
Analog input: <TuneByPrgTypeNumber>	Selects a PTN code (program type number) to search. There are 31 different program categories available for selection. The categories differ depending on whether the tuner is in US or European mode. Valid values range from 1 to 31. Refer to the table at the end of this topic for a table of codes and their corresponding categories. Setting this analog value to a valid PTN initiates the search. The search operation stops when: 1) a station is found with the given category; or 2) the Tune, Scan, TA/TP Search, or Band mode buttons are pressed; or 3) the maximum loop counter has been reached. Sending a new analog value will cancel the current search and initiate a new search.
Analog output: <PrgTypeCode>	Reports the PTN code of the current station. The analog values will range from 1 to 31. The program type name and additional information are reported as serial strings via <ProgramTypeName> .
Analog output: <UTC_Year>	Some stations that support RDS/RBDS transmit UTC (universal time clock) information. This analog reports the UTC year. For example, the year 2004 will report as 2004d.

(continued on next page)

*C2N-TFM FM Tuner RDS Information Input and Output Signal Descriptions
(continued)*

SIGNAL TYPE AND NAME	DESCRIPTION
Analog output: <UTC_Month>	Reports the UTC month of the year. The analog value will range from 1d (for January) to 12d (for December).
Analog output: <UTC_Day>	Reports the UTC day of the month. The analog value will range from 1d to 31d.
Analog output: <UTC_Hour>	Reports the UTC hour of the day. The analog value will range from 0d, for 12:00 A.M. (midnight) to 23d.
Analog output: <UTC_Minute>	Reports the UTC minute. The analog value will range from 0d to 59d.
Analog output: <OffsetFromUTC>	Reports the time offset from UTC. The time offset is added or subtracted from the UTC and is measured in multiples of half-hours, which map to a range from -127 to +127. For example, -1d equals "minus 30 minutes"; +1d equals "plus 30 minutes."
Analog output: <TA_StateReport>	Reports whether the current station broadcasts special traffic announcements. The analog value will equal 1 if True, or 0 if False.
Analog output: <TP_StateReport>	Reports whether the current station regularly broadcasts traffic information throughout the day. The analog value will equal 1 if True, or 0 if False.
Analog output: <RDS/RBDS_Station>	Reports whether the current station supports RDS/RBDS, as follows: 0 = No RDS or RBDS 1 = RBDS 2 = RDS
Serial output: <ProgramServiceName>	Reports the program service name (PS) string for the current station. Typically, these are the call letters of the station, e.g., WBGO. The maximum string length is eight characters.
Serial output: <RadioText>	Reports the radio text (RT) string for the current station. This can include radio information such as phone numbers, artist names, song titles, or station names. The maximum string length is either 32 (RBDS) or 64 (RDS) characters.
Serial output: <ProgramTypeName>	Reports the program type name (PTYN) string for the current station, with additional information. There are 31 program types, including jazz, classical, nostalgic, etc. For example, a SPORT program type may send the text "Football" in this field. The maximum string length is eight characters.

C2N-TFM Slot 03, AM Tuner Controls Digital Input and Output Signals

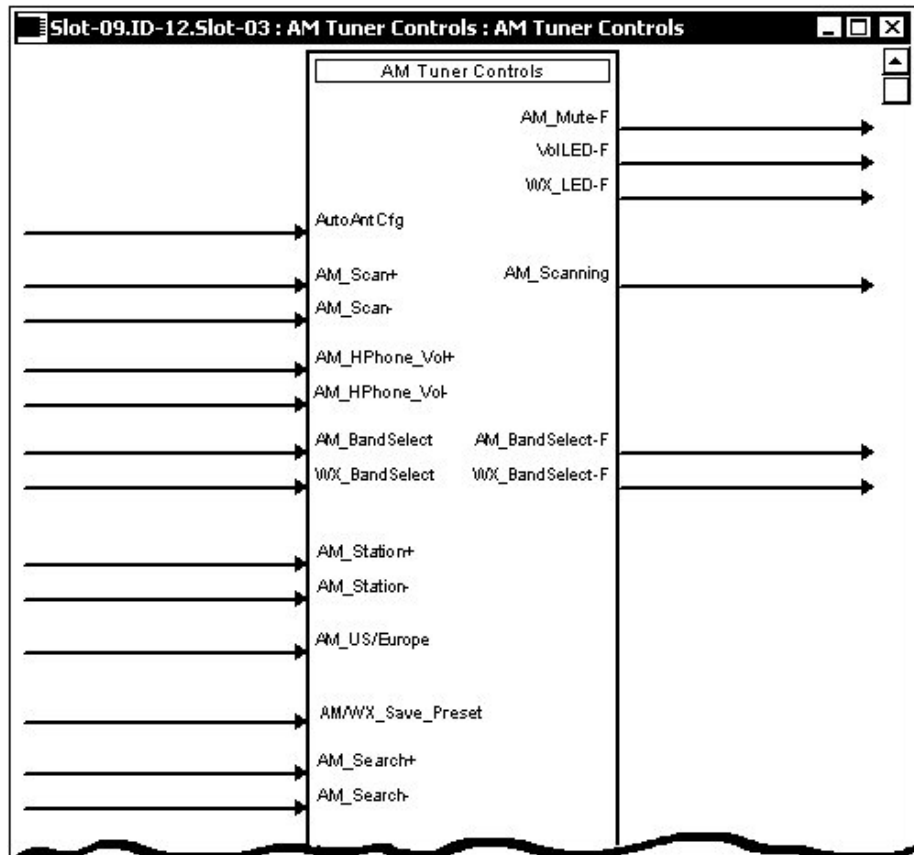

C2N-TFM AM Tuner Controls Digital Input and Output Signal Descriptions

SIGNAL TYPE AND NAME	DESCRIPTION
Output: <AM_Mute-F>	Indicates that AM speaker and headphone audio is muted. The output will be high for as long as the audio remains muted. Audio will mute whenever: 1) the <FM_MuteAll> input is high; or 2) the signal level is less than the <SquelchLevel>. High/1 = AM audio muted; Low/0 = AM audio not muted.
Output: <VoLED-F>	Indicates the state of the VOL LED on the C2N-TAMWX. This LED is active when the C2N-TAMWX is in headphone volume mode. High/1 = Active (VOL LED on); Low/0 = Not active (VOL LED off).

(continued on next page)

*C2N-TFM AM Tuner Controls Digital Input and Output Signal Descriptions
(continued)*

SIGNAL TYPE AND NAME	DESCRIPTION
Output: <WX_LED-F>	<p>Indicates the state of the WX LED on the C2N-TAMWX. This LED is active when the C2N-TAMWX is set to the weather band.</p> <p>High/1 = Active (WX LED on); Low/0 = Not active (WX LED off)</p>
Inputs: <AutoAntCfg>	<p>Sets the AM tuner to auto-configure mode when the input is high.</p> <p>In this mode, the tuner will automatically configure the internal A and B loop antennas and select the A or B loop depending on which signal is stronger.</p> <p>High/1 = Automatic antenna configuration; Low/0 = Manual antenna configuration</p>
Inputs: <AM_Scan+>, <AM_Scan->	<p>Scans through each AM station on the rising edge of the input. The scan function only applies to the AM band; it is not supported in the weather band.</p> <p>Users can scan for AM stations by pressing the Up and Down buttons on the C2N-TFM when the unit is in SCAN mode; or from remote buttons defined on a touchpanel or other interface. (The C2N-TAMWX does not provide Scan buttons.)</p> <p>The tuner will scan up (+) or down (-) to an AM station, pause for five seconds, and then continue scanning to the next station. Pressing the scan button again stops the Scan operation.</p> <p>The Scan operation also stops when it wraps around to the original station.</p> <p>High/1 (rising edge) = Scan up or down (AM only); Low/0 = No effect</p>
Output: <AM_Scanning>	<p>Indicates that the AM tuner is busy scanning AM Stations. The output will be high for as long as the tuner remains scanning.</p> <p>High/1 = Scanning; Low/0 = Not scanning</p>
Inputs: <AM_HPhone_Vol+>, <AM_HPhone_Vol->	<p>Increases (+) and decreases (-) the headphone volume for as long as the input remains high.</p> <p>Users control headphone volume by pressing the Up and Down buttons on the C2N-TAMWX when the unit is in VOL mode; or from remote buttons defined on a touchpanel or other interface.</p> <p>High/1 = Raise/lower volume (Volume button pressed); Low/0 = Volume button released</p>

(continued on next page)

*C2N-TFM AM Tuner Controls Digital Input and Output Signal Descriptions
(continued)*

SIGNAL TYPE AND NAME	DESCRIPTION
Input: <AM_BandSelect>	<p>Sets the C2N-TAMWX to the AM band for as long as the input is high.</p> <p>Users can select the band by pressing the local BAND button on the C2N-TAMWX or C2N-TFM; or from remote buttons defined on a touchpanel or other interface.</p> <p>This input is interlocked with the FM and WX band selection inputs. That is, only one band can be selected at a time. The band will be set to whichever <bandselect> input goes high last.</p> <p>High/1 = Set to AM band; Low/0 = Exit AM band</p>
Output: <AM_BandSelect-F>	<p>Indicates that the AM band has been selected via the BAND button on the C2N-TAMWX or C2N-TFM.</p> <p>If the band is changed from a remote button, the feedback will not be returned on this signal.</p> <p>High/1 = AM band selected via local BAND button; Low/0 = AM band not selected via local BAND button</p>
Input: <WX_BandSelect>	<p>Sets the C2N-TAMWX to the weather band for as long as the input is high.</p> <p>Users can select the band by pressing the local BAND button on the C2N-TAMWX or C2N-TFM; or from remote buttons defined on a touchpanel or other interface.</p> <p>This input is interlocked with the AM and FM band selection inputs. That is, only one band can be selected at a time. The band will be set to whichever <bandselect> input goes high last.</p> <p>High/1 = Set to WX band; Low/0 = Exit WX band</p>
Output: <WX_BandSelect-F>	<p>Indicates that the weather band has been selected via the BAND button on the C2N-TAMWX or C2N-TFM.</p> <p>If the band is changed from a remote button, the feedback will not be returned on this signal.</p> <p>High/1 = WX band selected via local BAND button; Low/0 = WX band not selected via local BAND button</p>

(continued on next page)

*C2N-TFM AM Tuner Controls Digital Input and Output Signal Descriptions
(continued)*

SIGNAL TYPE AND NAME	DESCRIPTION
Inputs: <AM_Station+>, <AM_Station->	<p>Tunes the AM or weather station up (+) or down (-), for as long as the input is high.</p> <p>Users can tune to stations by pressing the up (▲) or down (▼) buttons on the AM/WX Tuner or the FM Tuner when the unit is in TUNE mode; or by using remote buttons defined on a touchpanel or other interface.</p> <p>The Station+/- function will continue until the input goes low (the local or remote tune button is released).</p> <p>The tuner will jump in 10 kHz steps if in US mode; or in 9 kHz steps if in European mode. The step rate is selected via the <AM_US/Europe> input.</p> <p>High/1 = Station up or down (tune button pressed); Low/0 = Stop station changing (tune button released)</p>
Input: <AM_US/Europe>	<p>Selects the AM frequency step rate. When low, the frequency is set to US steps (10 kHz). When high, the frequency is set to European steps (9 kHz).</p> <p>The tuner stores the frequency selection in the EEPROM. On power-up, it restores this value.</p> <p>High/1 = European mode; Low/0 = US mode</p>
Input: <AM/WX_Save_Preset>	<p>Saves the current station to the preset given by the <AM_Presets> or <WX_Presets> analogs.</p> <p>Users can save a preset by pressing the SAVE button on the FM Tuner when the unit is in Preset mode; or from remote buttons defined on a touchpanel or other interface. (The AM/WX Tuner does not provide a local Save button.)</p> <p>High/1 (rising edge) = Save preset; Low/0 = No effect</p>
Inputs: <AM_Search+>, <AM_Search->	<p>Searches in the up (+) or down (-) direction for AM stations, for as long as the input remains high. The search function only applies to the AM band; it is not supported in the weather band.</p> <p>Users can search for AM stations by pressing remote buttons defined on a touchpanel or other interface. (Neither the AM/WX Tuner nor the FM Tuner provide AM search buttons.)</p> <p>The Search function will continue until</p> <ol style="list-style-type: none"> 1) the remote search button is released; or 2) it wraps around to the original station. <p>High/1 = Search up or down (remote search button pressed, AM band only); Low/0 = Stop search (remote search button released)</p>

C2N-TFM Slot 03, AM Tuner Controls Analog Input and Output Signals

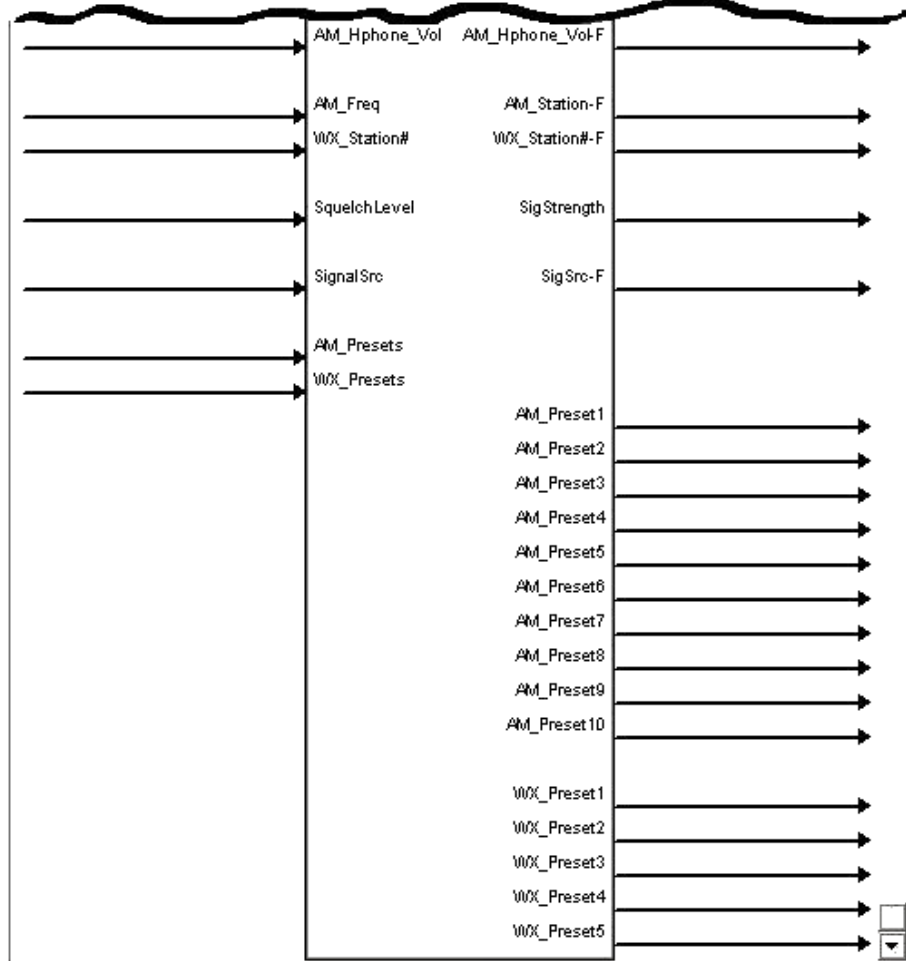

C2N-TFM AM Tuner Controls Analog Input and Output Signal Descriptions

SIGNAL NAME	DESCRIPTION
Input: <AM_Hphone_Vol>	Sets the headphone volume level from 0% to 100%.
Output: <AM_Hphone_Vol-F>	Indicates the current headphone volume.
Input: <AM_Freq>	Sets the tuner to the indicated AM frequency. In both US and European modes, valid analog values range from 5300d (for 530 kHz) to 17100d (for 1710 kHz). Values above and below the maximum and minimum values will hold at the min/max frequencies.
Output: <AM_Station-F>	Indicates the current AM station frequency.
Input: <WX_Station#>	Sets the tuner to the indicated weather station number. Valid analog values range from 1 to 7. No other values are valid.
Output: <WX_Station#-F>	Indicates the current weather station number. The analog values will range from 1 to 7.

(continued on next page)

*C2N-TFM AM Tuner Controls Analog Input and Output Signal Descriptions
(continued)*

SIGNAL NAME	DESCRIPTION
Input: <SquelchLevel>	Sets the AM/WX tuner's squelch level, from 0% to 100%. The default squelch level is about 55%.
Output: <Sig_Strength>	Indicates the AM signal strength. The analog values will range from 0 (for no signal) to 65535 (maximum signal strength).
Input: <SigSrc>	Sets the AM/WX antenna signal source. Valid analog values are as follows: 0 = Internal Loop A 1 = Internal Loop B 2 = External Plus Loop A 3 = External Plus Loop B No other values are valid.
Output: <SigSrc-F>	Indicates the current AM/WX antenna signal source. The analog values will range from 0 to 3.
Input: <AM_Presets>	Selects an AM station preset to Play or Save. When the <AM_Save_Preset> input is high, the tuner saves the selected preset. When <AM_Save_Preset> is low, the tuner plays the selected preset. Valid analog values range from 0d (for Preset 1) to 9d (for Preset 10). No other values are valid.
Input: <WX_Presets>	Selects a weather station preset to Play or Save. When the <AM_Save_Preset> input is high, the tuner saves the selected preset. When <AM_Save_Preset> is low, the tuner plays the selected preset. Valid analog values range from 0d (for Preset 1) to 4d (for Preset 5). No other values are valid.
Inputs: <AM_Preset1> through <AM_Preset10>	Indicates the frequency of the corresponding preset. For example, if Preset 4 is AM station 820, then <AM_Preset4> will equal 820d.
Inputs: <WX_Preset1> through <WX_Preset5>	Indicates the weather station channel number of the corresponding preset. The analog values will range from 1 to 7.

Uploading and Upgrading

Assuming a PC is properly connected to the entire system, Crestron programming software allows the programmer to upload programs and projects after their development to the system and network devices. However, there are times when the files for the program and projects are compiled and not uploaded. Instead, compiled files may be distributed from programmers to installers, from Crestron to dealers, etc. Even firmware upgrades are available from the Crestron website as new features are developed after product releases. In those instances, one has the option to upload via the programming software or to upload and upgrade via the Crestron Viewport.

NOTE: The Crestron Viewport is available as a pull-down command from SIMPL Windows and VT Pro-e (**Tools | Viewport**) or as a standalone utility. The Viewport utility accomplishes multiple system tasks, primarily via an RS-232 or TCP/IP

connection between the control system and a PC. It is used to observe system processes, upload new operating systems and firmware, change system and network parameters, and communicate with network device consoles and touchpanels, among many other tasks. Viewport can also function as a terminal emulator for generic file transfer. All of these functions are accessed through the commands and options in the Viewport menus. Therefore, for its effectiveness as a support and diagnostic tool, the Crestron Viewport may be preferred over development tools when uploading programs and projects.

The following sections define how one would upload a SIMPL Windows program or upgrade the firmware of the C2N-TFM. However, before attempting to upload or upgrade, it is necessary to establish communications.

Communication Settings

NOTE: For laptops and other PCs without a built-in RS-232 port, Crestron recommends the use of PCMCIA cards, rather than USB-to-serial adapters. If a USB-to-serial adapter must be used, Crestron has tested the following devices:

Belkin (large model) F5U103
 I/O Gear GUC232A (discontinued)
 Keyspan USA-19QW (discontinued)

Results may vary, depending on the computer being used. Other models, even from the same manufacturer, may not yield the same results.

The procedure in this section provides details for RS-232 communication between the PC and the control system. If TCP/IP communication is preferred, consult the latest version of the Crestron e-Control Reference Guide (Doc. 6052) or the respective Operations Guide for the control system. These documents are available from the Downloads | Product Manuals section of the Crestron website (www.crestron.com). Refer to the following figure for a typical connection diagram when uploading files.

NOTE: Use a standard DB9 male to female “straight-through” cable.

Typical Connection Diagram when Uploading

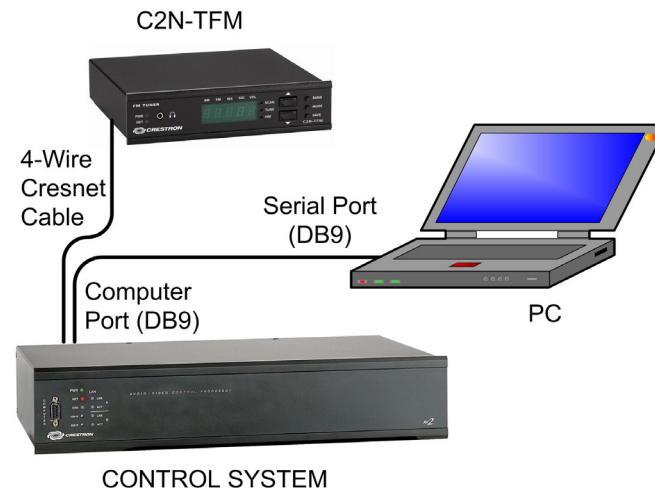

1. Open the Crestron Viewport.
Either launch the stand-alone version of Viewport, or start SIMPL Windows or VT Pro-e, and from the menu bar, select **Tools | Viewport**.
2. Refer to the figure after this step. From the Viewport menu, select **Setup | Communications settings** (alternatively, press **Alt+D**) to open the “Port Settings” window.

Setup | Communications Settings Command

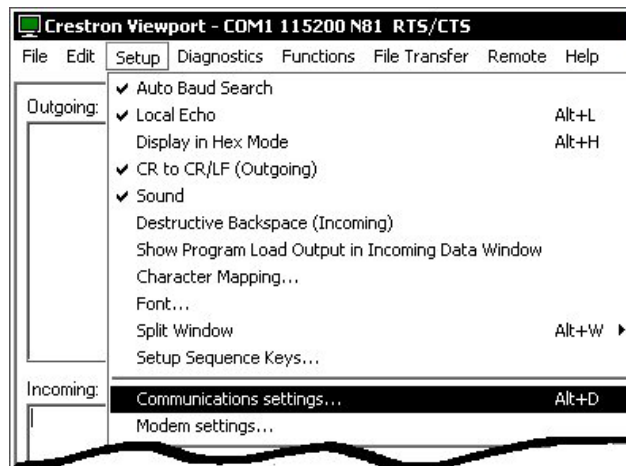

3. Select **RS-232** as the connection type. Verify that an available COM port (COM 1 is shown after this step) is selected, and that all communication parameters and necessary options from the “Port Settings” window are selected as shown below. Click the **OK** button to save the settings and close the window.

“Port Settings” Window

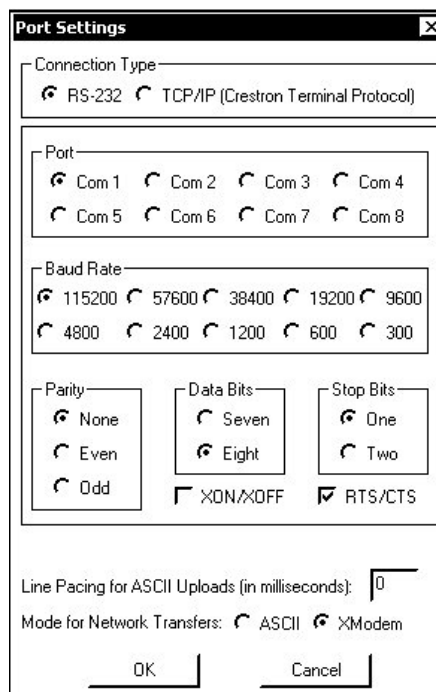

NOTE: The parameters shown in the previous illustration are the port settings for a 2-Series control system. Consult the Operations Guide for the control system being used for exact parameter selection.

- To verify communication, select **Diagnostics | Establish Communications (Find Rack)**. This should display a window that gives the COM port and baud rate. If communication cannot be established, refer to the “Troubleshooting Communications” section in the respective Operations Guide for the control system.

Uploading a SIMPL Windows Program

A control system source file has the extension .smw. A compiled SIMPL Windows file has the extension .spz for a 2-Series control system, .bin for CNX generation, and .csz for CNX generation with SIMPL+.

The SIMPL Windows file can be uploaded to the control system using SIMPL Windows or via the Crestron Viewport.

Upload via SIMPL Windows

- Start SIMPL Windows.
- Select **File | Open** to view the “Open” window, navigate to the SIMPL Window file (.smw), and click **Open**.
- Select **Project | Transfer Program**.

Upload via Crestron Viewport

- Verify that the procedure for “Communication Settings” that begins on page 34 has been performed.
- As shown after this step, select **File Transfer | Send Program** (alternatively, press **Alt+P**) from the Viewport menu.

File Transfer | Send Program Command

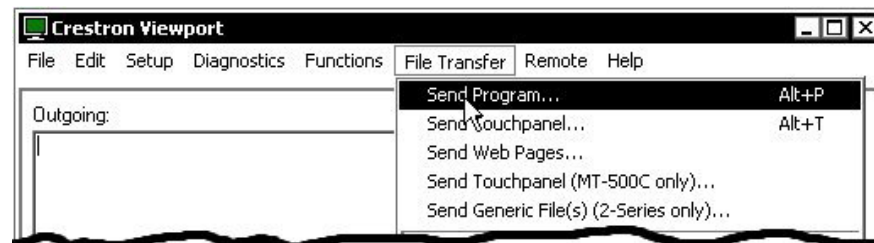

- The “Send Program” window appears, as shown after this step. Click **Browse**, locate the compiled file (.spz for PRO2), and click **Open**. This will display the program's header information and enable one or both of the *What to Send* check boxes. If the program does not contain any SIMPL+ modules, only the *SIMPL Program* check box will be enabled. If it does contain SIMPL+ modules, then the *SIMPL+ Program(s)* check box will also be enabled. Select one or both check boxes and then click **Send Program** to begin the transfer.

NOTE: Refer to the respective Operations Guide for the control system for details about the other fields shown on the “Send Program” window.

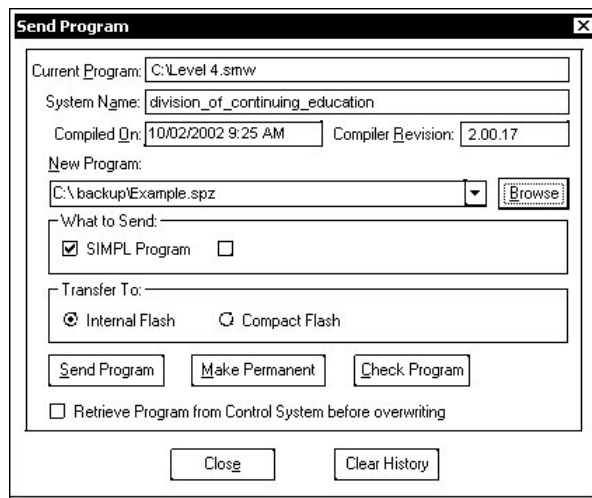
“Send Program” Window

4. To verify that the program has been transferred successfully, select **Diagnostics | Report Program Information**. This should display a window that provides details about the current program loaded into the control system.

Firmware Upgrade – FM Tuner

A firmware upgrade file has the extension .upg.

To take advantage of all the C2N-TFM features, it is important that the unit contains the latest firmware available. Therefore, please check the Crestron website (http://www.crestron.com/downloads/software_updates.asp) for the latest version of firmware. Not every product has a firmware upgrade, but as Crestron improves functions, adds new features, and extends the capabilities of its products, firmware upgrades are posted. To upgrade the firmware, complete the following steps.

1. Make sure that “Communication Settings” that begins on page 34 has been performed.
2. As shown after this step, select **File Transfer | Update Network Device Firmware** from the Viewport menu.

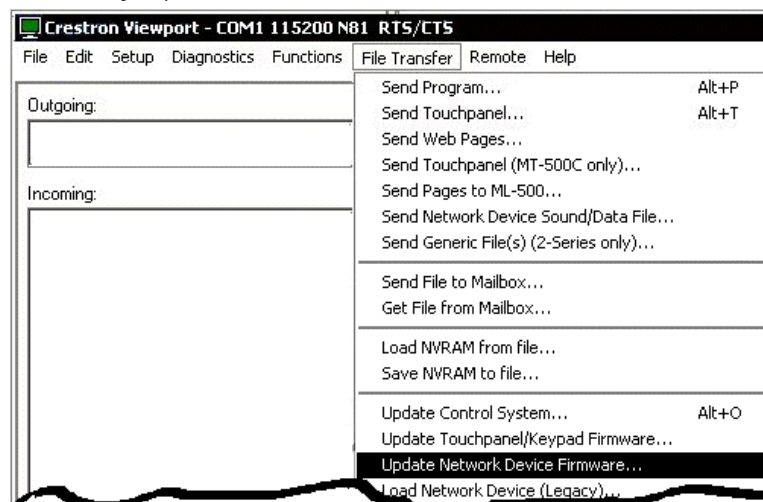
File Transfer | Load Network Device Command

- As shown after this step, select the Net ID of the C2N-TFM and then click **OK**. The “Open” window appears (refer to the subsequent graphic).

“Select Network ID” Window

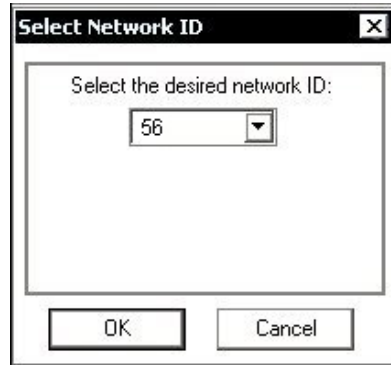

NOTE: When transferring any Cresnet file (touchpanel project/firmware), lower the port speed baud rate to 38400 to match the Cresnet bus speed.

“Open” Window

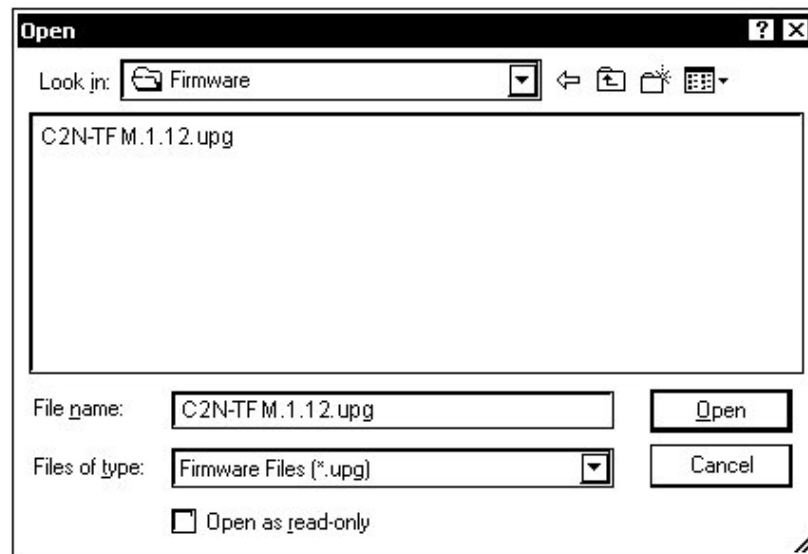

- Browse to the desired .upg file and click **Open** to begin the transfer.

Firmware Upgrade – AMWX Tuner

The procedures for upgrading the firmware for the AM/WX Tuner are almost identical to those for the FM Tuner. The difference is that the AMWX Tuner is not a standalone Cresnet device, but is a sub-slot device of the FM Tuner. To upgrade the firmware, complete the following steps.

- Make sure that the AM/WX Tuner is connected to the FM Tuner (refer to “Hardware Hookup” on page 12) and that “Communication Settings” that begins on page 34 has been performed.
- As shown after this step, select **File Transfer | Update Sub-Slot Device Firmware** from the Viewport menu.

File Transfer | Load Sub-Slot Device Command

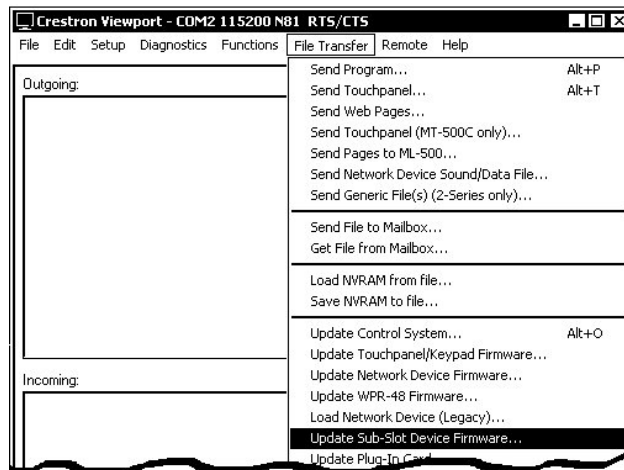

- As shown after this step, select the Net ID of the C2N-TFM (56), select the desired sub-slot ID of the AM/WX Tuner (03), and then click **OK**. The "Open" window appears (refer to the subsequent graphic).

"Select Network ID" Window

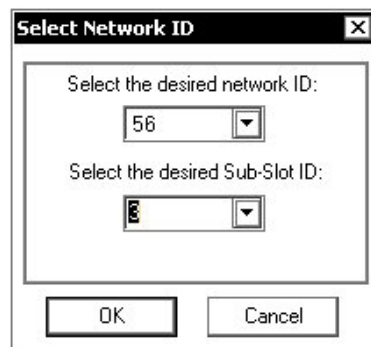

NOTE: When transferring any Cresnet file (touchpanel project/firmware), lower the port speed baud rate to 38400 to match the Cresnet bus speed.

"Open" Window

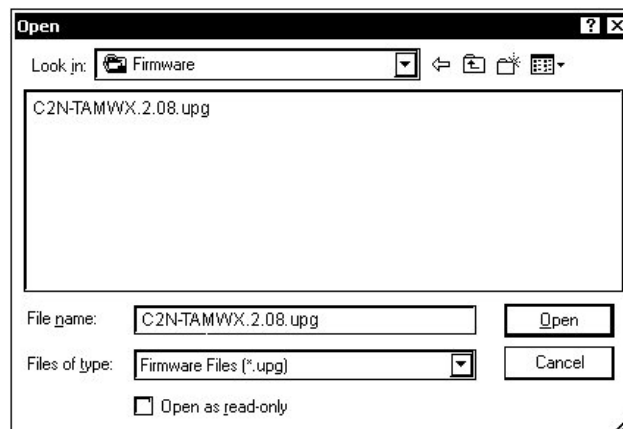

- Browse to the desired .upg file and click **Open** to begin the transfer.

Problem Solving

Troubleshooting

The following table provides corrective action for possible trouble situations. If further assistance is required, please contact a Crestron customer service representative.

C2N-TFM Troubleshooting

TROUBLE	PROBABLE CAUSE(S)	CORRECTIVE ACTION
Green PWR LED does not illuminate.	Wrong power supply.	Use a Crestron power supply.
	C2N-TFM is not receiving power.	Verify that cables plugged into NET port are secure.
Yellow NET LED does not illuminate.	Improper Net ID.	Verify that the C2N-TFM Net ID matches Net ID in the software program.
	Loose network connection.	Verify that cable plugged into NET port is secure.
Search functions do not work properly.	Station signal strength is too low.	Check antenna placement for good signal strength.

Further Inquiries

If you cannot locate specific information or have questions after reviewing this guide, please take advantage of Crestron's award winning customer service team by calling the Crestron corporate headquarters at 1-888-CRESTRON [1-888-273-7876]. For assistance in your local time zone, refer to the Crestron website (www.crestron.com) for a listing of Crestron worldwide offices.

You can also log onto the online help section of the Crestron website (www.crestron.com) to ask questions about Crestron products. First-time users will need to establish a user account to fully benefit from all available features.

Future Updates

As Crestron improves functions, adds new features, and extends the capabilities of the C2N-TFM, additional information and programming examples may be made available as manual updates. These updates are solely electronic and serve as intermediary supplements prior to the release of a complete technical documentation revision.

Check the Crestron website (www.crestron.com) periodically for manual update availability and its relevance. Updates are available from the Downloads | Product Manuals section and are identified as an “Addendum” in the Download column.

Appendix: RDS/RBDS Function Support

Many radio stations transmit additional information, such as traffic information, radio text, real time clock etc., with their regular FM programming. The FM Tuner contains circuitry that retrieves this information.

The US format for such information is called the Radio Broadcast Data System (RBDS), and in Europe this format is called the Radio Data System (RDS). There are some differences between the US and European standards.

The tables in this Appendix describe information included in the standard.

RDS/RBDS Supported Feature Overview

FEATURES	DESCRIPTION
Program type name (PTY)	There are 31 program types such as jazz, classic etc. Each station that supports RDS will report its program type. (Refer to program type list following this table.)
Program service name (PS)	The station reports its service name such as WIRL, KTU etc.
Program type additional Info (PTYN)	The station sometimes will report additional information about its program type. For example, a program type "Sport" station may report a PTYN of "Football".
Radio text display support (RT)	The station will report radio text information such as phone numbers, artist, song, stations name, etc., in this field. This field could be either 32 or 64 characters.
Universal real time clock (UTC)	Some stations transmit the universal time clock year, month, day, hour, minute, and GMT offset.
Traffic information report (TA/TP)	The stations that support the traffic information.
Station search by TA, TP or TA&TP traffic information types	The FM Tuner can search for stations, which either broadcast or know about other stations that transmit the traffic information. TA = This station has information about other station which carries the traffic announcements. TP = This station broadcasts traffic announcements, but none is being broadcasted right now. TA&TP = This station is currently broadcasting the traffic announcements.
Station search by PTY	The FM Tuner is able to search for station with specified program type

RDS/RBDS Program Types

PTY CODE	RDS PROGRAM TYPE (EUROPE)	RBDS PROGRAM TYPE (US)
0	No program type or undefined	No program type or undefined
1	News	News
2	Current Affair	Information
3	Information	Sports
4	Sports	Talk
5	Education	Rock
6	Drama	Classic Rock

(continued on next page)

RDS/RBDS Command Table (continued)

PTY CODE	RDS PROGRAM TYPE (EUROPE)	RBDS PROGRAM TYPE (US)
7	Culture	Adult Hits
8	Science	Soft Rock
9	Varied	Top 40
10	Pop Music	Country
11	Rock Music	Oldies
12	M.O.R Music	Soft
13	Light classical	Nostalgia
14	Serious Classic	Jazz
15	Other Music	Classical
16	Weather	Rhythm and Blues
17	Finance	Soft Rhythm and Blues
18	Children's Program	Language
19	Social Affairs	Religious Music
20	Religion	Religious Talk
21	Phone In	Personality
22	Travel	Public
23	Leisure	College
24	Jazz Music	Unassigned
25	Country Music	Unassigned
26	National Music	Unassigned
27	Oldies Music	Unassigned
28	Folk Music	Unassigned
29	Documentary	Weather
30	Alarm Test	Emergency Text
31	Alarm	Emergency

Return and Warranty Policies

Merchandise Returns / Repair Service

1. No merchandise may be returned for credit, exchange, or service without prior authorization from CRESTRON. To obtain warranty service for CRESTRON products, contact the factory and request an RMA (Return Merchandise Authorization) number. Enclose a note specifying the nature of the problem, name and phone number of contact person, RMA number, and return address.
2. Products may be returned for credit, exchange, or service with a CRESTRON Return Merchandise Authorization (RMA) number. Authorized returns must be shipped freight prepaid to CRESTRON, 6 Volvo Drive, Rockleigh, N.J., or its authorized subsidiaries, with RMA number clearly marked on the outside of all cartons. Shipments arriving freight collect or without an RMA number shall be subject to refusal. CRESTRON reserves the right in its sole and absolute discretion to charge a 15% restocking fee, plus shipping costs, on any products returned with an RMA.
3. Return freight charges following repair of items under warranty shall be paid by CRESTRON, shipping by standard ground carrier. In the event repairs are found to be non-warranty, return freight costs shall be paid by the purchaser.

CRESTRON Limited Warranty

CRESTRON ELECTRONICS, Inc. warrants its products to be free from manufacturing defects in materials and workmanship under normal use for a period of three (3) years from the date of purchase from CRESTRON, with the following exceptions: disk drives and any other moving or rotating mechanical parts, pan/tilt heads and power supplies are covered for a period of one (1) year; touchscreen display and overlay components are covered for 90 days; batteries and incandescent lamps are not covered.

This warranty extends to products purchased directly from CRESTRON or an authorized CRESTRON dealer. Purchasers should inquire of the dealer regarding the nature and extent of the dealer's warranty, if any.

CRESTRON shall not be liable to honor the terms of this warranty if the product has been used in any application other than that for which it was intended, or if it has been subjected to misuse, accidental damage, modification, or improper installation procedures. Furthermore, this warranty does not cover any product that has had the serial number altered, defaced, or removed.

This warranty shall be the sole and exclusive remedy to the original purchaser. In no event shall CRESTRON be liable for incidental or consequential damages of any kind (property or economic damages inclusive) arising from the sale or use of this equipment. CRESTRON is not liable for any claim made by a third party or made by the purchaser for a third party.

CRESTRON shall, at its option, repair or replace any product found defective, without charge for parts or labor. Repaired or replaced equipment and parts supplied under this warranty shall be covered only by the unexpired portion of the warranty.

Except as expressly set forth in this warranty, CRESTRON makes no other warranties, expressed or implied, nor authorizes any other party to offer any warranty, including any implied warranties of merchantability or fitness for a particular purpose. Any implied warranties that may be imposed by law are limited to the terms of this limited warranty. This warranty statement supercedes all previous warranties.

Trademark Information

All brand names, product names, and trademarks are the sole property of their respective owners. Windows is a registered trademark of Microsoft Corporation. Windows95/98/Me/XP and WindowsNT/2000 are trademarks of Microsoft Corporation.



Crestron Electronics, Inc.
15 Volvo Drive Rockleigh, NJ 07647
Tel: 888.CRESTRON
Fax: 201.767.7576
www.crestron.com

Operations Guide – DOC. 6233A
07.04

Specifications subject to
change without notice.

Free Manuals Download Website

<http://myh66.com>

<http://usermanuals.us>

<http://www.somanuals.com>

<http://www.4manuals.cc>

<http://www.manual-lib.com>

<http://www.404manual.com>

<http://www.luxmanual.com>

<http://aubethermostatmanual.com>

Golf course search by state

<http://golfingnear.com>

Email search by domain

<http://emailbydomain.com>

Auto manuals search

<http://auto.somanuals.com>

TV manuals search

<http://tv.somanuals.com>