

Introduction

CRESTRON GREEN LIGHT EXPRESS power switching cabinets come pre-configured with GLXP switching modules already installed. The cabinets only require installation and wiring of feed and load circuits.

Regulatory Compliance

The cabinet and modules are Listed to applicable UL Standards and requirements by Underwriters Laboratories Inc.



Application

The following diagram shows CRESTRON GREEN LIGHT EXPRESS power switching cabinets in a lighting application that is controlled by an IPAC system.

CRESTRON GREEN LIGHT EXPRESS Power Switching Cabinets in a Typical Lighting Application

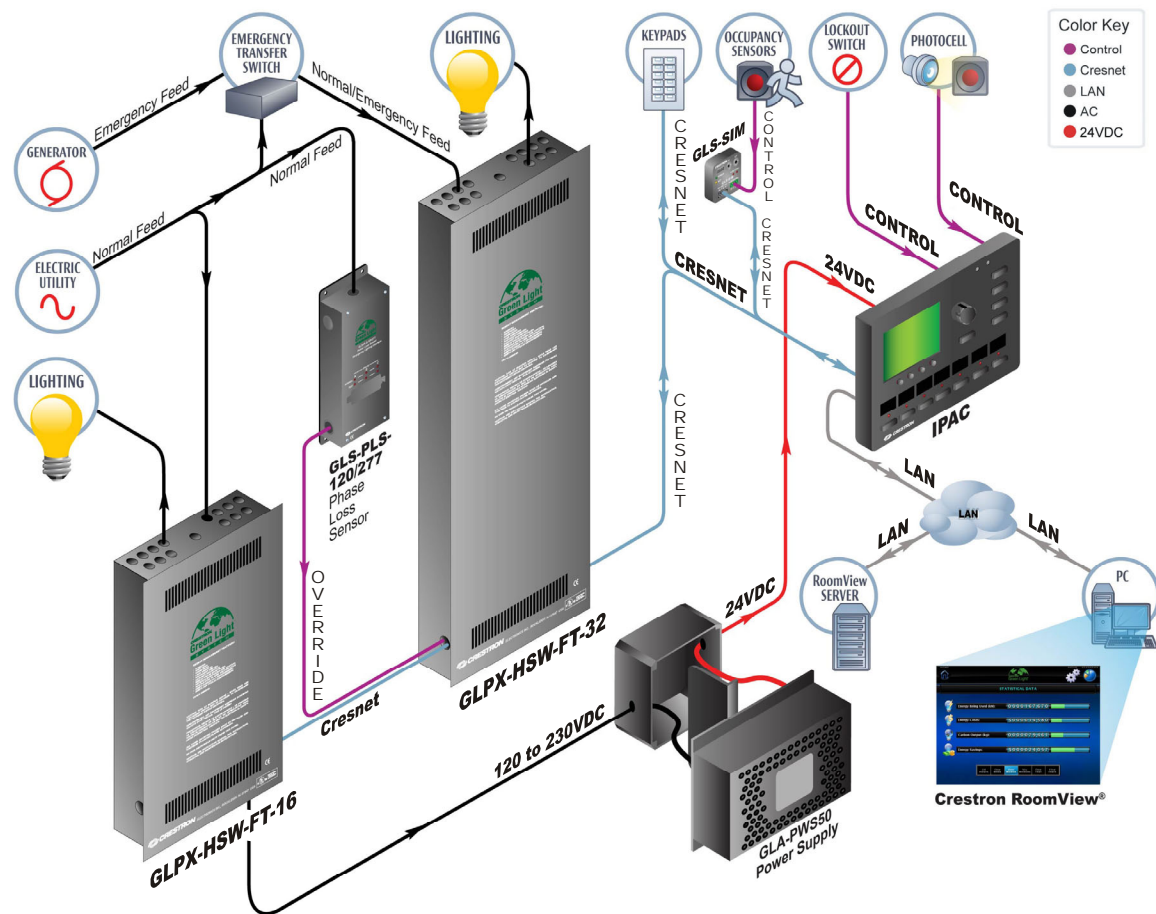

Physical Description

This section shows the dimensions of the CRESTRON GREEN LIGHT EXPRESS power switching cabinets.

Dimensions of GLPX-HSW-FT-8, -12, -16 Power Switching Cabinets (Front, Side and Bottom View)

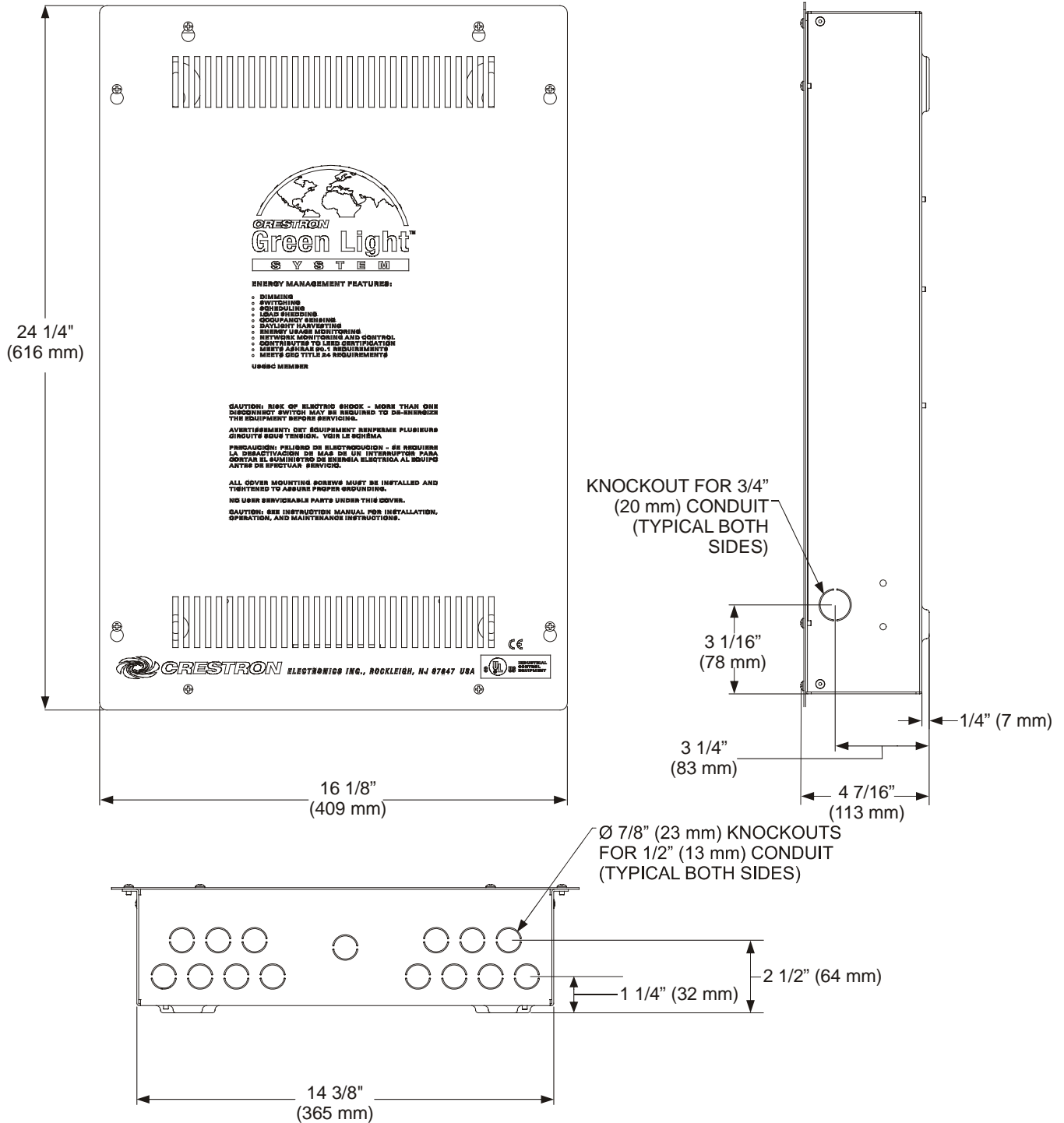

Dimensions of GLPX-HSW-FT-8 , -12, -16 Power Switching Cabinets (Internal View)

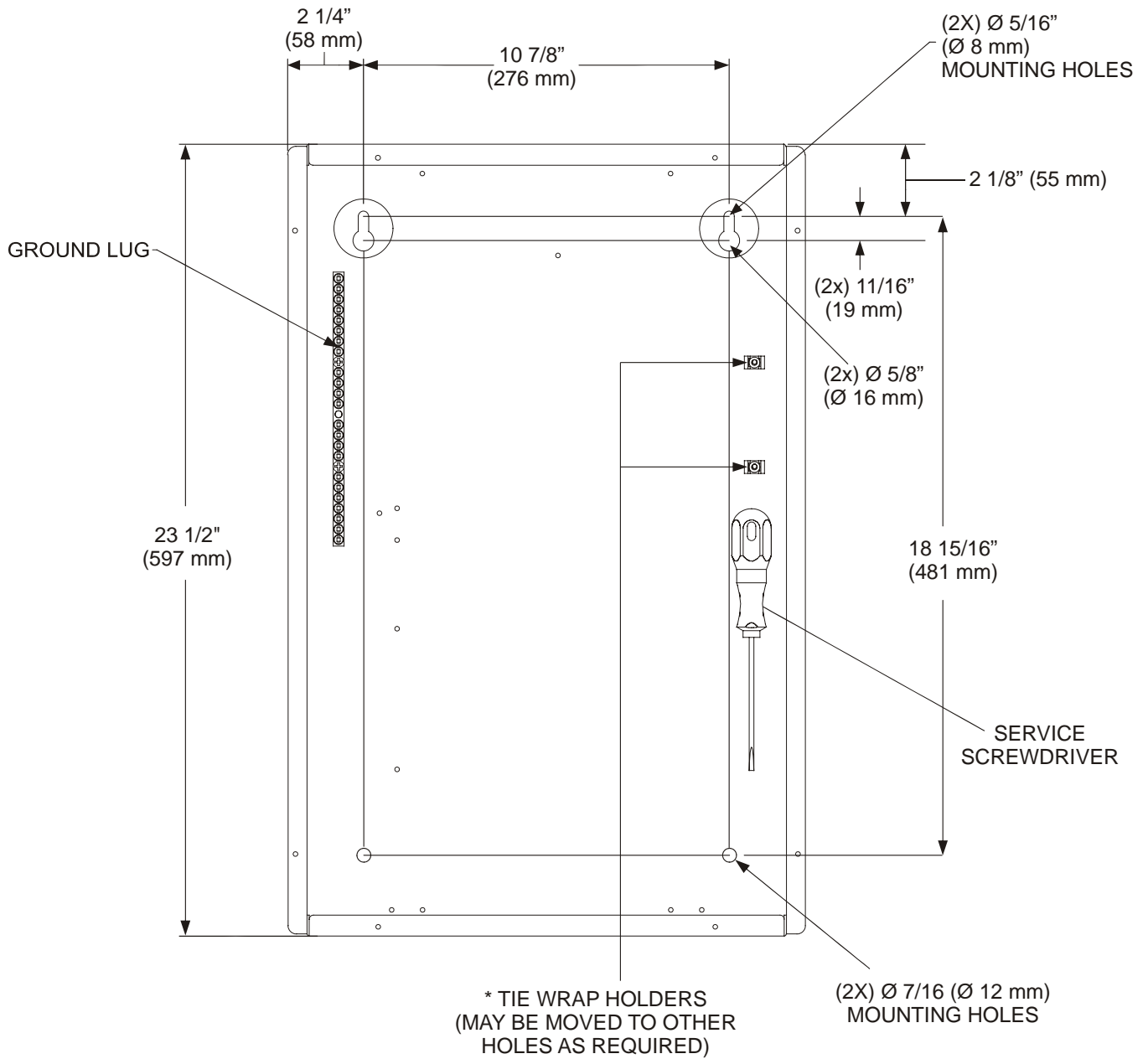

* Installed GLXP modules come with additional tie wrap holders.

Dimensions of GLPX-HSW-FT-20, -24, -28, -32 Power Switching Cabinets (Front, Side and Bottom View)

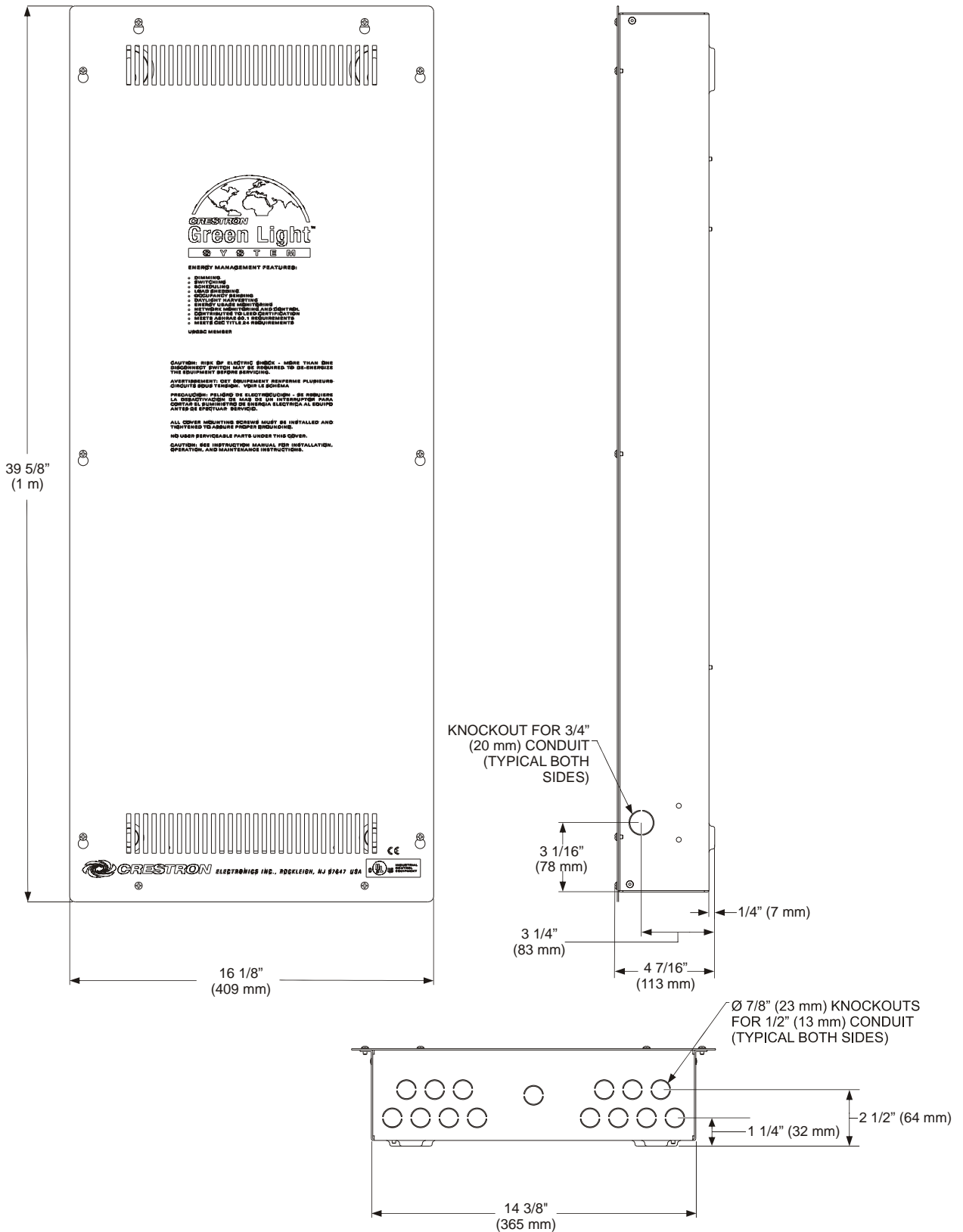

Dimensions of GLPX-HSW-FT-20, -24, -28, -32 Power Switching Cabinets (Internal View)

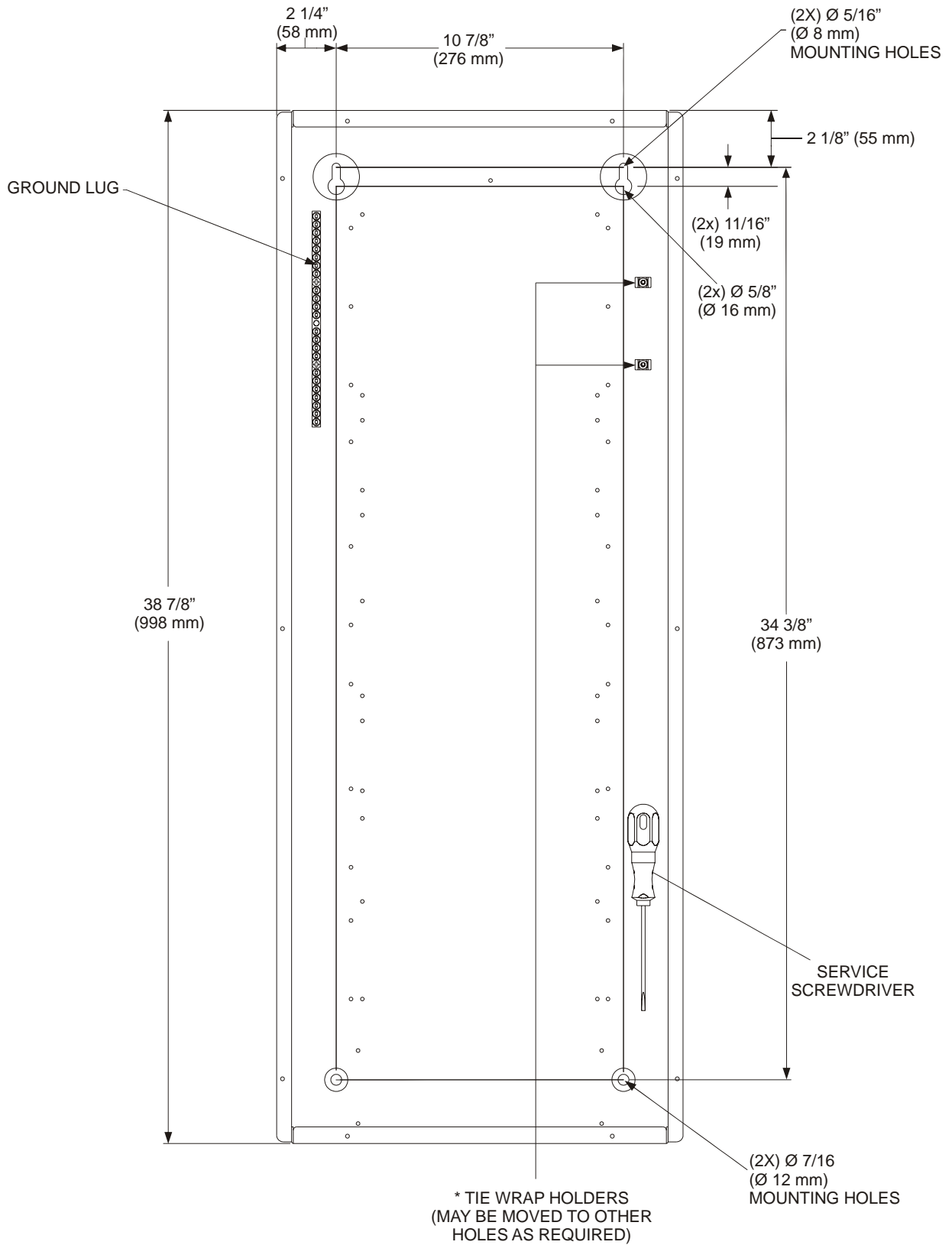

* Installed GLXP modules come with additional tie wrap holders.

Installation

Observe the following when installing the cabinet:

- The cabinet must be mounted by a licensed electrician in accordance with all national and local codes. Refer to the diagram below for specific requirements.
- The cabinet is designed for surface mounting on a wall.
- Cabinets are intended for indoor use only.
- The ambient temperature range should be 32°F to 104°F (0°C to 40°C). The relative humidity should range from 10% to 90% (non-condensing). Allow adequate clearance in front of the cover for servicing.

Mounting Location

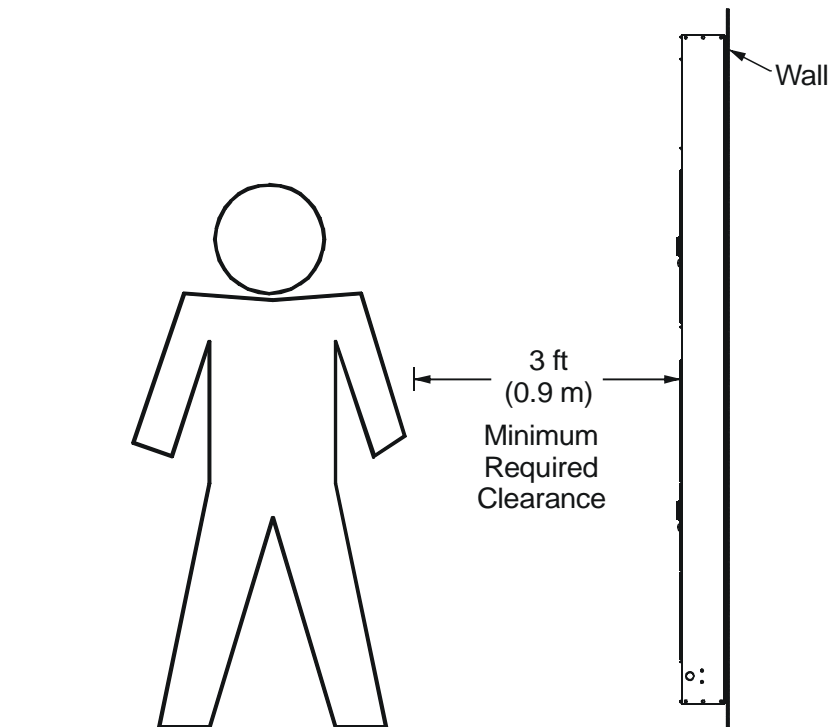

Wiring

NOTE: All wiring must be installed in accordance with all local and national electrical codes.

NOTE: Refer to the torque settings specified on pages 8 and 9.

CRESTRON GREEN LIGHT EXPRESS cabinets are shipped with GLXP low profile switching modules installed. The following must be performed after mounting the cabinet:

- Connect incoming feed conductors to the **L** and **N** input terminals and connect loads to **SW** output terminals (section **A** of the following diagram)
- Connect control wiring (section **B** of the following diagram)

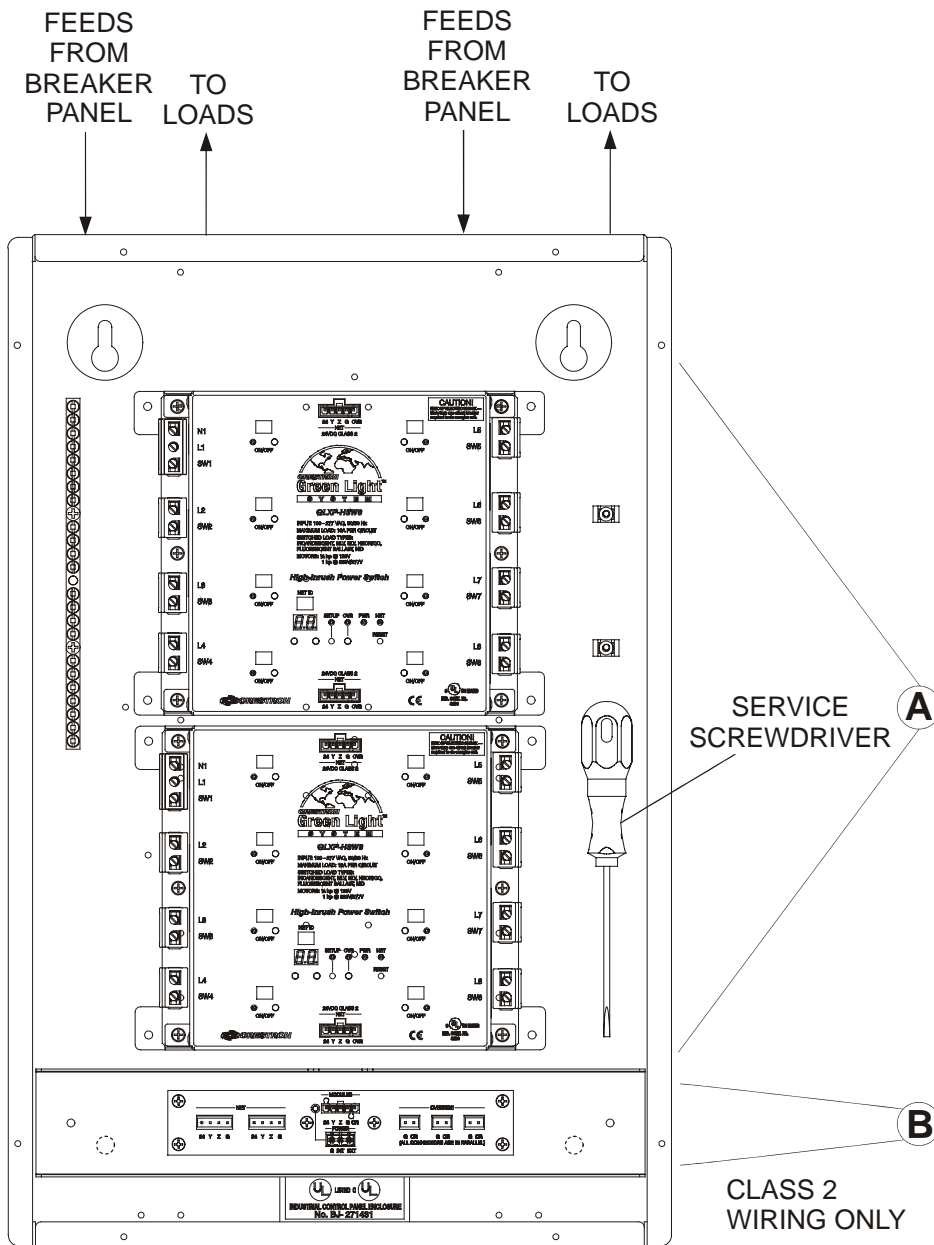

Feed-Through and Load Wiring (Section A)

CAUTION: Bypass jumpers are provided on each output to allow testing and to protect the modules during installation. The jumper shorts the **L** and **SW** terminals so that the load circuit is energized when the branch breaker is on.

NOTE: Do not remove the bypass jumper until all feed and load wiring has been completed, and the circuits have been tested for electrical faults.

NOTE: Use copper conductors only – rated 75°C.

Wire Gauge and Torque Values

TERMINAL	CONNECTOR MAX WIRE RANGE	TORQUE	STRIP LENGTH
L AND N INPUTS	26-10 AWG	5.31 lb-in (0.6 Nm) to 7.08 lb-in (0.8 Nm) max	3/8" (9 mm)
SW OUTPUTS	26-10 AWG	5.31 lb-in (0.6 Nm) to 7.08 lb-in (0.8 Nm) max	3/8" (9 mm)
GROUND LUG	14-4 AWG	25-45 lb-in (2.8-5.1 Nm)	3/4" (19 mm)

Load Wiring for GLXP-HSW8 and GLXP-HSW12

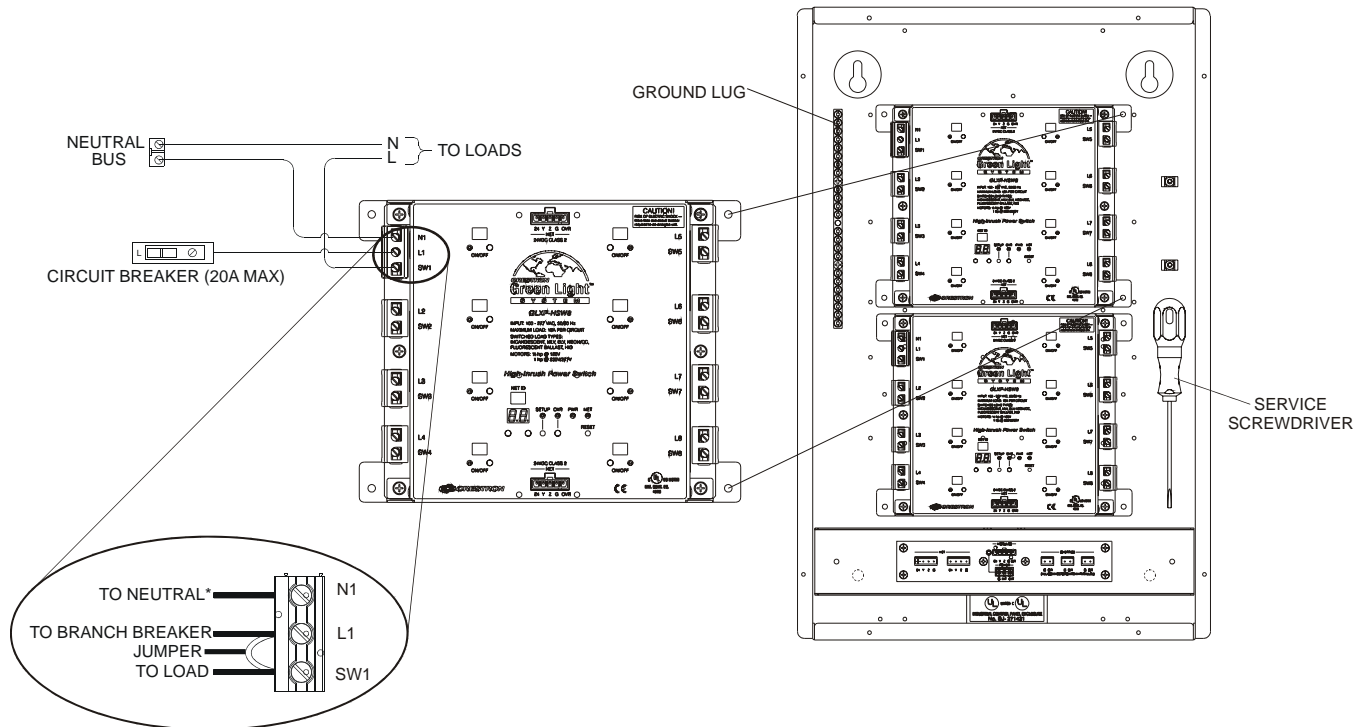

* A single **NEUTRAL** connection is required for each module.

1. Test the circuit for electrical faults by turning on each circuit breaker, checking that the breakers do not trip, and that power is delivered to the proper loads.
2. Turn off the circuit breaker(s) and remove all jumpers.
3. Turn on the circuit breakers.

Control Wiring (Section B)

The bottom of the cabinet contains Cresnet® connections for interfacing to the rest of the Crestron® control system, and a power port to provide an alternate source of 24 volt power to the modules. It also provides an override input which can be tied to devices such as the GLS-PLS-120/277 phase-loss sensor, or other devices that provide a dry contact closure (manual switch, fire alarm relay, etc.).

NOTE: Interface connectors for **NET** (x2), **POWER** (x1), and **OVERRIDE** (x3) ports are provided.

Wire Gauge and Torque Values

TERMINAL	CONNECTOR MAX WIRE RANGE	TORQUE	STRIP LENGTH
NET	26-12 AWG	4.43 lb-in (0.5 Nm)	1/4" (6 mm)
POWER	26-12 AWG	4.43 lb-in (0.5 Nm)	1/4" (6 mm)
OVERRIDE	26-12 AWG	4.43 lb-in (0.5 Nm)	1/4" (6 mm)

Connector Wiring

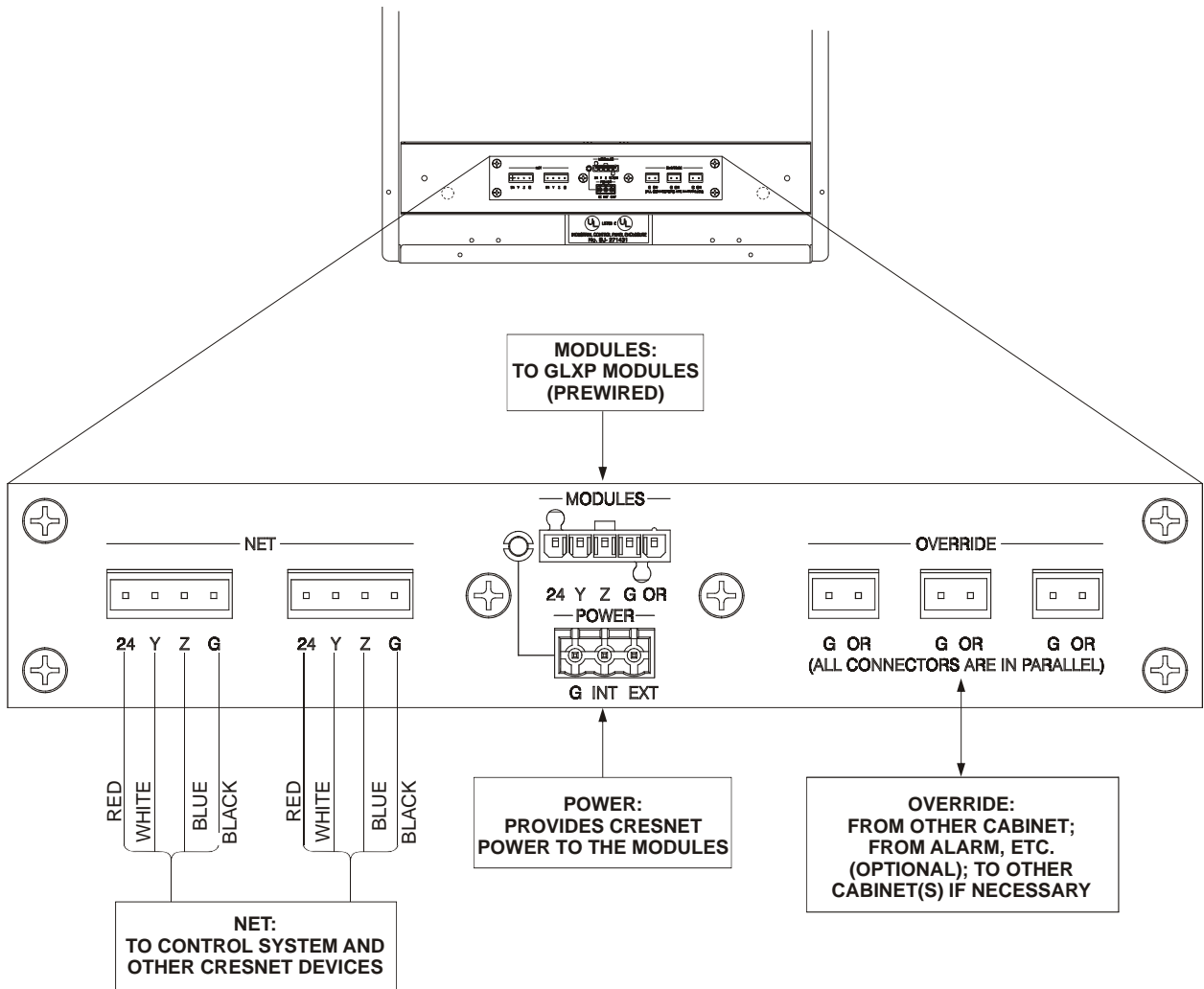

NET Port Wiring

When wiring the supplied **NET** connectors for connection to a Crestron control system or other device on the Cresnet network, use Crestron certified wire such as CRESNET-NP or CRESNET-P.

To ensure optimum performance over the full range of your installation topology, use Crestron certified wire. Failure to do so may incur additional charges if support is required to identify performance deficiencies because of using improper wire.

When daisy-chaining connections between **NET** ports, strip the ends of the wires carefully to avoid nicking the conductors. Twist together the ends of the wires that share a pin on the network connector, insert the connection into the Cresnet connector, tighten the retaining screw. Repeat the procedure for the other three conductors.

POWER Port Wiring

Each module in the cabinet receives power via the line voltage connected to channel 1. In the event that line voltage is unavailable, the module can receive power via a backup low voltage supply. Low voltage (24 VDC) power may be supplied to the modules either internally via the **NET** port or externally via a Cresnet power supply connected to the **POWER** port.

To power the modules from the **NET** port, install a jumper from the **INT** pin on the supplied **POWER** connector to the **EXT** pin on the **POWER** connector as shown in the following diagram.

Providing Cresnet Power Via The Net Port

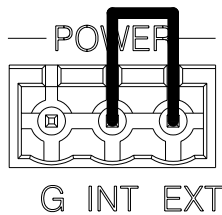

To power the modules externally from a Cresnet 24 VDC power supply, connect the external power supply to the **EXT** and **G** pins on the **POWER** supplied connector as shown in the following diagram.

Providing Cresnet Power Via Dedicated Power Supply

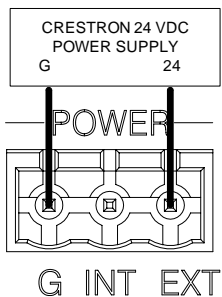

When properly connected and receiving 24 VDC power, the green LED next to the **MODULES** port will light.

OVERRIDE Port Wiring

When a connection is applied between the override terminals, the modules will enter override mode. The Crestron GLS-PLS-120/277 phase-loss sensor or any device that provides a dry contact closure can be connected to the supplied **OVERRIDE** connector on the bottom of the cabinet.

Testing

Manual Control

Lighting modules can be manually controlled from the front panel.

To toggle the output between off and on, tap the appropriate **ON/OFF** button. The corresponding LED illuminates and the output state is shown on the **NET ID** display (“oF” for off, “On” for on) for two seconds after the button is released.

NOTE: The control system program may change the settings if the *Override* mode is not enabled.

Override Mode

The *Override* mode overrides the control system program and sets all of the output states to the stored override values. For instructions on saving override settings, refer to “Save Override Settings” below.

To enable *Override* mode, press and release the **OVR** button. The **OVR** LED flashes slowly.

NOTE: If the *Override* mode was enabled from an external device (i.e. a contact closure is present on the **OVERRIDE** terminals), the **OVR** LED will flash quickly. Pressing the **OVR** button has no effect.

To disable *Override* mode, press the **OVR** button again. The **OVR** LED extinguishes and the outputs return to the states set by the control system program.

NOTE: If override states have not been stored, the factory default override state is all loads on.

Save Override Settings

The state of each output can be saved as an override setting, which can be automatically recalled when the *Override* mode is enabled.

NOTE: The control system program has a setting that can prevent locally saving the override state. If this setting is enabled, the display shows “Er” when trying to save override states. For more information, refer to the SIMPL Windows help file.

To save the states of all outputs as the override setting, press and hold the **OVR** button for three seconds until the LED blinks once. The **OVR** LED blinks to indicate the new override setting has been stored.

System Operation and Commissioning

This cabinet has been designed as a component of a programmed Crestron system. System commissioning by an authorized Crestron representative **must** be performed to ensure system operation.

Once the cabinet has been wired and the modules have been tested, contact Crestron at 1-888-CRESTRON [1-888-273-7876] to schedule commissioning.

Problem Solving

Troubleshooting

The following table provides corrective action for possible trouble situations. If further assistance is required, please contact a Crestron customer service representative.

Troubleshooting

TROUBLE	POSSIBLE CAUSE(S)	CORRECTIVE ACTION
Module(s) does not function.	Power not delivered to the module.	If the module is powered internally, verify that the circuit breaker connected to the first channel on the module is on and delivering power to the module. If module is powered externally, verify that the POWER port is correctly wired and receiving power.
	System commissioning not complete.	Arrange for system commissioning.
Module's PWR LED is flashing.	AC power not present on L1 .	Check that the branch breaker feeding L1 has not tripped. Note that unit will continue to function, but will draw power from the backup Cresnet power supply if available.
Unit cannot be taken out of <i>Override</i> mode	Short (contact closure) exists between G and OVR terminals on any of the OVERRIDE terminals present at bottom of the cabinet.	Determine the reason for the short. Remove or remedy the short (e.g. GLS-PLS-120/277 phase-loss sensor may not have been installed properly, or actual phase-loss has been detected).

Further Inquiries

If you cannot locate specific information or have questions after reviewing this guide, please take advantage of Crestron's award winning customer service team by calling Crestron at 1-888-CRESTRON [1-888-273-7876].

You can also log onto the online help section of the Crestron website (www.crestron.com/onlinehelp) to ask questions about Crestron products. First-time users will need to establish a user account to fully benefit from all available features.

Appendix A: Setting Module Net IDs

The following procedure will normally be performed by an authorized Crestron representative as part of the System Commissioning phase. For system wiring and basic testing as described on pages 7 and 11, it is not necessary to perform this step. Only perform this step if instructed by an authorized Crestron representative, or when replacing modules on a system that have already been commissioned (in the latter case the Net ID should be set to match the Net ID of the module being replaced).

The Net ID of each module in the cabinet can be changed from the front panel of each module. The Net IDs of each module in the system must be unique.

To set the Net ID using the front panel:

1. Press the recessed **SETUP** button to enter the *Setup* mode. The **SETUP** LED illuminates.
2. As shown in the following diagram, press the left button under the **NET ID** display to change the left digit of the Net ID or press the right button under the **NET ID** display to change the right digit of the Net ID number.

Changing the Net ID

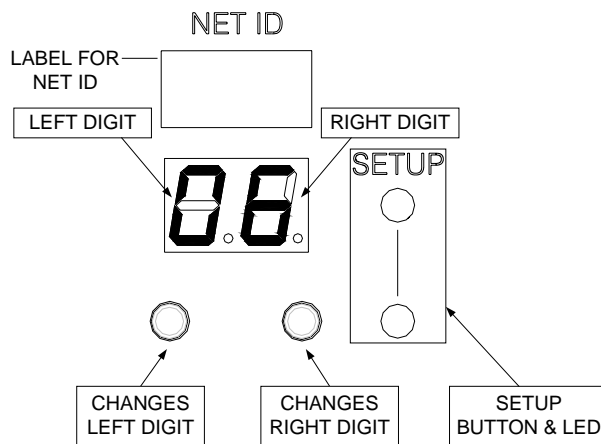

3. When the desired Net ID is displayed, press the **SETUP** button to exit the *Setup* mode. The **SETUP** LED extinguishes.

If the **SETUP** button is not pressed, the *Setup* mode will time out after one minute of inactivity and the Net ID will revert back to its original value.

Appendix B: Specifications

Specifications for the GLXP modules are listed in the following table.

GLXP Module Specifications

SPECIFICATION	DETAILS
Input Voltage	100 – 277 VAC 50/60 Hz
Supported Load Types	Incandescent, HID, magnetic low voltage (MLV), electronic low voltage (ELV), neon/cold cathode, and fluorescent ballasts, motor
Maximum Load	
Lighting	16 A per output
Motor	½ HP @ 120V 1 HP @ 230V / 277V
Environmental	
Temperature	32° to 104° F (0° to 40° C)
Humidity	10% to 90% RH (non-condensing)
Heat Dissipation	10 BTU/Hr

This page is intentionally left blank.

Return and Warranty Policies

Merchandise Returns / Repair Service

1. No merchandise may be returned for credit, exchange or service without prior authorization from CRESTRON. To obtain warranty service for CRESTRON products, contact an authorized CRESTRON dealer. Only authorized CRESTRON dealers may contact the factory and request an RMA (Return Merchandise Authorization) number. Enclose a note specifying the nature of the problem, name and phone number of contact person, RMA number and return address.
2. Products may be returned for credit, exchange or service with a CRESTRON Return Merchandise Authorization (RMA) number. Authorized returns must be shipped freight prepaid to CRESTRON, 6 Volvo Drive, Rockleigh, N.J. or its authorized subsidiaries, with RMA number clearly marked on the outside of all cartons. Shipments arriving freight collect or without an RMA number shall be subject to refusal. CRESTRON reserves the right in its sole and absolute discretion to charge a 15% restocking fee plus shipping costs on any products returned with an RMA.
3. Return freight charges following repair of items under warranty shall be paid by CRESTRON, shipping by standard ground carrier. In the event repairs are found to be non-warranty, return freight costs shall be paid by the purchaser.

CRESTRON Limited Warranty

CRESTRON ELECTRONICS, Inc. warrants its products to be free from manufacturing defects in materials and workmanship under normal use for a period of three (3) years from the date of purchase from CRESTRON, with the following exceptions: disk drives and any other moving or rotating mechanical parts, pan/tilt heads and power supplies are covered for a period of one (1) year; touchscreen display and overlay components are covered for 90 days; batteries and incandescent lamps are not covered.

This warranty extends to products purchased directly from CRESTRON or an authorized CRESTRON dealer. Purchasers should inquire of the dealer regarding the nature and extent of the dealer's warranty, if any.

CRESTRON shall not be liable to honor the terms of this warranty if the product has been used in any application other than that for which it was intended or if it has been subjected to misuse, accidental damage, modification or improper installation procedures. Furthermore, this warranty does not cover any product that has had the serial number altered, defaced or removed.

This warranty shall be the sole and exclusive remedy to the original purchaser. In no event shall CRESTRON be liable for incidental or consequential damages of any kind (property or economic damages inclusive) arising from the sale or use of this equipment. CRESTRON is not liable for any claim made by a third party or made by the purchaser for a third party.

CRESTRON shall, at its option, repair or replace any product found defective, without charge for parts or labor. Repaired or replaced equipment and parts supplied under this warranty shall be covered only by the unexpired portion of the warranty.

Except as expressly set forth in this warranty, CRESTRON makes no other warranties, expressed or implied, nor authorizes any other party to offer any warranty, including any implied warranties of merchantability or fitness for a particular purpose. Any implied warranties that may be imposed by law are limited to the terms of this limited warranty. This warranty statement supersedes all previous warranties.

Trademark Information

All brand names, product names and trademarks are the sole property of their respective owners. Windows is a registered trademark of Microsoft Corporation. Windows95/98/Me/XP/Vista/7 and WindowsNT/2000 are trademarks of Microsoft Corporation.

Free Manuals Download Website

<http://myh66.com>

<http://usermanuals.us>

<http://www.somanuals.com>

<http://www.4manuals.cc>

<http://www.manual-lib.com>

<http://www.404manual.com>

<http://www.luxmanual.com>

<http://aubethermostatmanual.com>

Golf course search by state

<http://golfingnear.com>

Email search by domain

<http://emailbydomain.com>

Auto manuals search

<http://auto.somanuals.com>

TV manuals search

<http://tv.somanuals.com>