

Dell PowerEdge FC630 Owner's Manual

Regulatory Model: E02B
Regulatory Type: E02B004



Notes, Cautions, and Warnings

 **NOTE:** A NOTE indicates important information that helps you make better use of your computer.

 **CAUTION:** A CAUTION indicates either potential damage to hardware or loss of data and tells you how to avoid the problem.

 **WARNING:** A WARNING indicates a potential for property damage, personal injury, or death.

Copyright © 2014 Dell Inc. All rights reserved. This product is protected by U.S. and international copyright and intellectual property laws. Dell™ and the Dell logo are trademarks of Dell Inc. in the United States and/or other jurisdictions. All other marks and names mentioned herein may be trademarks of their respective companies.

2014 - 09

Rev. A00

Contents

1 About your system.....	7
Front-panel features and indicators.....	7
Using USB diskette or USB DVD/CD drives.....	8
Hard-drive/SSD indicator patterns.....	8
iDRAC Direct LED indicator codes.....	9
Documentation matrix.....	11
Quick Resource Locator.....	12
2 Performing initial system configuration.....	13
Setting up your system.....	13
Setting up and configuring the iDRAC IP address.....	13
Logging in to iDRAC.....	14
Installing the operating system.....	14
Managing your system remotely.....	14
Downloading and installing drivers and firmware.....	14
3 Pre-operating system management applications.....	16
Navigation keys.....	16
About System Setup.....	16
Entering System Setup.....	17
System Setup Main Menu.....	17
System BIOS screen.....	17
System Information screen.....	18
System Memory screen.....	18
Processor Settings screen.....	19
SATA Settings screen.....	20
Boot Settings screen.....	23
Network Settings screen.....	23
Integrated Devices screen.....	24
Serial Communication screen.....	25
System Profile Settings screen.....	26
System Security Settings screen.....	27
Miscellaneous Settings screen.....	28
About Boot Manager.....	30
Entering Boot Manager	30
Boot Manager main menu.....	30
About Dell Lifecycle Controller.....	30
Changing the boot order.....	30

Choosing the system boot mode.....	31
Assigning a system and/or setup password.....	31
Using your system password to secure your system.....	32
Deleting or changing an existing system and/or setup password.....	32
Operating with a setup password enabled.....	33
Embedded systems management.....	33
iDRAC Settings utility.....	33
Entering the iDRAC Settings utility.....	34

4 Installing and removing sled components..... 35

Safety instructions.....	35
Before working inside your system.....	35
After working inside your system.....	35
Recommended tools.....	35
Removing and installing a sled.....	36
Removing the sled.....	36
Installing the sled.....	38
Inside the sled.....	39
Cooling shroud.....	40
Removing the cooling shroud.....	40
Installing the cooling shroud.....	41
Processor/DIMM blank.....	41
Removing a processor/DIMM blank.....	41
Installing a processor/DIMM blank.....	42
System memory.....	43
General memory-module installation guidelines.....	45
Mode-specific guidelines.....	46
Sample memory configurations.....	47
Removing memory modules.....	49
Installing memory modules.....	50
PCIe mezzanine card.....	51
Removing a PCIe mezzanine card.....	51
Installing a PCIe mezzanine card.....	53
IDSDM card (optional).....	53
Replacing an SD card.....	53
Internal USB key.....	55
Removing the IDSDM card.....	57
Installing the IDSDM card.....	58
rSPI card (optional).....	59
Removing the rSPI card.....	59
Installing the rSPI card.....	60
SD vFlash card.....	60

Replacing the SD vFlash card.....	60
Network Daughter Card.....	61
Removing the Network Daughter Card.....	61
Installing the Network Daughter Card.....	63
Processors.....	63
Removing a processor.....	64
Installing a processor.....	67
Hard drives/SSDs.....	70
Hard-drive/SSD bay numbering.....	70
Hard drive/SSD installation guidelines.....	70
Removing a hard drive/SSD.....	71
Installing a hard drive/SSD.....	72
Removing a hard-drive/SSD blank.....	72
Installing a hard-drive/SSD blank.....	74
Shutdown procedure for servicing a hard drive/SSD.....	74
Configuring the boot drive.....	74
Removing a 2.5 inch hard drive/SSD from a 2.5 inch hard-drive/SSD carrier.....	74
Installing a 2.5 inch hard drive/SSD in a 2.5 inch hard-drive/SSD carrier.....	75
Removing a 1.8 inch SSD from a 1.8 inch SSD carrier	76
Installing a 1.8 inch SSD in a 1.8 inch SSD carrier.....	77
Removing the hard-drive/SSD cage.....	77
Installing the hard-drive/SSD cage.....	78
Hard-drive backplane.....	79
Removing the hard-drive/SSD backplane.....	79
Installing the hard-drive/SSD backplane.....	81
PERC H730P slim card.....	82
Removing a PERC H730P slim card.....	82
Installing a PERC H730P slim card.....	83
Storage controller card.....	84
Removing the PCIe extender/storage controller card.....	84
Installing the PCIe extender/storage controller card.....	86
NVRAM backup battery.....	87
Replacing the NVRAM backup battery.....	87
System board.....	89
Removing the system board.....	89
Installing the system board.....	92
Trusted Platform Module.....	94
Installing the Trusted Platform Module	94
Re-enabling the TPM for BitLocker users.....	95
Re-enabling the TPM for TXT users.....	95

5 Troubleshooting your system..... 96

Safety first—for you and your system.....	96
Troubleshooting system memory.....	96
Troubleshooting hard drives.....	97
Troubleshooting USB devices.....	97
Troubleshooting Solid State Drives.....	98
Troubleshooting an internal SD card.....	99
Troubleshooting processors.....	99
Troubleshooting the system board.....	100
Troubleshooting the NVRAM backup battery.....	100
System messages.....	101
Warning messages.....	101
Diagnostic messages.....	101
Alert messages.....	101
6 Using System Diagnostics.....	102
Dell Embedded System Diagnostics.....	102
When to use the Embedded System Diagnostics.....	102
Running the Embedded System Diagnostics.....	102
Running Embedded System Diagnostics from an external media.....	103
System diagnostics controls.....	103
7 Jumpers and connectors.....	104
System board jumper settings.....	104
System board connectors.....	105
Disabling a forgotten password.....	106
8 Technical specifications.....	107
9 Getting help.....	112
Contacting Dell.....	112
Documentation feedback.....	112
Locating your system Service Tag.....	112
Quick Resource Locator.....	112

About your system

Front-panel features and indicators

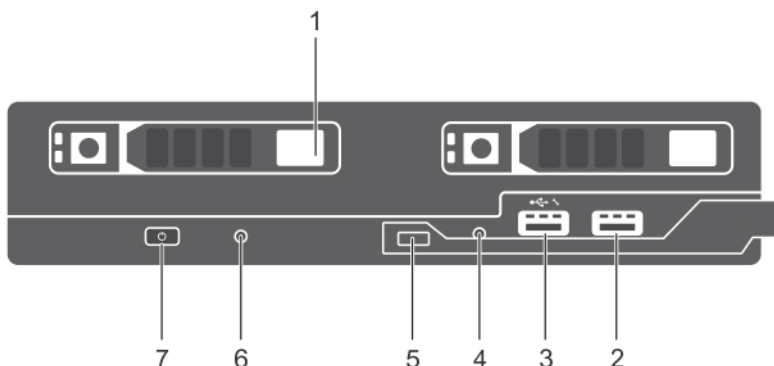

Figure 1. Front-panel features and indicators—2.5 inch hard-drive/SSD system

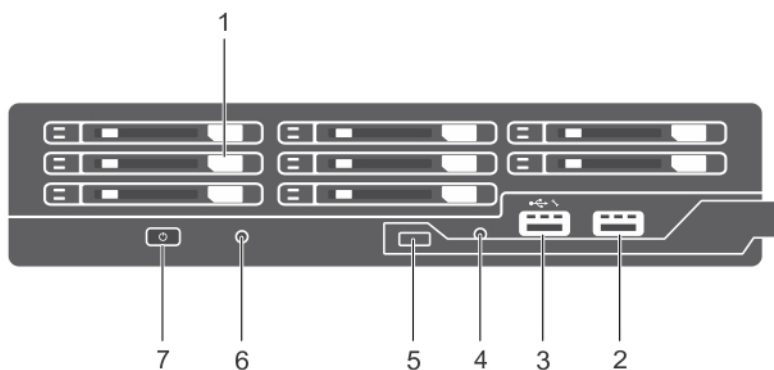





Figure 2. Front-panel features and indicators—1.8 inch SSD system

Item	Indicator, Button, or Connector	Icon	Description
1	Hard drives/SSDs		2.5 inch hard-drive system Two 2.5 inch hot-swap SAS/SATA hard drives or SAS/SATA/PCIe SSDs.

Item	Indicator, Button, or Connector	Icon	Description
			1.8 inch SSD system Eight 1.8 inch hot-swap SATA SSDs.
2	USB management port		Allows a USB device to be connected to the system.
3	USB management port/iDRAC Direct port		The USB management port can function as a regular USB port or provide access to the iDRAC features. For more information, see the iDRAC User's Guide at dell.com/esmanuals .
4	iDRAC Direct LED indicator		The management indicator lights when the iDRAC controls the USB1 port for management functions.
5	Sled handle		Used to slide the sled out of the enclosure.
6	Status indicator		Provides information about the status of the system.
7	Sled power-on indicator, power button		The power-on indicator lights when the sled power is on. The power button controls the power supply output to the system.

Using USB diskette or USB DVD/CD drives

The sled has USB ports on the front which allow you to connect a USB diskette drive, USB flash drive, USB DVD/CD drive, keyboard, or mouse. The USB drives can be used to configure the sled.

To designate the USB diskette drive as the boot drive:

1. connect the USB drive
2. restart the system
3. enter the System Setup
4. set the drive as first in the boot sequence

The USB device is displayed in the boot order setup screen only if it is attached to the system before you run the System Setup. You can also select the boot device by pressing <F11> during system start-up and selecting a boot device for the current boot sequence.

Hard-drive/SSD indicator patterns

The hard-drive/SSD (Solid State Drives) indicators display different patterns as drive events occur in the system.

 **NOTE:** The sled must have a hard-drive/SSD or a hard-drive blank installed in each drive bay.

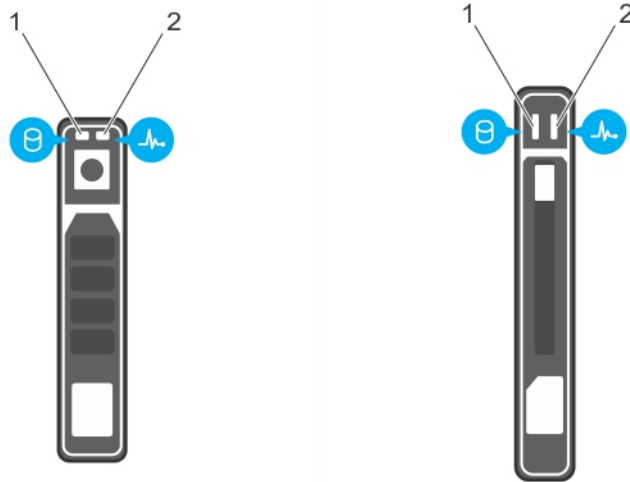

Figure 3. Hard-drive/SSD indicators

1. drive activity indicator (green)
2. drive status indicator (green and amber)

NOTE: If the drive is in Advanced Host Controller Interface (AHCI) mode, the status LED (on the right side) does not function and remains off.

Drive-Status Indicator Pattern	Condition
Blinks green two times per second	Identifying drive or preparing for removal
Off	Drive ready for insertion or removal NOTE: The drive status indicator remains off until all drives are initialized after system power is applied. Drives are not ready for insertion or removal during this time.
Blinks green, amber, and then turns off	Drive predicted failure
Blinks amber four times per second	Drive failed
Blinks green slowly	Drive rebuilding
Steady green	Drive online
Blinks green three seconds, amber three seconds, and off six seconds	Rebuild aborted

iDRAC Direct LED indicator codes

NOTE: The iDRAC Direct LED indicator does not light up for the USB mode.

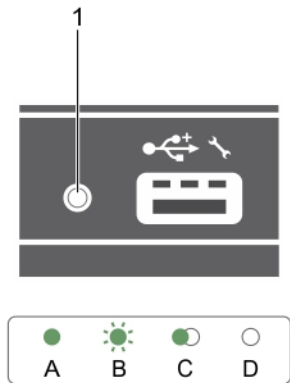

Figure 4. iDRAC Direct LED indicator

1. iDRAC Direct status indicator

The table below displays iDRAC Direct activity when configuring iDRAC Direct by using the management port (USB XML Import).

Convention	iDRAC Direct LED indicator pattern	Condition
A	Steady green	Lights green for a minimum of 2 seconds at the beginning and end of a file transfer.
B	Flashing green	Indicates file transfer or any operation tasks.
C	Green and turns off	Indicates that the file transfer is complete.
D	Turn off	Indicates that the USB is ready to be removed or that a task is complete.

The table below displays iDRAC Direct activity when configuring iDRAC Direct using your laptop and cable (Laptop Connect).

iDRAC Direct LED indicator pattern	Condition
Steady green for two seconds	Indicates that the system is connected.
Flashing green (on for two seconds and off for two seconds)	Indicates that the system connected is recognized.
Turns off	Indicates that the system is unplugged.

Documentation matrix

The documentation matrix provides information about documents that you can refer to, for setting up and managing your system.

To...	Refer to...
Set up your system and know the system technical specifications	Getting Started With Your System
Install the operating system	Operating system documentation at dell.com/operatingsystemmanuals
Get an overview of the Dell Systems Management offerings	Dell OpenManage Systems Management Overview Guide at dell.com/openmanagemanuals
Configure and log in to iDRAC, set up managed and management system, know the iDRAC features, and troubleshoot using iDRAC	Integrated Dell Remote Access Controller User's Guide at dell.com/esmmanuals
Know about the RACADM subcommands and supported RACADM interfaces	RACADM Command Line Reference Guide for iDRAC and CMC at dell.com/esmmanuals
Start, enable, and disable Lifecycle Controller, know the features, use, and troubleshoot Lifecycle Controller	Dell Lifecycle Controller User's Guide at dell.com/esmmanuals
Use Lifecycle Controller Remote Services	Dell Lifecycle Controller Remote Services Quick Start Guide at dell.com/esmmanuals
Set up, use, and troubleshoot OpenManage Server Administrator	Dell OpenManage Server Administrator User's Guide at dell.com/openmanagemanuals
Install, use and troubleshoot OpenManage Essentials	Dell OpenManage Essentials User's Guide at dell.com/openmanagemanuals
Know the system features, remove and install system components, and troubleshoot components	Owner's Manual at dell.com/poweredgemanuals
Know the enclosure features, remove and install enclosure components, and troubleshoot enclosure components	Enclosure Owner's Manual at dell.com/poweredgemanuals
Know the features of the storage controller cards, deploy the cards, and manage the storage subsystem	Storage controller documentation at dell.com/storagecontrollermanuals
See the event and error messages generated by the system firmware and agents that monitor system components	Dell Event and Error Messages Reference Guide at dell.com/esmmanuals

Quick Resource Locator

Use the Quick Resource Locator (QRL) to get immediate access to system information and how-to videos. This can be done by visiting dell.com/QRL or by using your smartphone and a model specific Quick Resource (QR) code located on your Dell PowerEdge system. To try out the QR code, scan the following image.



Performing initial system configuration

After you receive your PowerEdge system, you must set up your system in the enclosure, install the operating system if it is not pre-installed, and set up and configure the system iDRAC IP address.

Setting up your system

1. Unpack the sled.
2. Remove the I/O connector cover from the sled connectors.

 **CAUTION:** While installing the sled, ensure that it is properly aligned with the slot on the enclosure, to prevent damage to the sled connectors.

3. Install the sled in the enclosure.
4. Turn on the enclosure.

 **NOTE:** Wait for the chassis to initialize before you press the power button.

5. Turn on the sled by pressing the power button on the sled.
Alternatively, you can also turn on the sled by using:
 - The sled iDRAC. For more information, see [Logging in to iDRAC](#).
 - The enclosure Chassis Management Controller (CMC), after the sled iDRAC is configured on the CMC. For more information, see the CMC User's Guide at dell.com/esmmanuals.

Related Links

[Installing the sled](#)

Setting up and configuring the iDRAC IP address

You can set up the iDRAC IP address using one of the following interfaces:

- iDRAC Settings utility
- Dell Lifecycle Controller
- Dell Deployment Toolkit
- CMC Web interface

You can configure iDRAC using one of the following interfaces:

- iDRAC Web interface
- RACADM
- Remote services
- IPMI tool

For more information on setting up and configuring iDRAC, see the iDRAC User's Guide at dell.com/esmmanuals.

Logging in to iDRAC

You can log in to iDRAC as an iDRAC user, a Microsoft Active Directory user, or a Lightweight Directory Access Protocol (LDAP) user. You can also log in using Single Sign-On or Smart Card. The default user name is `root` and password is `calvin`. For more information on logging in to iDRAC and iDRAC licenses, see the iDRAC User's Guide at dell.com/esmmanuals.

You can also access iDRAC using RACADM. For more information, see the *RACADM Reference Guide for iDRAC and CMC* available at dell.com/esmmanuals.

Installing the operating system

You can install the supported operating system on the sled by using the following methods:

- Dell Systems Management Tools and Documentation media. See the operating system documentation at dell.com/operatingsystemmanuals.
- Dell Lifecycle Controller. See the Lifecycle Controller documentation at dell.com/esmmanuals.
- Dell OpenManage Deployment Toolkit. See the OpenManage documentation at dell.com/openmanagemanuals.

For information on the list of operating systems supported on your system, see the operating systems support matrix at dell.com/ossupport.

Managing your system remotely

To perform out-of-band systems management using iDRAC, you must configure iDRAC for remote accessibility, set up the management station and managed system, and configure the supported Web browsers. For more information, see the iDRAC User's Guide at dell.com/esmmanuals.

You can also remotely monitor and manage the sleds from a single workstation, using the Dell OpenManage Server Administrator (OMSA) software and OpenManage Essentials (OME) systems management console. For more information, see dell.com/openmanagemanuals.

Downloading and installing drivers and firmware

It is recommended that you download and install the latest BIOS, drivers, and systems management firmware on your system.

Prerequisites

Ensure that you clear the web browser cache.

Steps

1. Go to dell.com/support/drivers.
2. In the **Product Selection** section, enter the Service Tag of your system in the **Service Tag or Express Service Code** field.

 **NOTE:** If you do not have the Service Tag, select **Automatically detect my Service Tag for me** to allow the system to automatically detect your Service Tag, or select **Choose from a list of all Dell products** to select your product from the **Product Selection** page.

3. Click **Get drivers and downloads**.

The drivers that are applicable to your selection are displayed.

4. Download the drivers you require to a diskette drive, USB drive, CD, or DVD.

Pre-operating system management applications

The pre-operating system management applications for your PowerEdge system help you manage different settings and features of your system without booting to the operating system.

Your PowerEdge system has the following pre-operating system management applications:

- System Setup
- Boot Manager
- Dell Lifecycle Controller

Navigation keys

The navigation keys can help you access the pre-operating system management applications.

Key	Description
<Page Up>	Moves to the previous screen.
<Page Down>	Moves to the next screen.
Up arrow	Moves to the previous field.
Down arrow	Moves to the next field.
<Enter>	Enables you to type a value in the selected field (if applicable) or follow the link in the field.
Spacebar	Expands or collapses a drop-down list, if applicable.
<Tab>	Moves to the next focus area.
	 NOTE: This feature is applicable for the standard graphical browser only.
<Esc>	Moves to the previous page until you view the main screen. Pressing <Esc> in the main screen exits System BIOS/iDRAC Settings/Device Settings/Service Tag Settings and proceeds with system boot.
<F1>	Displays the System Setup help.

About System Setup

Using System Setup, you can configure the BIOS settings, iDRAC settings, and device settings of your system.

You can access System Setup in two ways:

- Standard Graphical Browser — This is enabled by default.
- Text Browser — This is enabled using Console Redirection.

 **NOTE:** By default, help text for the selected field is displayed in the graphical browser. To view the help text in the text browser, press <F1>.

Entering System Setup

1. Turn on or restart your system.
2. Press <F2> immediately after you see the following message:
<F2> = System Setup

If your operating system begins to load before you press <F2>, allow the system to finish booting, and then restart your system and try again.

System Setup Main Menu

Option	Description
System BIOS	Enables you to configure BIOS settings.
iDRAC Settings	Enables you to configure iDRAC settings. The iDRAC Settings utility is an interface to set up and configure the iDRAC parameters by using UEFI. You can enable or disable various iDRAC parameters by using the iDRAC Settings utility. For more information about this utility, see the Integrated Dell Remote Access Controller User's Guide at dell.com/esmmanuals .
Device Settings	Enables you to configure device settings.

System BIOS screen

You can use the **System BIOS** screen to view BIOS settings as well as edit specific functions such as boot order, system password, setup password, setting RAID mode, and enabling or disabling USB ports. In the **System Setup Main Menu**, click **System BIOS**.

Menu Item	Description
System Information	Displays information about the system such as the system model name, BIOS version and Service Tag.
Memory Settings	Displays information and options related to the installed memory.
Processor Settings	Displays information and options related to the processor such as speed, cache size, and so on.
SATA Settings	Displays options to enable or disable the integrated SATA controller and ports.
Boot Settings	Displays options to specify the boot mode (BIOS or UEFI). Enables you to modify UEFI and BIOS boot settings.
Network Settings	Displays options to change the network settings.
Integrated Devices	Displays options to enable or disable integrated device controllers and ports, and to specify related features and options.

Menu Item	Description
Serial Communication	Displays options to enable or disable the serial ports and specify related features and options.
System Profile Settings	Displays options to change the processor power management settings, memory frequency, and so on.
System Security	Displays options to configure the system security settings like, system password, setup password, TPM security, and so on. It also enables or disables support for the power and NMI buttons on the system.
Miscellaneous Settings	Displays options to change the system date, time, and so on.

System Information screen

You can use the **System Information** screen to view system properties such as Service Tag, system model, and the BIOS version.

You can view the **System Information** screen by clicking **System Setup Main Menu** → **System BIOS** → **System Information**.



Menu Item	Description
System Model Name	Displays the system model name.
System BIOS Version	Displays the BIOS version installed on the system.
System Management Engine Version	Displays the current revision of the Management Engine firmware.
System Service Tag	Displays the system Service Tag.
System Manufacturer	Displays the name of the system manufacturer.
System Manufacturer Contact Information	Displays the contact information of the system manufacturer.
System CPLD Version	Displays the current revision of the system CPLD firmware.
UEFI Compliance Version	Displays the system firmware UEFI compliance level.

System Memory screen

System Memory screen allows you to view all the memory settings as well as enable or disable specific memory functions such as system memory testing and node interleaving.

In the **System Setup Main Menu**, click **System BIOS** → **System Memory**.

Menu Item	Description
System Memory Size	Displays the amount of memory installed in the system.
System Memory Type	Displays the type of memory installed in the system.
System Memory Speed	Displays the system memory speed.
System Memory Voltage	Displays the system memory voltage.
Video Memory	Displays the amount of video memory.
System Memory Testing	Specifies whether system memory tests are run during system boot. Options are Enabled and Disabled . By default, the System Memory Testing option is set to Disabled .



Menu Item	Description
Memory Operating Mode	<p>Specifies the memory operating mode. The options available are Optimizer Mode, Advanced ECC Mode, Mirror Mode, Spare Mode, Spare with Advanced ECC Mode, and Dell Fault Resilient Mode. By default, the Memory Operating Mode option is set to Optimizer Mode.</p> <p> NOTE: The Memory Operating Mode can have different defaults and available options based on the memory configuration of your system.</p> <p> NOTE: The Dell Fault Resilient Mode establishes an area of memory that is fault resilient. This mode can be used by an operating system that supports the feature to load critical applications or enables the operating system kernel to maximize system availability.</p>
Node Interleaving	<p>If this field is Enabled, memory interleaving is supported if a symmetric memory configuration is installed. If Disabled, the system supports Non-Uniform Memory architecture (NUMA) (asymmetric) memory configurations. By default, Node Interleaving option is set to Disabled.</p>
Snoop Mode	<p>Snoop Mode options available are Disabled, Home Snoop, Early Snoop, Cluster on Die. By default, the Snoop Mode option is set to Disabled. The field is only available when Node Interleaving is Disabled.</p>

Processor Settings screen

You can use the **Processor Settings** screen to view the processor settings and perform specific functions such as enabling virtualization technology, hardware prefetcher, and logical processor idling.

You can view the **Processor Settings** screen by clicking **System Setup Main Menu** → **System BIOS** → **Processor Settings**.

Menu Item	Description
Logical Processor	<p>Enables or disables the logical processors and displays the number of logical processors. If the Logical Processor option is set to Enabled, the BIOS displays all the logical processors. If this option is set to Disabled, the BIOS only displays one logical processor per core. By default, the Logical Processor option is set to Enabled.</p>
Alternate RTID (Requestor Transaction ID) Setting	<p>Enables you to allocate more RTIDs to the remote socket, thereby increasing cache performance between the sockets or easing work in normal mode for NUMA. By default, the Alternate RTID (Requestor Transaction ID) Setting is set to Disabled.</p>
Virtualization Technology	<p>Enables or disables the additional hardware capabilities provided for virtualization. By default, the Virtualization Technology option is set to Enabled.</p>
Address Translation Service (ATS)	<p>Defines the Address Translation Cache (ATC) for devices to cache the DMA transactions. This field provides an interface to a chipset's Address Translation and Protection Table to translate DMA addresses to host addresses. By default, the option is set to Enabled.</p>
Adjacent Cache Line Prefetch	<p>Optimizes the system for applications that require high utilization of sequential memory access. By default, the Adjacent Cache Line Prefetch option is set to Enabled. You can disable this option for applications that require high utilization of random memory access.</p>

Menu Item	Description
Hardware Prefetcher	Enables or disables the hardware prefetcher. By default, the Hardware Prefetcher option is set to Enabled .
DCU Streamer Prefetcher	Allows you to enable or disable the Data Cache Unit (DCU) streamer prefetcher. By default, the DCU Streamer Prefetcher option is set to Enabled .
DCU IP Prefetcher	Enables or disables the Data Cache Unit (DCU) IP prefetcher. By default, the DCU IP Prefetcher option is set to Enabled .
Execute Disable	Enables or disables the execute disable memory protection technology. By default, the Execute Disable option is set to Enabled .
Logical Processor Idling	Enables or disables the operating system capability to put logical processors in the idling state in order to reduce power consumption. By default, the option is set to Disabled .
Configurable TDP	Allows reconfiguration of Thermal Design Power (TDP) to lower levels. TDP refers to the maximum amount of power the cooling system is required to dissipate.
X2Apic Mode	Enables or disables the X2Apic mode.
Dell Controlled Turbo	 NOTE: Depending on the number of installed CPUs, there may be up to four processor listings. Controls the turbo engagement. Enable this option only when System Profile is set to Performance .
Number of Cores per Processor	Controls the number of enabled cores in each processor. By default, the Number of Cores per Processor option is set to All .
Processor 64-bit Support	Specifies if the processor(s) support 64-bit extensions.
Processor Core Speed	Displays the maximum core frequency of the processor.
Processor 1	 NOTE: Depending on the number of installed CPUs, there may be up to four processor listings. The following settings are displayed for each processor installed in the system.
Family-Model-Stepping	Displays the family, model and stepping of the processor as defined by Intel.
Brand	Displays the brand name reported by the processor.
Level 2 Cache	Displays the total L2 cache.
Level 3 Cache	Displays the total L3 cache.
Number of Cores	Displays the number of cores per processor.

SATA Settings screen

You can use the **SATA Settings** screen to view the SATA settings of SATA devices and enable RAID on your system.

You can view the **SATA Settings** screen by clicking **System Setup Main Menu** → **System BIOS** → **SATA Settings**.

Menu Item	Description
Embedded SATA	Enables the embedded SATA to be set to Off , ATA , AHCI , or RAID modes. By default, the Embedded SATA option is set to AHCI .
Security Freeze Lock	Sends Security Freeze Lock command to the Embedded SATA drives during POST. This option is applicable only to ATA and AHCI mode.
Write Cache	Enables or disables the command for Embedded SATA drives during POST.
Port A	Sets the drive type of the selected device. For Embedded SATA settings in ATA mode, set this field to Auto to enable BIOS support. Set it to OFF to turn off BIOS support. For AHCI mode or RAID mode, BIOS always enables support.
Model	Displays the drive model of the selected device.
Drive Type	Displays the type of drive attached to the SATA port.
Capacity	Displays the total capacity of the hard drive. The field is undefined for removable media devices such as optical drives.
Port B	Sets the drive type of the selected device. For Embedded SATA settings in ATA mode, set this field to Auto to enable BIOS support. Set it to OFF to turn off BIOS support. For AHCI mode or RAID mode, BIOS always enables support.
Model	Displays the drive model of the selected device.
Drive Type	Displays the type of drive attached to the SATA port.
Capacity	Displays the total capacity of the hard drive. The field is undefined for removable media devices such as optical drives.
Port C	Sets the drive type of the selected device. For Embedded SATA settings in ATA mode, set this field to Auto to enable BIOS support. Set it to OFF to turn off BIOS support. For AHCI mode or RAID mode, BIOS always enables support.
Model	Displays the drive model of the selected device.
Drive Type	Displays the type of drive attached to the SATA port.
Capacity	Displays the total capacity of the hard drive. The field is undefined for removable media devices such as optical drives.
Port D	Sets the drive type of the selected device. For Embedded SATA settings in ATA mode, set this field to Auto to enable BIOS support. Set it to OFF to turn off BIOS support. For AHCI mode or RAID mode, BIOS always enables support.
Model	Displays the drive model of the selected device.
Drive Type	Displays the type of drive attached to the SATA port.
Capacity	Displays the total capacity of the hard drive. The field is undefined for removable media devices such as optical drives.



Menu Item	Description
Port E	Sets the drive type of the selected device. For Embedded SATA settings in ATA mode, set this field to Auto to enable BIOS support. Set it to OFF to turn off BIOS support. For AHCI mode or RAID mode, BIOS always enables support.
Model	Displays the drive model of the selected device.
Drive Type	Displays the type of drive attached to the SATA port.
Capacity	Displays the total capacity of the hard drive. The field is undefined for removable media devices such as optical drives.
Port F	Sets the drive type of the selected device. For Embedded SATA settings in ATA mode, set this field to Auto to enable BIOS support. Set it to OFF to turn off BIOS support. For AHCI mode or RAID mode, BIOS always enables support.
Model	Displays the drive model of the selected device.
Drive Type	Displays the type of drive attached to the SATA port.
Capacity	Displays the total capacity of the hard drive. The field is undefined for removable media devices such as optical drives.
Port G	Sets the drive type of the selected device. For Embedded SATA settings in ATA mode, set this field to Auto to enable BIOS support. Set it to OFF to turn off BIOS support. For AHCI mode or RAID mode, BIOS always enables support.
Model	Displays the drive model of the selected device.
Drive Type	Displays the type of drive attached to the SATA port.
Capacity	Displays the total capacity of the hard drive. The field is undefined for removable media devices such as optical drives.
Port H	Sets the drive type of the selected device. For Embedded SATA settings in ATA mode, set this field to Auto to enable BIOS support. Set it to OFF to turn off BIOS support. For AHCI mode or RAID mode, BIOS always enables support.
Model	Displays the drive model of the selected device.
Drive Type	Displays the type of drive attached to the SATA port.
Capacity	Displays the total capacity of the hard drive. The field is undefined for removable media devices such as optical drives.
Port I	Sets the drive type of the selected device. For Embedded SATA settings in ATA mode, set this field to Auto to enable BIOS support. Set it to OFF to turn off BIOS support. For AHCI mode or RAID mode, BIOS always enables support.
Model	Displays the drive model of the selected device.
Drive Type	Displays the type of drive attached to the SATA port.

Menu Item	Description
Capacity	Displays the total capacity of the hard drive. The field is undefined for removable media devices such as optical drives.
Port J	Sets the drive type of the selected device. For Embedded SATA settings in ATA mode, set this field to Auto to enable BIOS support. Set it to OFF to turn off BIOS support. For AHCI mode or RAID mode, BIOS always enables support.
Model	Displays the drive model of the selected device.
Drive Type	Displays the type of drive attached to the SATA port.
Capacity	Displays the total capacity of the hard drive. The field is undefined for removable media devices such as optical drives.

Boot Settings screen

You can use the **Boot Settings** screen to set the Boot mode to either **BIOS** or **UEFI**. It also allows you to specify the boot order.

You can view the **Boot Settings** screen by clicking **System Setup Main Menu** → **System BIOS** → **Boot Settings**.

Menu Item	Description
Boot Mode	<p>Enables you to set the boot mode of the system.</p> <p> CAUTION: Switching the boot mode may prevent the system from booting if the operating system is not installed in the same boot mode.</p> <p> NOTE: Setting this field to UEFI disables the BIOS Boot Settings menu. Setting this field to BIOS disables the UEFI Boot Settings menu.</p> <p>If the operating system supports UEFI, you can set this option to UEFI. Setting this field to BIOS allows compatibility with non-UEFI operating systems. By default, the Boot Mode option is set to BIOS.</p>
Boot Sequence Retry	Enables or disables the Boot Sequence Retry feature. If this field is enabled and the system fails to boot, the system reattempts the boot sequence after 30 seconds. By default, the Boot Sequence Retry option is set to Enabled .
Hard-Disk Failover	Specifies which devices in the Hard-Disk Drive Sequence are attempted in the boot sequence. When the option is Disabled , only the first hard disk device in the list is attempted to boot. When set to Enabled , all hard disk devices are attempted in order, as listed in the Hard-Disk Drive Sequence . This option is not enabled for UEFI Boot Mode.
Boot Option Settings	Configures the boot sequence and the boot devices.

Network Settings screen

You can use the **Network Settings** screen to modify PXE device settings. Network Settings are only available in UEFI boot mode. BIOS does not control network settings in the BIOS boot mode. For BIOS boot mode, the network settings are handled by the network controllers option ROM.



You can view the **Network Settings** screen by clicking **System Setup Main Menu** → **System BIOS** → **Network Settings**.

Menu Item	Description
PXE Device n (n = 1 to 4)	Enables or disables the device. When enabled, a UEFI boot option is created for the device.
PXE Device n Settings (n = 1 to 4)	Allows you to control the configuration of the PXE device.

Integrated Devices screen

Integrated Devices screen allows you to view and configure the settings of all integrated devices including the video controller, integrated RAID controller, and the USB ports.





In the **System Setup Main Menu**, click **System BIOS** → **Integrated Devices**.

Menu Item	Description
USB 3.0 Setting	Allows you to enable or disable the USB 3.0 support. Enable this option only if your operating system support USB 3.0. Disabling this allows devices to operate at USB 2.0 speed. USB 3.0 is disabled by default.
User Accessible USB Ports	Allows you to enable or disable the USB ports. Selecting Only Back Ports On disables the front USB ports, selecting All Ports Off disables all USB ports. The USB keyboard and mouse operates during boot process in certain operating systems. After the boot process is complete, the USB keyboard and mouse does not work if the ports are disabled.  NOTE: Selecting Only Back Ports On and All Ports Off will disable the USB management port and also restrict access to iDRAC features.
Internal USB Port	Allows you to enable or disable the internal USB port.
Integrated RAID Controller	Allows you to enable or disable the integrated RAID controller.  NOTE: This feature is not supported for the PowerEdge T630 system.
Integrated Network Card 1	Allows you to enable or disable the integrated network card.
I/OAT DMA Engine	Allows you to enable or disable the I/OAT option. Enable only if the hardware and software supports the feature.
Embedded Video Controller	Allows you to enable or disable the Embedded Video Controller . By default, the embedded video controller is Enabled . Current state of Embedded Video Controller is Enabled . Current State of Embedded Video Controller is a read only field, indicating the current state for the Embedded Video Controller. If the Embedded Video Controller is the only display capability in the system (that is, no add-in graphics card is installed), then the Embedded Video Controller is automatically used as the primary display even if the Embedded Video Controller setting is Disabled .
SR-IOV Global Enable	Allows you to enable or disable the BIOS configuration of Single Root I/O Virtualization (SR-IOV) devices. By default, the SR-IOV Global Enable option is set to Disabled .
OS Watchdog Timer	If your system stops responding, this watchdog timer aids in the recovery of your operating system. When this field is set to Enabled , the operating system is allowed to initialize the timer. When is set to Disabled (the default), the timer will have no effect on the system.

Menu Item	Description
Memory Mapped I/O above 4GB	Allows you to enable support for PCIe devices that require large amounts of memory. By default, the option is set to Enabled .

Serial Communication screen

You can use the **Serial Communication** screen to view the properties of the serial communication port. You can view the **Serial Communication** screen by clicking **System Setup Main Menu** → **System BIOS** → **Serial Communication**.



Menu Item	Description
Serial Communication	Selects serial communication devices (Serial Device 1 and Serial Device 2) in the BIOS. BIOS console redirection can also be enabled and the port address can be specified. By default, Serial Communication option is set to Auto .
Serial Port Address	<p>Enables you to set the port address for serial devices. By default, the Serial Port Address option is set to Serial Device 1=COM2, Serial Device 2=COM1</p> <p> NOTE: You can use only Serial Device 2 for the Serial Over LAN (SOL) feature. To use console redirection by SOL, configure the same port address for console redirection and the serial device.</p> <p> NOTE: Every time the system boots, the BIOS syncs the serial MUX setting saved in iDRAC. The serial MUX setting can independently be changed in iDRAC. Therefore, loading the BIOS default settings from within the BIOS setup utility may not always revert this setting to the default setting of Serial Device 1.</p>
External Serial Connector	<p>You can associate the External Serial Connector to Serial Device 1, Serial Device 2, or the Remote Access Device using this field.</p> <p> NOTE: Only Serial Device 2 can be used for (Serial Over LAN) SOL. To use console redirection by SOL, configure the same port address for console redirection and the serial device.</p> <p> NOTE: Every time the system boots, the BIOS syncs the serial MUX setting saved in iDRAC. The serial MUX setting can independently be changed in iDRAC. Therefore, loading the BIOS default settings from within the BIOS setup utility may not always revert this setting to the default setting of Serial Device 1.</p>
Failsafe Baud Rate	Displays the failsafe baud rate for console redirection. The BIOS attempts to determine the baud rate automatically. This failsafe baud rate is used only if the attempt fails, and the value must not be changed. By default, the Failsafe Baud Rate option is set to 115200 .
Remote Terminal Type	Sets the remote console terminal type. By default, the Remote Terminal Type option is set to VT 100/VT 220 .
Redirection After Boot	Enables or disables the BIOS console redirection when the operating system is loaded. By default, the Redirection After Boot option is set to Enabled .

System Profile Settings screen

You can use the **System Profile Settings** screen to enable specific system performance settings such as power management.

You can view the **System Profile Settings** screen by clicking **System Setup Main Menu** → **System BIOS** → **System Profile Settings**.



Menu Item	Description
System Profile	<p>Sets the system profile. If you set the System Profile option to a mode other than Custom, the BIOS automatically sets the rest of the options. You can only change the rest of the options if the mode is set to Custom. By default, the System Profile option is set to Performance Per Watt Optimized (DAPC). DAPC is Dell Active Power Controller.</p> <p> NOTE: The following parameters are available only when the System Profile is set to Custom.</p>
CPU Power Management	<p>Sets the CPU power management. By default, the CPU Power Management option is set to System DBPM (DAPC). DBPM is Demand-Based Power Management.</p>
Memory Frequency	<p>Sets the speed of the system memory. You can select Maximum Performance, Maximum Reliability, or a specific speed.</p>
Turbo Boost	<p>Enables or disables the processor to operate in turbo boost mode. By default, the Turbo Boost option is set to Enabled.</p>
Energy Efficient Turbo	<p>Enables or disables the Energy Efficient Turbo. Energy Efficient Turbo (EET) is a mode of operation where a processor's core frequency is adjusted within the turbo range based on workload.</p>
C1E	<p>Enables or disables the processor to switch to a minimum performance state when it is idle. By default, the C1E option is set to Enabled.</p>
C States	<p>Enables or disables the processor to operate in all available power states. By default, the C States option is set to Enabled.</p>
Collaborative CPU Performance Control	<p>Enables or disables the CPU power management. When set to Enabled, the CPU power management is controlled by the OS DBPM and the System DBPM (DAPC). By default, the option is set to Disabled.</p>
Memory Patrol Scrub	<p>Sets the memory patrol scrub frequency. By default, the Memory Patrol Scrub option is set to Standard.</p>
Memory Refresh Rate	<p>Sets the memory refresh rate to either 1x or 2x. By default, the Memory Refresh Rate option is set to 1x.</p>
Uncore Frequency	<p>Selects the Processor Uncore Frequency. Dynamic mode allows the processor to optimize power resources across the cores and uncore during runtime. The optimization of the uncore frequency to either save power or optimize performance is influenced by the setting of the Energy Efficiency Policy.</p>
Energy Efficient Policy	<p>Enables you to select the Energy Efficient Policy. The CPU uses the setting to manipulate the internal behavior of the processor and determines whether to target higher performance or better power savings.</p>

Menu Item	Description
Number of Turbo Boost Enabled Cores for Processor 1	 NOTE: If there are two processors installed in the system, you see an entry for Number of Turbo Boost Enabled Cores for Processor 2 . Controls the number of turbo boost enabled cores for processor 1. By default, the maximum number of cores is enabled.
Monitor/Mwait	Enables the Monitor/Mwait instructions in the processor. By default, the Monitor/Mwait option is set to Enabled for all system profiles, except Custom .  NOTE: This option can be disabled only if the C States option in Custom mode is disabled.  NOTE: When C States is enabled in Custom mode, changing the Monitor/Mwait setting does not impact system power/performance.

System Security Settings screen

System Security screen allows you to perform specific functions such as setting the system password, setup password, and disabling the power button.

In the **System Setup Main Menu**, click **System BIOS** → **System Security Settings**.

Menu Item	Description
Intel AES-NI	Improves the speed of applications by performing encryption and decryption using the Advanced Encryption Standard Instruction Set and is set to Enabled by default.
System Password	Allows you to set the system password. This option is set to Enabled by default and is read-only if the password jumper is not installed in the system.
Setup Password	Allows you to set the setup password. This option is read-only if the password jumper is not installed in the system.
Password Status	Allows you to lock the system password. By default, the Password Status option is set to Unlocked .
TPM Security	 NOTE: The TPM menu is available only when the TPM module is installed. Allows you to control the reporting mode of the Trusted Platform Module (TPM). By default, the TPM Security option is set to Off . You can only modify the TPM Status, TPM Activation, and Intel TXT fields if the TPM Status field is set to either On with Pre-boot Measurements or On without Pre-boot Measurements .
TPM Information	Allows you to change the operational state of the TPM. By default, the TPM Activation option is set to No Change .
TPM Status	Displays the TPM status.
TPM Command	 CAUTION: Clearing the TPM results in the loss of all keys in the TPM. The loss of TPM keys may affect booting to the operating system. Allows you to clear all the contents of the TPM. By default, the TPM Clear option is set to No .

Menu Item	Description
Intel TXT	Allows you to enable or disable Intel Trusted Execution Technology (TXT). To enable Intel TXT , Virtualization Technology must be enabled and TPM Security must be Enabled with Pre-boot measurements. By default, the Intel TXT option is set to Off .
Power Button	Allows you to enable or disable the power button on the front of the system. By default, the Power Button option is set to Enabled .
AC Power Recovery	Allows you to set how the system reacts after AC power is restored to the system. By default, the AC Power Recovery option is set to Last .
UEFI Variable Access	Provides varying degrees of securing UEFI variables. When set to Standard (the default) UEFI variables are accessible in the Operating System per the UEFI specification. When set to Controlled , selected UEFI variables are protected in the environment and new UEFI boot entries are forced to be at the end of the current boot order.
Secure Boot	Allows you to enable Secure Boot, where the BIOS authenticates each pre-boot image using the certificates in the Secure Boot Policy. Secure Boot is disabled by default.
Secure Boot Policy	When Secure Boot policy is Standard , the BIOS uses the system manufacturer's key and certificates to authenticate pre-boot images. When Secure Boot policy is Custom , the BIOS uses the user-defined key and certificates. Secure Boot policy is Standard by default.
Secure Boot Policy Summary	Allows you to view the list of certificates and hashes that secure boot uses to authenticated images.



Secure Boot Custom Policy Settings screen

Secure Boot Custom Policy Settings is displayed only when **Secure Boot Policy** is set to **Custom**. In the **System Setup Main Menu**, click **System BIOS** → **System Security** → **Secure Boot Custom Policy Settings**.

Menu Item	Description
Platform Key	Allows you to import, export, delete, or restore the platform key (PK).
Key Exchange Key Database	Allows you to import, export, delete, or restore entries in the Key Exchange Key (KEK) Database
Authorized Signature Database	Allows you to import, export, delete, or restore entries in the Authorized Signature Database (db).
Forbidden Signature Database	Allows you to import, export, delete, or restore entries in the Forbidden Signature Database (dbx).

Miscellaneous Settings screen

You can use the **Miscellaneous Settings** screen to perform specific functions such as updating the asset tag, and changing the system date and time. You can view the **Miscellaneous Settings** screen by clicking **System Setup Main Menu** → **System BIOS** → **Miscellaneous Settings**.

Menu Item	Description
System Time	Enables you to set the time on the system.
System Date	Enables you to set the date on the system.
Asset Tag	Displays the asset tag and enables you to modify it for security and tracking purposes.
Keyboard NumLock	<p>Enables you to set whether the system boots with the NumLock enabled or disabled. By default the Keyboard NumLock is set to On.</p> <p> NOTE: This option does not apply to 84-key keyboards.</p>
F1/F2 Prompt on Error	Enables or disables the F1/F2 prompt on error. By default, F1/F2 Prompt on Error is set to Enabled . The F1/F2 prompt also includes keyboard errors.
Load Legacy Video Option ROM	Enables you to determine whether the system BIOS loads the legacy video (INT 10H) option ROM from the video controller. Selecting Enabled in the operating system does not support UEFI video output standards. This field is only for UEFI boot mode. You cannot set this to Enabled if UEFI Secure Boot mode is enabled.
In-System Characterization	<p>This option enables or disables In-System Characterization. By default, In-System Characterization is set to Disabled. The two other options are Enabled and Enabled - No Reboot.</p> <p> NOTE: The default setting for In-System Characterization is subject to change in future BIOS releases.</p> <p>When enabled, In-System Characterization (ISC) executes during POST upon detecting relevant change(s) in system configuration to optimize system power and performance. ISC takes about 20 seconds to execute, and system reset is required for ISC results to be applied. The Enabled - No Reboot option executes ISC and continues without applying ISC results until the next time system reset occurs. The Enabled option executes ISC and forces an immediate system reset so that ISC results can be applied. It takes the system longer to be ready due to the forced system reset. When disabled, ISC does not execute.</p>

About Boot Manager

Boot Manager enables you to add, delete, and arrange boot options. You can also access System Setup and boot options without restarting the system.

Entering Boot Manager

The **Boot Manager** screen allows you to select boot options and diagnostic utilities.

1. Turn on or restart your system.
2. Press <F11> when you see the message <F11> = Boot Manager.
If your operating system begins to load before you press <F11>, allow the system to finish booting, and then restart your system and try again.

Boot Manager main menu

Menu Item	Description
Continue Normal Boot	The system attempts to boot to devices starting with the first item in the boot order. If the boot attempt fails, the system continues with the next item in the boot order until the boot is successful or no more boot options are found.
One Shot Boot Menu	Takes you to the boot menu where you can select a one time boot device to boot from.
Launch System Setup	Enables you to access the System Setup.
Launch Lifecycle Controller	Exits the Boot Manager and invokes the Lifecycle Controller program.
System Utilities	Launches system utilities menu such as system diagnostics and UEFI shell.

About Dell Lifecycle Controller

Dell Lifecycle Controller allows you to perform useful tasks such as configuring BIOS and hardware settings, deploying an operating system, updating drivers, changing RAID settings, and saving hardware profiles. For more information about Dell Lifecycle Controller, see the documentation at dell.com/esmmanuals.

Changing the boot order

You may have to change the boot order if you want to boot from a USB key or an optical drive. The instructions given below may vary if you have selected **BIOS** for **Boot Mode**.

1. In the **System Setup Main Menu**, click **System BIOS** → **Boot Settings**.
2. Click **Boot Option Settings** → **Boot Sequence**.
3. Use the arrow keys to select a boot device, and use the <+> and <-> keys to move the device down or up in the order.

4. Click **Exit**, click **Yes** to save the settings on exit.

Choosing the system boot mode

System Setup enables you to specify the boot mode for installing your operating system:

- BIOS boot mode (the default) is the standard BIOS-level boot interface.
- UEFI boot mode is an enhanced 64-bit boot interface based on Unified Extensible Firmware Interface (UEFI) specifications that overlays the system BIOS.

You must select the boot mode in the **Boot Mode** field of the **Boot Settings** screen of System Setup. Once you specify the boot mode, the system boots in the specified boot mode, proceed to install your operating system from that mode. Thereafter, you must boot the system in the same boot mode (BIOS or UEFI) to access the installed operating system.

 **CAUTION:** Trying to boot the operating system from the other boot mode will cause the system to halt at startup.

 **NOTE:** Operating systems must be UEFI-compatible to be installed from the UEFI boot mode. DOS and 32-bit operating systems do not support UEFI and can only be installed from the BIOS boot mode.

 **NOTE:** For the latest information on supported operating systems, go to dell.com/ossupport.

Assigning a system and/or setup password

Prerequisites

 **NOTE:** The password jumper enables or disables the System Password and Setup Password features. For more information on the password jumper settings, see "System board jumper settings".

You can assign a new **System Password** and/or **Setup Password** or change an existing **System Password** and/or **Setup Password** only when the password jumper setting is enabled and **Password Status** is **Unlocked**. If the Password Status is **Locked**, you cannot change the System Password and/or Setup Password.

If the password jumper setting is disabled, the existing System Password and Setup Password is deleted and you need not provide the system password to boot the system.

Steps

1. To enter System Setup, press <F2> immediately after a power-on or reboot.
2. In the **System Setup Main Menu**, select **System BIOS** and press <Enter>. The **System BIOS** screen is displayed.
3. In the **System BIOS** screen, select **System Security** and press <Enter>. The **System Security** screen is displayed.
4. In the **System Security** screen, verify that **Password Status** is **Unlocked**.
5. Select **System Password**, enter your system password, and press <Enter> or <Tab>. Use the following guidelines to assign the system password:
 - A password can have up to 32 characters.
 - The password can contain the numbers 0 through 9.

- Only the following special characters are allowed: space, ("), (+), (,), (-), (.), (/), (:), (|), (\), (|), (').

A message prompts you to re-enter the system password.

6. Re-enter the system password that you entered earlier and click **OK**.
7. Select **Setup Password**, enter your system password and press <Enter> or <Tab>. A message prompts you to re-enter the setup password.
8. Re-enter the setup password that you entered earlier and click **OK**.
9. Press <Esc> to return to the System BIOS screen. Press <Esc> again, and a message prompts you to save the changes.

 **NOTE:** Password protection does not take effect until the system reboots.

Using your system password to secure your system

Prerequisites

 **NOTE:** If you have assigned a setup password, the system accepts your setup password as an alternate system password.

Steps

1. Turn on or reboot your system.
2. Type your password and press <Enter>.

Next steps

When **Password Status** is **Locked**, type the password and press <Enter> when prompted at reboot.

If an incorrect system password is entered, the system displays a message and prompts you to re-enter your password. You have three attempts to enter the correct password. After the third unsuccessful attempt, the system displays an error message that the system has halted and must be powered down.

Even after you shut down and restart the system, the error message is displayed until the correct password is entered.

 **NOTE:** You can use the **Password Status** option in conjunction with the **System Password** and **Setup Password** options to protect your system from unauthorized changes.

Deleting or changing an existing system and/or setup password

Prerequisites

Ensure that the Password jumper is set to enabled and the **Password Status** is set to **Unlocked** before attempting to delete or change the existing System and/or Setup password. You cannot delete or change an existing System or Setup password if the **Password Status** is **Locked**.

Steps

1. To enter System Setup, press <F2> immediately after a power-on or restart.
2. In the **System Setup Main Menu**, select **System BIOS** and press <Enter>. The **System BIOS** screen is displayed.
3. In the **System BIOS Screen**, select **System Security** and press <Enter>. The **System Security** screen is displayed.
4. In the **System Security** screen, verify that **Password Status** is set to **Unlocked**.

5. Select **System Password**, alter or delete the existing system password and press **<Enter>** or **<Tab>**.
6. Select **Setup Password**, alter or delete the existing setup password and press **<Enter>** or **<Tab>**.

 **NOTE:** If you change the System and/or Setup password, a message prompts you to re-enter the new password. If you delete the System and/or Setup password, a message prompts you to confirm the deletion.

7. Press **<Esc>** to return to the System BIOS screen. Press **<Esc>** again, and a message prompts you to save the changes.

Operating with a setup password enabled

If **Setup Password** is **Enabled**, enter the correct setup password before modifying most of the System Setup options.

If you do not enter the correct password in three attempts, the system displays the message

```
Incorrect Password! Number of unsuccessful password attempts: <x> System
Halted! Must power down.
```

Even after you shut down and restart the system, the error message is displayed until the correct password is entered. The following options are exceptions:

- If **System Password** is not **Enabled** and is not locked through the **Password Status** option, you can assign a system password.
- You cannot disable or change an existing system password.

 **NOTE:** You can use the **Password Status** option in conjunction with the **Setup Password** option to protect the system password from unauthorized changes.

Embedded systems management

The Dell Lifecycle Controller provides advanced embedded systems management throughout the server's lifecycle. The Lifecycle Controller can be started during the boot sequence and can function independently of the operating system.

 **NOTE:** Certain platform configurations may not support the full set of features provided by the Lifecycle Controller.

For more information about setting up the Lifecycle Controller, configuring hardware and firmware, and deploying the operating system, see the Lifecycle Controller documentation at dell.com/support/home.

iDRAC Settings utility

The iDRAC Settings utility is an interface to setup and configure the iDRAC parameters using UEFI. You can enable or disable various iDRAC parameters using the iDRAC Settings utility, for example:

- Configure, enable, or disable the iDRAC local area network through the dedicated iDRAC Enterprise card port or the embedded NIC
- Enable or disable IPMI over LAN
- Enable a LAN Platform Event Trap (PET) destination
- Attach or detach the Virtual Media devices

For more information on using iDRAC, see the iDRAC User's Guide, at dell.com/esmmanuals.

Entering the iDRAC Settings utility

1. Turn on or restart the managed system.
2. Press <F2> during Power-on Self-test (POST).
3. In the **System Setup Main Menu** page, click **iDRAC Settings**.

The iDRAC Settings page is displayed.

Installing and removing sled components

This section provides information on installing and removing the sled components. For information on installing and removing the enclosure components, see the enclosure Owner's Manual at dell.com/poweredgemanuals.

Safety instructions

 **CAUTION:** Many repairs may only be done by a certified service technician. You should only perform troubleshooting and simple repairs as authorized in your product documentation, or as directed by the online or telephone service and support team. Damage due to servicing that is not authorized by Dell is not covered by your warranty. Read and follow the safety instructions that came with the product.

 **NOTE:** It is recommended that you always use a static mat and static strap while working on components inside the system.

 **NOTE:** To ensure proper operation and cooling, all bays in the system must be populated at all times with either a system component or with a blank.

Before working inside your system

1. Turn off the sled using the CMC.
2. Remove the sled from the enclosure.
3. Install the I/O connector cover.

After working inside your system

1. Install the sled in the enclosure.
2. Turn on the sled.

Recommended tools

You may need the following items to perform the procedures in this section:

- #1 and #2 Phillips screwdrivers
- T8 and T10 Torx drivers
- Wrist grounding strap
- Hex nut driver-5 mm

Removing and installing a sled

 **CAUTION:** Many repairs may only be done by a certified service technician. You should only perform troubleshooting and simple repairs as authorized in your product documentation, or as directed by the online or telephone service and support team. Damage due to servicing that is not authorized by Dell is not covered by your warranty. Read and follow the safety instructions that came with the product.

Removing the sled

Prerequisites

 **CAUTION:** Many repairs may only be done by a certified service technician. You should only perform troubleshooting and simple repairs as authorized in your product documentation, or as directed by the online or telephone service and support team. Damage due to servicing that is not authorized by Dell is not covered by your warranty. Read and follow the safety instructions that came with the product.

1. Ensure that you read the [Safety instructions](#).
2. Turn off the sled using the operating system commands or the CMC, and ensure that the sled's front-panel indicator is off.

Steps

1. Press the release button on the sled handle to the unlock position.
2. Rotate the sled handle away from the sled to disengage the sled from the midplane connectors.
3. Slide the sled out of the enclosure.

 **CAUTION:** To protect the I/O connector pins, install the I/O connector cover every time a sled is removed from the enclosure.

4. Install the I/O connector cover over the I/O connector.

 **CAUTION:** If you are permanently removing the sled, install a sled blank. Operating the system for extended periods of time without a sled blank installed can cause the enclosure to overheat.

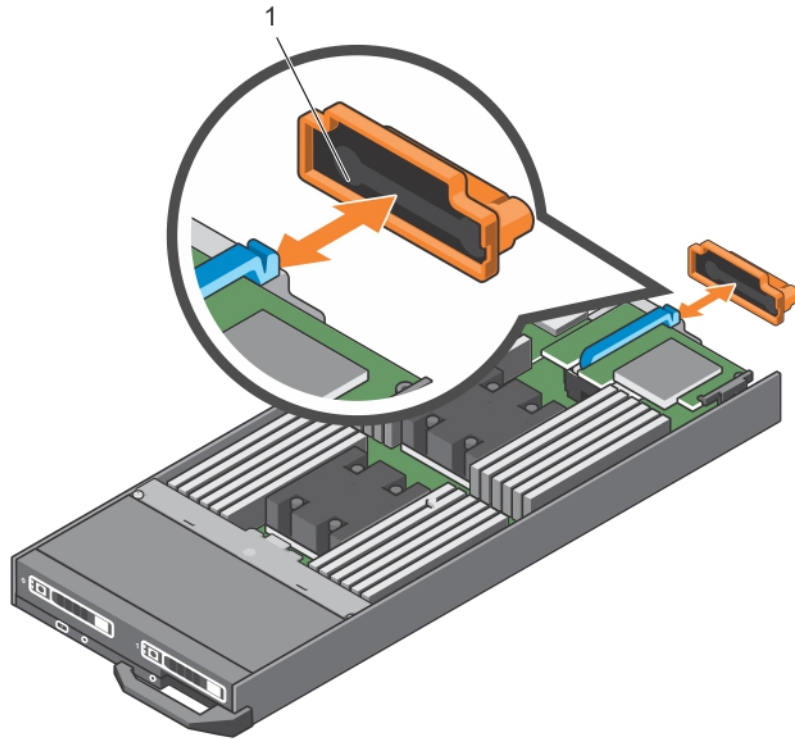

Figure 5. Removing and installing the I/O connector cover

1. I/O connector cover

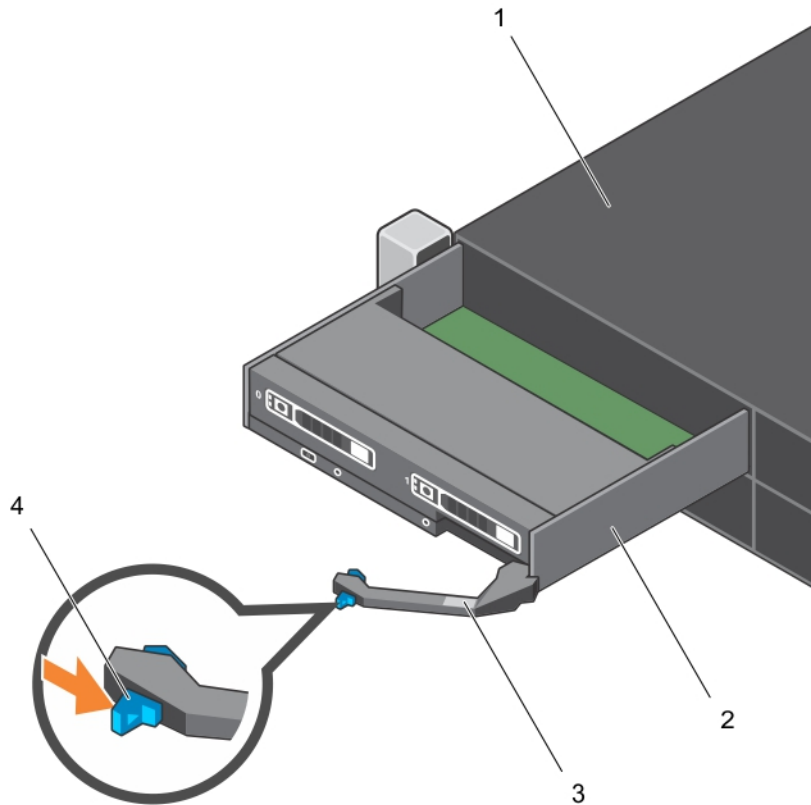

Figure 6. Removing and installing the sled

- | | |
|-----------------------|-------------------|
| 1. FX2/FX2s enclosure | 2. sled |
| 3. sled handle | 4. release button |

Installing the sled

Prerequisites

CAUTION: Many repairs may only be done by a certified service technician. You should only perform troubleshooting and simple repairs as authorized in your product documentation, or as directed by the online or telephone service and support team. Damage due to servicing that is not authorized by Dell is not covered by your warranty. Read and follow the safety instructions that came with the product.

CAUTION: To prevent damage to the I/O connectors, do not touch connectors or the connector pins.

NOTE: Before installing the sleds, place the chassis in the location that you want.

Ensure that you read the [Safety instructions](#).

Steps

1. If you are installing a new sled, remove the plastic cover from the I/O connector(s) and save for future use.
2. Press the release button on the sled handle to the open position.

3. Align the sled with the bay on the enclosure.
4. Slide the sled into the enclosure until the sled connectors are firmly engaged with the midplane connectors.
The sled handle rotates toward the enclosure as the sled slides into the enclosure.
5. Press the sled handle to closed position till the release button clicks into place.

Next steps

Turn on the sled.

Inside the sled

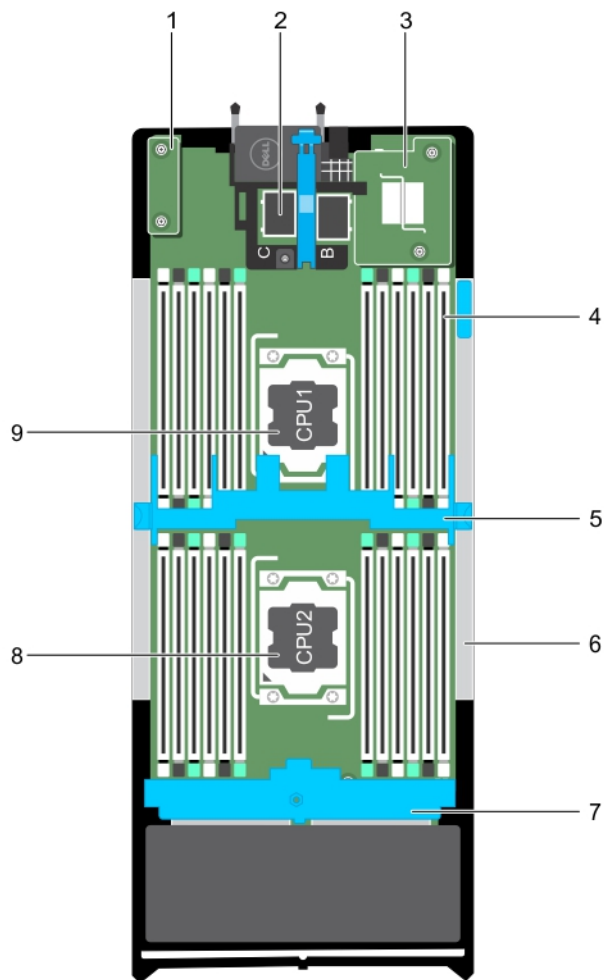

Figure 7. Inside the sled

- | | |
|-----------------------------|--------------------------------------|
| 1. rSPI card | 2. PCIe mezzanine card connector (2) |
| 3. NDC | 4. memory module (24) |
| 5. cooling shroud | 6. PERC H730P Slim card blank |
| 7. hard-drive/SSD backplane | 8. processor 2 |

Cooling shroud

Removing the cooling shroud

Prerequisites

⚠ **CAUTION:** Many repairs may only be done by a certified service technician. You should only perform troubleshooting and simple repairs as authorized in your product documentation, or as directed by the online or telephone service and support team. Damage due to servicing that is not authorized by Dell is not covered by your warranty. Read and follow the safety instructions that came with the product.

⚠ **CAUTION:** Never operate your system with the cooling shroud removed. The system may get overheated quickly, resulting in shutdown and loss of data.

1. Ensure that you read the [Safety instructions](#).
2. Follow the procedure listed in [Before working inside your system](#).

Steps

Pressing the release latches, hold both the edges of the cooling shroud and lift it up and away from the system.

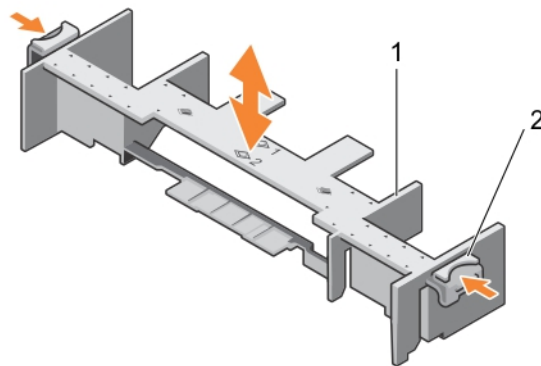

Figure 8. Removing and installing a cooling shroud

1. cooling shroud
2. release latch (2)

Next steps

1. Install the cooling shroud. See [Installing the cooling shroud](#).
2. Follow the procedure listed in [After working inside your system](#).

Installing the cooling shroud

Prerequisites

 **CAUTION:** Many repairs may only be done by a certified service technician. You should only perform troubleshooting and simple repairs as authorized in your product documentation, or as directed by the online or telephone service and support team. Damage due to servicing that is not authorized by Dell is not covered by your warranty. Read and follow the safety instructions that came with the product.

 **NOTE:** You must remove the cooling shroud to service other components inside the system.

1. Ensure that you read the [Safety instructions](#).
2. Follow the procedure listed in [Before working inside your system](#).
3. Ensure that the cooling shroud is removed. See [Removing the cooling shroud](#).

Steps

Pressing the release latches, lower the cooling shroud into the system until the tabs on the sides of the release latches engage with the slots on the sled chassis.

Next steps

Follow the procedure listed in [After working inside your system](#).

Processor/DIMM blank

 **CAUTION:** If you are permanently removing a processor, you must install a socket protective cap and a processor blank/DIMM blank in the vacant socket to ensure proper system cooling. The processor/DIMM blank covers the vacant sockets for the DIMMs and the processor.

Removing a processor/DIMM blank

Prerequisites

 **CAUTION:** Many repairs may only be done by a certified service technician. You should only perform troubleshooting and simple repairs as authorized in your product documentation, or as directed by the online or telephone service and support team. Damage due to servicing that is not authorized by Dell is not covered by your warranty. Read and follow the safety instructions that came with the product.

1. Ensure that you read the [Safety instructions](#).
2. Follow the procedure listed in [Before working inside your system](#).

Steps

Hold the processor/DIMM blank by its edges and lift it away from the system.

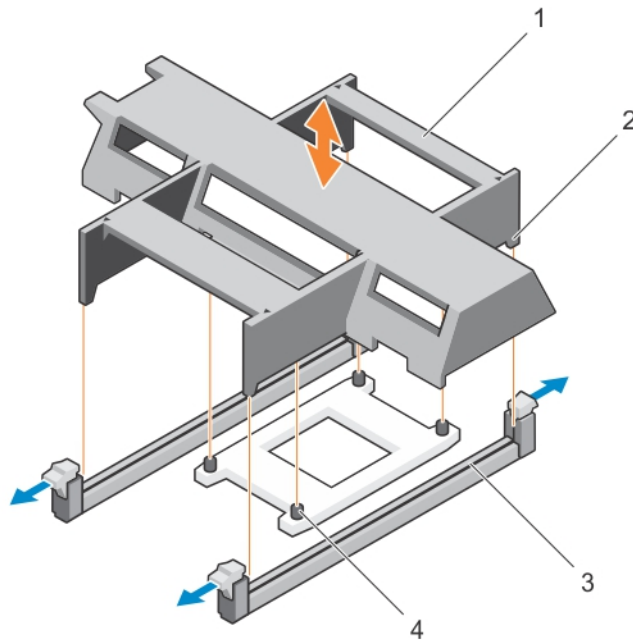

Figure 9. Removing and installing a processor/DIMM blank

- | | |
|-----------------------------|--|
| 1. processor/DIMM blank | 2. tab on the processor/DIMM blank (4) |
| 3. memory module socket (2) | 4. heat sink retention socket (4) |

Next steps

1. Install the processor and the heat sink. See [Installing a processor](#).
2. If you are removing a processor permanently, install the processor/DIMM blank. See [Installing a processor/DIMM blank](#).
3. Follow the procedure listed in [After working inside your system](#).

Installing a processor/DIMM blank

Prerequisites

CAUTION: Many repairs may only be done by a certified service technician. You should only perform troubleshooting and simple repairs as authorized in your product documentation, or as directed by the online or telephone service and support team. Damage due to servicing that is not authorized by Dell is not covered by your warranty. Read and follow the safety instructions that came with the product.

NOTE: You must remove the processor/DIMM blank when using the two-processor configuration or to service other components inside the system.

1. Ensure that you read the [Safety instructions](#).
2. Follow the procedure listed in [Before working inside your system](#).

Steps

1. Align the standoffs on the processor/DIMM blank with the heat sink retention screws on the system board.
2. Lower the processor/DIMM blank onto the system until the holes on the tabs of the processor/DIMM blank engages with the heat sink retention screws on the system board.

Next steps

1. Install the processor and the heat sink. See [Installing a processor](#).
2. Ensure that you install a processor/DIMM blank when you have removed a processor permanently.
3. Follow the procedure listed in [After working inside your system](#).

System memory

Your system supports DDR4 registered DIMMs (RDIMMs) and load reduced DIMMs (LRDIMMs). It supports DDR4 voltage specifications.

 **NOTE:** MT/s indicates DIMM speed in MegaTransfers per second.

Memory bus operating frequency can be 2133 MT/s, 1866 MT/s, 1600 MT/s, or 1333 MT/s depending on:

- Number of DIMMs populated per channel
- System profile selected (for example, Performance Optimized, Custom, or Dense Configuration Optimized)
- Maximum supported DIMM frequency of the processors

The system contains 24 memory sockets split into two sets of 12 sockets, one set per processor. Each 12-socket set is organized into four channels. In each channel, the release levers of the first socket are marked white, the second socket black, and the third socket green.

 **NOTE:** DIMMs in sockets A1 to A12 are assigned to processor 1 and DIMMs in sockets B1 to B12 are assigned to processor 2.

The following table shows the memory populations and operating frequencies for the supported configurations.

Table 1. Memory population — operating frequency for supported configuration

DIMM Type	DIMMs Populated Per Channel	Operating Frequency (in MT/s) For 1.2 V	Maximum DIMM Rank Per Channel
RDIMM	1	2133, 1866, 1600, 1333	Single rank
		2133, 1866, 1600, 1333	Dual rank
	2	2133, 1866, 1600, 1333	Single rank
		2133, 1866, 1600, 1333	Dual rank
	3	1866, 1600, 1333	Single rank
		1866, 1600, 1333	Dual rank
LRDIMM	1	2133, 1866, 1600, 1333	Quad rank

DIMM Type	DIMMs Populated Per Channel	Operating Frequency (in MT/s) For 1.2 V	Maximum DIMM Rank Per Channel
	2	2133, 1866, 1600, 1333	Quad rank
	3	1866, 1600, 1333	Quad rank

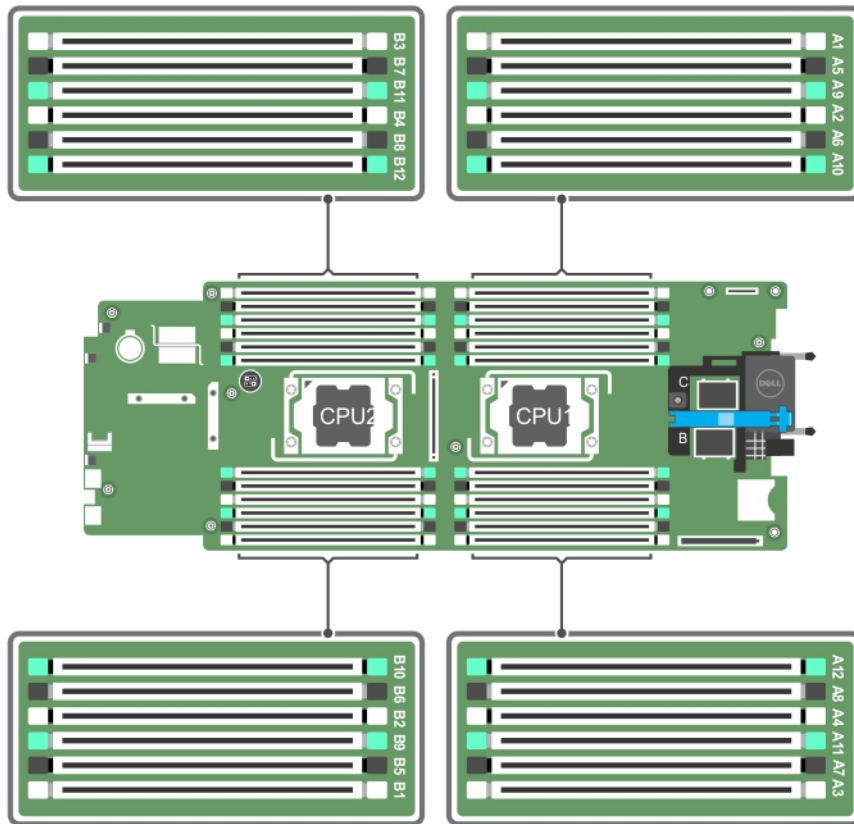

Figure 10. Memory socket locations

Memory channels are organized as follows:

- Processor 1**
- channel 0: memory sockets A1, A5, and A9
 - channel 1: memory sockets A2, A6, and A10
 - channel 2: memory sockets A3, A7, and A11
 - channel 3: memory sockets A4, A8, and A12
- Processor 2**
- channel 0: memory sockets B1, B5, and B9
 - channel 1: memory sockets B2, B6, and B10
 - channel 2: memory sockets B3, B7, and B11
 - channel 3: memory sockets B4, B8, and B12

General memory-module installation guidelines

Your system supports Flexible Memory Configuration, enabling the system to be configured and run in any valid chipset architectural configuration. The following are the recommended guidelines for best performance:

- LRDIMMs, and RDIMMs must not be mixed.
- x4 and x8 DRAM based DIMMs can be mixed. For more information, see [Mode-specific guidelines](#).
- A maximum of three single- or dual-rank RDIMMs can be populated in a channel.
- Populate DIMM sockets only if a processor is installed. For single-processor systems, sockets A1 to A12 are available. For dual-processor systems, sockets A1 to A12 and sockets B1 to B12 are available.
- Populate all sockets with white release tabs first, black, and then green.
- Populate the sockets by highest capacity DIMM in the following order - first in sockets with white release levers and then black. For example, if you want to mix 16 GB and 8 GB DIMMs, populate 16 GB DIMMs in the sockets with white release tabs and 8 GB DIMMs in the sockets with black release tabs.
- In a dual-processor configuration, the memory configuration for each processor must be identical. For example, if you populate socket A1 for processor 1, then populate socket B1 for processor 2, and so on.
- Memory modules of different sizes can be mixed provided that other memory population rules are followed (for example, 4 GB and 8 GB memory modules can be mixed).
- Depending on mode-specific guidelines, populate four DIMMs per processor (one DIMM per channel) at a time to maximize performance. For more information, see [Mode-specific guidelines](#).

Table 2. Heat sink — processor configurations

Processor Configuration	Processor Type (in Watts)	Heat Sink Width	Number of DIMMs	
			Maximum System Capacity	Reliability, Availability, and Serviceability (RAS) Features
Single processor	105 W, 120 W or 135 W	68 mm	12	12
	135 W (four cores, six cores, or eight cores), 145 W, or 105 W acoustic configuration	104 mm	8 (Three DIMMs in channel 0 and channel 2 and one DIMM in channel 1 and channel 3)	4 (One DIMM per channel)
Dual processor	105 W, 120 W or 135 W	68 mm	24	24
	135 W (four cores, six cores, or eight cores), 145 W, or 105 W acoustic configuration	104 mm	16 (Three DIMMs in channel 0 and channel 2 and one DIMM in channel 1 and channel 3)	8 (One DIMM per channel)

 **NOTE:** When using an 104 mm wide heat sink for a single processor, the memory module sockets A6, A8, A10, and A12 are not available for population.

 **NOTE:** When using an 104 mm wide heat sink for a dual processor, the memory module sockets A6, A8, A10, A12, B6, B8, B10, and B12 are not available for population.

Mode-specific guidelines

Four memory channels are allocated to each processor. The allowable configurations depend on the memory mode selected.

 **NOTE:** x4 and x8 DRAM based DIMMs can be mixed providing support for RAS features. However, all guidelines for specific RAS features must be followed. x4 DRAM based DIMMs retain Single Device Data Correction (SDDC) in memory optimized (independent channel) mode. x8 DRAM based DIMMs require Advanced ECC mode to gain SDDC.

The following sections provide additional slot population guidelines for each mode.

Advanced ECC (Lockstep)

Advanced ECC mode extends SDDC from x4 DRAM based DIMMs to both x4 and x8 DRAMs. This protects against single DRAM chip failures during normal operation.

Memory installation guidelines:

- Memory modules must be identical in size, speed, and technology.
- DIMMs installed in memory sockets with white release tabs must be identical and similar rule applies for sockets with black and green release tabs. This ensures that identical DIMMs are installed in matched pairs - for example, A1 with A2, A3 with A4, A5 with A6, and so on.

 **NOTE:** Advanced ECC with mirroring is not supported.

Memory optimized (independent channel) mode

This mode supports SDDC only for memory modules that use x4 device width and does not impose any specific slot population requirements.

Memory Sparing

 **NOTE:** To use Memory Sparing, all populated channels must have at least two DIMMs and Memory Sparing must be enabled in the System Setup.

In this mode, one rank per channel is reserved as a spare. If persistent correctable errors are detected on a rank, the data from this rank is copied to the spare rank and the failed rank is disabled.

With Memory Sparing enabled, the system memory available to the operating system is reduced by one rank per channel. For example, in a dual-processor configuration with sixteen 4 GB dual-rank DIMMs, the available system memory is: $\frac{3}{4}$ (ranks/channel) \times 16 (DIMMs) \times 8 GB = 96 GB, and not 16 (DIMMs) \times 8 GB = 128 GB.

 **NOTE:** Memory Sparing does not offer protection against a multi-bit uncorrectable error.

 **NOTE:** Both Advanced ECC/Lockstep and Optimizer modes support Memory Sparing.

Memory Mirroring

Memory Mirroring offers the strongest DIMM reliability mode compared to all other modes, providing improved uncorrectable multi-bit failure protection. In a mirrored configuration, the total available system memory is one half of the total installed physical memory. Half of the installed memory is used to mirror the active DIMMs. In the event of an uncorrectable error, the system will switch over to the mirrored copy. This ensures SDDC and multi-bit protection.

Memory installation guidelines:

- Memory modules must be identical in size, speed, and technology.
- DIMMs installed in memory sockets with white release tabs must be identical and similar rule applies for sockets with black and green release tabs. This ensures that identical DIMMs are installed in matched pairs - for example, A1 with A2, A3 with A4, A5 with A6, and so on.

Sample memory configurations

The following tables show sample memory configurations that follow the appropriate memory guidelines stated in this section.

 **NOTE:** 1R, 2R, and 4R in the following tables indicate single-, dual-, and quad-rank DIMMs respectively.



 **NOTE:** When using an 104 mm wide heat sink for a single processor, the memory module sockets A6, A8, A10, and A12 are not available for population.

Table 3. Memory configurations – single processor

System Capacity (in GB)	DIMM Size (in GB)	Number of DIMMs	Organization and Speed	DIMM Slot Population
16	4	4	1R x8, 2133 MT/s	A1, A2, A3, A4
24	4	6	1R x8, 2133 MT/s	A1, A2, A3, A4, A5, A6
48	4	12	1R x8, 1600 MT/s	A1, A2, A3, A4, A5, A6, A7, A8, A9, A10, A11, A12
48	8	6	2R x8, 2133 MT/s	A1, A2, A3, A4, A5, A6
96	8	12	2R x8, 1600 MT/s	A1, A2, A3, A4, A5, A6, A7, A8, A9, A10, A11, A12
96	16	6	2R x4, 2133 MT/s	A1, A2, A3, A4, A5, A6
128	16	8	2R x4, 2133 MT/s	A1, A2, A3, A4, A5, A6, A7, A8
144	16 and 8	10	2R x4, 1600 MT/s	A1, A2, A3, A4, A5, A6, A7, A8, A9, A11
				 NOTE: 16 GB DIMMs must be installed in the slots numbered A1, A2, A3, A4, A5, A6, A7, and A8 and 8 GB DIMMs must be installed in slots A9 and A11.
256	32	8	4R x4, 2133 MT/s	A1, A2, A3, A4, A5, A6, A7, A8
384	32	12	4R x4, 1600 MT/s	A1, A2, A3, A4, A5, A6, A7, A8, A9, A10, A11, A12



 **NOTE:** When using an 104 mm wide heat sinks for dual processors, the memory module sockets A6, A8, A10, A12, B6, B8, B10, and B12 are not available for population.



Table 4. Memory configurations – two processors

System Capacity (in GB)	DIMM Size (in GB)	Number of DIMMs	Organization and Speed	DIMM Slot Population
32	4	8	1R x8, 2133 MT/s	A1, A2, A3, A4, B1, B2, B3, B4
64	4	16	1R x8, 2133 MT/s	A1, A2, A3, A4, A5, A6, A7, A8, B1, B2, B3, B4, B5, B6, B7, B8
64	8	8	2R x8, 2133 MT/s	A1, A2, A3, A4, B1, B2, B3, B4
96	4	24	1R x8, 1600 MT/s	A1, A2, A3, A4, A5, A6, A7, A8, A9, A10, A11, A12, B1, B2, B3, B4, B5, B6, B7, B8, B9, B10, B11, B12
96	8	12	2R x8, 2133 MT/s	A1, A2, A3, A4, A5, A6, B1, B2, B3, B4, B5, B6
128	8	16	2R x8, 2133 MT/s	A1, A2, A3, A4, A5, A6, A7, A8, B1, B2, B3, B4, B5, B6, B7, B8
128	16	8	2R x4, 2133 MT/s	A1, A2, A3, A4, B1, B2, B3, B4
160	8	20	2R x8, 1600 MT/s	A1, A2, A3, A4, A5, A6, A7, A8, A9, A11, B1, B2, B3, B4, B5, B6, B7, B8, B9, B11
160	16 and 8	12	2R x4, 2133 MT/s	A1, A2, A3, A4, A5, A6, B1, B2, B3, B4, B5, B6
				 NOTE: 16 GB DIMMs must be installed in the slots numbered A1, A2, A3, A4, B1, B2, B3, and B4 and 8 GB DIMMs must be installed in slots A5, A6, B5 and B6.
192	8	24	2R x8, 1600 MT/s	A1, A2, A3, A4, A5, A6, A7, A8, A9, A10, A11, A12, B1, B2, B3, B4, B5, B6, B7, B8, B9, B10, B11, B12
192	16	12	2R x4, 2133 MT/s	A1, A2, A3, A4, A5, A6, B1, B2, B3, B4, B5, B6

System Capacity (in GB)	DIMM Size (in GB)	Number of DIMMs	Organization and Speed	DIMM Slot Population
256	16	16	2R x4, 2133 MT/s	A1, A2, A3, A4, A5, A6, A7, A8, B1, B2, B3, B4, B5, B6, B7, B8
384	16	24	2R x4, 1600 MT/s	A1, A2, A3, A4, A5, A6, A7, A8, A9, A10, A11, A12, B1, B2, B3, B4, B5, B6, B7, B8, B9, B10, B11, B12
512	32	16	4R x4, 2133 MT/s	A1, A2, A3, A4, A5, A6, A7, A8, B1, B2, B3, B4, B5, B6, B7, B8
768	32	24	4R x4, 1600 MT/s	A1, A2, A3, A4, A5, A6, A7, A8, A9, A10, A11, A12, B1, B2, B3, B4, B5, B6, B7, B8, B9, B10, B11, B12

Removing memory modules

Prerequisites

-  **WARNING:** The memory modules are hot to touch for some time after the system has been powered down. Allow time for the memory modules to cool before handling them. Handle the memory modules by the card edges and avoid touching the components or metallic contacts on the memory module.
 -  **CAUTION:** Many repairs may only be done by a certified service technician. You should only perform troubleshooting and simple repairs as authorized in your product documentation, or as directed by the online or telephone service and support team. Damage due to servicing that is not authorized by Dell is not covered by your warranty. Read and follow the safety instructions that came with the product.
 -  **CAUTION:** To ensure proper system cooling, memory-module blanks must be installed in any memory socket that is not occupied. Remove memory-module blanks only if you intend to install memory modules in those sockets.
1. Ensure that you read the [Safety instructions](#).
 2. Follow the procedure listed in [Before working inside your system](#).
 3. Remove the cooling shroud.

Steps

1. Locate the appropriate memory-module socket(s).
2. To release the memory module from the socket, simultaneously press the ejectors on both ends of the memory-module socket.
 -  **CAUTION:** Handle each memory module only by the card edges, making sure not to touch the middle of the memory module or metallic contacts.
3. Remove the memory module from the socket.

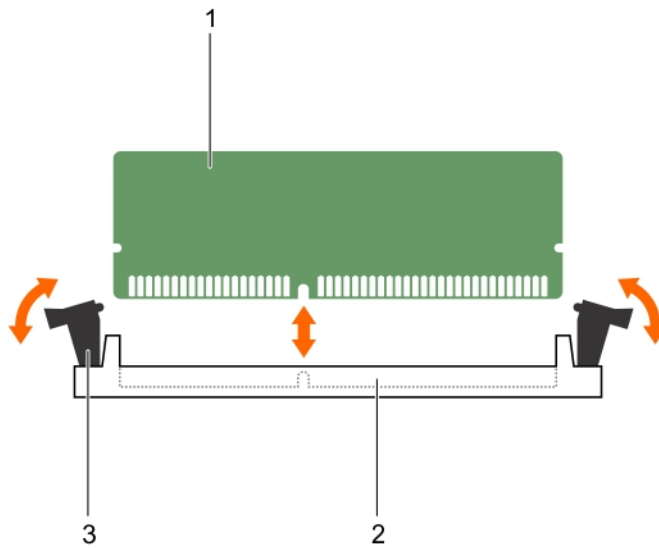

Figure 11. Removing the memory module

- | | |
|------------------------------|-------------------------|
| 1. memory module | 2. memory-module socket |
| 3. memory-module ejector (2) | |

Next steps

1. If you are removing the memory module permanently, install a memory-module blank. If you are installing a new memory module, see [Installing memory modules](#).
2. Follow the procedure listed in [After working inside your system](#).

Installing memory modules

Prerequisites





CAUTION: Many repairs may only be done by a certified service technician. You should only perform troubleshooting and simple repairs as authorized in your product documentation, or as directed by the online or telephone service and support team. Damage due to servicing that is not authorized by Dell is not covered by your warranty. Read and follow the safety instructions that came with the product.

NOTE: You must remove a memory module to upgrade a memory module or replace a faulty memory module.

1. Ensure that you read the [Safety instructions](#).
2. Follow the procedure listed in [Before working inside your system](#).
3. If installed, remove the memory module or the memory-module blank.

WARNING: The memory modules are hot to touch for some time after the system has been powered down. Allow time for the memory modules to cool before handling them. Handle the memory modules by the card edges and avoid touching the components or metallic contacts on the memory module.

Steps

1. Locate the appropriate memory-module socket.
2. Press the ejectors on the memory-module socket outward to allow the memory module to be inserted into the socket.
 **CAUTION: Handle each memory module only on either card edge, making sure not to touch the middle of the memory module.**
3. Align the edge connector on the memory module with the alignment key on the memory-module socket, and insert the memory module in the socket.
 **NOTE:** The memory-module socket has an alignment key that allows you to install the memory module in the socket in only one orientation.
 **CAUTION: To prevent damage to the memory-module socket during installation, apply pressure at both ends of the memory module evenly. Do not apply pressure to the center of the memory module.**
4. Press down on the memory module with your thumbs to lock the memory module into the socket.
 **NOTE:** When the memory module is properly seated in the socket, the ejectors on the memory-module socket align with the ejectors on the other sockets that have memory modules installed.
5. Repeat step 4 through step 7 of this procedure to install the remaining memory modules.

Next steps

1. Follow the procedure listed in [After working inside your system](#).
2. (Optional) Press <F2> to enter the System Setup, and check the **System Memory** setting.

The system should have already changed the value to reflect the newly installed memory.

-  **NOTE:** If the value is incorrect, one or more of the memory modules may not be installed properly. Check to ensure that the memory modules are firmly seated in their sockets.
3. Run the system memory test in the system diagnostics.

PCIe mezzanine card

The sled supports x16 Gen 3 PCIe mezzanine card, which provides an interface between the sled and the PCIe switches on the FX2s enclosure.

-  **NOTE:** Ensure that the PCIe mezzanine card is set to **Enabled** in System Setup.

Removing a PCIe mezzanine card

Prerequisites

-  **CAUTION: Many repairs may only be done by a certified service technician. You should only perform troubleshooting and simple repairs as authorized in your product documentation, or as directed by the online or telephone service and support team. Damage due to servicing that is not authorized by Dell is not covered by your warranty. Read and follow the safety instructions that came with the product.**
1. Ensure that you read the [Safety instructions](#).
2. Follow the procedure listed in [Before working inside your system](#).

Steps

1. Open the PCIe mezzanine card retention latch by pressing the release tab on the retention latch.
2. Pull back and hold the retention bracket away from the PCIe mezzanine card.
3. Lift the end of the retention latch until the two connectors on the PCIe mezzanine card disengage from connectors on the system board.

⚠ CAUTION: To prevent damage to the PCIe mezzanine card, you must hold the card only by its edges.

4. Lift the PCIe mezzanine card up and away from the system.
5. Close the retention latch.

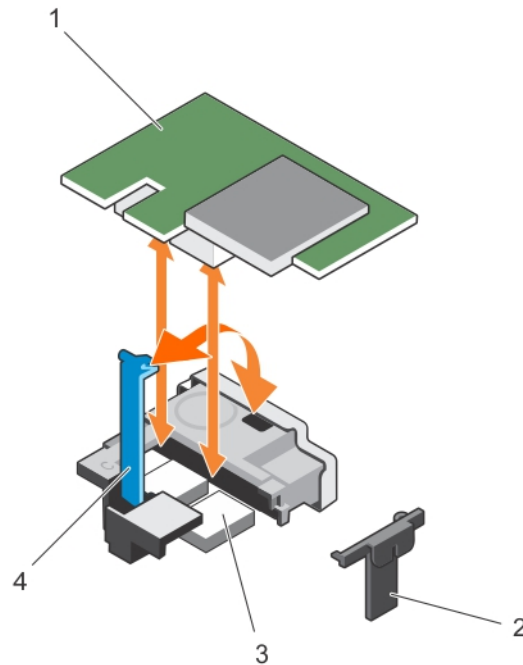

Figure 12. Removing and installing a PCIe mezzanine card

- | | |
|--------------------------------------|--|
| 1. PCIe mezzanine card | 2. PCIe mezzanine card retention bracket |
| 3. PCIe mezzanine card connector (2) | 4. PCIe mezzanine card retention latch |

Next steps

1. Install the PCIe mezzanine card. See [Installing a PCIe mezzanine card](#).
2. Follow the procedure listed in [After working inside your system](#).

Installing a PCIe mezzanine card

Prerequisites

 **CAUTION:** Many repairs may only be done by a certified service technician. You should only perform troubleshooting and simple repairs as authorized in your product documentation, or as directed by the online or telephone service and support team. Damage due to servicing that is not authorized by Dell is not covered by your warranty. Read and follow the safety instructions that came with the product.

 **NOTE:** You must remove the PCIe mezzanine card to replace a faulty PCIe mezzanine card or service other components inside the system.

1. Ensure that you read the [Safety instructions](#).
2. Remove the PCIe mezzanine card. See [Removing a PCIe mezzanine card](#).

Steps

1. Open the PCIe mezzanine card retention latch by pressing the release tab on the retention latch and lift the end of the latch.
2. If present, remove the connector cover from the PCIe mezzanine card bay.

 **CAUTION:** To prevent damage to the PCIe mezzanine card, you must hold the card only by its edges.

3. Align the two connectors on the PCIe mezzanine card with the connectors on the system board.
4. Press down the PCIe mezzanine card till the connectors on the card completely engage with the corresponding connectors.

The retention bracket on the side of the chassis latches onto the PCIe mezzanine card.

5. Close the retention latch.

Next steps

Follow the procedure listed in [After working inside your system](#).

Related Links

- [Removing the sled](#)
- [Installing the sled](#)

IDSDM card (optional)

The Internal Dual SD Module (IDSDM) card provides two SD card slots and a USB interface dedicated for the embedded hypervisor. This card offers the following features:

- Dual card operation — maintains a mirrored configuration using SD cards in both slots and provides redundancy.
- Single card operation — single card operation is supported, but without redundancy.

Replacing an SD card

Prerequisites

 **CAUTION:** Many repairs may only be done by a certified service technician. You should only perform troubleshooting and simple repairs as authorized in your product documentation, or as directed by the online or telephone service and support team. Damage due to servicing that is not authorized by Dell is not covered by your warranty. Read and follow the safety instructions that came with the product.

1. Ensure that you read the [Safety instructions](#).
2. Follow the procedure listed in [Before working inside your system](#).
3. Enter the System Setup and ensure that the **Internal SD Card Port** is enabled.

 **CAUTION:** When an SD card failure occurs, and the **Internal SD Card Redundancy** option in the **Integrated Devices** screen of the **System Setup** is set to **Mirror Mode**, there may be loss of data. To avoid data loss, follow step 4 through step 6 of [Troubleshooting an internal SD card](#).

 **NOTE:** The SD card in the lower card slot is the primary card (SD1) and the SD card in the upper card slot is the secondary card (SD2).

 **NOTE:** When an SD card failure occurs, the **Internal SD Card Redundancy** option in the System Setup is set to **Disabled** and the internal dual SD module controller notifies the system. On the next reboot, the system displays a message indicating the failure.

 **NOTE:** If the **Internal SD Card Redundancy** option is set to **Disabled**, replace the failed SD card with a new SD card.

Steps

1. Locate the SD card slot on the internal dual SD module (IDSMD) card.
2. Press inward on the card to release it from the slot, and remove the card.

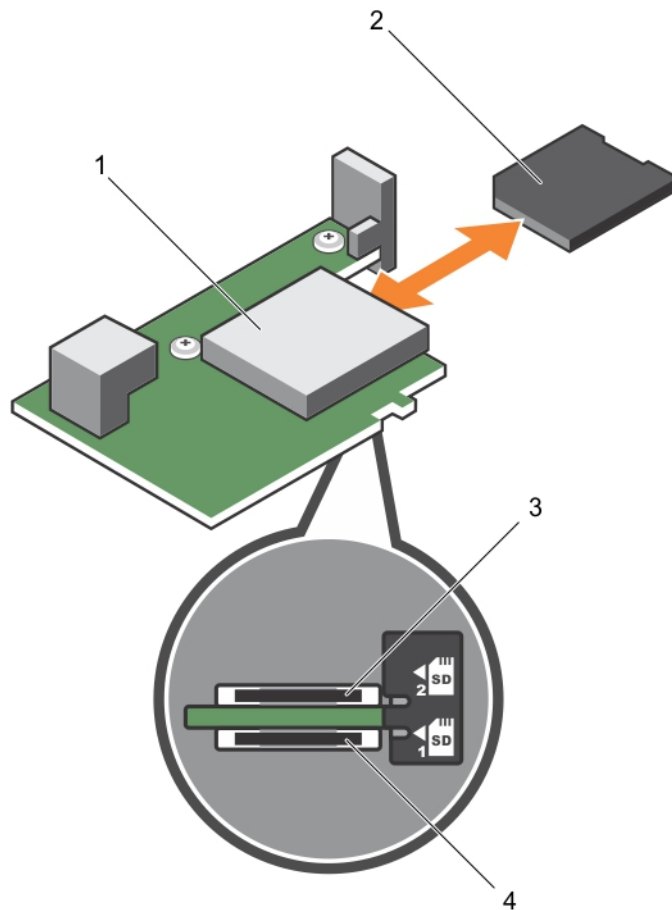

Figure 13. Replacing an SD card

- | | |
|---------------------------|---------------------------|
| 1. IDSDM card | 2. SD card |
| 3. upper card slot (SD 2) | 4. lower card slot (SD 1) |

Next steps

1. Follow the procedure listed in [After working inside your system](#).
2. Enter the System Setup and ensure that the **Internal SD Card Port** and **Internal SD Card Redundancy** mode is enabled.
3. Check if the new SD card is functioning properly. If the problem persists, see [Getting Help](#).

Internal USB key

The sled provides an internal USB connector for a USB flash memory key. The USB memory key can be used as a boot device, security key, or mass storage device. To use the internal USB connector, the **Internal USB Port** option must be enabled in the **Integrated Devices** screen of the System Setup.

To boot from the USB memory key, you must configure the USB memory key with a boot image, and then specify the USB memory key in the boot sequence in the System Setup. For information on creating

a bootable file on the USB memory key, see the user documentation that accompanied the USB memory key.

Replacing the internal USB key

Prerequisites

△ CAUTION: Many repairs may only be done by a certified service technician. You should only perform troubleshooting and simple repairs as authorized in your product documentation, or as directed by the online or telephone service and support team. Damage due to servicing that is not authorized by Dell is not covered by your warranty. Read and follow the safety instructions that came with the product.

△ CAUTION: To avoid interference with other components in the sled, the maximum permissible dimensions of the USB key are 15.9 mm wide x 57.15 mm long x 7.9 mm high.

1. Ensure that you read the [Safety instructions](#).
2. Follow the procedure listed in [Before working inside your system](#).

Steps

1. Locate the USB connector/USB key.
2. If installed, remove the USB key.
3. Insert the new USB memory key into the USB connector.

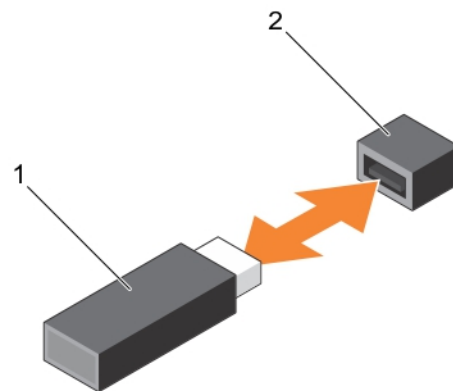

Figure 14. Replacing the USB memory key

1. USB memory key
2. USB memory key connector

Next steps

1. Follow the procedure listed in [After working inside your system](#).
2. Enter the System Setup and ensure that the USB key is detected by the system.

3. SD card slot bracket
4. PCIe mezzanine card support bracket
5. IDSDM card connector on the system board
6. standoff (2)

Next steps

1. Install the IDSDM card, see [Installing the IDSDM card](#).
2. Follow the procedure listed in [After working inside your system](#).

Related Links

[Replacing the internal USB key](#)

[Replacing an SD card](#)

Installing the IDSDM card

Prerequisites

 **CAUTION:** Many repairs may only be done by a certified service technician. You should only perform troubleshooting and simple repairs as authorized in your product documentation, or as directed by the online or telephone service and support team. Damage due to servicing that is not authorized by Dell is not covered by your warranty. Read and follow the safety instructions that came with the product.

 **NOTE:** You must remove the IDSDM card to replace a faulty IDSDM card or service other components inside the system.

1. Ensure that you read the [Safety instructions](#).
2. Keep the #2 Phillips screwdriver ready.
3. Remove the SD card.
4. Remove the IDSDM card, see [Removing the IDSDM card](#).

 **CAUTION:** To prevent damage to the IDSDM card, you must hold the card only by its edges.

Steps

1. Align the following:
 - The slot on the card edge with the projection tabs on the PCIe mezzanine card support.
 - The two screw holes on the IDSDM card with the standoffs on the system board.
 - The hole on the SD card slot bracket with the screw hole on the IDSDM card.
2. Install the two screws to secure the SD card slot bracket and IDSDM card to the system board.

Next steps

1. If applicable, install the SD card(s) and the internal USB key.
2. Follow the procedure listed in [After working inside your system](#).

Related Links

[Replacing an SD card](#)

[Replacing the internal USB key](#)

rSPI card (optional)

rSPI (restore Serial Peripheral Interface) is a SPI flash device to store information about the system Service Tag, system configuration, or iDRAC license.

Removing the rSPI card

Prerequisites

△ CAUTION: Many repairs may only be done by a certified service technician. You should only perform troubleshooting and simple repairs as authorized in your product documentation, or as directed by the online or telephone service and support team. Damage due to servicing that is not authorized by Dell is not covered by your warranty. Read and follow the safety instructions that came with the product.

1. Ensure that you read the [Safety instructions](#).
2. Keep the #2 Phillips screwdriver ready.
3. Follow the procedure listed in [Before working inside your system](#).

Steps

1. Remove the two screws securing the rSPI card to the system board.

△ CAUTION: To prevent damage to the rSPI card, you must hold the card only by its edges.

2. Lift the card up and away from the system.

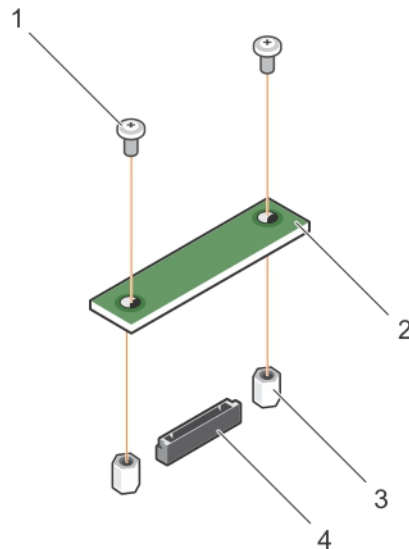

Figure 16. Removing and installing the rSPI card

- | | |
|-----------------|--------------|
| 1. screw (2) | 2. rSPI card |
| 3. standoff (2) | 4. connector |

Next steps

1. Install the rSPI card, see [Installing the rSPI card](#).
2. Follow the procedure listed in [After working inside your system](#).

Installing the rSPI card

Prerequisites

 **CAUTION:** Many repairs may only be done by a certified service technician. You should only perform troubleshooting and simple repairs as authorized in your product documentation, or as directed by the online or telephone service and support team. Damage due to servicing that is not authorized by Dell is not covered by your warranty. Read and follow the safety instructions that came with the product.

 **NOTE:** You must remove the rSPI card to replace a faulty rSPI card or service other components inside the system.

1. Ensure that you read the [Safety instructions](#).
2. Keep the #2 Phillips screwdriver ready.
3. Remove the rSPI card, see [Removing the rSPI card](#).

 **CAUTION:** To prevent damage to the rSPI card, you must hold the card only by its edges.

Steps

1. Align the two screw holes on the rSPI card with the standoffs on the system board.
2. Install the two screws to secure the rSPI card to the system board.

Next steps

Follow the procedure listed in [After working inside your system](#).

SD vFlash card

Replacing the SD vFlash card

Prerequisites

 **CAUTION:** Many repairs may only be done by a certified service technician. You should only perform troubleshooting and simple repairs as authorized in your product documentation, or as directed by the online or telephone service and support team. Damage due to servicing that is not authorized by Dell is not covered by your warranty. Read and follow the safety instructions that came with the product.

1. Ensure that you read the [Safety instructions](#).
2. Follow the procedure listed in [Before working inside your system](#).

Steps

1. If installed, remove the SD vFlash card from the card slot.

 **NOTE:** The SD vFlash card slot is near below the NDC.

2. Insert the contact-pin end of the SD card into the card slot on the VFlash media unit.

 **NOTE:** The slot is keyed to ensure correct insertion of the card.

3. Press inward on the card to lock it into the slot.

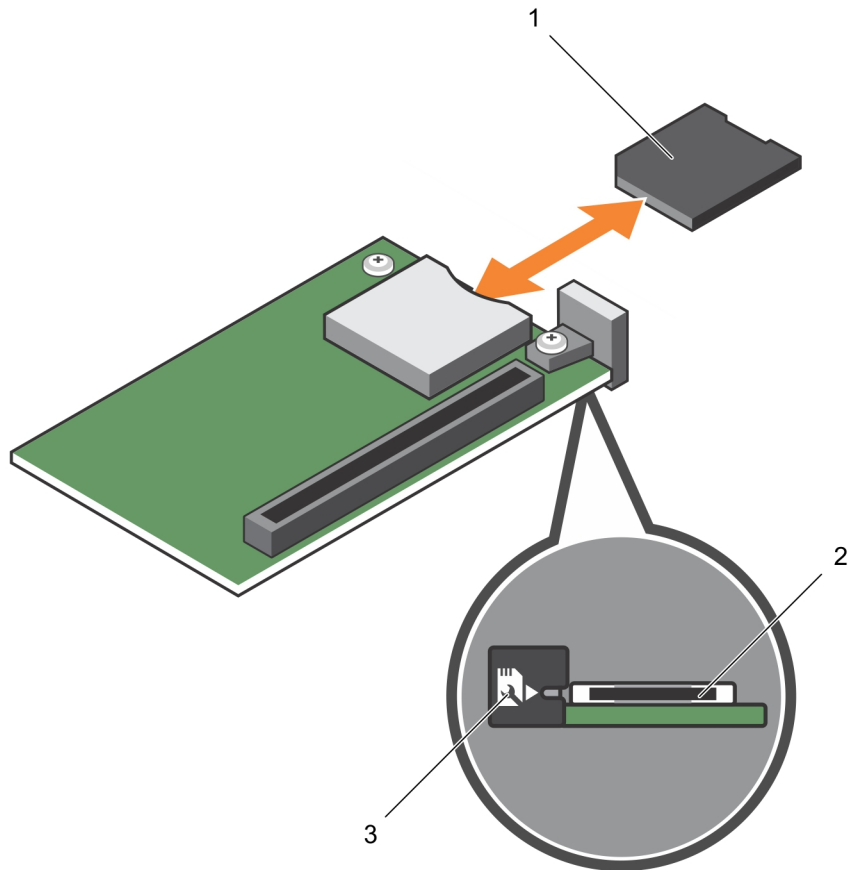

Figure 17. Replacing the SD vFlash card

1. SD vFlash card
2. SD vFlash card slot
3. SD vFlash card slot identification label

Next steps

Follow the procedure listed in [After working inside your system.](#)

Network Daughter Card

Removing the Network Daughter Card

Prerequisites

CAUTION: Many repairs may only be done by a certified service technician. You should only perform troubleshooting and simple repairs as authorized in your product documentation, or as directed by the online or telephone service and support team. Damage due to servicing that is not authorized by Dell is not covered by your warranty. Read and follow the safety instructions that came with the product.

1. Ensure that you read the [Safety instructions.](#)

2. Keep the #2 Phillips screwdriver ready.
3. Follow the procedure listed in [Before working inside your system.](#)
4. Remove the PCIe mezzanine card. See [Removing a PCIe mezzanine card.](#)

Steps

1. Remove the two screws that secure the Network Daughter Card (NDC) to the system board.
2. Lift the card from the system board.

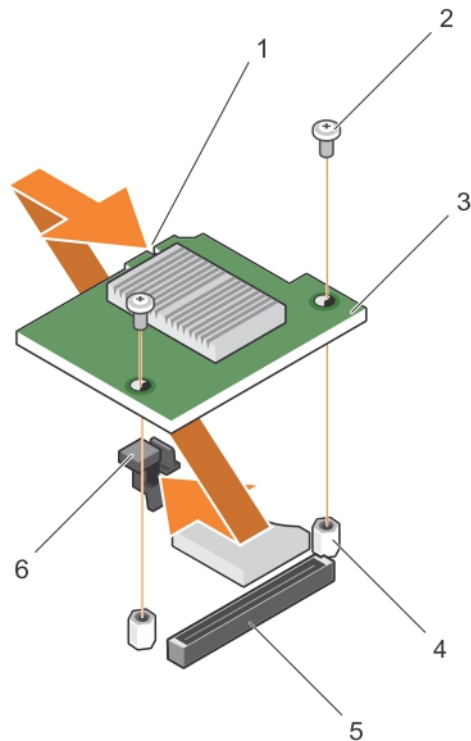

Figure 18. Removing and installing the NDC

- | | |
|----------------------------------|--------------------|
| 1. slot on the NDC | 2. screw (2) |
| 3. NDC | 4. standoff (2) |
| 5. connector on the system board | 6. tab projections |

Next steps

1. Install the NDC. See [Installing the Network Daughter Card.](#)
2. Install the PCIe mezzanine card. See [Installing a PCIe mezzanine card.](#)
3. Follow the procedure listed in [After working inside your system.](#)

Installing the Network Daughter Card

Prerequisites

 **CAUTION:** Many repairs may only be done by a certified service technician. You should only perform troubleshooting and simple repairs as authorized in your product documentation, or as directed by the online or telephone service and support team. Damage due to servicing that is not authorized by Dell is not covered by your warranty. Read and follow the safety instructions that came with the product.

 **NOTE:** You must remove the NDC to replace a faulty NDC card or service other components inside the system.

1. Ensure that you read the [Safety instructions](#).
2. Keep the #2 Phillips screwdriver ready.
3. Remove the PCIe mezzanine card. See [Removing a PCIe mezzanine card](#).
4. Remove the NDC. See [Removing the Network Daughter Card](#).

Steps

1. Align the following:
 - a. The slots on the card edge with the projection tabs on the plastic bracket covering the PCIe mezzanine card slots.
 - b. Screw holes on the card with the standoffs on the system board.

 **CAUTION:** To prevent damage to the NDC, you must hold the card only by its edges.

2. Lower the card into place until the card connector fits into the corresponding connector on the system board.
3. Secure the card with the two screws.

Next steps

1. Install the PCIe mezzanine card. See [Installing a PCIe mezzanine card](#).
2. Follow the procedure listed in [After working inside your system](#).

Processors

Your system supports one or two Intel Xeon E5-2600 v3 product family processors.

 **CAUTION:** For processors up to 105 W, 120 W, or 135 W, use heat sinks of 68 mm width.

 **CAUTION:** For processors up to 105 W (for acoustic configuration), 135 W (four cores, six cores, or eight cores), or 145 W, use heat sinks of 104 mm width.

 **NOTE:** Mixing processors of different wattages is not supported.

Use the following procedure when:

- Installing an additional processor
- Replacing a processor

Removing a processor

Prerequisites

 **CAUTION:** Many repairs may only be done by a certified service technician. You should only perform troubleshooting and simple repairs as authorized in your product documentation, or as directed by the online or telephone service and support team. Damage due to servicing that is not authorized by Dell is not covered by your warranty. Read and follow the safety instructions that came with the product.

 **CAUTION:** Never remove the heat sink from a processor unless you intend to remove the processor. The heat sink is necessary to maintain proper thermal conditions.

 **NOTE:** The processor and heat sink can become extremely hot. Be sure the processor has had sufficient time to cool before handling.

1. Ensure that you read the [Safety instructions](#).
2. Keep the #2 Phillips screwdriver ready.
3. Follow the procedure listed in [Before working inside your system](#).
4. Remove the cooling shroud.

Steps

1. Loosen the first screw that secures the heat sink to the system board.
2. Wait 30 seconds for the heat sink to loosen from the processor and loosen the screw diagonally opposite the first screw.
3. Repeat the procedure for the remaining two screws.
4. Remove the heat sink.

 **NOTE:** Set the heat sink upside down on the work surface to avoid contaminating the thermal grease.

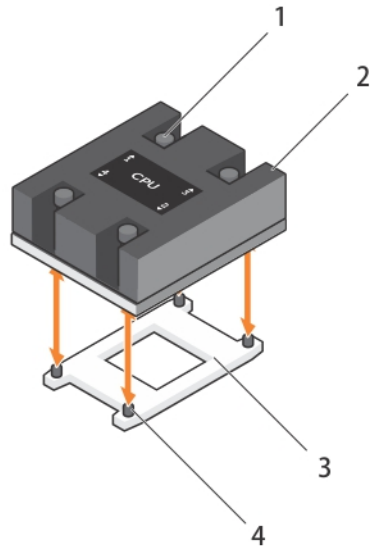

Figure 19. Installing and removing a heat sink

1. retention screw (4)
 2. heat sink
 3. processor socket
 4. heat sink retention socket (4)
5. Use a clean, lint-free cloth to remove any thermal grease from the surface of the processor shield.
- ⚠ CAUTION: The processor is held in its socket under strong pressure. Be aware that the release lever can spring up suddenly if not firmly grasped.**
6. Position your thumb firmly over the socket-release lever1 and lever 2 of the processor and release both the levers simultaneously from the locked position by pushing down and out from under the tab.

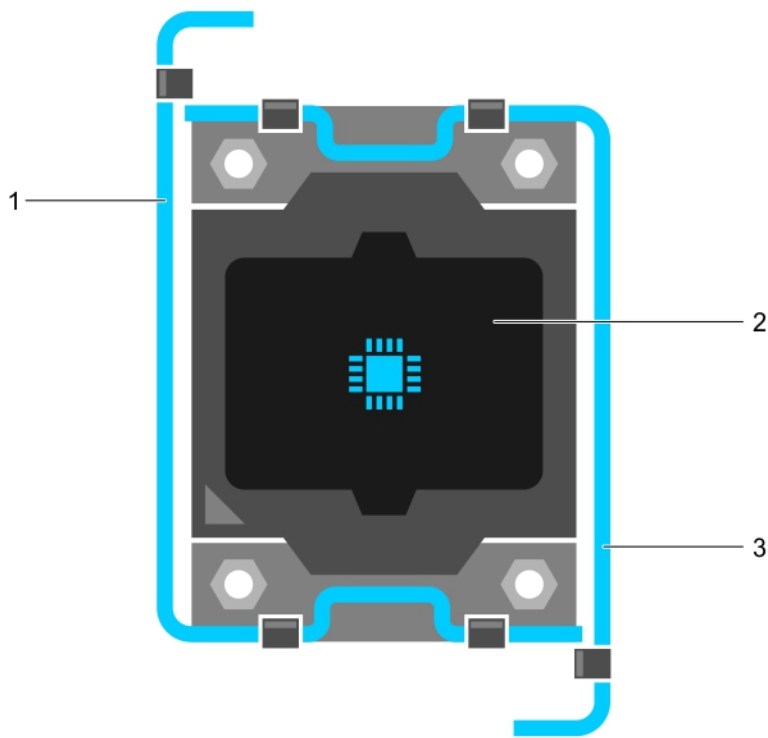

Figure 20. Processor shield opening and closing lever sequence

1. socket-release lever 1
 2. processor
 3. socket-release lever 2
7. Hold the tab on the processor shield and rotate the shield upward and out of the way.
 8. Lift the processor out of the socket and leave the release lever up so that the socket is ready for the new processor.

⚠ CAUTION: If you are permanently removing a processor, you must install a socket protective cap and a processor/DIMM blank in the vacant socket to ensure proper system cooling. The processor/DIMM blank covers the vacant sockets for the DIMMs and the processor.

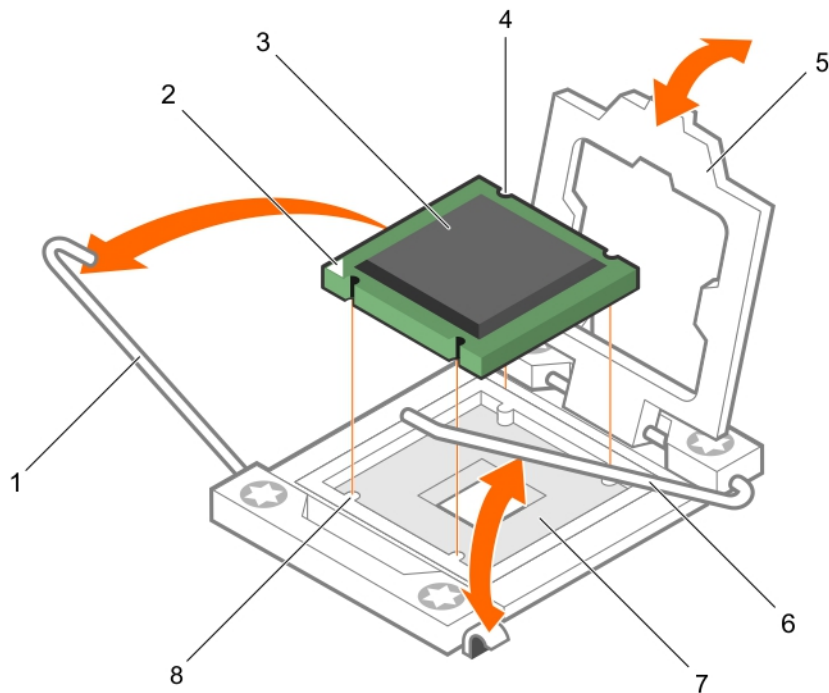

Figure 21. Installing and removing a processor

- | | |
|---------------------------|----------------------------------|
| 1. socket-release lever 1 | 2. pin-1 corner of the processor |
| 3. processor | 4. slot (4) |
| 5. processor shield | 6. socket-release lever 2 |
| 7. processor socket | 8. tab (4) |

Next steps

1. If you are removing the processor permanently, install the processor/DIMM blank. If you are installing a new processor, see [Installing a processor](#).
2. Follow the procedure listed in [After working inside your system](#).

Related Links

[Removing the cooling shroud](#)

Installing a processor

Prerequisites

⚠ CAUTION: Many repairs may only be done by a certified service technician. You should only perform troubleshooting and simple repairs as authorized in your product documentation, or as directed by the online or telephone service and support team. Damage due to servicing that is not authorized by Dell is not covered by your warranty. Read and follow the safety instructions that came with the product.

 **NOTE:** If you are installing just one processor, it must be installed in socket CPU1.

 **NOTE:** You must remove a processor to upgrade a processor or replace a faulty processor.

1. Ensure that you read the [Safety instructions](#).
2. Keep the #2 Phillips screwdriver ready.
3. Follow the procedure listed in [Before working inside your system](#).
4. Remove the processor or processor blank/DIMM blank.

Steps

1. Unlatch and rotate the socket-release levers 90 degrees upward and ensure that the socket-release lever is fully open.
2. Hold the tab on the processor shield and rotate the shield upward and out of the way.

 **NOTE:** It is recommended that you install/remove the socket protective cap from the processor shield with the processor shield in the open position.

3. If installed, remove the socket protective cap from the processor shield. To remove the socket protective cap, push the cap from the inside of the processor shield and move it away from the socket pins.

 **CAUTION: Positioning the processor incorrectly can permanently damage the system board or the processor. Be careful not to bend the pins in the socket.**

 **CAUTION: Do not use force to seat the processor. When the processor is positioned correctly, it engages easily into the socket.**

4. Install the processor in the socket:
 - a. Identify the pin-1 corner of the processor by locating the tiny gold triangle on one corner of the processor. Place this corner in the same corner of the ZIF socket identified by a corresponding triangle on the system board.
 - b. Align the pin-1 corner of the processor with the pin-1 corner of the system board.
 - c. Set the processor lightly in the socket.

Because the system uses a ZIF processor socket, do not use force. When the processor is positioned correctly, it drops down into the socket with minimal pressure.
 - d. Close the processor shield.
 - e. Rotate the socket-release lever 1 and lever 2 simultaneously until it is locked in position.
5. To install the heat sink:
 - a. If applicable, remove the existing thermal grease from the heat sink using a clean lint-free cloth.
 - b. Apply thermal grease on the top of the processor. Use the thermal-grease syringe included with your processor kit to apply the grease in a thin spiral on the top of the processor as shown in the figure.

 **CAUTION: Applying too much thermal grease can result in excess grease coming in contact with and contaminating the processor socket.**

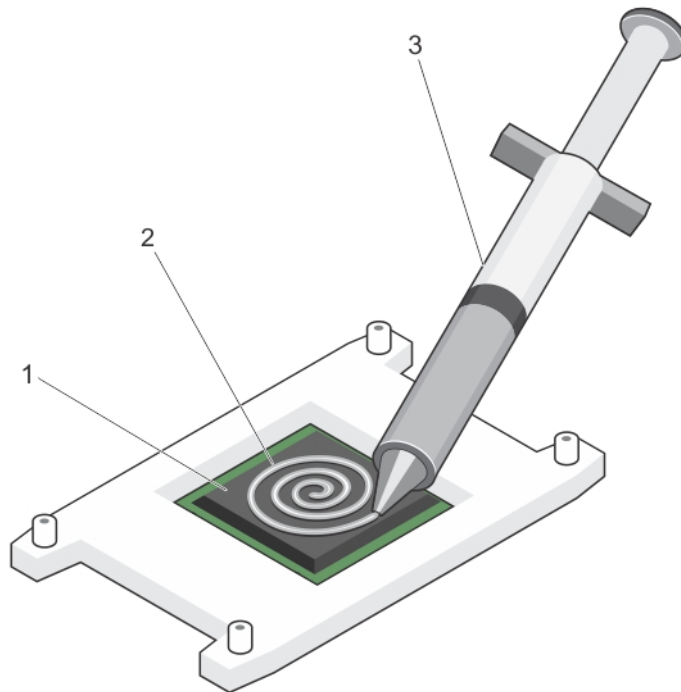



Figure 22. Applying thermal grease on the top of the processor

1. processor
2. thermal grease
3. thermal-grease syringe

 **NOTE:** The thermal-grease is intended for one-time use only. Dispose of the syringe after you use it.

- c. Place the heat sink onto the processor.
- d. Tighten the four screws to secure the heat sink to the system board.

 **NOTE:** Tighten the screws diagonally opposite to each other. Do not over-tighten the heat sink retention screws when installing the heat sink. To prevent over-tightening, tighten the retention screw until resistance is felt, and stop once the screw is seated. The screw tension should be no more than 6 in-lb (6.9 kg-cm).

Next steps

1. Install the cooling shroud.
2. Follow the procedure listed in [After working inside your system](#).

As the system boots, it detects the presence of the new processor and automatically changes the system configuration information in the System Setup.

3. Press <F2> to enter the System Setup and check that the processor information matches the new system configuration.
4. Run the system diagnostics to verify that the new processor operates correctly.
5. Update the system BIOS.

Related Links

[Installing the cooling shroud](#)

Hard drives/SSDs

Your system supports up to two 2.5 inch SAS/SATA/PCIe SSDs or SAS /SATA hard drives and eight 1.8 inch SATA SSDs. The hard drives/SSDs are supplied in special hot-swappable drive carriers that fit in the drive bays and these drives connect to the system board through the hard-drive backplane board.

 **NOTE:** Mixing of SSD/SAS/SATA harddrives is not supported.

Hard-drive/SSD bay numbering

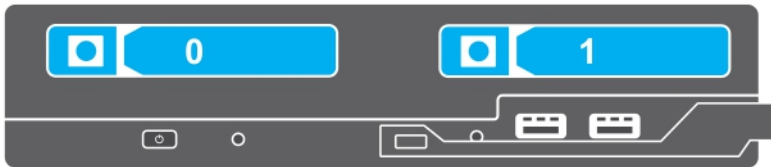

Figure 23. Hard-drive/SSD bay numbering — 2.5 inch hard-drive/SSD system



Figure 24. SSD bay numbering — 1.8 inch SSD system

Hard drive/SSD installation guidelines

For single hard drive configuration, a hard-drive blank must be installed in the other drive bay to maintain proper airflow.

Removing a hard drive/SSD

Prerequisites

CAUTION: Many repairs may only be done by a certified service technician. You should only perform troubleshooting and simple repairs as authorized in your product documentation, or as directed by the online or telephone service and support team. Damage due to servicing that is not authorized by Dell is not covered by your warranty. Read and follow the safety instructions that came with the product.

1. Ensure that you read the [Safety instructions](#).
2. Take the hard drive/SSD offline and wait until the hard-drive/SSD indicator codes on the drive carrier are off.

When all indicators are off, the drive is ready for removal. See your operating system documentation for more information on taking the hard drive/SSD offline.

NOTE: All operating systems do not support hot-swappable drive installation. See the documentation supplied with your operating system.

Steps

1. Press the release button to open the hard-drive/SSD carrier handle.
2. Slide the hard-drive/SSD carrier out until it is free of the hard-drive/SSD slot.
3. Slide the hard drive/SSD out until it is free of the hard-drive/SSD bay.

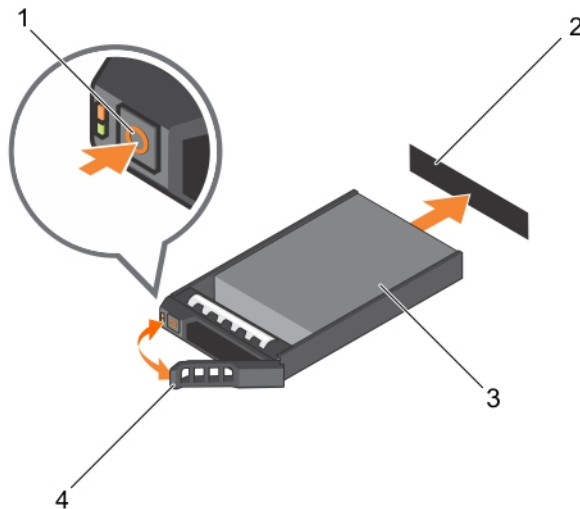

Figure 25. Removing and installing a hard drive/SSD

- | | |
|-------------------|--|
| 1. release button | 2. hard-drive/SSD connector (on backplane) |
| 3. hard drive/SSD | 4. hard-drive/SSD carrier handle |

Next steps

1. If you are removing a hard drive/SSD permanently, install the hard-drive/SSD blank. If you are installing a new hard drive/SSD, see [Installing a hard drive/SSD](#).

Related Links

[Hard-drive/SSD indicator patterns](#)

Installing a hard drive/SSD

Prerequisites

 **CAUTION:** When a replacement hot-swappable hard drive/SSD is installed and the sled is powered on, the hard drive/SSD automatically begins to rebuild. Make absolutely sure that the replacement hard drive/SSD is blank or contains data that you wish to have over-written. Any data on the replacement hard drive/SSD is immediately lost after the hard drive/SSD is installed.

 **NOTE:** You must remove a hard drive/SSD to upgrade a hard drive/SSD or replace a faulty hard drive/SSD.

1. Ensure that you read the [Safety instructions](#).
2. Remove the hard drive/SSD or hard-drive/SSD blank.

 **NOTE:** All operating systems do not support hot-swappable drive installation. See the documentation supplied with your operating system.

Steps

1. Press the release button to open the hard-drive/SSD carrier handle.
2. Slide the hard-drive/SSD carrier into the drive bay. Carefully align the channel on the hard-drive/SSD carrier with the appropriate drive slot on the sled.
3. Push the drive carrier into the slot until the handle makes contact with the sled.
4. Rotate the carrier handle to the closed position while pushing the carrier into the slot until it locks into place.

The status LED indicator displays a steady green light if the drive is installed correctly. The drive carrier LED green indicator flashes as the drive rebuilds.

Removing a hard-drive/SSD blank

Prerequisites

 **CAUTION:** Many repairs may only be done by a certified service technician. You should only perform troubleshooting and simple repairs as authorized in your product documentation, or as directed by the online or telephone service and support team. Damage due to servicing that is not authorized by Dell is not covered by your warranty. Read and follow the safety instructions that came with the product.

 **CAUTION:** To maintain proper system cooling, all empty hard-drive/SSD slots must have hard-drive/SSD blanks installed.

1. Ensure that you read the [Safety instructions](#).

Steps

Press the release latch and slide the hard-drive/SSD blank out of the hard-drive/SSD slot.

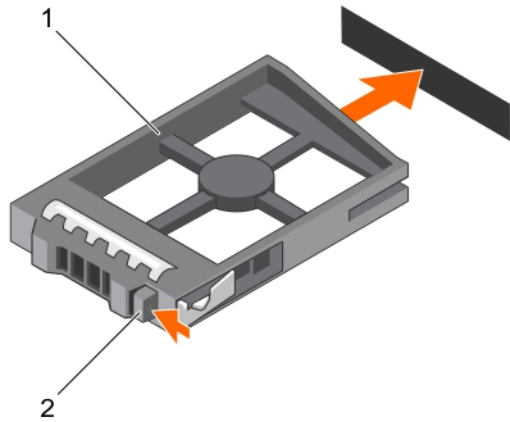

Figure 26. Removing and installing a 2.5 inch hard-drive/SSD blank

1. hard-drive/SSD blank
2. release latch

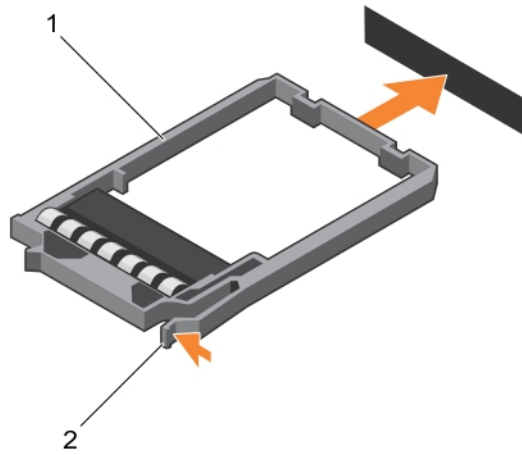

Figure 27. Removing and installing a 1.8 inch SSD blank

1. SSD blank
2. release latch

Next steps

1. Install the hard drive/SSD. See [Installing a hard drive/SSD](#).

Installing a hard-drive/SSD blank

Prerequisites

1. Ensure that you read the [Safety instructions](#).
2. Remove a hard drive/SSD. See [Removing a hard drive/SSD](#).

Steps

Insert the hard-drive/SSD blank into the hard-drive/SSD slot until the release latch clicks into place.

Shutdown procedure for servicing a hard drive/SSD

 **NOTE:** This section applies only to situations where the sled must be powered down to service a hard drive/SSD.

If you need to service a hard drive/SSD, turn off the sled and before removing the hard drive/SSD wait for 30 seconds after the sled's indicator turns off. Otherwise, the hard drive/SSD may not be recognized after it is reinstalled and the sled is powered on again.

Configuring the boot drive

The drive or device from which the system boots is determined by the boot order specified in the System Setup.

Removing a 2.5 inch hard drive/SSD from a 2.5 inch hard-drive/SSD carrier

Prerequisites

 **CAUTION:** Many repairs may only be done by a certified service technician. You should only perform troubleshooting and simple repairs as authorized in your product documentation, or as directed by the online or telephone service and support team. Damage due to servicing that is not authorized by Dell is not covered by your warranty. Read and follow the safety instructions that came with the product.

1. Ensure that you read the [Safety instructions](#).
2. Keep the #1 Phillips screwdriver ready.

Steps

1. Remove the four screws from the slide rails on the hard-drive/SSD carrier.
2. Slide the hard drive/SSD out of the hard-drive/SSD carrier.

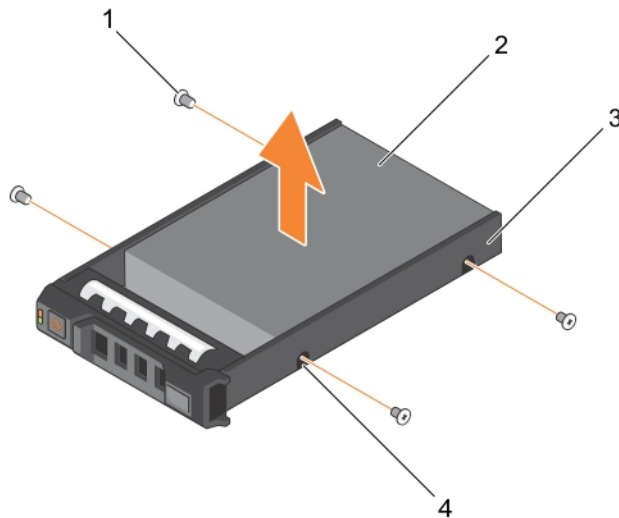

Figure 28. Removing and installing a 2.5 inch hard drive/SSD in a 2.5 inch hard-drive/SSD carrier

- | | |
|---------------------------|-------------------|
| 1. screw (4) | 2. hard drive/SSD |
| 3. hard-drive/SSD carrier | 4. screw hole (4) |

Next steps

Install a new 2.5 inch hard drive/SSD in a 2.5 inch hard-drive/SSD carrier. See [Installing a 2.5 inch hard drive/SSD in a 2.5 inch hard-drive/SSD carrier](#).

Installing a 2.5 inch hard drive/SSD in a 2.5 inch hard-drive/SSD carrier

Prerequisites

CAUTION: Many repairs may only be done by a certified service technician. You should only perform troubleshooting and simple repairs as authorized in your product documentation, or as directed by the online or telephone service and support team. Damage due to servicing that is not authorized by Dell is not covered by your warranty. Read and follow the safety instructions that came with the product.

NOTE: You must remove the hard drive/SSD from a hard-drive/SSD carrier to replace a faulty hard drive/SSD from a hard-drive/SSD carrier.

1. Ensure that you read the [Safety instructions](#).
2. Keep the #1 Phillips screwdriver ready.
3. Remove a 2.5 inch hard drive/SSD from 2.5 inch hard-drive/SSD carrier. See [Removing a 2.5 inch hard drive/SSD from a 2.5 inch hard-drive/SSD carrier](#).

Steps

1. Slide the hard drive/SSD in to the hard-drive/SSD carrier.
2. Align the screw holes on the hard drive/SSD with the holes on the hard-drive/SSD carrier.

 **CAUTION: To avoid damaging the drive or the carrier, do not overtighten the screws.**

3. Fasten the four screws to secure the hard drive/SSD to the hard-drive/SSD carrier.

Removing a 1.8 inch SSD from a 1.8 inch SSD carrier

Prerequisites

 **CAUTION: Many repairs may only be done by a certified service technician. You should only perform troubleshooting and simple repairs as authorized in your product documentation, or as directed by the online or telephone service and support team. Damage due to servicing that is not authorized by Dell is not covered by your warranty. Read and follow the safety instructions that came with the product.**

Ensure that you read the [Safety instructions](#).

Steps

Pull the rails on the side of the carrier and lift the SSD out of the carrier.

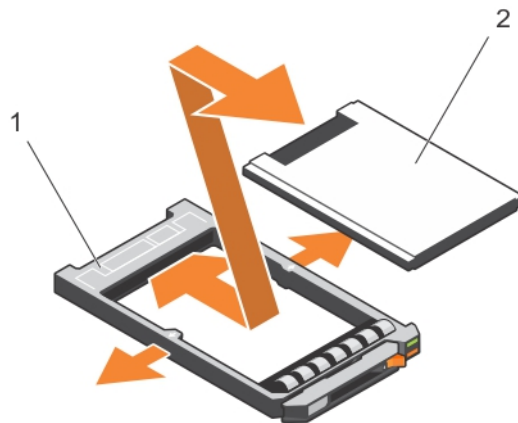

Figure 29. Removing and installing a 1.8 inch SSD in a 1.8 inch SSD carrier

1. SSD carrier
2. SSD

Next steps

Install a 1.8 inch SSD in a 1.8 inch SSD carrier. See [Installing a 1.8 inch SSD in a 1.8 inch SSD carrier](#).

Installing a 1.8 inch SSD in a 1.8 inch SSD carrier

Prerequisites

 **CAUTION:** Many repairs may only be done by a certified service technician. You should only perform troubleshooting and simple repairs as authorized in your product documentation, or as directed by the online or telephone service and support team. Damage due to servicing that is not authorized by Dell is not covered by your warranty. Read and follow the safety instructions that came with the product.

 **NOTE:** You must remove the hard drive/SSD from a hard-drive/SSD carrier to replace a faulty hard drive/SSD from a hard-drive/SSD carrier.

1. Ensure that you read the [Safety instructions](#).
2. Remove a 1.8 inch SSD from a 1.8 inch SSD carrier. See [Removing a 1.8 inch SSD from a 1.8 inch SSD carrier](#).

Steps

Insert the SSD into the SSD carrier with the connector end of the SSD toward the back. When aligned correctly, the back of the SSD is flush with the back of the SSD carrier.

Removing the hard-drive/SSD cage

Prerequisites

 **CAUTION:** Many repairs may only be done by a certified service technician. You should only perform troubleshooting and simple repairs as authorized in your product documentation, or as directed by the online or telephone service and support team. Damage due to servicing that is not authorized by Dell is not covered by your warranty. Read and follow the safety instructions that came with the product.

1. Ensure that you read the [Safety instructions](#).
2. Keep the #1 Phillips screwdriver ready.
3. Follow the procedure listed in [Before working inside your system](#).
4. Remove the hard drive(s)/SSD(s).
5. Remove the hard-drive/SSD backplane. See [Removing the hard-drive/SSD backplane](#).

Steps

1. Remove the two screws securing the hard-drive/SSD cage to the chassis.
2. Holding the hard-drive/SSD cage by its edges, slide it toward the front of the system and remove it from the sled.

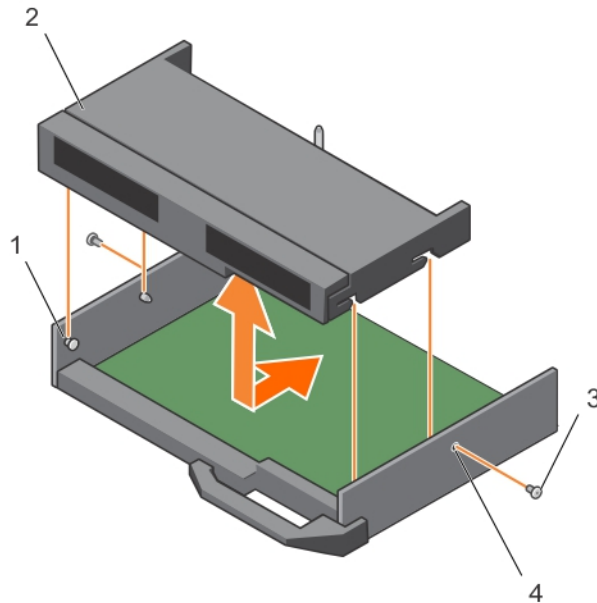

Figure 30. Removing and installing a hard-drive/SSD cage

- | | |
|-----------------|------------------------|
| 1. standoff (4) | 2. hard-drive/SSD cage |
| 3. screw (2) | 4. screw hole (2) |

Next steps

1. Install the hard-drive/SSD cage. See [Installing the hard-drive/SSD cage](#).
2. Install the hard-drive/SSD backplane.
3. Install the hard drive(s)/SSD(s).
4. Follow the procedure listed in [After working inside your system](#).

Related Links

[Removing a hard drive/SSD](#)

Installing the hard-drive/SSD cage

Prerequisites

△ CAUTION: Many repairs may only be done by a certified service technician. You should only perform troubleshooting and simple repairs as authorized in your product documentation, or as directed by the online or telephone service and support team. Damage due to servicing that is not authorized by Dell is not covered by your warranty. Read and follow the safety instructions that came with the product.



NOTE: You must remove the hard-drive/SSD cage to replace a faulty hard-drive/SSD cage or service other components inside the system.

1. Ensure that you read the [Safety instructions](#).
2. Keep the #1 Phillips screwdriver ready.
3. Remove the hard-drive/SSD cage, see [Removing the hard-drive/SSD cage](#).

Steps

1. Align the slots on the sides of the hard-drive/SSD cage with the standoffs on the chassis.
2. Lower the hard-drive/SSD cage into the chassis until the slots on the hard-drive/SSD cage engage with the standoffs on the chassis.
3. Slide the hard-drive/SSD cage into the chassis till it clicks into position.
4. Install the two screws to secure the hard-drive/SSD cage to the chassis.

Next steps

1. Install the hard-drive/SSD backplane. See [Installing the hard-drive/SSD backplane](#).
2. Install the hard drive/SSDs.
3. Follow the procedure listed in [After working inside your system](#).

Related Links

[Installing a hard drive/SSD](#)

Hard-drive backplane

Removing the hard-drive/SSD backplane

Prerequisites



CAUTION: Many repairs may only be done by a certified service technician. You should only perform troubleshooting and simple repairs as authorized in your product documentation, or as directed by the online or telephone service and support team. Damage due to servicing that is not authorized by Dell is not covered by your warranty. Read and follow the safety instructions that came with the product.

1. Ensure that you read the [Safety instructions](#).
2. Keep the #2 Phillips screwdriver ready.
3. Follow the procedure listed in [Before working inside your system](#).



CAUTION: To prevent damage to the hard drives/SSDs and the hard-drive/SSD backplane, you must remove the hard drives/SSDs from the sled before removing the hard-drive/SSD backplane.



CAUTION: You must note the number of each hard drive/SSD and temporarily label them before removal so that you can replace them in the same locations.

4. Remove the hard drive(s)/SSD(s).

Steps

1. Loosen the two retention screws securing the hard-drive/SSD backplane to the hard-drive/SSD cage.
2. Lift the hard-drive/SSD backplane by its edges till the guide pin on the hard-drive/SSD cage disengages with the guide on the hard-drive/SSD backplane.

3. Remove the hard-drive/SSD cage. See [Removing the hard-drive/SSD cage](#).
4. Loosen the two retention screws securing the hard-drive/SSD backplane cable connector to the system board connector.
5. Lift the backplane up and away from the system.

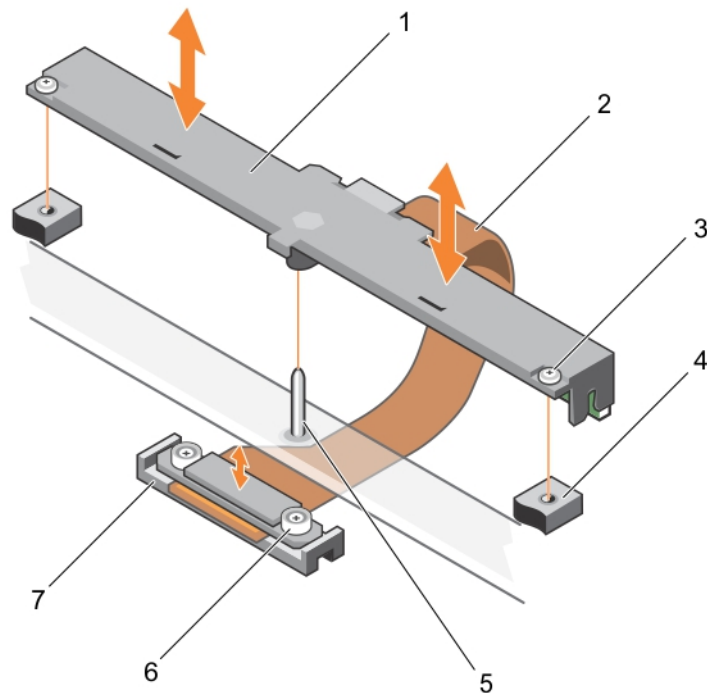

Figure 31. Removing and installing the hard-drive/SSD backplane

- | | |
|-----------------------------|--|
| 1. hard-drive/SSD backplane | 2. hard-drive/SSD backplane cable |
| 3. retention screw (2) | 4. screw hole on the hard-drive/SSD cage (2) |
| 5. guide pin | 6. retention screw on the hard-drive/SSD backplane cable connector (2) |
| 7. connector | |

Next steps

1. Install the hard-drive/SSD backplane, see [Installing the hard-drive/SSD backplane](#).
2. Install the hard drive/SSD.
3. Follow the procedure listed in [After working inside your system](#).

Related Links

[Removing a hard drive/SSD](#)

Installing the hard-drive/SSD backplane

Prerequisites

 **CAUTION:** Many repairs may only be done by a certified service technician. You should only perform troubleshooting and simple repairs as authorized in your product documentation, or as directed by the online or telephone service and support team. Damage due to servicing that is not authorized by Dell is not covered by your warranty. Read and follow the safety instructions that came with the product.

 **NOTE:** You must remove the hard-drive/SSD backplane to replace a faulty hard-drive/SSD backplane or service other components inside the system.

1. Ensure that you read the [Safety instructions](#).
2. Keep the #2 Phillips screwdriver ready.
3. Remove the hard drive/SSD. See [Removing a hard drive/SSD](#).
4. Remove the hard-drive/SSD backplane. See [Removing the hard-drive/SSD backplane](#).

Steps

1. Align the retention screws on the hard-drive/SSD backplane cable connector with the screw holes on the system board connector.
2. Tighten the two retention screws to secure the backplane cable connector on the system board.
3. Install the hard-drive/SSD cage.
4. Align the following:
 - Guide on the hard-drive/SSD backplane with the guide pin on the hard-drive/SSD cage.
 - retention screws on the hard-drive/SSD backplane with the screw holes on the hard-drive/SSD cage.
5. Lower the hard-drive/SSD backplane into place until the retention screws on the hard-drive/SSD backplane engage with the screw holes on the hard-drive/SSD cage.
6. Tighten the two retention screws to secure hard-drive/SSD backplane on the hard-drive/SSD cage.

Next steps

1. Install the hard drives/SSDs in their original locations.
2. Follow the procedure listed in [After working inside your system](#).

Related Links

[Installing the hard-drive/SSD cage](#)

[Installing a hard drive/SSD](#)

PERC H730P slim card

The PERC H730P slim card is supported only on systems with eight 1.8 inch SSDs and two processors.

Removing a PERC H730P slim card

Prerequisites

 **CAUTION:** Many repairs may only be done by a certified service technician. You should only perform troubleshooting and simple repairs as authorized in your product documentation, or as directed by the online or telephone service and support team. Damage due to servicing that is not authorized by Dell is not covered by your warranty. Read and follow the safety instructions that came with the product.

1. Ensure that you read the [Safety instructions](#).
2. Keep the #2 Phillips screwdriver ready.
3. Follow the procedure listed in [Before working inside your system](#).
4. Remove the cooling shroud.

Steps

1. Loosen the two retention screws on the PERC H730P slim-card cable connector.
2. Holding the pull tag, lift the PERC H730P slim-card cable connector from the system board connector.
3. Press the release latch on the side of the chassis to the unlock position and slide the PERC H730P slim card toward the back of the system.

 **CAUTION:** To prevent damage to the PERC H730P slim card, you must hold the card only by its edges.

4. Lift the card up and away from the system.

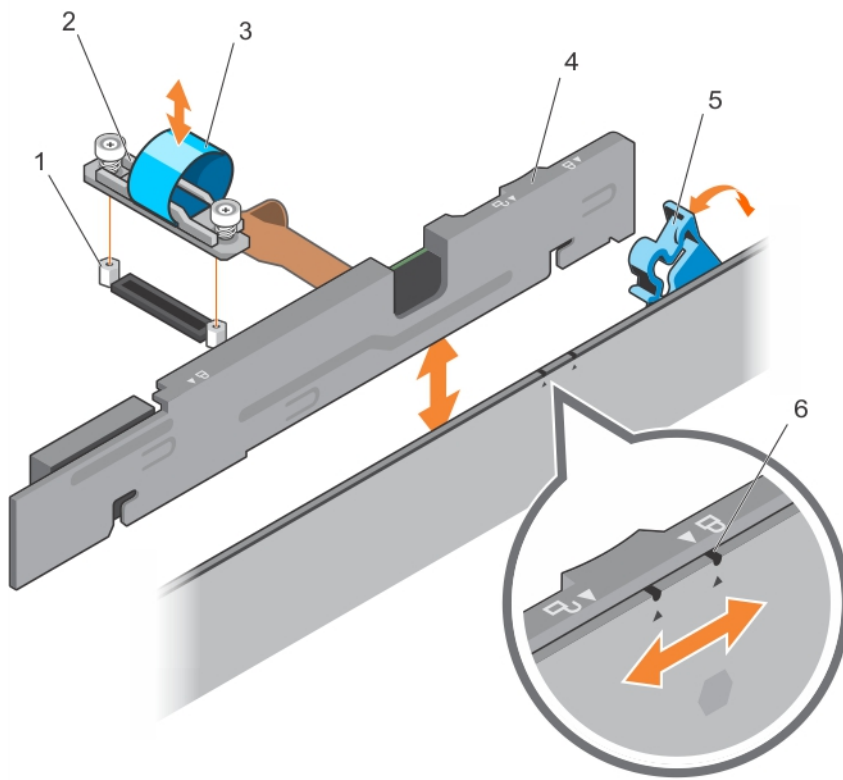

Figure 32. Removing and installing a PERC H730P slim card

- | | |
|-----------------------------|---|
| 1. standoff (2) | 2. PERC H730P slim-card cable connector |
| 3. pull tag | 4. PERC H730P slim card |
| 5. PERC H730P release latch | 6. lock and unlock icon on the PERC H730P slim card bracket |

Related Links

[Removing the cooling shroud](#)

Installing a PERC H730P slim card

Prerequisites

CAUTION: Many repairs may only be done by a certified service technician. You should only perform troubleshooting and simple repairs as authorized in your product documentation, or as directed by the online or telephone service and support team. Damage due to servicing that is not authorized by Dell is not covered by your warranty. Read and follow the safety instructions that came with the product.

1. Ensure that you read the [Safety instructions](#).
2. Keep the #2 Phillips screwdriver ready.

Steps

1. If installed, remove the PERC H730P slim card blank.
2. Press the release latch on the side of the chassis to the unlock position.
 **NOTE:** Ensure that all the memory-module ejectors are in the closed position.
3. Align the slots on the PERC H730P slim card with the standoffs on the side of the chassis.
4. Lower the PERC H730P slim card into the chassis until the slots on the card engage with the standoffs on the side of the chassis.
5. Press the release latch to the lock position to secure the card firmly on the chassis.
The PERC H730P slim card connects to the backplane connector.
6. Hold the pull tag on the PERC H730 slim-card cable connector and route the cable between the memory-module ejectors.
7. Align the retention screws on the PERC H730P slim-card cable connector with the screw holes on the system board connector.
8. Tighten the two retention screws to secure the PERC H730P slim-card cable connector on the system board.

Next steps

Follow the procedure listed in [After working inside your system](#).

Storage controller card

Your system includes a dedicated expansion-card slot on the system board for a storage controller card that provides the integrated storage subsystem for your system's hard drives. The storage controller card supports SSD/SAS/SATA hard drives.

 **NOTE:** The storage controller card is located underneath the hard-drive/SSD cage.

Removing the PCIe extender/storage controller card

Prerequisites

 **CAUTION:** Many repairs may only be done by a certified service technician. You should only perform troubleshooting and simple repairs as authorized in your product documentation, or as directed by the online or telephone service and support team. Damage due to servicing that is not authorized by Dell is not covered by your warranty. Read and follow the safety instructions that came with the product.

 **NOTE:** PCIe extender/storage controller card is supported on systems with the SAS backplanes.

1. Ensure that you read the [Safety instructions](#).
2. Keep the #2 Phillips screwdriver ready.
3. Follow the procedure listed in [Before working inside your system](#).
4. Remove the following:
 - a. hard drives/SSDs
 - b. hard-drive/SSD backplane
 - c. hard-drive/SSD cage

Steps

1. Loosen the two retention screws on the hard-drive/SSD backplane cable connector and lift it away from the PCIe extender/storage controller card.

⚠ CAUTION: To prevent damage to the PCIe extender/storage controller card, you must hold the card only by its edges.

2. Lift the PCIe extender/storage controller card up and away from the system.

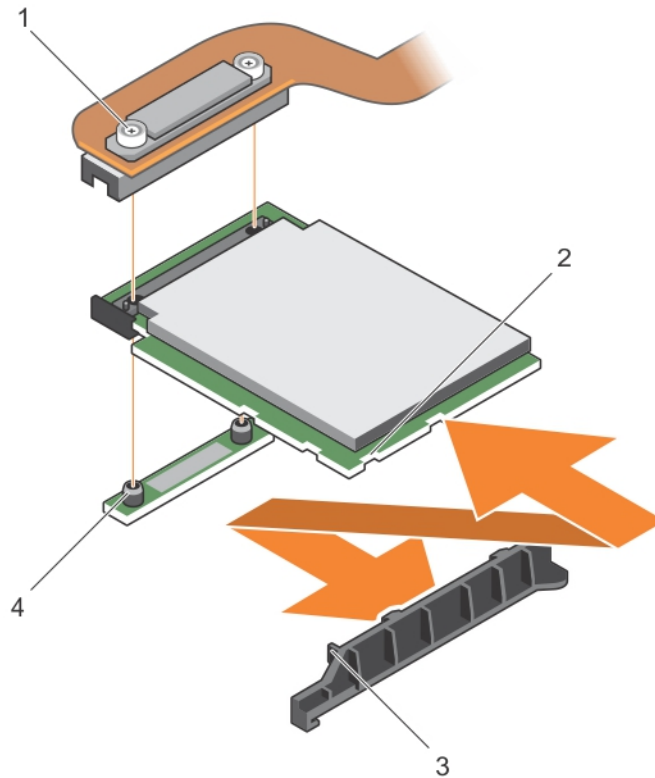

Figure 33. Removing and installing the PCIe extender/storage controller card

- | | |
|---|--|
| 1. retention screw (2) | 2. slot on the PCIe extender/storage controller card |
| 3. tab on the PCIe extender/storage controller card support bracket | 4. standoff (2) |

Next steps

1. Install the PCIe extender/storage controller card. See [Installing the PCIe extender/storage controller card](#).
2. Install the following:
 - a. hard-drive/SSD cage
 - b. hard-drive/SSD backplane
 - c. hard drives/SSDs

3. Follow the procedure listed in [After working inside your system](#).

Related Links

- [Removing a hard drive/SSD](#)
- [Removing the hard-drive/SSD backplane](#)
- [Removing the hard-drive/SSD cage](#)

Installing the PCIe extender/storage controller card

Prerequisites

 **CAUTION:** Many repairs may only be done by a certified service technician. You should only perform troubleshooting and simple repairs as authorized in your product documentation, or as directed by the online or telephone service and support team. Damage due to servicing that is not authorized by Dell is not covered by your warranty. Read and follow the safety instructions that came with the product.

 **NOTE:** PCIe extender/storage controller card is supported on systems with the SAS backplanes.

 **NOTE:** You must remove the PCIe extender/storage controller card to replace a faulty PCIe extender/storage controller card or service other components inside the system.

1. Ensure that you read the [Safety instructions](#).
2. Keep the #2 Phillips screwdriver ready.
3. Remove the PCIe extender/storage controller card. See [Removing the PCIe extender/storage controller card](#).

Steps

1. Align the slots on the PCIe extender/storage controller card edge with the tabs on the support bracket.

 **CAUTION:** To prevent damage to the PCIe extender/storage controller card, you must hold the card only by its edges.

2. Lower the PCIe extender/storage controller card on to the connector on the system board.
3. Tighten the two retention screws on the hard-drive/SSD backplane cable connector to secure the card on to the system board.

Next steps

1. Install the following:
 - a. hard drives/SSDs
 - b. hard-drive/SSD backplane
 - c. hard-drive/SSD cage
2. Follow the procedure listed in [After working inside your system](#).

Related Links

- [Installing a hard drive/SSD](#)
- [Installing the hard-drive/SSD backplane](#)
- [Installing the hard-drive/SSD cage](#)

NVRAM backup battery

Replacing the NVRAM backup battery

Prerequisites

 **WARNING:** There is a danger of a new battery exploding if it is incorrectly installed. Replace the battery only with the same or equivalent type recommended by the manufacturer. Discard used batteries according to the manufacturer's instructions. See the safety instructions that came with your system for additional information.

 **CAUTION:** Many repairs may only be done by a certified service technician. You should only perform troubleshooting and simple repairs as authorized in your product documentation, or as directed by the online or telephone service and support team. Damage due to servicing that is not authorized by Dell is not covered by your warranty. Read and follow the safety instructions that came with the product.

1. Ensure that you read the [Safety instructions](#).
2. Follow the procedure listed in [Before working inside your system](#).
3. Remove the following:
 - a. hard drives/SSDs
 - b. cooling shroud
 - c. hard-drive/SSD backplane
 - d. hard-drive/SSD cage
 - e. PCIe mezzanine card
 - f. NDC
 - g. IDSDM/rSPI card
 - h. system board

Steps

1. Locate the system battery on the system.
2. To remove the battery, press down firmly on the positive side of the connector and lift the battery out of the securing tabs at the negative side of the connector.
3. To install a new system battery:
 - a. Support the battery connector by pressing down firmly on the positive side of the connector.
 - b. Hold the battery with the "+" facing up and slide it under the securing tabs at the positive side of the connector.
4. Press the battery straight down into the connector until it snaps into place.

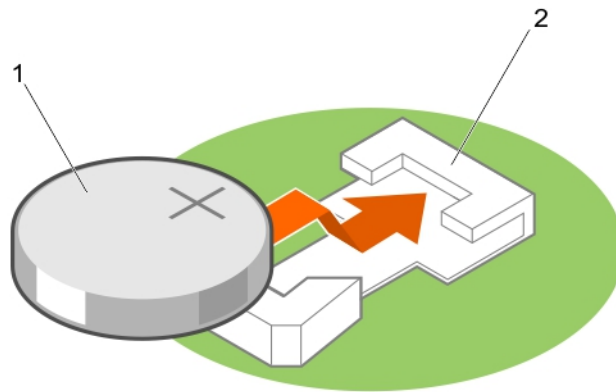

Figure 34. Replacing the NVRAM backup battery

1. positive side of battery
2. negative side of battery connector

Next steps

1. Install the following:
 - a. system board
 - b. IDSDM/rSPI card
 - c. NDC
 - d. PCIe mezzanine cards
 - e. hard-drive/SSD cage
 - f. hard-drive/SSD backplane
 - g. cooling shroud
 - h. hard drives/SSDs
2. Follow the procedure listed in [After working inside your system](#).
3. Enter the System Setup to confirm that the battery is operating properly.
4. Enter the correct time and date in the System Setup's **Time** and **Date** fields.
5. Exit the System Setup.
6. To test the newly installed battery, remove the sled for at least an hour.
7. Reinstall the sled after an hour.
8. Enter the System Setup and if the time and date are still incorrect, see [Getting Help](#).

Related Links



- [Removing a hard drive/SSD](#)
- [Removing the cooling shroud](#)
- [Removing the hard-drive/SSD backplane](#)
- [Removing the hard-drive/SSD cage](#)

[Removing a PCIe mezzanine card](#)
[Removing the Network Daughter Card](#)
[Removing the IDSDM card](#)
[Removing the rSPI card](#)
[Removing the system board](#)
[Installing the system board](#)
[Installing the IDSDM card](#)
[Installing the rSPI card](#)
[Installing the Network Daughter Card](#)
[Installing a PCIe mezzanine card](#)
[Installing the hard-drive/SSD cage](#)
[Installing the hard-drive/SSD backplane](#)
[Installing the cooling shroud](#)
[Installing a hard drive/SSD](#)
[Removing the sled](#)
[Installing the sled](#)

System board

Removing the system board

Prerequisites

-  **CAUTION:** Many repairs may only be done by a certified service technician. You should only perform troubleshooting and simple repairs as authorized in your product documentation, or as directed by the online or telephone service and support team. Damage due to servicing that is not authorized by Dell is not covered by your warranty. Read and follow the safety instructions that came with the product.
 -  **CAUTION:** If you are using Trusted Program Module (TPM) with an encryption key, you may be prompted to create a recovery key during program or System Setup. Be sure to create and safely store this recovery key. If you replace this system board, you must supply the recovery key when you restart your system or program before you can access the encrypted data on your hard drives.
 -  **CAUTION:** Do not attempt to remove the TPM plug-in module from the motherboard. Once the TPM plug-in module is installed, it is cryptographically bound to that specific motherboard. Any attempt to remove an installed TPM plug-in module breaks the cryptographic binding, and it cannot be re-installed or installed on another motherboard.
1. Ensure that you read the [Safety instructions](#).
 2. Keep the #2 Phillips screwdriver and the Hex nut driver-5 mm ready.
 3. Follow the procedure listed in [Before working inside your system](#).
 4. Remove the following:
 - a. processor(s) and heat sink(s)
 - b. memory modules
 - c. cooling shroud
 - d. hard drive/SSDs
 - e. hard-drive/SSD backplane

- f. hard-drive/SSD cage
 - g. PCIe extender/storage controller card
 - h. PCIe mezzanine card
 - i. IDSDM/rSPI card
 - j. NDC
 - k. SD vFlash card
 - l. internal USB key
5. Install an I/O connector cover on the I/O connector(s) at the back of the board.

 **CAUTION: Do not lift the system board assembly by holding a memory module, processor, or other components.**

 **CAUTION: You must temporarily label the hard drive/SSD before removal so that you can replace them in their original locations.**

 **WARNING: The processor and heat sink can become extremely hot. Be sure the processor has had sufficient time to cool before handling.**

 **WARNING: The memory modules are hot to the touch for some time after the system has been powered down. Allow time for the memory modules to cool before handling them. Handle the memory modules by the card edges and avoid touching the components.**

Steps

1. Remove the screws on the system board that secure the system board to the chassis
2. Lift the system board by its back end and angle it upward.
3. Remove the system board from the chassis by disengaging the USB connectors from the slots on the front wall of the chassis.
4. Ensure that the I/O connector cover is still in place on the I/O connector at the back of the board.

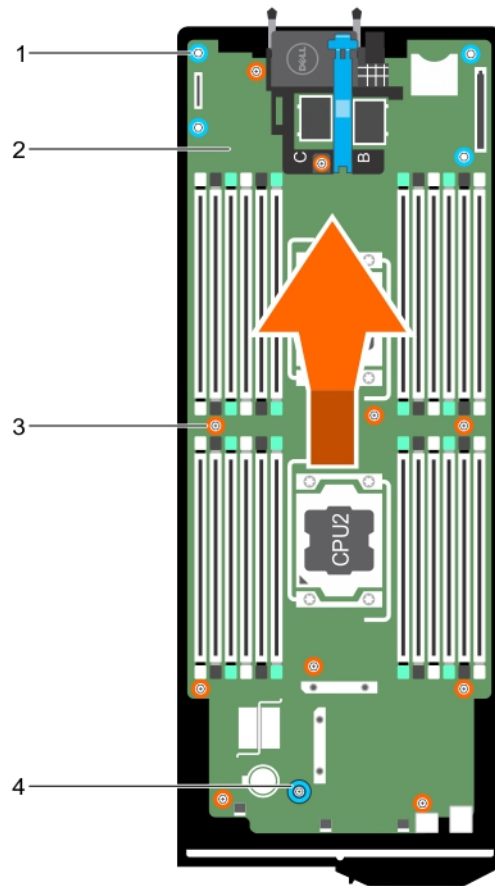

Figure 35. Removing and installing the system board

- | | |
|----------------------|------------------------|
| 1. hex nut screw (4) | 2. system board |
| 3. screw (10) | 4. system board handle |

Next steps

1. Install the system board. See [Installing the system board](#).
2. Follow the procedure listed in [After working inside your system](#).

Related Links

- [Removing a processor](#)
- [Removing memory modules](#)
- [Removing the cooling shroud](#)
- [Removing a hard drive/SSD](#)
- [Removing the hard-drive/SSD backplane](#)
- [Removing the hard-drive/SSD cage](#)

- [Removing a PCIe mezzanine card](#)
- [Removing the Network Daughter Card](#)
- [Removing the IDSDM card](#)
- [Removing the rSPI card](#)
- [Replacing the SD vFlash card](#)
- [Replacing the internal USB key](#)

Installing the system board

Prerequisites

 **CAUTION:** Many repairs may only be done by a certified service technician. You should only perform troubleshooting and simple repairs as authorized in your product documentation, or as directed by the online or telephone service and support team. Damage due to servicing that is not authorized by Dell is not covered by your warranty. Read and follow the safety instructions that came with the product.

 **NOTE:** You must remove the system board to replace a faulty system board.

1. Ensure that you read the [Safety instructions](#).
2. Keep the #2 Phillips screwdriver and the Hex nut driver-5 mm ready.
3. Remove the system board. See [Removing the system board](#).
4. Unpack the new system board assembly.

 **CAUTION:** Do not lift the system board assembly by holding a memory module, processor, or other components.



 **CAUTION:** Take care not to damage the system identification button while placing the system board into the chassis.

Steps

1. Hold the system board by its edges and align the USB connectors with the slots on the front wall of the chassis.
2. Lower the system board until the system board is firmly seated on the chassis.
3. Install the screws to secure the system board to the chassis.

Next steps

1. Install the Trusted Platform Module (TPM). For information on how to install TPM, see [Installing the Trusted Platform Module](#). For information on TPM, see [Trusted Platform Module](#).
2. Install the following:
 - a. internal USB key
 - b. SD vFlash card
 - c. IDSDM/rSPI card
 - d. NDC/LOM riser card
 - e. PCIe mezzanine card
 - f. PCIe extender/storage controller card
 - g. hard-drive/SSD cage
 - h. hard-drive/SSD backplane

- i. hard drive(s)/SSD(s)
 -  **NOTE:** Ensure that you reinstall the hard drives/SSDs in their original locations.
 - j. cooling shroud
 - k. memory modules
 - l. processor(s) and heat sink(s)
3. Follow the procedure listed in [After working inside your system](#).
 -  **NOTE:** If you are not installing the sled in the enclosure, install the I/O connector cover.
 4. Import your new or existing iDRAC Enterprise license. See the *iDRAC8 User's Guide* at dell.com/esmanuals.
 5. Ensure that you:
 - a. Use the Easy Restore feature to restore the Service Tag. For more information, see [Restoring the Service Tag using Easy Restore](#).
 - b. If the Service Tag is not backed up in the backup flash device, enter the system Service Tag manually. For more information, see [Entering the system Service Tag using System Setup](#).
 - c. Update the BIOS and iDRAC versions.
 - d. Re-enable the Trusted Platform Module (TPM). For more information, see [Re-enabling the TPM for BitLocker users](#) or [Re-enabling the TPM for TXT users](#).

Related Links

- [Replacing the internal USB key](#)
- [Replacing the SD vFlash card](#)
- [Installing the IDSDM card](#)
- [Installing the rSPI card](#)
- [Installing the Network Daughter Card](#)
- [Installing a PCIe mezzanine card](#)
- [Installing the PCIe extender/storage controller card](#)
- [Installing the hard-drive/SSD cage](#)
- [Installing the hard-drive/SSD backplane](#)
- [Installing a hard drive/SSD](#)
- [Installing the cooling shroud](#)
- [Installing memory modules](#)
- [Installing a processor](#)

Restoring the Service Tag using Easy Restore

Use the Easy Restore feature if you do not know the Service Tag of your system. The Easy Restore feature allows you to restore your system's Service Tag, license, UEFI configuration, and the system configuration data after replacing the system board. All data is backed up in a rSPI card automatically. If BIOS detects a new system board and the Service Tag in the rSPI card, BIOS prompts the user to restore the backup information.

1. Turn on the system.

If BIOS detects a new system board, and if the Service Tag is present in the rSPI card, BIOS displays the Service Tag, the status of the license, and the **UEFI Diagnostics** version.
2. Do one of the following:
 - Press **Y** to restore the Service Tag, license, and diagnostics information.

- Press **N** to navigate to the Lifecycle Controller based restore options.
- Press <F10> to restore data from a previously created **Hardware Server Profile**.

After the restore process is complete, BIOS prompts to restore the system configuration data.

3. Do one of the following:
 - Press **Y** to restore the system configuration data.
 - Press **N** to use the default configuration settings.

After the restore process is complete, the system reboots.

Entering the system Service Tag using System Setup

If you know the system Service Tag, use the System Setup menu to enter the Service Tag.

1. Turn on the system.
2. Press <F2> to enter the System Setup.
3. Click **Service Tag Settings**.
4. Enter the Service Tag.



NOTE: You can enter the only when the **Service Tag** field is empty. Ensure that you enter the correct Service Tag. Once the Service Tag is entered, it cannot be updated or changed.

5. Click **Ok**.
6. Import your new or existing iDRAC Enterprise license.

For more information, see Integrated Dell Remote Access Controller User's Guide, at dell.com/esmanuals.

Trusted Platform Module

The Trusted Platform Module (TPM) is used to generate/store keys, protect/authenticate passwords, and create/store digital certificates. TPM can also be used to enable the BitLocker hard drive encryption feature in Windows Server.



CAUTION: Do not attempt to remove the Trusted Platform Module (TPM) from the system board. Once the TPM is installed, it is cryptographically bound to that specific system board. Any attempt to remove an installed TPM breaks the cryptographic binding, and it cannot be re-installed or installed on another system board.

Installing the Trusted Platform Module

Prerequisites



CAUTION: Many repairs may only be done by a certified service technician. You should only perform troubleshooting and simple repairs as authorized in your product documentation, or as directed by the online or telephone service and support team. Damage due to servicing that is not authorized by Dell is not covered by your warranty. Read and follow the safety instructions that came with the product.

Ensure that you read the [Safety instructions](#).

Steps

1. Align the edge connectors on the TPM with the slot on the TPM connector.
2. Insert the TPM into the TPM connector such that the plastic bolt aligns with the slot on the system board.

3. Press the plastic bolt until the bolt snaps into place.

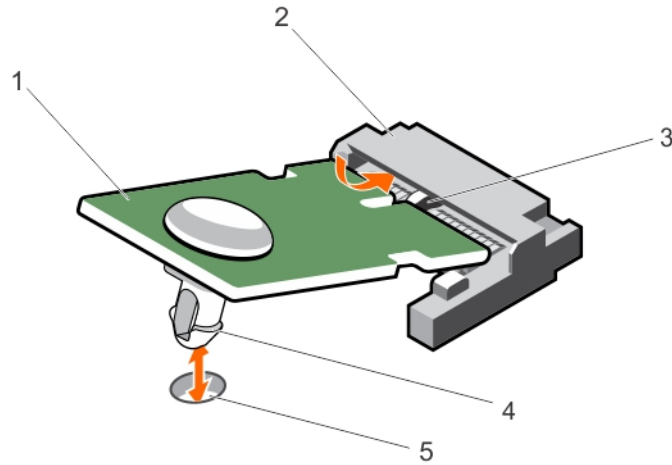

Figure 36. Installing the TPM

- | | |
|------------------------------|------------------|
| 1. TPM | 2. TPM connector |
| 3. slot on the TPM connector | 4. plastic bolt |
| 5. slot on the system board | |

Re-enabling the TPM for BitLocker users

Initialize the TPM.

For more information on initializing the TPM, see <http://technet.microsoft.com/en-us/library/cc753140.aspx>.

The **TPM Status** changes to **Enabled, Activated**.

Re-enabling the TPM for TXT users

1. While booting your system, press <F2> to enter System Setup.
2. In the **System Setup Main Menu**, click **System BIOS** → **System Security Settings**.
3. In the **TPM Security** option, select **On with Pre-boot Measurements**.
4. In the **TPM Command** option, select **Activate**.
5. Save the settings.
6. Restart your system.
7. Enter System Setup again.
8. In the **System Setup Main Menu**, click **System BIOS** → **System Security Settings**.
9. In the **Intel TXT** option, select **On**.

Troubleshooting your system

Safety first—for you and your system

 **CAUTION:** Many repairs may only be done by a certified service technician. You should only perform troubleshooting and simple repairs as authorized in your product documentation, or as directed by the online or telephone service and support team. Damage due to servicing that is not authorized by Dell is not covered by your warranty. Read and follow the safety instructions that came with the product.

 **NOTE:** For troubleshooting information on the FX2 and FX2s enclosure components, see the *Dell PowerEdge FX2 and FX2s Enclosure Owner's Manual* at dell.com/poweredgemanuals.

Troubleshooting system memory

Prerequisites

 **CAUTION:** Many repairs may only be done by a certified service technician. You should only perform troubleshooting and simple repairs as authorized in your product documentation, or as directed by the online or telephone service and support team. Damage due to servicing that is not authorized by Dell is not covered by your warranty. Read and follow the safety instructions that came with the product.

 **NOTE:** Before performing the following procedure, ensure that you have installed the memory modules according to the memory installation guidelines for the sled.

Steps

1. Restart the sled:
 - a. Press the power button once to turn off the sled.
 - b. Press the power button again to turn on the sled.
If no error messages appear, go to step 8.
2. Enter the System Setup and check the system memory setting.
If the amount of memory installed matches the system memory setting, go to step 8.
3. Turn off the sled using the operating system commands or the CMC.
4. Remove the sled from the enclosure.

 **CAUTION:** The memory modules are hot to touch for some time after the sled has been powered down. Allow time for the memory modules to cool before handling them. Handle the memory modules by the card edges and avoid touching the components.

5. Reseat the memory modules in their sockets.
6. Install the sled in the enclosure.
7. Turn on the sled.
8. Run the appropriate diagnostic test. For more information, see [Using System Diagnostics](#).

If the test fails, see [Getting Help](#).

Related Links

[Removing the sled](#)

[Installing the sled](#)

Troubleshooting hard drives

Prerequisites

 **CAUTION:** Many repairs may only be done by a certified service technician. You should only perform troubleshooting and simple repairs as authorized in your product documentation, or as directed by the online or telephone service and support team. Damage due to servicing that is not authorized by Dell is not covered by your warranty. Read and follow the safety instructions that came with the product.

 **CAUTION:** This troubleshooting procedure can destroy data stored on the hard drive. Before you proceed, back up all the files on the hard drive, if possible.

Steps

1. Run the appropriate controllers test and the hard drive tests in system diagnostics.
If the tests fail, go to step 3.
2. Take the hard drive offline and wait until the hard-drive indicator codes on the drive carrier signal that the drive may be removed safely, then remove and reseal the drive carrier in the sled.
3. Restart the sled, enter the System Setup and confirm that the drive controller is enabled.
4. Ensure that any required device drivers are installed and are configured correctly.
 **NOTE:** Installing a hard drive into another bay may break the drive mirroring if the mirror state is optimal.
5. Remove the hard drive and install it in the other drive bay.
6. If the problem is resolved, reinstall the hard drive in the original bay.
If the hard drive functions properly in the original bay, the drive carrier could have intermittent problems. Replace the drive carrier.
7. If the hard drive is the boot drive, ensure that the drive is configured and connected properly.
8. Partition and logically format the hard drive.
9. If possible, restore the files to the drive.
If the problem persists, see [Getting Help](#).

Related Links

[Removing a hard drive/SSD](#)

[Installing a hard drive/SSD](#)

[Hard-drive/SSD indicator patterns](#)

Troubleshooting USB devices

Prerequisites



 **CAUTION:** Many repairs may only be done by a certified service technician. You should only perform troubleshooting and simple repairs as authorized in your product documentation, or as directed by the online or telephone service and support team. Damage due to servicing that is not authorized by Dell is not covered by your warranty. Read and follow the safety instructions that came with the product.

Steps

1. Ensure that the sled is turned on.
2. Check the USB device connection to the sled.
3. Swap the USB device with a known-working USB device.
4. Connect the USB devices to the sled using a powered USB hub.
5. If another sled is installed, connect the USB device to that sled. If the USB device works with a different sled, the first sled may be faulty. See [Getting Help](#).

Troubleshooting Solid State Drives

Prerequisites

-  **CAUTION:** Many repairs may only be done by a certified service technician. You should only perform troubleshooting and simple repairs as authorized in your product documentation, or as directed by the online or telephone service and support team. Damage due to servicing that is not authorized by Dell is not covered by your warranty. Read and follow the safety instructions that came with the product.
-  **CAUTION:** This troubleshooting procedure can destroy data stored on the SSD. Before you proceed, back up all the files on the SSD, if possible.

Steps

1. Run the appropriate tests in system diagnostics.
If the tests fail, go to step 3.
2. Take the SSD offline and wait until the indicator codes on the SSD carrier signal that the SSD may be removed safely, then remove and reseat the SSD carrier in the sled.
3. Restart the sled, enter the System Setup and confirm that the drive controller is enabled.
4. Ensure that any required device drivers are installed and are configured correctly.
 -  **NOTE:** Installing a SSD into another bay may break the mirror if the mirror state is optimal.
5. Remove the SSD and install it in the other SSD slot.
6. If the problem is resolved, reinstall the SSD in the original slot.
If the SSD functions properly in the original slot, the SSD carrier could have intermittent problems. Replace the SSD carrier.
7. If the SSD is the boot drive, ensure that the SSD is configured and connected properly.
8. Partition and logically format the SSD.
9. If possible, restore the files to the SSD.
If the problem persists, see [Getting Help](#).

Related Links

- [Hard-drive/SSD indicator patterns](#)
- [Removing a hard drive/SSD](#)
- [Installing a hard drive/SSD](#)

Troubleshooting an internal SD card

Prerequisites

 **CAUTION:** Many repairs may only be done by a certified service technician. You should only perform troubleshooting and simple repairs as authorized in your product documentation, or as directed by the online or telephone service and support team. Damage due to servicing that is not authorized by Dell is not covered by your warranty. Read and follow the safety instructions that came with the product.

Steps

1. Enter the System Setup and ensure that the **Internal SD Card Port** is enabled.
2. Note the **Internal SD Card Redundancy** option is enabled in the **Integrated Devices** screen of the System Setup (Mirror or Disabled).
3. Turn off the sled using the operating system commands or the CMC.
4. Remove the sled from the enclosure.
5. If the **Internal SD Card Redundancy** option in the **Integrated Devices** screen of the System Setup is set to Mirror mode and SD card 1 has failed:
 - a. Remove the SD card from SD card slot 1.
 - b. Remove the SD card present in SD card slot 2 and insert it into SD card slot 1.
 - c. Install a new SD card in slot 2.
6. If the **Internal SD Card Redundancy** option in the **Integrated Devices** screen of the System Setup is set to Mirror mode and SD card 2 has failed, insert the new SD card into SD card slot 2.
7. If the **Internal SD Card Redundancy** option in **Integrated Devices** screen of the System Setup is set to Disabled, replace the failed SD card with a new SD card.
8. Install the sled in the enclosure.
9. Turn on the sled.
10. Enter the System Setup and ensure that the **Internal SD Card Port** option is enabled and **Internal SD Card Redundancy** option is set to Mirror mode.
11. Check if the SD card is functioning properly.
If the problem persists, see [Getting Help](#).

Related Links

- [Removing the sled](#)
- [Installing the sled](#)
- [Removing a hard drive/SSD](#)

Troubleshooting processors

1. Turn off the sled using the operating system commands or the CMC.
2. Remove the sled from the enclosure.
3. Ensure that the processor(s) and heat sink(s) are properly installed.
4. If your system only has one processor installed, ensure that it is installed in the primary processor socket (CPU1).
5. Install the sled in the enclosure.
6. Turn on the sled.
7. Run the appropriate diagnostic test. For more information, see Using System Diagnostics.
If the problem persists, see [Getting Help](#).

Related Links

- [Removing the sled](#)
- [Installing the sled](#)

Troubleshooting the system board

Prerequisites

 **CAUTION:** Many repairs may only be done by a certified service technician. You should only perform troubleshooting and simple repairs as authorized in your product documentation, or as directed by the online or telephone service and support team. Damage due to servicing that is not authorized by Dell is not covered by your warranty. Read and follow the safety instructions that came with the product.

Steps

1. Turn off the sled using the operating system commands or the CMC.
2. Remove the sled from the enclosure.
3. Clear the sled NVRAM.
4. If the problem persists with the sled, remove and reinstall the sled in the enclosure.
5. Turn on the sled.
6. Run the appropriate diagnostic test. For more information, see [Using System Diagnostics](#).
If the tests fail, see [Getting Help](#).

Related Links

- [Removing the sled](#)
- [Installing the sled](#)

Troubleshooting the NVRAM backup battery

Prerequisites

 **CAUTION:** Many repairs may only be done by a certified service technician. You should only perform troubleshooting and simple repairs as authorized in your product documentation, or as directed by the online or telephone service and support team. Damage due to servicing that is not authorized by Dell is not covered by your warranty. Read and follow the safety instructions that came with the product.

The battery maintains the sled configuration, date, and time information in the NVRAM when the sled is turned off. You may need to replace the battery if an incorrect time or date is displayed during the boot routine.



You can operate the sled without a battery; however, the sled configuration information maintained by the battery in NVRAM is erased each time you remove power from the sled. Therefore, you must re-enter the system configuration information and reset the options each time the sled boots until you replace the battery.

Steps

1. Re-enter the time and date through the System Setup.
2. Turn off the sled using the operating system commands or the CMC.
3. Remove the sled from the enclosure for at least one hour.
4. Install the sled in the enclosure.

5. Turn on the sled.
6. Enter the System Setup.

If the date and time are not correct in the System Setup, replace the battery. If the problem is not resolved by replacing the battery, see [Getting Help](#).

-  **NOTE:** If the sled is turned off for long periods of time (for weeks or months), the NVRAM may lose its system configuration information. This situation is caused by a defective battery.
-  **NOTE:** Some software may cause the sled's time to speed up or slow down. If the sled operates normally except for the time maintained by the System Setup, the problem may be caused by a software rather than by a defective battery.

Related Links

- [Removing the sled](#)
- [Installing the sled](#)
- [Replacing the NVRAM backup battery](#)

System messages

For a list of event and error messages generated by the system firmware and agents that monitor system components, see the Dell Event and Error Messages Reference Guide at dell.com/esmanuals.

Warning messages

A warning message alerts you to a possible problem and prompts you to respond before the system continues a task. For example, before you format a hard drive, a message warns you that you may lose all data on the hard drive. Warning messages usually interrupt the task and require you to respond by typing y (yes) or n (no).

-  **NOTE:** Warning messages are generated by either the application or the operating system. For more information, see the documentation that accompanied the operating system or application.

Diagnostic messages

The system diagnostic utilities may issue messages if you run diagnostic tests on your system. See [Using System Diagnostics](#) for more information about system diagnostics.

Alert messages

The systems management software generates alert messages for your system. Alert messages include information, status, warning, and failure messages for drive, temperature, fan, and power conditions. For more information, see the systems management software documentation.

Using System Diagnostics

If you experience a problem with your system, run the system diagnostics before contacting Dell for technical assistance. The purpose of running system diagnostics is to test your system hardware without requiring additional equipment or risking data loss. If you are unable to fix the problem yourself, service and support personnel can use the diagnostics results to help you solve the problem.

Dell Embedded System Diagnostics

 **NOTE:** The Dell Embedded System Diagnostics is also known as Enhanced Pre-boot System Assessment (ePSA) diagnostics.

The embedded system diagnostics provides a set of options for particular device groups or devices allowing you to:

- Run tests automatically or in an interactive mode
- Repeat tests
- Display or save test results
- Run thorough tests to introduce additional test options to provide extra information about the failed device(s)
- View status messages that inform you if tests are completed successfully
- View error messages that inform you of problems encountered during testing

When to use the Embedded System Diagnostics

If a major component or device in the system does not operate properly, running the embedded system diagnostics may indicate component failure.

Running the Embedded System Diagnostics

The embedded system diagnostics program is run from the Dell Lifecycle Controller.

Prerequisites

 **CAUTION:** Use the embedded system diagnostics to test only your system. Using this program with other systems may cause invalid results or error messages.

Steps

1. As the system boots, press <F11>.
2. Use the up and down arrow keys to select **System Utilities** → **Launch Dell Diagnostics**.
The **ePSA Pre-boot System Assessment** window is displayed, listing all devices detected in the system. The diagnostics starts executing the tests on all the detected devices.

Running Embedded System Diagnostics from an external media

1. Format the external resource media (USB flash drive or CDROM) to emulate a hard drive.
See the documentation that came with the resource media for instructions.
2. Configure the resource media to be a bootable device.
3. Create a directory for the system diagnostics on the resource media.
4. Copy the system diagnostics files into the directory.
To download the Dell diagnostics utility, go to **dell.com/support**.
5. Connect the resource media on your system.
6. As the system boots, press <F11>.
7. When prompted, select the media to perform a one-time boot.
If diagnostics does not start automatically after the diagnostic media is booted, enter **psa** at the command prompt.

System diagnostics controls

Menu	Description
Configuration	Displays the configuration and status information of all detected devices.
Results	Displays the results of all tests that are executed.
System Health	Provides the current overview of the system performance.
Event Log	Displays a time-stamped log of the results of all tests run on the system. This is displayed if at least one event description is recorded.

For information about embedded system diagnostics, see the *Dell Enhanced Pre-boot System Assessment User Guide* at **dell.com/support/home**.

Jumpers and connectors

System board jumper settings

⚠ CAUTION: Many repairs may only be done by a certified service technician. You should only perform troubleshooting and simple repairs as authorized in your product documentation, or as directed by the online or telephone service and support team. Damage due to servicing that is not authorized by Dell is not covered by your warranty. Read and follow the safety instructions that came with the product.

For information on resetting the password jumper to disable a password, see [Disabling a forgotten password](#).

Table 5. System Board Jumper settings

Jumper	Setting	Description
PWRD_EN	1 2 3 (default)	The password feature is enabled (pins 1–2).
	1 2 3	The password feature is disabled (pins 2–3).
NVRAM_CLR	1 2 3 (default)	The configuration settings are retained at system boot (pins 2–3).
	1 2 3	The configuration settings are cleared at the next system boot. (pins 1–2).

System board connectors

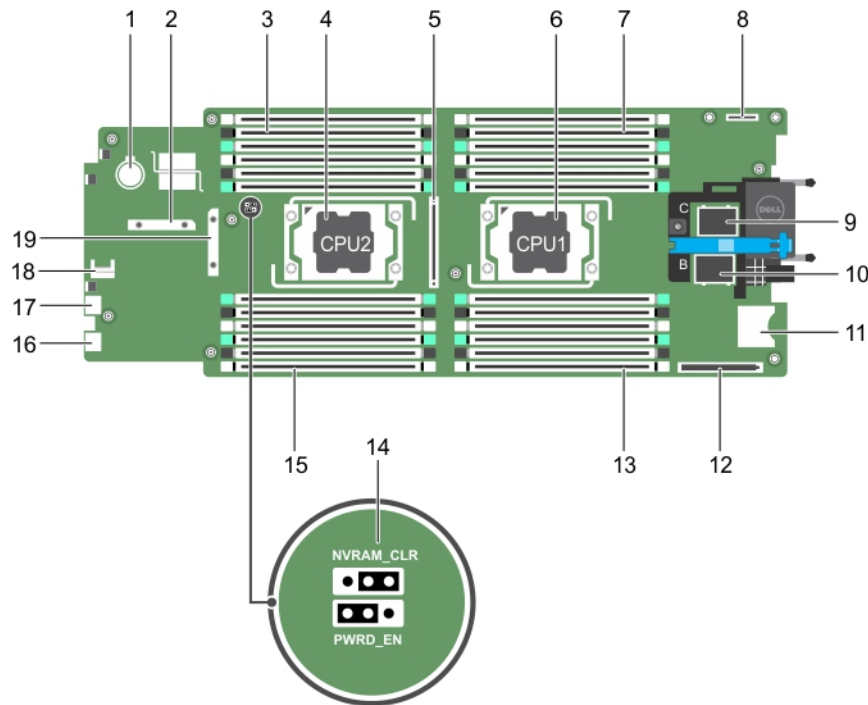



Figure 37. System board connectors

Table 6. System board connectors

Item	Connector	Description
1	BATTERY	Connector for the 3.0 V coin cell battery
2	STORAGE	Storage controller card connector
3	B3, B7, B11, B4, B8, B12	Memory module sockets (processor 2)
4	CPU2	Processor socket 2
5	J_PCIE_SEARAY	PERC H730P Slim PERC card connector
6	CPU1	Processor socket 1
7	A1, A5, A9, A2, A6, A10	Memory module sockets (processor 1)
8	IDSDM/rSPI	IDSDM/rSPI card connector
9	MEZZ1_FAB_C	PCIe mezzanine card connector for the expansion bus
10	MEZZ2_FAB_B	PCIe mezzanine card connector for the expansion bus
11	VFLASH	SD vFlash card connector
12	bNDC	Network daughter card connector

Item	Connector	Description
13	A3, A7, A11, A4, A8, A12	Memory module sockets (processor 1)
14	PWRD_EN, NVRAM_CLR	System configuration jumpers
		 NOTE: Access requires removal of system board.
15	B1, B5, B9, B2, B6, B10	Memory module sockets (processor 2)
16	USB2	USB connector
17	USB1	USB connector
18	TPM	TPM connector
19	J_BP	Hard-drive backplane connector

Disabling a forgotten password

The software security features of sled include a system password and a setup password. The password jumper enables these password features or disables them, and clears any password(s) currently in use.

Prerequisites

 **CAUTION:** Many repairs may only be done by a certified service technician. You should only perform troubleshooting and simple repairs as authorized in your product documentation, or as directed by the online or telephone service and support team. Damage due to servicing that is not authorized by Dell is not covered by your warranty. Read and follow the safety instructions that came with the product.

Steps

1. Turn off the sled using the operating system commands or the CMC.
2. Remove the sled from the enclosure to access the jumpers.
3. Move the jumper on the system-board jumper from pins 2 and 3 to pins 1 and 2.
4. Install the sled in the enclosure.
5. Turn on the sled.

When the sled is on, the power-on indicator is solid green. Allow the sled to finish booting.

The existing passwords are not disabled (erased) until the system boots with the password jumper on pins 1 and 2. However, before you assign a new system and/or setup password, you must reinstall the password jumper back to pins 2 and 3.

 **NOTE:** If you assign a new system and/or setup password with the jumper on pins 1 and 2, the system disables the new password(s) the next time it boots.

6. Turn off the sled using the operating system commands or the CMC.
7. Remove the sled from the enclosure to access the jumpers.
8. Move the jumper on the system-board jumper from pins 1 and 2 to pins 2 and 3.
9. Install the sled in the enclosure.
10. Turn on the sled.
11. Assign a new system and/or setup password.

Related Links

[Removing the sled](#)

[Installing the sled](#)

Technical specifications

Physical	
Height	4.03 cm (1.58 inch)
Width	21.1 cm (8.3 inch)
Depth	53.58 cm (21.09 inch)
Weight (maximum)	6.4 kg (14.11 lb)
Processor	
Processor type	One or two Intel Xeon processor E5-2600 v3 product family
Memory	
Architecture	2133 MT/s, 1866 MT/s, 1600 MT/s, or 13333 MT/s DDR4 DIMMs
Memory module sockets	Twenty-four 288-pin
Memory module capacities	
RDIMMs	4 GB (single-rank), 8 GB (dual-rank), and 16 GB (dual-rank)
LRDIMMs	32 GB (quad-rank)
Minimum RAM	4 GB (single processor configuration)
Maximum RAM	768 GB (with 32 GB LRDIMMs)
RAID controllers	
Controller types	PERC H730P, PERC H730, PERC H330, and PERC H730P slim card
Drives	
Hard drives	Up to two 2.5-inch, hot-swap SAS/SATA hard drives or SAS/SATA/PCIe SSDs
SSDs	Up to eight 1.8-inch, hot-swap SATA SSDs
Optical drive	External optional USB DVD
	 NOTE: DVD devices are data only.

Drives

Flash drive	Internal optional USB Internal optional SD card Optional vFlash card (with integrated iDRAC8 Enterprise)
-------------	--

Connectors

Front	
USB	One 4-pin, USB 2.0-compliant and one 4-pin, USB 3.0-compliant
Internal	
SD	Two internal SD cards dedicated for the hypervisor One SD card dedicated for future vFlash support

PCIe mezzanine card

PCIe mezzanine card slots	One PCIe x16 Gen 3 slot that supports PCIe mezzanine card
---------------------------	---

Video

Video type	Matrox G200 VGA controller integrated with iDRAC
Video memory	2 GB shared with iDRAC application memory

Battery

NVRAM backup battery	CR 2032 3.0 V lithium coin cell
----------------------	---------------------------------

Environmental specifications

 **NOTE:** For additional information about environmental measurements for specific system configurations, see dell.com/environmental_datasheets.

Temperature

Storage	-40°C to 65°C (-40°F to 149°F)
Continuous operation (for altitude less than 950 m or 3117 ft)	10°C to 35°C (50°F to 95°F) with no direct sunlight on the equipment.
Fresh air	For information on fresh air, see Expanded Operating Temperature section.
Maximum temperature gradient (operating and storage)	20°C/h (36°F/h)

Environmental specifications

Relative humidity

Storage	5% to 95% RH with 33°C (91°F) maximum dew point. Atmosphere must be non-condensing at all times.
Operating	10% to 80% Relative Humidity with 29°C (84.2°F) maximum dew point.

Maximum vibration

Operating	0.26 G _{rms} at 5 Hz to 350 Hz (all operation orientations).
Storage	1.88 G _{rms} at 10 Hz to 500 Hz for 15 min (all six sides tested).

Maximum shock

Operating	Six consecutively executed shock pulses in the positive and negative x, y, and z axes of 40 G for up to 2.3 ms.
Storage	Six consecutively executed shock pulses in the positive and negative x, y, and z axes (one pulse on each side of the system) of 71 G for up to 2 ms.

Maximum altitude

Operating	3048 m (10,000 ft).
Storage	12,000 m (39,370 ft).

Operating temperature de-rating

Up to 35 °C (95 °F)	Maximum temperature is reduced by 1°C/300 m (1°F/547 ft) above 950 m (3,117 ft).
35 °C to 40 °C (95 °F to 104 °F)	Maximum temperature is reduced by 1°C/175 m (1°F/319 ft) above 950 m (3,117 ft).
40 °C to 45 °C (104 °F to 113 °F)	Maximum temperature is reduced by 1°C/125 m (1°F/228 ft) above 950 m (3,117 ft).

Particulate contamination

 **NOTE:** This section defines the limits to help avoid IT equipment damage and/or failure from particulates and gaseous contamination. If it is determined that levels of particulates or gaseous pollution are beyond the limits specified below and are the reason for the damage and/or failures to your equipment, it may be necessary for you to re-mediate the environmental conditions that are causing the damage and/or failures. Re-mediation of environmental conditions will be the responsibility of the customer.

Air filtration	Data center air filtration as defined by ISO Class 8 per ISO 14644-1 with a 95% upper confidence limit.
----------------	---

Expanded operating temperature

For temperatures between 40°C and 45°C, de-rate maximum allowable temperature by 1°C per 125 m above 950 m (1°F per 228 ft).

Expanded operating temperature restrictions

- Do not perform a cold startup below 5 °C.
- Maximum 105 W processor is supported.
- The following do not support the expanded operating temperature range:
 - PCIe SSDs
 - Non Dell-qualified peripheral cards and/or peripheral cards greater than 25 W
- When populating the sled slots in the FX2s enclosure with only PowerEdge FC630 sleds:
 - Install 104 mm width heat sink for processors of less than 105 W.
 - If you install a sled with two processors in the FX2s enclosure, all sled slots in the enclosure must have PowerEdge FC630 sleds with the same configuration. However, vacant sled slots in the enclosure can be installed with sled blanks.

Getting help

Contacting Dell

Dell provides several online and telephone-based support and service options. If you do not have an active Internet connection, you can find contact information on your purchase invoice, packing slip, bill, or Dell product catalog. Availability varies by country and product, and some services may not be available in your area. To contact Dell for sales, technical support, or customer-service issues:

1. Go to **dell.com/support**.
2. Select your country from the drop-down menu on the bottom right corner of the page.
3. For customized support:
 - a. Enter your system Service Tag in the **Enter your Service Tag** field.
 - b. Click **Submit**.
4. For general support:
 - a. Select your product category.
 - b. Select your product segment.
 - c. Select your product.

The support page that lists the various support categories is displayed.

The support page that lists the various support categories is displayed.

Documentation feedback

If you have feedback for this document, write to **documentation_feedback@dell.com**. Alternatively, you can click on the **Feedback** link in any of the Dell documentation pages, fill out the form, and click **Submit** to send your feedback.

Locating your system Service Tag

Your system is identified by a unique Mini Express Service Tag and Service Tag number. The Mini Express Service Tag is found on the front of the system and Service Tag is found on the side of the system. This information is used by Dell to route support calls to the appropriate personnel.

Quick Resource Locator

Use the Quick Resource Locator (QRL) to get immediate access to system information and how-to videos. This can be done by visiting **dell.com/QRL** or by using your smartphone and a model specific Quick Resource (QR) code located on your Dell PowerEdge system. To try out the QR code, scan the following image.



Free Manuals Download Website

<http://myh66.com>

<http://usermanuals.us>

<http://www.somanuals.com>

<http://www.4manuals.cc>

<http://www.manual-lib.com>

<http://www.404manual.com>

<http://www.luxmanual.com>

<http://aubethermostatmanual.com>

Golf course search by state

<http://golfingnear.com>

Email search by domain

<http://emailbydomain.com>

Auto manuals search

<http://auto.somanuals.com>

TV manuals search

<http://tv.somanuals.com>