

DENON

AM-FM STEREO RECEIVER

DRA-CX3

Owner's Manual

Manuel de l'Utilisateur

Manual del usuario

SAFETY PRECAUTIONS



CAUTION
RISK OF ELECTRIC SHOCK
DO NOT OPEN



CAUTION:
TO REDUCE THE RISK OF ELECTRIC SHOCK, DO NOT REMOVE COVER (OR BACK). NO USER-SERVICEABLE PARTS INSIDE. REFER SERVICING TO QUALIFIED SERVICE PERSONNEL.

The lightning flash with arrowhead symbol, within an equilateral triangle, is intended to alert the user to the presence of uninsulated "dangerous voltage" within the product's enclosure that may be of sufficient magnitude to constitute a risk of electric shock to persons.

The exclamation point within an equilateral triangle is intended to alert the user to the presence of important operating and maintenance (servicing) instructions in the literature accompanying the appliance.

WARNING:
TO REDUCE THE RISK OF FIRE OR ELECTRIC SHOCK, DO NOT EXPOSE THIS APPLIANCE TO RAIN OR MOISTURE.

Location of Rating and Caution Labels : Bottom

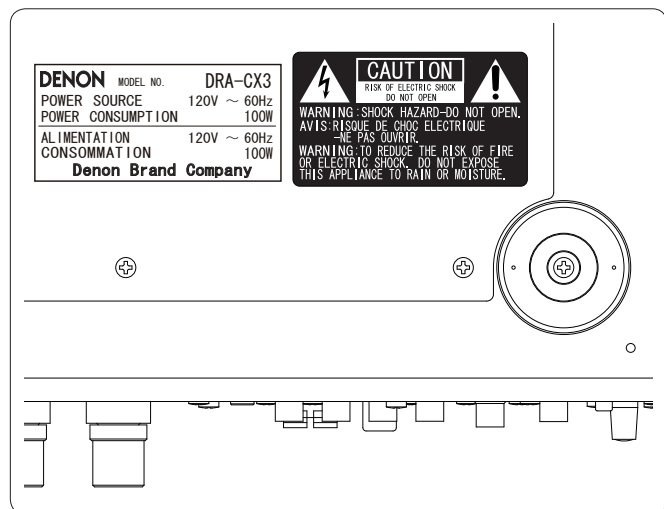

IMPOTANT SAFETY INSTRUCTIONS

1. Read these instructions.
2. Keep these instructions.
3. Heed all warnings.
4. Follow all instructions.
5. Do not use this apparatus near water.
6. Clean only with dry cloth.
7. Do not block any ventilation openings. Install in accordance with the manufacturer's instructions.
8. Do not install near any heat sources such as radiators, heat registers, stoves, or other apparatus (including amplifiers) that produce heat.
9. Do not defeat the safety purpose of the polarized or grounding-type plug. A polarized plug has two blades with one wider than the other. A grounding type plug has two blades and a third grounding prong. The wide blade or the third prong are provided for your safety. If the provided plug does not fit into your outlet, consult an electrician for replacement of the obsolete outlet.
10. Protect the power cord from being walked on or pinched particularly at plugs, convenience receptacles, and the point where they exit from the apparatus.
11. Only use attachments/accessories specified by the manufacturer.
12. Use only with the cart, stand, tripod, bracket, or table specified by the manufacturer, or sold with the apparatus. When a cart is used, use caution when moving the cart/apparatus combination to avoid injury from tip-over. 
13. Unplug this apparatus during lightning storms or when unused for long periods of time.
14. Refer all servicing to qualified service personnel. Servicing is required when the apparatus has been damaged in any way, such as power-supply cord or plug is damaged, liquid has been spilled or objects have fallen into the apparatus, the apparatus has been exposed to rain or moisture, does not operate normally, or has been dropped.
15. Batteries shall not be exposed to excessive heat such as sunshine, fire or the like.

CAUTION:

- The ventilation should not be impeded by covering the ventilation openings with items, such as newspapers, tablecloths, curtains, etc.
- No naked flame sources, such as lighted candles, should be placed on the unit.
- Observe and follow local regulations regarding battery disposal.
- Do not expose the unit to dripping or splashing fluids.
- Do not place objects filled with liquids, such as vases, on the unit.

ATTENTION:

- La ventilation ne doit pas être gênée en recouvrant les ouvertures de la ventilation avec des objets tels que journaux, rideaux, tissus, etc.
- Aucune flamme nue, par exemple une bougie, ne doit être placée sur l'appareil.
- Veuillez à respecter les lois en vigueur lorsque vous jetez les piles usagées.
- L'appareil ne doit pas être exposé à l'eau ou à l'humidité.
- Ne pas poser d'objet contenant du liquide, par exemple un vase, sur l'appareil.

PRECAUCIÓN:

- La ventilación no debe quedar obstruida por haberse cubierto las aperturas con objetos como periódicos, manteles, cortinas, etc.
- No debe colocarse sobre el aparato ninguna fuente inflamable sin protección, como velas encendidas.
- A la hora de deshacerse de las pilas, respete la normativa para el cuidado del medio ambiente.
- No exponer el aparato al goteo o salpicaduras cuando se utilice.
- No colocar sobre el aparato objetos llenos de líquido, como jarros.

CAUTION:

To completely disconnect this product from the mains, disconnect the plug from the wall socket outlet. The mains plug is used to completely interrupt the power supply to the unit and must be within easy access by the user.

PRECAUTION:

Pour déconnecter complètement ce produit du courant secteur, débranchez la prise de la prise murale. La prise secteur est utilisée pour couper complètement l'alimentation de l'appareil et l'utilisateur doit pouvoir y accéder facilement.

PRECAUCIÓN:

Para desconectar completamente este producto de la alimentación eléctrica, desconecte el enchufe del enchufe de la pared. El enchufe de la alimentación eléctrica se utiliza para interrumpir por completo el suministro de alimentación eléctrica a la unidad y debe de encontrarse en un lugar al que el usuario tenga fácil acceso.

FCC INFORMATION (For US customers)

1. PRODUCT

This product complies with Part 15 of the FCC Rules. Operation is subject to the following two conditions: (1) this product may not cause harmful interference, and (2) this product must accept any interference received, including interference that may cause undesired operation.

2. IMPORTANT NOTICE: DO NOT MODIFY THIS PRODUCT

This product, when installed as indicated in the instructions contained in this manual, meets FCC requirements. Modification not expressly approved by DENON may void your authority, granted by the FCC, to use the product.

3. NOTE







This product has been tested and found to comply with the limits for a Class B digital device, pursuant to Part 15 of the FCC Rules. These limits are designed to provide reasonable protection against harmful interference in a residential installation.

This product generates, uses and can radiate radio frequency energy and, if not installed and used in accordance with the instructions, may cause harmful interference to radio communications. However, there is no guarantee that interference will not occur in a particular installation. If this product does cause harmful interference to radio or television reception, which can be determined by turning the product OFF and ON, the user is encouraged to try to correct the interference by one or more of the following measures:

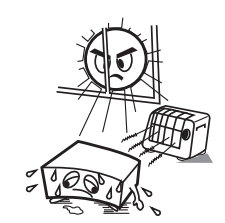
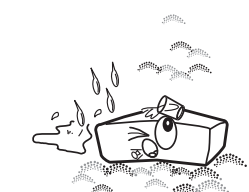
- Reorient or relocate the receiving antenna.
- Increase the separation between the equipment and receiver.
- Connect the product into an outlet on a circuit different from that to which the receiver is connected.
- Consult the local retailer authorized to distribute this type of product or an experienced radio/TV technician for help.

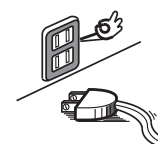
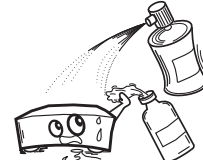
This Class B digital apparatus complies with Canadian ICES-003.
Cet appareil numérique de la classe B est conforme à la norme NMB-003 du Canada.

NOTE ON USE / OBSERVATIONS RELATIVES A L'UTILISATION / NOTAS SOBRE EL USO

 <ul style="list-style-type: none"> • Avoid high temperatures. Allow for sufficient heat dispersion when installed in a rack. • Éviter des températures élevées. Tenir compte d'une dispersion de chaleur suffisante lors de l'installation sur une étagère. • Evite altas temperaturas. Permite la suficiente dispersión del calor cuando está instalado en la consola. 	 <ul style="list-style-type: none"> • Keep the unit free from moisture, water, and dust. • Protéger l'appareil contre l'humidité, l'eau et la poussière. • Mantenga el equipo libre de humedad, agua y polvo. 	 <ul style="list-style-type: none"> • Do not let foreign objects into the unit. • Ne pas laisser des objets étrangers dans l'appareil. • No deje objetos extraños dentro del equipo.
 <ul style="list-style-type: none"> • Handle the power cord carefully. Hold the plug when unplugging the cord. • Manipuler le cordon d'alimentation avec précaution. Tenir la prise lors du débranchement du cordon. • Maneje el cordón de energía con cuidado. Sostenga el enchufe cuando desconecte el cordón de energía. 	 <ul style="list-style-type: none"> • Unplug the power cord when not using the unit for long periods of time. • Débrancher le cordon d'alimentation lorsque l'appareil n'est pas utilisé pendant de longues périodes. • Desconecte el cordón de energía cuando no utilice el equipo por mucho tiempo. 	 <ul style="list-style-type: none"> • Do not let insecticides, benzene, and thinner come in contact with the unit. • Ne pas mettre en contact des insecticides, du benzène et un diluant avec l'appareil. • No permita el contacto de insecticidas, gasolina y diluyentes con el equipo.
 <ul style="list-style-type: none"> • Handle the power cord carefully. Hold the plug when unplugging the cord. • Manipuler le cordon d'alimentation avec précaution. Tenir la prise lors du débranchement du cordon. • Maneje el cordón de energía con cuidado. Sostenga el enchufe cuando desconecte el cordón de energía. 	 <p>* (For apparatuses with ventilation holes)</p> <ul style="list-style-type: none"> • Do not obstruct the ventilation holes. • Ne pas obstruer les trous d'aération. • No obstruya los orificios de ventilación. 	 <ul style="list-style-type: none"> • Never disassemble or modify the unit in any way. • Ne jamais démonter ou modifier l'appareil d'une manière ou d'une autre. • Nunca desarme o modifique el equipo de ninguna manera.

Contents

Getting Started

- Accessories 1
- Cautions on handling 1
- Cautions on installation 1
- About the remote control unit 2
 - Inserting the batteries 2
 - Operating range of the remote control unit 2
- Part names and functions 3
 - Front panel 3
 - Display 3
 - Rear panel 3
 - Remote control unit 4

Connections

- Cable indications 5
- Speaker connections 5
 - Connecting the speaker cables 5, 6
- Connecting the antenna terminals 6
- Connecting a CD player 7
- Connecting a turntable 7
- Connecting an iPod® 7
- Connecting a tape deck, CD recorder or MD recorder 7
- Connecting the power cord 8

Operation

- Turning the power on 9
- Conducting playback 9
 - Adjusting the tone 9
 - Playing with higher quality sound (Pure Direct mode) 9
- Recording 10
- Tuning in radio broadcasts 10
- Presetting 10
 - Giving a name to the currently tuned in broadcast station and presetting it 10
 - Presetting broadcast stations automatically (Auto preset) 11
 - Listening to preset broadcast stations 11
- iPod® playback 11

- Troubleshooting 12

- Specifications 13

Getting Started

Thank you for purchasing this DENON product. To ensure proper operation, please read this owner's manual carefully before using the product.

After reading them, be sure to keep them for future reference.

Accessories

Check that the following parts are supplied with the product.

- ① Owner's Manual 1
- ② Warranty (for North America model only) 1
- ③ Service station list 1
- ④ Power cord (Cord length: Approx. 6.5 ft / 2 m) 1
- ⑤ Remote control (RC-1060) 1
- ⑥ R03/AAA batteries 2
- ⑦ AM loop antenna 1
- ⑧ FM indoor antenna 1

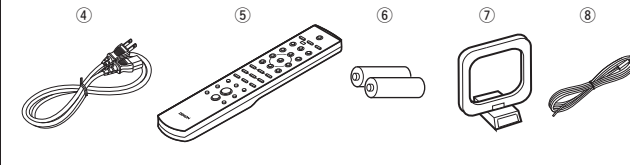

Cautions on handling

- **Before turning the power switch on**
Check once again that all connections are correct and that there are no problems with the connection cables.
- Power is supplied to some of the circuitry even when the unit is set to the standby mode. When traveling or leaving home for long periods of time, be sure to unplug the power cord from the power outlet.
- **Cautions on using mobile phones**
Using a mobile phone near this unit may result in noise. If so, move the mobile phone away from this unit when it is in use.
- **Moving the unit**
Turn off the power and unplug the power cord from the power outlet.
Next, disconnect the connection cables to other system units before moving the unit.
- Note that the illustrations in these instructions may differ from the actual unit for explanation purposes.

Cautions on installation

Note:
For proper heat dispersal, do not install this unit in a confined space, such as a bookcase or similar enclosure.

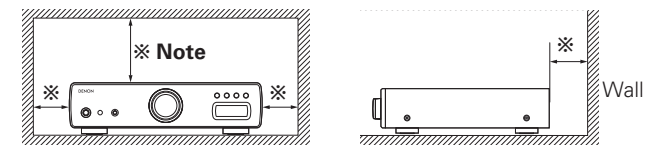

About the remote control unit

The included remote control unit (RC-1060) can be used to control the DENON DCD-CX3 Super Audio CD player in addition to the DRA-CX3 (see page 4).

Inserting the batteries

- ① Remove the remote control unit's rear cover.
- ② Set two R03/AAA batteries in the battery compartment in the indicated direction.

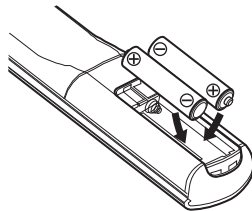
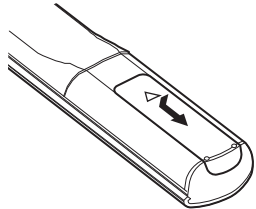

- ③ Put the rear cover back on.

NOTE

- Replace the batteries with new ones if the set does not operate even when the remote control unit is operated close to the unit. (The supplied batteries are only for verifying operation.)
- When inserting the batteries, be sure to do so in the proper direction, following the "⊕" and "⊖" marks in the battery compartment.
- To prevent damage or leakage of battery fluid:
 - Do not use a new battery together with an old one.
 - Do not use two different types of batteries.
 - Do not attempt to charge dry batteries.
 - Do not short-circuit, disassemble, heat or dispose of batteries in flames.
- If the battery fluid should leak, carefully wipe the fluid off the inside of the battery compartment and insert new batteries.
- Remove the batteries from the remote control unit if it will not be in use for long periods.

Operating range of the remote control unit

- Point the remote control unit at the remote sensor when operating it.
- The remote control unit can be used from a distance of up to about 23 feet / 7 meters, at a horizontal angle of up to 30° with respect to the sensor.

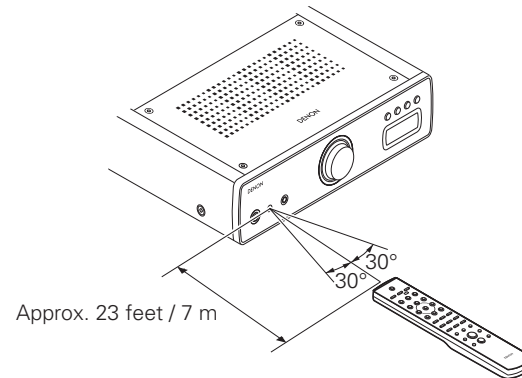

NOTE

The set may function improperly or the remote control unit may not operate if the remote control sensor is exposed to direct sunlight, strong artificial light from an inverter type fluorescent lamp or infrared light.

Part names and functions

For buttons not explained here, see the page indicated in parentheses ().

Front panel

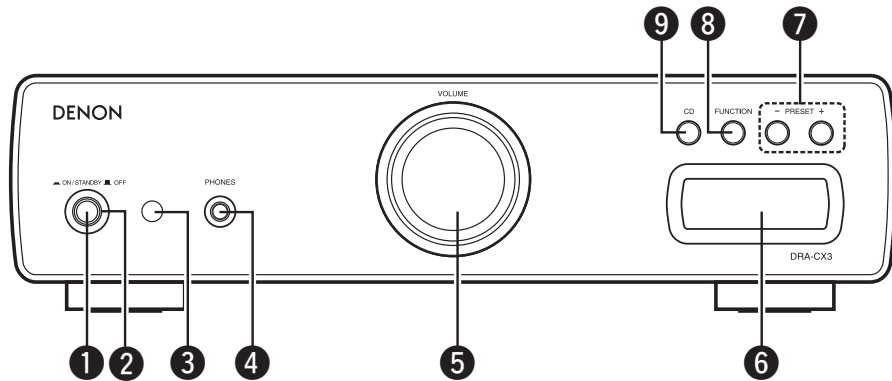

- 1 Power switch (ON/STANDBY OFF) (9)
- 2 Power indicator (9)
- 3 Remote control sensor (2)
- 4 Headphones jack (PHONES)
When headphones are plugged in, the sound can only be heard from the headphones.
- 5 VOLUME control knob (9)
- 6 Display
- 7 PRESET buttons (10)
- 8 FUNCTION button (9 ~ 11)
- 9 CD button (9, 10)

NOTE

Be careful not to set the volume too high when using headphones.

Display

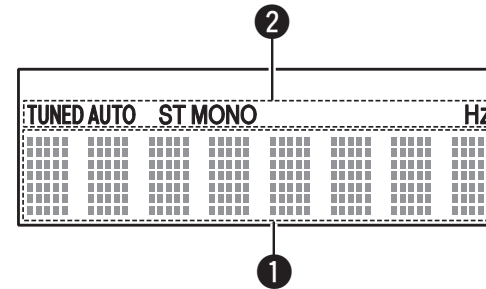

- 1 Information display (9 ~ 11)
Various information is displayed here, depending on the operation mode.
- 2 Tuner reception mode indicators (9 ~ 11)

Rear panel

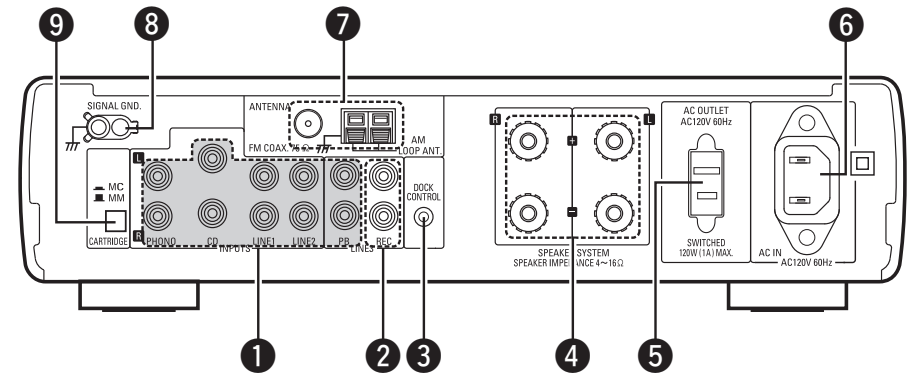

- 1 Input terminals (7)
- 2 Recording output terminals (7)
- 3 DOCK CONTROL jack (7)
- 4 Speaker terminals (5, 6)
- 5 AC outlet (8)
- 6 AC inlet (8)
- 7 ANTENNA terminals (6)
- 8 SIGNAL GND terminal (7)
- 9 CARTRIDGE selection switch (7)

Remote control unit

The operations of the remote control unit's buttons depend on the function that is currently set.

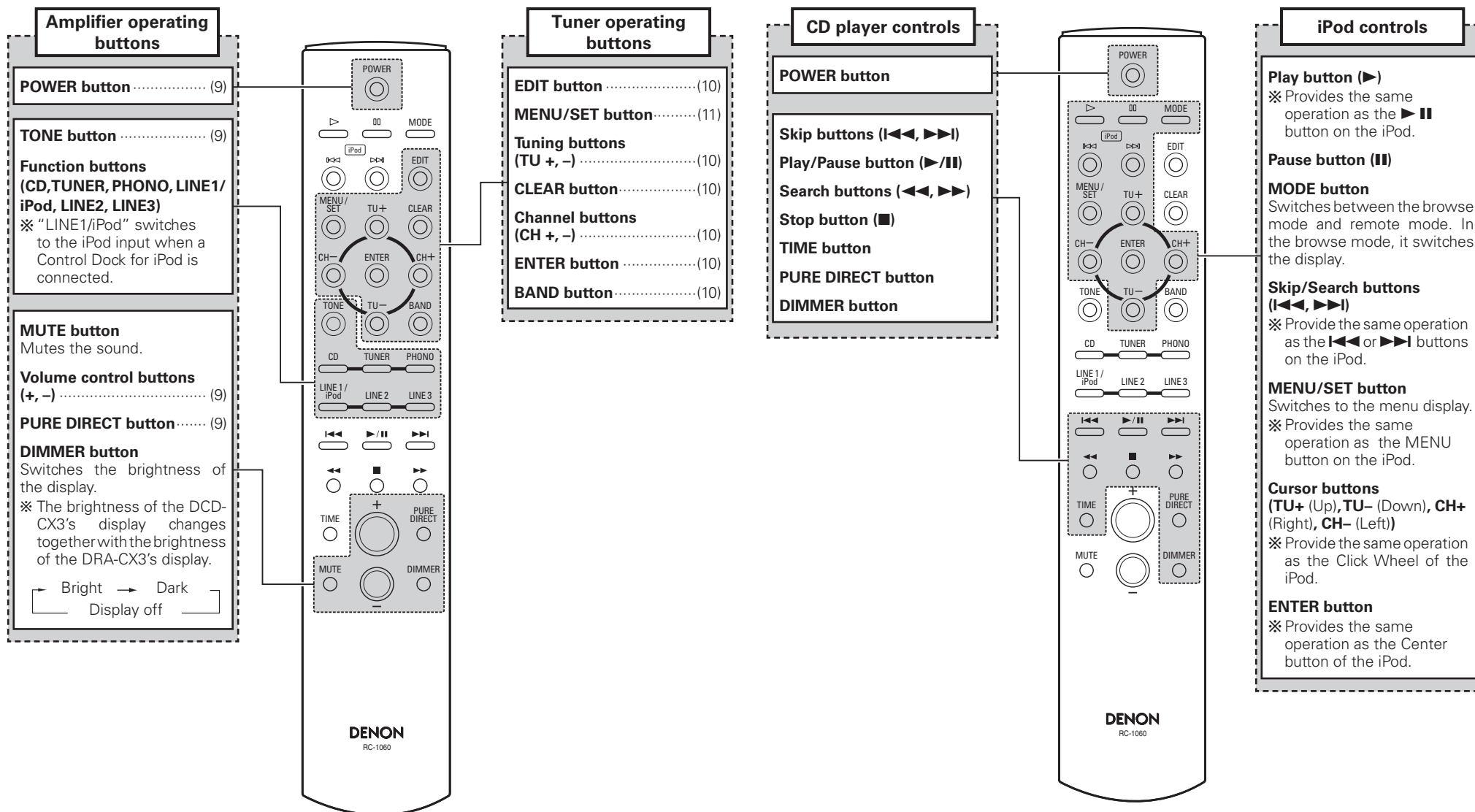

- The **POWER**, **PURE DIRECT** and **DIMMER** buttons function for the DENON DCD-CX3 Super Audio CD player as well, so the DCD-CX3 can be operated simultaneously with the DRA-CX3. When the two units have different settings, press and hold in the button for at least 2 seconds to reset them both to the default setting, then make the desired setting.
- The default settings are "on" for the power, "bright" for the dimmer and "off" for the pure direct mode.



- Use the separately sold Control Dock for iPod (ASD-1R, sold separately) to connect an iPod to the DRA-CX3 (☞ page 7).
- iPod playback modes include the browse mode and the remote mode. See "iPod® playback" (☞ page 11) for details.

Connections

NOTE

- Do not plug in the power cord until all connections have been completed.
- When making connections, also refer to the operating instructions of the other components.
- Be sure to connect the left and right channels properly (left with left, right with right).
- Do not bundle power cords together with connection cables. Doing so can result in humming or noise.

Cable indications

Connect using the connection cables shown below.

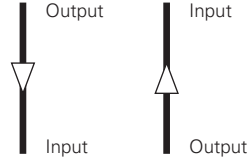
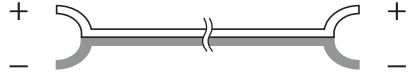

Audio cables	Signal direction
<p>Analog connections (Stereo)</p>  <p>RCA pin-plug cable</p>	<p>Audio signal:</p> 
<p>Speaker connections</p>  <p>Speaker cables</p>	

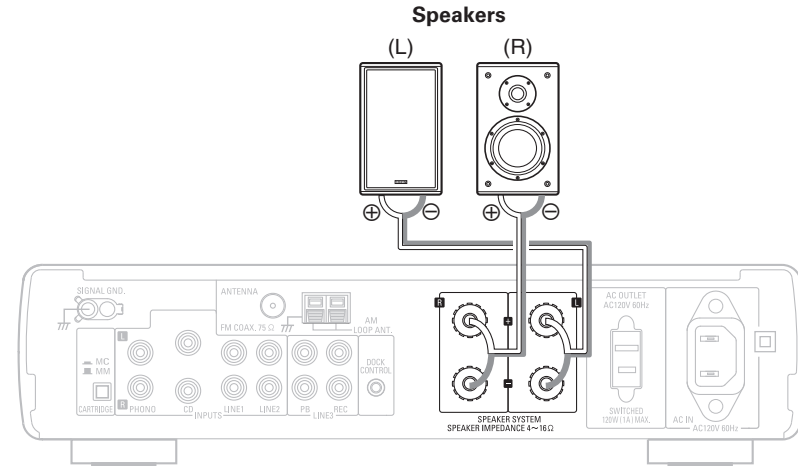
Speaker connections



Connecting the speaker cables

Carefully check the left (L) and right (R) channels and + (red) and - (black) polarities on the speakers being connected to the DRA-CX3, and be sure to interconnect the channels and polarities correctly.

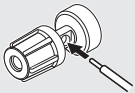
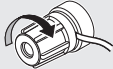
- 1** Peel off about 0.03 ft / 10 mm of sheathing from the tip of the speaker cable, then either twist the core wire tightly or terminate it. 
- 2** Turn the speaker terminal counterclockwise to loosen it. 
- 3** Insert the speaker cable's core wire to the hilt into the speaker terminal. 
- 4** Turn the speaker terminal clockwise to tighten it. 

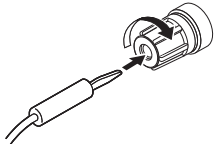
When using a banana plug
Tighten the speaker terminal firmly before inserting the banana plug. 

NOTE

- Use speakers with an impedance of 4 to 16 Ω/ohms.
- When making connections, take care that none of the strands in the speaker cable come in contact with adjacent terminals, other speaker cable strands, or with the rear panel and screws.
NEVER touch the speaker terminals when the power is on. Doing so can result in electric shocks.

Protection circuit

When using speakers with an impedance below the designated value (for example 3 Ω/ohms), playing for long periods of time with the volume high can cause the temperature to rise, activating the protection circuit.

When this circuit is activated, the output to the speakers is cut off and the power indicator blinks. If this happens, unplug the power cord, wait for the set to cool off and improve ventilation around the unit. Also check the wiring of the input cables and the speaker cables. After doing this, plug the power cord back in and turn the unit's power back on.

If the protection circuit is activated again even though there are no problems with the wiring or the ventilation around the unit, switch off the power and contact a DENON service center.

AM loop antenna assembly

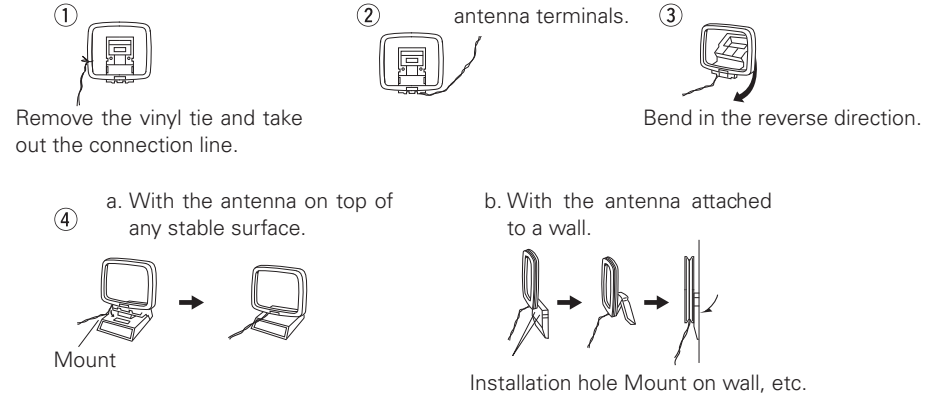

Connection of AM antennas

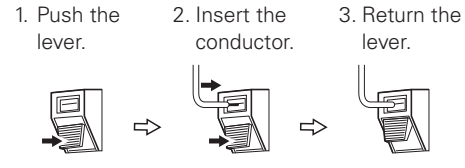

NOTE

- Do not connect two FM antennas simultaneously.
- Even if an AM outdoor antenna is used, do not disconnect the AM loop antenna.
- It is not possible to receive AM broadcasts with good quality if the AM loop antenna is near something metallic.

Note to CATV system installer:

This reminder is provided to call the CATV system installer's attention to Article 820-40 of the NEC which provides guidelines for proper grounding and, in particular, specifies that the cable ground shall be connected to the grounding system of the building, as close to the point of cable entry as practical.

Connecting the antenna terminals

An F-type FM antenna can be connected directly.

Direction of broadcasting station

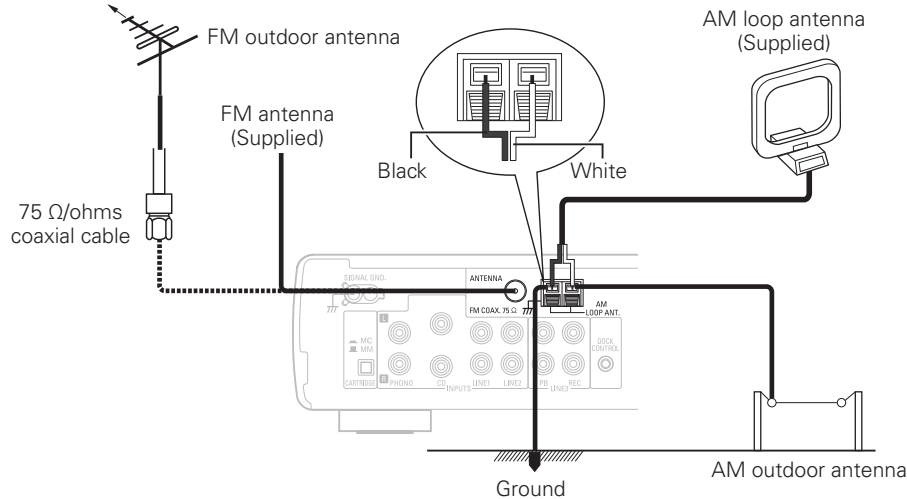

Connecting a CD player

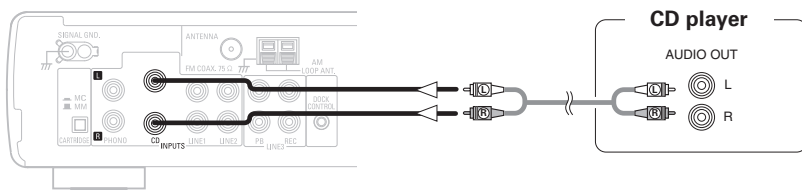

Connecting a turntable

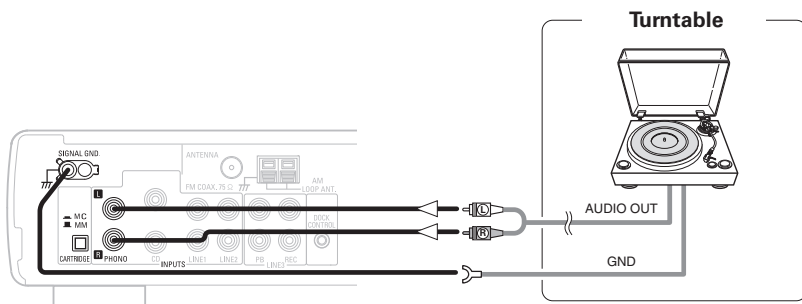

- If connecting the turntable ground wire causes noise, disconnect it. For instructions on connecting the turntable ground wire, refer to the operating instructions included with the turntable.
- Set the **CARTRIDGE** selection switch to “MM” or “MC” according to the cartridge being used.

NOTE

- If a turntable is not connected to the PHONO input terminals, do not select PHONO since this can cause humming and noise, especially if the volume is turned up high. When not connecting a turntable, leave the included short-circuiting pin plugged in.
- The DRA-CX3's SIGNAL GND terminal () is not a safety ground.

Connecting an iPod®

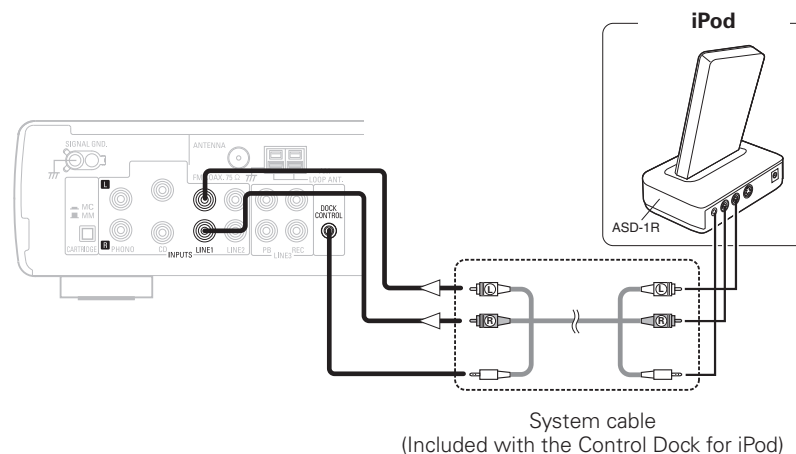

- Use the separately sold Control Dock for iPod (ASD-1R) to connect an iPod to the DRA-CX3.
- When using a Control Dock for iPod (ASD-1R), the communications mode selection switch must be set. For details, refer to the operating instructions of the Control Dock for iPod.
- When connecting the exclusive Control Dock for iPod (ASD-1R, sold separately), connect the Control Dock for iPod with the system cable included with the dock.
- When the Control Dock for iPod is connected, the function indicator switches from “LINE1” to “iPod”.

Connecting a tape deck, CD recorder or MD recorder

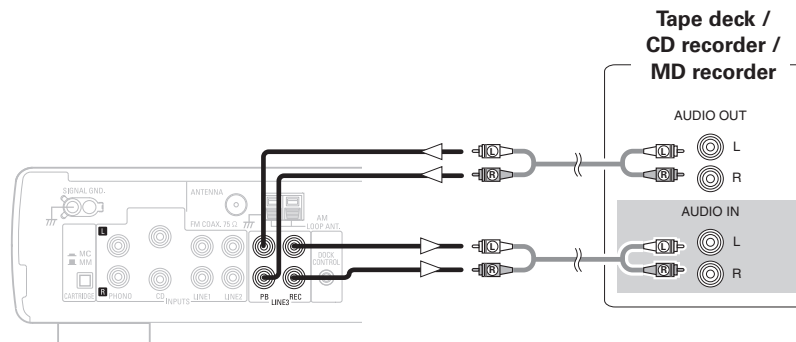

Connecting the power cord

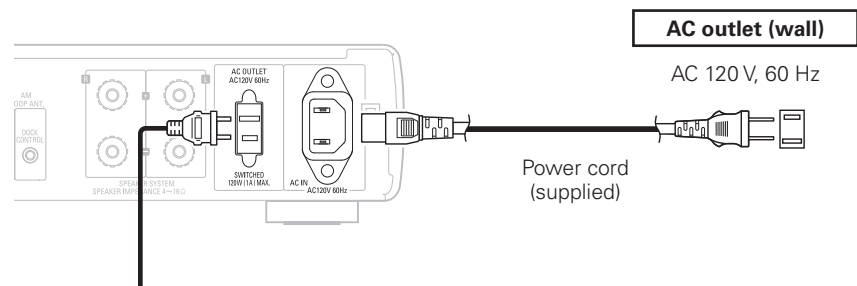

AC OUTLET

SWITCHED (total capacity – 120 W (1 A))
 The power turns on and off together with the power switch on the main unit, but not with the power switch on the remote control unit. Power is supplied to the AC outlet when the DRA-CX3 is in standby. NEVER connect devices with a power consumption of 120 W (1 A) or greater.

NOTE

- Insert the plugs securely. Incomplete connections will result in the generation of noise.
- Connect the power cord from one of the components connected to the DRA-CX3 into the DRA-CX3's AC outlet on the rear panel. Do not use this outlet for hairdryers or other non-audio devices.

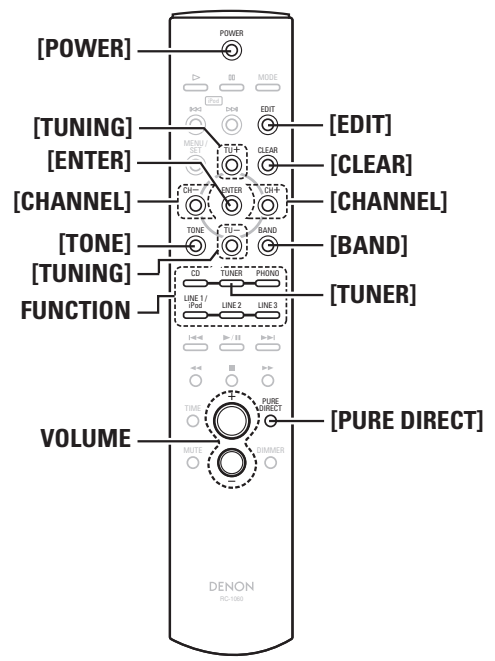
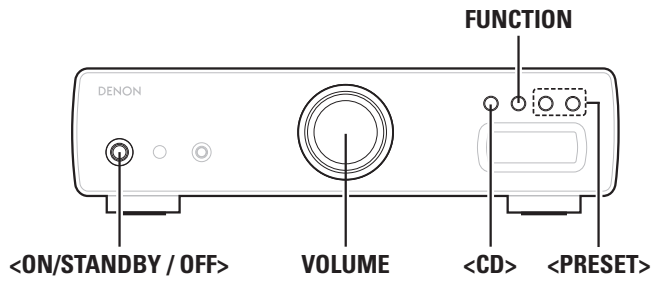

About the button names in these explanations
 < > : Buttons on the main unit
 [] : Buttons on the remote control unit
Button name only:
 Buttons on the main unit and remote control unit

Operation

Turning the power on

Press **<ON/STANDBY / OFF>**.

※ When the power is turned on, the function that was being used when the power was last turned off is selected (Last function memory).

Setting the power to the standby mode:
 Press **[POWER]**.

Canceling the standby mode:
 Press **[POWER]** again.

Turning the power off:
 Press **<ON/STANDBY / OFF>**.

Power indicator
Power on Red **Standby** Orange

Conducting playback

1 Press **FUNCTION** to select the input function.

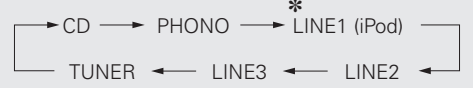

※ The function can be switched directly to "TUNER" by pressing **<PRESET>**, to "CD" by pressing **<CD>**.
 ※ The "iPod" indicator is displayed when a Control Dock for iPod is connected. ("NO iPod" is displayed if no iPod is connected to the Control Dock for iPod.)

2 Start playback on the selected component.

※ For instructions on operating, see the operating instructions of the connected component.

3 Adjust the **VOLUME**.
 ※ The volume can be adjusted within the range 0 to -90 dB to -∞. When set to -∞, the display reads "-∞ dB".

Adjusting the tone

1 Press **[TONE]** to select the tone parameter to be adjusted.

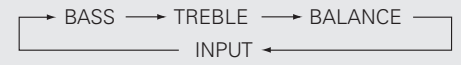

BASS: Adjusts the bass sound.
TREBLE: Adjusts the treble sound.
BALANCE: Adjusts the left/right volume balance.

2 When the bass or treble level or the balance is displayed, adjust pressing **[CHANNEL]**.

Playing with higher quality sound (Pure Direct mode)

Press **[PURE DIRECT]**.
 The display is turned off.

※ The audio signals do not pass through the tone adjustment circuitry, so highly pure sound is played.

Canceling the Pure Direct mode:
 Press **[PURE DIRECT]** again.

When in the pure direct mode, the tone is set to "flat" and the balance to "center". The tone and balance cannot be adjusted when this mode is selected.

Recording

1 Press **FUNCTION** to select the input function.

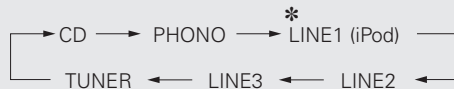

※ The function can be switched directly to “TUNER” by pressing **<PRESET>**, to “CD” by pressing **<CD>**.

※ The “iPod” indicator is displayed when a Control Dock for iPod is connected. (“NO iPod” is displayed if no iPod is connected to the Control Dock for iPod.)

2 Set the recorder to the recording mode.

※ For instructions on operating, see the operating instructions of the connected component.

3 Start playback on the player.

※ For instructions on operating, see the operating instructions of the connected component.



- The LINE3 input signal is not output to the recording output terminal (REC).
- Adjusting the volume or tone does not affect the sound being recorded.

Tuning in radio broadcasts

1 Press **[TUNER]**, **<PRESET>** or **<FUNCTION>** to select “TUNER”.

The reception frequency is displayed.

2 Press **[BAND]** to select the reception band.

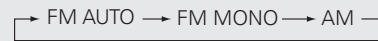

3 Press **[TUNING]** to select the reception frequency.

The “TUNED” indicator lights when a station is tuned in.

FM station reception conditions

- When the reception band mode is set to “FM AUTO”, the “ST” indicator lights when a stereo broadcast is tuned in.
- If the signal is weak and the stereo broadcast reception is not stable, set the reception mode to “FM MONO”. The “MONO” indicator lights.

Auto tuning

Press and hold in **<PRESET>** or **[TUNING]** to search for and tune in the next stereo broadcast automatically.
Stations cannot be tuned in if the signal is too weak.

Canceling auto tuning

Press **<PRESET>** or **[TUNING]**.

Manual tuning

The frequency changes one step at a time each time **[TUNING]** is pressed.



Noise may be produced in the sound when receiving AM broadcasts if there is e.g. a TV nearby. If so, move the DRA-CX3 and TV as far apart as possible.

Presetting

Giving a name to the currently tuned in broadcast station and presetting it

- A total of 40 FM and AM broadcast stations combined can be preset.
- Preset stations can be given names of up to 8 characters.

1 Tune in the broadcast station.

The reception frequency is displayed.

2 Press **[EDIT]**.

The name input mode is set.

3 Press **[CHANNEL]** to select the desired character.

※ Up to 8 characters can be input for each preset.
The characters that can be input are as shown below.

A	B	C	D	E	F	G	H	I	J	K	L	M	N	O	P	Q	R	S	T	U	V	W	X	Y	Z
0	1	2	3	4	5	6	7	8	9																
^	'	()	*	+	,	-	.	/	=	(space)															

※ Press **[TUNING]** to move the cursor.

※ Press **[CLEAR]** to delete characters.

4 Press **[ENTER]**.

The name input mode is set.

5 Press **[CHANNEL]** to select the preset number, then press **[ENTER]**.

The reception frequency and reception mode are preset.

To change the name of a preset station:

- ① Call out the preset name to be changed, then press **[EDIT]**.
- ② Perform steps **3, 4** under “Giving a name to the currently tuned in broadcast station and presetting it”.

To only preset the station:

- ① Press **[ENTER]** while the station is tuned in.
- ② Perform step **5** under “Giving a name to the currently tuned in broadcast station and presetting it”.

NOTE

If a station is preset at a number where a station has already been preset, the old setting is deleted and replaced with the new setting.

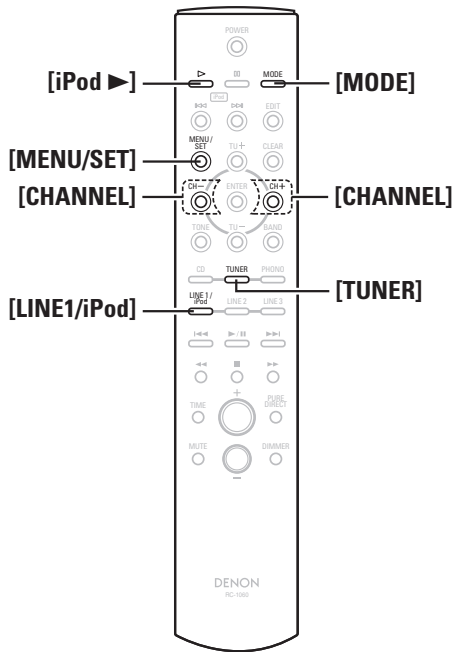
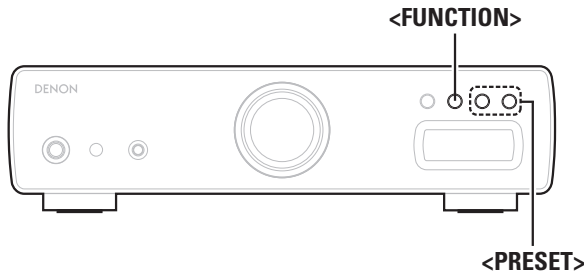

About the button names in these explanations

- < > : Buttons on the main unit
- [] : Buttons on the remote control unit

Button name only:

Buttons on the main unit and remote control unit

Presetting broadcast stations automatically (Auto preset)

- 1** Press [TUNER], <PRESET> or <FUNCTION> to select "TUNER".
The reception frequency is displayed.
- 2** Press and hold [MENU/SET].
"A. PRESET" is displayed.
- 3** Press [MENU/SET].
Broadcast stations are preset automatically.



- Broadcast stations whose signals are too weak cannot be preset automatically. To preset them, tune them in manually, then follow the operation described at "Giving a name to the currently tuned in broadcast station and presetting it."
- Once auto presetting starts, it cannot be stopped before it is completed. (It takes about 60 seconds for auto presetting to be completed.)

Listening to preset broadcast stations

Select the preset number by pressing <PRESET> or [CHANNEL].

iPod® playback

The music on an iPod can be played by using the Control Dock for iPod (ASD-1R, sold separately). The iPod can be controlled using the buttons on the main unit and the remote control unit.



iPod is a trademark of Apple Inc., registered in the U.S. and other countries.

- ※ The iPod may only be used to copy or play contents that are not copyrighted or contents for which copying or playback is legally permitted for your private use as an individual. Be sure to comply with applicable copyright legislation.

1 Connect the DRA-CX3 and iPod using the Control Dock for iPod (ASD-1R) (see page 7).

2 Press [LINE1/iPod] or <FUNCTION> to select "LINE1".
The display switches from "LINE1" to "iPod".

3 Press [MODE] for 2 seconds or more to select the play mode.

Browse ↔ Remote

Browse:

Displays menu or track information on the display of the main unit. ("DENON" is displayed on the iPod display.)

Remote:

Displays menu or track information on the iPod display. ("iPod" is displayed on the display of the main unit.)

※ Select the remote mode to enjoy iPod video information such as slide shows and videos.

4 Press [iPod ▶].

※ When pressed again, the pause mode is set.



For remote control unit buttons that can be used when the function is set to "iPod", see page 4.

NOTE

- DENON will accept no responsibility whatsoever for possible loss of iPod data when using an iPod connected to the DRA-CX3.
- Depending on the type of iPod and the software version, some functions may not operate.

Troubleshooting

If a problem should arise, first check the following:

1. Are the connections correct ?
2. Is the set being operated as described in the operating instructions ?
3. Are the other components operating properly ?

If this unit does not operate properly, check the items listed in the table below. Should the problem persist, there may be a malfunction.

In this case, disconnect the power immediately and contact your store of purchase.

Symptom	Cause	Measures	Page
When the power is turned on, the power indicator does not light and no sound is produced.	<ul style="list-style-type: none"> • The power cord's plug is not fully plugged in. 	<ul style="list-style-type: none"> • Check the insertion of the power cord plug and connected securely. 	8
The power indicator lights but no sound is produced.	<ul style="list-style-type: none"> • The speaker cables are not properly connected. • The function (input) is incorrect. • The volume is set too low. 	<ul style="list-style-type: none"> • Connect securely. 	5
		<ul style="list-style-type: none"> • Switch to the correct function (input). 	9
		<ul style="list-style-type: none"> • Adjust the volume to an appropriate level. 	9
No sound is produced from one side.	<ul style="list-style-type: none"> • The speaker cables are not properly connected. • The input cables are not properly connected. • The left/right balance is off. 	<ul style="list-style-type: none"> • Connect securely. 	5
		<ul style="list-style-type: none"> • Connect securely. 	6, 7
		<ul style="list-style-type: none"> • Adjust the left/right balance. 	9
For stereo sources, the positions of the instruments are inverted.	<ul style="list-style-type: none"> • The connections of the speaker cables or input cables are inverted. 	<ul style="list-style-type: none"> • Check and remedy the connections. 	5
Buzzing noise in FM broadcasts.	<ul style="list-style-type: none"> • The antenna cable is not properly connected. • Noise interference from a nearby electronic device equipped with a microprocessor, or the radio broadcast signal is weak. 	<ul style="list-style-type: none"> • Connect the antenna properly. 	6
		<ul style="list-style-type: none"> • Reposition the equipment or the positions or directions of the connection cables, antenna, etc. 	6
		<ul style="list-style-type: none"> • Connect an outdoor antenna. 	6

Symptom	Cause	Measures	Page
Hissing or buzzing noise is heard in AM broadcasts.	<ul style="list-style-type: none"> • Noise interference from a nearby monitor, etc., or there is interference in the broadcast signal. 	<ul style="list-style-type: none"> • Turn off the monitor. • Change the position or direction of the AM loop antenna. • Connect an outdoor antenna. 	– 6 6
Humming noise is heard in AM broadcasts.	<ul style="list-style-type: none"> • There is interference from current in power cords. 	<ul style="list-style-type: none"> • Connect an outdoor antenna. 	6
When playing records, a wailing noise (howling) is produced when the volume is raised.	<ul style="list-style-type: none"> • The player and speakers are too close together. • The floor is soft and vibrates easily. 	<ul style="list-style-type: none"> • Move the player and speakers as far apart as possible. • Use cushions or spikes to absorb the vibrations of the speakers being conveyed from the floor. 	7 –
		<ul style="list-style-type: none"> • The batteries are flat. • The remote control unit is too far away. • There is an obstacle between the main unit and the remote control unit. 	<ul style="list-style-type: none"> • Replace with new batteries. • Operate from closer to the main unit. • Remove the obstacle.
Remote control unit does not operate.	<ul style="list-style-type: none"> • The remote control unit is being operated at an angle of over 30° with respect to the front panel. • The batteries are inserted in the wrong direction. 	<ul style="list-style-type: none"> • Operate the remote control unit from directly in front of the main unit. 	2
		<ul style="list-style-type: none"> • Insert the batteries in the proper direction. 	2

Specifications

Receiver section

Rated output: 2-channel driving (CD → SP OUT)
 75 W + 75 W (8 Ω/ohms, DIN, 1 kHz, T.H.D. 0.7 %)
 150 W + 150 W (4 Ω/ohms, DIN, 1 kHz, T.H.D. 0.7 %)

High frequency distortion: 0.05 % (Rated output: -3 dB), 8 Ω/ohms, 1 kHz

Output terminals: Speaker 4 ~ 16 Ω/ohms
 Suited for headphones/stereo headphones

Equalizer amplifier output (REC OUT terminals):

Rated output : 150 mV

Input sensitivity /

Input impedance: PHONO (MM) : 2.5 mV / 47 kΩ/kohms
 PHONO (MC) : 0.2 mV / 100 Ω/ohms
 CD, LINE1, LINE2, LINE3 : 130 mV / 47 kΩ/kohms
 PHONO (MM) : 20 Hz ~ 20 kHz ±0.5 dB
 PHONO (MC) : 30 Hz ~ 20 kHz ±0.5 dB

RIAA deviation:

Reception frequency range: FM : 87.5 MHz ~ 107.9 MHz AM : 520 kHz ~ 1710 kHz

Reception sensitivity: FM : 1.5 μV / 75 Ω/ohms AM : 20 μV

FM channel separation: 35 dB (1 kHz)

FM S/N ratio: Monaural : 74 dB Stereo : 70 dB

FM harmonic distortion: Monaural : 0.3 % Stereo : 0.4 %

Properties

S/N ratio: PHONO (MM) : 84 dB
 (With input terminals short-circuited, 5 mV input signal)
 PHONO (MC) : 70 dB
 (With input terminals short-circuited, 0.5 mV input signal)

(A-weighted network) CD, LINE1, LINE2, LINE3 : 95 dB (input terminals short-circuited)

Tone control: BASS : 100 Hz ± 8 dB

TREBLE : 10 kHz ± 8 dB

Frequency response: 5 Hz ~ 40 kHz (+0.5 dB, -3 dB) (INPUT : CD, PURE DIRECT: ON)

General

Power outlet: 1 switched outlet, total capacity 120 W (1 A)

Power supply: AC 120 V, 60 Hz

Power consumption: 100 W
 Standby: 0.5 W or less

Maximum external dimensions: 300 (W) x 80 (H) x 341 (D) mm (11-13/16" x 3-3/16" x 13-7/16")

Weight: 5.5 kg (12 lbs 2 oz)

Remote control unit (RC-1060)

Remote control method: Infrared pulse method

Batteries: R03/AAA Type (two batteries)

Maximum external dimensions: 44 (W) x 233 (H) x 22 (D) mm (1-3/4" x 9-3/16" x 7/8")

Weight: 165 g (Approx 5.8 oz) (including batteries)

* For purposes of improvement, specifications and design are subject to change without notice.



DENON

www.denon.com

Denon Brand Company, D&M Holdings Inc.
Printed in Japan 5411 10027 007D

Free Manuals Download Website

<http://myh66.com>

<http://usermanuals.us>

<http://www.somanuals.com>

<http://www.4manuals.cc>

<http://www.manual-lib.com>

<http://www.404manual.com>

<http://www.luxmanual.com>

<http://aubethermostatmanual.com>

Golf course search by state

<http://golfingnear.com>

Email search by domain

<http://emailbydomain.com>

Auto manuals search

<http://auto.somanuals.com>

TV manuals search

<http://tv.somanuals.com>